

IM C4500/C5500/C6000
IM C2000/C2500/C3000/C3500
Machine Code:
D0BN/D0BP/D0BQ
D0BJ/D0BK/D0BL/D0BM
Field Service Manual
Ver. 1.0

Latest Release: December, 2018
Initial Release: December, 2018
(c) 2018 Ricoh Co., Ltd.

Important Safety Notices

Warnings, Cautions, Notes

In this manual, the following important symbols and notations are used.



- A Warning indicates a potentially hazardous situation. Failure to obey a Warning could result in death or serious injury.



- A Caution indicates a potentially hazardous situation. Failure to obey a Caution could result in minor or moderate injury or damage to the machine or other property.



- Obey these guidelines to avoid problems such as misfeeds, damage to originals, loss of valuable data and to prevent damage to the machine.



- This information provides tips and advice about how to best service the machine.

General Safety Instructions

For your safety, please read this manual carefully before you use this product. Keep this manual handy for future reference.

Safety Information

Always obey the following safety precautions when using this product.

Safety During Operation

In this manual, the following important symbols and notations are used.



[A]: ON

[B]: OFF

[C]: Push ON/Push OFF

[D]: Standby

Switches and Symbols

Where symbols are used on or near switches on machines for Europe and other areas, the meaning of each symbol conforms with IEC60417.

Safety

Prevention of Physical Injury

1. Before disassembling or assembling parts of the machine and peripherals, make sure that the machine and peripheral power cords are unplugged.
2. The plug should be near the machine and easily accessible.
3. Note that some components of the machine and the paper tray unit are supplied with electrical voltage even if the main power switch is turned off.
4. Always unplug the power cord from the power source before you move the product. Before you move the machine, arrange the power cord so it will not fall under the machine.
5. Disconnect all peripheral units (finisher, LCT, etc.) from the mainframe before you move the machine.
6. If any adjustment or operation check has to be made with exterior covers off or open while the main switch is turned on, keep hands away from electrified or mechanically driven components.
7. The machine drives some of its components when it completes the warm-up period. Be careful to keep hands away from the mechanical and electrical components as the machine starts operation.
8. The inside and the metal parts of the fusing unit become extremely hot while the machine is operating. Be careful to avoid touching those components with your bare hands.
9. To prevent a fire or explosion, keep the machine away from flammable liquids, gases, and aerosols.
10. Do not use flammable sprays or solvent in the vicinity of the machine. Also, avoid placing these items in the vicinity of the machine. Doing so could result in fire or electric shock.
11. To avoid fire or explosion, never use an organic cleaner near any part that generates heat.
12. Clean the floor completely after accidental spillage of silicone oil or other materials to prevent slippery surfaces that could cause accidents leading to hand or leg injuries.
13. Never remove any safety device unless it requires replacement. Always replace safety devices immediately.
14. Never do any procedure that defeats the function of any safety device.
15. Modification or removal of a safety device (fuse, switch, etc.) could lead to a fire and personal injury. Always test the operation of the machine to ensure that it is operating normally and safely after removal and replacement of any safety device.
16. For replacements use only the correct fuses or circuit breakers rated for use with the machine. Using replacement devices not designed for use with the machine could lead to a fire and personal injuries.
17. For machines installed with the ADF/ARDF:
When a thick book or three-dimensional original is placed on the exposure glass and the ARDF cover is lowered, the back side of the ARDF rises up to accommodate the original. Therefore, when closing the ARDF, please be sure to keep your hands away from the hinges at the back of the ARDF.
18. When using a vacuum cleaner around the machine, keep others away from the cleaner, especially

small children.

19. For machines installed with the anti-tip components:

The anti-tip components are necessary for meeting the requirements of IEC60950-1, the international standard for safety. The aim of these components is to prevent the products, which are heavy in weight, from toppling as a result of people running into or leaning onto the products, which can lead to serious accidents such as persons becoming trapped under the product. (U.S.: UL60950-1, Europe: EN60950-1) Therefore, removal of such components must always be with the consent of the customer. Do not remove them at your own judgment.

20. **NEVER touch** the AC circuits on the PSU board to prevent electric shock caused by residual charge. Residual charge of about 100V-400V remains in the AC circuits on the PSU board for several months even when the board has been removed from the machine after turning off the machine power and unplugging the power cord.

Health Safety Conditions

1. For the machines installed with the ozone filters:
 - Never operate the machine without the ozone filters installed.
 - Always replace the ozone filters with the specified types at the proper intervals.
2. The machine, which use high voltage power source, can generate ozone gas. High ozone density is harmful to human health. Therefore, locate the machine in a large well ventilated room that has an air turnover rate of more than 50m³/hr/person.
3. Toner and developer are non-toxic, but if you get either of them in your eyes by accident, it may cause temporary eye discomfort. Try to remove with eye drops or flush with water as first aid. If unsuccessful, get medical attention.

Observance of Electrical Safety Standards

1. The machine and its peripherals must be installed and maintained by a customer service representative who has completed the training course on those models with exceptions on some machines where the installation can be handled by the user.

Safety and Ecological Notes for Disposal

- Do not incinerate toner bottles or used toner. Toner dust may ignite suddenly when exposed to an open flame.
- Dispose of used toner, developer, organic photoconductors, and AIO unit in accordance with local regulations. (These are non-toxic supplies.)
- Dispose of replaced parts in accordance with local regulations.
- When keeping used lithium batteries in order to dispose of them later, do not put more than 100 batteries per sealed box. Storing larger numbers or not sealing them apart may lead to chemical reactions and heat build-up.



The danger of explosion exists if a battery of this type is incorrectly replaced. Replace only with the same or an equivalent type recommended by the manufacturer. Discard used batteries in accordance with the manufacturer's instructions.

Handling Toner

- Work carefully when removing paper jams or replacing toner bottles or cartridges to avoid spilling toner on clothing or the hands.
- If toner is inhaled, immediately gargle with large amounts of cold water and move to a well-ventilated location. If there are signs of irritation or other problems, seek medical attention.
- If toner gets on the skin, wash immediately with soap and cold running water.
- If toner gets into the eyes, flush the eyes with cold running water or eye wash. If there are signs of irritation or other problems, seek medical attention.
- If toner is swallowed, drink a large amount of cold water to dilute the ingested toner. If there are signs of any problem, seek medical attention.
- If toner spills on clothing, wash the affected area immediately with soap and cold water. Never use hot water! Hot water can cause toner to set and permanently stain fabric.
- Always store toner and developer supplies such as toner and developer packages, cartridges, bottles (including used toner and empty bottles and cartridges), and AIO unit out of the reach of children.
- Always store fresh toner supplies or empty bottles or cartridges in a cool, dry location that is not exposed to direct sunlight.
- Do not use a vacuum cleaner to remove spilled toner (including used toner). Vacuumed toner may cause a fire or explosion due to sparks or electrical contact inside the cleaner. However, it is possible to use a cleaner designed to be dust explosion-proof. If toner is spilled over the floor, sweep up spilled toner slowly and clean up any remaining toner with a wet cloth.

Handling the development unit cooling system

For the machines installed the development cooling system:

1. The development unit cooling system circulates propylene glycol from a sealed tank through hoses that pass behind cooling plates on the sides of each development unit.
2. The coolant tank is located at the bottom of the cooling box on the back of the main machine.
3. Always obey local laws and regulations if you need to dispose of a tank or the propylene glycol coolant.
4. The tank must never be emptied directly into a local drainage system, river, pond, or lake.
5. Contact a professional industrial waste disposal organization and ask them to dispose of the tank.

Lithium Batteries for Taiwan



Laser Safety

The Center for Devices and Radiological Health (CDRH) prohibits the repair of laser-based optical units in the field. The optical housing unit can only be repaired in a factory or at a location with the requisite equipment. The laser subsystem is replaceable in the field by a qualified Customer Engineer. The laser chassis is not repairable in the field. Customer engineers are therefore directed to return all chassis and laser subsystems to the factory or service depot when replacement of the optical subsystem is required.

WARNING

- Use of controls, or adjustment, or performance of procedures other than those specified in this manual may result in hazardous radiation exposure.

WARNING FOR LASER UNIT

WARNING:

Turn off the main switch before attempting any of the procedures in the Laser Unit section. Laser beams can seriously damage your eyes.



Safety Instructions for the Color Controller

Fuse

The color controller uses a double pole fuse. If this fuse blows, be sure to replace it with an identical fuse.

Batteries

CAUTION

Always replace a battery with the same type of battery prescribed for use with the color controller unit. Replacing a battery with any type other than the one prescribed for use could cause an explosion.











- Never discard used batteries by mixing them with other batteries or other refuse.
- Always remove used batteries from the work site and dispose of them in accordance with local laws and regulations regarding the disposal of such items.

Symbols, Abbreviations and Trademarks

Symbols, Abbreviations

This manual uses several symbols and abbreviations.

Symbols:

Symbol	What it means
	Clip ring
	Screw
	Connector
	Clamp
	E-ring
	Flat Flexible Cable
	Timing Belt
SEF	Short Edge Feed
LEF	Long Edge Feed
K	Black
C	Cyan
M	Magenta
Y	Yellow
B/W, BW	Black and White
FC	Full color
	Location of the screw(s) to be unscrewed or loosen
	Location of the connector(s), clamp(s) or spring(s) to be removed
	Direction (Rotating or moving)

Abbreviations:



Abbreviations such as (M1), (S1), or (TH1) attached after the name of some electrical components show the symbols in Point-to-Point diagram.

Abbreviation	Meaning
SEF	Short Edge Feed
LEF	Long Edge Feed

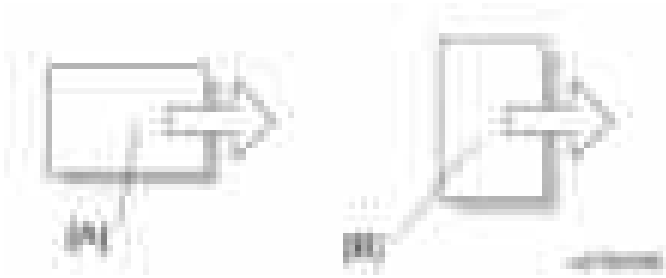

[A] Short Edge Feed (SEF)

[B] Long Edge Feed (LEF)

Trademarks

Adobe, Acrobat, PageMaker, PostScript, and PostScript 3 are either registered trademarks or trademarks of Adobe Systems Incorporated in the United States and/or other countries.

The Bluetooth® word mark and logos are registered trademarks owned by Bluetooth SIG, Inc. and any use of such marks by Ricoh Company, Ltd. is under license.

Firefox and Thunderbird are registered trademarks of the Mozilla Foundation.

Google, Android, and Chrome are trademarks of Google Inc.

iOS® is a registered trademark or trademark of Cisco Systems, Inc. and/or its affiliates in the United States and certain other countries.

Java is a registered trademark of Oracle and/or its affiliates.

JAWS® is a registered trademark of Freedom Scientific, Inc., St. Petersburg, Florida and/or other countries.

Kerberos is a trademark of the Massachusetts Institute of Technology (MIT).

Linux is a registered trademark of Linus Torvalds.

Macintosh, OS X, Bonjour, Safari, and TrueType are trademarks of Apple Inc., registered in the U.S. and other countries.

Microsoft, Windows, Windows Server, Windows Vista, Internet Explorer, and Outlook are either registered trademarks or trademarks of Microsoft Corp. in the United States and/or other countries.

PictBridge is a trademark.

QR Code is a registered trademark of DENSO WAVE INCORPORATED in Japan and in other countries.

"Red Hat" is a registered trademark of Red Hat, Inc.

The SD and SD logo are trademarks of SD-3C, LLC.

UNIX is a registered trademark of The Open Group.

UPnP is a trademark of UPnP Implementers Corporation.



This product includes RSA BSAFE® Cryptographic software of EMC Corporation. RSA and BSAFE are registered trademarks or trademarks of EMC Corporation in the United States and other countries.

The proper names of Internet Explorer 6, 7, and 8 are as follows:

- Microsoft® Internet Explorer® 6
- Windows® Internet Explorer® 7
- Windows® Internet Explorer® 8

The proper names of the Windows operating systems are as follows:

- The product names of Windows Vista are as follows:

Microsoft® Windows Vista® Ultimate

Microsoft® Windows Vista® Business

Microsoft® Windows Vista® Home Premium

Microsoft® Windows Vista® Home Basic

Microsoft® Windows Vista® Enterprise

- The product names of Windows 7 are as follows:

Microsoft® Windows® 7 Home Premium

Microsoft® Windows® 7 Professional

Microsoft® Windows® 7 Ultimate

Microsoft® Windows® 7 Enterprise

- The product names of Windows 8 are as follows:

Microsoft® Windows® 8

Microsoft® Windows® 8 Pro

Microsoft® Windows® 8 Enterprise

- The product names of Windows 8.1 are as follows:

Microsoft® Windows® 8.1

Microsoft® Windows® 8.1 Pro

Microsoft® Windows® 8.1 Enterprise

- The product names of Windows 10 are as follows:

Microsoft® Windows® 10 Home Premium

Microsoft® Windows® 10 Pro

Microsoft® Windows® 10 Enterprise

Microsoft® Windows® 10 Education

- The product names of Windows Server 2003 are as follows:

Microsoft® Windows Server® 2003 Standard Edition

Microsoft® Windows Server® 2003 Enterprise Edition

- The product names of Windows Server 2003 R2 are as follows:

Microsoft® Windows Server® 2003 R2 Standard Edition

Microsoft® Windows Server® 2003 R2 Enterprise Edition

- The product names of Windows Server 2008 are as follows:

Microsoft® Windows Server® 2008 Standard

Microsoft® Windows Server® 2008 Enterprise

- The product names of Windows Server 2008 R2 are as follows:

Microsoft® Windows Server® 2008 R2 Standard

Microsoft® Windows Server® 2008 R2 Enterprise

- The product names of Windows Server 2012 are as follows:

Microsoft® Windows Server® 2012 Foundation

Microsoft® Windows Server® 2012 Essentials

Microsoft® Windows Server® 2012 Standard

- The product names of Windows Server 2012 R2 are as follows:

Microsoft® Windows Server® 2012 R2 Foundation

Microsoft® Windows Server® 2012 R2 Essentials

Microsoft® Windows Server® 2012 R2 Standard

Other product names used herein are for identification purposes only and might be trademarks of their respective companies. We disclaim any and all rights to those marks.

Microsoft product screen shots reprinted with permission from Microsoft Corporation.

Table of Contents

1. Product Information	18
Changes from the Previous Models	18
Lookup Table	18
Exterior Cover/Air Flows (Fan Control)	20
Scanner	20
Laser Unit	20
Auto Image Adjustment	20
PCDU (Photo Conductor and Development Unit)	20
Fusing	21
Waste Toner	21
Paper Feed / Transport	21
Electrical Components	21
Machine Codes and Peripherals Configuration	22
Main Machine	22
Option	24
Diagram	28
Specifications	32
2. Installation	33
Installation Requirements	33
Environment	33
Machine Level	34
Machine Space Requirements	34
Machine Dimensions	34
Power Requirements	36
Changes from Previous Machine Concerning Installation	37
Main Machine Installation: Important Notice on Security Issues	39
Overview	39
Password Setting Procedure	40
Main Machine Installation: Accessory Check	42
Main Machine Installation: Installation Procedure	44
Removing the Packing Materials and Shipping Retainers	44
Removing the PCDU Seals and Spacer	48
Attaching the Accessories	50
Toner Bottle Installation and Toner Initialization	53
Image Quality Test / Settings	55
Main Machine Installation: When Moving the Machine	67
Cautions upon Lashing	68

Anti-Condensation Heater (Scanner, PCDU).....	70
Anti-Condensation Heater (Scanner)	70
Anti-Condensation Heater (PCDU)	80
Dehumidification Heater for Paper Feed Trays.....	88
Accessory Check	88
Connecting to Main Machine Tray.....	88
Connecting to Paper Feed Unit PB3300/PB3280	92
Connecting to Paper Feed Unit PB3270	94
Connecting to LCIT PB3290	98
Paper Feed Unit PB3280 / B3300 (D3FY / D3FZ).....	101
Accessory Check	101
Installation Procedure	101
Paper Feed Unit PB3270 (D3G0).....	106
Accessory Check	106
Installation Procedure	106
LCIT PB3290 (D3G2)	111
Accessory Check	111
Installation Procedure	111
LCIT RT3040 (D3G1)	118
Accessory Check	118
Installation Procedure	118
Dehumidification Heater for LCIT RT3040 (Service Option).....	125
Accessory Check	125
Installation Procedure	126
Caster Table Type M3 (D178).....	137
Accessory Check	137
Installation Procedure	137
Platen Cover PN2000 (D700).....	140
Accessory Check	140
Installation Procedure	140
ARDF DF3110 (D3FE)	143
Accessory Check	143
Installation Procedure	143
SPDF DF3120 (D3FF-17, -21)	149
Accessory Check	149
Installation Procedure	149
Small Paper Feeding Unit Type M37 (D3FF-18, -22).....	158
Accessory Check	158
Installation Procedure	158

Page Keeper Type M37 (D3FF-19, -23)	164
Accessory Check	164
Installation Procedure	164
1 Bin Tray BN3130 (D3CQ).....	180
Accessory Check	180
Installation Procedure	180
Internal Shift Tray SH3080 (D3FV)	189
Accessory Check	189
Installation procedure	189
Side Tray Type M37 (D3FX)	194
Accessory Check	194
Installation Procedure	194
Bridge Unit BU3090 (D3FW).....	201
Accessory Check	201
Installation Procedure	201
Booklet Finisher SR3290 (D3FN) / Finisher SR3280 (D3G4).....	208
Accessory Check	208
Installation Procedure	209
Punch Unit PU3090 (D3FP)	221
Accessory Check	221
Installation Procedure	221
Booklet Finisher SR3270 (D3FQ).....	231
Accessory Check	231
Installation Procedure	231
Notes on Moving the Finisher	240
Finisher SR3260 (D3FR).....	241
Accessory Check	241
Installation Procedure	241
Stapleless Stapler Initial Settings	250
Notes on Moving the Finisher	252
Punch Unit PU3080 (D3G5)	253
Accessory Check	253
Installation Procedure	253
Internal Finisher SR3250 (D3FG).....	264
Accessory Check	264
Installation Procedure	265
Punch Unit PU3070 (D3FM).....	274
Accessory Check	274
Installation Procedure	274

Internal Finisher SR3300 (D3FT)	279
Accessory Check	279
Installation Procedure	279
Stapleless Stapler Initial Settings	290
Internal Multi-Fold Unit FD3010 (D3FS).....	292
Accessory Check	292
Installation Procedure	293
When Attaching the Finisher Beyond the Internal Multi-Fold Unit	309
Banner Paper Guide Tray Type M19 (D3BF).....	311
Accessory Check	311
Installation Procedure	311
Imageable Area Extension Unit Type M19 (D3BR-07).....	315
Accessory Check	315
Installation Procedure	315
External Keyboard Bracket Type M19 (D3BR-10).....	318
Accessory Check	318
Installation Procedure	318
Internal Options	323
List of Slots	323
Device Server Option Type M37 (D3GF-10, -11)	324
Component Check	324
Installation Procedure	324
IP Address Setting	328
IEEE 1284 Interface Board Type M19 (D3C0).....	330
Component Check	330
Installation Procedure	330
IEEE 802.11a/g/n Interface Unit Type M19 (D3BR-01).....	332
Component Check	332
Installation Procedure	332
User Tool Settings for IEEE 802.11a/g/n	334
SP Mode Settings for IEEE 802.11 Wireless LAN	335
File Format Converter Type M19 (D3BR-04).....	337
Component Check	337
Installation Procedure	337
Memory Unit Type M37 4GB (D3GF-08)	338
Component Check	338
Installation Procedure	338
Enhanced Security HDD Option Type M12 (D3A6-02).....	340
Component Check	340

Installation Procedure	340
Optional Counter Interface Unit Type M12 (B870-21)	345
Component Check	345
Installation Procedure	345
Key Counter Bracket Type M3 (D739-09).....	348
Component Check	348
Installation Procedure	348
NFC Card Reader Type M37 (D3GF-34).....	352
Component Check	352
Installation Procedure	352
Smart Card Reader Built-in Unit Type M37 (D3GF-35).....	359
Component Check	359
Installation Procedure	359
SD Card Options	372
SD Card Slots	372
SD Card Appli Move	372
PostScript3 Unit Type M37 (D3GF-26, -27, -28).....	376
Camera Direct Print Card Type M37 (D3GF-30).....	380
IPDS Unit Type M20 (D3BC-20, -21, -22).....	381
XPS Direct Print Option Type M37 (D3GF-19, -20, -21).....	383
OCR Unit Type M13 (D3AC-23, -24, -25)	384
DataOverwriteSecurity Unit Type M19 (D3BS-03).....	386
VM CARD Type M37 (D3GF-32).....	392
Network Settings	394
Specifying Network Settings According to Customer's Environment.....	394
Settings on Displaying an Alert When the Ethernet Cable is Broken or Disconnected	395
@Remote Settings	396
Security Settings.....	401
Security Function Installation.....	401
Data Overwrite Security.....	401
HDD Encryption	403
"Web Help Support" Settings	411
Overview	411
How to Enable/Disable Web Help Support.....	411
"RemoteConnect Support" Settings	414
Overview	414
How to Enable/Disable RemoteConnect Support	414
Uninstalling RemoteConnect Support	417
"Remote Panel Operation" Settings	418

Overview	418
How to Enable/Disable Remote Panel Operation/Monitoring	419
Operation Guidance for Users	421
Checking the Connection of Peripherals and Options	421
3. Preventive Maintenance	423
PM Parts Settings	423
Replacement Procedure of the PM Parts	423
After Installing the New PM Parts	426
Operation Check	426
PM Parts List	430
4. Replacement and Adjustment	431
Notes on the Main Power Switch	431
Push Switch	431
Beforehand	434
Special Tools and Lubricants	435
Special Tools and Lubricants	435
Where to Apply Noise-Reduction Grease	435
Exterior Covers	446
Overview	446
Front Cover	448
Controller Cover	449
Upper Left Cover	449
Left Rear Cover	450
Left Cover	450
Rear Cover	452
Rear Lower Cover	453
Right Rear Cover	453
Right Upper Cover	454
Proximity Sensor Cover	455
Proximity Sensor (S49)	456
Main Power Switch Cover	458
Waste Toner Cover	458
Inverter Tray	459
Paper Exit Tray	459
Paper Exit Cover	460
Paper Exit Lower Cover	460
Paper Exit Front Cover	461
Inner Upper Cover	461
Inner Lower Cover	462

Operation Panel (PCB13).....	463
Operation Panel Unit	463
USB Cable	466
ADF	468
ADF Removal	468
Scanner Unit.....	471
Before You Begin.....	471
Scanner Exterior	471
Exposure Glass	473
Scanner Carriage.....	475
Scanner Motor (M26).....	481
APS Sensors (S44)(S45).....	482
Scanner Home Position Sensor (S42)	483
ADF/Platen Cover Sensor (S43)	484
Scanner FFC.....	484
Laser Unit	488
Laser Unit.....	488
Polygon Mirror Motor (M27).....	492
SP descriptions.....	492
PCDU.....	494
Notes when replacing a PCDU	494
PCDU	500
PCU/Development Unit	502
Imaging Temperature Sensor (Thermistor) (S33).....	509
Waste Toner	511
Before Replacing the Waste Toner Bottle	511
Replacement.....	511
Waste Toner Bottle Full Sensor (S34), Waste Toner Bottle Set Sensor (S35)	512
Image Transfer Unit.....	515
Image Transfer Belt Unit.....	515
Image Transfer Cleaning Unit.....	518
Image Transfer Belt	523
Paper Transfer Roller	530
Paper Transfer Roller Unit.....	533
Fusing Entrance Sensor (S1)	535
TM/ID Sensor (S48).....	536
Temperature and Humidity Sensor (S41).....	540
ITB Contact and Release Sensor (S32).....	541
Image Transfer Lock Unit	542

Drive Unit	545
Overview	545
Paper Feed Motor (M6)	546
Transport Motor (M5).....	547
Paper Transfer Contact and Release Motor Unit (M18)	547
Imaging Drive Unit	548
PCU Motor: CMY (M15)	549
Development Motor: CMY (M16).....	550
Development Motor: Black (M29).....	550
PCU: Black / Image Transfer Motor (M17).....	551
Registration Motor (M7).....	551
Fusing Motor (M8)	551
Paper Exit / Pressure Release Motor (M4).....	552
Duplex Entrance Motor (M1)	552
Toner Supply Motor (M19) (M20) (M21) (M22).....	553
Sub Hopper.....	554
Toner End Sensor (S18)(S19)(S20)(S21).....	558
Toner Bottle Drive Motor	558
ID Chip Contact Board.....	560
Transport Coil Unit.....	562
Fusing Unit.....	568
Fusing Unit.....	568
Fusing Entrance Guide Plate.....	569
Fusing Exit Guide Plate	570
Fusing Upper Cover.....	571
Fusing Lower Cover.....	571
Fusing Sleeve Belt Unit	572
Pressure Roller	576
Fusing Sleeve Thermostat Unit	578
Non-Contact Thermistor (S46)(S47)	578
Pressure Roller Thermistor (TH3) (TH4) (TH5).....	579
Thermopile Unit	579
Pressure Roller HP Sensor (S26).....	580
Shield Position Sensor (S50) (IM C6000/5500/4500).....	580
Shield Drive Motor (M28) (IM 6000/5500/4500).....	581
Fusing Exit Drive Solenoid (SOL3).....	582
Paper Exit	583
Paper Exit Unit.....	583
Paper Exit Solenoid (SOL2)	584

Paper Exit Sensor (S10).....	584
Reverse Sensor (S9).....	585
Paper Exit Full Sensor (S11) (IM C6000/C5500/C4500/C3500/C3000).....	587
Reverse Motor (M3).....	588
Fusing Exit Sensor (S27).....	589
Paper Feed.....	590
Paper Feed Unit.....	590
Paper Dust Collection Unit.....	593
Pick-up Roller, Paper Feed Roller.....	594
Friction Roller (1st Paper Tray), Torque Limiter.....	594
Friction Roller (2nd Paper Tray), Torque Limiter.....	595
Lift Motor (1st Feed Tray) (M9), Lift Motor (2nd Feed Tray) (M10).....	595
Paper Feed Sensor (S12) (S22) (IM C6000/5500/4500/3500/3000).....	596
Transport Sensor (S13)(S23).....	597
Upper Limit Sensor (S15) (S25).....	597
Paper End Sensor (S14) (S24).....	598
Registration Sensor (S16).....	598
Bypass Tray Unit.....	600
Bypass Tray.....	600
Bypass Paper End Sensor (S6).....	602
Bypass Pick-up Roller.....	603
Bypass Paper Feed Roller.....	603
Bypass Separation Roller/Torque Limiter.....	604
Bypass Width Sensor (S8).....	604
Bypass Length Sensor (S7).....	607
Bypass Table Calibration.....	607
Bypass Pick-up Solenoid.....	608
Duplex Unit.....	613
Duplex Unit.....	613
Bypass/Duplex Motor (M2).....	614
Duplex Entrance Sensor (S5).....	615
Duplex Exit Sensor (S3).....	617
Duplex Guide Plate Open/Close Sensor (S4).....	618
Electrical Components.....	619
Overview.....	619
Controller Box Cover.....	621
BICU (PCB10).....	621
Controller Board (PCB11).....	624
HDD (PCB12).....	631

Controller Box	632
Imaging IOB (PCB2)	632
HVP-TTS (PCB16)	634
PSU (AC Controller Board) (PCB9)	634
PSU (DC Power)	635
Power Supply Box	637
Paper Transport IOB (PCB1)	638
HVP-CB (PCB19)	638
Proximity Sensor Board (PCB18)	640
Fans/Filters	642
Exhaust Filter	642
Deodorization Filter	643
Development Intake Fan (FAN6)	643
Ozone Exhaust Fan (FAN3)	644
Paper Exit Cooling Fan (FAN7)	647
Fusing Exhaust Fan (FAN1)	647
Drive Cooling Fan (FAN9) (IM C6000/C5500/C4500 Only)	648
Main Exhaust Fan (FAN8) (IM C6000/C5500/C4500 Only)	648
Toner Supply Cooling Fan (FAN5)	649
PSU Cooling Fan (FAN2)	650
Controller Box Cooling Fan (FAN4)	650
Image Adjustment	652
Auto Color Calibration	652
Adjusting the Tone of the Printed Image	653
Adjustment by Changing the Printer Driver Setting	654
Adjustment by Changing the Machine's Profile Setting	660
Printer Gamma Correction	662
Color Registration	664
Adjustment after Replacement	672
Image Adjustment After Replacing Parts	672
Image Position Adjustment	672
Scanning Adjustment	675
ADF Image Adjustment	676
5. Troubleshooting	678
Self-Diagnostic Mode	678
SC Automatic Reboot	678
HDD-related Messages	679
Service Call Conditions	683
Summary	683

List of Automatic Reboot Target SC.....	684
SC Code Classification	704
SC100 (Engine: Scanning).....	705
SC200 (Engine: Image Writing).....	713
SC300 (Engine: Charge, Development).....	720
SC400 (Engine: Around the Drum)	728
SC500.....	732
Engine: Paper transport 1 (Paper Feed, Duplex, Transport)	732
Engine: Fusing.....	751
SC600.....	771
SC600 (Engine: Communication and Others).....	771
SC600 (Controller).....	789
SC700 (Engine: Peripherals).....	799
SC800 (Controller).....	833
SC900.....	865
SC900 (Engine: Others)	865
SC900 (Controller).....	868
Troubleshooting for SC Errors.....	879
When SC285-02 (MUSIC Error) is displayed.....	879
When SC285-03 (Insufficient MUSIC patterns) is Displayed.....	882
When SC370 (TM (ID) sensor calibration error) is Displayed.....	882
When SC371 (TM/ID Sensor Output Error: Background Output (Regular Reflection)) is Displayed	884
When SC375 (TM/ID sensor output error, belt damage detected) is Displayed.....	885
When SC501, SC502, SC503, or SC504 (Paper Tray Lift/Descent Error) is Displayed	885
When SC549 (Shield Operation Error Detection) is Displayed.....	886
When SC670 (Engine start up error) is displayed.....	890
When SC672 (Controller start up error) is displayed	891
Jam Detection.....	899
Jam Display	899
Clearing a Paper Jam	899
Paper Jam History	899
Jam Codes and Display Codes	900
Paper Size Code.....	910
Sensor Locations	911
Troubleshooting for Transport/Paper Feeding of the Machine	912
Curled Paper.....	912
Initial Jam.....	912
Jam	915

Display Error	937
Others	942
Troubleshooting for Finishing Options	946
Side-to-side Registration Error (Finisher Registration Adjustment)	946
Stapling Misalignment of Some Sheets or Last Sheet (Booklet Finisher SR3290 / Finisher SR3280) (Booklet Finisher SR3290/Finisher SR3280)	950
Paper Stacking Error on Shift Tray (Booklet Finisher SR3270 / Finisher SR3260).....	952
Finisher Jogger Problem (Booklet Finisher SR3270/Finisher SR3260).....	955
Skew Adjustment for Saddle Stitching and Center Folding (Booklet Finisher SR3270).....	956
Early Tray Full Detection Mylar for Internal Finisher SR3250.....	958
Paper Curl Problem for Internal Finisher SR3300.....	962
Maximum number of Sheets for Stapling and What Happens when the Job Has Too Many Pages	964
Electrical Component Defects	967
Fuses	967
Vertical Streaks on Copies due to Scanning Problems	971
Overview	971
Image Quality Problems	977
Misrecognition of Auto Color Selection When Scanning Originals	977
Misrecognition of Auto Color Selection (Copy/Scanner).....	979
Failure to Reproduce Colored Text During Color Copying	981
Flowchart for Identifying Unit Causing Image Quality Degradation	983
Scale-Like Density Fluctuation	984
Other Troubleshooting.....	987
When Fluorescent/ LED Lamps Flicker.....	987
When Abnormal Noise Occurs	988
Error Message "Replacement of the control panel is now necessary" is Displayed and SC843-02 Occurs.....	991
Error Message "Invalid firmware is..." Appears after Turning Power ON.....	992
6. System Maintenance	994
SP Tables	994
Overview of Firmware Update.....	995
Difference from Previous Machine	995
Overview	995
Firmware Types	996
Firmware Update (Removable Media)	1001
Overview	1001
Media slot to use when updating.....	1001
Update Procedure.....	1002

Error Screens During Updating	1009
Firmware Update (Smart Firmware Update)	1015
Overview	1015
Immediate Update	1015
Update at the Next Visit (Reserve).....	1018
Firmware Update (Remote Firmware Update).....	1025
RFU Performable Condition	1025
Firmware Update (Auto Remote Firmware Update)	1026
Overview	1026
Downloading and Updating Process	1026
Related SP.....	1031
Updating JavaVM	1035
Overview	1035
Deactivating SDK Applications and Removing the VM Card	1035
Updating JavaVM and Inserting the VM Card	1037
Activating SDK Applications	1038
NVRAM Data Upload/Download	1039
Uploading Content of NVRAM to an SD card	1039
Downloading an SD Card to NVRAM.....	1040
Address Book Upload/Download.....	1041
Information List	1041
Download	1041
Upload.....	1042
Capturing the Device Logs	1043
Overview	1043
Retrieving the Device Logs via Operation Panel.....	1045
Retrieving the Device Logs via Web Image Monitor	1047
SMC List Card Save Function	1050
Overview	1050
Procedure	1050
File Names of the Saved SMC Lists.....	1052
Error Messages	1053
UP/SP Data Import/Export	1054
UP Data Import/Export.....	1054
SP Data Import/Export.....	1056
Possible solutions for import/export problems	1058
Card Save Function.....	1061
Overview	1061
Procedure	1061

Error Messages	1063
Test Pattern Printing.....	1065
7. Detailed Descriptions.....	1066
Product Overview	1066
Component Layout	1066
Paper Path.....	1067
Drive Layout.....	1070
Component Layout	1072
Scanner Unit	1072
Laser Exposure Unit	1073
Image Transfer Unit.....	1074
PCDU	1075
Toner Supply / Waste Toner Bottle	1076
Paper Feed Unit.....	1077
Duplex Unit	1078
Bypass Unit.....	1079
Fusing Unit.....	1079
Paper Transfer / Paper Exit	1080
Air Flow	1081
Drive Unit	1082
Board / Switch.....	1084
Scanner	1085
Changes from the Previous Models	1085
Overview	1085
Mechanism.....	1087
Image Processing.....	1096
Changes from the Previous Machine	1096
Mechanism.....	1096
Laser Unit	1098
Changes from the Previous Models	1098
Overview	1098
Mechanism.....	1100
Auto Image Adjustment (Image Density / Color Calibration)	1104
Changes from the Previous Models	1104
Mechanism.....	1106
Process Control (Image Density Control).....	1107
MUSIC (Automatic Color Registration Correction).....	1113
Real Time Process Control.....	1115
IBACC	1116

SP Descriptions	1117
PCDU (Photo Conductor and Development Unit).....	1120
Changes from the Previous Models	1120
Overview	1121
Mechanism (PCU)	1123
Mechanism (Development).....	1124
Toner Supply	1128
Changes from the Previous Machine	1128
Overview	1128
Mechanism.....	1128
Waste Toner	1136
Changes from the Previous Models	1136
Overview	1138
Mechanism.....	1138
Image Transfer and Paper Transfer.....	1141
Changes from the Previous Models	1141
Overview	1142
Image Transfer Unit Mechanism	1143
Image Transfer Belt Cleaning Mechanism	1145
Paper Transfer Unit Mechanism.....	1145
Paper Feed / Transport	1148
Changes from the Previous Models	1148
Overview	1154
Feed / Transport	1155
Bypass Feed.....	1164
Duplex.....	1167
Paper Exit Unit.....	1170
Drive/Sensor Layout	1173
Fusing.....	1178
Changes from the Previous Models	1178
Overview	1179
Mechanism.....	1180
Electrical Parts.....	1190
Changes from the Previous Models	1190
Block Diagram	1192
Board Outline.....	1192
Paper Tray Dehumidifier Heaters and Scanner/PCDU Anti-condensation Heaters.....	1193
Exterior Cover/Air Flows (Fan Control)	1195
Changes from the Previous Models	1195

Overview	1197
Mechanism.....	1202
Energy Save	1205
Energy Saver Modes	1205
Power States of this Machine	1207
Verification of Up Time for each Energy Saving State	1209
Checking the Up time by Device State	1210
Recommendation.....	1211
New Functions	1212
PS3/PDF Direct Emulation (Clone PS)	1212
Bypass Tray Assist Function	1222
Web Help Support	1222
Displaying an Alert When the Ethernet Cable is Broken or Disconnected	1222
"RemoteConnect Support" and "Remote Panel Operation"	1223
Copy: Shiny Materials Mode.....	1223
Other Functions	1224
Proximity Sensor.....	1224
10 Second Recovery from Sleep Mode.....	1227
8. Smart Operation Panel G2.5	1229
Replacement and Adjustment	1229
LCD	1229
Microphone	1230
Wi-Fi Module.....	1231
Speaker.....	1231
Main Controller Board.....	1232
NFC Board	1235
Mechanism	1237
System Components	1237
Panel Components/Screen Layout.....	1244
Electrical Components.....	1247
Controlling the Power Supply	1249
System Maintenance	1253
Maintenance Modes	1253
Login to/Logout from Control Panel Service Mode	1253
Service Mode Menu.....	1255
Panel Self Check	1262
Recovery Mode.....	1269
Special Key Combinations.....	1270
Backup/Restore for Smart Operation Panel Application/Settings Function.....	1270

Software Update	1272
Troubleshooting	1278
Problems and Errors Related to Hardware	1278
Errors Related to Applications	1279
Factory Reset and Restoration	1280
Errors that occur during application update from an SD card	1281
Errors that occur during update from the eDC Server	1283
Other Troubleshooting	1284

1. Product Information

Changes from the Previous Models

Lookup Table

Component	Changed Item	MP	IM
		C2004/C2504/C3004/C3504/C4504/C5504/C6004(Previous Model)	C2000/C2500/C3000/C3500/C4500/C5500/C6000
Exterior Covers	Proximity Sensor Left Cover	N/A	Added
Document Feeder	Double-feed Detection	Not supported	Optional (Page Keeper Type 37)
	Small Size Paper	Not supported	Optional (Small Paper Feeding Unit Type M37)
Scanner Unit	Image Sensor	CCD	CMOS
Auto Image Adjustment	Auto Color Calibration (ACC)	-	Added the quick correction mode Changed the test pattern layout
Laser Unit	Synchronizing detector board Cylinder lens on Y and M color side	Provided	Removed
PCDU	PCDU Seals	Wound by a supplied lever	Wound automatically when turning on the power
	Removin	Secured by screw	Secured by lever

1.Product Information

Component	Changed Item	MP C2004/C2504/C3004/C3504/C4504/C5504/C6004(Previous Model)	IM C2000/C2500/C3000/C3500/C4500/C5500/C6000
	g PCDU		
Operation Panel	Version	G2	G2.5
	Harness	Between operation panel and IPU	Between operation panel and CTL
Fusing Unit	Tools for Attachment	Screws	Lock lever (same as Met-P2)
Paper Transfer	Paper Transfer Unit	PM part (400K)	EM part
	Image Transfer Cleaning Unit cycle	300K	600K
Electrical Components	Board Composition	IPU, BCU	BICU (combined IPU and BCU)
	NVRAM	2 (2M×2)	1 (4M×1)
	Java VM	Standard onboard function	Supplied as an optional SD card
Proximity Sensor (S49)	SC869-01	Occurs if continuously switched on for 24 hours	Occurs if continuously switched on for 480 hours
	SC869-02	Occurs on detecting user operation 20 times when switched off	Occurs on detecting user operation 300 times when switched off
Airflow	Exhaust Filter – Maintenance Interval	300K	400K
	Others	-	<ul style="list-style-type: none"> Removed Helmholtz system Removed PSU exhaust fan Exhaust filter (removed only on y/z models)
Waste Toner	-	Replaced by Service Technician	Replaced by user
	Waste	N/A	Started the service

1.Product Information

Component	Changed Item	MP C2004/C2504/C3004/C3504/C4504/C5504/C6004(Previous Model)	IM C2000/C2500/C3000/C3500/C4500/C5500/C6000
Bottle	Toner Bottle Automatic Delivery Service		
Other New Features		-	<ul style="list-style-type: none"> • PS3/PDF Direct Emulation (Clone PS) • "Web Help Support" Settings • "RemoteConnect Support" Settings • "Remote Panel Operation" Settings • Settings on Displaying an Alert When the Ethernet Cable is Broken or Disconnected

Exterior Cover/Air Flows (Fan Control)

Refer to ["Changes from the Previous Models"](#).

Scanner

Refer to ["Changes from the Previous Models"](#).

Laser Unit

Refer to ["Changes from the Previous Models"](#).

Auto Image Adjustment

Refer to ["Changes from the Previous Models"](#).

PCDU (Photo Conductor and Development Unit)

Refer to ["Changes from the Previous Models"](#).

Fusing

Refer to "[Changes from the Previous Models](#)".

Waste Toner

Refer to "[Changes from the Previous Models](#)".

Paper Feed / Transport

Refer to "[Changes from the Previous Models](#)".

Electrical Components

Refer to "[Changes from the Previous Models](#)".

Machine Codes and Peripherals Configuration

Main Machine

The machine codes have the following suffix codes, which show where the machine is delivered to.

Key	Area	Power
-17	North America/ Central, South America	120V/60Hz
-18	North America GSA models	120V/60Hz
-19	Taiwan	110V/60Hz
-21	China	220-240V/50-60Hz
-22	China	220-240V/50-60Hz
-27	Europe/ Middle, Near East	220-240V/50-60Hz
-29	Asia/Pacific/ Central, South America, Korea	220-240V/50-60Hz
-65	Europe/ Middle, Near East	220-240V/50-60Hz

-17

Product name	Machine code	Model code	Initial configuration
IM C6000	D0BQ-17	MF3e	SPDF
IM C4500	D0BN-17	MF3c	SPDF
IM C3500	D0BM-17	MF3b	SPDF
IM C3000	D0BL-17	MF3a	SPDF
IM C2000	D0BJ-17	MF3y	ARDF
IM C2500	D0BK-17	MF3z	ARDF

-18

Product name	Machine code	Model code	Initial configuration	Remarks
IM C4500G	D0BN-18	MF3c	SPDF	GSA Model
IM C3500G	D0BM-18	MF3b	SPDF	GSA Model
IM C3000G	D0BL-18	MF3a	SPDF	GSA Model
IM C2000G	D0BJ-18	MF3y	ARDF	GSA Model
IM C2500G	D0BK-18	MF3z	ARDF	GSA Model

-19

Product name	Machine code	Model code	Initial configuration
IM C6000	D0BQ-19	MF3e	SPDF
IM C4500	D0BN-19	MF3c	SPDF
IM C3500	D0BM-19	MF3b	ARDF
IM C3000	D0BL-19	MF3a	ARDF
IM C2000	D0BJ-19	MF3y	ARDF

Product name	Machine code	Model code	Initial configuration
IM C2500	D0BK-19	MF3z	ARDF

-21

Product name	Machine code	Model code	Initial configuration
IM C6000	D0BQ-21	MF3e	SPDF
IM C4500	D0BN-21	MF3c	-
IM C3500	D0BM-21	MF3b	-
IM C3000	D0BL-21	MF3a	-
IM C2000	D0BJ-21	MF3y	-
IM C2500	D0BK-21	MF3z	-

-22

Product name	Machine code	Model code	Initial configuration
GS3160c	D0BQ-22	MF3e	SPDF
GS3045c	D0BN-22	MF3c	-
GS3030c	D0BL-22	MF3a	-
GS3020c	D0BJ-22	MF3y	-
GS3025c	D0BK-22	MF3z	-

-27

Product name	Machine code	Model code	Initial configuration
IM C6000	D0BQ-27	MF3e	SPDF
IM C5500	D0BP-27	MF3d	ARDF
IM C4500	D0BN-27	MF3c	ARDF
IM C3500	D0BM-27	MF3b	ARDF
IM C3000	D0BL-27	MF3a	ARDF
IM C2000	D0BJ-27	MF3y	ARDF
IM C2500	D0BK-27	MF3z	ARDF

-29

Product name	Machine code	Model code	Initial configuration
IM C6000	D0BQ-29	MF3e	SPDF
IM C4500	D0BN-29	MF3c	SPDF
IM C3500	D0BM-29	MF3b	-
IM C3000	D0BL-29	MF3a	-
IM C2000	D0BJ-29	MF3y	-
IM C2500	D0BK-29	MF3z	-

1.Product Information

-65

Product name	Machine code	Model code	Initial configuration
IM C5500A	D0BP-65	MF3d	SPDF
IM C4500A	D0BN-65	MF3c	SPDF
IM C3500A	D0BM-65	MF3b	SPDF
IM C3000A	D0BL-65	MF3a	SPDF
IM C2000A	D0BJ-65	MF3y	SPDF
IM C2500A	D0BK-65	MF3z	SPDF

Option

y: IM C2000, z: IM C2500, ab: IM C3000/IM C3500

cd: IM C4500/IM C5500, e: IM C6000

Internal Options

Product Name	Code	Supporting models					New or Common
		y	z	ab	cd	e	
Fax Option Type M37	D3GF-02, -03, -04, -05, -06	☞	☞	☞	☞	☞	New
G3 Interface Unit Type M37	D3GF-41, -42, -43	☞	☞	☞	☞	☞	New
Fax Connection Unit Type M37	D3GF-15, -16, -17	☞	☞	☞	☞	☞	New
FAX Memory Unit Type M19 64MB	D3BZ-17	☞	☞	☞	☞	☞	Common (C2/C2.1)
IEEE 1284 Interface Board Type M19	D3C0-17	☞	☞	☞	☞	☞	Common (C2/C2.1)
IEEE 802.11a/g/n Interface Unit Type M19 (Not supplied in China or Taiwan)	D3BR-01	☞	☞	☞	☞	☞	Common (C2/C2.1)
File Format Converter Type M19	D3BR04	☞	☞	☞	☞	☞	Common (C2/C2.1)
Memory Unit Type M37 4GB	D3GF08	☞	☞	☞	☞	☞	New
Device Server Option Type M37 (Not supplied in China or Taiwan)	D3GF-10, -11	☞	☞	☞	☞	☞	New
OCR Unit Type M13	D3AC-23, -24, -25	☞	☞	☞	☞	☞	Common (C2/C2.1)
VM CARD Type M37	D3GF-32	☞	☞	☞	☞	☞	New
Enhanced Security HDD Option Type M12 (Not supplied in China, Taiwan or other Asian countries)	D3A6-02	☞	☞	☞	☞	☞	Common (C2/C2.1)

1.Product Information

Product Name	Code	Supporting models					New or Common
		y	z	ab	cd	e	
DataOverwriteSecurity Unit Type M19	D3BS-03	☞	☞	☞	☞	☞	Common (C2/C2.1)
IPDS Unit Type M20	D3BC-20, -21, -22	☞	☞	☞	☞	☞	Common (C2/C2.1)

External Option / Peripheral Devices

Product Name	Code	Supporting models					New or Common
		y	z	ab	cd	e	
Platen Cover PN2000 (China and rest of Asia only)	D700-01	☞	☞	☞	☞	-	Common (C2/C2.1)
ARDF DF3110	D3FE-17, -21	☞	☞	☞	☞	-	New
SPDF DF3120	D3FF-17, -21	☞	☞	☞	☞	-	New
Small Paper Feeding Unit Type M37	D3FF-18, -22	☞	☞	☞	☞	☞	New
Page Keeper Type M37	D3FF-19, -23	☞	☞	☞	☞	☞	New
Paper Feed Unit PB3280	D3FY-17, -21	-	-	☞	☞	☞	New
Paper Feed Unit PB3300	D3FZ-17, -21	☞	☞	-	-	-	New
Paper Feed Unit PB3270	D3G0-17, -21	☞	☞	☞	☞	☞	New
LCIT PB3290	D3G2-17, -21, -27	-	-	☞	☞	☞	New
LCIT RT3040	D3G1-17, -21, -27	-	-	☞	☞	☞	New
Bridge Unit BU3090	D3FW-17, -21	☞	☞	☞	☞	☞	New
1 Bin Tray BN3130	D3CQ-18, -22	☞	☞	☞	☞	☞	New
Internal Shift Tray SH3080	D3FV-17, -21	☞	☞	☞	☞	☞	New
Side Tray Type M37	D3FX-17, -21	☞	☞	☞	☞	☞	New
Handset HS3020 (North America only)	D739-17	☞	☞	☞	☞	☞	Common (C2/C2.1)
Caster Table Type M3	D178-02	☞	☞	☞	☞	☞	Common (C2/C2.1)
Booklet Finisher SR3290	D3FN-17, -21	-	-	-	☞	☞	New
Finisher SR3280	D3G4-17, -21	-	-	-	☞	☞	New
Punch Unit PU3090 NA	D3FP-00	-	-	-	☞	☞	New
Punch Unit PU3090 EU	D3FP-01	-	-	-	☞	☞	New
Punch Unit PU3090 SC	D3FP-02	-	-	-	☞	☞	New
Booklet Finisher SR3270	D3FQ-17, -21	☞	☞	☞	☞	☞	New
Finisher SR3260	D3FR-17, -21	☞	☞	☞	☞	☞	New
Punch Unit PU3080 NA	D3G5-17	☞	☞	☞	☞	☞	New

1.Product Information

Product Name	Code	Supporting models					New or Common
		y	z	ab	cd	e	
Punch Unit PU3080 EU	D3G5-27	☑	☑	☑	☑	☑	New
Punch Unit PU3080 SC	D3G5-28	☑	☑	☑	☑	☑	New
Internal Finisher SR3250	D3FG-17, -21	☑	☑	☑	☑	-	New
Punch Unit PU3070 NA	D3FM-17	☑	☑	☑	☑	-	New
Punch Unit PU3070 EU	D3FM-27	☑	☑	☑	☑	-	New
Punch Unit PU3070 SC	D3FM-28	☑	☑	☑	☑	-	New
Internal Finisher SR3300	D3FT-17, -21	☑	☑	☑	-	-	New
Internal Multi-Fold Unit FD3010	D3FS-17, -21	-	-	☑	☑	☑	New
Imageable Area Extension Unit Type M19	D3BR-07	☑	☑	☑	☑	☑	Common (C2/C2.1)
ADF Handle TypeC	D593-81	☑	☑	☑	☑	☑	Common (C2/C2.1)
External Keyboard Bracket Type M19	D3BR-10	☑	☑	☑	☑	☑	Common (C2/C2.1)
Banner Paper Guide Tray Type M19	D3BF-00	☑	☑	☑	☑	☑	Common (C2/C2.1)

Options Connectable to the Printer

Product Name	Code	Supporting models					New or Common
		y	z	ab	cd	e	
Camera Direct Print Card Type M37	D3GF-30	☑	☑	☑	☑	☑	Common (C2/C2.1)
PostScript3 Unit Type M37	D3GF-27	☑	☑	☑	☑	☑	New
XPS Direct Print Option Type M37	D3GF-19, -20, -21	☑	☑	☑	☑	☑	New
IPDS Unit Type M37	D3GF-44, -45, -46	-	-	-	☑	☑	New

EFI-Related Option

Product Name	Code	Supporting models					New or Common
		y	z	ab	cd	e	
Color Controller E-25C	D3GF-37, -38	-	-	☑	☑	☑	New

User Authentication-Related Option

1.Product Information

Product Name	Code	Supporting models					New or Common
		y	z	ab	cd	e	
NFC Card Reader Type M37	D3GF-34	☒	☒	☒	☒	☒	New
Smart Card Reader Built-in Unit Type M37	D3GF-35	☒	☒	☒	☒	☒	New

Other Options

Product Name	Code	Supporting models					New or Common
		y	z	ab	cd	e	
Optional Counter Interface Unit Type M12	B870-21	☒	☒	☒	☒	☒	Common (C2/C2.1)
Key Counter Bracket Type M3	D739-09	☒	☒	☒	☒	☒	Common (C2/C2.1)

1.Product Information

Diagram

IM C6000 Peripherals

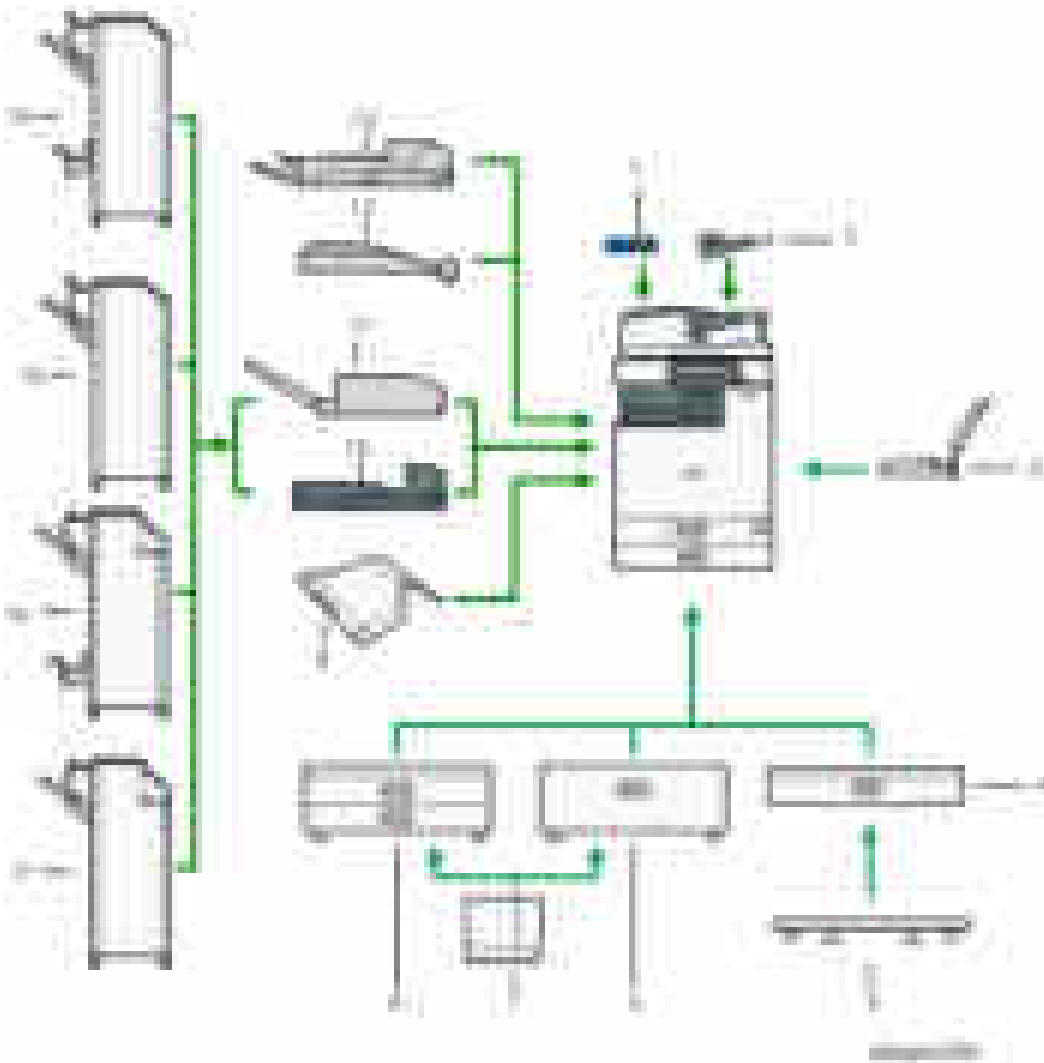

No.	Name	No.	Name
1	Page Keeper Type M37	10	Bridge Unit BU3090
2	Small Paper Feeding Unit Type M37	11	Internal Multi-Fold Unit FD3010
3	Banner Paper Guide Tray Type M19	12	Internal Shift Tray SH3080
4	Paper Feed Unit PB3270	13	Side Tray Type M37
5	Caster Table Type M3	14	Booklet Finisher SR3270
6	LCIT PB3290	15	Finisher SR3260
7	LCIT RT3040	16	Booklet Finisher SR3290
8	Paper Feed Unit PB3280	17	Finisher SR3280
9	1 Bin Tray BN3130	-	-

IM C5500 / IM C4500 Peripherals

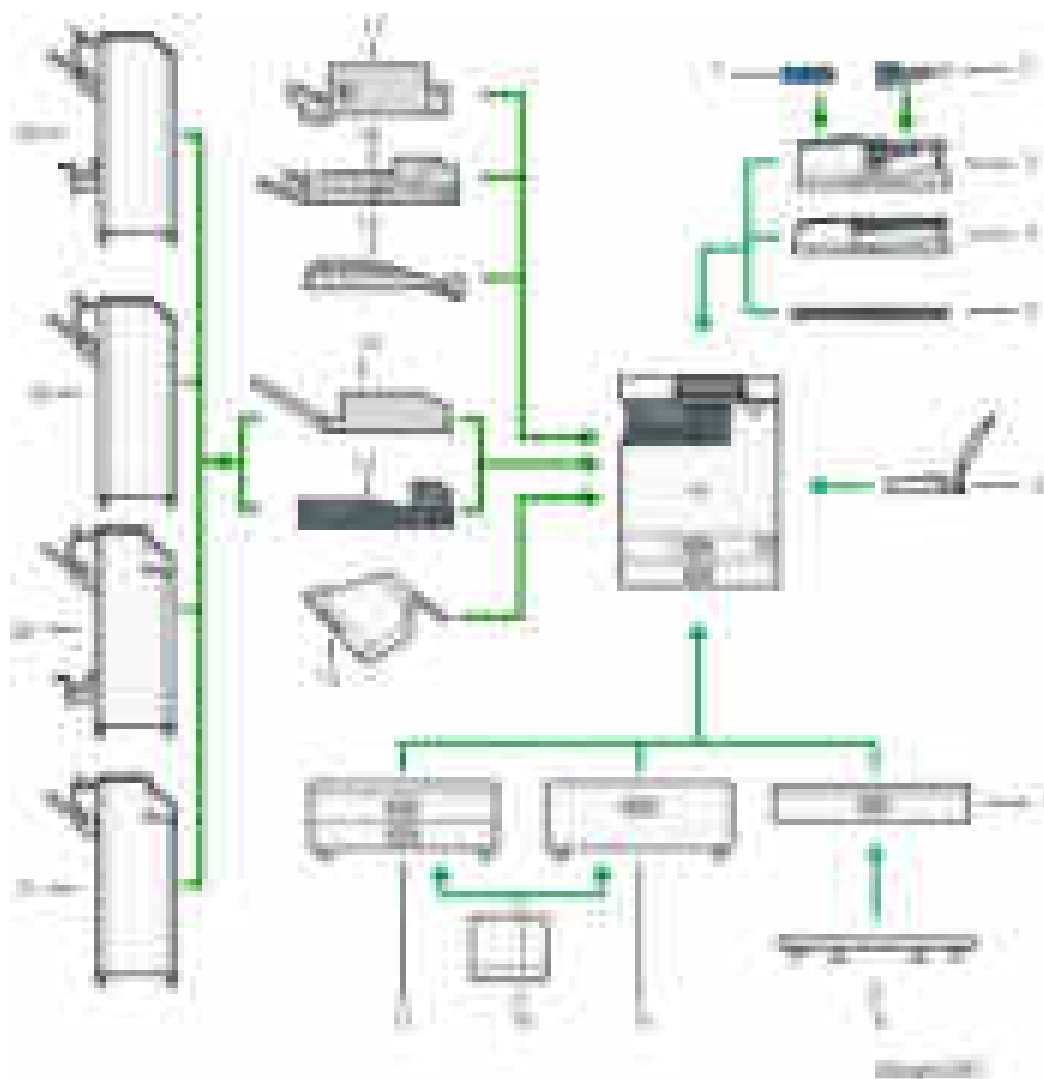

No.	Name	No.	Name
1	Page Keeper Type M37	12	1 Bin Tray BN3130
2	Small Paper Feeding Unit Type M37	13	Bridge Unit BU3090
3	SPDF DF3120	14	Internal Multi-Fold Unit FD3010
4	ARDF DF3110	15	Internal Shift Tray SH3080
5	Platen Cover PN2000	16	Side Tray Type M37
6	Banner Paper Guide Tray Type M19	17	Internal Finisher SR3250
7	Paper Feed Unit PB3270	18	Booklet Finisher SR3270
8	Caster Table Type M3	19	Finisher SR3260
9	LCIT PB3290	20	Booklet Finisher SR3290
10	LCIT RT3040	21	Finisher SR3280
11	Paper Feed Unit PB3280	-	-

1.Product Information

IM C3500 / IM C3000 Peripherals

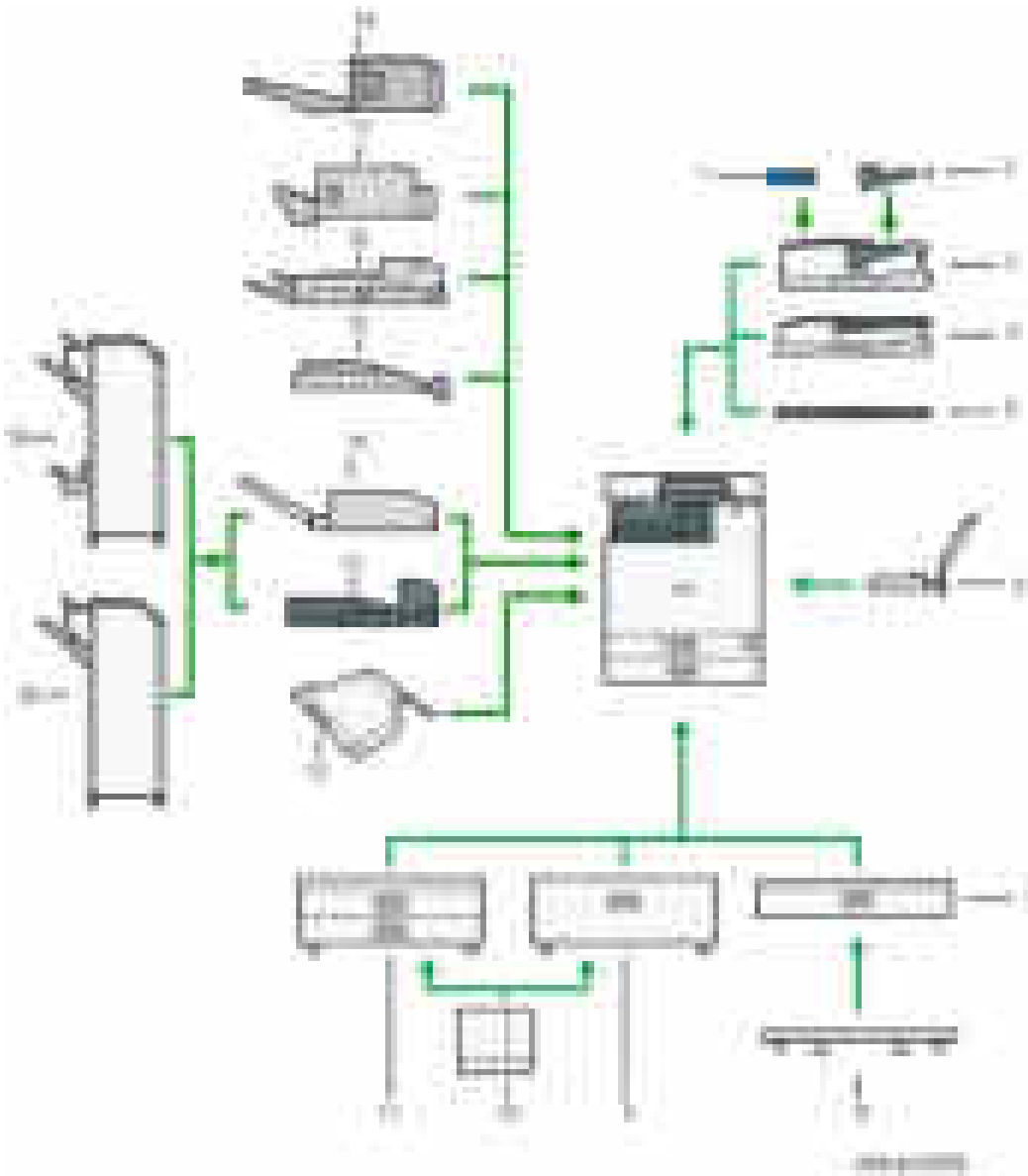

No.	Name	No.	Name
1	Page Keeper Type M37	12	1 Bin Tray BN3130
2	Small Paper Feeding Unit Type M37	13	Bridge Unit BU3090
3	SPDF DF3120	14	Internal Multi-Fold Unit FD3010
4	ARDF DF3110	15	Internal Shift Tray SH3080
5	Platen Cover PN2000	16	Side Tray Type M37
6	Banner Paper Guide Tray Type M19	17	Internal Finisher SR3250
7	Paper Feed Unit PB3270	18	Internal Finisher SR3300
8	Caster Table Type M3	19	Booklet Finisher SR3270
9	LCIT PB3290	20	Finisher SR3260
10	LCIT RT3040	-	-
11	Paper Feed Unit PB3280	-	-

IM C2500 / IM C2000 Peripherals

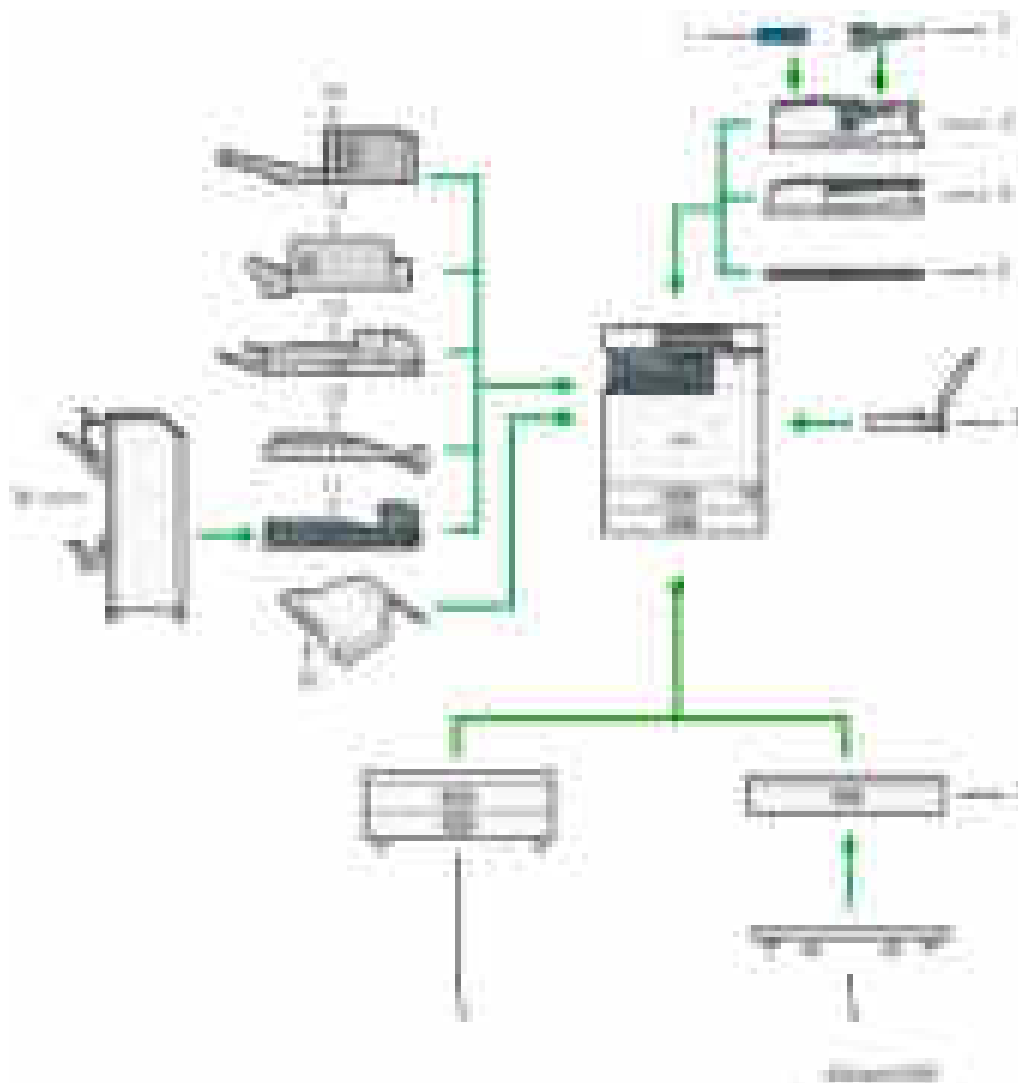

No.	Name	No.	Name
1	Page Keeper Type M37	9	Paper Feed Unit PB3300
2	Small Paper Feeding Unit Type M37	10	1 Bin Tray BN3130
3	SPDF DF3120	11	Bridge Unit BU3090
4	ARDF DF3110	12	Internal Shift Tray SH3080
5	Platen Cover PN2000	13	Side Tray Type M37
6	Banner Paper Guide Tray Type M19	14	Internal Finisher SR3250
7	Paper Feed Unit PB3270	15	Internal Finisher SR3300
8	Caster Table Type M3	16	Booklet Finisher SR3270

1.Product Information

Specifications

See "Appendices" for the following information:

- General Specifications
- Supported Paper Sizes
- Software Accessories
- Optional Equipment
- Other Specifications

2. Installation

Installation Requirements

Environment



Temperature Range:	10°C to 32°C (50°F to 90°F)
Humidity Range:	15% to 80% RH
Ambient Illumination:	Less than 1,500 lux (do not expose to direct sunlight.)
Ventilation:	Room air should turn over at least 30 m ³ /hr/person

1. Avoid areas exposed to sudden temperature changes:
 - 1) Areas directly exposed to cool air from an air conditioner.
 - 2) Areas directly exposed to heat from a heater.
2. Do not place the machine where it will be exposed to corrosive gases.
3. Do not install the machine at any location over 2,000 m (6,500 ft.) above sea level. (NA model can be installed up to 2,500m (8,202 ft.))
4. Place the main machine on a sturdy and level base. Inclination on any side should be no more than 5 mm (0.2").
5. Do not place the machine where it may be subjected to strong vibrations.

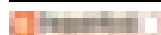

- Store toner where it will not be exposed to direct sunlight, temperatures above 35°C, or high humidity.

2. Installation

Machine Level

- Front to back: Within 5 mm (0.2")
- Right to left: Within 5 mm (0.2")

Machine Space Requirements



- These are the minimum space requirements.

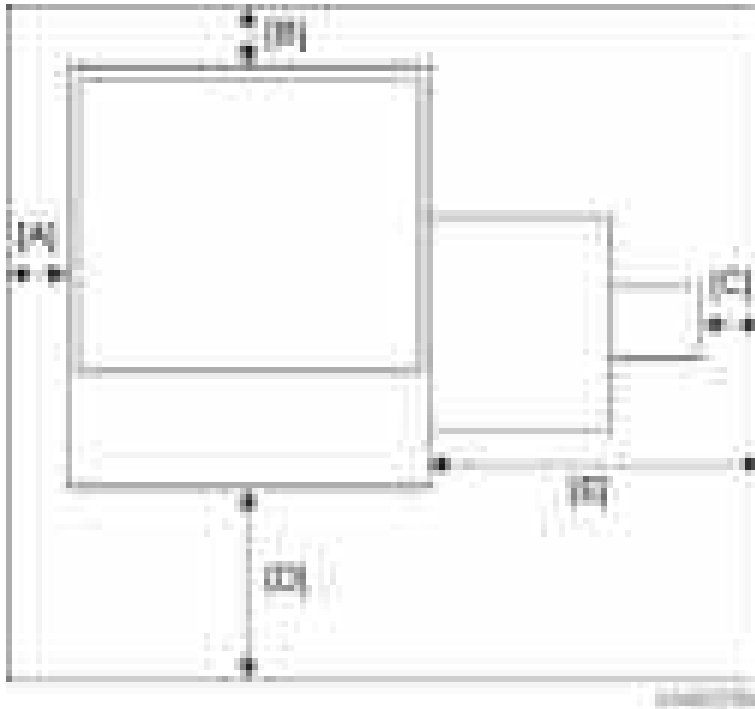

[A]	Left	Over 100 mm (3.9")
[B]	Rear	Over 100 mm (3.9")
[C]	Right (with Bypass tray)	Over 100 mm (3.9")
[D]	Front	Over 750 mm (29.5")
[E]	Right	Over 500 mm (19.7")

Put the machine near the power source with the clearance shown above.



- Main Machine Occupation Dimensions (W x D):
1149 mm (45.24") x 1236 mm (48.67") (With Bypass table opened + Main unit paper exit drawer)

Machine Dimensions

Models equipped with the ARDF (W x D x H up to ARDF):

587 x 685 x 913 mm (23.2 x 27.0 x 36.0 inches)

Models equipped with the SPDF (W × D × H up to SPDF):

587 × 685 × 963 mm (23.2 × 27.0 × 38.0 inches)

Models with no ADF (W × D × H up to exposure glass):

587 × 685 × 788 mm (23.2 × 27.0 × 31.1 inches)

The main machine is equipped with the following peripherals:

- Paper Feed Unit PB3160
- LCIT RT3040
- Bridge Unit BU3090
- Booklet Finisher SR3270

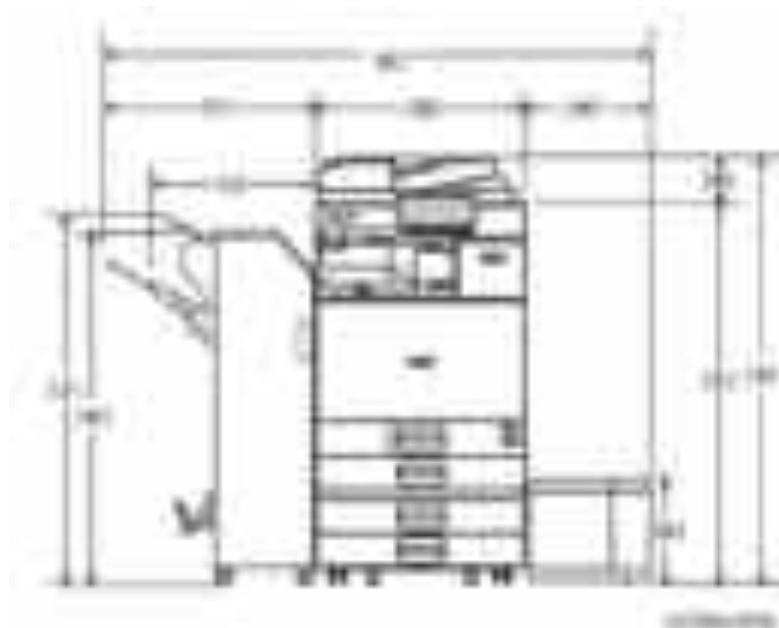

A	1,155mm / 45.47" (when equipped with ARDF) 1,205mm / 47.44" (when equipped with SPDF)
B	125mm /4.92" (when equipped with ARDF) 175mm /6.89" (when equipped with SPDF)
C	1,030mm /40.55"
D	290mm /11.41"
E	1,683mm / 66.26"
F	575 to 660mm / 22.63" to 25.98" (when equipped with Finisher SR3260) 657 to 756mm /25.86" to 29.76" (when equipped with Finisher SR3280)
G	587mm / 23.11"
H	340mm / 13.38"
I	575mm / 22.63" (when equipped with Finisher SR3260) 657mm / 25.86" (when equipped with Finisher SR3280)
J	1,045mm / 41.14" (when equipped with Finisher SR3260)

2. Installation

	1,028mm / 40.47" (when equipped with Finisher SR3280)
K	986mm / 38.81" (when equipped with Finisher SR3260) 973mm / 38.30" (when equipped with Finisher SR3280)

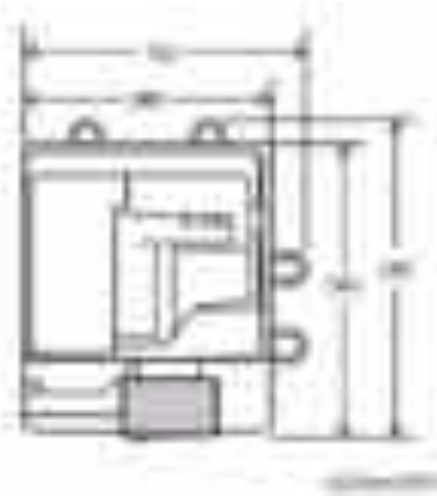

L	668mm / 26.29"
M	587mm / 23.11"
N	738mm / 29.05"
O	685mm / 26.96"

Power Requirements

CAUTION

- Insert the plug firmly in the outlet.
- Do not use an outlet extension plug or cord.

Input Voltage Level

Destination	Power supply voltage	Rated current consumption	Permissible voltage fluctuation
NA	120 to 127V	12A or more	Image quality guaranteed: 108V (120V-10%) to 138V (127V+8.66%) Machine operation guaranteed: 102V (120V-15%) to 138V (127V+8.66%)
EU	220 to 240V	10A	Image quality guaranteed: 198V (220V-10%) to 264V (240V+10%) Machine operation guaranteed: 187V (220-15%) to 276V (240V+15%)
AP			
CHN			

Changes from Previous Machine Concerning Installation

The main unit and peripheral devices can be Installed quickly and easily like user maintenance models SP C840DN / SP C842DN (Met-P2).

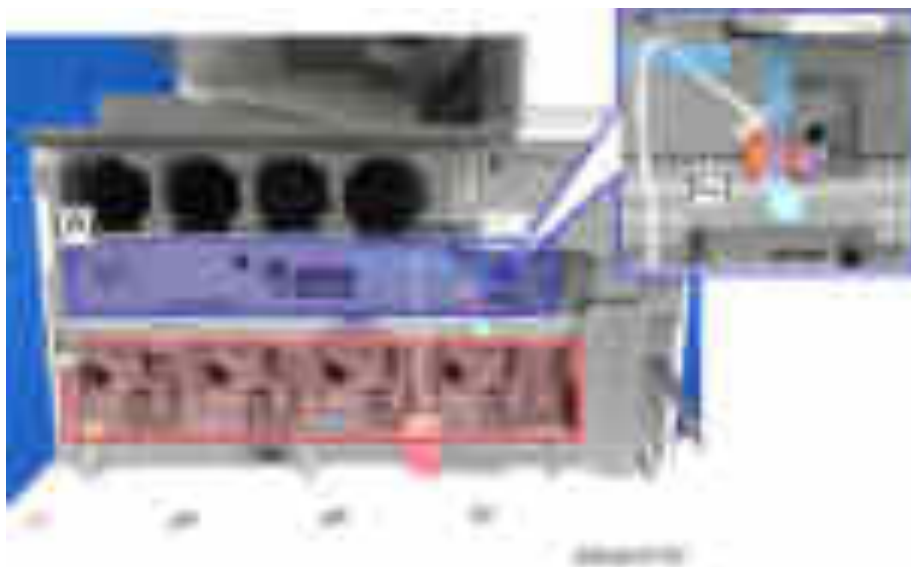

- **Image Transfer Front Cover [A]**

The image transfer front cover included separately with the previous model is already attached to the main unit.

- **PCDU[B]**

On the previous model, the PCDU seals were wound using the supplied winding lever [D], but this model has been superseded by an auto-wind system.



How PCDU seals are removed

Models	CMY	K
IM C6000/C5500/C4500	Wound automatically when turning on the power	
IM C3500/C3000	Pulled out by hand	Wound automatically when turning on the power
IM C2500/C2000	Pulled out by hand	

- **Spacer [C]**

A spacer has been added to secure the ITB contact/separation lever. When shipped from the factory, the image transfer belt and drum are separated, so remove the spacer and raise the ITB contact/separation lever to bring them into contact.

2. Installation

- **Proximity Sensor Left Cover**

A proximity sensor left cover [A] has been added to the proximity sensor cover.

On the previous model, it was necessary to remove the proximity sensor cover when installing the bridge unit and other internal finisher options; but on this model, it is possible to install such options by removing only the proximity sensor left cover.



- **Auto Color Calibration (ACC) Quick Correction Mode**

In response to requests to reduce the time that a service technician takes for adjustment during machine installation, this machine is equipped with Quick Correction mode for Auto Color Calibration (ACC). On the previous model, it was necessary to execute correction at all resolutions (Patterns 1 to 5), but on this model, the correction can be performed simply by executing Quick Test Pattern (Quick Correction Mode) once.



Main Machine Installation: Important Notice on Security Issues

Overview

In order to increase the security of the MFP, and to ensure that the customer sets the administrator password, an administrator set/change prompt display is shown up at the first power-up.



When the customers set the administrator/supervisor login password, the display disappears and the home display will appear. The customers, however, can erase this screen with the following procedure in the case that they think there is no need to set the password.

- 1.** On the Program/Change Administrator screen, press [Change] next to Supervisor and then touch [OK] without inputting any password.
- 2.** Touch [OK] again when the Confirm password display shows up.
- 3.** For Administrator 1, do the same procedure as steps 1 and 2.
- 4.** Press the [OK] button, and then turn the power OFF/ON.

SP5-755-002 (Display Setting: Hide Administrator Password Change Scrn) allows you to skip this screen temporarily and continue the installation procedure without setting an administrator password. However, the Program/Change Administrator screen appears every time you turn the power OFF/ON if the password is not set.



- To enter the SP mode, there are two ways to display the number keyboard on the screen;
 1. Press the "Document Server" icon.
 2. Press and hold the button [A] located on the left side of the operation panel and "Check Status [B]" at the same time.

2. Installation



- For more details about this security issue, see "Notes on Using Multi-Function Printers Safely" supplied with the MFP.
- When Supervisor / Administrator 1-4 passwords are configured via network, the "Change Supervisor login password" window won't display.

Password Setting Procedure

- 1.** Install the machine.
- 2.** Turn ON the main power.
Password change display appears.
- 3.** Press [Change] and change the supervisor login password.



- 4.** Input the password, and then press [OK].
- 5.** Confirm the password, and then press [OK].

6. Change the administrator 1 login password.



7. Input the password, and then press [OK].
8. Confirm the password, and then press [OK].
9. Turn the main power OFF and back ON again.



The passwords for Supervisor or Administrator 1 to 4 can be set via "System Settings". But the Program/Change Administrator screen appears every time the power switch is turned ON if the passwords are set with this method. So we recommend the customers to set the passwords via the network or the Program/Change Administrator screen.

Main Machine Installation: Accessory Check

No.	Name	Q'ty	
		SPDF models	ARDF models
1	Inkjet Decal	1	1
-	Sheet -Safety (EU only)	1	1
2	Paper Size Tray Number Decal	1	1
3	ADF Caution Decal	1	1
4	Sheet -Tel (China only)	1	1
5	Original Set Decal	1	1
6	End Fence	1	1
7	Cap for scanner lock	1	1
8	Gestetner Brand Logo (Asia only)	1	1
9	Logo Plate (except Taiwan, China)	1	1
-	Set of Manuals	1	1
10	Power Cord	1	1
11	Cleaning Cloth	1	1
12	Cleaning Cloth Holder	1	1
-	Warranty (China only)	1	1



Main Machine Installation: Installation Procedure



- Make sure to remove the PCDU seals from the development units before turning the main power ON. The development units can be severely damaged if the PCDU seals are still attached.

Removing the Packing Materials and Shipping Retainers

- 1.** Remove the machine from the box, and check the items in the package.
Remove the styrofoam [A] at the lower front right before lifting up the machine, because the handle for lifting the machine is hidden by the retainer [A].



- When you lift the machine, hold the correct parts, as shown in the photo below.
- Do not lift by holding the scanner unit, etc., because this might deform the machine or

break the exterior covers.



- 2.** Remove the packing tape and retainers on the outside.
The following photo is an example of an SPDF model.



- For a model on which SPDF or ARDF is preinstalled, remove the packing tape and retainers on the SPDF or ARDF.
- For a model on which SPDF, remove the protective sheet as an additional procedure. If the protective sheet remains in the SPDF, a paper jam will be detected.
 - 1.** Open the SPDF.
 - 2.** Release the lever [A], open the pressure plate sheet [B], and pull out the protective sheet slowly.
 - 3.** Remove the packing tape [C].

2. Installation



- 4.** Close the pressure plate sheet.
- 5.** Close the SPDF.
- 3.** Remove the paper size decal [A] on the exposure glass.



- 4.** Remove the packing tape on the scanner shipping locks.



- 5.** Remove the two scanner shipping locks [A] by rotating them 90 degrees counterclockwise.
SC120 is displayed when the machine is turned ON with the shipping lock attached.



- Keep the scanner shipping locks after installing the machine. The scanner shipping locks must be installed before moving the machine using methods in which the machine will not always be level, such as by truck over rough ground, or by ship.
- Before moving the machine, make sure to move the scanner carriage to the correct position with SP4-806-001 and reattach the shipping locks. ([Main Machine Installation: When Moving the Machine](#)).

6. Attach the two caps [A] provided with the machine.



2. Installation

- 7.** Pull out the 1st/2nd paper trays, remove the packing tape.



- 8.** Remove the scanner support [A].



- 9.** Open the front cover, and store the scanner support in the storage location.



- The factory setting sheet is kept in the position [A].
- The factory setting sheet is stored in the storage part of the scanner support.

SP descriptions

- SP4-806-001 (Scanner carriage storage operation).

Moves the scanner carriage to the shipping lock position. Attach the scanner shipping locks and fix the scanner carriage after executing SP4-806-001.

Removing the PCDU Seals and Spacer

The procedure differs between models as follows.

Models	CMY	Bk
IM C6000/C5500/C4500	Wound automatically when turning on the power	
IM C3500/C3000	Pulled out by hand	Wound automatically when turning on the power
IM C2500/C2000	Pulled out by hand	



- An automatic initial adjustment will be done even if the seal was not removed correctly. But toner from a PCDU that still has the seal will not be able to reach the ITB, and will not be transferred to printouts and copies.
- If this happens, remove the PCDU seal and do SP2-111-004 (Forced Line Position Adj. Mode d).
- White stripes may appear in the printed images for the first 20k pages printing continuously in a low humid environment, due to the deviation of toner density adjustment. Except for that, the machine operates normally.

1. Open the front cover.

2. Pull out the seals [A].

For IM C6000/C5500/C4500, the PCDU seals are automatically wound when the power is turned on. Do not turn the power on until the procedure requires that you do so.



3. Remove the packing tapes, and remove the spacer [A].



4. Rotate the ITB contact/separation lever clockwise, and set it to the position in the following picture. The separated image transfer belt and OPC drum come into contact.

2. Installation

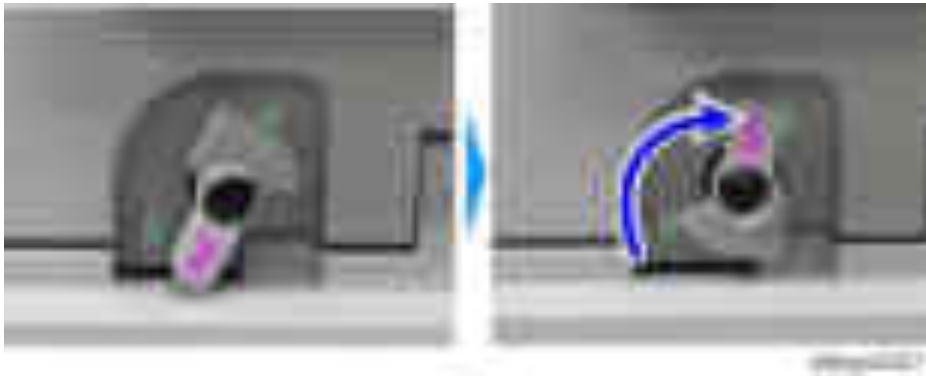

5. Close the front cover.

SP descriptions

- **SP2-111-004 (Forced Line Position Adj. Mode d)**
Executes the fine line position adjustment and rough line position adjustment.

Attaching the Accessories

Cleaning Cloth Holder

1. Clean the adhesive surface of the cleaning cloth holder with an alcohol-soaked cloth.
2. Attach the cleaning cloth holder [A] to the left side of the scanner and put the cleaning cloth into the holder.



End Fence

1. Attach the end fence [A] to the paper exit tray.
First, insert and attach the front pin (inside the blue circle).

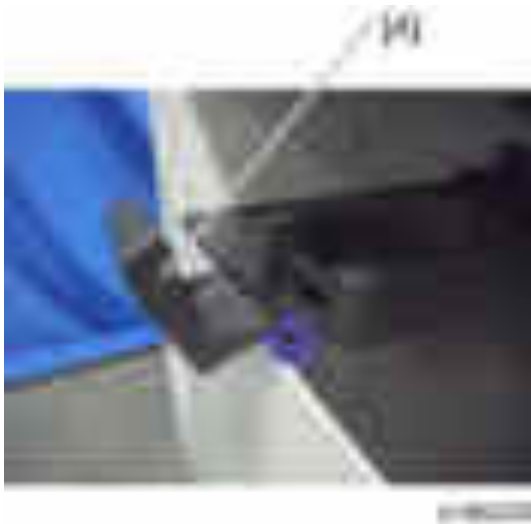

Decals

Attach the following decals provided with the machine accessories.

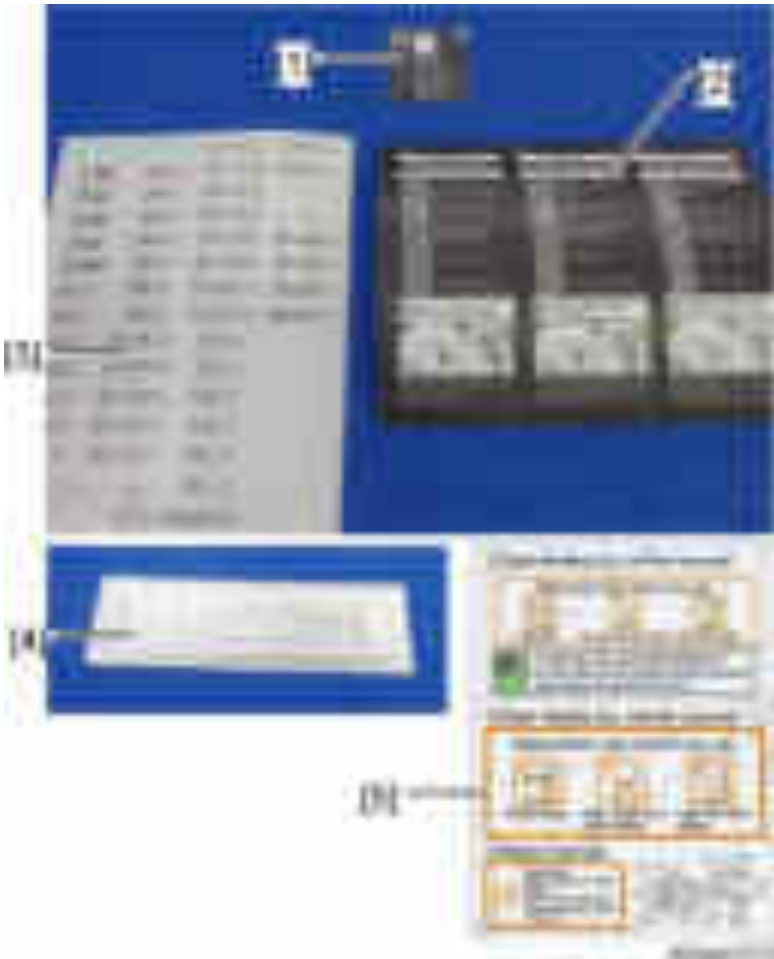

- 1: Original Set Decal
- 2: ADF Caution Decal
- 3: Paper Size Tray Number Decal
- 4: Brand Logo for Front cover

2. Installation

5: Inkjet decals

Location for each decal

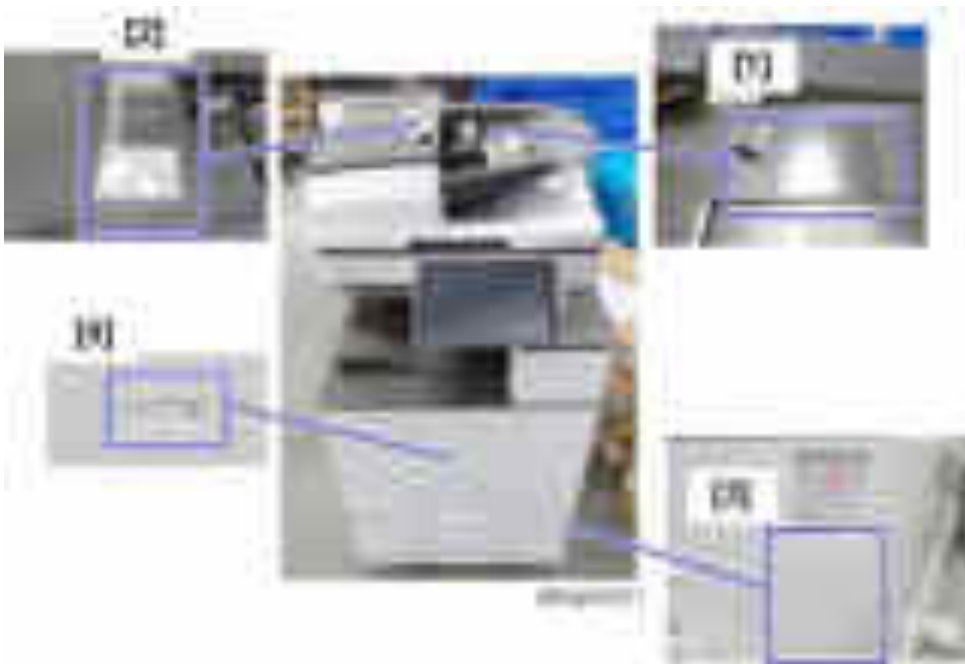

Installing the Feeler for the Paper Exit Full Sensor

- 1.** Pull the sensor feeler [A] out.



Checking the Position of the Paper Exit Feeler

Check the following points for the paper exit feeler [A] installed at the paper exit.

- It can move in line with the ejection of paper.
- It holds contact with the surface of the ejected paper and is still movable.



Paper will get jammed in the following cases.

- The paper exit feeler does not function due to obstacles (such as cables).
- The paper exit feeler does not function when the paper is pulled out and pushed back again.



Toner Bottle Installation and Toner Initialization

- 1.** Open the front cover.
- 2.** Shake the toner bottle (Bk) 7 to 8 times.

2. Installation

- 3.** Remove the toner bottle protection cap.



- 4.** Push the toner bottle into the machine slowly.



- 5.** Set the toner bottles (Y, M, and C) in the same way.

- 6.** Close the front cover.

- 7.** Connect the power cord to the machine.



- Use the power cord that is provided with the machine. Do not use any other power cord. Also, do not use an extension cord.

- 8.** Turn ON the main power.

- Toner Initialization starts. It takes about 5 minutes to fill the toner up. Wait until it finishes, or the Auto Color Calibration (ACC) will take longer.
- The Program/Change Administrator screen is displayed at the first power-up. Follow the

procedure in [Main Machine Installation: Important Notice on Security Issues](#).



- 9.** After changing the administrator/supervisor password, turn the main power OFF and back ON again.



- The machine may be ON even the display looks OFF. So before power cycling, make sure the power indicator is OFF.

- 10.** After the toner initialization is completed, the machine beeps, and the following message is displayed. Turn the main power OFF and back ON again.



Image Quality Test / Settings

- Perform the following sections after installing all peripherals.
- Confirm that there are no accessories (such as screws and clamps) left inside the main machine and peripherals.

Loading Paper

- 1.** Turn ON the main power.
- 2.** Confirm that a message to load the paper is displayed on the operation panel.
- 3.** Load the paper.

The paper size is detected automatically.

1. Pull out the paper feed tray slowly until it stops.
2. Load the paper.
3. While pressing the release lever, adjust the side fence to the paper size to be set.

2. Installation

4. Set the end fence.

Color Registration and Auto Color Calibration (ACC)

Be sure to execute color registration and auto color calibration when installing the machine.

Color Registration

- 1.** Press [Settings] on the HOME screen.
- 2.** Press [Machine Features Settings] > [Maintenance] > [Color Registration].



- 3.** Press [OK].



- 4.** After the adjustment is complete, press [Exit].

Auto Color Calibration (ACC)

Do the "Auto Color Calibration (ACC)" for the copier mode & printer mode as follows:

- Copier mode -

- 1.** Press [Settings] on the HOME screen.
- 2.** Press [Machine Features Settings] > [Maintenance] > [Auto Color Calibration]



- 3.** Press [Start] for Copier Function.
- 4.** Press [Start Printing] to print the test pattern.
- 5.** Clean the exposure glass.

- 6.** Put the test pattern on the exposure glass.

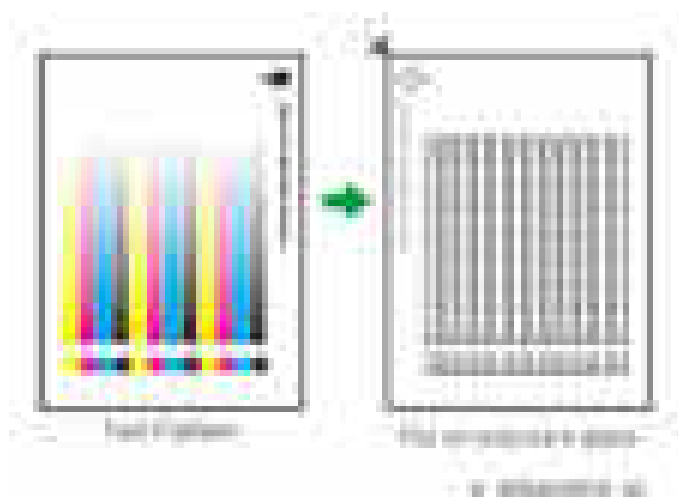

- 7.** Put 10 sheets of white paper on the test chart. This ensures the precise ACC adjustment.
8. Close the SPDF/ARDF or the platen cover.
9. Press [Start Scanning].
 The machine starts the ACC.

- Printer mode -

- 1.** Then, Press [Start] for Printer Function.
2. Press [Start Printing] to print the test pattern.
3. Press [Quick Test Pattern], then press [Start Printing] to print the test pattern.
 The test pattern is printed after self-checking.



- 4.** Put the printout on the exposure glass.

2. Installation

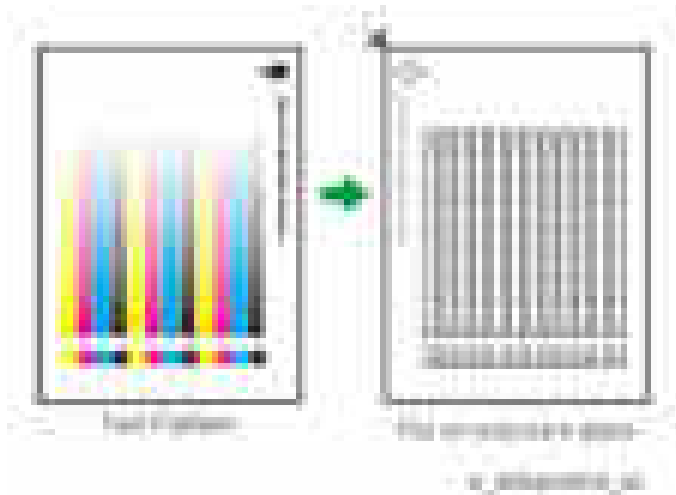

- 5.** Put 10 sheets of white paper on the test chart. This ensures the precise ACC adjustment.
- 6.** Close the SPDF/ARDF or the platen cover.
- 7.** Press [Start Scanning].
The machine starts the ACC.
- 8.** Confirm that the execution result is displayed.
For the Quick Test Pattern, the execution result is recorded with all resolutions (patterns 1 to 5).



- If the printed image is not adjusted properly after executing Quick Mode, perform ACC with normal mode (test pattern in applicable resolution) again.

Checking the Copy Image with the Test Chart

Make a copy of a test chart and check the output quality.

Paper Registration

If necessary, adjust the registration for the paper feed tray.

- SP1-002-002 (Side-to-Side Registration Paper Tray 1)
- SP1-002-003 (Side-to-Side Registration Paper Tray 2)

SP descriptions

- **SP1-002 (Side-to-Side Registration)**

Adjusts the side-to-side registration by changing the laser main scan start position for each mode and tray.

Increasing a value: The image is moved towards the rear edge of the paper.

Decreasing a value: The image is moved towards the front edge of the paper.

Auto Remote Firmware Update Settings

Specify ARFU settings as required.

Operating Conditions:

- Use the machine in an environment where it can be connected to the Internet.



- Auto remote firmware update (ARFU) requires a connection to an external network. Be sure to get permission from the customer before setting ARFU up.
- The connection is one-way, so the user's data will not be accessed from the global server.

Pre-Operation Set Up and Checks

- 1.** Check the network settings (IP address, Subnet mask, Gateway, and DNS).
- 2.** Check the proxy settings.
- 3.** In the environment to execute ARFU, check that the machine's main power is always turned on and it is always connected to the Internet.

This condition is required for downloading the firmware package in the background and also for updating the firmware by ARFU when the machine is turned ON for the first time at machine installation.

- 4.** Check the time (day of the week and time) to prohibit the execution of ARFU.



- If the access to the external server is restricted, request the network administrator (customer) to permit the following FQDN name for communication.
- **FQDN: p-rfu-ds2.support.rioh.com**

Configuration Procedure

- 1.** In "Settings" icon > Machine Features Settings > System Settings > Interface Settings, specify the IP address, Subnet, Gateway, and DNS settings according to the user's network environment.



- Make sure to specify the DNS settings. To acquire the firmware data, it is necessary to have the hostname resolved so that access to the global server is possible using the hostname.

- 2.** Check the user's network environment and, as required, specify the proxy server settings in the following SPs:
 - SP5-819-062 (Use Proxy DFU(SSP))

2. Installation

1: Use / **0: Not use**

- SP5-816-063 (Use Proxy DFU(SSP))
- SP5-816-064 (Proxy Port Number)
- SP5-816-065 (Proxy User Name)
- SP5-816-066 (Proxy Password)

They can be specified also via Web Image Monitor, from Device

Management>Configuration>Device Setting>Auto Firmware Update. (However, "Auto Firmware Update" appears on Web Image Monitor only if the ARFU function is set to "ON".)

3. Set SP5-886-111(AutoUpdateSetting) to "1(ON)"



- To download the firmware only using SFU, and not by ARFU, specify the settings as follows:
 - SP5-886-111(AutoUpdateSetting) to "0 (OFF)"
 - Set SP5-886-115 (SfuAutoDownloadSetting) to "1 (ON)"

4. When setting the prohibited day, time and so on of the auto firmware update, set them with following SPs, or Web Image Monitor.

- SP5-886-112 (AutoUpdateProhibitTermSetting)
0: OFF, 1: ON (Default)
- SP5-886-113 (AutoUpdateProhibitStartHour)
Default: 9
- SP5-886-114 (AutoUpdateProhibitEndHour)
Default: 17
- SP5-886-120 (AutoUpdateProhibitDayOfWeekSetting)
Default: 0x00

Set the bits for the days of the week to prohibit updating.

Prohibited (Monday - Sunday): Bit 7

Monday: bit 6

Tuesday: bit 5

Wednesday: bit 4

Thursday: bit 3

Friday: bit 2

Saturday: bit 1

Sunday: bit 0

e.g.) Prohibited on Mon., Fri., Sat., and Sun.: 0x47 (01000111)

5. Use the machine with its main power and connected to the Internet.

Specifying the Times and Days of the Week to Prohibit Updating via Web Image Monitor

- 1.** Start the Web Image Monitor.
- 2.** Log in as the machine administrator.

- 3.** Point to [Device Management], and then click [Configuration].



- 4.** Click "Auto Firmware Update".



- 5.** In the applicable items, specify the times and days of the week to prohibit updating.
Select the check boxes of the applicable days of the week to prohibit updating on that day

2. Installation

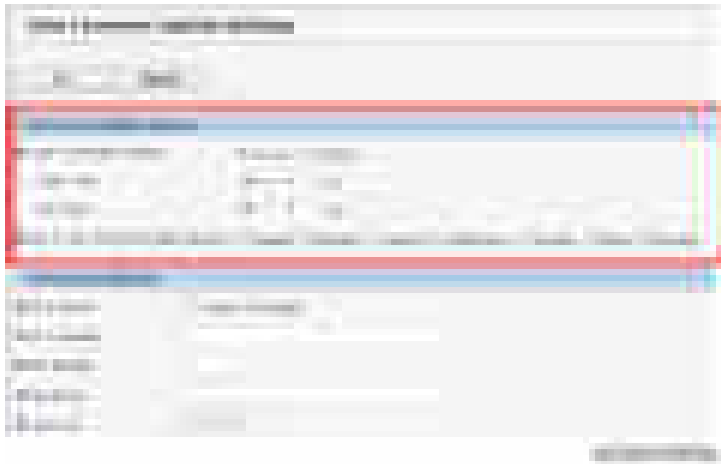

Checking the ARFU Connection

- 1.** Enter the SP mode.
- 2.** Press [Firmware update].
- 3.** Press [Update].
- 4.** Press [Execute update].



- "Execute update" appears even if @Remote connection has not been established.
- If an error code appears when you click "Execute update", the machine is in the following status.

Error code	Status
E51	The machine in operation for printing, etc.
E71	Network connection error

- 5.** Check if one of the following messages appears: "Will you download the latest package Ver *** and update?" or "The installed package is the latest version."
 - If the message appears, it is possible to execute ARFU.
->Press "No" and close SP mode to complete the configuration.
 - If the message does not appear, it is not possible to execute ARFU.
->Check the network settings again.



- SP5-886-116 (Auto Update Prohibit Term Setting) displays the scheduled date and time of the

next ARFU.

- If the scheduled date and time of the next ARFU coincides with a time and day of the week when ARFU is prohibited, the machine sends an inquiry to the server to check if there is a new firmware package at this time. If there is a new firmware package, it is downloaded in the background, but the package updating is canceled and executed on the next occasion, 76 hours later, to update the package.

Checking the ARFU Result

Checking the Result from the Firmware Update Setting

- 1.** Enter the SP mode.
- 2.** Press [Firmware update].
- 3.** Press [Update].
- 4.** Press [Update Package Information].
- 5.** If the firmware package is the same as the one on the global server, the update was completed successfully. Otherwise, check the result using the logging data.
In SP7-520-041 to -045 (Update Log: Auto:Version), you can check the versions of the packages updated by ARFU. (-041 displays the latest result. It is also printed on the SMC sheet.)

Checking the Result Using the Logging Data

- 1.** Enter the SP mode.
- 2.** Press [System/Copy].
- 3.** Check the results for ARFU by SP7-520-051 to 060 (Update Log: Auto:Result)
"-051" is the latest update result. For details about the number of each result log, see [Firmware Update \(Auto Remote Firmware Update\)](#).

Enabling the Copy Data Security Function

Enable this function in Settings when installing the machine.

- 1.** Press [Settings] icon on the HOME screen.
- 2.** Select [Machine Features Settings] > [System Settings] > [Administrator Tools] > [Detect Data Security for Copying] > "On".

Copy Data Security Function

If the Unauthorized Copy Prevention function is enabled, embedded text patterns (for instance, a warning message such as "No Copying") are displayed when documents are copied illegally.

Accordingly, unauthorized copying can be prevented.

If the Data Security for Copying function is used and settings for special patterns embedded in documents are enabled, copies of documents with embedded patterns are printed with gray overprint. Accordingly, information leakage can be prevented. To protect documents by gray overprint, the Data Security for Copying function must be enabled on the copier or multi-function printer.

2. Installation

HDD Security Function Settings

Perform the encryption and overwrite settings to protect the user information in the HDD as necessary. Follow the instructions in [Security Settings](#).

Settings Relevant to the Service Contract

Change the necessary settings for the following SP modes if the customer has made a service contract.

SP No.	Function	Default
SP5-045-001 Counter method	Specifies if the counting method used in meter charge mode is based on developments, prints, or coverage.	"1": Prints
SP5-104-001 (SSP) A3/DLT double count	Specifies whether the counter is doubled for A3/DLT size paper.	"0": Single counting
SP5-812-001 and -002 Service Tel: Telephone / Facsimile	-001: shows or sets the telephone number of the service representative. -002: shows or sets the fax number of the service station. The number is printed on the counter list when the "Meter Click Charge" is enabled. The user can send a fax message with the counter list.	

Counter Display Method

There are 3 types (Developments, Prints, and Coverage). The display mode can be set by SP5-045-001 (Accounting counter: Counter Method).

Value	Mode	Descriptions
0	Development Count	YMC Development Counter Bk Development Counter
1	Print Count (Default)	Color Copy Counter B&W Copy Counter Color Print Counter B&W Print Counter Color Total Counter B&W Total Counter
2	Coverage Count	Color Total Counter B&W Total Counter Color Coverage Counter 1 Color Coverage Counter 2 Color Coverage Counter 3
7	Coverage Count (YMC)	Color Total Counter B&W Total Counter Color Coverage Counter 1 (YMC) Color Coverage Counter 2 (YMC)

Value	Mode	Descriptions
		Color Coverage Counter 3 (YMC)

Changes for Using the @Remote Toner and Waste Toner Bottle Automatic Delivery Service

If using the @Remote Toner and Waste Toner Bottle Automatic Delivery Service, you can adjust the delivery timing of the toner and waste toner bottle.

- Ordered according to the amount of remaining toner and waste toner (Spare not kept)
- Ordered when replacing the toner bottle/waste toner bottle (Spare kept)

Upon receiving a request from the sales department or a request from the customer via the sales department to change to “toner spare kept”, change the setting using the SP.

Differences between the operation for “spare not kept” and “spare kept”

		Spare not kept	Spare kept
Overview		Spare toner and waste toner bottles not kept on customer’s premises at the time of delivery.	Spare toner bottles of all colors and waste toner bottle kept on customer’s premises at all times after product shipment.
First unit	Toner bottles	Toner bottles: 1 bottle of each color (delivered with the machine)	1 bottle of each color (delivered with the machine) Note: It is necessary to order spare toner bottles.
	Waste toner bottle	1 bottle (installed to machine)	1 bottle (installed to machine) Note: It is necessary to order spare waste toner bottle.
Call timing	Toner bottles	Set remaining amount You can change the threshold with SP5-507-081/082 (Supply/CC Alarm:Toner Call Threshold).	When replacing toner
	Waste toner bottle	Set capacity You can change the threshold with SP3-802-001 (Waste Toner Bottle Call:Automatic Ordering Thresh).	On detecting a new unit
Collection	Toner bottles	Kept by the customer for collection at the time of next delivery.	At the time of spare toner bottle delivery
	Waste toner bottle		At the time of spare waste toner bottle delivery

Delivery Flowchart (Toner Bottle)

2. Installation

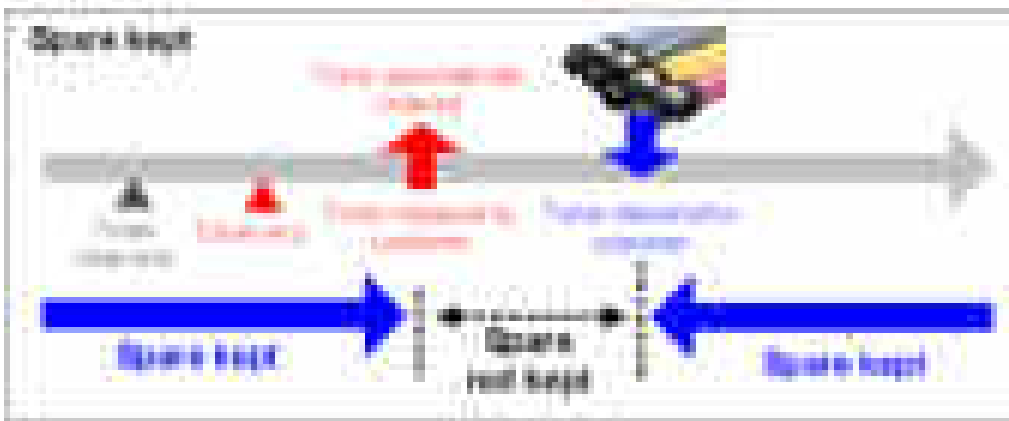
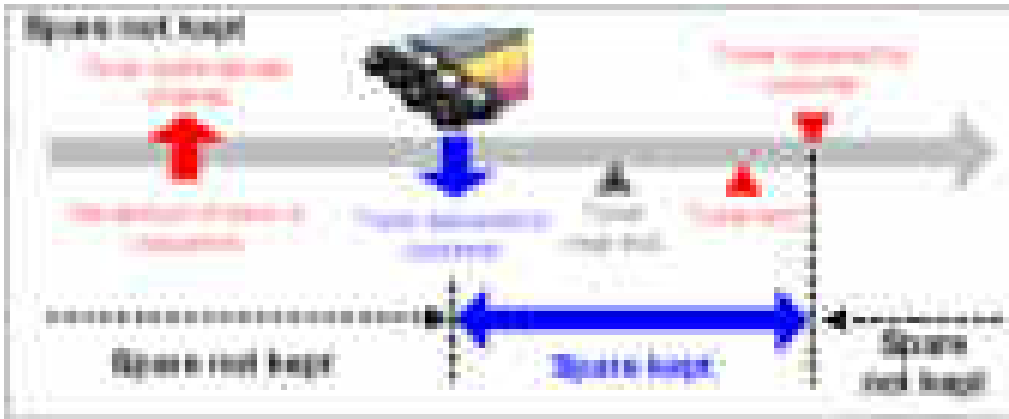

- **SP for changing the timing of toner bottle delivery**

SP5-507-080 (TonnerCallTriger)

0 *Default	When replacing toner	Spare kept
1	When remaining toner is below the set amount	Spare not kept

- **SP for changing the timing of waste toner bottle delivery**

SP5-507-070 (Supply/CC Alarm: WasteTonerBottle Call Timing)

0	On detecting a new product	Spare kept
1	PM counter 50% full You can check the PM counter in SP7-621 (PM Counter Display).	Spare not kept
2*Default	Value in SP7-956-142 (Estimated Remain Days: Waste Toner Bottle)	Spare not kept

To start Toner and Waste Toner Bottle Automatic Delivery Service, the following SPs must be enabled :

- Set SP5-507-003 (Supply/CC Alarm:Toner Supply Alarm) to "1 (enable)"
- Set SP5-507-006 (Supply/CC Alarm: WasteTonerBottle) to "1 (enable)"
- Set SP5-515-010 (SC/Alarm Setting: Supply Automatic Ordering Call) to "1 (enable)"

A customer support operator remotely connects the client's machine via @Remote and configure the required settings. It is not necessary that a service technician changes the SPs on the customer site.

Installation is now completed.

Main Machine Installation: When Moving the Machine

This section shows how to move the machine from one floor to another floor. Before turning off the main power, make sure 100% is shown as available memory on the screen if the fax option is installed.

- Turn off the main power.
- Disconnect the power plug from the outlet.
- Close all covers and paper trays, including the front cover and bypass tray.
- Move the scanner carriage to the correct position [A] with SP4-806-001, and reattach the scanner shipping locks with lock position [B].

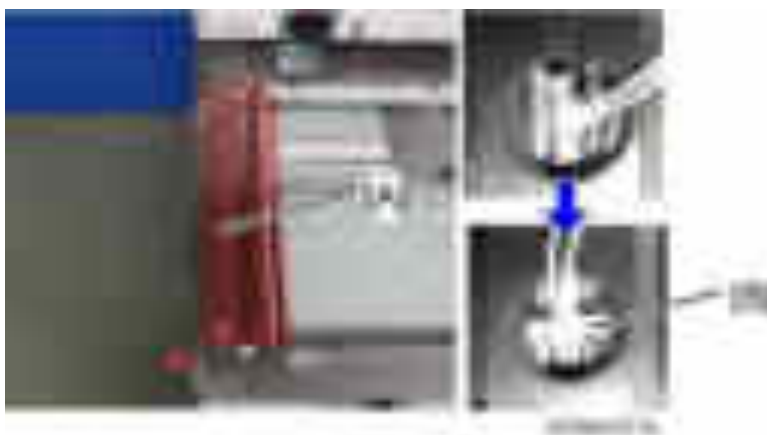

- Keep the machine level and carry it carefully, taking care not to jolt or tip it, and protect the machine from strong shocks.
- When moving the machine, do not press against the ADF.
- Remove the optional feed tray when lifting the main machine for moving it to another floor.



- Do not push the center part of the rear cover. Do not hold the covers of the stabilizers.



2. Installation

- Do not push on the rear cover [A] or the operation panel [C] of the machine.



- Hold 4 corners on the bottom base when holding the machine with the optional paper feeding tray joined to the main machine. Do not hold any other parts.



Cautions upon Lashing

- 1.** Position the machine so that its left side faces the wall. Make sure to put cushioning in between.
- 2.** Fasten the belt at the ridgeline with cushioning.
- 3.** Make sure that the belt is over the front cover (at 45 - 75cm height from the ground).

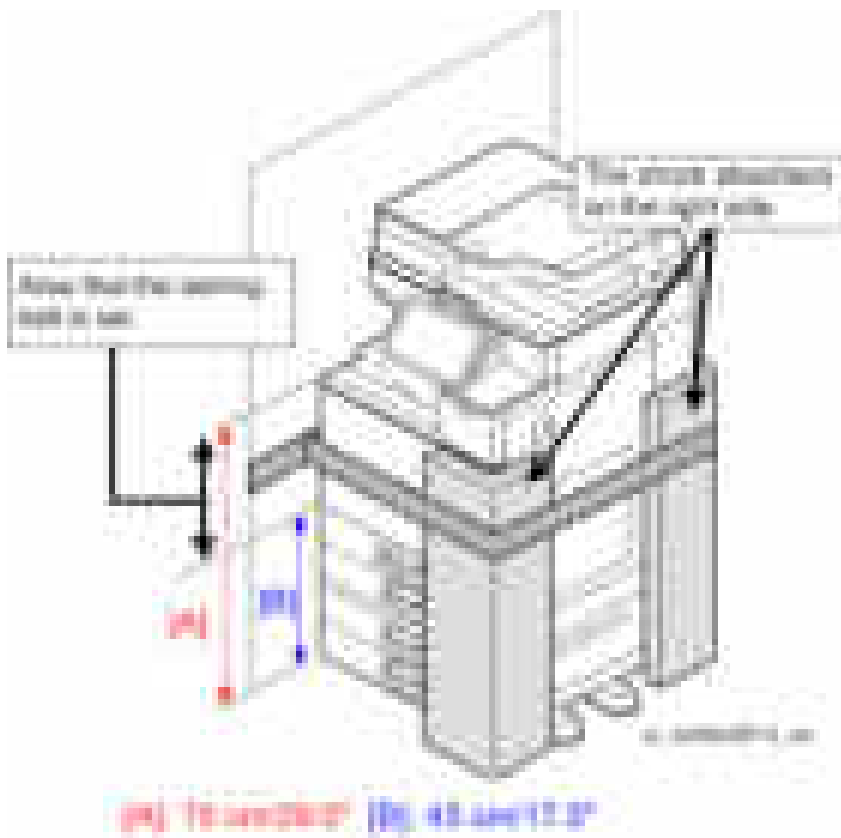

Anti-Condensation Heater (Scanner, PCDU)



- Unplug the machine power cord before starting the following procedure.
- Do the following procedure not to damage any harnesses.
- Check that harnesses are not damaged or pinched after installation.

Anti-Condensation Heater (Scanner)



- Anti-Condensation Heater (Scanner) part is optional.
- Necessary parts to install Anti-Condensation Heater (Scanner):
 - (1) Heater for scanner
 - (2) Electrical components

Accessory Check

(1) Heater (lamp) for Scanner

No.	Description	Q'ty
1	COVER: HEATER: SCANNER	2
2	HEATER: 120V: 9W HEATER: 230V: 9W	1
3	BRACKET HEATER: SCANNER	1
5	SCREW: POLISHED ROUND/SPRING: M4x8	1
6	SCREW M3x3	2

(2) Electrical components

No.	Description	Q'ty
-	TAPPING SCREW M3X6	3
4	CLAMP	6
-	HARNESS: SCANNER/PCU	1
-	PCB: DHB	1
-	HARNESS: DC: DHB	1
-	HARNESS: AC: DHB	1

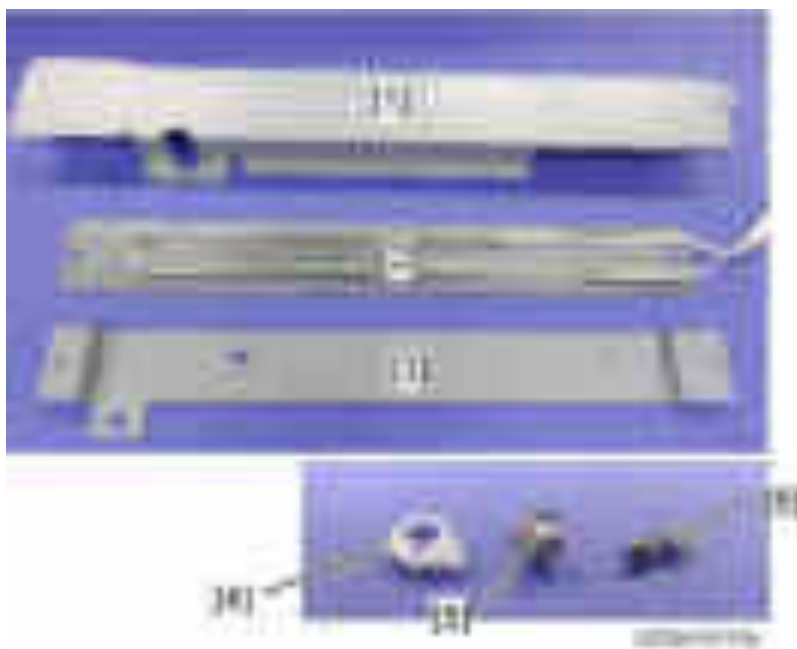

Installation procedure

- 1.** Remove the rear cover [A].

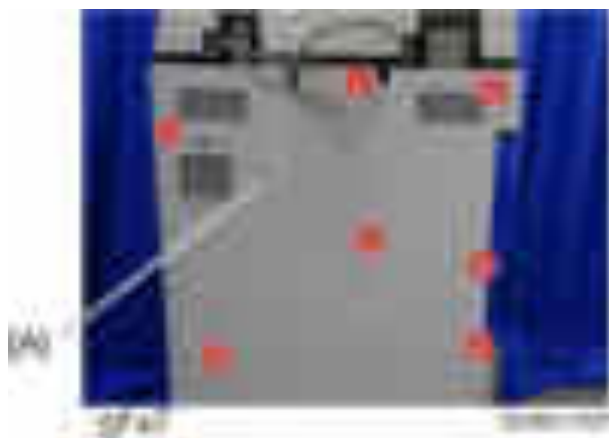

- 2.** Remove the rear lower cover [A].



2. Installation

- 3.** Remove the power supply box [A] (⊗ x6, Among them, tapping screw x1)



- 4.** Release the 5 clamps.



- 5.** Remove the HVP-CB (PCB19) with the bracket [A] (Hook x2).

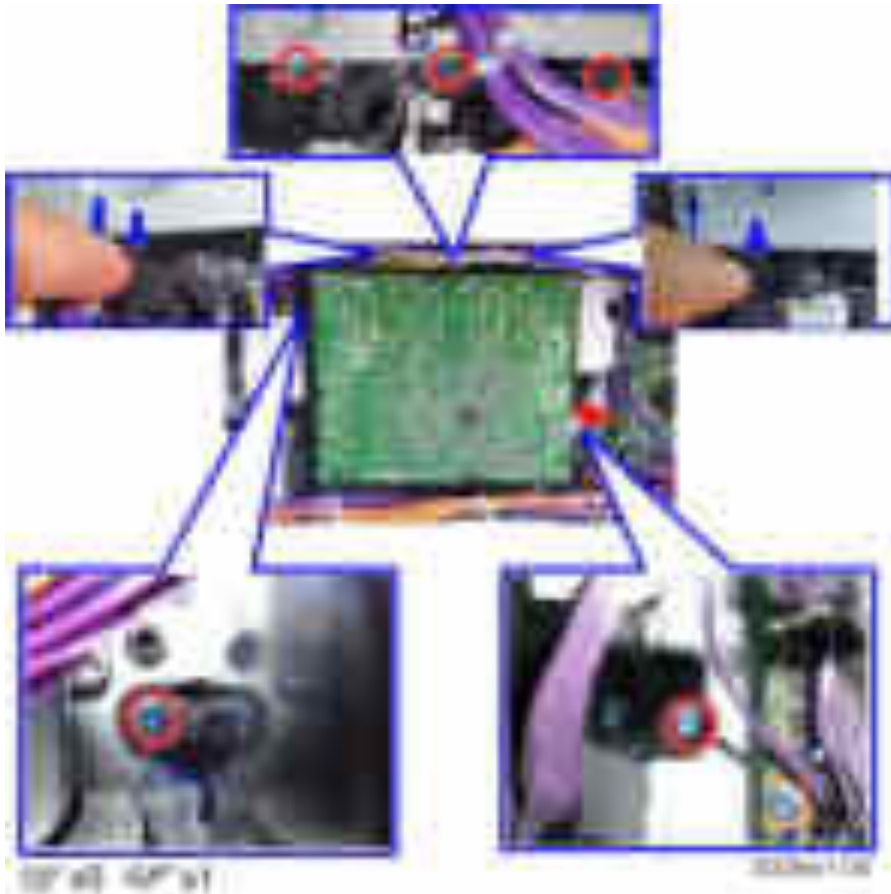

- 6.** Connect the combined Blue/White harness to the back frame [A].





2. Installation



- The harness will be connected to the relay board. See the details in step 8.

7. Reinstall the HVP-CB unit and power supply box.

8. Secure the relay board to the main machine and connect the Blue/White harness to the socket on the board ( × 1,  × 3).



9. Connect the harnesses on the relay board to the sockets on the PSU.



- Two types of harnesses are packed with the heater. Both the Blue/White one [A] and the Gray one [B] must be connected as shown below.



- 10.** Remove the right rear cover [A] (⊖ x4, among them, tapping screw x1)



- 11.** Remove a screw.



- 12.** Remove the scanner right cover [A].

Remove the hook at the upper part, and then slide the cover in the rear direction.



- 13.** Route the harness around the outside of the PSU and pull the harness out of the electrical box

2. Installation

through the hole [A] (■ x 4).



14. Route the harness in the direction of the scanner (■ x 6).



- Fasten the clamp between the bindings of the harness at the location indicated by the red circle.



- 15.** Attach the connector to the frame.
Connect it to the heater harness in step 25.



- 16.** Remove the scale [A]



- 17.** Remove the sheet-through exposure glass [A]



2. Installation

18. Remove the rear scale [A]



19. Remove the left scale and exposure glass [A]



- The exposure glass and the left scale are attached with double-sided tape.



20. Move the scanner carriage to the right.

21. Attach the heater [B] to the bracket [A] provided with the accessories (× 2).

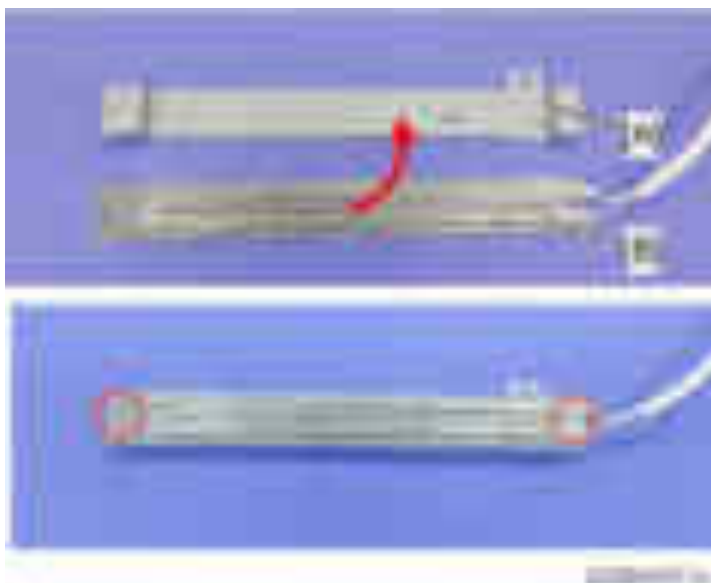

- 22.** Remove the release paper [A] on the back side of the bracket, and secure the heater [B] with the seal, aligning it with the boss on the frame.



- 23.** Pull the harness [A] out of the frame hole.
Route the harness into the harness guide.



- 24.** Attach the heater cover [A] (1 × 1).



- 25.** Connect the heater harness that was pulled out of the frame hole to the connector which was

2. Installation

mounted in step 15.



26. Reattach all the removed covers.

Anti-Condensation Heater (PCDU)



- Anti-Condensation Heater (PCUD) part is optional.
- Necessary parts to install Anti-Condensation Heater (PCDU):
 - (1) Heater for scanner
 - (2) Electrical components

Accessory Check

(1) Electrical parts

Description	Q'ty
TAPPING SCREW M3X6	3
CLAMP	6
HARNESS: SCANNER/PCU	1
PCB: DHB	1
HARNESS :DC: DHB	1
HARNESS :AC: DHB	1

(2) Heater for PCDU

Description	Q'ty
TAPPING SCREW: WASHER M3X8	1
HEATER: PHOTOCONDUCTOR: EU	1
HEATER: PHOTOCONDUCTOR: NA	1
DECAL HIGHT TEMP	1

Installation procedure

- 1.** Remove the rear cover.

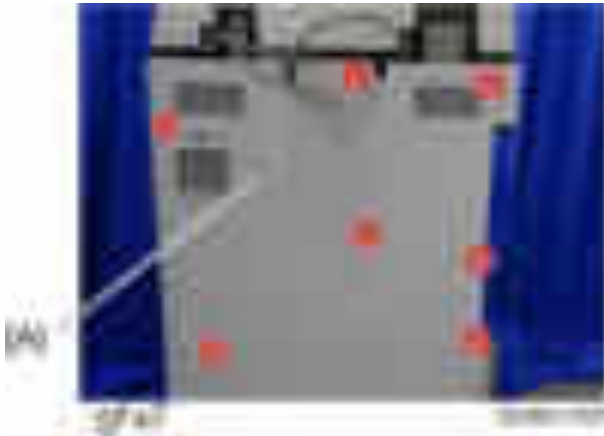

- 2.** Remove the rear lower cover.



- 3.** Remove the power supply box [A] (⌀ x6, among them, tapping screw x1).



2. Installation

4. Release the 5 clamps.



5. Remove the HVP-CB (PCB19) with bracket [A] (Hook x2).

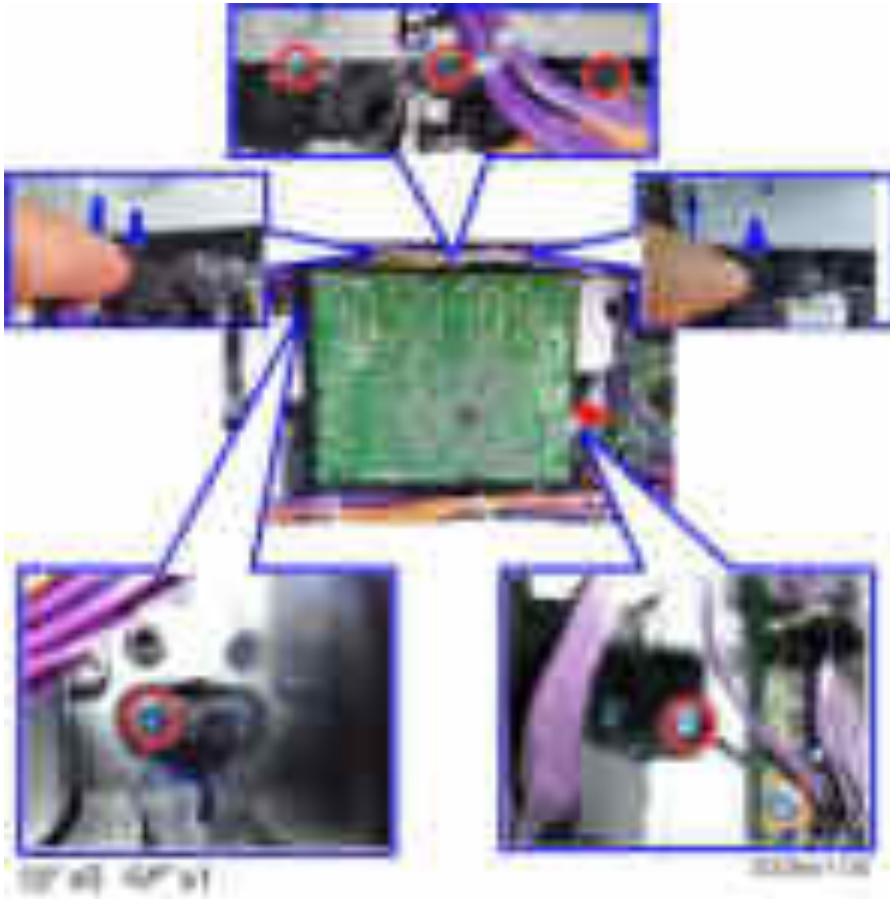



6. Connect the combined Blue/White harness to the back frame [A].



- The harness will be connected to the relay board. See the details in step 8.

7. Reinstall the HVP-CB unit and power supply box.

8. Secure the relay board to the main machine and connect the Blue/White harness to the connector on the board ($\text{M}20 \times 1$, $\text{M}20 \times 3$).



9. Connect the harnesses on the relay board to the connectors on the PSU.

- Two types of harnesses are packed with the heater. Both the Blue/White one [A] and the

2. Installation

Gray one [B] must be connected as shown below.



10. Remove the right rear cover [A] (⊙ x4, among them, tapping screw x1).



11. Remove a screw.



12. Remove the scanner right cover [A].

Remove the hook at the upper part, and then slide the cover in the rear direction.



- 13.** Route the harness around the outside of the PSU and pull the harness out of the electrical box through the hole [A] (■ x 4).



- 14.** Route the harness in the direction of the scanner (■ x 6).



- Fasten the clamp between the bindings of the harness at the location indicated by the red

2. Installation

circle.



15. Attach the connector to the frame.



16. Remove Feed Trays 1 and 2.

17. The connector cover located inside the machine [A] ( × 1).



18. Temporarily tighten a screw at the top (M3x8: x1).



19. Install the heater [A] by connecting the connector to the inside of the machine, then tighten the screw completely.



- Hold the heater against the inside during final tightening.



20. Reinstall the connector cover (x 1).

21. Attach the warning decal [A].



22. Reassemble the machine.

23. Connect the power cord, and then check that the heater is being powered and heated.

Dehumidification Heater for Paper Feed Trays

CAUTION

- Unplug the machine power cord before starting the following procedure.
- Do the following procedure not to damage any harnesses.
- Check that harnesses are not damaged or pinched after installation.

Accessory Check

Dehumidification Heater (Service Option) for Main Unit

No.	Description	Q'ty	Remarks
1	Tray heater	1	
2	Tapping screw: M3 X 8	1	
3	PCB: DHB	1	
4	Harness for tray	1	
5	Harness for DC	1	
6	Harness for AC	1	
7	Tapping screw: M3 X 6	3	

Dehumidification Heater (Service Option) for Optional PFU and LCIT

No.	Description	Q'ty	Remarks
1	Tray heater	1	
2	Harness	1	
3	Spring screw:M4 X 10	1	

Connecting to Main Machine Tray

1. Remove the rear cover [A].

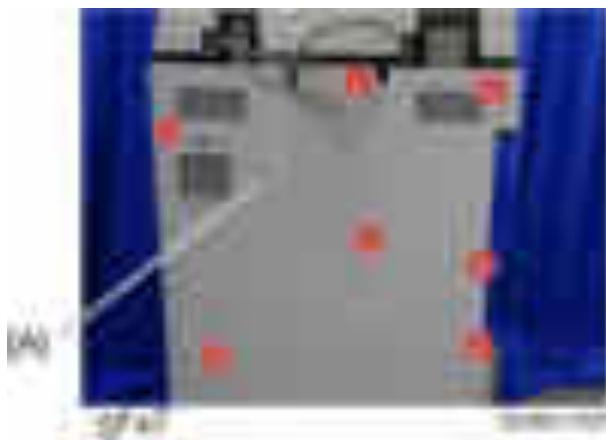

2. Remove the rear lower cover [A].



3. Attach the DHB (X 3).



4. Connect the two harnesses between DHB and PSU.



For the cable between CN920 and CN998, use a cable corresponding to the destination.

2.Installation

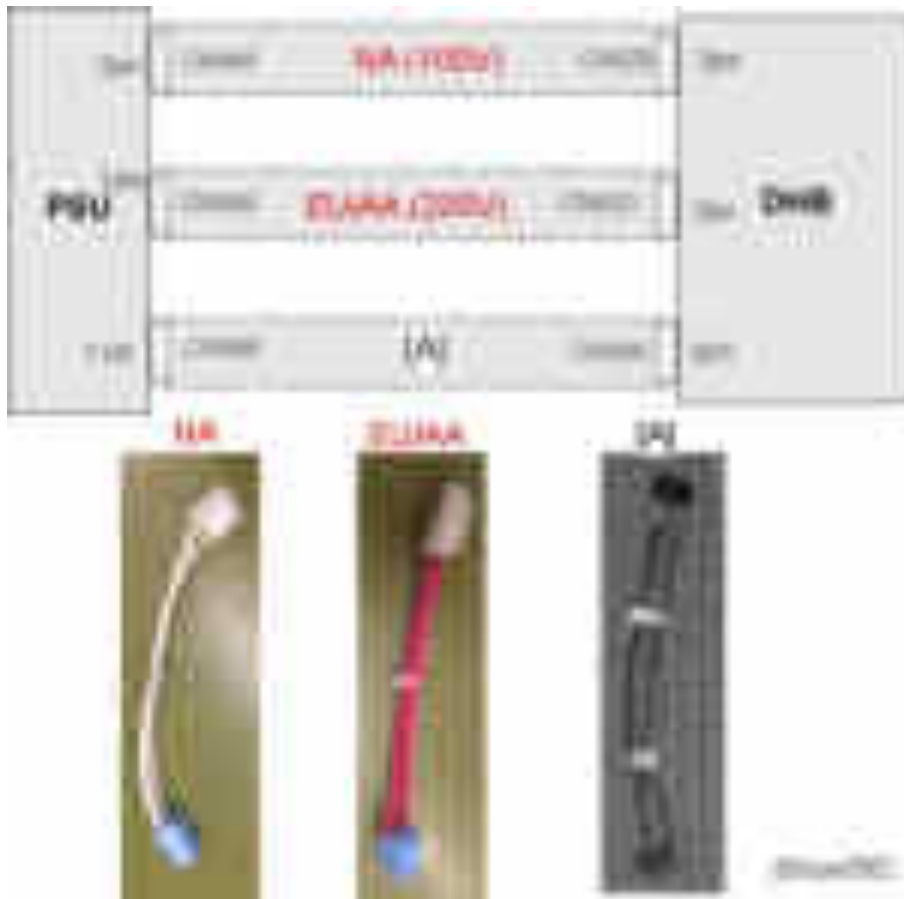

5. Attach relay harness.

- Connect the connector (1) to the DHB.
- Connect the connector (2) to the harness already attached.
- Mount the connector (3) to the bottom frame.





- The relay harness for NA/EU/AA areas is white colored.

6. Remove trays 1 and 2 from the machine.



7. Connect the connector of the heater to the main machine.



2. Installation

8. Install the heater inside the machine (x 1).



9. Reattach trays 1 and 2.

Connecting to Paper Feed Unit PB3300/PB3280

1. Perform Steps 1 to 7 of "Connecting to Main Machine Tray" ([Connecting to Main Machine Tray](#)).
2. Pull out the 1st and 2nd paper feed trays of the paper feed unit.
3. Pass the harness of the heater [A] for the optional paper feed unit through the hole in the inner rear frame of the optional paper feed unit, and then attach it (x1).



- 4.** Remove the securing brackets [A] of the optional paper feed unit.

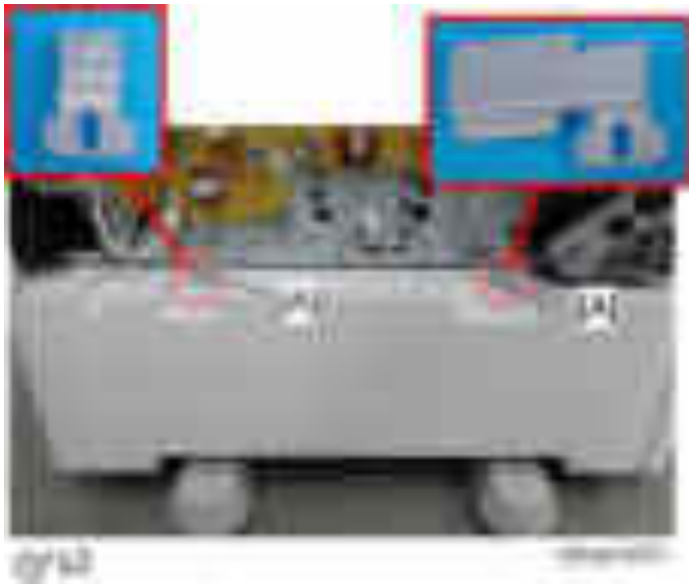

- 5.** Remove the rear cover [A] of the optional paper feed unit.



- 6.** Remove the bracket [A] on the bottom of the main machine (x1).
The removed bracket can be discarded.



- 7.** Connect the PFU harness [A] of the optional paper feed unit to the relay harness [B] of the main

2. Installation

machine and the heater harness [C] (■x4).



8. Reinstall the removed parts and covers.

9. Connect the power supply cord and turn ON the main power.

To set the anti-condensation heater to always ON, follow the steps below.

1. Set the setting of SP5-805-001 (Anti-Condensation Heater ON/OFF setting) to [1].

2. Manually disconnect the PCU and scanner heaters.



- The PCU and scanner heaters must be disabled because the temperature in the machine could become too high, causing problems with toner clogging, or damage to the scanner lamp stabilizer.

Connecting to Paper Feed Unit PB3270

1. Perform Steps 1 to 7 of "Connecting to Main Machine Tray" ([Connecting to Main Machine Tray](#)).

2. Pull out the paper feed tray of PB3150.

3. Put the harness of the heater [A] for the optional paper feed unit through the hole at the inner rear frame, and then attach it (■x1).



- 4.** Remove the securing brackets [A] of Paper Feed Unit PB3150.

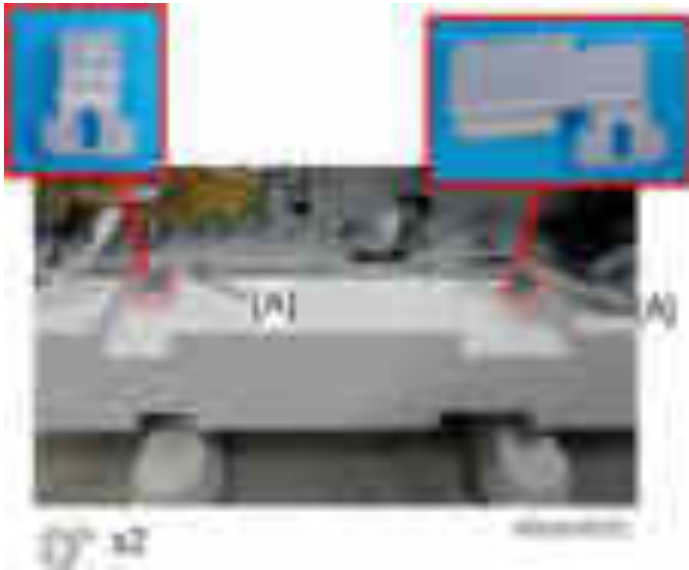

- 5.** Remove the rear cover [A] of Paper Feed Unit PB3150.



- 6.** Remove the bracket [A] on the bottom of the main machine (x1).
The removed bracket can be discarded.



2. Installation

7. Connect the PFU harness [A] to the relay harness [B] (x4).



8. Unscrew the marked screws and disconnect the connector indicated with red arrow.



9. Release the harness.

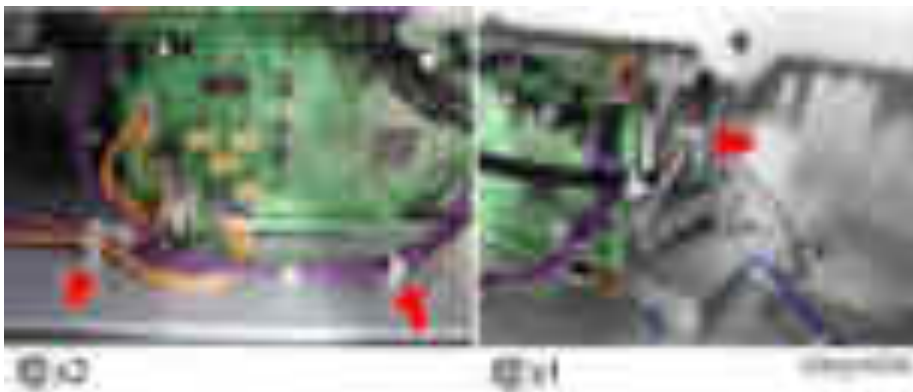

10. Tilt the controller board [A] to the front.



11. Peel the plastic sheet [A]



12. Run the heater cable through the opening behind the peeled plastic sheet and connect it



13. Reinstall the removed parts and covers.

14. Connect the power supply cord and turn ON the main power.

To set the anti-condensation heater to always ON, follow the steps below.

1. Set the setting of SP5-805-001 (Anti-Condensation Heater ON/OFF setting) to [1].

2. Manually disconnect the PCU and scanner heaters.



- The PCU and scanner heaters must be disabled because the temperature in the machine

2. Installation

could become too high, causing problems with toner clogging, or damage to the scanner lamp stabilizer.

Connecting to LCIT PB3290

- 1.** Perform Steps 1 to 7 of "Connecting to Main Machine Tray" ([Connecting to Main Machine Tray](#)).
- 2.** Pull out the paper feed tray of the optional LCT unit.
- 3.** Pass the harness of the heater [A] for the optional tray out through the hole in the inner rear frame of the optional LCT unit, and then attach it (🔌 x1).



- 4.** Remove the securing brackets [A] of the optional LCT unit.

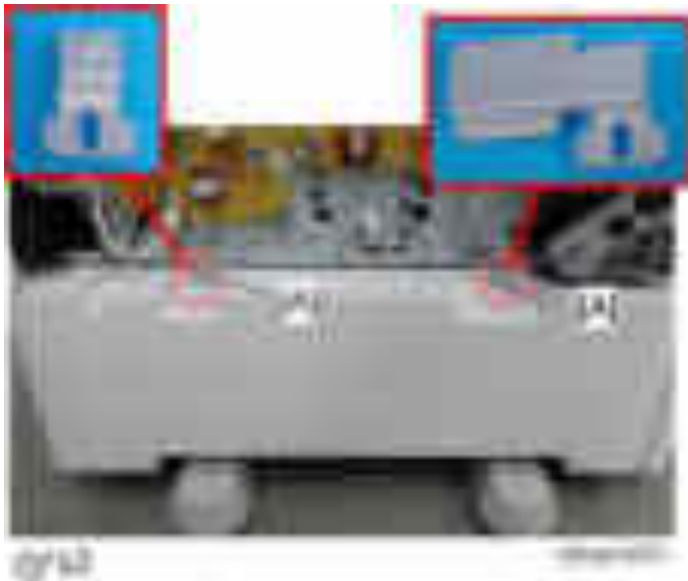

- 5.** Remove the rear cover [A] of the optional LCT unit.



- 6.** Remove the bracket [A] on the bottom of the main machine (x1).
The removed bracket can be discarded.



- 7.** Connect the PFU harness [A] of the optional LCT unit to the relay harness [B] of the main machine and the heater harness [C] (x3).



- 8.** Reinstall the removed parts and covers.
9. Connect the power supply cord and turn ON the main power.

2. Installation

To set the anti-condensation heater to always ON, follow the steps below.

- 1.** Set the setting of SP5-805-001 (Anti-Condensation Heater ON/OFF setting) to [1].
- 2.** Manually disconnect the PCU and scanner heaters.



- The PCU and scanner heaters must be disabled because the temperature in the machine could become too high, causing problems with toner clogging, or damage to the scanner lamp stabilizer.

Paper Feed Unit PB3280 / B3300 (D3FY / D3FZ)

Accessory Check

No.	Description	Q'ty	Remarks
1	Securing Bracket (Left)	1	
2	Securing Bracket (Right)	1	
3	Screw with Spring Washer (M4x10)	1	
4	Screws (M4x10)	2	



Installation Procedure

CAUTION

- The main machine weighs approximately 88 kg (194.1 lb.). Make sure to lift it with the help of at least one more person.
- The machine should be held at the correct locations and lifted gently. If it is lifted without care, handled carelessly or dropped, it may result in an injury.
- When installing this option, turn OFF the main power and unplug the power cord from the wall socket. If installing without turning OFF the main power, an electric shock or a malfunction may occur.
- Be sure to join the machine to the paper feed unit so as to prevent equipment from falling over. If they are not connected, they may move and fall over, resulting in injury.

1. Remove the packing tape and retainers, and then remove the accessories (fixing screws, etc.).



- When unpacking the paper feed unit, do not grip the stay [A]. Doing so may deform the stay, that results in a paper feeding problem.

2. Installation



- 2.** Holding the grips on the machine, align the machine with the locating pins [A], and place the machine on the paper feed unit.



- When you lift the machine, hold the correct locations.



- Do not lift the machine by holding the scanner unit, etc., because this may cause the machine to deform.
- Do not put the machine down on the paper feed unit as a temporary resting place. This may cause the paper feed unit to deform. Always connect the machine and paper feed unit properly.

- 3.** Pull out the 2nd paper feed tray.

- 4.** Using a securing bracket as a screwdriver, fix the machine to the feed unit (spring washer: screw:

M4×10).



- 5.** Attach the securing brackets to two positions on the left and right at the rear of the machine (screw: M4×10).

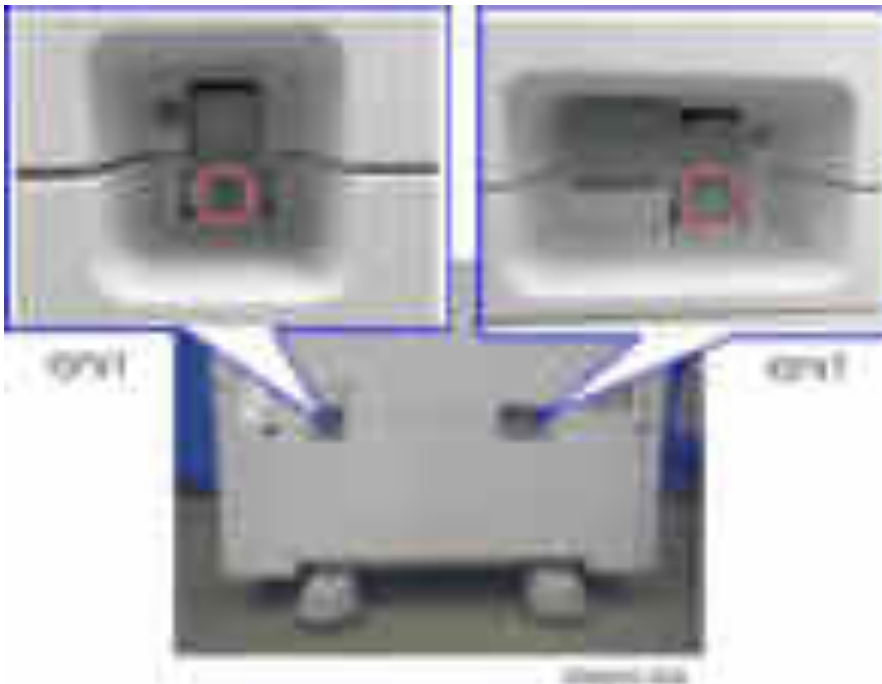

- 6.** Reattach the paper feed tray to the machine.
- 7.** Attach the paper size decal at [B].
- [A]: Tray number decal (is affixed at the factory.)
- [B]: Paper size decal

2. Installation

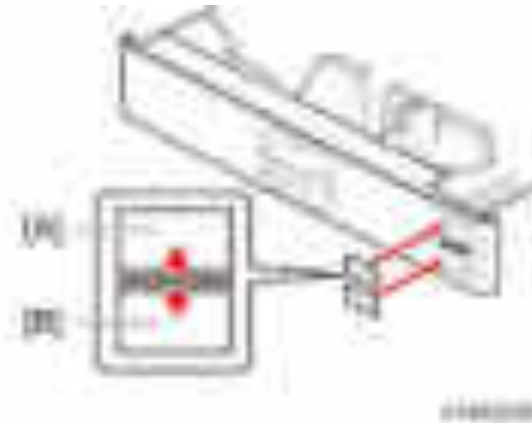

- The paper size decals are packaged together with the main machine.

8. Lock the casters of the paper feed unit.



9. Connect the power cord to the machine.



- Stabilizers are attached to the machine when it is shipped. Do not remove them.



10. Turn ON the main power.

11. Set the paper, and check that the paper size set in the paper feed tray is displayed on the operation panel.

12. Adjust the registration for the paper feed unit.

- SP1-002-004 (Side-to-Side Registration Paper Tray 3)
- SP1-002-005 (Side-to-Side Registration Paper Tray 4)

SP descriptions

- **SP1-002 (Side-to-Side Registration)**

Adjusts the side-to-side registration by changing the laser main scan start position for each mode and tray.

Increasing a value: The image is moved towards the rear edge of the paper.

Decreasing a value: The image is moved towards the front edge of the paper.

Paper Feed Unit PB3270 (D3G0)

Accessory Check

No.	Descriptions	Q'ty	Remarks
1	Securing Bracket (Left)	1	
2	Securing Bracket (Right)	1	
3	Screw with Spring Washer (M4x10)	1	
4	Screws (M4x10)	2	



Installation Procedure

CAUTION

- The main machine weighs approximately 88 kg (194.1 lb). Make sure to lift it with the help of at least one more person.
- The machine should be held at the correct locations and lifted gently by two people. If it is lifted without care, handled carelessly or dropped, it may result in injury.
- When installing this option, turn OFF the main power and unplug the power cord from the wall socket. If installing without turning OFF the main power, an electric shock or a malfunction may occur.
- Be sure to join the machine to the paper feed unit so as to prevent equipment from falling over. If they are not connected, they may move and fall over, resulting in injury.

1. Remove the packing tape and retainers, and then remove the accessories (screws, etc.).



- When unpacking the paper feed unit, do not grip the stay [A]. Doing so may deform the stay, that results in a paper feed problem.



- 2.** Holding the grips on the machine, align the machine with the locating pins [A], and place the machine on the paper feed unit.



- When you lift the machine, hold the correct locations.



- In particular, do not lift the machine by holding the scanner unit, etc., because this may cause the machine to deform.
- Do not put the machine down on the paper feed unit as a temporary resting place. This may cause the paper feed unit to deform. Always connect the machine and paper feed unit properly.

- 3.** Pull out the 2nd paper feed tray.

- 4.** Using a securing bracket as a screwdriver, fix the machine to the feed unit (spring washer: screw:

2.Installation

M4x10).



- 5.** Attach the securing brackets to two positions on the left and right at the rear of the machine (screw: M4x10).

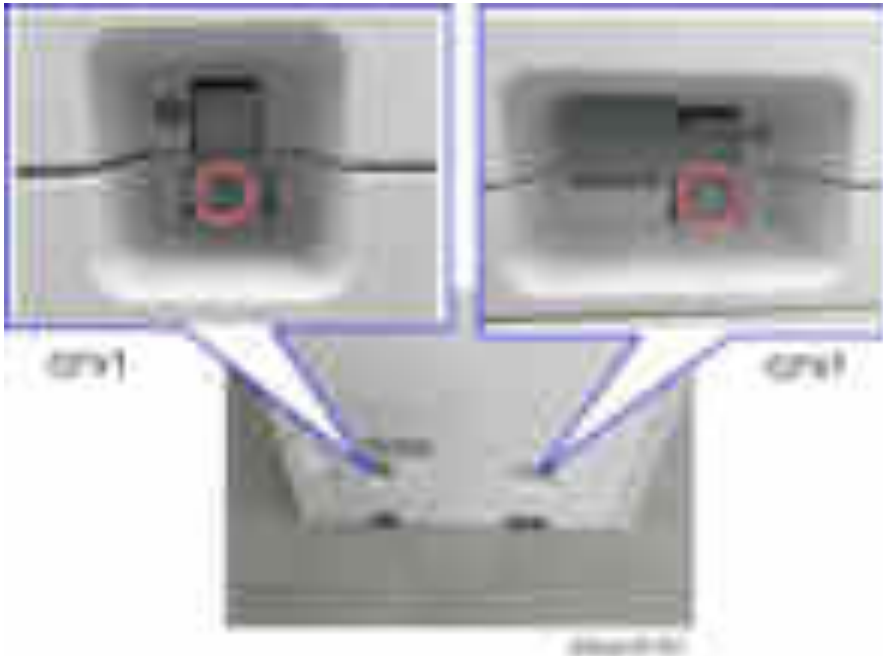

- 6.** Reattach the paper feed tray to the machine.
- 7.** Attach the paper size decal at [B].
- [A]: Tray number decal (is affixed at the factory.)
- [B]: Paper size decal

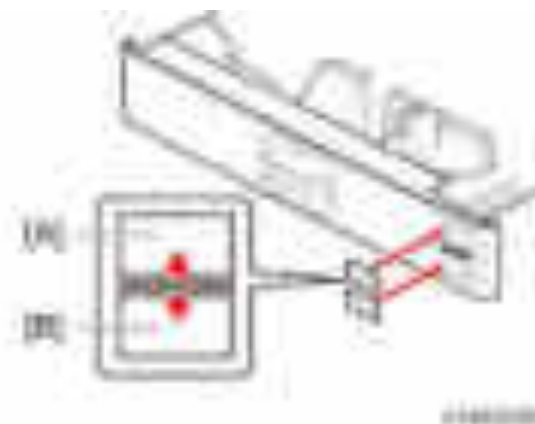

Notes

- The tray number decal and paper size decal are packaged together with the machine.

8. Connect the power cord to the machine.

9. Turn ON the main power.

10. Set the paper, and check that the paper size set in the paper feed tray is displayed on the operation panel.

11. Adjust the registration for the paper feed unit.

SP1-002-004 (Side-to-Side Registration Paper Tray 3)

Notes

- This optional paper feed unit [A] is not supplied with a caster. You can attach the optional Caster Table Type M3 [B] ([Caster Table Type M3 \(D178\)](#)).

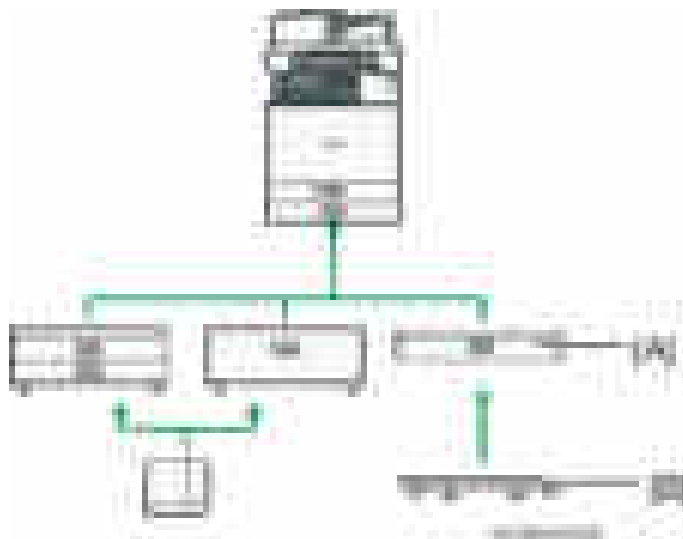

SP descriptions

- SP1-002 (Side-to-Side Registration)**

Adjusts the side-to-side registration by changing the laser main scan start position for each mode and tray.

2. Installation

Increasing a value: The image is moved towards the rear edge of the paper.

Decreasing a value: The image is moved towards the front edge of the paper.

LCIT PB3290 (D3G2)

Accessory Check

No.	Description	Q'ty	Remarks
1	Securing Bracket (Left)	1	
2	Securing Bracket (Right)	1	
3	Screw with Spring Washer (M4x10)	1	
4	Screws (M4x10)	2	



Installation Procedure

CAUTION

- The main machine weighs approximately 88 kg (194.1 lb). Make sure to lift it with the help of at least one more person.
- The machine should be held at the correct locations and lifted gently. If it is lifted without care, handled carelessly or dropped, it may result in an injury.
- When installing this option, turn OFF the main power and unplug the power cord from the wall socket. If installing without turning OFF the main power, an electric shock or a malfunction may occur.
- Be sure to join the machine to the paper feed unit so as to prevent equipment from falling over. If they are not connected, they may move and fall over, resulting in injury.

1. Remove the packing tape and retainers, and then remove the accessories (stud screws, etc.).



- When unpacking the paper feed unit, do not grip the stay [A]. Doing so may deform the stay, that results in a paper feed problem.

2. Installation



- Make sure to remove the blue tape [A] inside the tray (front side of the right drawer).



- 2.** Holding the grips on the machine, align the machine with the locating pins [A], and place the machine on the paper feed unit.





- When you lift the machine, hold the correct locations.



- In particular, do not lift the machine by holding the scanner unit, etc., because this may cause the machine to deform.
- Do not put the machine down on the paper feed unit as a temporary resting place. This may cause the paper feed unit to deform. Always connect the machine and paper feed unit properly.

3. Pull out the 2nd paper feed tray.

4. Using a securing bracket as a screwdriver, fix the machine to the feed unit (spring washer: screw: M4x10).



5. Attach the securing brackets to two positions on the left and right at the rear of the machine

2. Installation

(screws: M4x10).

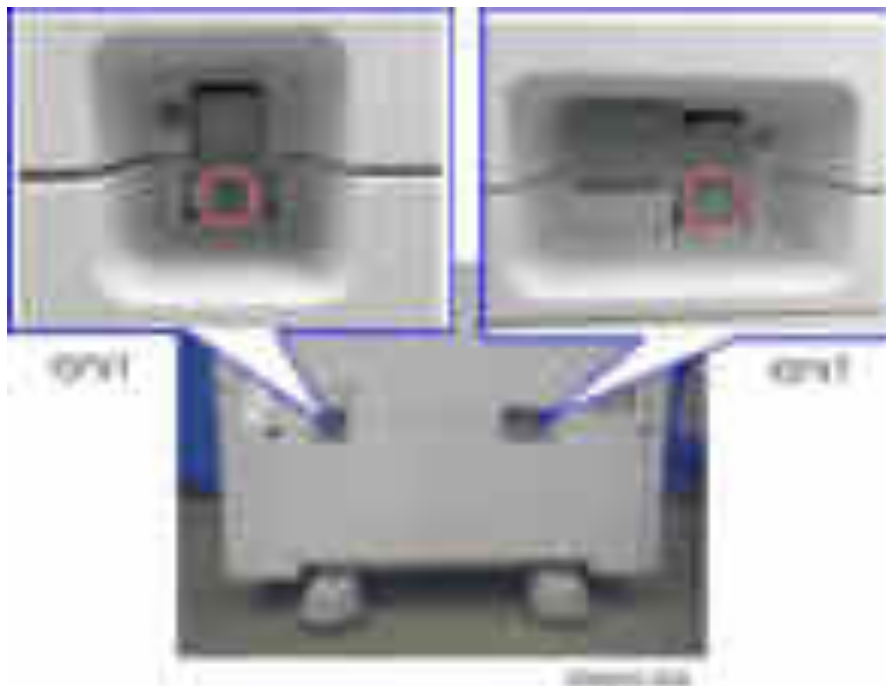

- 6.** Reattach the paper feed tray to the machine.
- 7.** Attach the paper size decal at [B].
[A]: Tray number decal (is affixed at the factory.)
[B]: Paper size decal

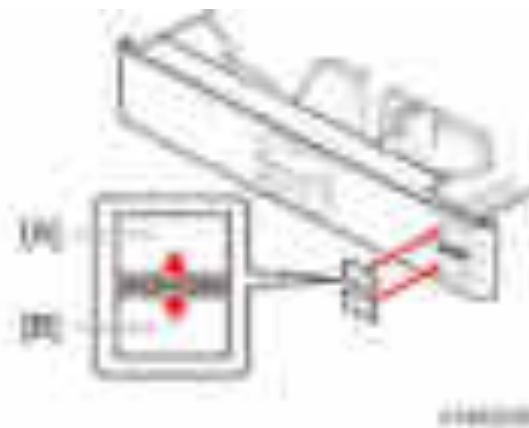

- The pare paper size decals are packaged together with the main machine.

- 8.** Lock the casters of the paper feed unit.



- 9.** Connect the power cord to the machine.



- The stabilizers are attached to the LCIT when it is shipped. Do not remove any of them.



- 10.** Turn ON the main power.

- 11.** Set the paper, and check that the paper size set in the paper feed tray is displayed on the operation panel.

- 12.** Adjust the registration for the paper feed unit.
SP1-002-004 (Side-to-Side Registration Paper Tray 3)

SP descriptions

- SP1-002 (Side-to-Side Registration)
Adjusts the side-to-side registration by changing the laser main scan start position for each mode and tray.
Increasing a value: The image is moved towards the rear edge of the paper.
Decreasing a value: The image is moved towards the front edge of the paper.

Changing the Paper Size

Paper size is set as shown below when the machine is shipped from the factory.

- NA: LT LEF
- EU.AA.CHN: A4 LEF

The paper size can be changed to A4 or LT.

2. Installation

- 1.** Pull out the left tray and right tray.
- 2.** Remove the screws on the right tray side fences (front [A], rear [B]) and right tray end fence [C] (×3).

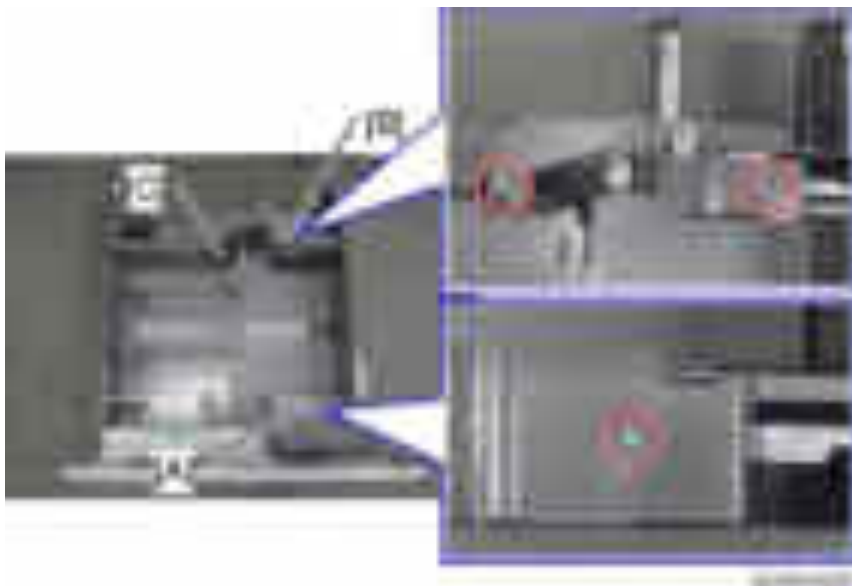

- 3.** Remove the screws on the left tray side fences (front [A], rear [B])

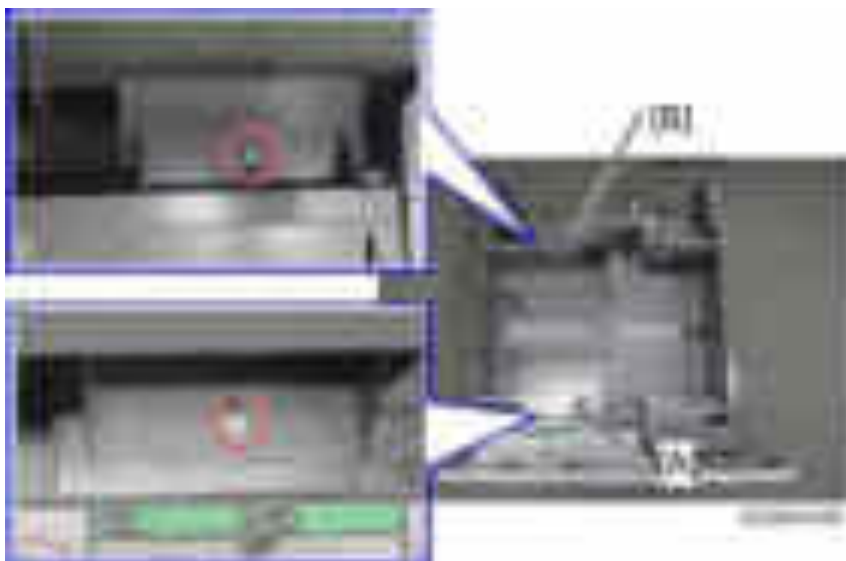

- 4.** Slide the fences to the required position (A4 or LT), and then tighten the screws.
[A]: A4 position (screw holes of the metal frame are hidden)
[B]: LT position (screw holes of the metal frame are visible)



- 5.** Make sure that the spring [A] is attached.



- 6.** Specify the following SP to set the paper size of the tandem paper tray.
SP5-181-007 (Size Adjust: TRAY 3/T-LCT: 1)
0: A4 LEF
1: LT LEF

2. Installation

LCIT RT3040 (D3G1)



- To install this optional unit, Paper Feed Unit PB3300 / PB3280 or LCIT PB3290 is required.

Accessory Check

No.	Description	Q'ty	Remarks
1	Connector Cover	1	
2	Front Bracket	1	
3	Rear Bracket	1	
4	Harness	1	
5	Stud screw	4	
6	Joint Pins	2	
7	Tapping Screw – M3 × 6	1	
8	Screw – M3 × 6	1	



Installation Procedure

CAUTION

- When installing this option, turn OFF the main power and unplug the power cord from the wall socket. If installing without turning OFF the main power, an electric shock or a malfunction may occur.



- Before installing this option [A], first, you must install the "Paper Feed Unit PB3280 / Paper

Feed Unit PB3300 [C] " or "LCIT PB3290 [B]".

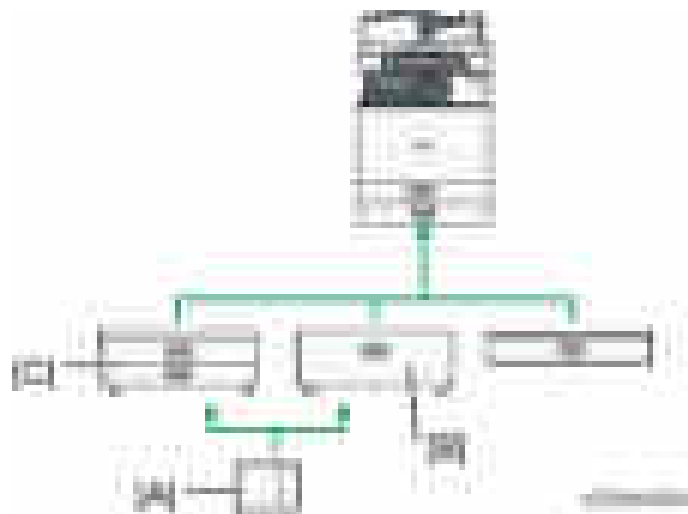

- 1.** Remove the packing tape and retainers, and then remove the accessories (stud screws, etc.).
- 2.** Remove the eight covers on the right of the paper feed table.

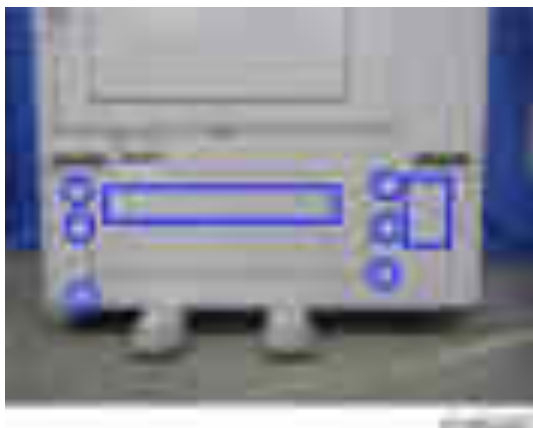

- 3.** Attach the joint pins [A] to the front and rear on the right of the paper feed table.



2. Installation

4. Attach the front bracket [A], rear bracket [B] at the positions of the joint pins (■×4).



5. Remove the paper feed table rear cover [A] (■×2).



6. Connect the harness [A].
For a machine with LCIT PB3290

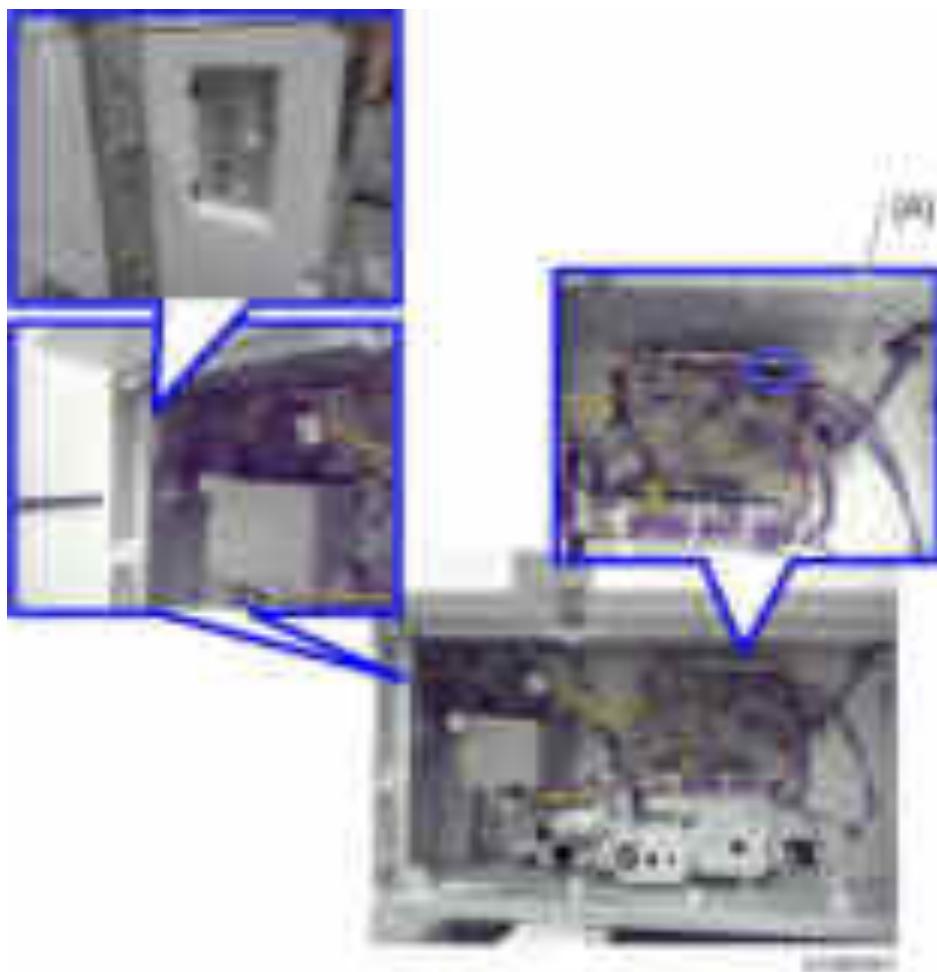

For a machine with Paper Feed Unit PB3280 / Paper Feed Unit PB3300



7. Clamp the harness.

For a machine with LCIT PB3290

2. Installation



For a machine with Paper Feed Unit PB3280 / Paper Feed Unit PB3300



- 8.** Attach the paper feed table rear cover.
- 9.** Attach the hook of the side LCT to the bracket.



- 10.** Connect the cable [A] of the side LCT to the machine (1×1).



- 11.** Attach the connector cover [A] (1×1).



- 12.** Push the side LCT towards the machine.



- 13.** Turn On the main power.
14. Set the paper, and check that the paper size set in the paper feed tray is displayed on the control unit.
15. Do the registration adjustment for the large capacity tray.
SP1-002-007 (Side-to-Side Registration Large Capacity Tray)

SP descriptions

2. Installation

SP1-002 (Side-to-Side Registration)

Adjusts the side-to-side registration by changing the laser main scan start position for each mode and tray.

Increasing a value: The image is moved towards the rear edge of the paper.

Decreasing a value: The image is moved towards the front edge of the paper.

Changing the Paper Size

Paper size is set as shown below when the machine is shipped from the factory.

NA: LT LEF

EU.AA.CHN: A4 LEF

The paper size can be changed to A4, LT, or B5.

- 1.** Open the tray cover.
- 2.** Remove the upper screw at the front side fence, and after setting the side fence to the position of the paper (outer: A4 LEF, center: LT LEF, inner: B5 LEF), tighten the screw that was removed.



- 3.** Also, change the rear side fence to the same size position.



- 4.** Change the paper size according to the new side fence position.

SP5-181-017 (Size Adjust: LCT)

- 0: A4 LEF
- 1: LT LEF
- 2: B5 LEF

Dehumidification Heater for LCIT RT3040 (Service Option)

Accessory Check

Dehumidification Heater for RT3040

No.	Description	Q'ty	Remarks
1	Relay harness bracket	1	
2	Cover	1	
3	Heater (120V for NA) Heater (230V for EU)	1	
4	Large Clamp	1	
5	Small Clamp	1	
-	Screw (M3x6) with spring washer	1	



Parts for the LCIT PB3290, or Paper Feed Unit PB3300

No.	Description	Q'ty	Remarks
1	Large Clamp	1	
2	Small Clamp	1	
3	Entrance bracket	1	
4	Distribution harness	1	
5	Screw (M4x10) with spring washer	1	
-	Screw (M3x6)	3	

2. Installation

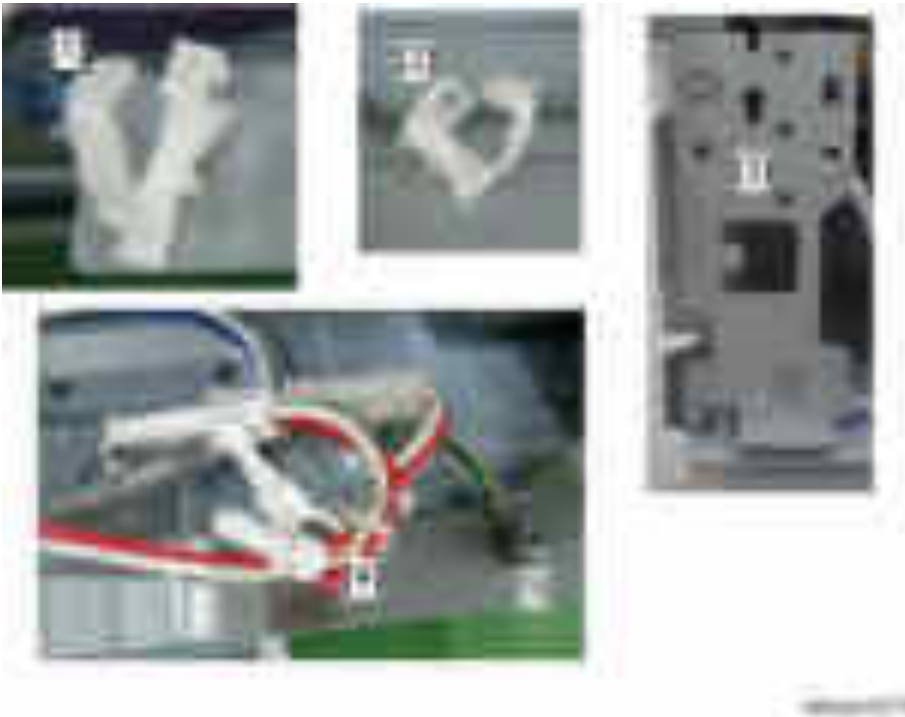

Installation Procedure

CAUTION

- When installing this option, turn OFF the main power and unplug the power cord from the wall socket. If installing without turning OFF the main power, an electric shock or a malfunction may occur.

Installing the Heater to LCIT RT3040

- 1.** Remove the rear cover [A](×3).



2. Remove the metal plate [A].

The removed screw is used to fix the entrance bracket in step 4 of the next section "[Connecting the LCIT PB3290](#)" or "[Connecting the Paper Feed Unit PB3300](#)" [Installing the Heater to LCIT RT3040](#)



3. Remove the metal plate [B].

The removed screw is used in step 5.

2. Installation



- 4.** Attach the supplied large clamp on the LCIT frame, and clamp the harness as shown below.



- 5.** Install the relay harness bracket [A], and then fix the ground wire.
Use the M3x6 screws [B] removed in step 3, and the supplied M3x6 screw with spring washer [C].



Confirm that the bracket of the relay harness does not entrap the harness that already routed.

- 6.** Attach the heater inside the red line as shown below.
Lines are engraved on the metal frame.



- 7.** Remove the three screws (M3×6).
The removed screw is used in step 10.



- 8.** Attach the supplied small clamp.
9. Route the heater harness as shown below, and connect the relay harness.

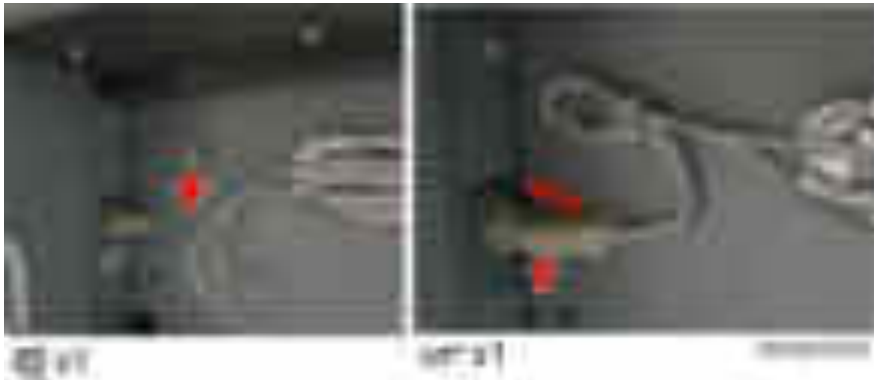

- 10.** Insert the cover to the cutout of the frame, and fasten it with the screws that you removed in step 7.

2. Installation



11. Reattach the rear cover.

Before reattaching the rear cover, be sure to pass the replay harness [A] and the I/F cable [B] through the hole on the rear cover.



Connecting the LCIT PB3290

Connection schematic diagram



Orange: Replay harness

Yellow: Distribution harness

Green: Ground wire

1. Remove the rear cover of tandem PFU.

2. Attach the supplied clamps.

Left: large clamp, Right: small camp



3. Remove the cable cover [A].



4. Install the supplied entrance bracket [A].

Use the supplied M3x6 screw, and the screw removed in Step 2 of the previous section "[Installing the Heater to LCIT RT3040](#)".



2. Installation

- 5.** Fix the replay harness [A] to the entrance bracket with supplied screws (M3x6).



- 6.** Route the replay harness [A] and then clamp the unshielded part of the connector base [B].
- 7.** Fix the ground wire.

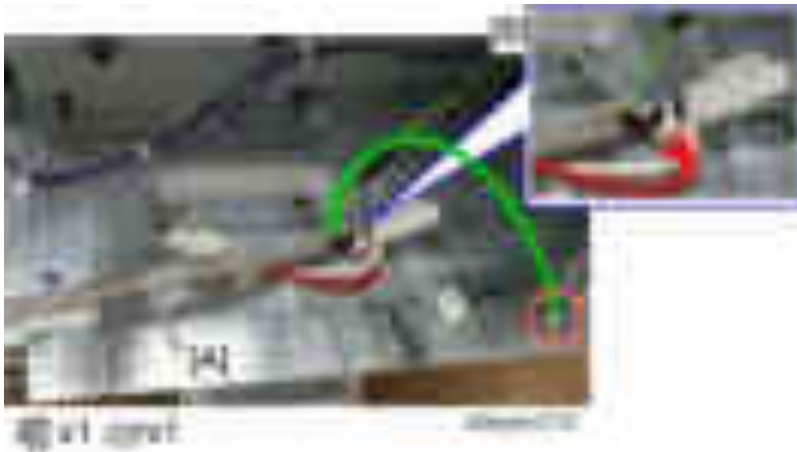

- 8.** Connect the distribution harness to:

1. Replay harness (to orange)
2. Tandem PFU heater harness (to purple)

Clamp the distribution harness at the position between the bind parts [A].



9. Connect the long harness to the relay connector on the main machine.



10. Reattach the rear cover.

Connecting the Paper Feed Unit PB3300

Connection schematic diagram

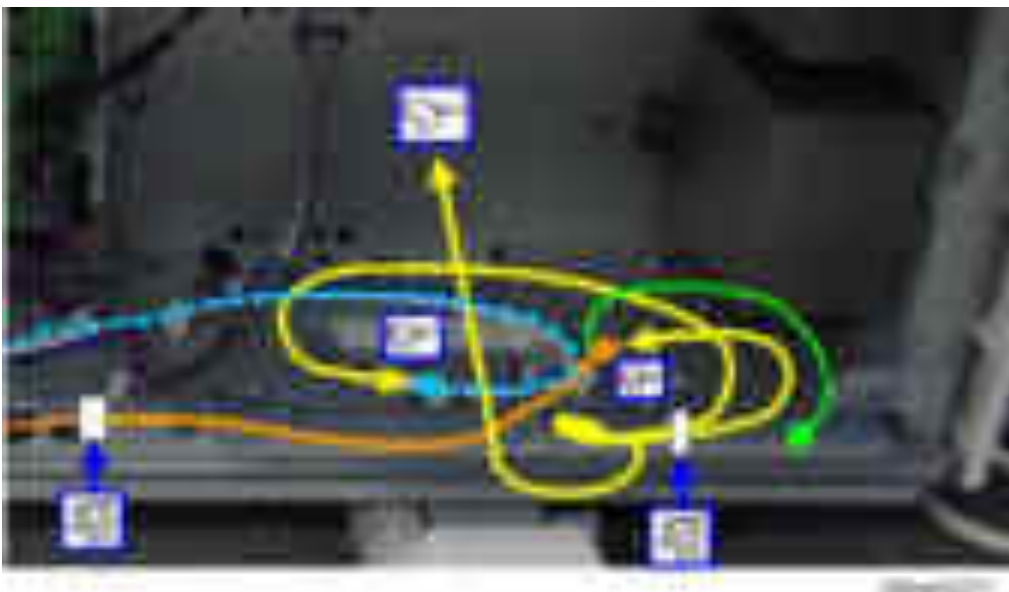

2. Installation

Orange: Relay harness

Yellow: Distribution harness

Green: Ground wire

1. Remove the rear cover of 2tray PFU.

2. Attach the supplied clamps.

Left: large clamp, Right: small camp



3. Remove the cable cover [A].



4. Install the supplied entrance bracket [A].

Use the supplied M3x6 screw, and the screw removed in Step 2 of the previous section "[Installing the Heater to LCIT RT3040](#)".



- 5.** Fix the relay harness [A] to the entrance bracket.



- 6.** Route the relay harness [A] and then clamp the unshielded part of the connector base [B].

- 7.** Fix the ground wire.

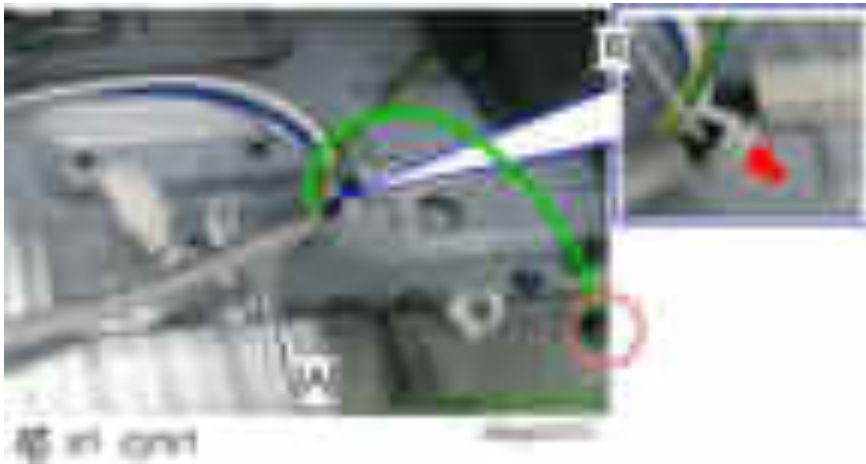

- 8.** Connect the distribution harness to:

1. Relay harness (to orange)
2. 2 tray PFU heater harness (to blue)

Clamp the distribution harness at the position between the bind parts [A].

2.Installation



- 9.** Connect the long harness to the relay connector on the main machine.



- 10.** Reattach the rear cover.

Caster Table Type M3 (D178)

Accessory Check

No.	Description	Q'ty	Remarks
1	Right Lower Cover	1	Use this part only when the Paper Feed Unit PB3270 is not installed.
2	Securing Bracket	2	
3	Screws (M4 × 10)	2	
4	Screw with Spring Washer (M4 × 10)	1	



Installation Procedure

CAUTION

- The main machine weighs approximately 88 kg (194.1 lb.). Make sure to lift it with the help of at least one more person.
- The machine must be held at the correct locations and must be lifted slowly. If it is lifted with force, handled carelessly or dropped, it will result in an injury.
- When installing this option, turn OFF the main power and unplug the power cord from the wall socket. If installing without turning OFF the main power, an electric shock or a malfunction may occur.
- Be sure to join the machine and caster table to prevent equipment from falling over. If it is not joined, the machine will move or fall over, which will result in an injury.

2. Installation

How to Place the Main Machine on the Caster Table

- 1.** Hold the grips on the machine, align it with the pins, and place the machine on the caster table.



- When you lift the machine, hold the lifting handles.



- In particular, do not lift it by holding the scanner unit, etc., (as it may deform).
- Do not put the machine down on the caster table as a temporary resting place. This may cause the machine to deform. Always connect the machine and caster unit properly.

- 2.** Pull out the 2nd paper feed tray.

- 3.** Using a securing bracket, fix the machine to the paper tray unit (spring washer: screw: M4×10).

- 4.** Attach the securing brackets at 2 positions to left and right at the rear of the machine (screws: 1 each).

- 5.** Reattach the 2nd paper feed tray to the machine.

- 6.** Attach the supplied right lower cover to the right side of the machine.

How to Place the Paper Feed Unit PB3270 on the Caster Table

1. Place the paper feed unit [B] on the caster table [A].



2. Pull out the 1st paper feed tray.
3. Using a securing bracket, fix the caster table to the paper tray unit (spring washer: screw: M4×10).



4. Attach the securing brackets [A] at 2 positions to left and right at the rear of the machine (screws: 1 each).



5. Reattach the paper feed tray.
6. Holding the grips on the machine, align the machine with the locating pins, and place the machine on the paper tray unit.

To finish the installation, follow the installation procedure of [Paper Feed Unit PB3270 \(D3G0\)](#).

Platen Cover PN2000 (D700)

Accessory Check

No.	Descriptions	Q'ty	Remarks
1	Platen Cover	1	
2	Platen Sheet	1	
3	Feeler Guide	1	
4	Stepped Screw	2	



Installation Procedure

CAUTION

- When installing this option, turn OFF the main power and unplug the power cord from the wall socket. If installing without turning OFF the main power, an electric shock or a malfunction may occur.

- 1.** Install the stepped screws ( × 2).



- 2.** Install the feeler guide [A].



- 3.** Install the platen cover [A].



- 4.** Place the platen sheet [A] on the exposure glass.

- 5.** Line up the rear left corner of the platen sheet flush against corner [B] on the exposure glass.



2. Installation

- 6.** Close the platen cover.
- 7.** Open the platen cover.
- 8.** Press the surface of the platen sheet gently to fix it on the platen cover securely.

ARDF DF3110 (D3FE)

Accessory Check

No.	Description	Q'ty	Remarks
1	Screw (M3x6)	2	
2	Short Stud Screw	1	
3	Long Stud Screw	1	
4	Knob Screw	2	
5	Attention Decal – Top Cover	1	
6	Cleaning Decal	1	



Installation Procedure

CAUTION

- Turn OFF the main power and unplug the power cord from the wall socket. If installing without turning OFF the main power, an electric shock or a malfunction may occur.

- 1.** Place the unit on the machine temporarily, and then remove the packing tape, shipping retainers, and accessories in the package (boards, fixing screws, etc.).

2. Installation

2. Attach the two stud screws ([A] is the long stud screw, [B] is the short stud screw).

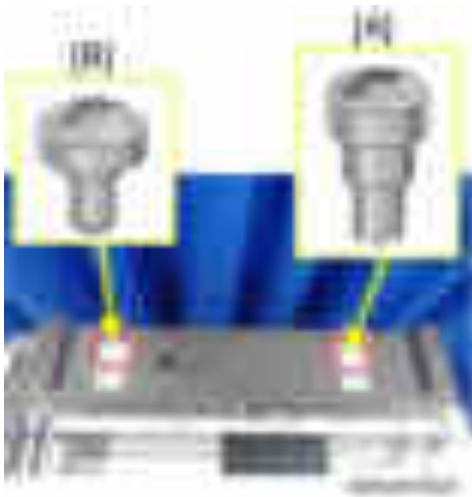

3. Temporarily place the ARDF on the machine by aligning the screw keyholes [A] of the ARDF support plate over the stud screws.
4. Slide the ARDF toward the front of the machine, and hook the stud screws to the hinge.
5. Secure the ARDF with the two knob screws [B].



To fix the right hinge, make sure to use the left screw hole. The screw hole [C] is for skew correction, so if you attach the screw to screw hole [C], it may cause a skew.

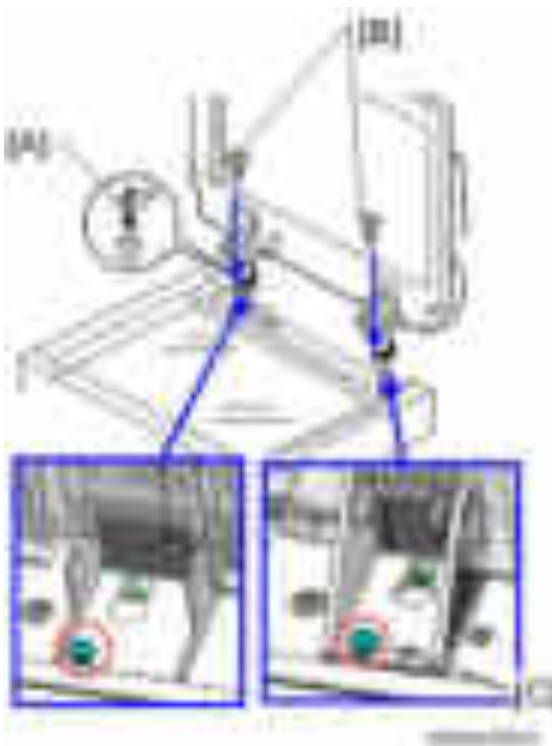

6. Align the rear left corner of the platen sheet [A] with the corner [B] on the exposure glass.
7. Close the ARDF.

- 8.** Open the ARDF and check that the platen sheet is correctly attached.



- 9.** Remove the rear cover [A] (x7).



- 10.** Remove the small disposable cover [A] on the rear cover (on the right side).



- 11.** Connect the ARDF cable as shown and mount the bracket [A] on the machine's rear frame. Make sure to connect the grounding wire.

2. Installation



12. Connect the scanner cable to the connector at the machine's rear.



13. Reattach the rear cover.

14. Lift the ARDF original tray.

15. Slide the stamp holder [A] out and install the stamp cartridge in it, if necessary.

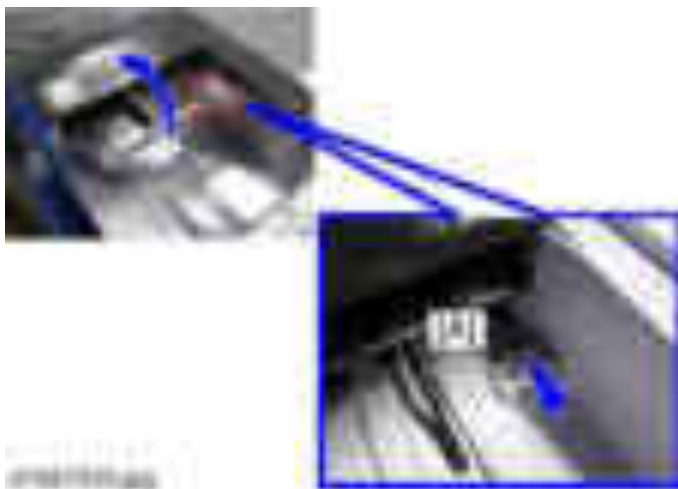

- After the stamp installation, be sure to slide the holder in, correctly. Make sure to slide it in

thoroughly until the reference marks on the holder and exterior cover are aligned.



16. Attach the attention decal to the top cover as shown.

- Choose the language that you want (English, French, or Spanish).
- The decal should be affixed inside the rib [A]. Make sure that the decal does not ride up the rib [A].



17. Attach the decal [A] on the front cover of the scanner unit.



18. Plug in and turn ON the main power.

2. Installation

19. Set SP4-688-001 (DF Density Adjustment ARDF) to "104".

20. Check the ARDF operation, and make a full-size copy.

21. Check that the registrations (side-to-side and leading edge) and image skew are correct. If they are not, adjust the registrations and image skew (see [ADF Image Adjustment](#)).

When Feeding Thin Paper

When feeding thin paper, adjust the sliding tray to the point shown below [A].

When feeding normal paper, adjust the sliding tray to the point shown below [B].

If not, it may cause problems as follows:

- Original jam
- Original curl
- Originals cannot be stacked neatly

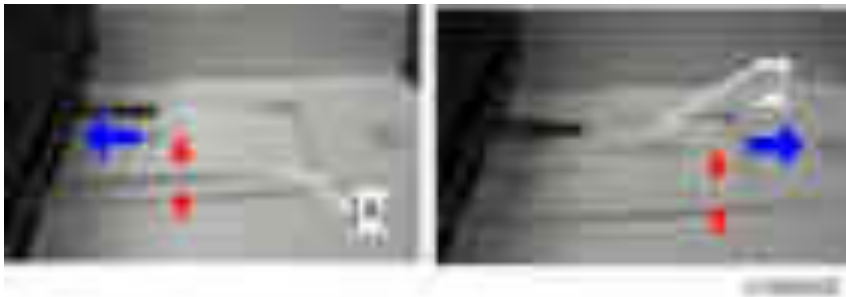

SPDF DF3120 (D3FF-17, -21)

Accessory Check

No.	Description	Q'ty	Remarks
1	Attention Decal – Top Cover	1	
2	Cleaning Decal	1	
3	Knob Screw	2	
4	Stud Screw	2	
5	Screw (3x6)	4	
-	EMC Sheet	1	



Installation Procedure

CAUTION

- Turn OFF the main power and unplug the power cord from the wall socket. If installing without turning OFF the main power, an electric shock or a malfunction may occur.

IMPORTANT

- Do not turn the power on until you perform "Adjustment after Installation," or it may not start normally.

Attaching the SPDF

1. When unpacking, hold both sides of the SPDF and take it out of the box.



2. Installation

- 2.** Place the unit on the machine temporarily, and then remove the packing tape, shipping retainers, and accessories in the package (boards, fixing screws, etc.).
- 3.** Attach the 2 stepped screws to the machine.



- 4.** Align the hinges of the SPDF with the stepped screws, and attach them by sliding them in.
- 5.** Fix the SPDF to the machine (coin screws×2).
To fix the right hinge, make sure to use the screw hole [A]. The screw hole [B] is for skew correction, so if you attach the screw to screw hole [B], it may cause a skew.

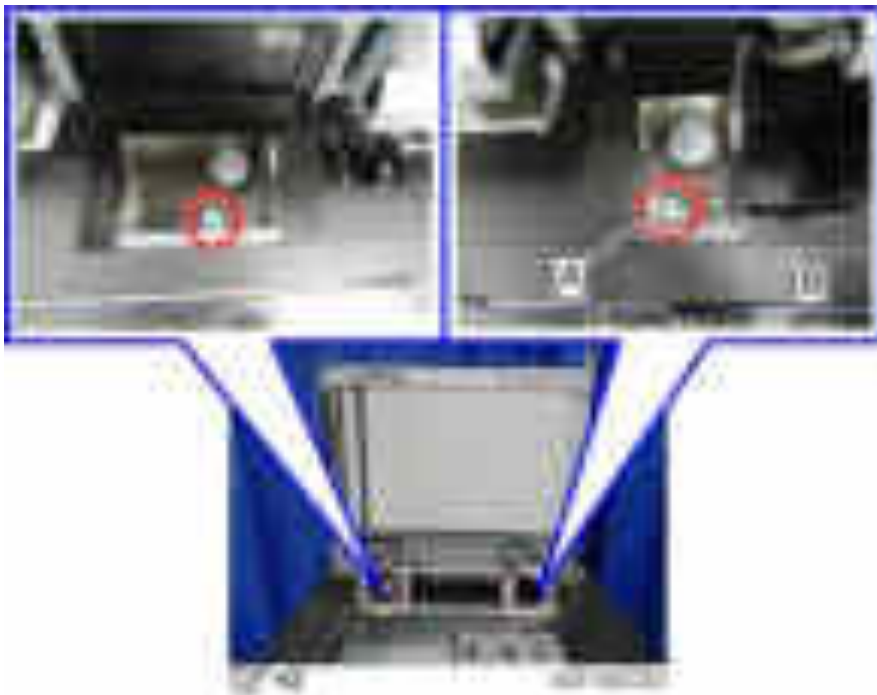

- 6.** Release the lever [A], then open the pressure plate sheet [B], and gently remove the protective sheet [C].

- 7.** Remove the packing tape, and shut the pressure plate sheet.



- 8.** Remove the platen sheet [A], and set it on the exposure glass. Align it with the left scale and rear scale of the scanner.



- 9.** Close the SPDF slowly, and attach the platen sheet and SPDF.



2. Installation

10. Remove the rear cover [A].

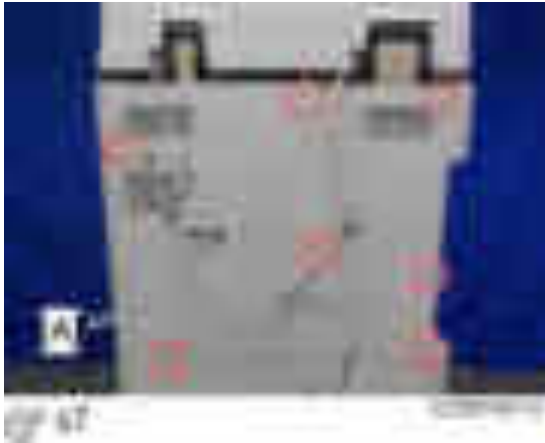

11. Remove the small disposable covers [A] on the rear cover.



12. Remove the controller box cover [A].

Red Circle: Remove, Blue Circle: Loosen



13. Connect the SPDF cable as shown and mount the brackets [A] [B] on the machine's rear frame. Make sure to connect the grounding wire.

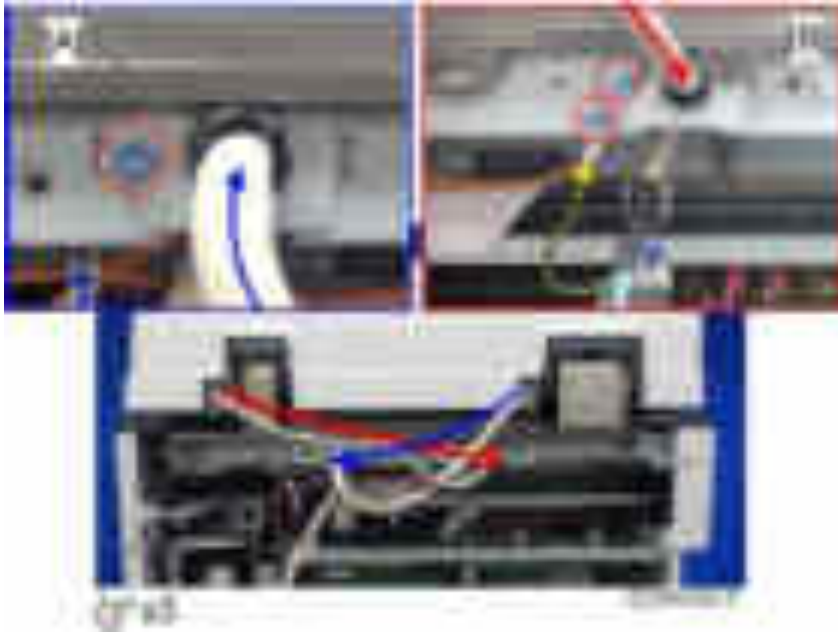

14. Connect the scanner cable to the connector at the machine's rear.



2. Installation

15. Attach the scanner cable [A] with the bracket on the upper frame of the controller box.

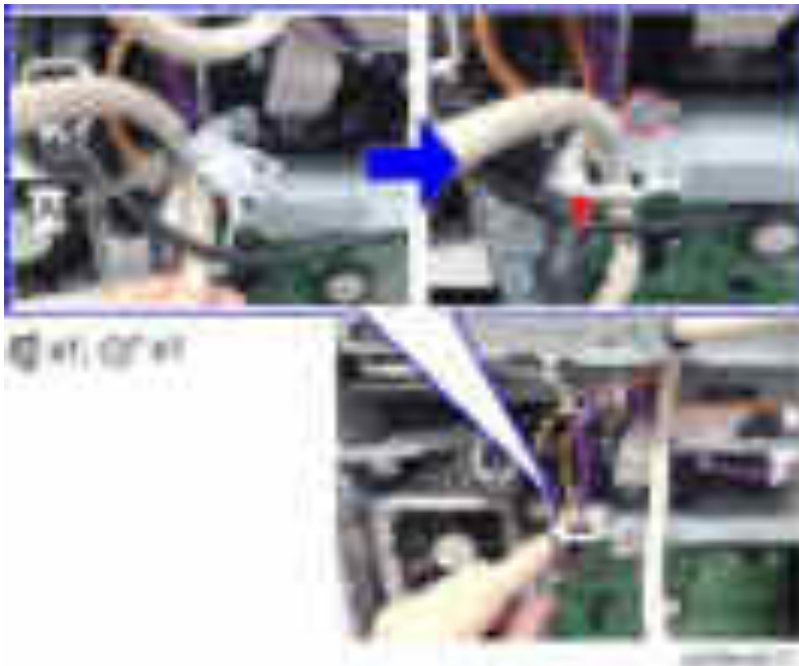

16. Connect the cable to the BICU (CN564).

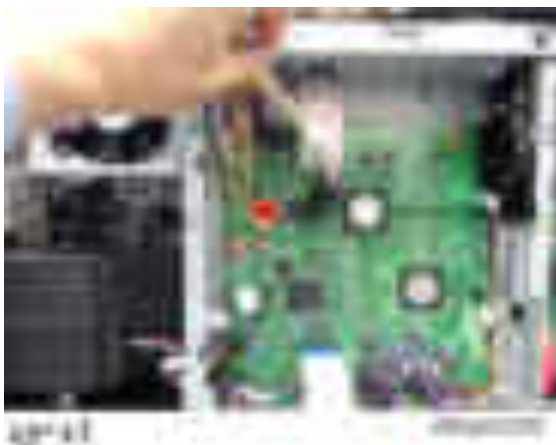

17. Reattach the controller box cover and the rear cover.

18. Attach the attention decal [A] to the top cover as shown.

- Choose the language that you want (English, French, or Spanish).
- The decal should be affixed inside the rib [B]. Make sure that the decal does not ride up the rib.



19. Attach the decal [A] on the front cover of the scanner unit.



20. Plug in and turn ON the main power.

21. Check that the registrations (side-to-side and leading edge) and image skew are correct. If they are not, adjust the registrations and image skew (Refer to [ADF Image Adjustment](#)).

Adjustment after Installation

- 1.** Turn ON the main power.
- 2.** Set SP4-688-002 (Scan Image Density Adjustment 1-pass DF) to "101".
- 3.** Execute SP4-730-002 (FROM Main Factory Setting Execution ON/OFF).
- 4.** Check the vertical registration for the SPDF.
 1. Create an original as shown in the following picture.
The large white arrow indicates the direction of feed.

2. Installation

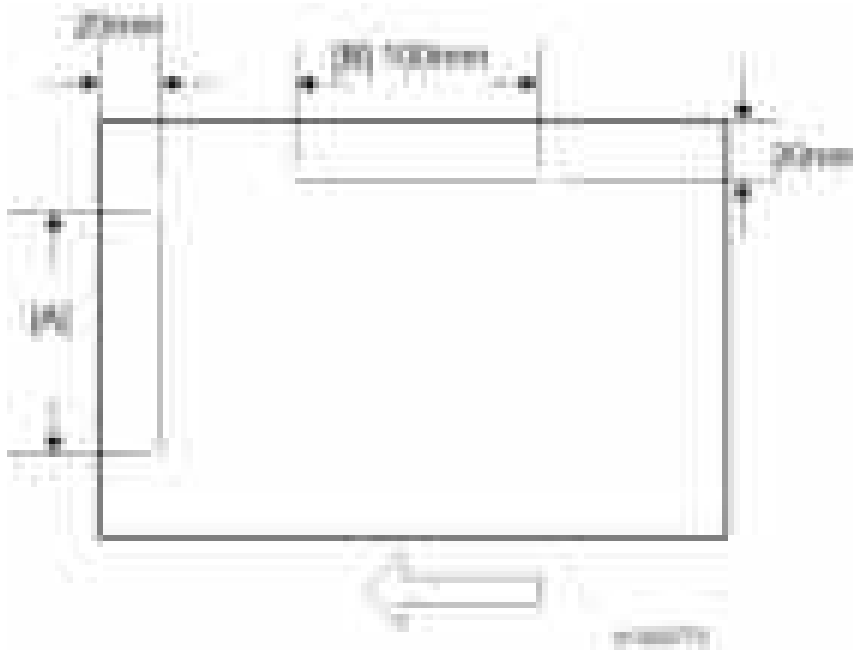

2. Copy the original and make sure that the position of line [A] is within $0\pm 1\text{mm}$
3. If not within the standard, adjust with the SP modes.
SP6-006-001 (ADF Adjustment Side-to-Side Regist: Front)
SP6-006-002 (ADF Adjustment Side-to-Side Regist: Rear)

5. Check the horizontal registration for the SPDF.

1. Copy the original and make sure that the position of the line [B] that you wrote on the original (see above) is within $0\pm 2\text{mm}$.
2. If not within the standard, adjust with the SP modes.
SP6-006-010 (ADF Adjustment L-Edge Regist (1-Pass): Front)
SP6-006-011 (ADF Adjustment L-Edge Regist (1-Pass): Rear)

6. Check the skew.

1. Make sure that the difference between both end positions of the line [A] that you wrote on the original (see above) is within $0\pm 2\text{mm}$.
2. If not within the standard, change the position of the fixing screw [A] to the long hole [B] at the right hinge.



SP descriptions

- **SP4-688-002 (Scan Image Density Adjustment: 1-pass DF)**

Adjusts density difference between Book and ADF. This SP is only for the SPDF models.

- **SP4-730-002 (FROM Main Factory Setting Execution ON/OFF)**

Copies the parameters written in FROM in the SPDF to the engine board in the MFP. This SP is only for the SPDF models.

Small Paper Feeding Unit Type M37 (D3FF-18, -22)

Accessory Check

No.	Description	Q'ty	Remarks
1	Tray Holder	1	
2	Spacer	2	
3	Rivet	2	
4	Double-sided Tape	2	



Installation Procedure

By installing this option to the SPDF, originals of A6 size can be set.

Applications that can scan originals with the Small Paper Feeding Unit:

- Copy
- Scanner
- Media Print & Scan

Other applications including fax and Classic Applications are not supported.

Installing the Small Paper Feeding Unit

1. Enter the SP mode, and then change SP6-050-001 (DF Feeding Unit detect ON/OFF) to "1 (On)".



2. Exit the SP mode, and then turn the main power OFF and back ON again.
The setting value is not be applied unless it is turned OFF/ON.
3. Remove the caps on the original tray.

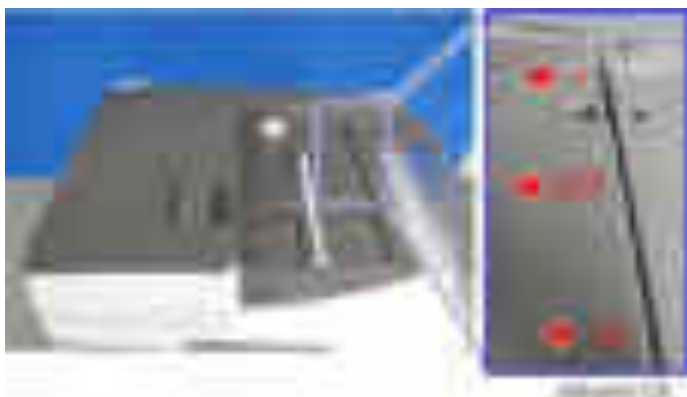

4. Install the small paper feeding unit [A].



2. Installation

5. Start the application that supports the small paper feeding unit.



6. After "Can scan with the small paper feeding unit" is displayed for a few seconds, it switches to the input screen of the small original size.



Attaching the Tray Holder

The tray holder can be attached on the front side or the rear side of the finisher.
You instruct to keep the paper feeding unit in the holder when users do not use it.

Front Side of Finisher

1. Affix the double-sided tape on the back side of the holder.
Clean the surface with an alcohol-soaked cloth.



- 2.** Attach the holder to the finisher front cover as shown below.



Rear of Finisher

- 1.** Attach the holder on rear cover of the finisher.



Main Machine Left Cover

2. Installation

1. Attach the holder to the main machine left cover.



If you want to attach another holder, attach it at the position of the blue frame with a double-sided tape.



If you want to stack two holders side by side, attach them using the supplied spacers as shown below.



[A]: Holder, [B]: Rivet, [C]: Spacer

SP Adjustment

Adjust the registration (front/back, leading edge/trailing edge) for the small paper feeding unit, if necessary.

SP items for the image position adjustments when using the Small Paper Feeding Unit is different from

the conventional SP number.

Here are the SP lists when using the Small Paper Feeding Unit:

- SP6-006-017 (ADF Adjustment: Side-to-Side Regist:Front: with Feeding Unit)
- SP6-006-018 (ADF Adjustment: Side-to-Side Regist:Rear: with Feeding Unit)
- SP6-006-019 (ADF Adjustment: L-Edge Regist(1-Pass): Front:with FeedingUnit)
- SP6-006-020 (ADF Adjustment: L-Edge Regist(1-Pass): Rear:with Feeding Unit)
- SP6-006-021 (ADF Adjustment: T-Edge Erase(1-Pass): Front:with FeedingUnit)
- SP6-006-022 (ADF Adjustment: T-Edge Erase(1-Pass): Rear:with Feeding Unit)
- SP6-006-023 (ADF Adjustment: 1st Buckle(1-Pass): with Feeding Unit)

Page Keeper Type M37 (D3FF-19, -23)

Accessory Check

No.	Description	Q'ty	Remarks
1	Double-feed Sensor (Receiver)	1	
2	Double-feed Sensor Board	1	
3	Double-feed Sensor (Emitter)	1	
4	13 pin harness	1	
5	2 pin harness	1	
6	7 pin harness	1	
7	Long harness	1	
8	Screw (M3x8)	2	
9	Screw (M3x6)	4	
10	Large Clamp	1	
11	Small Clamp	1	
12	Plastic Sheet	1	



Installation Procedure

CAUTION

- Turn OFF the main power and unplug the power cord from the wall socket. If installing without turning OFF the main power, an electric shock or a malfunction may occur.

Installation flow

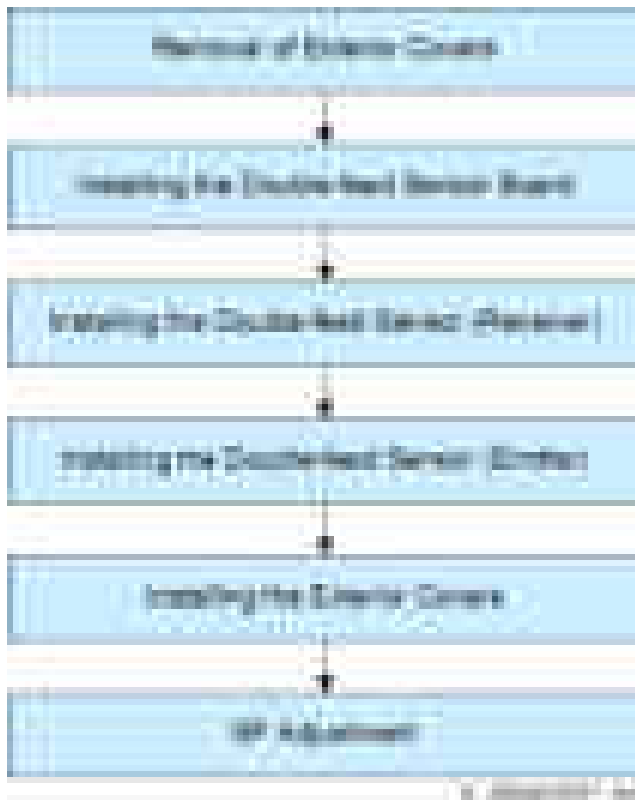

Removal of Exterior Covers

1. Open the lift cover, and then remove the flat cover [A].



2. Remove the rear cover [A].



2. Installation

- 3.** Remove the front cover [A] by sliding it to the arrow direction.



- 4.** Remove the ground wire, and then disconnect the harness routing to the lift cover.



- 5.** Remove the lift cover [A].
The screws must be removed in the order of (1) and (2).



6. Remove the lower paper guide [C].

Screw [A]: Silver screw, Screw [B]: Black step screws

When the lower paper guide is removed, the mounting position [D] of the double-feed Sensor (Emitter) is exposed.



2. Installation

Installing the Double-feed Sensor Board

- 1.** Attach the supplied large clamp to the Double-feed Sensor Board.



- 2.** Connect the supplied harnesses.
(From left to right: 7pin, 13pin, 2pin)



- 3.** Bind the harnesses with the supplied clamp.



- 4.** Install the Double-feed Sensor Board [A] to the ADF (M3x6).
Fit the bracket to the positioning projection on the ADF frame and then screw it.



- 5.** Keep the harness towards the upper side along the cover as shown below.



- 6.** Connect the 13 pin harness to the ADF main board.



- 7.** Route and clamp the harness (7pin and 2pin) along the guide.

2. Installation



Installing the Double-feed Sensor (Receiver)

- 1.** Remove the upper paper guide [A] of the lift cover.



- 2.** Remove the bracket [A].



- 3.** Disconnect the harness of the separation sensor [A] and Skew correction sensor [B].

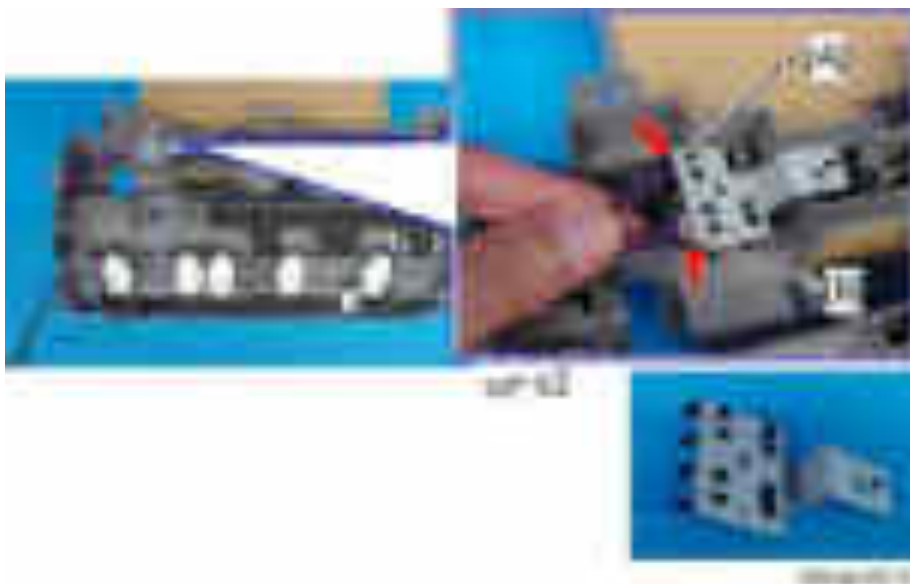

- 4.** Remove the harness [A] from the upper paper guide.
Discard the removed harness. Do not keep it.



- 5.** Prepare the supplied long harness [A], and then connect it to the double-feed sensor (receiver) [B], and connect to the sensors removed in step 3.
Since both separation sensor and skew correction sensor connectors are 3 pins, they are identified by color (black and white). Connect as shown below.

2. Installation

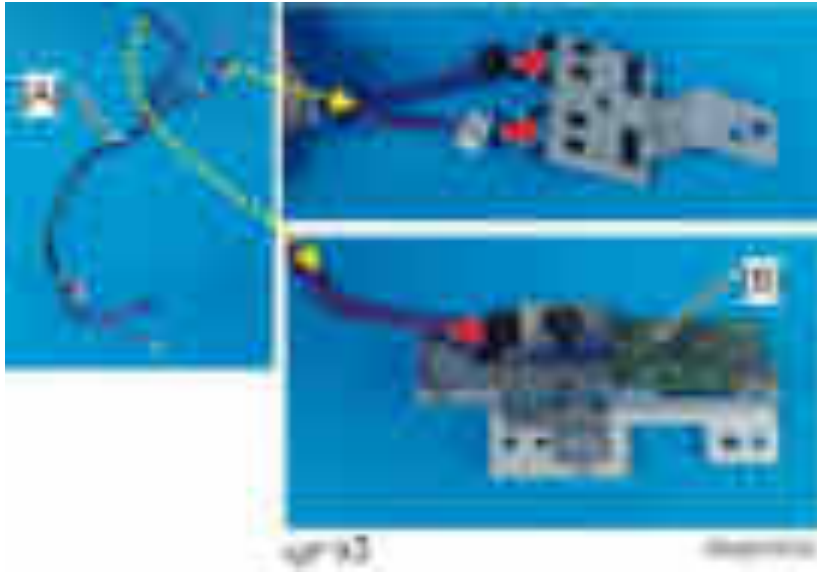

- 6.** Install the double-feed sensor (receiver) [A] to the upper paper guide. Fit the bracket to the positioning projection and then screw it.



- 7.** Route the harness as shown below and let it through the hook. Also, adjust the length so that the binding part [A] comes to the position just before the hook.



- 8.** Attach the supplied small clamp [A] to the bracket removed in step 2.



- 9.** Reattach the bracket [A] to the upper paper guide. Pass the harness of the double-feed sensor (receiver) through the clamp.

- 10.** Pass the harness of the double-feed sensor (receiver) through the clamp. Make sure that the bearings [B] of the bracket [A] is fixed to the guide.

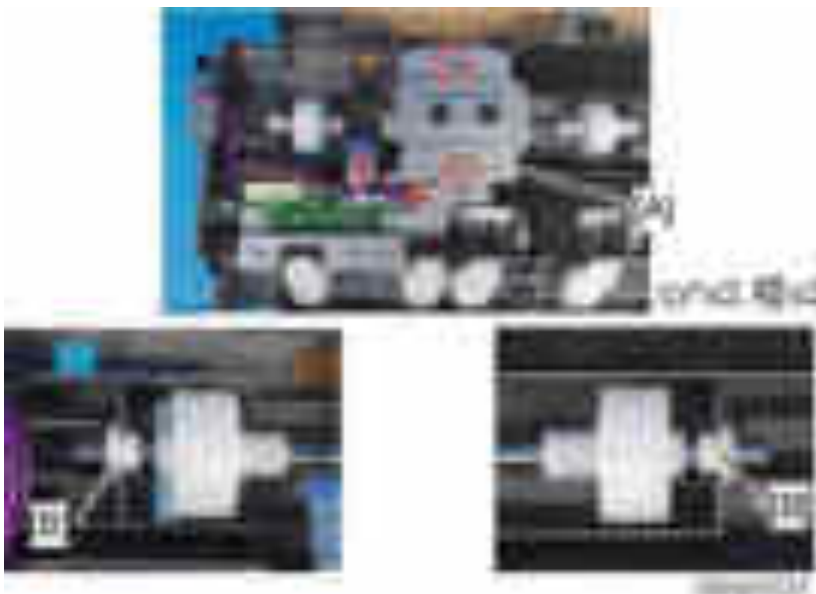

- 11.** Reattach the sensor bracket [A].

Let the harness through the hook and adjust the length so that the binding part [B] comes to the position just before the hook.



- 12.** Confirm the routing of the harness.

2. Installation

Whether the harness and the ground wire of the double-feed sensor are on the front side of rib [A].

Whether the position of the bind parts are correct.

Whether the harness goes through a hook.



13. Clean the area [A] on side of rib with alcohol.



14. Prepare the supplied plastic sheet [A], and fit the groove (red circle below) to the bracket as shown below.



15. Push the plastic sheet to all the way in the unit it stops.

16. Align the plastic sheet to the top (red line) of the rib, then peel off the double-sided tape [B] on the

back of the plastic sheet and affix it to the side of the rib.



- 17.** Attach the upper paper guide [A].
Confirm that there is no entrapment of the harness at the position [B].



Installing the Double-feed Sensor (Emitter)

- 1.** Route the 2 pin connector harness [A] as shown below.



- 2.** Open the clamps that fix the ferrite core to free the harness.

2. Installation



- 3.** Connect the 2 pin connector to the double-feed sensor (emitter) [A].



- 4.** Install the double-feed sensor (emitter) [A] to the ADF frame.
5. Fit the sensor bracket to the positioning projection and then screw it.



- 6.** Open the ferrite core, and then put the harness of the double feed sensor into the core, and clamp

it.

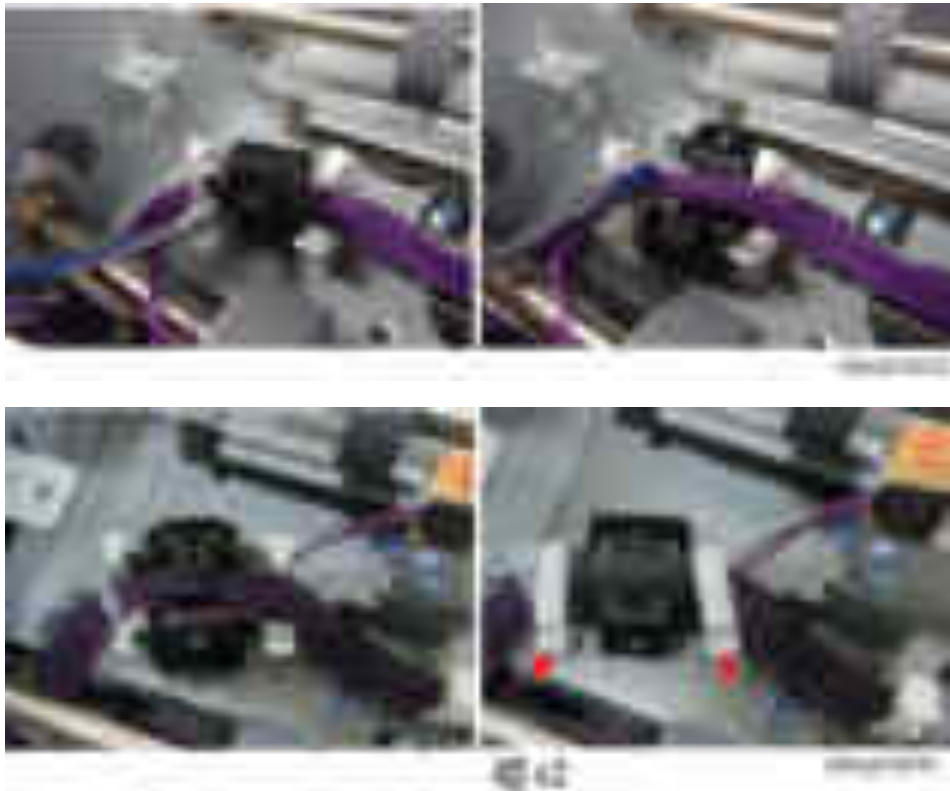

Installing the Exterior Covers

- 1.** Push the harness into the cutout of the frame.



- 2.** Reattach the lower paper guide.
Confirm that there is no entrapment of the harness at the cutout position (blue square).



2. Installation

- 3.** Insert the shaft of the lift cover into the hole of the rear frame and reattach the lift cover. Insert the black rubber [A] so that it fits outside of 5 hooks [B].

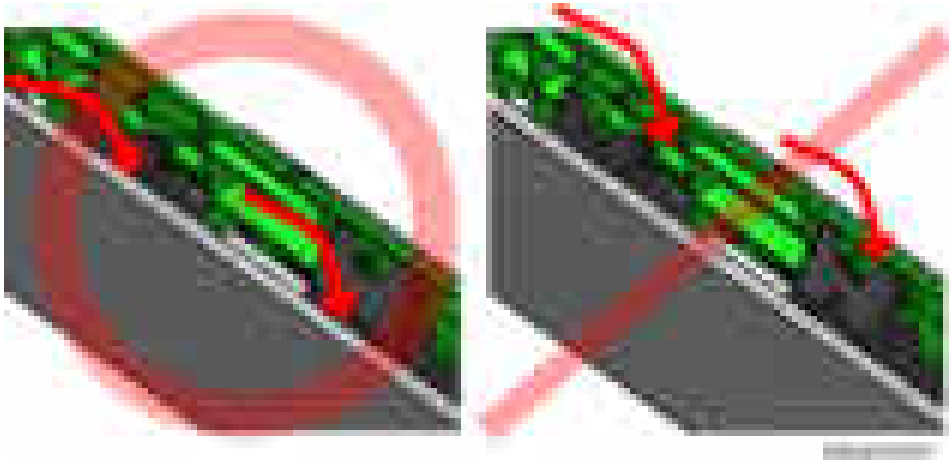
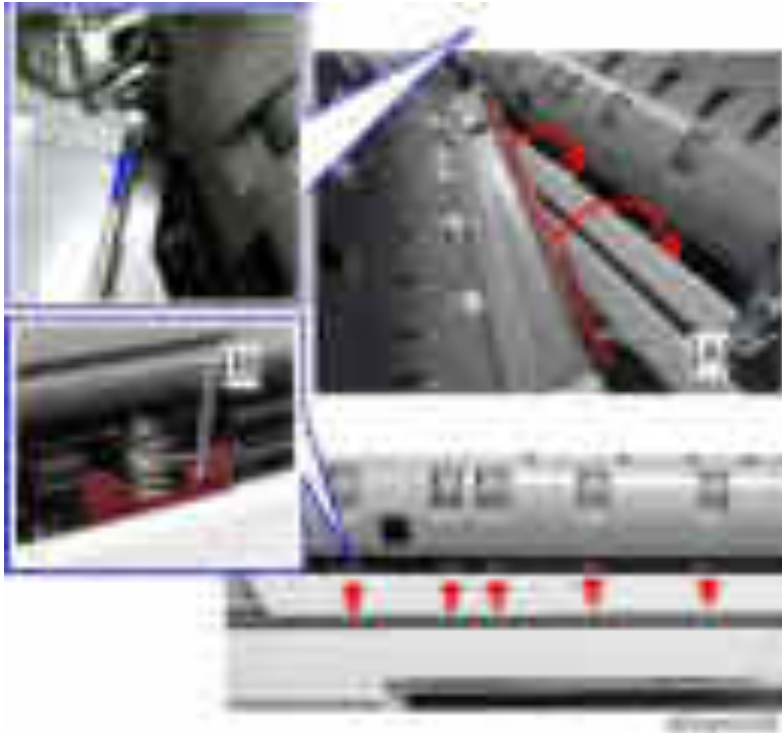

- 4.** Fasten the lift cover. The screws must be reinstalled in the order of (1) and (2).



- 5.** Connect the harness routed from the lift cover, and then fasten the ground wire.



- 6.** Reattach the exterior covers.

SP Adjustment

- 1.** Turn the main power ON, and then enter the SP mode.
- 2.** Change both of the following SP to "1".
 - SP6-040-001 (ADF Double Feed Detect Setup: Double Feed Detect Sensor (1-Pass))
Default: 0.
 - SP6-040-002 (ADF Double Feed Detect Setup: Detect enable (1-Pass))
Default: 0
- 3.** Place an original (standard paper such as plain paper) on the SPDF.
- 4.** Execute SP6-040-008 (ADF Double Feed Detect Setup: Detect Test (1-Pass)).
The original is scanned.
- 5.** Execute SP6-040-009(ADF Double Feed Detect Setup: Detect Adjust Result (1-Pass)).
- 6.** Check the result code. If 002 or 003 is displayed, the double -feed is successfully detected.

Code	Result	Description
001	No execution	-
002	Succeeded Low sensitivity	Detect test has been successful.
003	Succeeded High sensitivity	Detect test has been successful.
004	Failed	<ul style="list-style-type: none"> • The harnesses are disconnected, or loose. • Double-feed Sensor Board is defective.

1 Bin Tray BN3130 (D3CQ)

Accessory Check

No.	Description	Q'ty	Remarks
1	Tray	1	
2	Harness cover	1	
3	1 Bin Tray Unit	1	
4	Harness	1	
5	Tray support bar	1	
6	Gear	1	
7	Screw: M3 x 8	2	



Installation Procedure

CAUTION

- When installing this option, turn OFF the main power and unplug the power cord from the wall socket. If installing without turning OFF the main power, an electric shock or a malfunction may occur.

IMPORTANT

- When attaching this 1-bin tray unit at the same time as Bridge Unit or Side Tray, attach this tray first. Otherwise, the 1-bin tray's exit tray cannot be attached due to the Bridge Unit or Side Tray.

1. Remove the packing tape and retainers, and then remove the accessories (screws, etc.).

- 2.** Remove the inverter tray [A].



- 3.** Remove the paper exit tray [A].



- 4.** Remove the paper exit feeler [A].



2. Installation

- 5.** Tuck in the lever [A] for detecting when the tray is full.



- 6.** Remove the proximity sensor left cover [A].



- 7.** Open the right door, and then remove the small cover [A].



- 8.** Open the front cover.

- 9.** Remove the proximity sensor cover [A].



Figure 10

- Remember that there are three tabs at the positions of the red arrows.
- Tilt the operation panel [B] upward to a horizontal position, and then remove the proximity sensor cover [A].



10. Remove the paper exit cover [A].



2. Installation

- 11.** Attach the supplied gear [A].



- 12.** Attach the 1-bin tray unit [A].

Make sure to engage it with the gear attached in the previous step.

Take care that the harness is not trapped between the 1-bin tray unit and the machine frame.



- 13.** Remove the upper left cover [A] by pulling it towards the front.



- 14.** Remove the left rear cover [A].



- 15.** Remove the tray support rod cover [A].



- 16.** Attach the supplied harness.



- 17.** Attach the tray support bar [A].

When attaching the tray support bar [A], make sure that the harness attached in the previous step goes through the slit in the tray support bar circled in blue [A] and comes outside of it as shown below.

2. Installation



18. Hook the 1-bin tray [A] onto the 1-bin tray unit, aligning the positions in the blue circle.



19. Connect the harness to the 1-bin tray, and bring it around.



- 20.** Insert the tray support bar firmly in the 1-bin tray, and attach the harness cover [A].



- 21.** Reattach the paper exit feeler [A].



- 22.** Pull the lever [A] out.



- 23.** Reattach covers.

When reattaching the proximity sensor cover, make sure to connect the harness.



2. Installation

24. Turn ON the main power.

25. Check that output to this tray can be selected on the operation panel, and check operation.

Checking the Position of the Paper Exit Feeler

Check the following points for the paper exit feeler [A] at the paper exit.

- It can move in line with the ejection of paper
- It holds contact with the surface of the ejected paper and is still movable



Paper will get jammed in the following cases.

- The paper exit feeler does not function due to obstacles (such as cables).
- The paper exit feeler does not function when the paper is pulled out and pushed back again.



Internal Shift Tray SH3080 (D3FV)

Accessory Check

No.	Description	Q'ty	Remarks
1	Tray Cover	1	
2	Sheet	2	



Installation procedure

CAUTION

- When installing this option, turn OFF the main power and unplug the power cord from the wall socket. If installing without turning OFF the main power, an electric shock or a malfunction may occur.

INFORMATION

- The internal shift tray cannot be used together with the following peripherals:
 - Bridge Unit BU3090 (D3FW)
 - Side Tray Type M37 (D3FX)
 - Internal Finisher SR 3250 (D3FG)
 - Internal Finisher SR 3300 (D3FT)
 - Internal Multi-Fold Unit FD3010 (D3FS)
- To use together with the "1 Bin Tray BN3130", attach the "1 Bin Tray BN3130" first before installing the internal shift tray.

1. Remove the packing tape and retainers, and then remove the accessories (screws, etc.).

2. Installation

2. Attach the tray cover [B] to the shift tray [A].

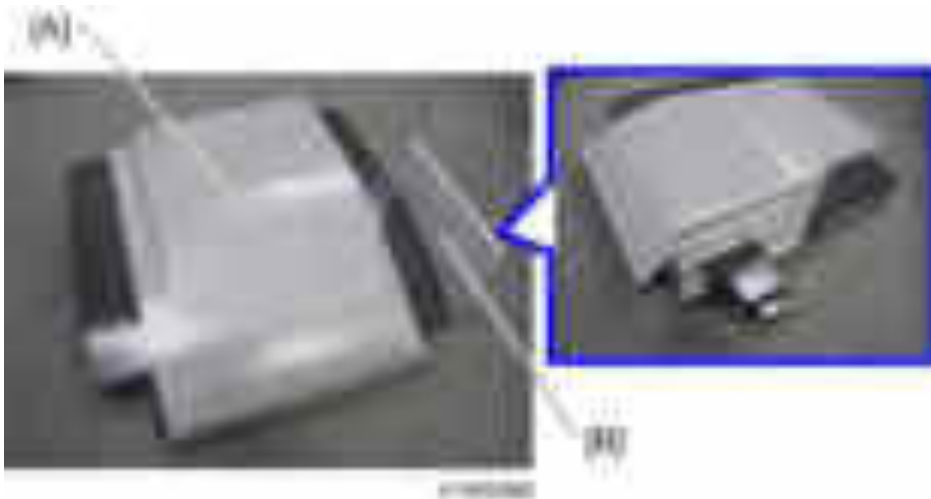

3. Remove the paper exit tray [A].



4. Remove the connector cover [A].



5. Attach the shift tray [A].



6. Remove the paper exit feeler [A] to apply the Mylar sheet properly.



7. Attach the sheets [A] at the edge of the paper exit cover.



- Make sure to attach the Mylar as shown in the photo below. This is to prevent curling when the paper lands in the tray.
- The Mylar's top edge should be **0-2.5mm** from the top edge of the paper exit cover, i.e. between the two red lines.
- The Mylar's side edge should be **flush against** the side of the cover, i.e. along the yellow dotted line.



2. Installation

- 8.** Tuck in the lever [A] for detecting when the tray is full.



- 9.** Reattach the removed paper exit feeler [A].



- 10.** Turn ON the main power.

- 11.** Check that paper output to the shift tray can be selected at the operation panel, and check the operation.

Checking the Position of the Paper Exit Feeler

Check the following points for the paper exit feeler [A] at the paper exit.

- It can move in line with the ejection of paper
- It holds contact with the surface of the ejected paper and is still movable



Paper will get jammed in the following cases.

- The paper exit feeler does not function due to obstacles (such as cables).

- The paper exit feeler does not function when the paper is pulled out and pushed back again.



Side Tray Type M37 (D3FX)

Accessory Check

No.	Description	Q'ty	Remarks
1	Left Extension Tray	1	
2	Upper Extension Tray	1	
3	Fixing Plate	1	
4	Knob Screw	1	
5	Tapping screw - M4 x 14	1	
6	Tapping screw - M3 x 8	1	
7	Bracket	1	
8	Paper Support Guide	1	
9	Driven Roller (Flat)	1	

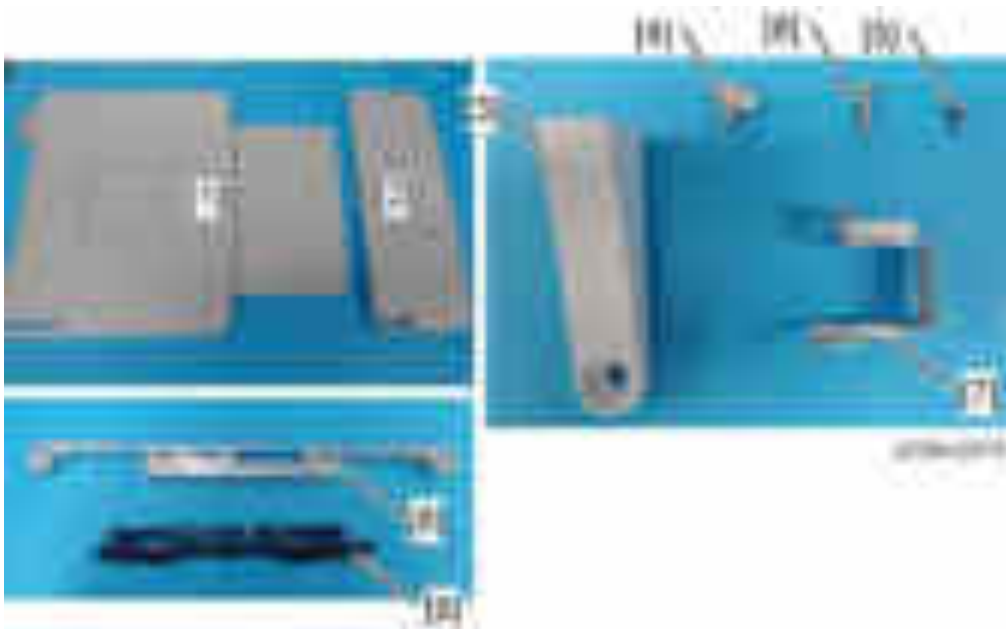

Installation Procedure

CAUTION

- When installing this option, turn OFF the main power and unplug the power cord from the wall socket. If installing without turning OFF the main power, an electric shock or a malfunction may occur.

NOTE

- The side tray cannot be used together with the following peripherals:
 - Internal Shift Tray SH3080 (D3FV)
 - Bridge Unit BU3090 (D3FW)
 - Internal Finisher SR 3250 (D3FG)

- Internal Finisher SR 3300 (D3FT)
- Internal Multi-Fold Unit FD3010 (D3FS)

- To use together with the "1 Bin Tray BN3130 ", attach the "1 Bin Tray BN3130" first before installing the side tray.

- 1.** Remove the packing tape and retainers, and then remove the accessories (screws, etc.).
- 2.** Remove the inverter tray [A].



- 3.** Remove the paper exit tray [A].



2. Installation

- 4.** Remove the connector cover [A].



- 5.** Remove the paper exit feeler [A].



- 6.** Tuck in the lever [A] for detecting when the tray is full.



- 7.** Remove the driven roller [B] at the machine's exit tray and attach the supplied driven roller [A].

- Insert a flathead screwdriver into the depression in the center, and then, lifting the driven roller, unlock the part indicated by the red arrow.
- When attaching the driven roller, push its center all the way in until it clicks.

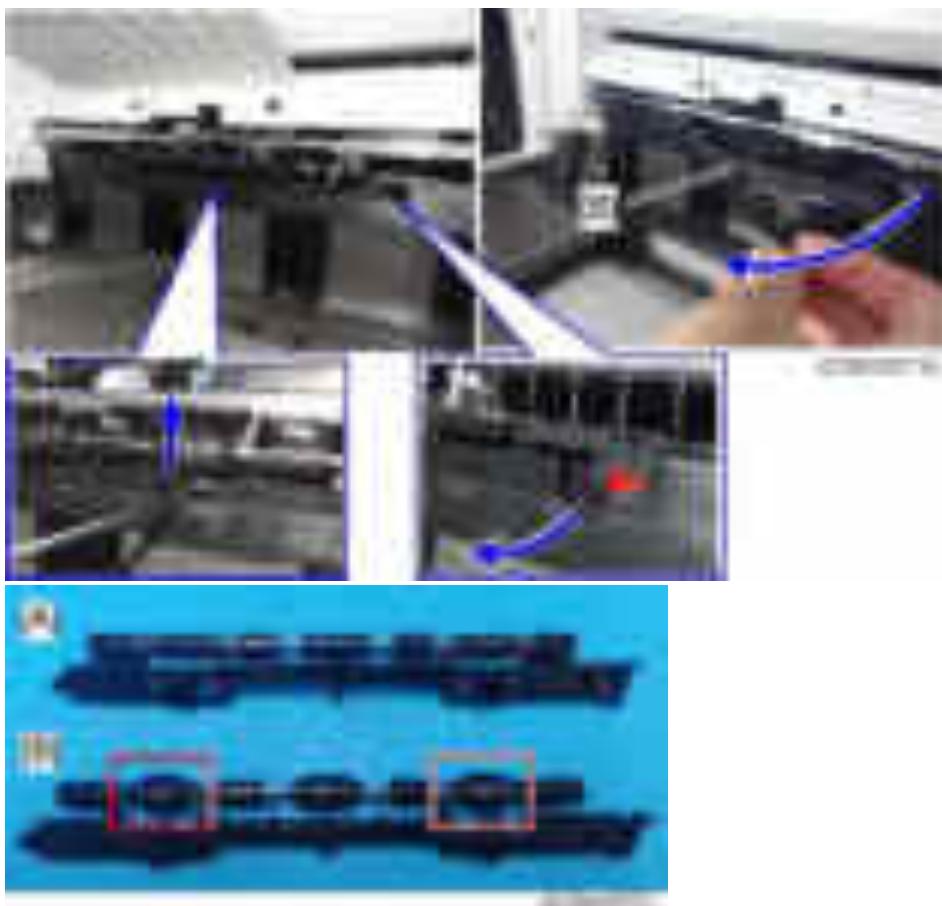

[A]: The supplied driven roller has flat rollers.

[B]: The machine's standard driven roller has drum-type rollers (as indicated by red frames).



The spring arm on the flat roller might be disconnected due to the vibration or shock. After attaching the roller, perform a visual check whether the state of assembly is normal or not.

[A]: Normal position, [B]: spring arm is disconnected.

2.Installation

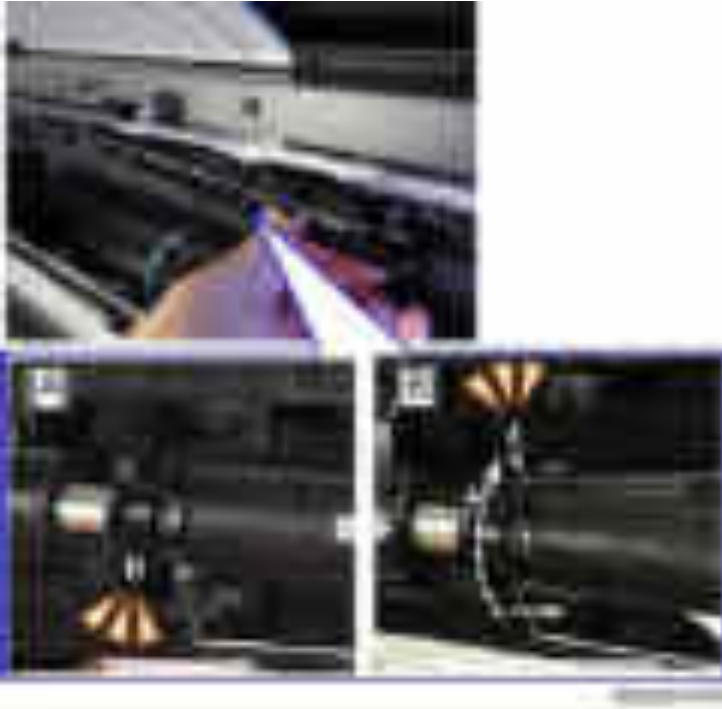

8. Attach the paper support guide [A] (Tab x4).



9. Remove the proximity sensor left cover [A].



10. Attach the bracket [A].



11. Reattach the proximity sensor left cover [A].



12. Attach the side tray unit [A] to the machine, and fix with a knob screw.



2. Installation

13. Attach the fixing plate [A] (1×1).



14. Attach the upper extension tray [A] and the left extension tray [B].



15. Reattach the inverter tray.

16. Turn ON the main power.

17. Check that paper output to the side tray can be selected at the operation panel, and check the operation.

Bridge Unit BU3090 (D3FW)

Accessory Check

No.	Description	Q'ty
1	Tapping screw- M3 × 8	1
2	Screw - M4	1
3	Knob Screw - M4	1
4	Right Front Bracket	1
5	Upper Left Cover	1
6	Left Front Bracket	1
7	Paper Support Guide	1
8	Driven Roller (Flat)	1



Installation Procedure

CAUTION

- When installing this option, turn OFF the main power and unplug the power cord from the wall socket. If installing without turning OFF the main power, an electric shock or a malfunction may occur.

NOTE

- The bridge unit cannot be used together with the following peripherals:
 - Internal Shift Tray SH3080 (D3FV)
 - Side Tray Type M37 (D3FX)
 - Internal Finisher SR 3250 (D3FG)
 - Internal Finisher SR 3300 (D3FT)
 - Internal Multi-Fold Unit FD3010 (D3FS)
- To use together with the "1 Bin Tray BN3130", attach the "1 Bin Tray BN3130" first before installing the bridge unit.

- Remove the packing tapes and retainers, and remove the accessories (screws, etc.).

2. Installation

2. Remove the interval tray [A].



3. Remove the paper exit tray [A].



4. Remove the connector cover [A].



- 5.** Remove the paper exit feeler [A].



- 6.** Tuck in the lever [A] for detecting when the tray is full.



- 7.** Remove the driven roller [B] at the machine's exit tray and attach the supplied driven roller [A].

- Insert a flathead screwdriver into the depression in the center, and then, lifting the driven roller, unlock the part indicated by the red arrow.
- When attaching the driven roller, push its center all the way in until it clicks.



[A]: The supplied driven roller has flat rollers.

[B]: The machine's standard driven roller has drum-type rollers (as indicated by red frames).

2. Installation



The spring arm on the flat roller might be disconnected due to the vibration or shock. After attaching the roller, perform a visual check whether the state of assembly is normal or not.

[A]: Normal position, [B]: spring arm is disconnected.

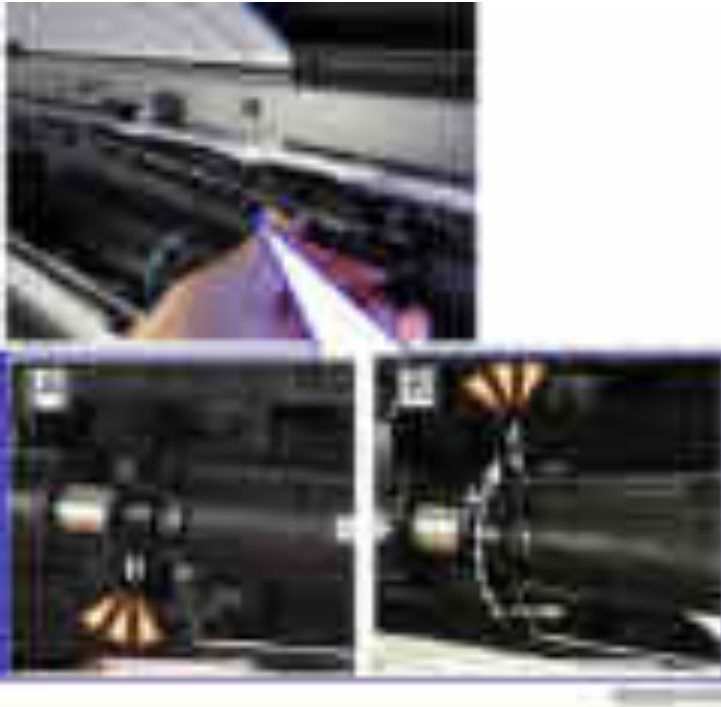

8. Attach the paper support guide [A] (Tab x4).



9. Open the front cover.

10. Remove the upper left cover [A].



- The screw removed is used again in step 16.



11. Remove the proximity sensor left cover [A].



12. Attach the bracket [A].



13. Reattach the proximity sensor left cover [A].



2.Installation

14. Attach the bridge unit [A] to the machine.



15. Reattach the inverter tray.

16. Attach the supplied upper left cover [A].
Use the screw removed in step 10.



17. Attach the L type connecting bracket [A].

To fix the bridge unit securely on the machine, tighten the finisher's joint bracket and L type connecting bracket [A] together when installing the finisher.



18. Complete the bridge unit attachment.

Refer to the procedure for connecting the optional unit downstream of the bridge unit.

- Booklet Finisher SR3240 (D3BB) ([Booklet Finisher SR3290 \(D3FN\)](#) / [Finisher SR3280 \(D3G4\)](#))
- Finisher SR3230 (D3BA) ([Booklet Finisher SR3290 \(D3FN\)](#) / [Finisher SR3280 \(D3G4\)](#))
- Booklet Finisher SR3220 (D3B9) ([Booklet Finisher SR3270 \(D3FQ\)](#))
- Finisher SR3210 (D3B8) ([Finisher SR3260 \(D3FR\)](#))

Booklet Finisher SR3290 (D3FN) / Finisher SR3280 (D3G4)

- To attach this optional unit, the following optional units are required.
 - Bridge Unit BU3090 or Internal Multi-Fold Unit FD3010
 - LCIT PB3290 or Paper Feed Unit PB3300/Paper Feed Unit PB3280

Accessory Check

No.	Description	Q'ty	Remarks
1	Booklet Tray	1	Booklet Finisher SR3290 only
2	Shift Tray	1	
3	Relay Guide Plate	1	
4	Joint Bracket	1	
5	Cushion	1	
6	Cushion for Staple Stand	1	
7	Screws(4x12)	4	
8	Screws(3x6)	4	
9	Screws(3x8)	1	
10	Ground Plate	1	
11	Tray Holder	1	
12	Round Rivets	2	
13	Booklet Stapler Unit Fixing Cover	1	Booklet Finisher SR3290 only
14	Proof Support Tray	1	



Installation Procedure

CAUTION

- When installing this option, turn OFF the main power and unplug the power cord from the wall socket. If installing without turning OFF the main power, an electric shock or a malfunction may occur.

Note

- Before installing this option, attach the "Bridge Unit BU3090" and "LCIT PB3290" or "Paper Feed Unit PB3300/PB3280" first.
- Depending on the floor of the installation location, apply the felt cushion to the staple stand to prevent scratches. For details about applying the cushion, see step 17 and later.

Felt cushion	Floor type
Apply	Tile, steel, coated, flooring
Do not apply	Carpet

- 1.** Remove the packing tape and retainers, and then remove the accessories (screws, etc.).
- 2.** Open the front cover, and remove the packing tapes, shipping retainers.

2000-sheet Booklet Finisher

1. Remove the fixing bracket [A].

2. Installation

Keep the screws that were removed and reuse them for attaching the supplied booklet stapler unit fixing cover [A] in step 5.



2. Remove the screw at the lower part of the finisher (red circle).
3. Pull out the saddle stitch unit and remove the fixing bracket [A].



4. Remove the packing tapes and shipping retainers on the saddle stitch unit.



5. Attach the supplied booklet stapler unit fixing cover [A].

Use the screws removed in step 1.

When you attach the Punch Unit PU3090, it is not necessary to attach this cover.

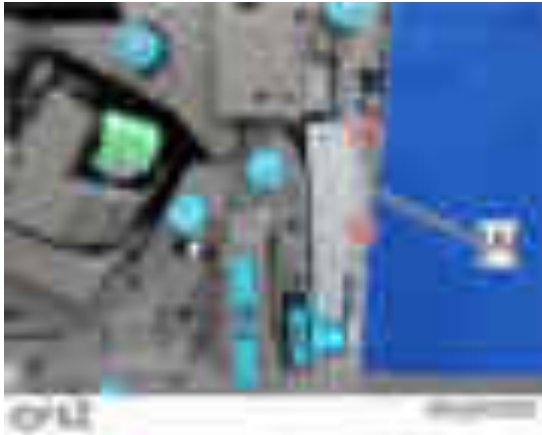

3000-sheet Finisher

1. Remove the packing tapes, shipping retainers.

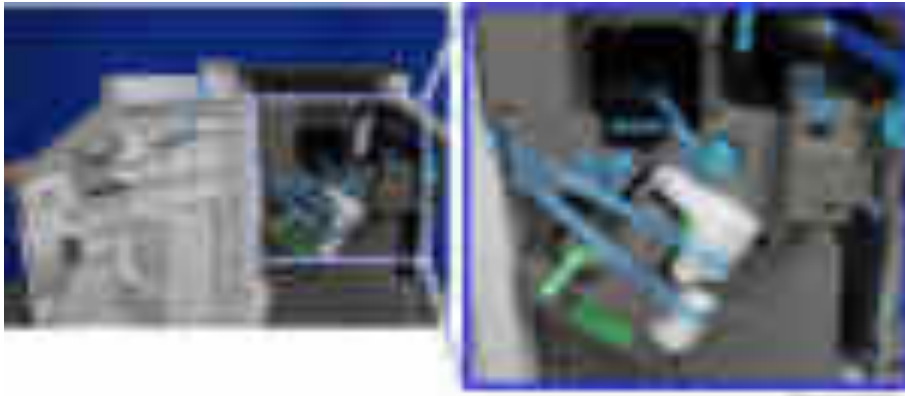

3. Attach the shift tray [A] (3x8).

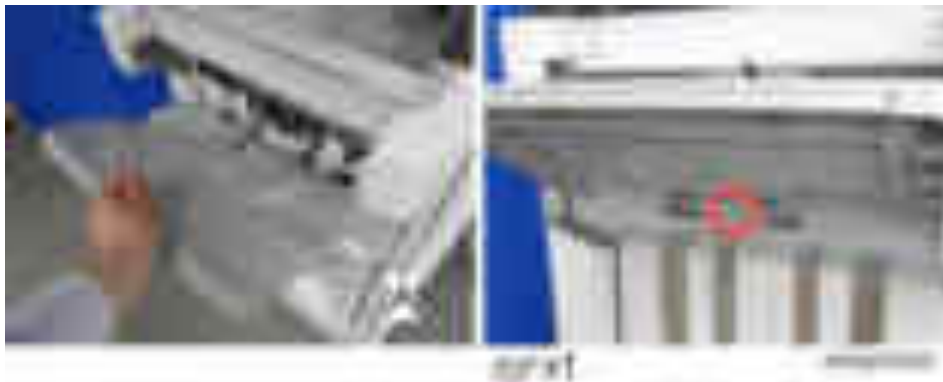

2. Installation

- 4.** Attach the booklet tray [A] (2000-sheet Booklet Finisher only).



- 5.** Attach the relay guide plate [A] in the following procedure.

1. Temporarily attach the screw on the front side (3x6).



2. Hook the relay guide plate [A] on the screw attached in step 1, then fully tighten the screw on the rear side (3x6).



3. Fully tighten the screw on the front side.

6. Attach the ground plate [A] (3x6).



7. Attach the joint bracket [A] to the machine in the following procedure.

1. Temporarily attach the screws on the upper screw holes (4x12).



2. Hook the joint bracket [A] on the screws attached in step 1, then adjust the position so that the screw head comes to the center mark of the scale.



3. Fully fix the joint bracket [A] (4x12).

Tighten the joint bracket [A] and bracket [B] of the bridge unit together.

2. Installation



- 8.** Clean the right side of the upper cover with a cloth moistened with alcohol, and then attach the cushion [A] to the finisher.

Make sure that the cushion is aligned with the guide rib of the upper cover.

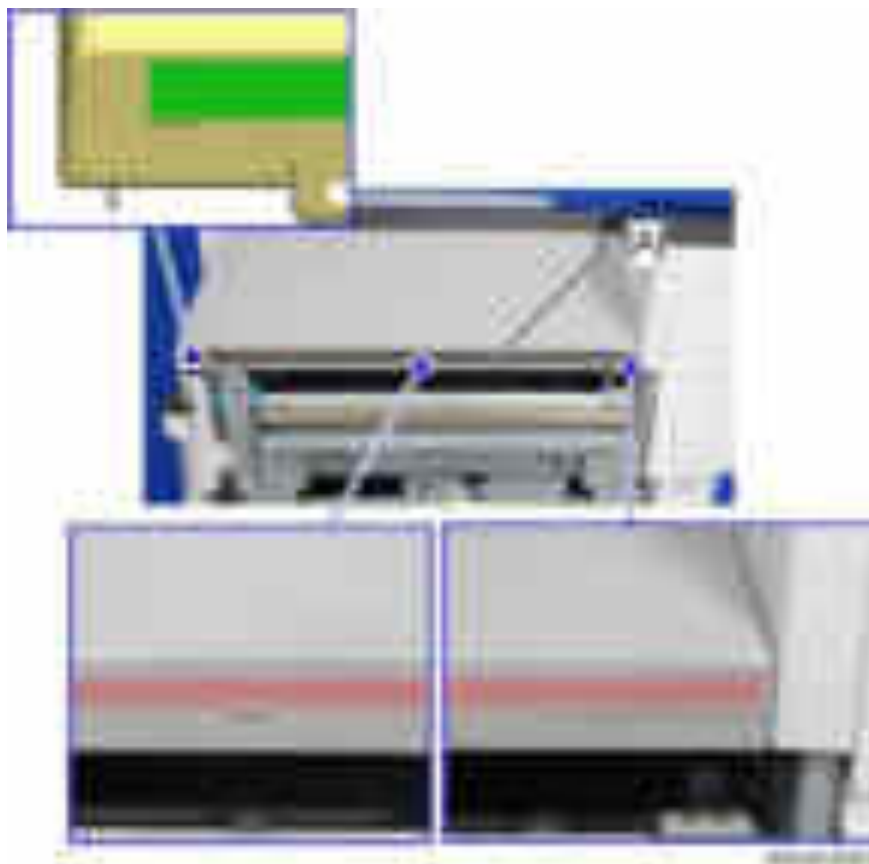

- 9.** Remove the connector cover [A] on the right side of the main machine.
When the Internal Multi-Fold Unit FD3010 is installed, it is not necessary to remove this cover.



- 10.** When the Internal Multi-Fold Unit FD3010 is installed, connect the finisher cable to the connector on the internal multi-fold unit.



- 11.** Remove the screw on the connection lever [A] and pull the lever.



- 12.** Connect the finisher to the main unit, and then push in the connection lever [A] to fasten it to the

2. Installation

main unit.



When the Internal Multi-Fold Unit FD3010 is installed, make sure that the finisher's 2 cables are not crossing each other before you connect the finisher.



13. When the bridge unit is installed, connect the interface cable to the machine.



- 14.** Attach the tray holder [A].



- 15.** Pull out the saddle stitch unit.



- 16.** Lift the staple stand [A] until it comes into contact with the inner cover, and then apply the felt cushion [B].

Apply the felt cushion with the base at the point where the staple stand comes into contact with the inner cover. Be sure to apply the cushion to wrap the staple stand, so that the cushion does not protrude.



- 17.** Close the front cover.

- 18.** Turn ON the main power.

- 19.** Deliver some A3/DLT paper to the proof tray and check if the vertical registration is correct according to the adjustment scale for A3/DLT paper ([Side-to-side Registration Error \(Finisher Registration Adjustment\)](#)).

- 20.** Check that the finisher can be selected on the operation panel, and check the finisher's operation.

2. Installation

Attaching the Proof Support Tray

Explain the following information to the users.

- The sensor may detect that the exit tray is full prematurely when delivering z-folded sheets or curled paper to the tray.
- If a message reporting the paper exit tray full appears, the job will be suspended until the papers are removed from the paper exit tray. By attaching a support tray, you can prevent the premature full detection.

Three types of support tray are provided for this finisher. Make sure that you understand the purpose of each support tray before installing one of them.



Support Tray: Proof Tray ("1" marked on the back)

When using B4, LG or larger paper, or when using limp paper, the sheet may become bent, resulting in premature full detection.



This can be solved by attaching the proof support tray [B] on the proof tray [A].



A problem that may occur after attaching this support tray:

When printing A4, LT or smaller paper with the support tray, the machine stacks only 200 sheets, which is less than the standard specification of 250 sheets.

When printing B4, LG or larger paper with the support tray, the machine stacks 50 sheets, which is the same as the standard specification.

Support Tray: Proof Tray ("2" marked on the back) provided with the Internal Multi-Fold Unit

By attaching Support Tray: Proof [A], more sheets can be stacked when delivering z-folded sheets to the proof tray, preventing premature full detection.

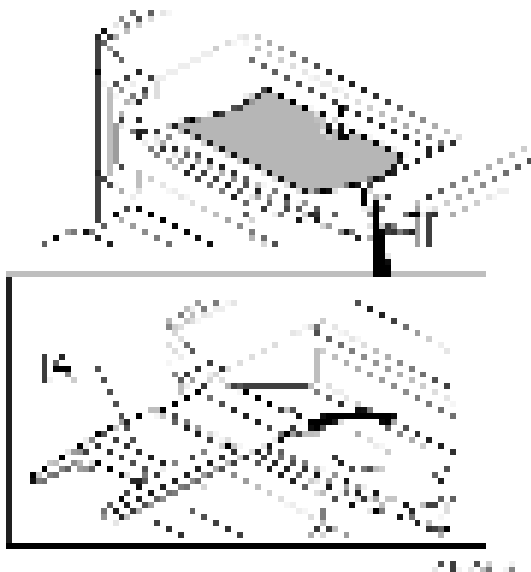

Support Tray: Shift Tray ("3" marked on the back) provided with the Internal Multi-Fold Unit

By attaching Support Tray: Shift [A], more sheets can be stacked when delivering z-folded sheets to the shift tray, preventing premature full detection.

The sensor is located at the paper exit. During the installation, be careful not to remove the feeler.

2. Installation



Notes on Moving the Finisher

CAUTION

- When moving the finisher, move it together with the main machine linked to it. If you try to move only the finisher, it may fall down, causing injury.

Punch Unit PU3090 (D3FP)



- This Punch Unit is for the Booklet Finisher SR3290 / Finisher SR3280.

Accessory Check

No.	Description	Q'ty	Remarks
1	Side-to-side Detection Unit	1	
2	Registration Guide Plate	1	
3	Hopper	1	
4	Punch Unit	1	
5	Punch Unit Movement Motor Unit	1	
6	Cover	1	
7	Tapping Screw- M3×6	9	



Installation Procedure

CAUTION

- When installing this option, turn OFF the main power and unplug the power cord from the wall socket. If installing without turning OFF the main power, an electric shock or a malfunction may occur.

2. Installation

1. Remove the rear upper cover [A] and the rear lower cover [B].



2. For 2000-sheet booklet finisher, remove the cover [A] of the booklet finisher unit.



3. Remove the inner cover [A] ( ×3,  ×1)



- There is a connector on the back of the inner cover.



4. Remove the punch guide plate [A]

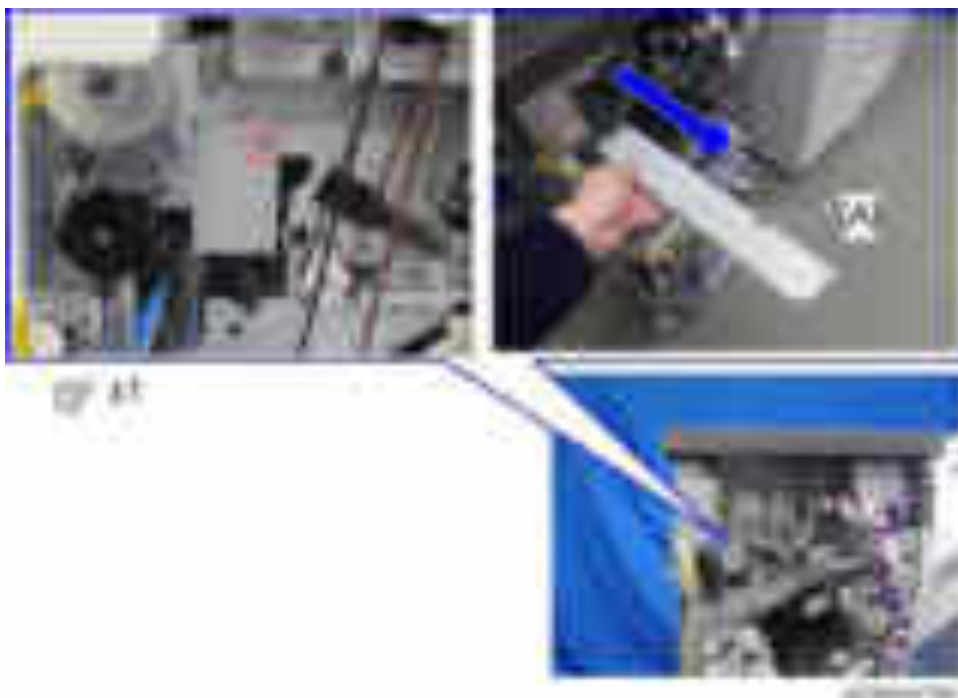

5. Attach the registration guide plate [A]. ( ×2)



[A]: Rear, [B]: Front



2. Installation



6. Attach the side-to-side detection unit [A]. (1x)

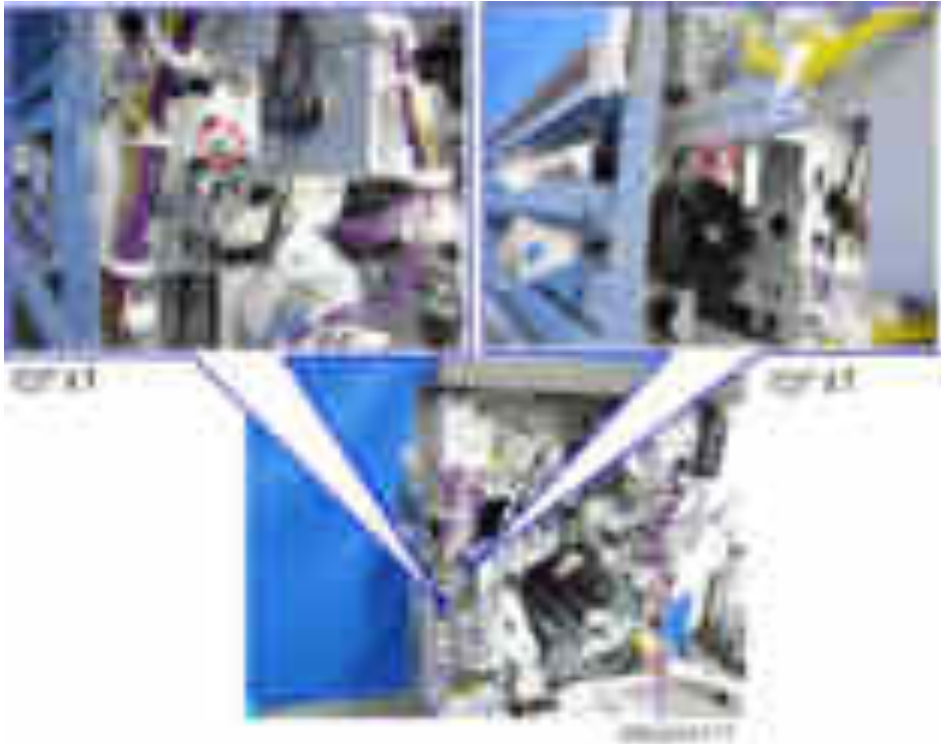

- Insert the front pins of the side-to-side detection unit into the holes of the frame.



7. Attach the punch unit [A]. (2x)



- After inserting the pins [B] of the punch unit stay into the front and rear holes of the punch

unit, fix the punch unit with two screws.



- Rear

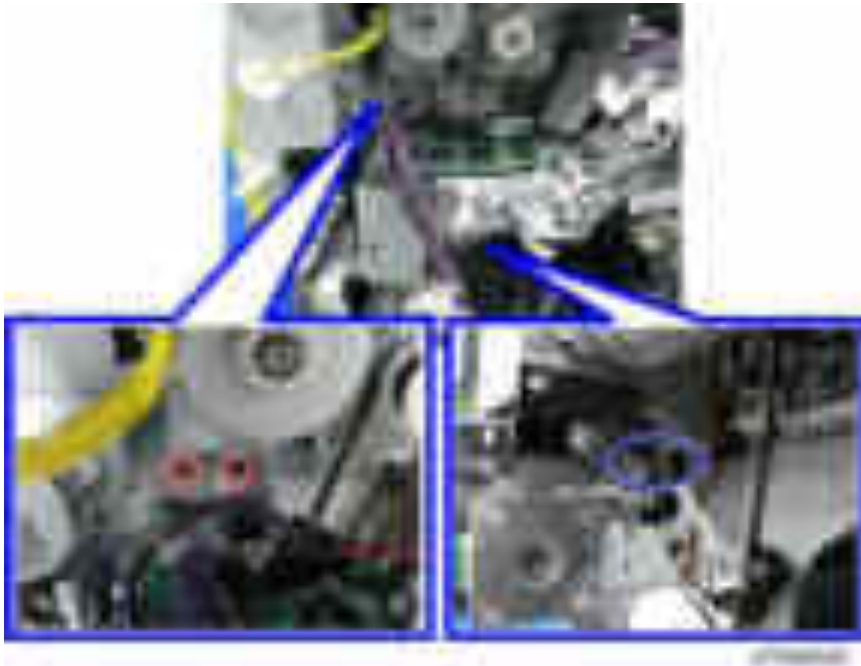

- Front



2. Installation

8. Attach the punch unit movement motor unit [A]. ( ×2)

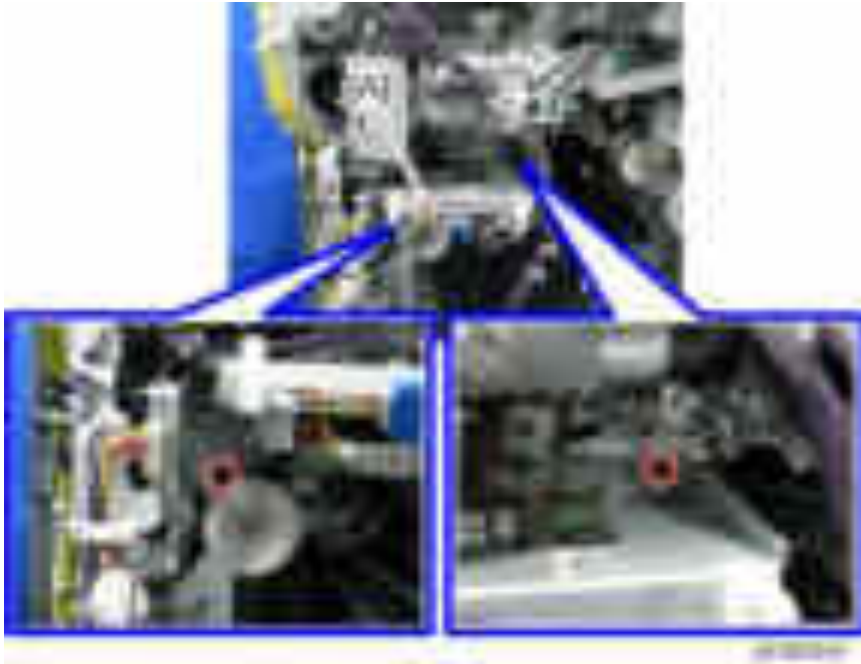

- Engage the gear [B] of the punch unit movement motor unit with the rack [C] of the punch unit.



9. At the rear part of the finisher, release the clamped harness.

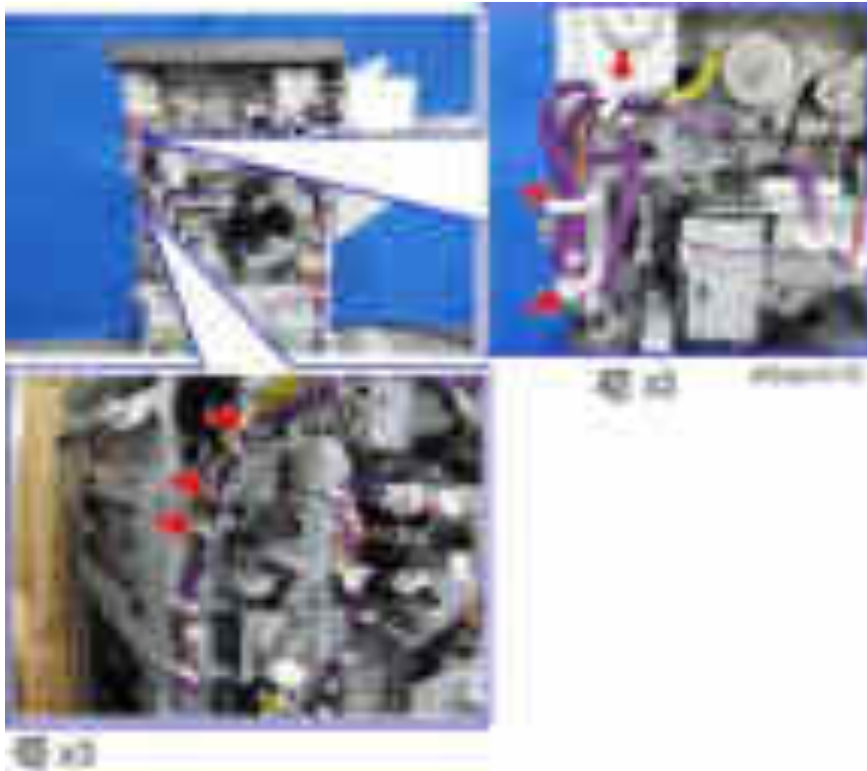

10. Route the harness and connect it to the punch unit board as shown below.



11. Pull out the harness clamped (with 3 pins) to the finisher, and then connect it to the relay connector

2. Installation

at the bottom of the side-to-side detection unit.

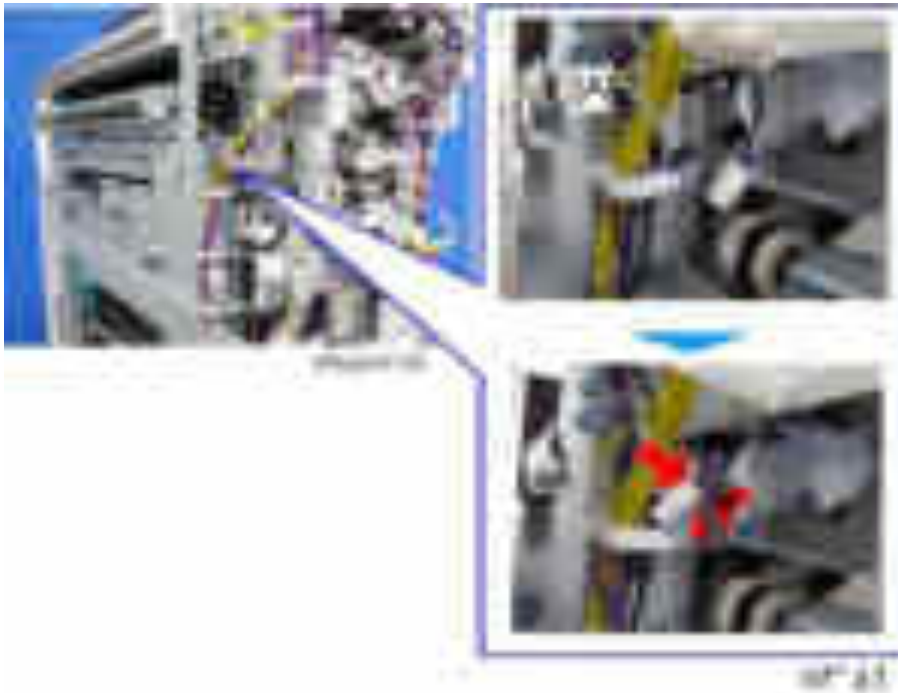

- 12.** Route the connector [A] of the punch unit movement motor unit as shown below, and then connect it to the punch unit board.
- 13.** Unclamp the connector [A] of the side-to-side detection unit, and then connect it to the relay connector.



- 14.** Route the long harness connector [A] as shown below, and then connect it to the punch unit board.

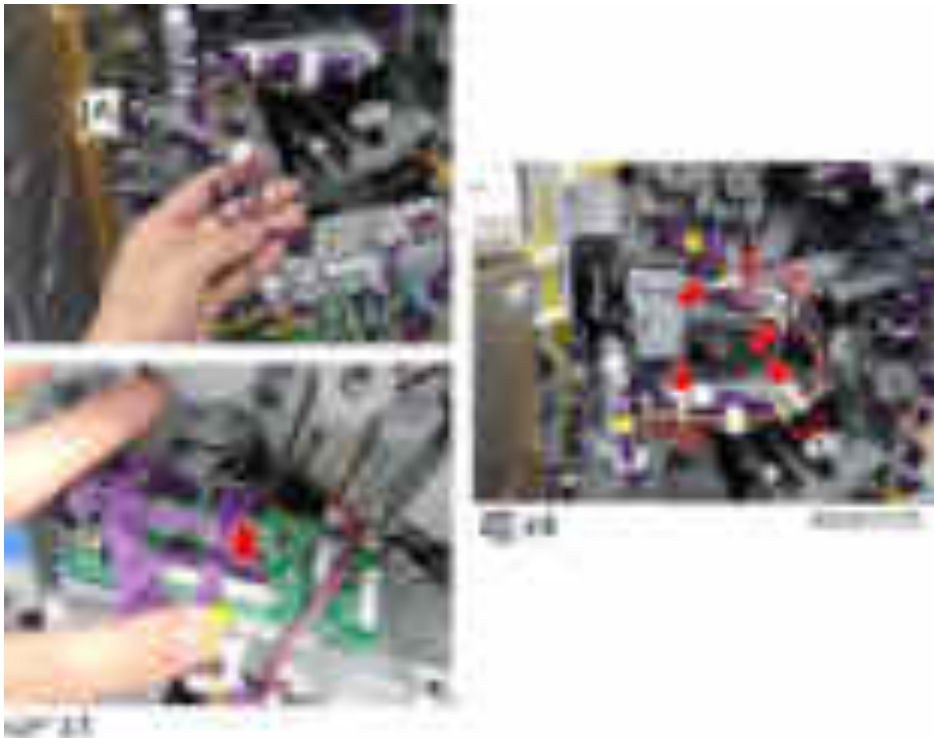

- 15.** After connecting all the harnesses, check that the cable tie has been applied to the following positions next to the clamps.



2. Installation

16. Attach the supplied cover [A] to the punch unit board.



17. Attach the hopper [A].



18. Attach the rear upper cover, the rear lower cover, the inner cover.

Booklet Finisher SR3270 (D3FQ)



- To attach this optional unit, the following optional units are required.
 - Bridge Unit BU3090 or Internal Multi-Fold Unit FD3010
 - LCIT PB3290 or Paper Feed Unit PB3300/Paper Feed Unit PB3280

Accessory Check

No.	Description	Q'ty	Remarks
1	Shift Tray	1	
2	Booklet Tray	1	
3	Joint Bracket	1	
4	Relay Guide Plate	1	
5	Cushion	1	
6	Tapping screws - M3 × 6	4	
7	Tapping screw - M4 × 8	1	
8	Screws - M4 × 12	4	
9	Ground Plate	1	
10	Proof Support Tray	1	
11	Stabilizer	1	



Installation Procedure



- When installing this option, turn OFF the main power and unplug the power cord from the wall

2. Installation

socket. If installing without turning OFF the main power, an electric shock or a malfunction may occur.

- This finisher is light and has a high center of gravity, so it easily topples when installing or moving it. Therefore, it is equipped with the stabilizer [A] attached to the left side of the finisher when shipped.



- 1.** After unpacking, immediately attach the stabilizer [A] to prevent toppling. Push it in thoroughly along the guide until it clicks.



- 2.** Remove the packing tapes and retainers, and then remove the accessories (screws, etc.).
- 3.** Open the front cover, and then remove the packing tapes and packing materials.

- 4.** Remove the fixing bracket [A].



- 5.** Pull out the saddle stitch unit, and remove the packing taps and packing materials.



- 6.** Attach the shift tray [A] (1 × 1 : M4 × 8).



2. Installation

7. Attach the booklet tray [A].



8. Attach the relay guide plate in the following procedure.

1. Temporarily attach the screw on the front side (3x6).



2. Hook the relay guide plate [A] on the screw attached in step 1, then fully tighten the screw on the rear side (3x6).

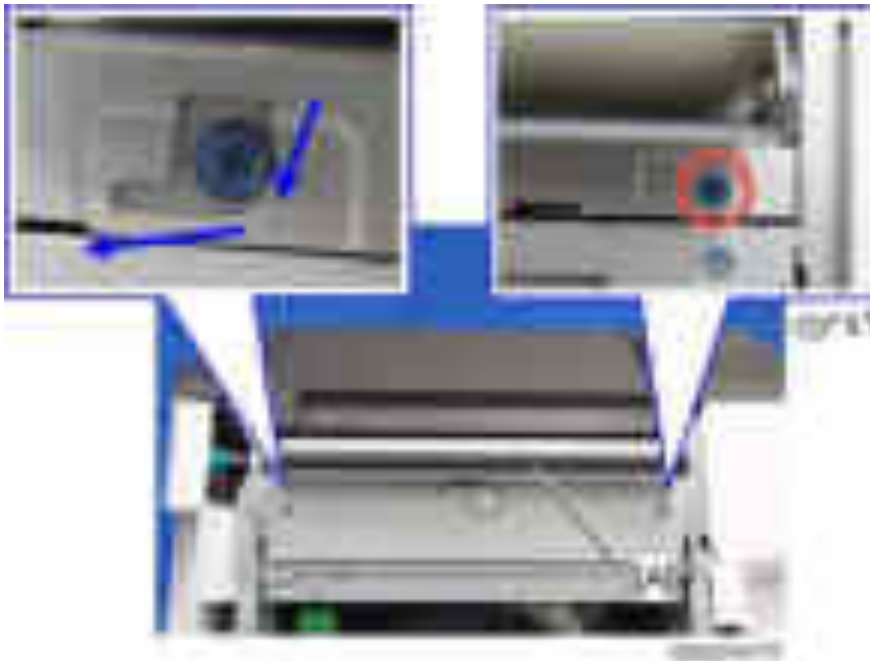

3. Fully tighten the screw on the front side.

9. Clean the right side of the upper cover with a cloth moistened with alcohol, and then attach the

cushion [A] to the finisher.

Make sure that the cushion is aligned with the guide rib of the upper cover.

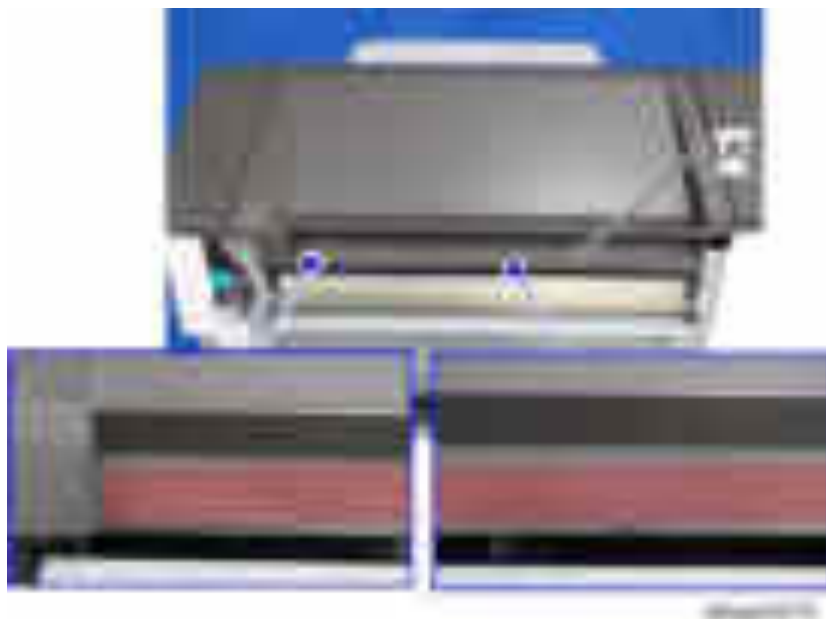

Important

If the internal multi-fold unit is installed on the main machine, cut off the section of the cushion indicated by the notch so that the cushion does not interfere with the I/F connector [A] of the finisher.

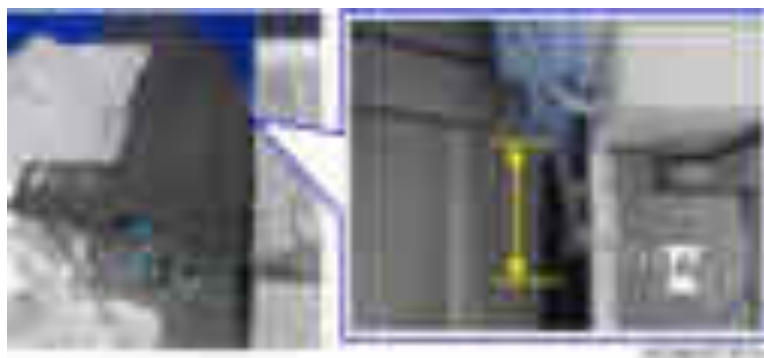

10. Attach the ground plate [A] (3x6).



11. Attach the joint bracket [A] to the machine in the following procedure.

2. Installation

1. Temporarily attach the screws on the lower screw holes (4x12).

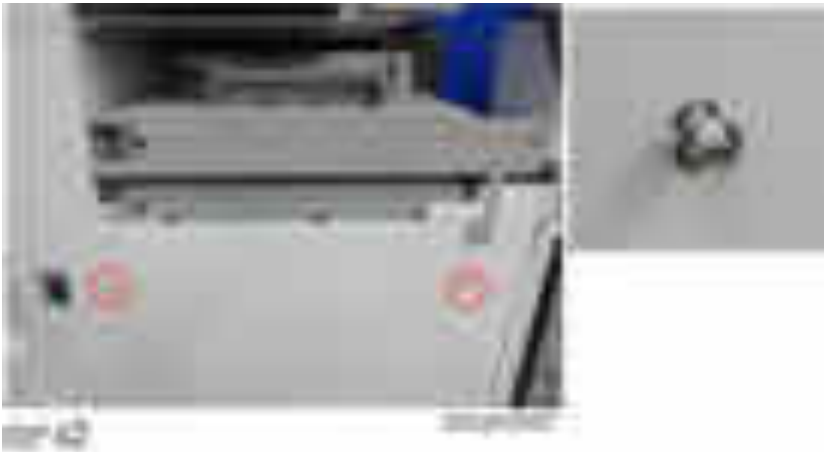

2. Hook the joint bracket [A] on the screws attached in step 1, then adjust the position so that the screw head comes to the center mark of the scale.



3. Fully fix the joint bracket (4x12).
Tighten the joint bracket and bracket [A] of the bridge unit together.

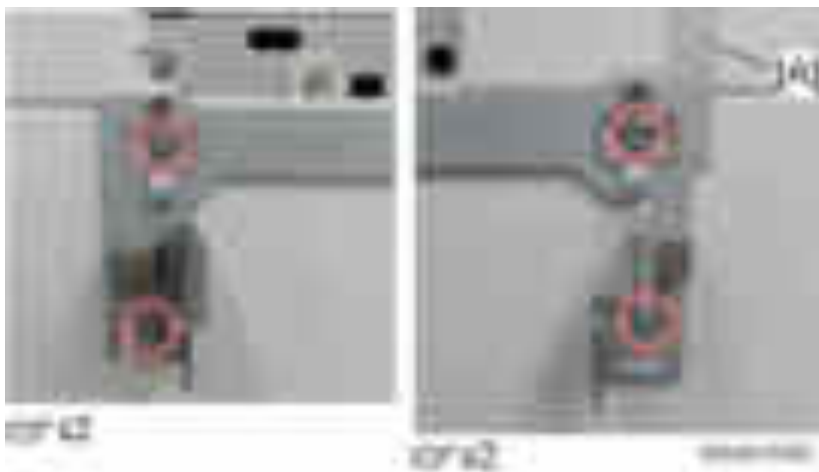

12. Remove the connector cover [A] on the right side of the main machine.

When the Internal Multi-Fold Unit FD3010 is installed, it is not necessary to remove this cover.



13. When the Internal Multi-Fold Unit FD3010 is installed, connect the finisher cable to the connector on the internal multi-fold unit.



2. Installation

- 14.** Remove the screw on the connection lever [A] and pull the lever.



- 15.** Connect the finisher to the main unit, and then push in the connection lever [A] to fasten it to the main unit. (x1)



When the Internal Multi-Fold Unit FD3010 is installed, make sure that the finisher's 2 cables are not crossing each other before you connect the finisher.



- 16.** When the bridge unit is installed, connect the interface cable to the machine.



- 17.** Attach the tray holder [A].



- 18.** Close the front cover.
19. Turn ON the main power.
20. Deliver some A3/DLT paper to the proof tray and check if the vertical registration is correct according to the adjustment scale for A3/DLT paper ([Side-to-side Registration Error \(Finisher Registration Adjustment\)](#)).
21. Check that the finisher can be selected on the operation panel, and check the finisher's operation.

Attaching the Proof Support Tray

When using B4 or larger paper, paper that bends easily, or paper with its grain direction perpendicular to the paper feed direction, the sheet may become curled, resulting in premature full detection by the proof full detection sensor.

2. Installation



This can be solved by attaching the proof support tray [B] on the proof tray [A].



The problem that may occur after attaching this support tray:

When printing A4, LT or smaller paper with the support tray, the machine stacks only 200 sheets, which is less than the standard specification of 250 sheets.

When printing B4, LG or larger paper with the support tray, the machine stacks 50 sheets, which is the same as the standard specification.

Notes on Moving the Finisher

CAUTION

- When moving the finisher, move it together with the main machine linked to it. If you try to move only the finisher, it may fall down, causing injury.

Finisher SR3260 (D3FR)



- To attach this optional unit, the following optional units are required.
 - Bridge Unit BU3090 or Internal Multi-Fold Unit FD3010
 - LCIT PB3290 or Paper Feed Unit PB3300/Paper Feed Unit PB3280

Accessory Check

No.	Description	Q'ty	Remarks
1	Joint Bracket	1	
2	Cushion	1	
3	Relay Guide Plate	1	
4	Shift Tray	1	
5	Ground Plate	1	
6	Stabilizer	1	This part must be attached to the finisher just after it is taken out of the shipping box.
7	Tapping screws - M3 × 6	4	
8	Screws - M4 × 12	4	
9	Tapping screw - M4 × 8	1	
10	Proof Support Tray	1	



Installation Procedure



- When installing this option, turn OFF the main power and unplug the power cord from the wall

2. Installation

socket. If installing without turning OFF the main power, an electric shock or a malfunction may occur.

- This finisher is light and has a high center of gravity, so it easily topples when installing or moving it. Therefore, it is equipped with the stabilizer [A] attached to the left side of the finisher when shipped.



- 1.** After unpacking, immediately attach the stabilizer [A] to prevent toppling. Push it in thoroughly along the guide until it clicks.



- 2.** Remove the packing tapes and retainers, and then remove the accessories (screws, etc.).
- 3.** Open the front cover, and then remove the packing tapes and packing materials.





4. Remove the fixing bracket [A] of the stapleless stapler unit.

1. Remove the fixing screws.



2. Pull out the bracket from the insertion part (marked in blue). (The bracket has been inserted into the stapleless stapler unit for alignment.)



2. Installation

3. Pull out the bracket from the gap in the finisher's frame.



5. Attach the shift tray [A] (×1: M4 × 8).



6. Attach the relay guide plate in the following procedure.

1. Temporarily attach the screw on the front side (3x6).



2. Hook the relay guide plate [A] on the screw attached in step 1, then fully tighten the screw on

the rear side (3x6).

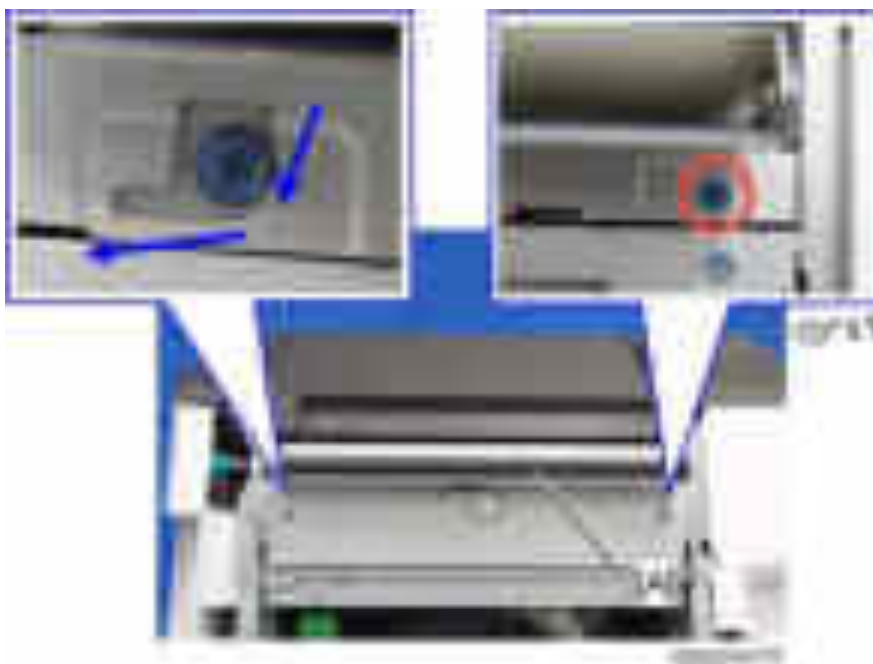

3. Fully tighten the screw on the front side.

- 7.** Clean the right side of the upper cover with a cloth moistened with alcohol, and then attach the cushion [A] to the finisher.

Make sure that the cushion is aligned with the guide rib of the upper cover.

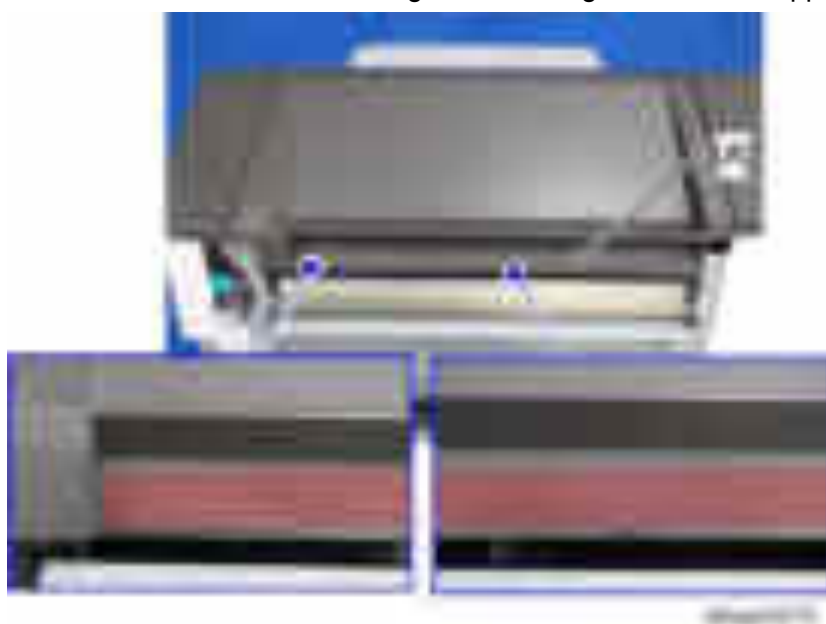

If the internal multi-fold unit is installed on the main machine, cut off the section of the cushion indicated by the notch so that the cushion does not interfere with the I/F connector [A] of the finisher.

2. Installation

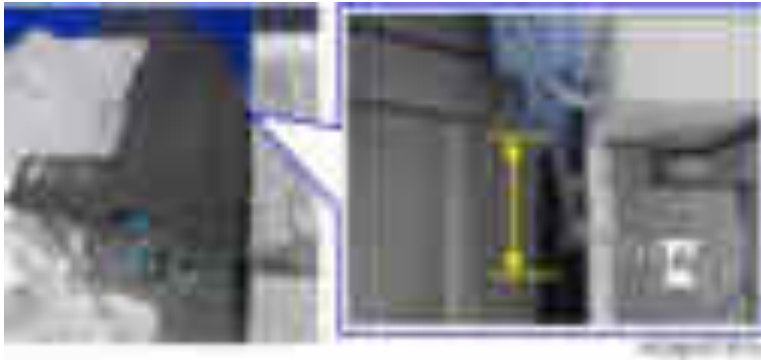

- 8.** Attach the ground plate [A] (3x6).



- 9.** Attach the joint bracket to the machine in the following procedure.
1. Temporarily attach the screws on the lower screw holes (4x12).

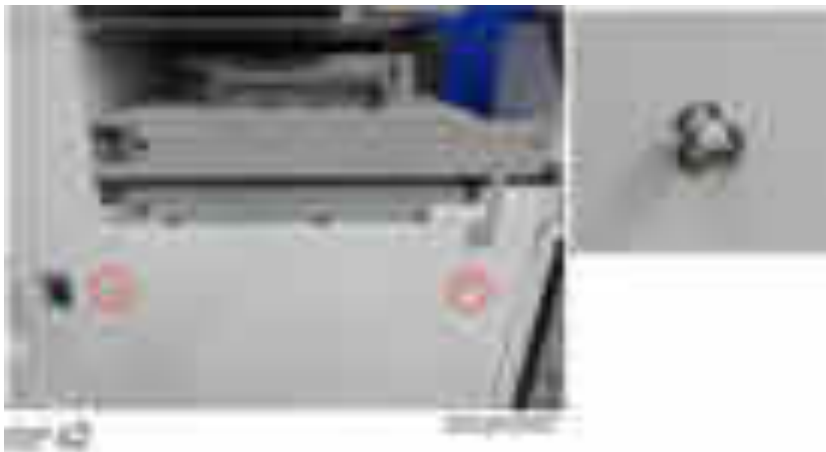

2. Hook the joint bracket [A] on the screws attached in step 1, then adjust the position so that the

screw head comes to the center mark of the scale.



3. Fully fix the joint bracket (4x12).
Tighten the joint bracket and bracket [A] of the bridge unit together.

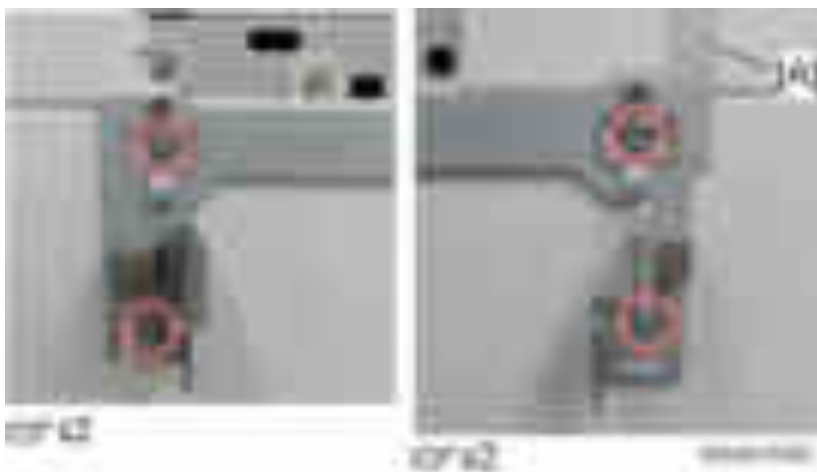

- 10.** Remove the connector cover [A] on the right side of the main machine.
When the Internal Multi-Fold Unit FD3010 is installed, it is not necessary to remove this cover.

2. Installation



- 11.** When the Internal Multi-Fold Unit FD3010 is installed, connect the finisher cable to the connector on the internal multi-fold unit.



- 12.** Remove the screw on the connection lever [A] and pull the lever.



- 13.** Connect the finisher to the main unit, and then push in the connection lever [A] to fasten it to the

main unit. (x1)



When the Internal Multi-Fold Unit FD3010 is installed, make sure that the finisher's 2 cables are not crossing each other before you connect the finisher.



14. When the bridge unit is installed, connect the interface cable to the machine.



15. Attach the tray holder [A].



2. Installation

- 16.** Close the front cover.
- 17.** Turn ON the main power.
- 18.** Deliver some A3/DLT paper to the proof tray and check if the vertical registration is correct according to the adjustment scale for A3/DLT paper ([Side-to-side Registration Error \(Finisher Registration Adjustment\)](#)).
- 19.** Check that the finisher can be selected on the operation panel, and check the finisher's operation.

Attaching the Proof Support Tray

When using B4, LG or larger paper, or when using limp paper, the sheet may become kinked, resulting in premature full detection.



This can be solved by attaching the proof support tray [B] on the proof tray [A].



The problem that may occur after attaching this support tray:

When using A4, LT or smaller paper, the machine will detect when the tray is full at 200 sheets instead of the normal 250 sheets.

When using B4, LG or larger paper, the machine detects when the tray is full at 50 sheets as usual.

Stapleless Stapler Initial Settings

If you replace this finisher with one that has a stapleless staple unit, the saved settings such as [Stapling Method for Stapleless Stapler] will not be transferred and the settings must be configured again.



- To adjust the strength of the crimp between sheets of stapled paper, there is a setting to select either single or double stapling.
- The crimp is weakened when there is an image (toner) at the point which is to be stapled. There also is a setting to mask the image on the point for stapling, in order to prevent the crimp from being weakened.
- Depending on users demands, explain the settings/methods of the settings by checking the following instructions.

How to Change the Setting of Staple Method for Stapleless Stapler

1. Press the [Settings] icon on Home screen.
2. Press [Machine Features Settings] > [System Setting] > [General Setting] > [Stapling Method for Stapleless Stapler].
3. Select [Double] or [Single].



How to Set Margin Erase for Stapleless Stapler

1. Press the [Settings] icon.
2. Press [Machine Features Settings] > [System Setting] > [General Setting].
3. Press [Erase Margin for Stapleless Stapler].



2. Installation

Notes on Moving the Finisher

CAUTION

- When moving the finisher, move it together with the main machine linked to it. If you try to move only the finisher, it may fall down, causing injury.

Punch Unit PU3080 (D3G5)



- This Punch Unit is for the Booklet Finisher SR3270 / Finisher SR3260.

Accessory Check

No.	Description	Q'ty	Remarks
1	Side-to-side detection unit	1	
2	Guide plate	1	
3	Hopper	1	
4	Punch unit	1	
5	Punch unit movement motor unit	1	
6	Cover	1	
7	Tapping screws - M3 × 6	9	



Installation Procedure

CAUTION

- When installing this option, turn OFF the main power and unplug the power cord from the wall socket. If installing without turning OFF the main power, an electric shock or a malfunction may occur.

- 1.** Take out of the shipping box, and remove the packing tapes and shipping retainers.
- 2.** Pull out the finisher interface cable, and move it away from the machine.

2. Installation

- 3.** Remove the finisher rear cover [A] (④×3).



- 4.** Open the top cover, and then remove the arms.



- 5.** Remove the top cover [A].

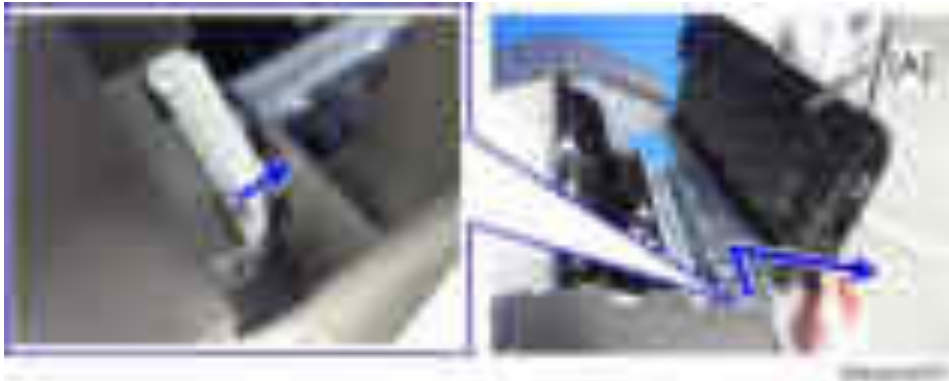

- 6.** Cut off part of the finisher inner cover.



7. Remove the guide plate [A].

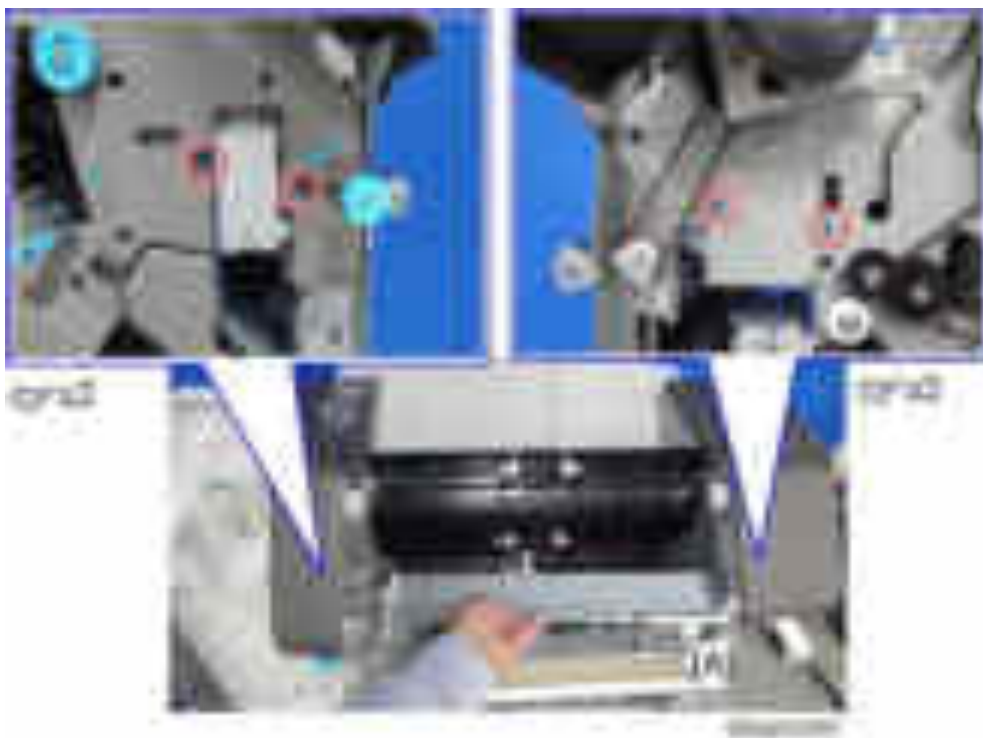

8. Insert and attach the guide plate [A] from the rear.

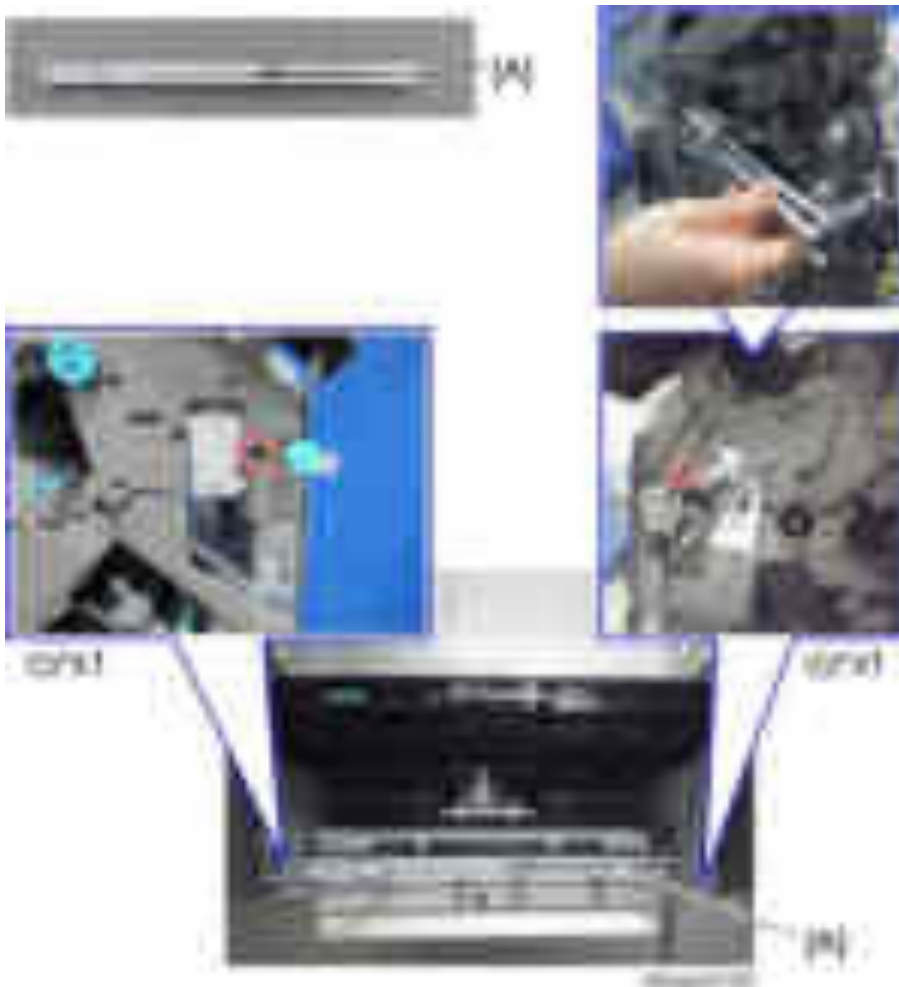

2. Installation

- 9.** Insert and attach the side-to-side detection unit [A] from the rear.

*Front: The two shafts of the unit are passed through bearings in the finisher.

In the following figure, the inner cover has been removed so that the bearings' position can be seen. The inner cover is actually not removed.

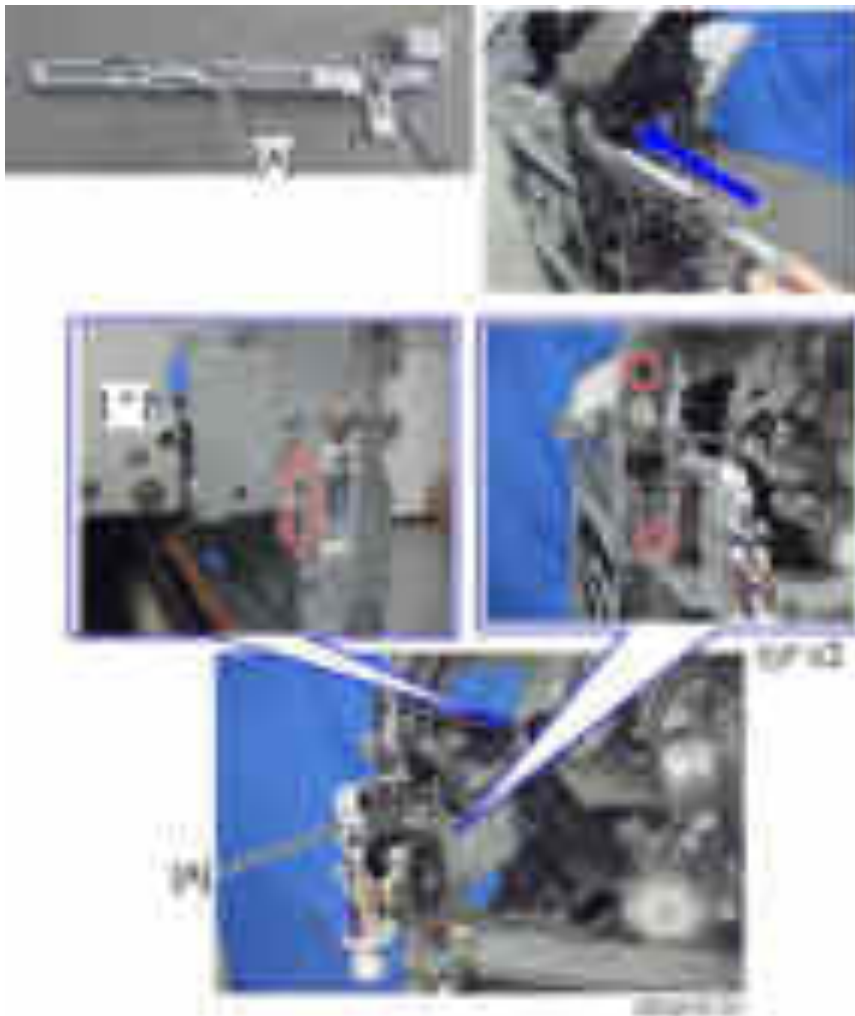

- 10.** Connect the harness at the bottom part of the side-to-side detection unit to the connector on the finisher.



11. Insert and attach the punch unit [A] from the rear.



12. Attach the punch unit movement motor unit [A] so that the gear [B] meshes firmly (×2).

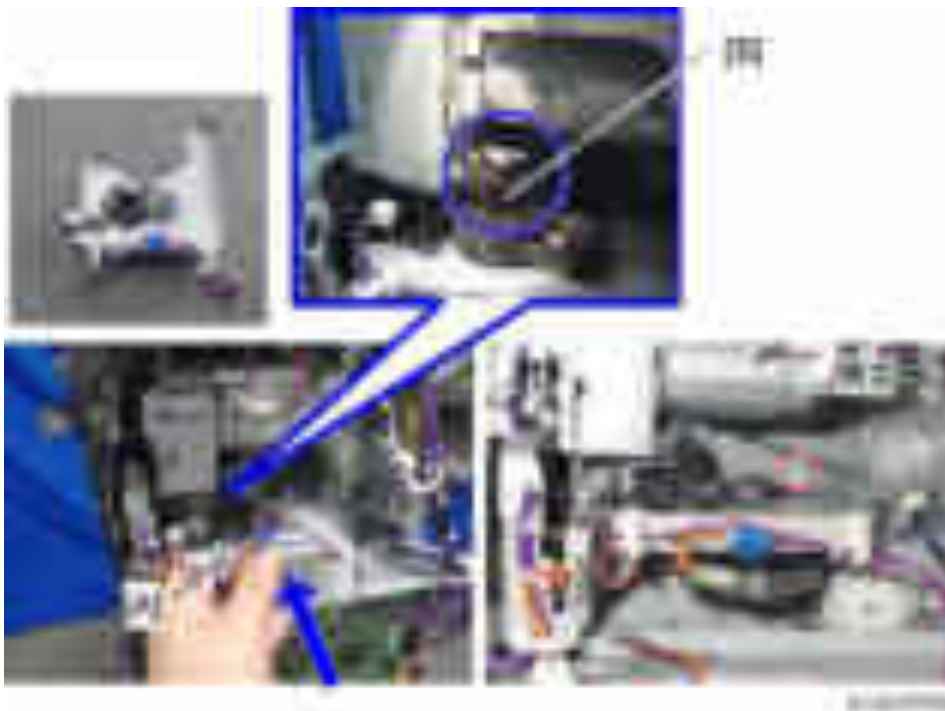

13. Insert the hopper [A].

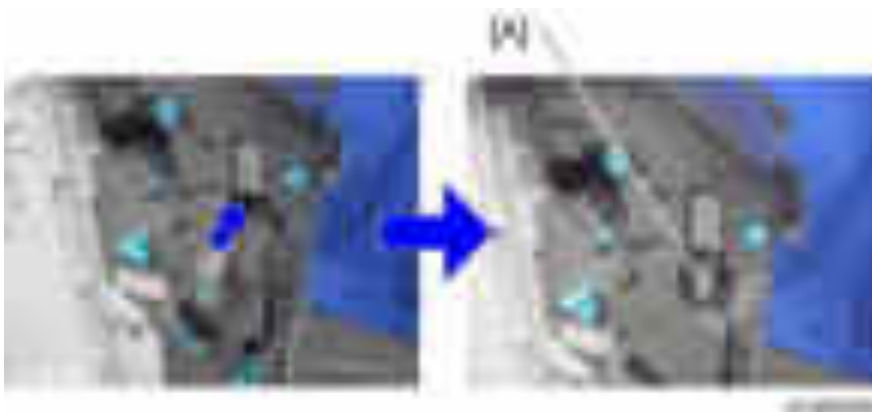

14. Connect the harnesses in the following procedure.

2. Installation

1000-sheet Booklet Finisher

1. Unclamp the harness [A] at the rear part, route the connector through the top part and then clamp it.



2. Route the harness as shown below.



3. Connect the harness to the punch unit board.



4. Route the harness [A] of the punch unit movement motor unit, and then connect it to the punch unit board.

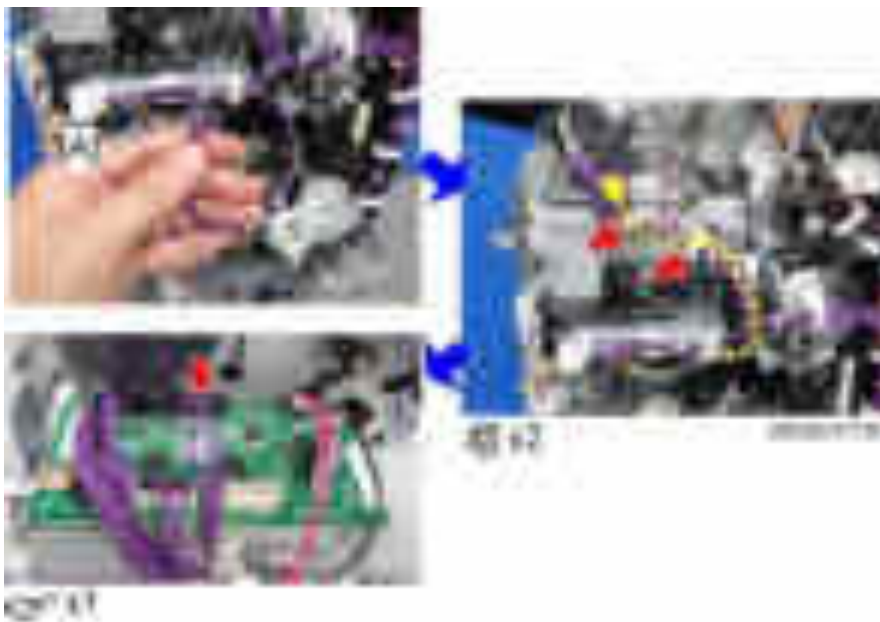

2. Installation

5. Release the harness of the side-to-side detection unit, and then route it as shown below.

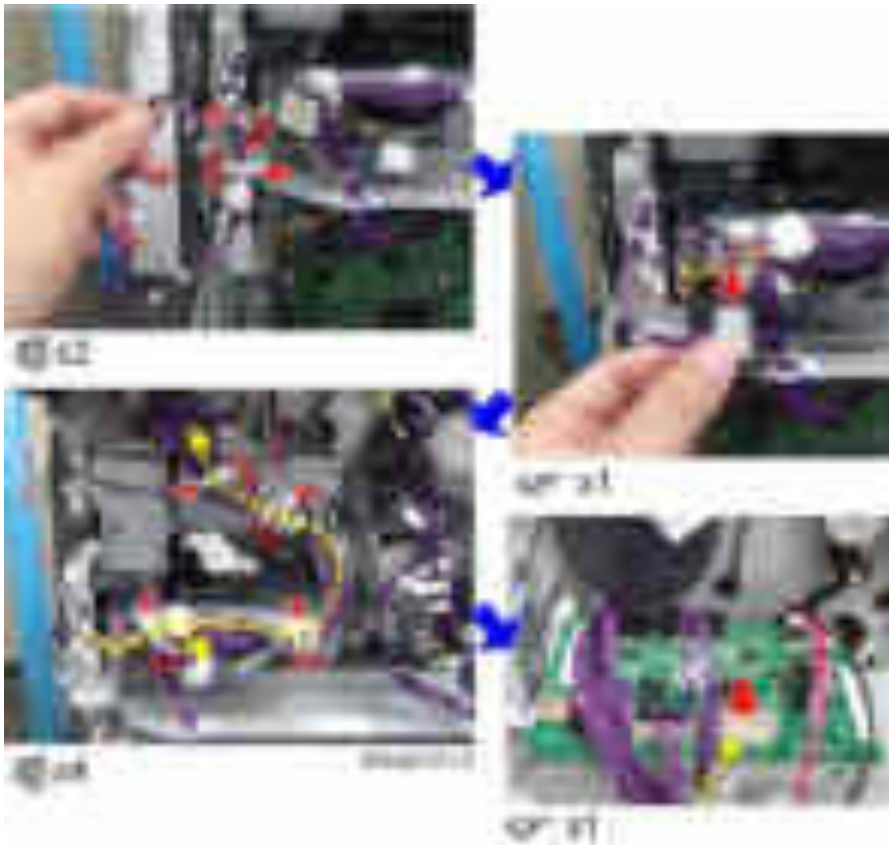

1000-sheet Finisher

1. Release the harnesses clamped at the rear part of the finisher.



2. Route the harness as shown below.



3. Connect the harness to the punch unit board.



4. Route the harness [A] of the punch unit movement motor unit, and then connect it to the punch unit board.

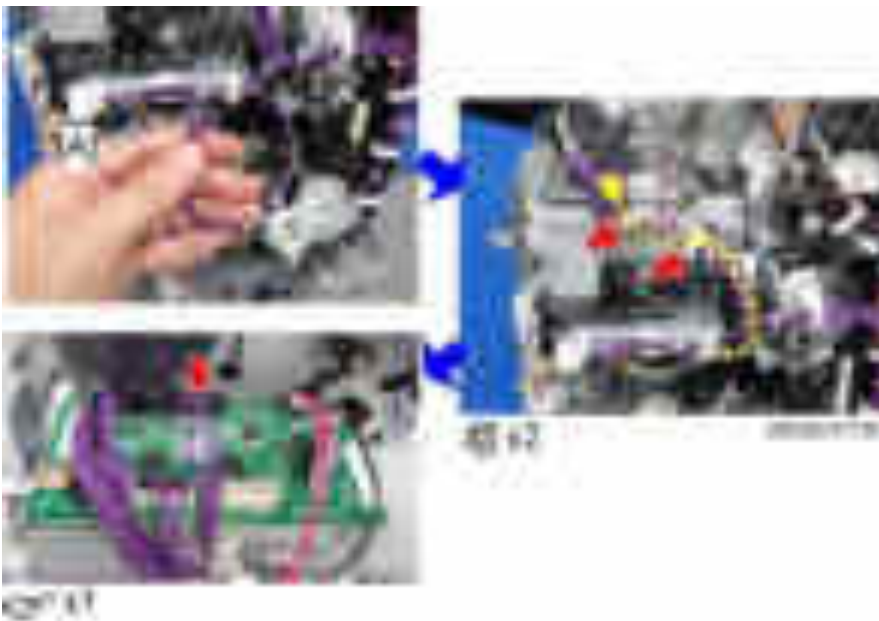

2. Installation

5. Release the harness of the side-to-side detection unit, and then route it as shown below.

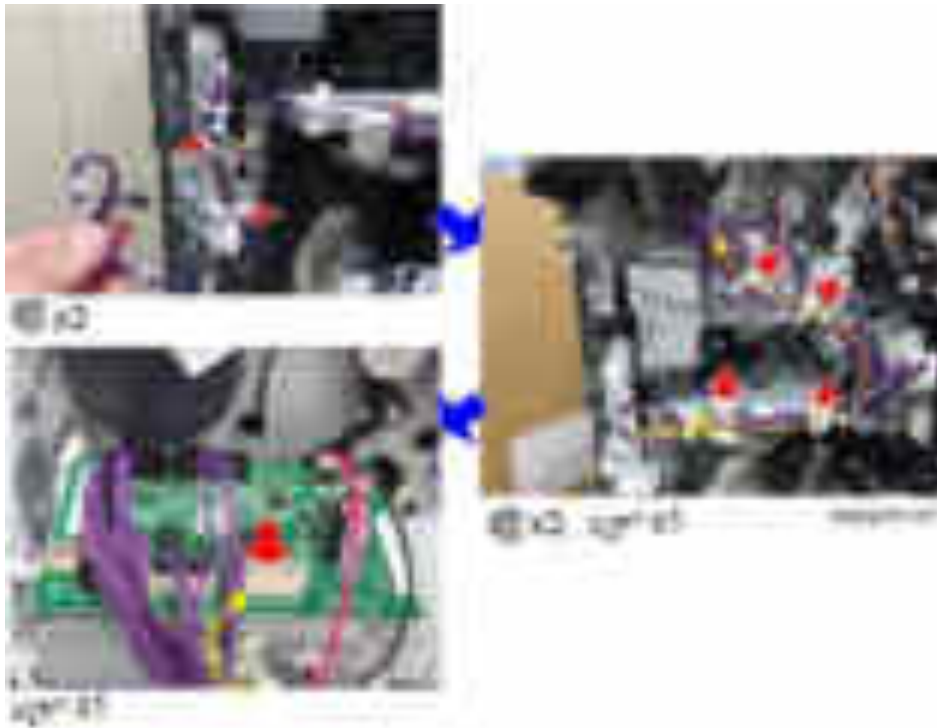

- 15.** After connecting all the harnesses, check that the cable tie has been applied to the following positions next to the clamps.

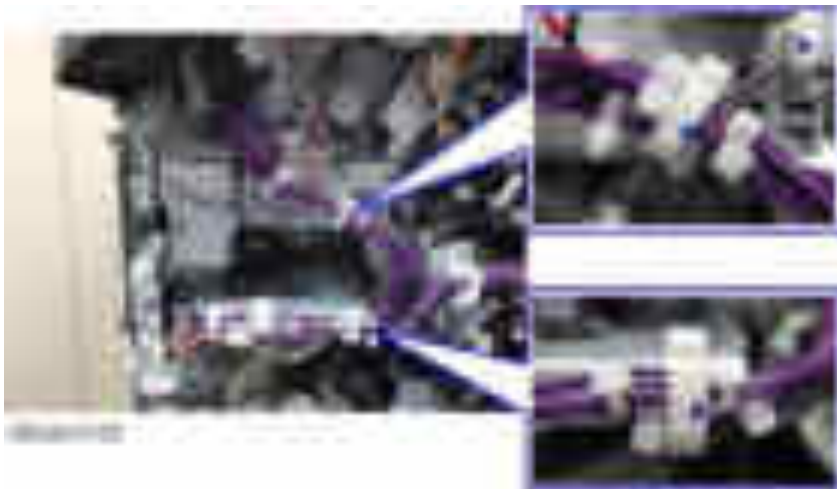

- 16.** Attach the supplied cover [A] to the punch unit board.



- 17.** Reattach the covers that you removed.
18. Close the front cover.
19. Reconnect the finisher to the machine, and connect the interface cable.
20. Turn ON the main power.
21. Check that the punch can be selected at the operation panel, and check the operation.

Internal Finisher SR3250 (D3FG)

Accessory Check

No.	Description	Q'ty	Remarks
1	Stabilizer	2	
2	Front Right Cover	1	
3	Left Lower Cover	1	
4	Entrance Guide Plate	1	Not used when the punch unit is attached.
5	Staple Cartridge	1	
6	Bottom Plate	1	
7	Paper Support Guide	1	
8	Driven Roller (Flat)	1	
9	Tapping Screw – M4 x 6	1	
10	Screw - M3 × 6	6	
-	Decal - EMC Address	1	
-	Notes on Installing the Optional Unit	1	



Installation Procedure

CAUTION

- When installing this option, turn OFF the main power and unplug the power cord from the wall socket. If installing without turning OFF the main power, an electric shock or a malfunction may occur.

Note

- This option cannot be used together with the following peripherals:
 - Internal Shift Tray SH3080 (D3FV)
 - Bridge Unit BU3090 (D3FW)
 - Internal Finisher SR 3300 (D3FT)
 - Side Tray Type M37 (D3FX)
 - Internal Multi-Fold Unit FD3010 (D3FS)
- To use together with the "Punch Unit PU3070", first attach the "Punch Unit PU3070" before installing this option.

- 1.** Remove the packing tapes and retainers, and then remove the accessories (screws, etc.).
- 2.** Remove the paper exit tray [A].



- 3.** Remove the paper exit feeler [A].



2. Installation

- 4.** Tuck in the lever [A] for detecting when the tray is full.



- 5.** Open the front cover, and then remove the upper left cover [A].



- 6.** Remove the left rear cover [A].



- 7.** Remove the proximity sensor left cover [A].



- 8.** Remove the paper exit lower cover [A].



- 9.** Install a screw removed in step 8.
This protects your fingers from burrs of screw hole.



- 10.** While pressing the bottom plate [A] into the area shown by the blue circle [B], insert it into the slot shown by the blue circles [C] [D].



- The following procedure is the easiest way to set this bottom plate.
 - 1) Slip the bottom plate into the position in the blue circle [B].
 - 2) Insert the bottom plate into the hole in the blue circle [C].
 - 3) Hook the position [E] of the bottom plate with your index finger, and insert the bottom plate into the hole of the blue circle [D] while lifting it.

2. Installation

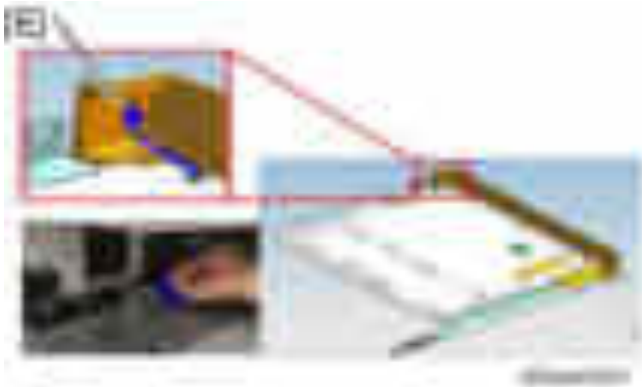
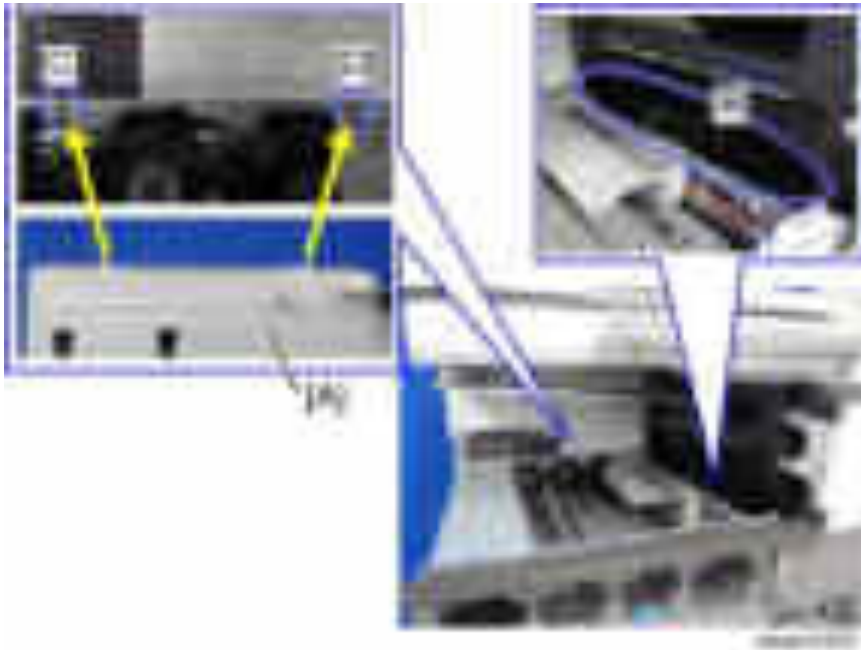

11. Attach the bottom plate [A] (M3×6).



12. Reattach the proximity sensor onto the left cover.

13. Remove the driven roller [B] at the machine's exit tray and attach the supplied driven roller [A].

- Insert a flathead screwdriver into the depression in the center, and then, lifting the driven roller, unlock the part indicated by the red arrow.
- When attaching the driven roller, push its center all the way in until it clicks.

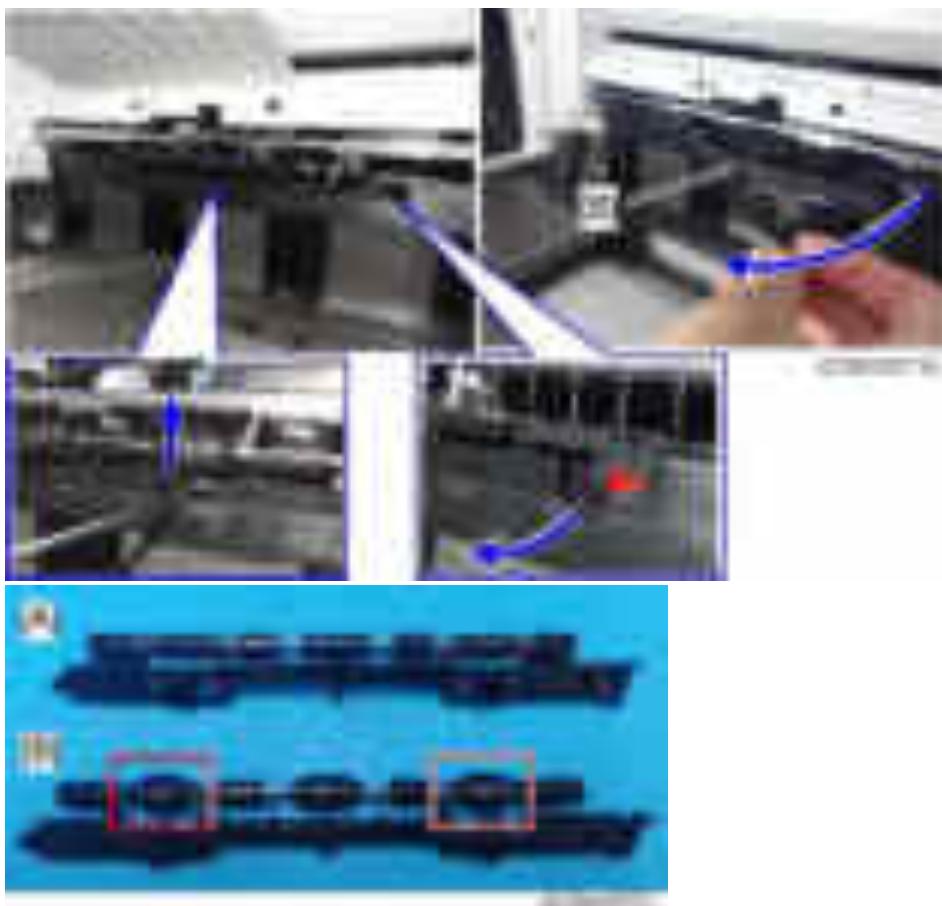

[A]: The supplied driven roller has flat rollers.

[B]: The machine's standard driven roller has drum-type rollers (as indicated by red frames).



The spring arm on the flat roller might be disconnected due to the vibration or shock. After attaching the roller, perform a visual check whether the state of assembly is normal or not.

[A]: Normal position, [B]: spring arm is disconnected.

2. Installation

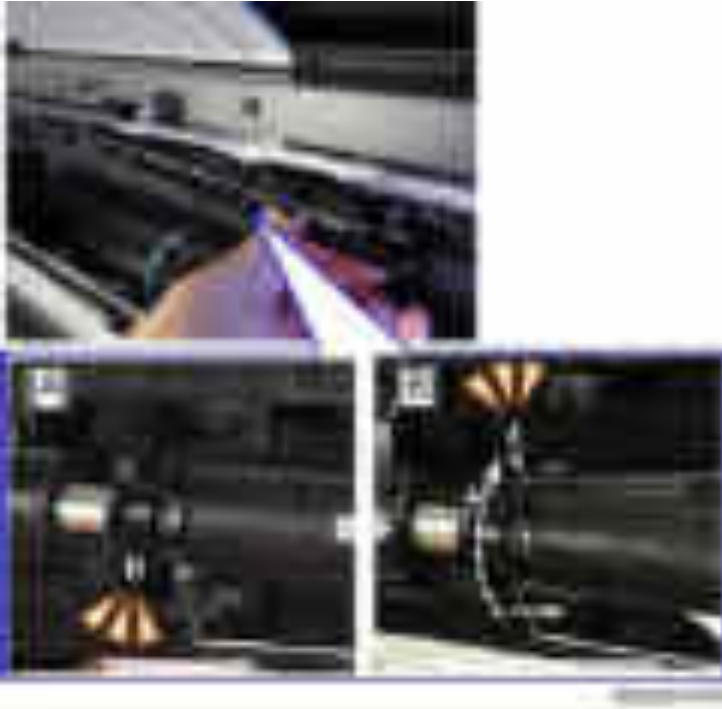

14. Attach the paper support guide [A] (Tab x4).



- Up to this point, the procedure is the same as punch unit installation (for fitting the punch unit, refer to Step 3 and later of the Punch unit installation procedure).

15. Slide the finisher front right cover [A] from left to right to attach it (M3x6).



16. Attach the entrance guide plate [B] to the finisher [A] (⊗×2: M3x6).



17. Slide the finisher [A] along the rail of the bottom plate from the left-hand side of the machine to attach it (⊗×1: M4x6).



18. Reattach the left rear cover.

19. Insert the upper left cover [A] from the front, and slide it to reattach it.
Use the screw removed in step 5.



20. Attach the stabilizers.



- Because the weight is biased to the right of the machine if the internal finisher is installed,

2. Installation

stabilizers are required on the left side. Because they are included with the finisher, install these stabilizers at the same time as you install the internal finisher.



21. Connect the interface cable to the machine.



- 22.** Move the stapler unit forward, then set the staple cartridge [A].



- 23.** Reinstall the stapler unit, and then turn ON the main power.
- 24.** Check that the finisher can be selected at the operation panel, and check the finisher operation.
Also when the punch unit is installed, check the punching operation.

2. Installation

Punch Unit PU3070 (D3FM)



- Punching unit for the Internal Finisher SR3250.

Accessory Check

No.	Description	Q'ty	Remarks
1	Hopper	1	
2	Lower Front Cover	1	
3	Lower Rear Cover	1	
4	Holder	1	
5	Tapping screws - M3x 6	3	
-	Decal - EMC Address	1	



Installation Procedure

CAUTION

- When installing this option, turn OFF the main power and unplug the power cord from the wall socket. If installing without turning OFF the main power, an electric shock or a malfunction may occur.



- To install together with the Internal Finisher SR3250, attach this option before installing the Internal Finisher SR3250.
 - If the Internal Finisher SR3250 is already attached, temporarily remove the Internal Finisher SR3250 to install this option.
- 1.** Remove the packing tapes and retainers, and then remove the accessories (screws, etc.).
 - 2.** Perform steps 1 to 14 of the installation procedure for the [Internal Finisher SR3250 \(D3FG\)](#), and further remove the following covers.

- Inverter Tray [A]



- Connector Cover [A]



- 3.** Remove the bracket [A] of the bottom plate.

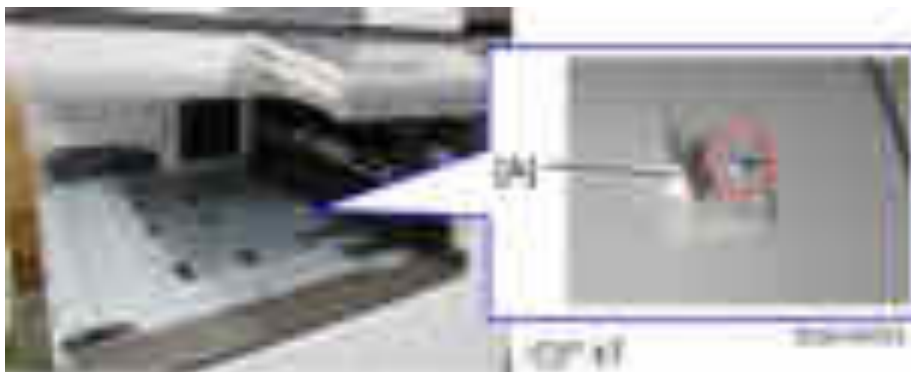

- 4.** Replace the lock holder of the bottom plate with the supplied lock holder [A].
Use the screw you removed the assembled lock holder.

2. Installation



5. Attach the proximity sensor left cover ().

6. Pass the shafts of the punch unit through the bearings of the bottom plate, and attach to the machine (×1, knob screw).

If it is difficult to insert by probing, look from the side while you insert it into the bearings of the bottom plate.



Lift the punch unit up and attach it so that the support plate [B] of the punch unit does not interfere with the front upper cover [A]. (If you attach the punch unit on the front upper cover without lifting it up, the front upper cover may be scratched).



7. Open the punch unit [A], and then fix it with the supplied screw (M3x6).



8. Attach the components [A] and [B] to the finisher (×2: M3x6).



9. When installing the punch unit in a finisher that is already installed, remove the relay guide plate [A] (×2).



- This step is unnecessary when installing the finisher and punch unit at the same time.

2. Installation

- 10.** Insert the hopper [A].



- 11.** Slide the finisher [A] along the rail of the bottom plate from the left-hand side of the machine to attach it (1x).



- 12.** Follow the installation procedure in “[Internal Finisher SR3250 \(D3FG\)](#)” from Step 18 to attach the finisher.

Internal Finisher SR3300 (D3FT)

Accessory Check

No.	Description	Q'ty	Remarks
1	Bottom Plate	1	
2	Left Lower Cover	1	
3	Paper Exit Tray	1	
4	TAPPING SCREW:3X8	2	
5	TAPPING SCREW:3X8	2	
6	TAPPING SCREW:3X8	2	
7	SCREW:M3X6	3	
8	TAPPING SCREW:3X6	1	
9	TAPPING SCREW:4X8	1	
10	Slide Rail	1	
11	Nylon Clamp	1	
12	Paper Support Guide	1	
13	Driven Roller (Flat)	1	



Installation Procedure

CAUTION

- When installing this option, turn OFF the main power and unplug the power cord from the wall socket. If installing without turning OFF the main power, an electric shock or a malfunction may occur.

2. Installation



- This option cannot be used together with the following peripherals:
 - Internal Shift Tray SH3080 (D3FV)
 - Bridge Unit BU3090 (D3FW)
 - Internal Finisher SR 3250 (D3FG)
 - Side Tray Type M37 (D3FS)
 - Internal Multi-Fold Unit FD3010 (D3FS)
- For using this option together with "1 Bin Tray BN3130", attach the bottom plate of this option at the beginning, then install the "1 Bin Tray BN3130", followed by installing this option.

- 1.** Remove the packing tapes and retainers, and then remove the accessories (screws, etc.).
- 2.** Remove the knob screw and red tag [A] (📄 x 1).



- 3.** Remove the shaft [B] from the slide rail [A] (📄 x 1).



- 4.** Remove the paper exit cover [A] (📄 x 2).



- 5.** Place the slide rail [A] under the internal finisher [B].



- 6.** Insert the shaft [A] into the holes located in the slide rail and internal finisher, and then fasten with the screw (x 1).



- 7.** Attach the paper exit cover (removed in step 4) [A] (x 2).



2. Installation

- 8.** Remove the paper exit tray [A].



- 9.** Remove the paper exit feeler [A].



- 10.** Tuck in the lever [A] for detecting when the tray is full.



- 11.** Open the front cover, and then remove the left upper cover [A].



12. Remove the left rear cover [A].



13. Remove the proximity sensor left cover [A].



14. Remove the paper exit lower cover [A].



- The lower inside cover can be removed together with the paper exit lower cover since the inside cover is secured on the paper exit lower cover with two screws.



2. Installation

15. Remove the lower inside cover [B] from the paper exit lower cover [A] (x 2).



16. Insert the bottom plate [A] into the holes.



You can easily install the plate as follows:

1. Evenly insert the bottom plate under the upper rear inner cover [B] from the front.



2. Installation

2. Check that the front resin part of the bottom plate and the paper exit cover are at this location.



3. Slightly lifting the front right part of the bottom plate, slide the front resin part of the bottom plate under the paper exit cover.



4. Pulling the bracket at the rear part slightly, engage the hook on the bottom plate with the hole in the side of the machine.



2. Installation

17. Install the bottom plate [A] (Accessory No. 7).



18. Install the lower inside cover (removed in step 15) [A] in the finisher (x 2, Accessory No.5).



19. Remove the driven roller [B] at the machine's exit tray and attach the supplied driven roller [A].

- Insert a flathead screwdriver into the depression in the center, and then, lifting the driven roller, unlock the part indicated by the red arrow.
- When attaching the driven roller, push its center all the way in until it clicks.





[A]: The supplied driven roller has flat rollers.

[B]: The machine's standard driven roller has drum-type rollers (as indicated by red frames).



The spring arm on the flat roller might be disconnected due to the vibration or shock. After attaching the roller, perform a visual check whether the state of assembly is normal or not.

[A]: Normal position, [B]: spring arm is disconnected.

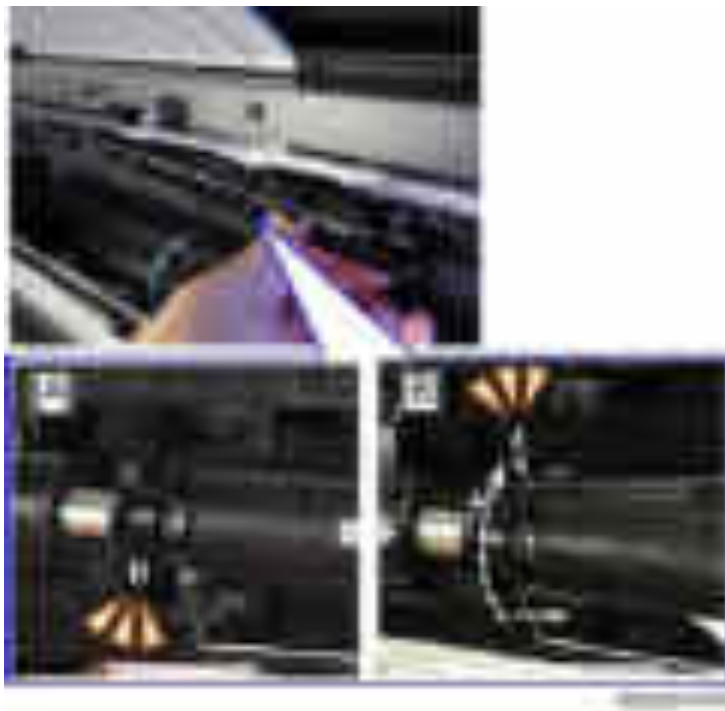

20. Attach the paper support guide [A] (Tab x 4).



2. Installation

21. Reattach the proximity sensor on the left cover.



22. Install the internal finisher [A].



23. Secure the finisher (x 1, Accessory No.8).



- 24.** Reattach the left upper cover [A] and left rear cover [B].



- 25.** Attach the left lower cover [A] (x 2, Accessory No.6).



- 26.** Attach the paper exit tray [A] (x 2, Accessory No.4).

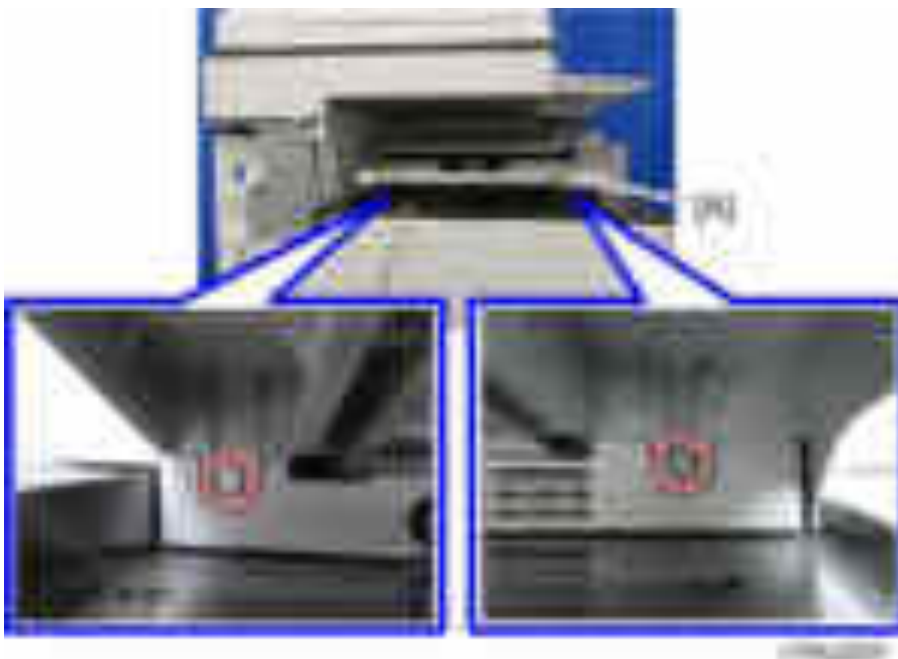

2.Installation

27. Remove the Connector cover [A] (Release the tab).



28. Connect the interface cable [A].



29. Attach the nylon clamp [A] as shown below (x 1, Accessory No.9).



30. Turn ON the main power.

31. Ensure that the operation panel displays finisher jobs properly and that it works properly.

Stapleless Stapler Initial Settings

If you replace this finisher with one that has a staple-free stapler unit, the saved settings such as [Stapling Method] will not be transferred and the settings must be configured again.



- To adjust the strength of the crimp between sheets of stapled paper, there is a setting to select

either single or double stapling.

- The crimp is weakened when there is an image (toner) at the point which is to be stapled. There also is a setting to mask the image on the point for stapling, in order to prevent the crimp from being weakened.
- Depending on users demands, explain the settings/methods of the settings by checking the following instructions.

How to Change the Setting of Staple Method for Stapleless Stapler

1. Press the [Settings] icon on Home screen.
2. Press [Machine Features Settings] > [System Setting] > [General Setting] > [Stapling Method for Stapleless Stapler].
3. Select [Double] or [Single].



How to Set Margin Erase for Stapleless Stapler

1. Press the [Settings] icon.
2. Press [Machine Features Settings] > [System Setting] > [General Setting].
3. Press [Erase Margin for Stapleless Stapler].



Internal Multi-Fold Unit FD3010 (D3FS)

Accessory Check

No.	Description	Q'ty	Remarks
1	Paper Exit Tray	1	
2	Bottom Plate	1	
3	Correction Plate for Side to side registration	1	
4	Coin Screw M4	1	
5	Screw M4x6	1	
6	Screw M3x6	1	
7	Bind Screw M3x6	3	
8	Coin Screw M4x8	4	
9	Paper Exit Guide (Relay)	1	Use this when connecting the finisher beyond the internal multi-fold unit.
10	Paper Relay Cover	1	
11	Left Upper Cover	1	Use this when connecting the finisher beyond the internal multi-fold unit.
12	Support Tray: Shift	1	Use this for the finisher shift tray.
13	Support Tray: Proof	1	Use this for the finisher proof tray.
14	Driven Roller (Flat)	1	
15	Paper Support Guide (Small)	1	
16	Cushion (Top/Front)	1	Not used for this machine.
17	Cushion (Rear)	1	
18	Cushion (Paper Entrance)	1	
19	Cushion (Short)	1	Not used for this machine.
-	Sheet (applying pressure to the folding roller)	1	
-	Sheet (attaching the paper support guide)	1	
-	Sheet (keeping the accessories)	1	
-	Sheet (about interference with the finisher's I/F cables)	1	



When installing the internal multi-fold unit alone

Use the paper exit tray [1] and the paper relay cover [10].

When connecting the finisher beyond the internal multi-fold unit

Use the paper exit guide (relay) [9] and the left upper cover [11].



The customer should keep the unused accessories included with the product. When connecting a finisher that was purchased separately or when disconnecting the finisher that is connected downstream from the internal multi-fold unit, if the customer did not keep the necessary accessories, order them as service parts.

Installation Procedure

CAUTION

- When installing this option, turn OFF the main power and unplug the power cord from the wall socket. If installing without turning OFF the main power, an electric shock or a malfunction may occur.



- This option cannot be used together with the following peripherals:
 - Internal Shift Tray SH3080 (D3FV)
 - Bridge Unit BU3090 (D3FT)
 - Internal Finisher SR 3300 (D3FT)
 - Internal Finisher SR 3250 (D3FG)
 - Side Tray Type M37 (D3FX)

2. Installation

1. Unpack the internal multi-fold unit [A].

Hold the parts circled in blue. Do not hold other parts. Doing so may damage exterior cover or deform the frame. (Note: The actual packaging tape is blue.)



2. Remove the packing tapes and retainers, and then remove the accessories (screws, etc.).



- There are 2 mylar sheets inside, so be sure to remove them.



Make sure to remove the tape fixing the joint bracket [A].



- 3.** Remove the proximity sensor left cover [A].



- 4.** Remove the paper exit feeler [A].
The removed paper exit feeler can be discarded.



- 5.** Tuck in the lever [A] for detecting when the tray is full.



- 6.** Remove the paper exit tray [A].

2. Installation



7. Remove the connector cover [A].



8. Remove the upper left cover [A] by pulling it towards the front.



9. Remove the left rear cover [A].



- 10.** Remove the driven roller [B] at the machine's exit tray and attach the supplied driven roller [A].
- Insert a flathead screwdriver into the depression in the center, and then, lifting the driven roller, unlock the part indicated by the red arrow.
 - When attaching the driven roller, push its center all the way in until it clicks.

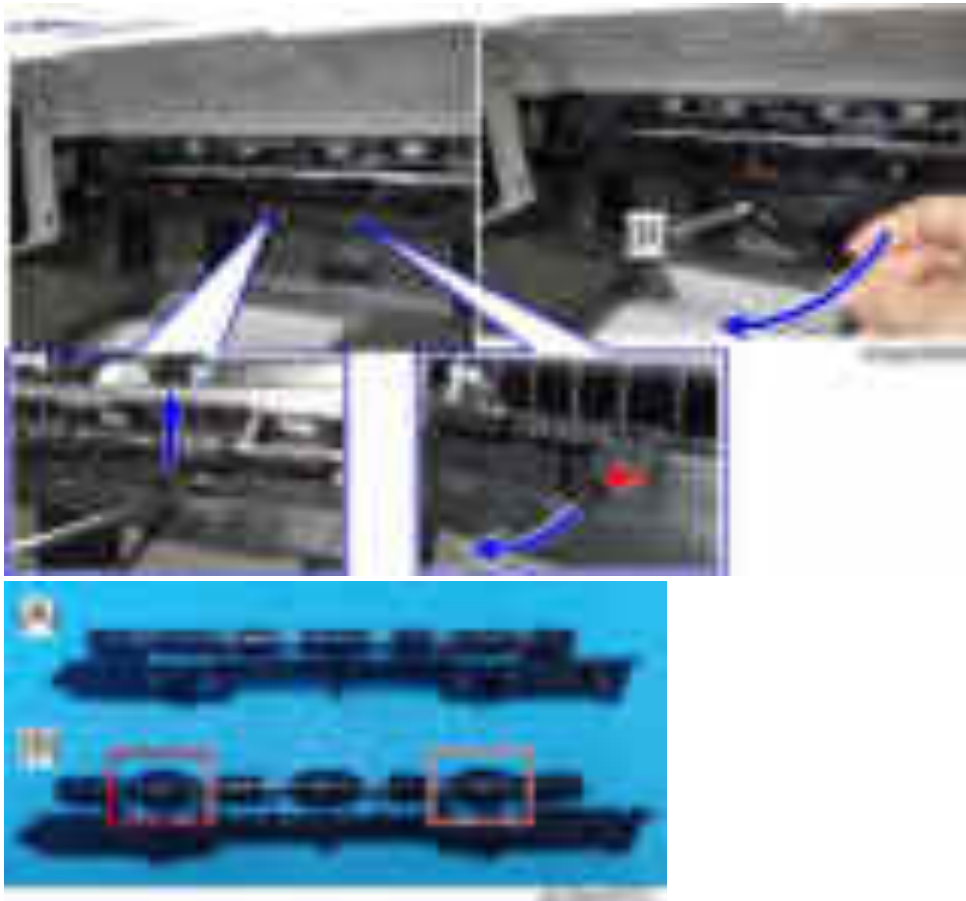

[A]: The supplied driven roller has flat rollers.

[B]: The machine's standard driven roller has drum-type rollers (as indicated by the red frames).



The spring arm on the flat roller might be disconnected due to the vibration or shock. After

2. Installation

attaching the roller, perform a visual check whether the state of assembly is normal or not.

[A]: Normal position, [B]: spring arm is disconnected.

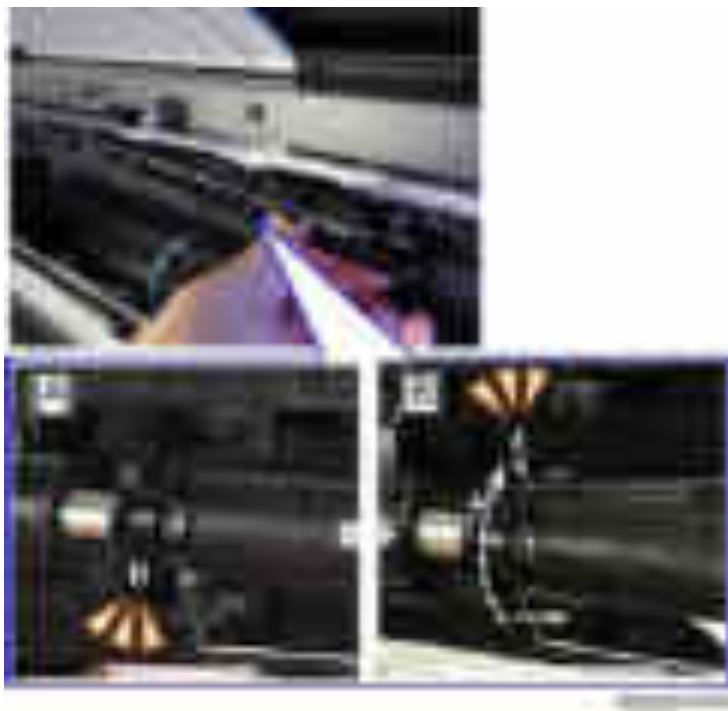

11. Attach the paper support guide (small) to the exit tray (hook x2).

1. Align and insert the support guide's tabs under the notches in the discharge brush frame [A] upward at an angle.

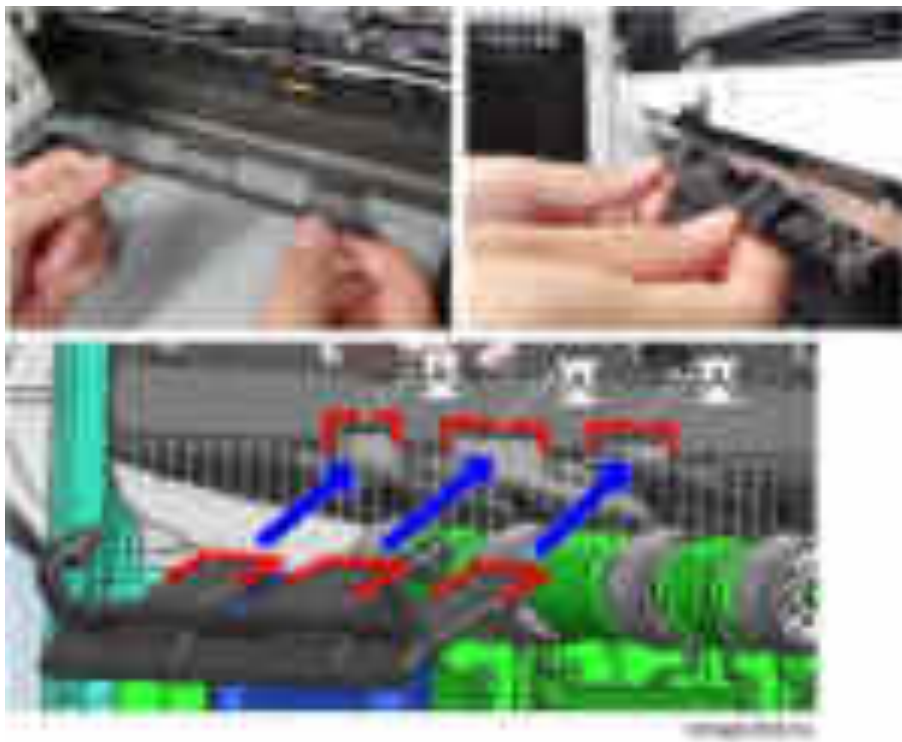

2. Rotate the support guide upward so that the support guide's hooks [C] become horizontal to

the discharge brush frame [B].



- Do not continue to hold the support guide at an angle when pushing it in. Otherwise, you damage the attachment or the hooks.



3. Holding the back of the discharge brush frame with the forefingers, push the hooks in horizontally one at a time until they click.

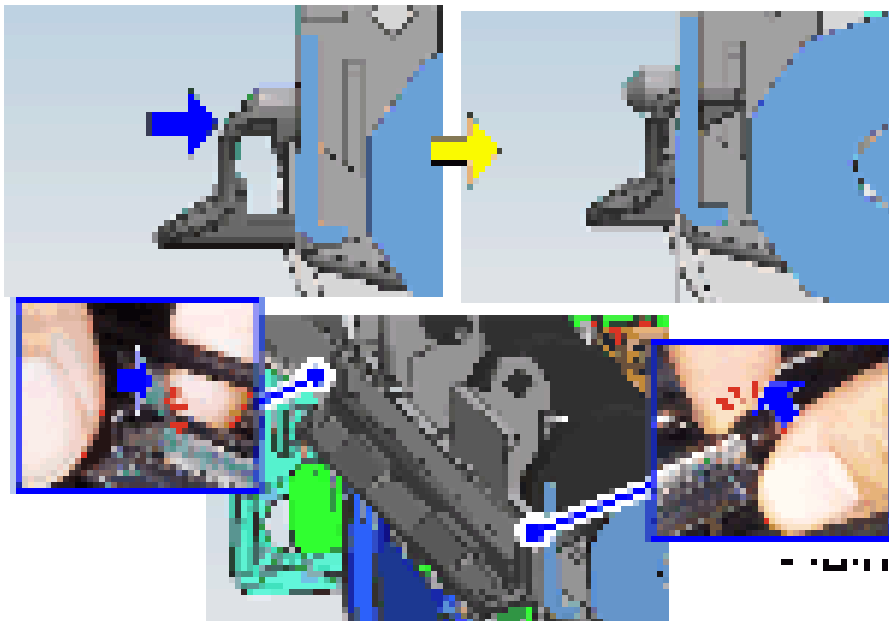

2. Installation

12. Remove the paper exit lower cover [A].



13. Attach the bottom plate (3 × 6). Before you attach it, insert the bottom plate's 2 tabs [A] into the slots in the machine.



You can easily install the plate as follows:

1. Evenly insert the bottom plate under the upper rear inner cover [B] from the front.



2.Installation

2. Check that the front resin part of the bottom plate and the paper exit cover are at this location.



3. Slightly lifting the front right part of the bottom plate, slide the front resin part of the bottom plate under the paper exit cover.



4. Pulling the bracket at the rear part slightly, engage the hook on the bottom plate with the hole in the side of the machine.



2. Installation

14. Reattach the proximity sensor on the left cover.



15. Close the front cover.

16. Attach the cushions to the internal multi-fold unit.

- When attaching the cushion (paper entrance) [1], align the cutout [A] with the top of the upper cover.
- When attaching the cushion (rear) [2], align it with a point 3 mm from the left edge [B].

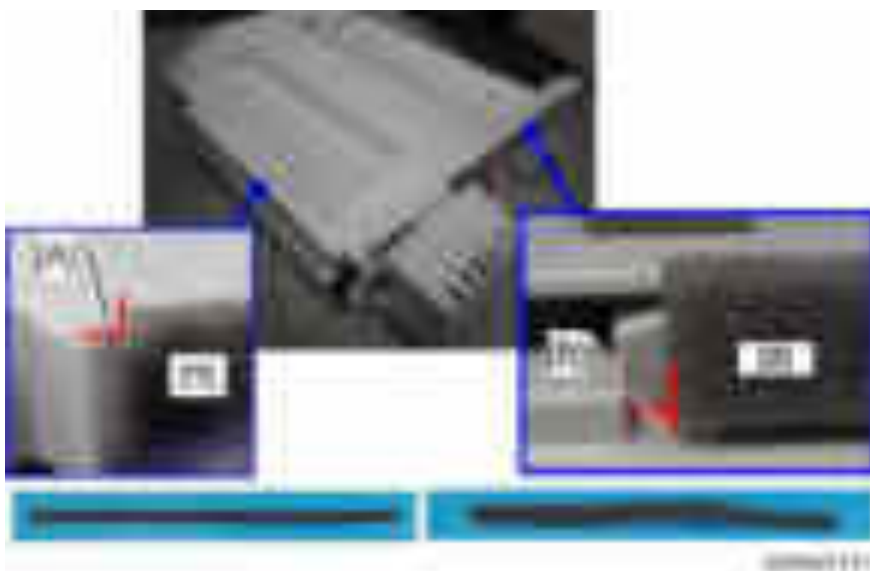

- 17.** Open the front cover of the internal multi-fold unit, and then secure the 2 screws in the recesses.



- This operation is required to apply pressure to the internal multi-fold unit roller when attaching it. The screw holes become inaccessible when the unit is attached to the machine, so be sure to perform this in advance.
- Be sure to turn the screws until they stop. It is not necessary to continue tightening them.

- 18.** Temporarily place the internal multi-fold unit [A] on the bottom plate.



- 19.** Open the front cover of the internal multi-fold unit, and then, holding the exit tray frame [A] and the top edge of the opening [B], lift the internal multi-fold unit and attach it to the machine.

- Lower the lever [C] to keep the paper guide plate open during operation, because the plate might be deformed if a strong force is applied while the guide plate is closed.
- Hold the metal frame part of the opening [B], not the exterior cover, to avoid the deformation of the cover.

2. Installation

- Be careful not to touch the mylar sheet [D] located behind.



- Be careful not to let the securing bracket [A] get caught between the internal multi-fold unit and the machine.



20. Attach the securing bracket [A] (M4x6).



21. Temporarily attach the internal multi-fold unit with the supplied coin screw (M4x1).



- The unit is only temporarily attached at this stage, so leave the screws loose.
- Fix the screw to the left screw hole [A] of the two screw holes. Do not use the right screw

hole [B].



22. Attach the correction plate for side-to-side registration [A] to the machine (M3x6).



- Partially secure the adjusting screw [B] on the upper part of the correction plate, and then secure the screw [C] at the bottom part of the plate.

23. Connect the cable [A] of the internal multi-fold unit to the machine.



24. Turn ON the main power.

25. Feed A3/DLT paper (any brand) from Tray 2 and check the scale [A].

Select the [Settings] icon > [Machine Features Settings] > [Printer Settings] > [List/ Test Print] > [Operation Test].

2. Installation



26. Check the movement at the paper edge from the leading to trailing edges, and turn the adjusting screws of the correction plate to adjust the internal multi-fold unit's position until the deviation stays within 2 marks on the scale. (Each mark represents 1 mm.)

- [A]: When the paper edge shifts towards the front, turn the adjusting screw clockwise.
- [B]: When the paper edge shifts towards the rear, turn the adjusting screw counterclockwise.

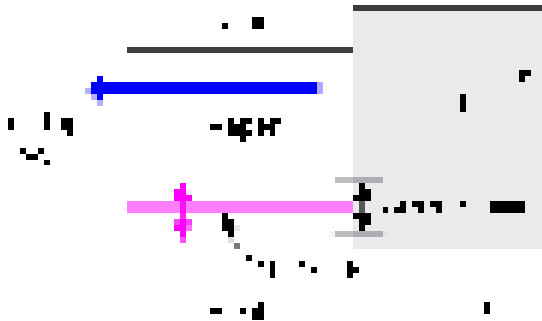

27. After registration, tighten the coin screw [A] to secure the internal multi-fold unit.

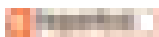

- When you fully open the front cover of the internal multi-fold unit, it may interfere with the machine's upper front cover, causing the internal multi-fold unit to become misaligned. Therefore, tighten the screw [A] with a stubby screwdriver.



28. Reattach the left rear cover.

29. When attaching the finisher beyond the internal multi-fold unit, attach the supplied paper exit guide (No.9). For details, refer to [When Attaching the Finisher Beyond the Internal Multi-Fold Unit](#).

30. Reattach the left upper cover.

- The exit tray of the internal multi-fold unit has mylar sheets [A] on it. When attaching the cover, be careful not to damage the mylar sheets [A].
- The left upper cover bulges slightly because of the mylar sheets, but this does not cause any problem if the mylar sheets are positioned correctly.



- Reattach the left upper cover with the mylar sheets [B] sandwiched behind it. The mylar sheets must not catch on or hang over the left upper cover, as shown by [C].



31. Reattach the inverter tray.

32. Insert the 4 hooks on the paper exit tray [A] into the slots (hook x 4).

When attaching the paper exit tray, do not put the movable plate [B] under the paper exit tray,

2. Installation

because that would interfere with the operation of the internal multi-fold unit.

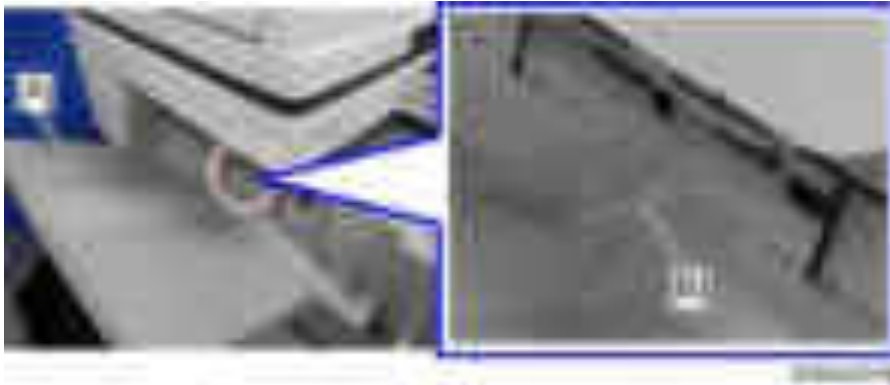

33. Tighten the screws to secure the paper exit tray (coin screw x2:M4).



34. Attach the paper relay cover (coin screw x2: M4)



When Attaching the Finisher Beyond the Internal Multi-Fold Unit

When attaching a finisher downstream from the internal multi-fold unit, attach the supplied left upper cover [A] and paper exit guide (relay) [B].



- 1.** Attach the paper exit guide (relay) [A] provided with this unit. (coin screw x2)
When attaching the paper exit tray, do not put the movable plate [B] under the paper exit tray, because that would interfere with the operation of the internal multi-fold unit.



- 2.** Attach the left upper cover [A] provided with this unit.



- 3.** To complete installation of the finisher, refer to the finisher installation below.
 - [Booklet Finisher SR3290 \(D3FN\) / Finisher SR3280 \(D3G4\)](#)
 - [Booklet Finisher SR3270 \(D3FQ\)](#)

2.Installation

- [Finisher SR3260 \(D3FR\)](#)

Banner Paper Guide Tray Type M19 (D3BF)

Accessory Check

No.	Description	Q'ty	Remarks
1	Main Tray	1	
2	Lock Plate	1	
3	Sub Tray	1	
4	Rivet	2	



Installation Procedure

CAUTION

- When installing this option, turn OFF the main power and unplug the power cord from the wall socket. If installing without turning OFF the main power, an electric shock or a malfunction may occur.
- Be careful not to get your finger caught in the area indicated by the red frame (the tray's rotating and insertion part).



2. Installation

- 1.** Open the bypass tray, and then attach the sub-tray [A]. (Rivet x2)



- 2.** Fold the sub-tray.



- 3.** While pressing down the feeler [B] on the bypass tray, push the main tray [A] into the bypass tray to attach it.

When you attach the tray, hold it with both hands to make sure that it does not fall.





- Check if the locks on the main tray's sides are engaged.



- 4.** Attach the belt by engaging it with the hooks [A].



- 5.** Remove the backing paper for the double-sided tapes on the lock plate.



2. Installation

6. Stick the lock plate [B] with its center aligned with the indentation [A] on the right door.



7. Tuck in the banner paper guide tray [A].



• Note

- The double-sided adhesive tapes stick firmly in about one day.

• Important

- When replacing the parts of the Banner Paper Guide Tray, use the installation procedure above in reverse order as a reference in order to make it easier to disassemble the unit.

Imageable Area Extension Unit Type M19 (D3BR-07)

Accessory Check

No.	Description	Q'ty	Remarks
1	Paper transfer roller (Extended)	1	



Installation Procedure



- Do not touch the roller surface during replacement. Also, when taking out the unit from the box, be careful not to touch the roller surface [A].



- Turn ON the main power.
- Enter the SP mode, and set SP2-400-001(Paper Transfer Roller Settings Width of Paper Transfer Roller) to "1: Wide roller".



- When SP2-400-001 is changed over, a message is displayed stating "Switch the power OFF/ON".

- After the SP is changed, turn OFF the main power.
- Replace the roller [A].

For details about how to replace the roller, refer to [Paper Transfer Roller](#).

2. Installation



- During PM replacement, do not install the wrong type of roller.

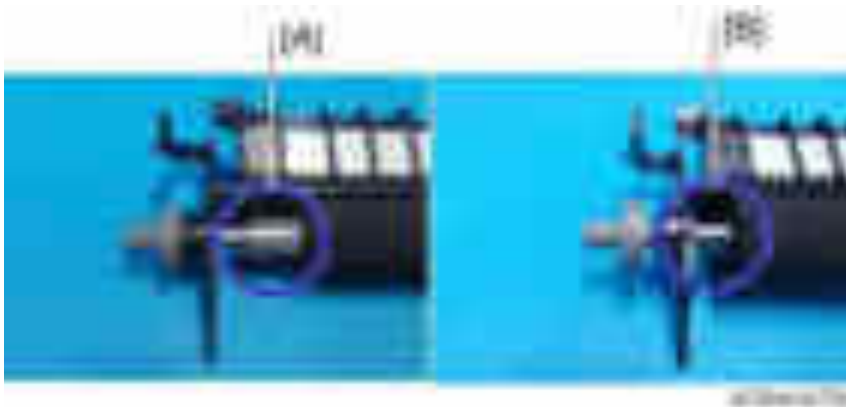

[A]: The standard roller has a gray collar at its end.

[B]: Imageable Area Extension Unit Type M19 does not have a collar on it.

- 5.** After replacing the paper transfer roller, turn ON the main power.
- 6.** Load SRA3 paper in Tray 2, and then print a full-bleed halftone test page to check if the print area extends to 315 mm in width.

SP descriptions

- **SP2-400-001 (Paper Transfer Roller Settings)**
Specifies the width of the Paper Transfer Roller. This SP must be set to "1" when Imageable Area Extension Unit Type M19 is installed.
0: Default roller
1: Wide roller

If You Forgot to Change the SP

The following problems occur.

When a change-over was made from a standard roller to the Imageable Area Extension Unit:

If the SP setting value is "0: Default roller" is set (SRA3 paper not supported), but the Imageable Area Extension Unit is installed:

- The image cannot be correctly transferred to the SRA3 paper area.
- The MUSIC/program control pattern adheres to the ends of the paper transfer roller (outside the A3

area), and this can transfer to the underside of printouts.

- Real-time process control cannot be performed correctly, and an abnormal image and SC285-00 (MUSIC error) may occur.

When a change-over was made from the Imageable Area Extension Unit to a standard roller:

If the SP setting value is "1: Wide roller", but the paper transfer roller is the normal one (SRA3 paper not supported):

- Real-time process control is not performed, and the interval between process controls becomes short.
- The waiting time for fusing temperature rise is longer than intended.

External Keyboard Bracket Type M19 (D3BR-10)

Accessory Check

Description	Q'ty	Remarks
Keyboard table bracket	1	
Keyboard stand bracket	1	
Keyboard stand	2	
Screw: M4 x 12	2	
Screw: M3 x 8	4	
Screw: M3 x 12	1	



- This optional unit is not supplied with a keyboard. Use a commercially available keyboard.

Installation Procedure

CAUTION

- When installing this option, turn OFF the main power and unplug the power cord from the wall socket. If installing without turning OFF the main power, an electric shock or a malfunction may occur.

- 1.** Remove the proximity sensor left cover [A].



- 2.** Open the right door, and then remove the small cover [A].



- 3.** Open the front cover.
- 4.** Remove the proximity sensor cover [A].



Figure 1

- Remember that there is a tab at the positions of the red arrows.
- Rotate the operation panel [B] upward to a horizontal position, and then detach the proximity sensor cover [A].



- 5.** Remove the screw [A] on the frame of the machine.



2. Installation

- 6.** Make 3 screw holes in the proximity sensor cover.



- 7.** Reattach the proximity sensor cover and proximity sensor left cover.
8. Attach the keyboard stand bracket [A] on the proximity sensor cover (x3).



- 9.** Attach the keyboard stand [A] on the keyboard stand bracket (x4).



- 10.** Place a keyboard on the keyboard stand, and then pass the keyboard cable through the hole in the

keyboard stand.

- 11.** Remove the rear cover [A].

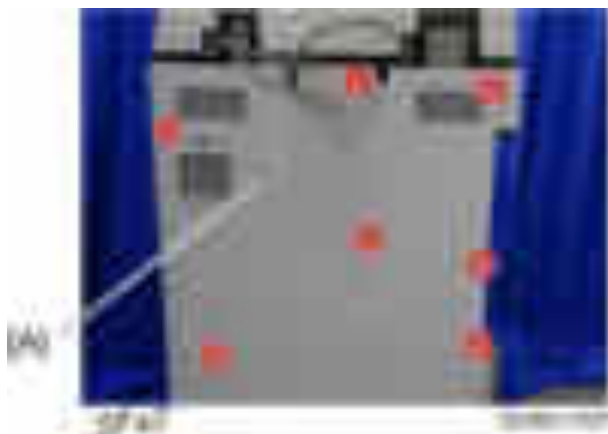

- 12.** Remove the scanner right cover [A] (1x1)



- 13.** Route the keyboard cable [A] along the right side of the scanner unit as shown below.



- 14.** Route the keyboard cable along the rear side of the scanner unit (1x1).

- Adjust the keyboard cable by making loops if the keyboard cable has too much slack.

2. Installation



- 15.** Remove the cutout [A] in the left rear cover to make a cable hole, and then pass the keyboard cable [B] through it.



- 16.** Connect the keyboard cable to the USB slot.



- 17.** Reattach the scanner right cover and rear cover.
18. Close the right door.

Internal Options

List of Slots

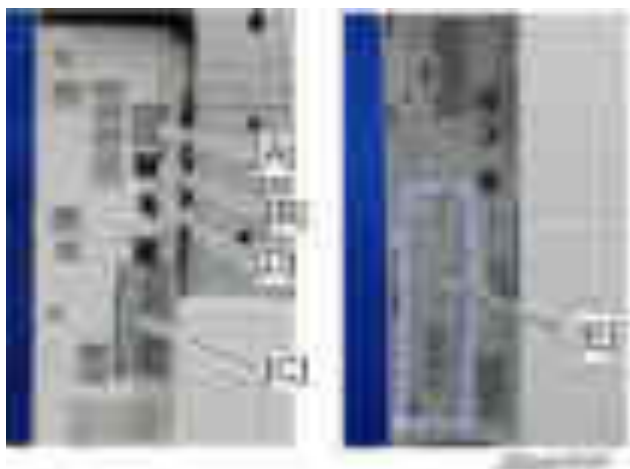

Slot		Option
[A]	USB mini	-
[B]	USB (host) port* ²	<ul style="list-style-type: none"> Used for the PictBridge function. Smart Card Reader Built-in Unit Type M37 (D3GF-35) External Keyboard Bracket Type M19 (D3BR-10)
[C]	I/F (RiO4) slot	<ul style="list-style-type: none"> IEEE 1284 Interface Board Type M19 (D3C0) File Format Converter Type M19 (D3BR-04) IEEE 802.11agn Interface Unit Type M19 (D3BR-01) Device Server Option Type M37 (D3GF-10, -11) RC-GATE
[D]	USB (device) port	-
[E]	I/F slot* ¹	Fax Option Type M37

*1 Dedicated slot for fax unit

*2 There is no difference between the left and right USB port.



- [NFC Card Reader Type M37 \(D3GF-34\)](#) connects the USB port that is mounted on the operation panel.

Device Server Option Type M37 (D3GF-10, -11)

Component Check

No	Items	Q'ty	Remarks
1	Cable Ties	2	
2	Interface Board	1	
3	Ferrite Core	2	



- An Ethernet cable is not packed with this option.

Installation Procedure



- When installing this option, turn OFF the main power and unplug the power cord from the wall socket. If installing without turning OFF the main power, an electric shock or a malfunction may occur.



- The device server option has an IP address stored on the PCB. This is different from the machine's IP address. The IP address and other network settings of the device server option must be configured after installing this option.

- 1.** Turn OFF the main power of the machine, and unplug the power cord from the wall socket.

2. Remove the slot cover [A].



3. Insert the interface board into the I/F slot.



4. Reattach the I/F cover.
5. Attach the ferrite cores to the Ethernet cable, while looping the cable at 3 cm (approx. 1.2 inches) [A] from each end of the cable.

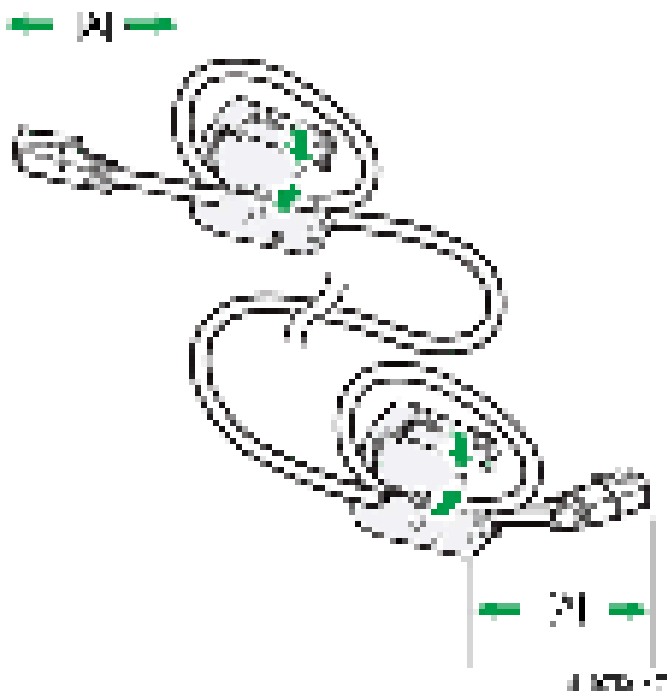

6. Only for installing this option in North America, bind both cores with cable ties [A] as shown below.

2. Installation

The two binds are not included in options produced before March 2015. To bind the cores, use the binds registered as service parts or similar ones.



- 7.** Insert the Ethernet cable into the Ethernet port on this option.



- 8.** Insert the other end of the Ethernet cable to a PC for network setting.

- 9.** Plug the power cord into the wall socket and turn on the main power of the machine.



- Do not unplug the USB cable while the machine is recognizing this option. It may take between 30 seconds to 1 minute to finish recognizing it (the LEDs on the Ethernet port of this option light up after recognizing this option; see below). If unplugged, connect the cable again.

- 10.** Make sure that the machine recognizes this option correctly by doing one of the following:

1. Access the option's IP address from a web browser.
2. Ping the option's IP address from a command prompt on a Windows PC in the same network as the mainframe.

If the IP address cannot be found (DHCP server), use the MAC address. This is the number printed on the seal attached to the printed circuit board.



3. Use "RX" + the option's MAC address and access a web browser.
Example: `http://RX0080926A3264`



4. Ping "RX" + "MAC address" from the command prompt on a windows PC which is on the same network as the mainframe.



- When installing the Device Server Option Type M37, the installation status is not shown on the configuration page.



- The customer should keep the slot covers which were removed.

What Do the LED Indications Mean?

When this option is properly installed and recognized by the main machine, the LED indicators light up under the following conditions.

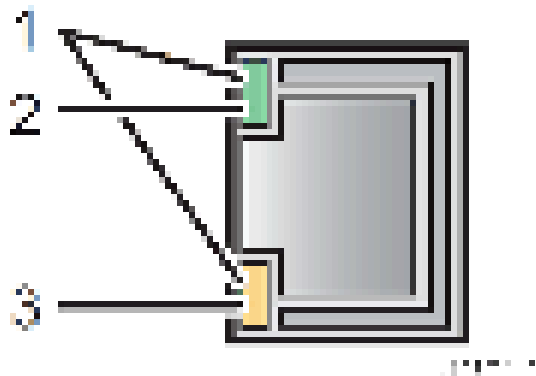

2. Installation

No.	Light Color	Lights Up When:
1	Green and Yellow	1000BASE-T operates
2	Green	10BASE-T operates
3	Yellow	100BASE-TX operates

Notes for Energy Saving Mode Setting

If the machine which has this option enters into the energy saving mode, you cannot print because there will be a communication error. Follow the instructions below to disable the machine's entering into the energy saving mode.

- 1.** Enter SP mode, and then set SP5-191-001 (Power Setting: Power Str) to "0 (Off)".

IP Address Setting

This section describes how to set an IP address on this option manually. Note that you can set an IP address which is not only on the same network segment but also on a different network segment to share a single printer with devices in multiple networks.



- You cannot change the IP address for this option from the operation panel of the main machine. The setting must be done from a web browser on your PC.
- The network setting of this option is initially assigned as follows:
IP address: 192.168.100.100 / Subnet mask: 255.255.255.0
- The network setting of your PC must be in the same network segment to change the network setting of this option.

- 1.** Make a note of the current network settings of your PC.
- 2.** Change the IP address on your PC to [192.168.100.xxx (*0 - 255)].
- 3.** Change the subnet mask on your PC to [255.255.255.0].
- 4.** Open a web browser.
- 5.** Type [http://192.168.100.100/] in the address bar.
- 6.** Press the "Enter" key.



- The setting screen for this option appears.

- 7.** Click [Network Setting].



- 8.** Type [root] in the user name textbox and click [OK].
9. Input [IP Address], [Subnet Mask] and [Default Gateway].



- 10.** Set other items if needed.
11. Press [Set]
12. Close the web browser.
13. Disconnect the Ethernet cable from the PC.
14. Connect the Ethernet cable to a network device (e.g. switching hub).
15. Set the IP address of this option in the printer driver which you use.

IEEE 1284 Interface Board Type M19 (D3C0)

Component Check

No.	Description	Qty	Remarks
1	IEEE 1284 Interface Board	1	
2	FCC document	1	
3	Notes for users	1	



Installation Procedure

CAUTION

- When installing this option, turn OFF the main power and unplug the power cord from the wall socket. If installing without turning OFF the main power, an electric shock or a malfunction may occur.
- Do not put your hand into the controller box. It will result in a malfunction or injury.
- Before doing any work, touch a metal object to discharge static electricity from the body. There is a possibility that the IEEE 1284 Interface Board may malfunction due to static electricity.

1. Remove the slot cover [A].



2. Insert the IEEE 1284 Interface Board into the I/F slot.

3. Turn ON the main power.

4. Check that the system settings list is output and that the board is recognized correctly.



- The customer should keep the slot covers which were removed.

2. Installation

IEEE 802.11ag Interface Unit Type M19 (D3BR-01)

This option is not available in China and Taiwan.

Component Check

No.	Description	Q'ty
1	IEEE802.11a/g/n Unit	1
2	Clamps	2
3	Velcro Fasteners	8
4	Notes for Users	2



Important

- Since disassembly/alteration of a wireless LAN board is illegal, during service replacements, replace the whole PCB assembly.
- Be sure to give the provided leaflet to the customer.

Installation Procedure

CAUTION

- When installing this option, turn OFF the main power and unplug the power cord from the wall socket. If installing without turning OFF the main power, an electric shock or a malfunction may occur.
- Do not put your hand into the controller box. It will result in a malfunction or injury.
- Before doing any work, touch a metal object to discharge static electricity from the body. There is a possibility that the extension wireless LAN board may malfunction due to static electricity.



- When using wireless LAN (IEEE802.11 b/g/n:2.4-GHz band), this radio product uses the 2.4-GHz band. Check that industrial, scientific and medical devices using the same frequency bands, such as a microwave oven or a cordless telephone, are not used nearby.
- If there is interference, communication may become unstable. Check that there are no devices likely to cause interference in the surrounding area.

1. Remove the slot cover [A].



2. Insert the extended wireless LAN board [A] into the slot ( ×2)



- Press the extended wireless LAN board firmly in, and check it is firmly connected.
- The customer should keep the slot covers which were removed.

3. Attach the hook-and-loop fastener [B] (provided with the accessories) on the antenna [A].



4. Peel the backing paper off the hook-and-loop fastener, and attach the antenna on the rear cover

2. Installation

and scanner's left cover as shown (x4).



- Take care to loop it around so that it does not interfere with other options or I/F cables.

5. Turn ON the main power.

6. Check that the system settings list is output, and the option is recognized correctly.

User Tool Settings for IEEE 802.11a/g/n

Go into the Settings mode and do the procedure below. These settings take effect every time the machine is powered on.



- IEEE 802.11a/g/n function is disabled while using Ethernet.

1. Press the "Settings" icon.

2. Press "Machine Features Settings" > "System Settings".



- Select "Interface Settings"> "Network" > "LAN Type". The "LAN Type" (default: Ethernet) must be set for either Ethernet or wireless LAN.

3. Select "Interface Settings"> "Wireless LAN". Only the wireless LAN options show.

4. Set the "Communication Mode".

5. Enter the "SSID setting". (The setting is case sensitive.)

6. Set the "Ad-hoc Channel". You need this setting when Ad Hoc Mode is selected. The allowed range for the channel settings may vary for different countries.

- For mainly Europe and Asia
2412 - 2462 MHz (1 - 11 channels)
5180 - 5240 MHz (36, 40, 44 and 48 channels)
(Default: 11)



- In some countries, only the following channels are available: 2412 - 2462 MHz (1 - 11 channels)
- For mainly North America
2412 - 2462 MHz (1 - 11 channels)

5180 - 5240 MHz (36, 40, 44 and 48 channels)

(Default: 11)

7. Set the "Security Method" to specify the encryption of the Wireless LAN.

- The "WEP" (Wired Equivalent Privacy) setting is designed to protect wireless data transmission. The same WEP key is required on the receiving side in order to unlock encoded data. There are 64 bit and 128 bit WEP keys.
 - Range of Allowed Settings:
 - 64 bit: 10 characters
 - 128 bit: 26 characters
- Specify "WPA2" when "Communication Mode" is set to "Infrastructure Mode". Set the "WPA2 Authent. Method".
 - WPA2 Authent. Method:
 - Select either "WPA2-PSK" or "WPA2".
 - If you select "WPA2-PSK", enter the pre-shared key (PSK) of 8-63 characters in ASCII code.
 - When "WPA2" is selected, authentication settings and certificate installation settings are required.

8. Press "Wireless LAN Signal" to check the machine's radio wave status using the operation panel.

- Press "Restore Factory Defaults" to initialize the wireless LAN settings.

SP Mode Settings for IEEE 802.11 Wireless LAN

The following SP commands and UP modes can be set for IEEE 802.11_111

SP No.	Name	Function
SP5-840-006	Channel MAX	Sets the maximum range of the channel settings for the country.
SP5-840-007	Channel MIN	Sets the minimum range of the channels settings allowed for your country.
SP5-840-008	Transmission Speed	Sets the transmission speed. Auto, 54 Mbps, 48 Mbps, 36 Mbps, 24 Mbps, 18 Mbps, 12 Mbps, 9 Mbps, 6 Mbps, 11 Mbps, 5.5 Mbps, 2 Mbps, 1 Mbps (default: Auto).
SP5-840-011	WEP Key Select	Used to select the WEP key (Default: 00).
UP mode	Name	Function
	SSID	Used to confirm the current SSID setting.
	WEP Key	Used to confirm the current WEP key setting.
	WEP Mode	Used to show the maximum length of the string that can be used for the WEP Key entry.
	WPA2 Authent.	Used to confirm the current WPA authentication setting and

2.Installation

SP No.	Name	Function
	Method	preshared key.

File Format Converter Type M19 (D3BR-04)

Component Check

No.	Description	Q'ty
1	File Format Converter	1
2	Notes for Users	1



Installation Procedure

CAUTION

- When installing this option, turn OFF the main power and unplug the power cord from the wall socket. If installing without turning OFF the main power, an electric shock or a malfunction may occur.
- Do not put your hand into the controller box. It will result in a malfunction or injury.
- Before doing any work, touch a metal object to discharge static electricity from the body. There is a possibility that the board may malfunction due to static electricity.

1. Remove the slot cover [A].



2. Insert the file format converter board into the I/F slot.

3. Turn ON the main power.

4. Check the system settings list is output, and that the option is recognized correctly.



- The customer should keep the slot covers which were removed.

2. Installation

Memory Unit Type M37 4GB (D3GF-08)

Component Check

No.	Description	Q'ty	Remarks
1	Memory Unit (DDR3L-DIMM 4G)	1	



Installation Procedure

CAUTION

- When installing this option, turn OFF the main power and unplug the power cord from the wall socket. If installing without turning OFF the main power, an electric shock or a malfunction may occur.

1. Remove the rear cover [A].

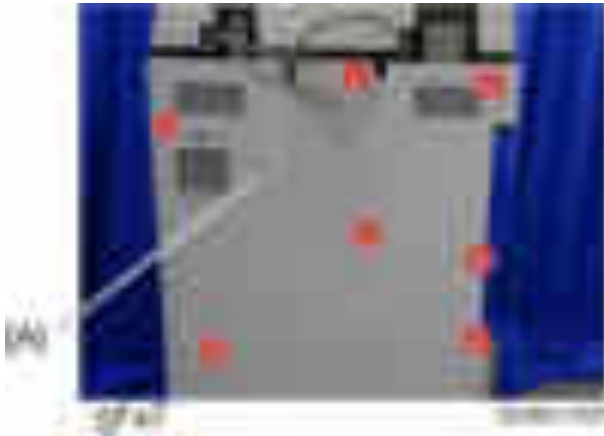

2. Remove the controller box cover [A].

Red Circle: Remove / Blue Circle: Loosen



- 3.** Release the latches and remove the standard 2GB DIMM [A].



- 4.** Insert the Memory Unit Type M37 4GB into the SDRAM socket.
Push the release latches [A] until they slip into the notch on the edge of the SDRAM.



- 5.** Reattach the controller box cover and rear cover.
6. Turn ON the main power.
7. Print out the system setting list to make sure that the memory unit is recognized properly.

Enhanced Security HDD Option Type M12 (D3A6-02)

Component Check

No.	Description	Q'ty	Remarks
1	Enhanced Security HDD	1	
-	EMC Address	1	



Installation Procedure

CAUTION

- When installing this option, turn OFF the main power and unplug the power cord from the wall socket. If installing without turning OFF the main power, an electric shock or a malfunction may occur.

1. Remove the rear cover [A].

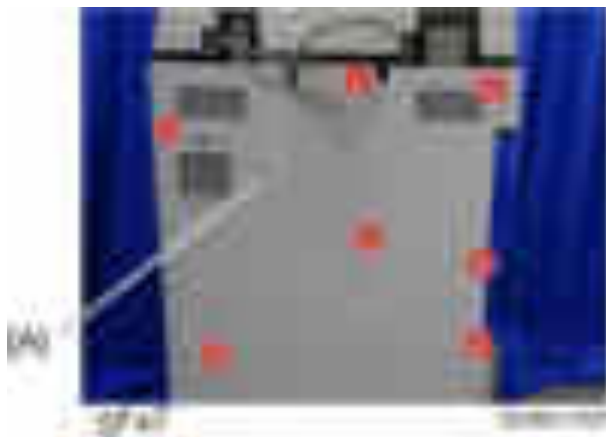

2. Remove the controller box cover [A].

Red Circle: Remove / Blue Circle: Loosen



- 3.** Remove the standard HDD [A] installed on the machine.



- 4.** Separate the standard HDD from the bracket.



2. Installation

- 5.** Disconnect the cables from the standard HDD. (🔧 × 2)



- 6.** Remove the enhanced security HDD from its protective pack.



- 7.** Connect the two cables to the enhanced security HDD. (🔧 × 2)



- 8.** Fasten the HDD to the bracket. (🔧 × 4)
9. Install the HDD bracket in the controller box.
10. Reassemble the machine.

After Installing the HDD

1. Connect the power cord and turn the machine on. A message prompts you to format the hard disk.



2. Touch [Format].

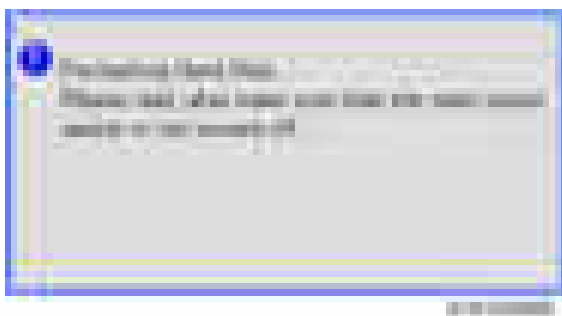

3. Wait for the machine to finish formatting the hard disk.



- Do not touch the power switch while the hard disk format is in progress. Wait for the machine to tell you that the formatting is finished.



4. Turn the main power OFF and back ON again after the message tells you formatting is finished.
5. Enter the SP mode.
6. Do SP5-846-040 to copy the address book to the hard disk from the controller board.
7. Do SP5-846-041 to let the user get access to the address book.
8. Turn the main power OFF and back ON again.
9. Ask an administrator to register an HDD authentication code in the machine.



- If the HDD Authentication Code is not registered, the function of the enhanced security HDD is not activated.

SP descriptions

SP5-	UCS Setting: Addr Book Migration(USB->HDD)
------	--

2. Installation

846-040	Copies the address book to the hard disk from the controller board. [Execute]
SP5-846-041	UCS Setting: Fill Addr Acl Info This SP must be executed immediately after installation of an HDD unit in a basic machine that previously had no HDD. The first time the machine is powered on with the new HDD installed, the system automatically takes the address book from the NVRAM and writes it onto the new HDD. However, the new address book on the HDD can be accessed only by the system administrator at this stage. Executing this SP by the service technician immediately after power on grants full address book access to all users. [Execute]

Optional Counter Interface Unit Type M12 (B870-21)

Component Check

No.	Description	Q'ty	Remarks
1	PCB: MKB	1	
2	Harness (MB to MKB) Not Used	1	
3	Harness (MB to MKB) Not Used	1	
4	Screws M3x6	4	
5	Standoffs	4	
6	Clamp	1	
7	Lock Band	1	
8	Relay Harness Not Used	1	



Installation Procedure

CAUTION

- When installing this option, turn OFF the main power and unplug the power cord from the wall socket. If installing without turning OFF the main power, an electric shock or a malfunction may occur.

2. Installation

1. Remove the rear cover [A].

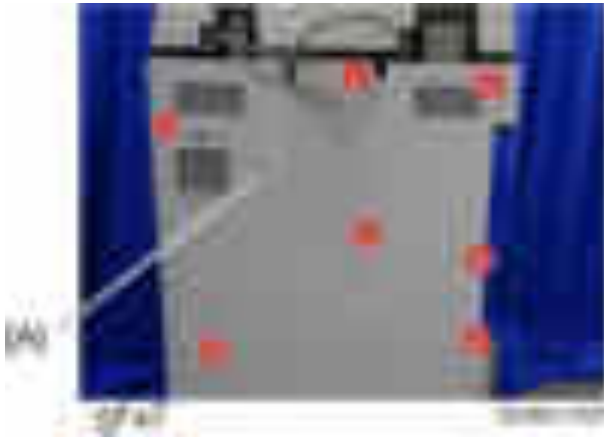

2. Remove the controller box cover [A].

Red Circle: Remove / Blue Circle: Loosen



3. Attach the studs provided with the option on the mainframe (Stud ×4).



- 4.** Attach the counter interface board [A].



- 5.** Release the harness [A] clamped to the main machine, and connect it to the 13 pin connector on the counter interface board.



- Do not use the harness that is provided with the accessories for the interface cable.

- 6.** Connect the I/F cable [A] of the optional counter device to the connector CN4 [B], and fix the ground wire at [C].



Key Counter Bracket Type M3 (D739-09)



Component Check

No.	Description	Q'ty	Remarks
-	Screw: M3X8	1	
-	Binding Self-Tapping Screw: M4X8	3	
-	Clamp: LWS-1211Z	2	
-	Clamp: NK-3N	1	
-	Double Sided Tape	2	
-	Key Counter Plate Nut	2	
-	Key Counter Harness	1	

Installation Procedure

CAUTION

- When installing this option, turn OFF the main power and unplug the power cord from the wall socket. If installing without turning OFF the main power, an electric shock or a malfunction may occur.

- Hold the key counter plate nuts [A] on the inside of the key counter bracket [B] and insert the key counter holder [C].
- Secure the key counter holder to the bracket ( x2).
- Install the key counter cover [D] ( x2).



- Open the right door.

5. Right rear cover [A] (x4, among them, tapping screw x1)



Notes:

- When installing, insert the projections [A] in the holes [B], taking care not to trap the harness inside.

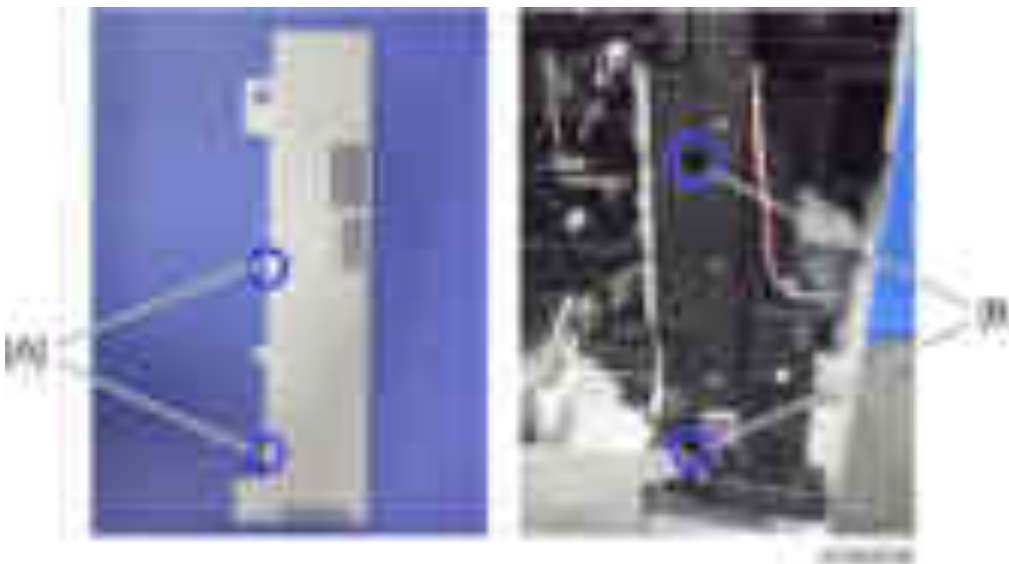

6. Remove the rear cover [A].

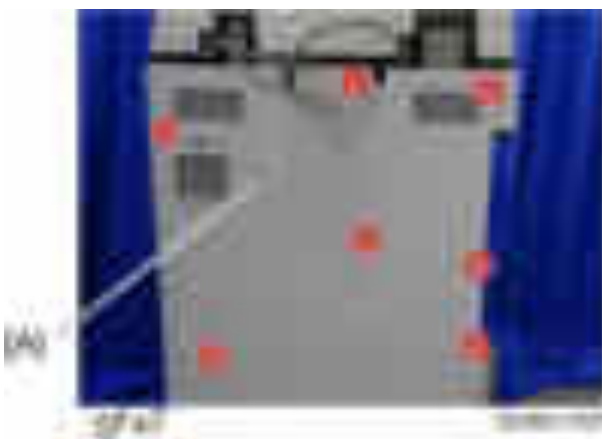

7. Remove the controller box cover [A].

2. Installation

Red Circle: Remove / Blue Circle: Loosen



- 8.** Route the key counter's cable inside the machine and clamp it.

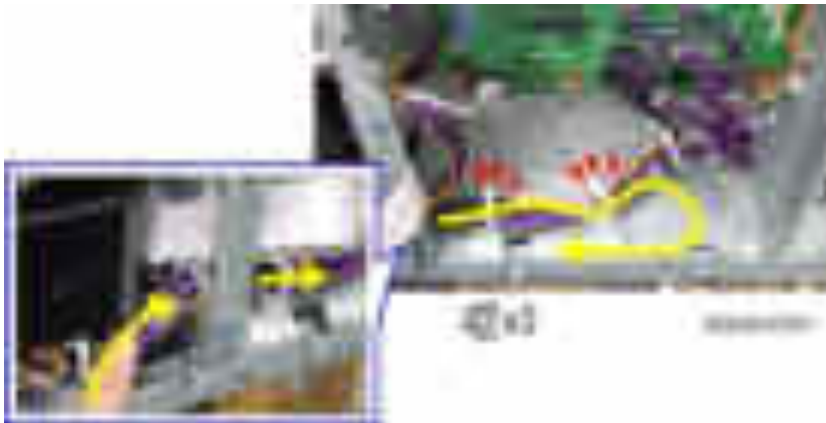

- 9.** Connect the key counter's cable to the 4-pin connector [A] on the machine.



10. Attach the supplied clamps [A], and then route the cable as shown.

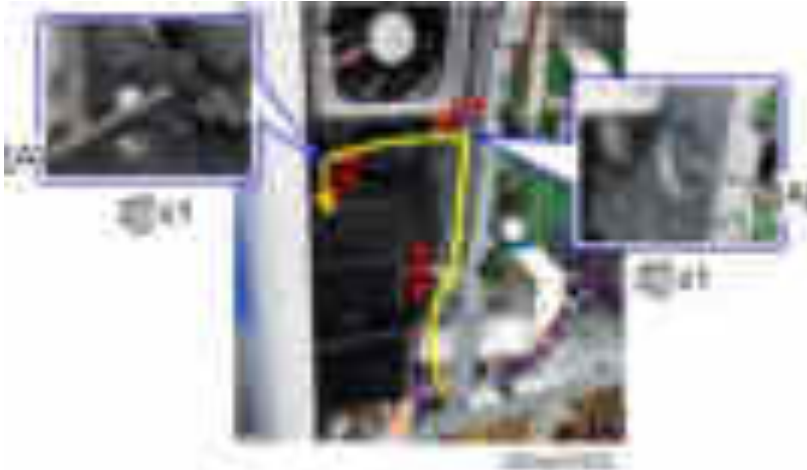

11. Open the slit in the rear cover to put the cable through, and then attach the rear cover while putting the cable through.



12. Connect the key counter and cable.

13. Attach the key counter [A] to the machine's rear right.



14. Reinstall all the covers on the main machine.

15. Peel off the double sided tape on the key counter bracket and attach the key counter to the scanner right cover.

16. Reassemble the machine.

2. Installation

NFC Card Reader Type M37 (D3GF-34)

Component Check

No.	Description	Q'ty	Remarks
1	Corner Cover	1	
2	Reader Spacer	1	
3	Reader Cover	1	
4	Reader	1	
5	Sponge Cushions	2	
6	Interface Cable (with the ferrite core)	1	



Installation Procedure

CAUTION

- When installing this option, turn OFF the main power and unplug the power cord from the wall socket. If installing without turning OFF the main power, an electric shock or a malfunction may occur.

1. Remove the proximity sensor left cover [A].



2. Open the right door, and then remove the small cover [A].



3. Open the front cover.

4. Remove the proximity sensor cover [A].



- Remember that there is a tab at the positions of the red arrows.
- Rotate the operation panel [B] upward to a horizontal position, and then detach the

2. Installation

proximity sensor cover [A].



5. Remove the original upper cover [A].



6. Attach the corner cover [A] provided with this option.
Use the screws removed in the previous step.



7. Remove the scanner front cover [A].



- 8.** Remove the operation panel upper cover [A].



- 9.** Remove the operation panel right cover [A].

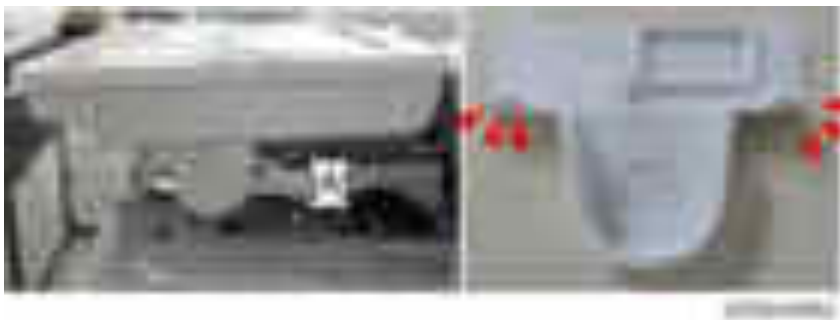

- 10.** Thread the USB cable [B] through the notch in the corner cover [A].



- 11.** Reattach the proximity sensor cover to the machine.
When reattaching the proximity sensor cover, make sure to connect the harness.

2. Installation



12. Attach the reader spacer [A].



13. Attach the sponge cushions [A] to the reader spacer.



14. Connect the card reader and interface cable.

Make sure to turn the USB cable as shown so that it threads through the notch in the spacer [A].



15. Attach the reader cover [A].



16. Connect the USB cable to the machine's operation panel connector.



17. Thread the USB cable through the U-shaped groove [A] at the hinge of the operation panel and notch [B] on the cover under the cover.



2. Installation

18. Apply the clamp to fasten the USB cable to the machine.

Make sure that the cable is not loose between the connector and hinge [A] and the hinge and clamp [B].



19. Tuck in the excess length portion of the USB cable in the space under the scanner.



20. Reattach the removed covers.

Smart Card Reader Built-in Unit Type M37 (D3GF-35)

Component Check

No.	Description	Q'ty	Remarks
1	Corner Cover	1	
2	IC Card Reader Spacer	1	
3	IC Card Reader Table	1	
4	Sponge	2	



Installation Procedure

CAUTION

- When installing this option, turn OFF the main power and unplug the power cord from the wall socket. If installing without turning OFF the main power, an electric shock or a malfunction may occur.

An IC card reader and a USB cable are not included with this unit. The customers must obtain these themselves, and the technicians must install them.

There are 2 ways to connect the USB cable of the IC card. One is to the machine USB slot which is the same way as the previous machine, and another is to the smart operation panel USB slot.

2. Installation

Procedure for Connecting to the Main Machine USB Slot

- 1.** Remove the proximity sensor left cover [A].



- 2.** Open the right door, and then remove the small cover [A].



- 3.** Open the front cover.

- 4.** Remove the proximity sensor cover [A].



- Remember that there is a tab at the positions of the red arrows.
- Rotate the operation panel [B] upward to a horizontal position, and then detach the

proximity sensor cover [A].



5. Remove the original upper cover [A]



6. Attach the corner cover [A] provided with this option.
Use the screws removed in the previous step.



7. Remove the scanner right cover [A].



2. Installation

- 8.** Reattach the proximity sensor cover with corner cover [A] to the machine.



- 9.** Pass the USB cable [A] through the hole.



- This cable is not included in this unit. The user may need to provide it.



- 10.** Attach the table [A].



- There are three ribs on the back side of the table.



11. Attach the sponges [A] with double-sided tape.



12. Connect the cable [B] to the IC reader [A] and attach the reader to the table.



- The USB cable should be turned as the following photo shows.



2. Installation

13. Attach the IC card reader cover [A].



14. Attach the three clamps (■x3).



15. Remove the cover to make the hole [A] to pass the cable through.



- 16.** Connect the USB connector to the USB interface of the controller.



- 17.** Route the cable as shown in the following photo (x1).

Tuck in the excess length portion of the cable in the space over the controller box.



- 18.** Reattach the exterior covers.

Procedure for Connecting to the Operation Panel USB Slot

- 1.** Remove the proximity sensor left cover [A].



2. Installation

- 2.** Open the right door, and then remove the small cover [A].



- 3.** Open the front cover.

- 4.** Remove the proximity sensor cover [A].



- Remember that there is a tab at the positions of the red arrows.
- Rotate the operation panel [B] upward to a horizontal position, and then detach the proximity sensor cover [A].



- 5.** Remove the original upper cover [A]



- 6.** Attach the corner cover [A] provided with this option.
Use the screws removed in the previous step.



- 7.** Remove the scanner front cover [A].



- 8.** Remove the operation panel upper cover [A].



2. Installation

- 9.** Remove the operation panel right cover [A].

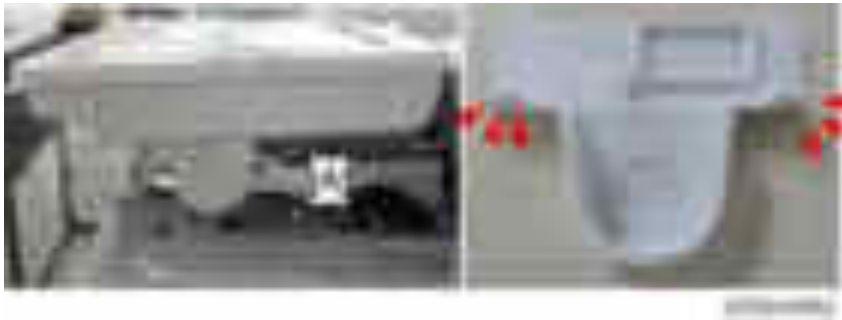

- 10.** Thread the USB cable [B] through the notch in the corner cover [A].



- 11.** Reattach the proximity sensor cover to the machine.

- 12.** Attach the reader spacer [A].



- 13.** Attach the sponge cushions [A] to the reader spacer.



- 14.** Connect the card reader and interface cable.

Make sure to turn the USB cable as shown so that it threads through the notch in the spacer [A].



- 15.** Attach the reader cover [A].



2. Installation

16. Connect the USB cable to the machine's operation panel connector.



17. Thread the USB cable through the U-shaped groove [A] at the hinge of the operation panel and notch [B] in the cover under the cover.



18. Apply the clamp to fasten the USB cable to the machine.
Make sure that the cable is not loose between the connector and hinge [A] and the hinge and clamp [B].



- 19.** Tuck in the excess length portion of the USB cable in the space under the scanner.



- 20.** Reattach the removed covers.

SD Card Options

SD Card Slots

Optional SD cards can be set in either slot 1 or slot 2. But slot 2 is the service slot, so we recommend that you use slot 1 to install the SD card options.



[A]: SD card slot 1 (option slot)

[B]: SD card slot 2 (service slot)

List of Slots Used

- VM CARD Type M37
- Camera Direct Print Card Type M37
- PostScript3 Unit Type M37
- XPS Direct Print Option Type M37
- IPDS Unit Type M20
- DataOverwriteSecurity Unit Type M19
- OCR Unit Type M13
- Fax Connection Unit Type M37
- Unicode Font Package for SAP(R) 1 License
- Unicode Font Package for SAP(R) 10 Licenses
- Unicode Font Package for SAP(R) 100 Licenses

SD Card Appli Move

Overview

Since there are only two SD card slots (one of them is a service slot), three or more SD card applications cannot be used simultaneously.

However, if multiple SD card applications are merged, three or more SD card options can be used.

This function is referred to as the "**SD card merge function**".

The "**SD card merge function**" is a function which enables the use of three or more functions within the capacity of two SD cards by physically transferring the function of one SD card to other SD cards (all SD card options can be stored in two SD cards).

However, SD card applications are under license, therefore, since an SD card license after the merge is

transferred to the target SD card, it cannot be used even if it is moved to the target machine.
Also, a process to prevent illegal copying is performed.



- After the merge, store the empty SD card in the location shown below.

1. Remove the proximity sensor left cover [A].



2. Open the right door, and then remove the small cover [A].



3. Open the front cover.

4. Remove the proximity sensor cover [A].



- Remember that there is a tab at the positions in the red arrows.
- Rotate the operation panel [B] upward to a horizontal position, and then detach the

2. Installation

proximity sensor cover [A].



5. Insert the SD card in the storage location inside the cover.

Up to 3 SD cards can be accommodated.



6. Put the removed covers back in their original positions.

When attaching the proximity sensor left cover, be sure to connect the connector.



Move Exec



- When merging SD cards, an SD card to be merged is not specified.

1. Turn the OFF the main power.

- 2.** Remove the SD card slot covers [A].

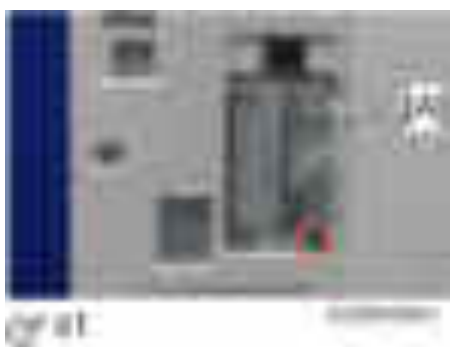

- 3.** Set the destination SD card (SD card where data is to be stored) in Slot 1 [A], and set the original SD card (SD card from which data is to be transferred) in Slot 2 [B].



- 4.** Turn ON the main power, and press [ENTER] in SP5-873-001 (SD Card Appli Move: Move Exec).
5. When a confirmation screen is displayed, press [ENTER] (it takes about 2 - 3 minutes).



- If [CANCEL] is pressed, the display returns to the previous screen.
- Note that if the power supply is turned off, a panel operation is performed, or the cover is opened during the merge, it will result in a malfunction.

- 6.** When the merge is complete, press [CLOSE].



- If the process is terminated abnormally, perform the merge in SP mode again.
- If the capacity of the destination SD card is insufficient, the merge operation cannot be performed.

- 7.** Press [END] twice.
8. Turn OFF the main power.
9. Remove the empty SD card after transfer from Slot 2.
10. Reattach the slot cover (A ×1).
11. Turn ON the main power, output the system setting list, and check that the options are recognized correctly.

Undo Exec

This is a recovery function if an application is incorrectly transferred to a different device of the same model.

2. Installation

- 1.** Turn OFF the main power.
- 2.** Remove the SD card slot covers [A].

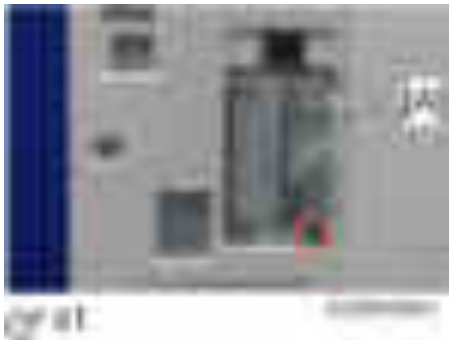

- 3.** Insert the integrated SD card in Slot 1 [A: Upper].



- 4.** Insert the SD card which became empty after integration in Slot 2 (lower slot).
- 5.** Turn On the main power, and press [ENTER] in SP5-873-002 (SD Card Appli Move: Undo Exec).
- 6.** When a confirmation screen is displayed, press [ENTER].



- If [CANCEL] is pressed, the display returns to the previous screen.
- Note that if the power supply is turned off, a panel operation is performed, or the cover is opened during cancellation, it will result in a malfunction.

- 7.** When cancellation is complete, press [CLOSE].
- 8.** Press [END] twice.
- 9.** Turn OFF the main power.
- 10.** Reattach the SD card slot cover (A×1).
- 11.** Turn ON the main power, and check that the application has been deleted.

PostScript3 Unit Type M37 (D3GF-26, -27, -28)

Overview

This machine is equipped with a clone program for emulating Adobe PostScript/PDF (hereafter “Clone PS”) as a standard feature. So, by factory default, it can perform printing using PostScript 3 and PDF Direct Print, in addition to RPCS.

However, the variety and number of built-in fonts (device fonts) differ between Adobe PS and Clone PS, sometimes resulting in different printing results.

To address the possible customer needs listed below, the PostScript3 Unit Type M37 is made available as an option.

- When you want to use device fonts supplied with Adobe PS.
- Since forms and ledgers have been created based on device fonts supplied with Adobe PS, a changeover to Clone PS requires a redesign of these documents.
- From the viewpoint of a precise printing operation, it is impossible to accept any differences in output results in comparison with Adobe PS.

Component Check

No.	Description	Q'ty
1	SD Card	1
2	PS3 Decal	1



Installation Procedure (Adobe PS)



- When installing more than one SD card, perform the merge operation ([SD Card Appli Move](#)).
- Clone PS and Adobe PS cannot be run simultaneously. If PostScript3 Unit Type M37 (Adobe PS) is installed, Clone PS will be disabled.

- 1.** Remove the SD card slot cover [A].

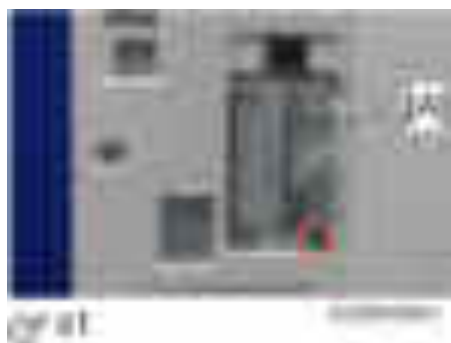

2. Installation

2. Insert the PS3 SD card in SD card slot 1 [A: Upper Slot].



3. Reattach the SD card slot cover (x1).
4. Stick the "Adobe PostScript3" decal [A] on the front face of the machine.



5. Turn ON the main power.
Adobe PostScript3 installation starts.
6. Press [Restart] when the following message appears.

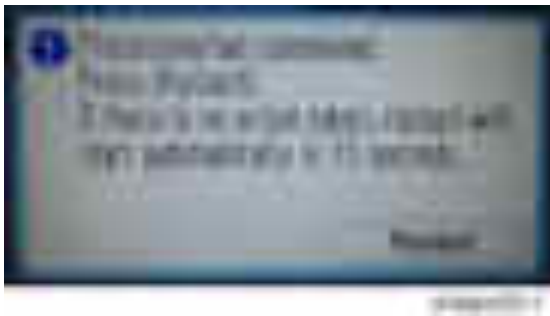

7. Print out the "Configuration Page", and then check if this option is correctly recognized.
 - Settings > Machine Features Settings > Printer Settings > List/Test Page > Configuration Page
 - Note that the description of Firmware Version shown in the printed Configuration Page differs between Clone PS and Adobe PS.

PS type	Description of Firmware Version
When PostScript3 Unit Type P37 (Adobe PS) is installed	RPCS [x.xx.xx] Adobe PostScript 3 [x.xx], Adobe PDF [x.xx]
Clone PS	RPCS [x.xx.xx] PS3 [x.xx], PDF [x.xx]

Switching back to Clone PS from Adobe PS

Clone PS can be resumed by removing the Adobe PS card from the SD card slot and applying the

firmware for Clone PS/PDF (".fwu" or ".rfu").

Note: The work should be carried out by service technicians.

In doing this, be sure to apply both PS3 and PDF firmware modules. If only one of them is applied, the machine will not operate properly. (As a stopgap measure to fix the malfunction, insert the optional Adobe PS card again into the SD card slot to enable the use of Adobe PS. Then, Clone PS can be resumed by applying both the PS3 and PDF firmware modules once again.)

Classification	Firmware name	Software part number
Clone PS component firmware	Clone PS3	D0AF5573
	Clone PDF	D0AF5575
	IRIPS Font	D0AF5577
Adobe PS component firmware	Adobe PS3	D3BD5731
	Adobe PDF	D3BD5733
	PS3 Font	D2415681

Initial Settings for the Printer Driver

After installation of an SD card, configure the settings for the printer driver in accordance with the type of PS to be used.



- The same printer driver, PS3 printer driver, can be used for printing either for Adobe PS or Clone PS.

Setting items (Windows):

In an environment where interactive communication is enabled, the machine attempts to acquire information to perform automatic configuration.

When manual configuration is to be performed, select "Adobe PostScript" if Adobe PS is used, and choose "Emulated PostScript" if Clone PS is used.

- 1.** On the [Start] menu, click [Devices and Printers].
- 2.** Right-click the icon of the printer you want to use.
- 3.** Click [Printer properties].
- 4.** Click the "Accessories" tab and configure settings for Adobe PS/Clone PS using the PostScript

2. Installation

pull-down menu.



Setting items (Mac OS X):

If the driver is installed by means of the Bonjour function or “HP Jetdirect - Socket”, the settings will be automatically configured.

Automatic configuration will not work if any other protocol is used for installation. In this case, manual configuration is required.

When manual configuration is to be performed, select “Adobe PostScript” if Adobe PS is used, and “Emulated PostScript” if Clone PS is used.

Camera Direct Print Card Type M37 (D3GF-30)

Component Check

No.	Description	Q'ty
1	SD Card	1

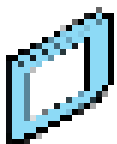

SD Card

Installation Procedure



- When installing more than one SD card, perform the merge operation ([SD Card Appli Move](#)).

2. Installation

Installation Procedure



- When installing more than one SD card, perform the merge operation ([SD Card Appli Move](#)).

1. Remove the SD card slot cover [A].



2. Insert the IPDS card in SD card slot 1 [A: Upper Slot].



3. Reattach the SD card slot cover. ( ×1)

4. Do one of the following ("A" or "B") to enable the IPDS function.

A. [Enable the IPDS function via telnet]

1. Connect the machine via telnet.
2. Execute the following commands:

```
msh> set ipds up
```

***If you want to stop the function.

```
msh> set ipds down
```

B. [Enable the IPDS option via Web Image Monitor]

1. Log in to Web Image Monitor.
2. Change the setting to enable IPDS.

5. Attach the decal.

6. Print out the "Configuration Page", and then check if this option is correctly recognized.

- Settings > Machine Features Settings > Printer Settings > List/Test Page > Configuration Page

XPS Direct Print Option Type M37 (D3GF-19, -20, -21)

Component Check

No.	Description	Q'ty	Remarks
1	XPS Direct Print SD Card	1	



2-4-1-1-1

Installation Procedure



- When installing more than one SD card, perform the merge operation ([SD Card Appli Move](#)).

1. Remove the SD card slot cover [A].

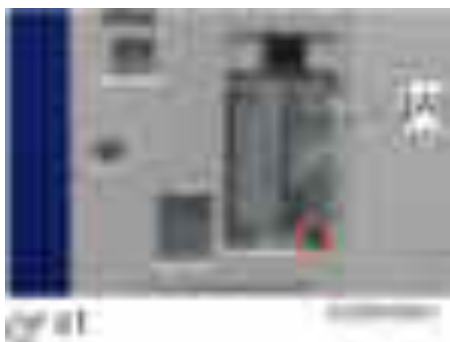

2. Insert the XPS SD card in SD card slot 1 [A: Upper Slot].



3. Reattach the SD card slot cover. (1x)

4. Turn ON the main power.

5. Print out the "Configuration Page", and then check if this option is correctly recognized.

- Settings > Machine Features Settings > Printer Settings > List/Test Page > Configuration Page

2. Installation

OCR Unit Type M13 (D3AC-23, -24, -25)

Component Check

No.	Description	Q'ty
1	SD Card	1

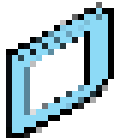

.....

Searchable PDF Function Outline

This option adds a searchable PDF function to the scanning function.

- The searchable PDF function performs OCR by the MFP on a document read with the scanner and embeds text data in the PDF. This permits PDF text browsing, automatic assignment of filenames, and automatic alignment of document orientation.
- This option is provided with an SD card. By installing an SD card in the MFP, a functional icon is added to the control unit. It is not necessary to install software on a PC.
- If this option is installed, various settings related to the searchable PDF function are available.
- After reading of the document is completed (after it is read by the SPDF/ARDF and output), OCR is performed. Therefore, after reading is completed, documents can be collected from the document glass or SPDF/ARDF.
- Other functions, such as the copy function and printer function, can be used during OCR.

Installation Procedure



- When installing more than one SD card, perform the merge operation ([SD Card Appli Move](#)).

1. Remove the SD card slot cover [A].

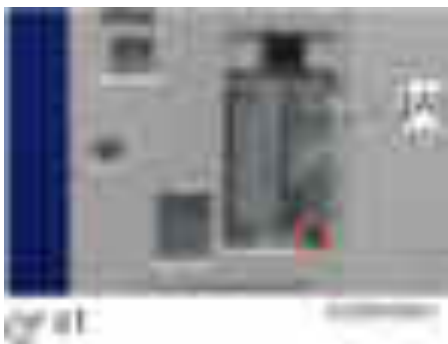

- 2.** Insert the OCR Unit SD card in SD card slot 1 [A: Upper Slot].



- 3.** Turn ON the main power.
- 4.** Enter the SP mode, and then press "Enter" in SP5-878-004 (Option Setup: OCR Dictionary).
The SD card ID is saved in the NVRAM, and the ID of the MFP is saved on the SD card. The MFP and SD card are thereby linked.
- 5.** When "operation complete" is displayed, press "Close".



- If installation fails, "Failed" is displayed.
- If installation fails, perform the following steps.

1. Check whether it is a used SD card.
2. Switch the power OFF, and repeat steps 1-5.

- 6.** Turn the machine OFF and back ON again.
- 7.** Press "Enter" in SP5-878-004 (Option Setup: OCR Dictionary).
Dictionary data is copied to the HDD.



- On the first run, SP5-878-004 links the SD card, and on the second run, copies dictionary data.

- 8.** Turn OFF the main power.
- 9.** Remove the SD card from the SD card slot.



- Keep the SD card in the SD card storage location of the MFP. The original SD card is needed in the event of a HDD malfunction.

- 10.** Reattach the SD card slot cover.
- 11.** Turn ON the main power.
- 12.** Press [File Format / File Name] on the scanner function screen.
- 13.** Check that [OCR setting] is displayed on the "File format / "File Name" screen.



- After installation, the OCR setting can be changed on the "OCR setting" screen.
- When setting OCR, set [OCR setting] to [Yes]. (Default setting: [No])

Recovery Procedure

When this option is installed, a function is saved on the HDD, and ID information on the SD card is

2. Installation

saved in the NVRAM. Therefore, when replacing the HDD and NVRAM, this option must be reinstalled.

When storing the original SD card

- When only the HDD is replaced
Reinstall using the original SD card.
- When only the NVRAM is replaced
When performing an upload/download of NVRAM data, reinstall using the original SD card.
When not performing upload/download of NVRAM data, order and reinstall a new SD card (service part).
- When the HDD and NVRAM are replaced simultaneously
Reinstall using the original SD card.

If the original SD card is lost

Order and reinstall a new SD card (service part).

DataOverwriteSecurity Unit Type M19 (D3BS-03)

Overview

The machine's hard disk stores all document data from the Copier, Printer, and Scanner functions. It also stores the data of users' Document Server and code counters, and the Address Book. To prevent data on the hard disk being leaked before disposing of the machine, you can overwrite all data stored on the hard disk (Erase All Memory). You can also automatically overwrite temporarily-stored data (Auto Erase Memory).

The function of this option is completely the same as the Data Overwrite Security in Security Functions, which is standard on this machine ([Security Settings](#))

This option should be installed only for the customer who requires the **CC certified Data Overwrite Security function**.

Component Check

Check the quantity and condition of the accessories in the box against the following list.

No.	Description	Q'ty
1.	SD Card	1
-	Comments Sheet	1
-	Operating Instructions CD-ROM	1

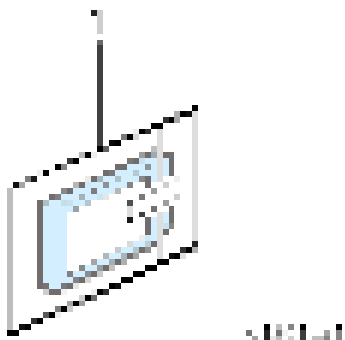

Before You Begin the Procedure

- 1.** Confirm that the Data Overwrite Security unit SD card is the correct type for the machine. The correct type for this machine is "Type M19".



- If you install any version other than "**Type M19**" for this machine, you will have to replace the NVRAM and do this installation procedure again.

- 2.** Make sure that the following settings are not at their factory default values:

- Supervisor login password
- Administrator login name
- Administrator login password

If any of these settings are at a factory default value, tell the customer these settings must be changed before you do the installation procedure.

- 3.** Make sure that "Admin. Authentication" is ON.

"Settings" icon > Machine Features Settings > System Settings > Administrator Tools > Administrator Authentication Management > Admin. Authentication

If this setting is OFF, tell the customer this setting must be ON before you do the installation procedure.

- 4.** Make sure that "Administrator Tools" is enabled (selected).

"Settings" icon > Machine Features Settings > System Settings > Administrator Tools > Administrator Authentication Management > Available Settings

If this setting is disabled (not selected), tell the customer this setting must be enabled (selected) before you do the installation procedure.



- See the Operating Instructions (Security Guide) for the factory default values.

Seal Check and Removal

Before opening the corrugated envelope, make sure that the seal has not been broken or peeled off. If the seal has been broken or peeled off (even partially), this is considered an arrival defect. Note that once the seal is peeled off, this will leave a mark on the bag.

2. Installation

CAUTION

- You must check the box seals to make sure that they were not removed after the items were sealed in the box at the factory before you do the installation.

1. Check the box seals [A] on each corner of the box.

- Make sure that a tape is attached to each corner.
- The surfaces of the tapes must be blank. If you see "VOID" on the tapes, do not install the components in the box.

2. If the surfaces of the tapes do not show "VOID", remove them from the corners of the box.

3. You can see the "VOID" marks [B] when you remove each seal. In this condition, they cannot be attached to the box again.

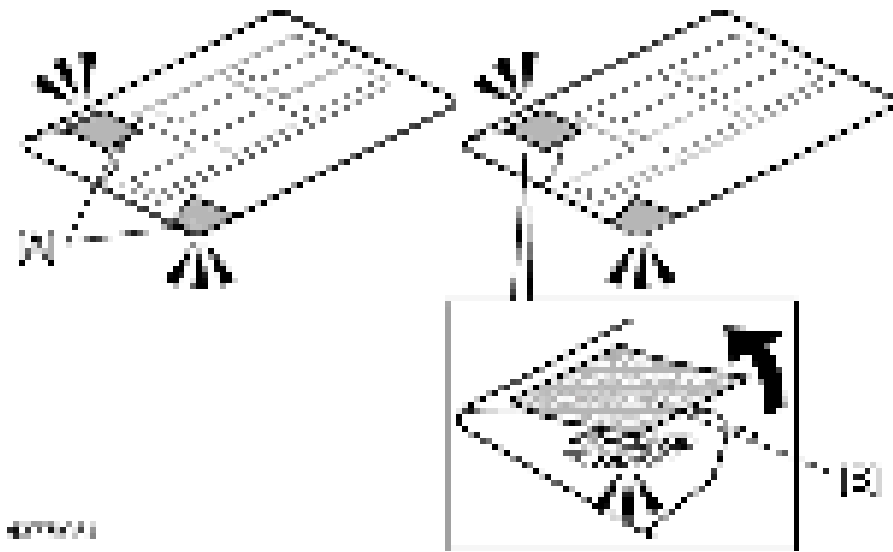

Installation Procedure

- 1.** Turn the main power off, and then remove the power plug and cables that are connected.
- 2.** Remove the SD card slot cover [A].

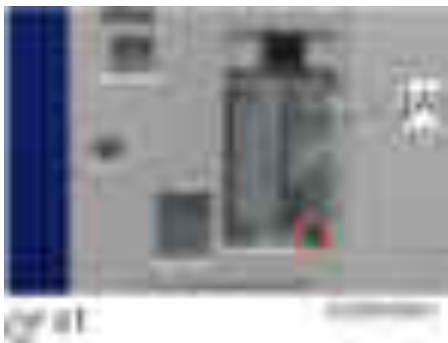

- 3.** Insert the DataOverwriteSecurity Unit Type M19 SD card in SD card slot 1 [A: Upper Slot].



- 4.** Reattach the SD card slot cover. (Image ×1)

- 5.** Insert the power cord into the outlet and turn ON the main power.



- When installing more than one SD card, perform the merge operation.

- 6.** Enter the SP mode.

- 7.** Do this step only if you are installing the option on a machine that is already in use (not a new machine):

- **If the customer wishes to** continue using the same hard disk, execute all three SP modes below.
 - SP5-801-014 (Clear DCS Setting)
 - SP5-832-001 (HDD Formatting (ALL))
 - SP5-832-002 (HDD Formatting (IMH))
- **If the customer wishes to** replace the hard disk with a new one, execute SP5-801-014 only.



- If the customer continues using the same hard disk, the overwriting of the data stored on the disk before the option is installed cannot be guaranteed. It is highly recommended to replace the hard disk with a new one.

- 8.** Set SP5-836-001 (Capture Function (0:Off 1:On)) to a value of 0 (disable).

- 9.** Execute SP5-878-001 ([Option Setup: Data Overwrite Security])

If the installation fails, "Installation failed" is displayed when this SP is executed.

- 10.** Print out the System Settings List and make sure that the option was installed successfully.

- 11.** Reconnect the network cable.

- 12.** Execute SP5-990-005 (SP print mode Diagnostic Report).

Make sure to shut down and reboot the machine once before printing the SMC. Otherwise, the latest settings may not be collected when the SMC is printed.

- 13.** Make sure that ROM number "D3BC5757A" and firmware version "1.02" appear in both of the following areas on the report (they must match):

- "ROM Number / Firmware Version" - "HDD Format Option"
- "Loading Program"

2. Installation

Configuring "Auto Erase Memory" (Performed by the Customer)

- 1.** Press the [Settings] icon.
- 2.** Press [Machine Features Settings].
- 3.** Press [System Settings].
- 4.** Press [Administrator Tools].
- 5.** Press [Next] three times.
- 6.** Press [Auto Erase Memory Setting].



- 7.** Press [On].
- 8.** Select the method of overwriting.



- If you select [NSA] or [DoD], proceed to Step 11.
- If you select [Random Numbers], proceed to Step 9.



- 9.** Press [Change].
- 10.** Enter the number of times that you want to overwrite using the ten keys, and then press [#].



The Random Numbers method overwrites the data using random numbers. You can set the overwrite to be performed anywhere from 1-9 times, with a default of 3 times.

- 11.** Press [OK].
- 12.** Make sure that the Data Overwrite icon is displayed in the bottom right-hand corner of the screen.
- 13.** Take a test copy, and then make sure that the Data Overwrite icon changes from "Dirty" (solid) to "Dirty" (blinking), and then to "Clear".
 - If the Data Overwrite icon does not change to Clear, check to see if there are any active Sample Print or Locked Print jobs. A Sample Print or Locked Print job can only be overwritten after it has been executed.
 - The Dirty icon blinks while an overwrite is in progress.
 - If you use your machine for a while with Auto Erase Memory disabled, and then suddenly enable it, the overwrite process may take 10 or more hours depending on HDD usage.

Data Overwrite icon:

	Icon [1]	This icon is lit when there is temporary data to be overwritten and blinks during overwriting.
	Icon [2]	This icon is lit when there is no temporary data to be overwritten.

SP descriptions

- SP5-801-014 (Memory Clear: Clear DCS Setting)
Initializes the DCS (Delivery Control Service) settings.
- SP5-832-001 (HDD Formatting: HDD Formatting (ALL))
Initializes the hard disk.
- SP5-832-002 (HDD Formatting: HDD Formatting (IMH))
Initializes the hard disk.
- SP5-836-001 (Capture Settings: Capture Function (0:Off 1:On))
With this function disabled, the settings related to the capture feature cannot be initialized, displayed, or selected.
- 5-878-001 (Data Overwrite Security)
Enables the Data Overwrite Security unit. Press "EXECUTE" on the operation panel. Then turn the machine off and on.
- SP5-990-005 (SP Print Mode: Diagnostic Report).
Prints the configuration sheets of the system and user settings: SMC.
Make sure to shut down and reboot the machine once before printing the SMC. Otherwise, the latest settings may not be collected when the SMC is printed.

2. Installation

VM CARD Type M37 (D3GF-32)

Component Check

No.	Description	Q'ty
1	SD Card	1



2-4-1-1

Installation Procedure



- When installing more than one SD card, perform the merge operation ([SD Card Appli Move](#)).

1. Remove the SD card slot cover [A].

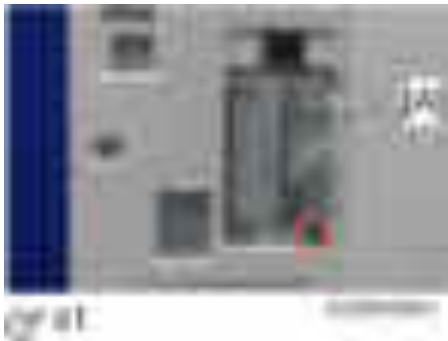

2. Insert the VM Card in SD card slot 2 [A: Lower Slot].



3. Reattach the SD card slot cover. (A ×1)

4. Turn ON the main power.

5. Operate the machine with the JavaVM SD card installed in SD Card Slot 2 (bottom slot).

Installing the Java Platform

Insert the SD card and turn the main power on, then the Java platform is automatically installed.

- Automatic installation takes approximately 1 minute.
- If you turn the power off during installation, the VM card may be damaged.
- Be sure to check the following before turning the power off.
 1. Press [Settings], [Machine Features Settings], and then [Extended Features Settings].
 2. If the installation is completed correctly, [Java™ Platform] appears in the Extended Features Settings menu.
 3. Press [Exit] twice to exit from the Extended Features Settings menu.
 4. Turn the main power off and then back on.
 5. Print out the "Configuration Page", and then check if this option is correctly recognized.
 - Settings > Machine Features Settings > Printer Settings > List/Test Page > Configuration Page

Network Settings

Specifying Network Settings According to Customer's Environment

Specifying Network Settings

Check the customer's network environment and specify network settings according to the functions to be used (such as a scanner, printer, and Document Server setting).

- 1.** Press the "Settings" icon.
- 2.** Press "Machine Features Settings" > "System Settings".
- 3.** On the [Interface Settings] and [File Transfer] tabs, specify the necessary settings.
For the settings to be specified, see the user manual.

Checking Communication by the Ping Command

Check whether a network connection between the machine and the client computer has been established.

- 1.** Press the "Settings" icon.
- 2.** Press "Machine Features Settings" > "System Settings" > "Interface Settings" tab.
- 3.** Press "Ping Command".
- 4.** Enter the client PC's IP address and press "#".



- 5.** If a network connection has been established correctly, the following message appears.



Settings on Displaying an Alert When the Ethernet Cable is Broken or Disconnected

Display an alert if Ethernet cable disconnection occurs while operating the machine.



By default, this setting is set to [OFF] and the interval to display the alert is set to 10 minutes.

Specify the setting according to the customer's request. For customers who do not want to connect the machine to the network, set this setting to [OFF].

- 1.** Press the "Settings" icon.
- 2.** Press "Machine Features Setting" > "System Settings" > "General Settings" tab.
- 3.** Set [Unconnected Network Instruction Screen] to [Display].



This setting can be specified also by SP5-080-003 (UI Display Selection: Network Connection Status).

0: Do not display

1: Display

@Remote Settings



- Prepare and check the following checkpoints before you visit the customer site. For details, ask the @Remote key person.

Checkpoints before making @Remote settings

- 1.** The setting of SP5-816-201 in the mainframe must be "0".
- 2.** Print the SMC with SP5-990-002 and then check if a device ID2 (SP5-811-003) must be correctly programmed.
 - 6 spaces must be put between the 3-digit prefix and the following 8-digit number (e.g. xxx _____xxxxxxx).
 - ID2 (SP5-811-003) and the serial number (SP5-811-001) must be the same (e.g. ID2: A01 _____23456789 = serial No. A0123456789)
 - Make sure to shut down and reboot the machine once before printing the SMC. Otherwise, the latest settings may not be collected when the SMC is printed.
- 3.** The following settings must be correctly programmed.
 - Proxy server IP address (SP5-816-063)
 - Proxy server Port number (SP5-816-064)
 - Proxy User ID (SP5-816-065)Settings
 - Proxy Password (SP5-816-066)

- 4.** Get a Request Number

Execute the @Remote Settings

- 1.** Enter the SP mode.
- 2.** Input the Request number which you have obtained from @Remote Center GUI, and then enter [OK] with SP5-816-202.
- 3.** Confirm the Request number, and then click [EXECUTE] with SP5-816-203.
- 4.** Check the confirmation result with SP5-816-204.

Value	Meaning	Solution/ Workaround
0	Succeeded	-
3	Communication error (proxy enabled)	Check the network condition.
4	Communication error (proxy disabled)	Check the network condition.
5	Proxy error (authentication error)	Check Proxy username and password.
6	Communication error	Check the network condition.
8	Other error	See "SP5816-208 Error Codes" below this.
9	Request number confirmation executing	Processing... Please wait.
11	Already registered	-

Value	Meaning	Solution/ Workaround
12	Parameter error	-
20	Dial-up authentication error	* These errors occur only in the modems that support @Remote.
21	Answer tone detection error	
22	Carrier detection error	
23	Invalid setting value (modem)	
24	Low power supply current	
25	unplugged modem	
26	Busy line	

- 5.** Make sure that the screen displays the Location Information with SP5-816-205 only when it has been input at the Center GUI.
- 6.** Click [EXECUTE] to execute the registration with SP5-816-206.
- 7.** Check the registration result with SP5-816-207.

Value	Meaning	Solution/ Workaround
0	Succeeded	-
1	Request number error	Check the request number again.
2	Already registered	Check the registration status.
3	Communication error (proxy enabled)	Check the network condition.
4	Communication error (proxy disabled)	Check the network condition.
5	Proxy error (Authentication error)	Check Proxy username and password.
8	Other error	See "SP5-816-208 Error Codes" below this.
9	Request number confirmation executing	Processing... Please wait.
11	Already registered	-
12	Parameter error	-
20	Dial-up authentication error	* These errors occur only in the modems that support @Remote.
21	Answer tone detection error	
22	Carrier detection error	
23	Invalid setting value (modem)	
24	Low power supply current	
25	unplugged modem	
26	Busy line	

- 8.** Exit the SP mode.

SP5-816-208 Error Codes

Caused by Operation Error, Incorrect Setting

2.Installation

Code	Meaning	Solution/ Workaround
- 12002	Inquiry, registration attempted without acquiring Request No.	Obtain a Request Number before attempting the Inquiry or Registration.
- 12003	Attempted registration without execution of a confirmation and no previous registration.	Perform Confirmation before attempting the Registration.
- 12004	Attempted setting with illegal entries for certification and ID2.	Check ID2 of the mainframe.
- 12005	@Remote communication is prohibited. The device has an Embedded RCG gate-related problem.	Make sure that "Remote Service" in Settings is set to "Do not prohibit".
- 12006	A confirmation request was made after the confirmation had been already completed.	Execute registration.
- 12007	The request number used at registration was different from the one used at confirmation.	Check Request No.
- 12008	Update certification failed because mainframe was in use.	Check the mainframe condition. If the mainframe is in use, try again later.
- 12009	The ID2 in the NVRAM does not match the ID2 in the individual certification.	Check ID2 of the mainframe.
- 12010	The certification area is not initialized.	Initialize the certification area.

Error Caused by Response from GW URL

Code	Meaning	Solution/ Workaround
-2385	Other error	
-2387	Not supported at the Service Center	
-2389	Database out of service	
-2390	Program out of service	
-2391	Two registrations for the same mainframe	Check the registration condition of the mainframe
-2392	Parameter error	
-2393	External RCG not managed	
-2394	Mainframe not managed	
-2395	Box ID for external RCG is illegal.	
-2396	Mainframe ID for external RCG is illegal.	
-2397	Incorrect ID2 format	Check the ID2 of the mainframe.
-2398	Incorrect request number format	Check the Request No.

SP descriptions

- SP5-816-201 (Remote Service: Regist Status DFU(SSP))**
 Displays a number that indicates the status of the @Remote service device.
 0: Neither the registered device by the external nor embedded RCG device is set.

1: The embedded RCG device is being set. Only Box registration is completed. In this status, this unit cannot answer a polling request from the external RCG.

2: The embedded RCG device is set. In this status, the external RCG unit cannot answer a polling request.

3: The registered device by the external RCG is being set. In this status, the embedded RCG device cannot be set.

4: The registered module by the external RCG has not started.

- **SP5-990-002 (SP Print Mode: SP(Mode Data List))**

Prints the configuration sheets of the system and user settings: SMC.

Make sure to shut down and reboot the machine once before printing the SMC. Otherwise, the latest settings may not be collected when the SMC is printed.

- **SP5-811-003 (Machine No. Setting: ID2 Code Display)**

Sets the ID-2 code used to identify the @remote device at installation.

- **SP5-816-063 (Remote Service: Proxy server IP address)**

This SP sets the address of the proxy server used for communication between the RCG device and the gateway. Use this SP to set up or display the customer proxy server address.

The address is necessary to set up the embedded RCG-N.

The address display is limited to 127 characters. Characters beyond the 127 characters are ignored.

This address is customer information and is not printed in the SMC report.

- **SP5-816-064 (Remote Service: Proxy server Port number)**

This SP sets the port number of the proxy server used for communication between the embedded RCG-N and the gateway. This setting is necessary to set up the embedded RC Gate-N.

This port number is customer information and is not printed in the SMC report.

- **SP5-816-065 (Remote Service: Proxy User ID)**

This SP sets the HTTP proxy certification username.

The length of the name is limited to 31 characters. Any character beyond the 31st character is ignored.

This name is customer information and is not printed in the SMC report.

- **SP5-816-066 (Remote Service: Proxy Password)**

This SP sets the HTTP proxy certification password.

The length of the password is limited to 31 characters. Any character beyond the 31st character is ignored.

This name is customer information and is not printed in the SMC report.

- **SP5-816-202 (Remote Service: Letter Number DFU(SSP))**

Allows entry of the number of the request needed for the RCG-N device.

- **SP5-816-203 (Remote Service: Confirm Execute)**

Executes the inquiry request to the @Remote GW URL.

- **SP5-816-204 (Remote Service: Confirm Result DFU(SSP))**

2. Installation

Displays a number that indicates the result of the inquiry executed with SP5816 203.

- **SP5-816-205 (Remote Service: Confirm Place DFU(SSP))**

Displays the installed section informed from G/W for the response of request number inquiry if the section is enrolled on the G/W.

- **SP5-816-206 (Remote Service: Register Execute)**

Executes "Embedded RCG Registration".

- **SP5-816-207 (Remote Service: Register Result DFU(SSP))**

Displays a number that indicates the registration result.

Security Settings

Security Function Installation

The machine contains the Security functions (Data Overwrite Security and HDD Encryption unit) in the controller board.

If you are installing a new machine, it is recommended to activate the Data Overwrite Security and HDD Encryption by selecting "Format All Data" from "System Settings" on the operation panel.



- This method is recommended because there is no user data on the hard drive yet (Address Book data, image data, etc.).

If the customer wishes to activate the Data Overwrite Security and HDD Encryption unit on a machine that is already running, it is recommended to activate the unit by selecting "All Data" from "System Settings" on the operation panel.



- Selecting "All Data" will preserve the data that has already been saved to the HDD. (If "Format All Data" is selected, all user data saved to the HDD up to that point will be erased).

Immediately after encryption is enabled, the encryption setting process will take several minutes to complete before you can begin using the machine.



- If encryption is enabled after data has been stored on the HDD, or if the encryption key is changed, this process can take up to three and a half hours or more.

The machine cannot be operated while data is being encrypted.

Once the encryption process begins, it cannot be stopped.

Make sure that the machine's main power is not turned off while the encryption process is in progress.

If the machine's main power is turned off while the encryption process is in progress, the HDD will be damaged and all data on it will be unusable.

Print the encryption key and keep the encryption key (which is printed as a paper sheet).

Keep the encryption key in a safe place. If the encryption key is lost and is needed, the controller board, HDD and NVRAM must all be replaced at the same time.



- "NVRAM" mentioned in here means the NVRAM on the Controller Board.
- "NVRAM" or EEPROM on the BCU has nothing to do with this.

Please use the following procedure when the Data Overwrite Security and HDD Encryption are reinstalled.

Data Overwrite Security

Before You Enable the Auto Erase Memory Setting

- 1.** Make sure that the following settings 1 to 3 are not at their factory default values.

2. Installation

1. Supervisor login password
2. Administrator login name
3. Administrator login password

If any of these settings are at a factory default value, tell the customer these settings must be changed.

- 2.** Make sure that "Admin. Authentication" is "ON". "Settings" icon -> "Machine Features Settings" -> "System Settings" -> "Administrator Tools" -> "Administrator Authentication Management" -> "Admin. Authentication"

If this setting is OFF, tell the customer this setting must be ON.

- 3.** Make sure that "Administrator Tools" is enabled (selected).
"Settings" icon -> "Machine Features Settings" -> "System Settings" -> "Administrator Tools" -> "Administrator Authentication Management" -> "Available Settings"

If this setting is disabled (not selected), tell the customer this setting must be enabled (selected) .

How to Enable Auto Erase Memory Setting

The Auto Erase Memory function can be enabled by the following procedure.

- 1.** Log in as the machine administrator from the operation panel.
- 2.** Press the [Settings] icon.
- 3.** Press [Machine Features Settings].
- 4.** Press [System Settings].
- 5.** Press [Administrator Tools].
- 6.** Press [Next] three times.
- 7.** Press [Auto Erase Memory Setting].





- 8.** Press [On].
- 9.** Select the method of overwriting.
If you select [NSA] or [DoD], proceed to step 12.
If you select [Random Numbers], proceed to step 10.
- 10.** Press [Change].
- 11.** Enter the number of times that you want to overwrite using the number keys, and then press [#].
- 12.** Press [OK]. Auto Erase Memory is set.

- 13.** Log out.
- 14.** Check the display and make sure that the overwrite erase icon appears.
- 15.** Check the overwrite erase icon.

The icon [1] is lit when there is temporary data to be overwritten and blinks during overwriting.
The icon [2] is lit when there is no temporary data to be overwritten.

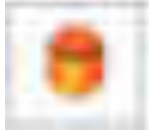

	Icon [1]	This icon is lit when there is temporary data to be overwritten and blinks during overwriting.
	Icon [2]	This icon is lit when there is no temporary data to be overwritten.

HDD Encryption

Before You Begin the Procedure

- 1.** Make sure that the following settings (1) to (3) are not at the factory default settings.
 - (1) Supervisor login password
 - (2) Administrator login name
 - (3) Administrator login password
 If any of these settings are at the factory default value, tell the customer these settings must be changed before you do the installation procedure.
- 2.** Confirm that "Admin. Authentication" is on:

[Settings] icon - [Machine Features Settings] - [System Settings] - [Administrator Tools] - [Administrator Authentication Management] - [Admin. Authentication] - [On]

 If this setting is off, tell the customer that this setting must be on before you can do the installation procedure.
- 3.** Confirm that "Administrator Tools" is selected and enabled.

[Settings] icon - [Machine Features Settings] - [System Settings] - [Administrator Tools] - [Administrator Authentication Management] - [Available Settings]

 "Available Settings" is not displayed until step 2 is done.

2. Installation

If this setting is not selected, tell the customer that this setting must be selected before you can do the installation procedure.

Installation Procedure

- 1.** Turn ON the main power, and then enter the SP mode.
- 2.** Select SP5-878-002, and then press "Execute".
- 3.** Exit the SP mode after "Completed" is displayed.
- 4.** Turn OFF the main power.

Enable Encryption Setting

Machine Data Encryption Settings can be enabled by the following procedure.



- When setting up encryption, specify whether to start encryption after deleting data (initialize) or encrypt and retain existing data. If data is retained, it may take some time to encrypt it.

- 1.** Turn ON the main power.
- 2.** Log in as the machine administrator from the operation panel.
- 3.** Press the [Settings] icon.
- 4.** Press [Machine Features Settings].
- 5.** Press [System Settings].
- 6.** Press [Administrator Tools].
- 7.** Press [Next] three times.
- 8.** Press [Machine Data Encryption Settings].



- 9.** Press [Encrypt].



- 10.** Select the data to be carried over to the HDD and not be reset.
To carry all of the data over to the HDD, select [All Data].
To carry over only the machine settings data, select [File System Data Only].
To reset all of the data, select [Format All Data].
- 11.** Select the backup method.



If you have selected [Save to SD Card], load an SD card into the media slot on the side of the operation panel and press [OK] to back up the machine's data encryption key.

If you have selected [Print on Paper], press the [Start] key. Print out the machine's data encryption key.

2. Installation



12. Press [OK].

13. Press [Exit].



14. Press [Exit].

15. Log out.

16. Turn OFF the main power, and then turn the main power back ON.

The machine will start to convert the data on the memory after you turn on the machine. Wait until the message "Memory conversion complete. Turn the main power switch off." appears, and then turn the main power off again.

Check the Encryption Settings

- 1.** Press the [Settings] icon.
- 2.** Press [Machine Features Settings].
- 3.** Press [System Settings].
- 4.** Press [Administrator Tools].
- 5.** Press [Machine Data Encryption Settings].

6. Confirm whether the encryption has been completed or not on this display.



Print the encryption key

Use the following procedure to print the key again if it has been lost or misplaced.

1. Press the [Settings] icon.
2. Press [Machine Features Settings].
3. Press [System Settings].
4. Press [Administrator Tools].
5. Press [Machine Data Encryption Settings].
If this item is not visible, press [Next] to display more settings.
6. Press [Print Encryption Key].

Encryption key sample



The encryption key is printed out as a sheet of paper like the example shown above. Please instruct the customer to keep it in a safe place.

2. Installation

Backing Up the Encryption Key

The encryption key can be backed up. Select whether to save it to an SD card or to print it.



- The encryption key is required for data recovery if the machine malfunctions. Be sure to store the encryption key safely for retrieving backup data.

- 1.** Log in as the machine administrator from the operation panel.
- 2.** Press the [Settings] icon.
- 3.** Press [Machine Features Settings].
- 4.** Press [System Settings].
- 5.** Press [Administrator Tools].
- 6.** Press [Next] three times.
- 7.** Press [Machine Data Encryption Settings].
- 8.** Press [Print Encryption Key].



- 9.** Select the backup method.

If you have selected [Save to SD Card], load an SD card into the media slot on the side of the operation panel and press [OK]; once the machine's data encryption key is backed up, press [Exit].
If you have selected [Print on Paper], press the [Start] key. Print out the machine's data encryption key.

- 10.** Press [Exit].
- 11.** Log out.

Encryption Key Restoration

How to restore the old encryption key to the machine

The following message appears after the controller board is replaced. In such a case, it is necessary to restore the encryption key to the new controller board.



To do this, follow the procedure below.

- 1.** Prepare an SD card that has been initialized in FAT16 format.
- 2.** Using a PC, create a folder in the SD card and name it "restore_key".
- 3.** Create a folder in the "restore_key" folder and name it the same as machine's serial number, "xxxxxxxxxxxx" (11 digits).
- 4.** Create a text file called "key_xxxxxxxxxx.txt" and save it in the "xxxxxxxxxxxx" folder. Write the encryption key in the text file.

```
/restore_key/xxxxxxxxxxxx/key_xxxxxxxxxx.txt
```



- Ask an Administrator to enter the encryption key. The key has already been printed-out by the user and may have been saved in the "key_xxxxxxxxxx.txt" file. (The function of back-up the encryption key to the SD card directly is provided 11A products or later.)

- 5.** Turn ON the machine's main power.
- 6.** Confirm that a message is displayed on the LCD telling to insert the SD card that contains the encryption key.
- 7.** Turn OFF the main power.
- 8.** Insert the SD card that contains the encryption key into SD card slot 2 (the lower slot).
- 9.** Turn ON the main power.



- The machine will automatically restore the encryption key to the flash memory on the controller board.

- 10.** Turn OFF the main power when the machine has returned to normal status.
- 11.** Remove the SD card from SD card slot 2.

How to do a forced startup with no encryption key

If the encryption key back-up has been lost, follow the procedure below to do a forced start-up.

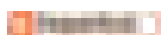

- The HDD will be formatted after the forced start-up.
- Encrypted data will be deleted.
- User settings will be cleared.

- 1.** Prepare an SD card.
- 2.** Create a directory named "restore_key" inside the root directory of the SD card. Then, save the "nvram_key.txt" file using the following name:

```
/restore_key/nvram_key.txt
```

- 3.** Create a text file and write "nvclear".



- Write this string at the head of the file.
- Use all lower-case letters.
- Do not use quotation marks or blank spaces.

2. Installation

- It is judged that a forced start has been selected when the content of "nvclear" is executed and the machine shifts to the alternate system (forced start).
- 4.** Confirm that a message is displayed on the LCD telling to insert the SD card that contains the encryption key.
 - 5.** Turn off the main power.
 - 6.** Insert the SD card that contains the encryption key into SD card slot 2 (the lower slot).
 - 7.** Turn ON the main power.
The machine automatically clears the HDD encryption.
 - 8.** Turn OFF the main power when the machine has returned to normal status.
 - 9.** Remove the SD card from SD card Slot 2.
 - 10.** Turn ON the main power.
 - 11.** Memory clear SP5-801-xxx (Exclude SP-5-801-001: All Clear and SP-5-801-002: Engine), and clear SP5-846-046: an address book.
 - 12.** Set necessary user settings in the "Settings" menu.

SP descriptions

- **SP5-878-002 (Option Setup: HDD Encryption)**
Executes the setup for encryption.
- **SP5-990-005 (SP Print Mode: Diagnostic Report)**
Prints the configuration sheets of the system and user settings: SMC.
Make sure to shut down and reboot the machine once before printing the SMC. Otherwise, the latest settings may not be collected when the SMC is printed.
- **SP5-801-001 (Memory Clear: All Clear)**
Resets all correction data for process control and all software counters, and returns all modes and adjustments to their default values.
- **SP5-801-002 (Memory Clear: Engine)**
Clears non-volatile memory of engine.
- **SP5-846-046 (UCS Setting: Addr Book Media)**
Displays the slot number where an address book data is in.
0: Unconfirmed
1: SD Slot 1
2: SD Slot 2
3: SD Slot 3
4: USB Flash ROM
10: SD Slot 10
20: HDD
30: Nothing

"Web Help Support" Settings

Overview

The Web Help Support function is a feature that assists users on the operation panel. When a user encounters troubles when operating a machine, the solution is displayed on the operation panel and a user can attempt to resolve the problem on his or her own. By offering this solution, we aim to reduce the number of calls, thereby improving the rate of self-resolution. This function is available when the machine is connected to the Internet.

[A]: Tap "?" to display help contents



The Web Help Support function is preinstalled and enabled by default. Specify whether or not to enable or disable the function in SP or UP mode.

How to Enable/Disable Web Help Support

This function is enabled by default. If a customer is not willing to use this function, the function can be disabled via UP and SP as follows:

UP setting

1. Select "Screen Device Settings".



2. Installation

2. Select Support Settings.



3. Enable or disable Help Functions.

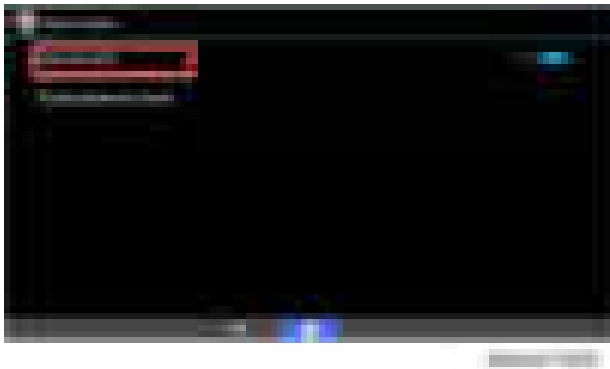

SP setting

1. Log in to Screen SP mode.

2. Select "Screen Device Settings".

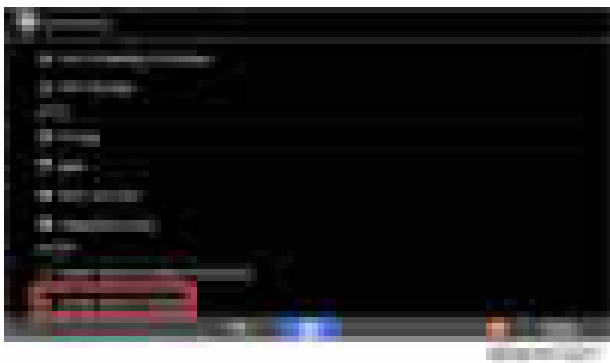

3. Select "Application Settings".

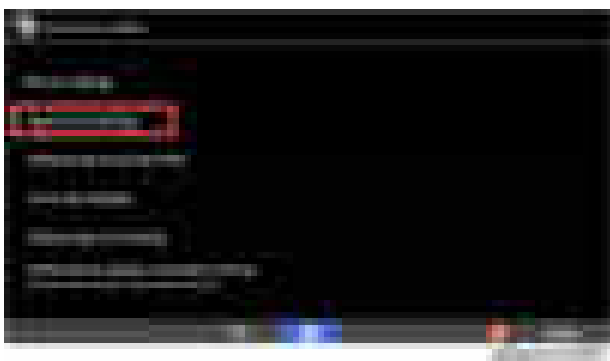

- 4.** Select "Settings" for "Support Settings".

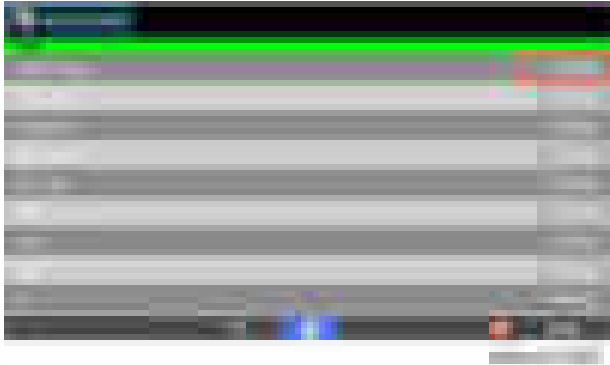

- 5.** Enable or disable Help Functions.

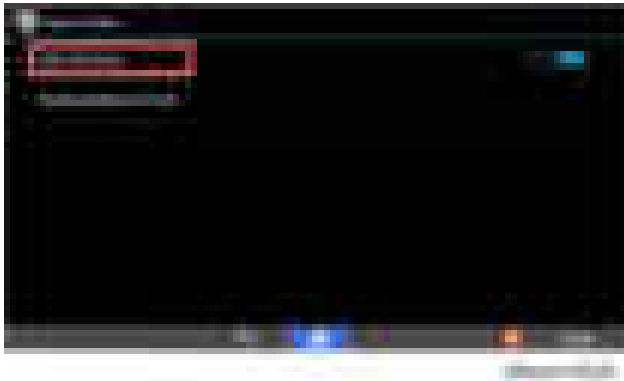

If this function is disabled in SP mode, the function in the UP setting menu will not be displayed.

"RemoteConnect Support" Settings

Overview

The RemoteConnect Support function allows monitoring and remote control of the customer's machine's operation panel.

- Allow a customer support operator to remotely connect with client's machine equipped with the Smart Operation panel (SOP-G2), or PC over the internet.
- Enable the support center to diagnose and resolve the issue through real-time screen sharing, remote guidance, and operation.



Previously, to avoid security concerns, the function was disabled by default. However, this has changed and the application is now enabled by default on machines produced since September 2018. (This setting is enabled by default on the current model.)

So, it's necessary to confirm with customers whether enabling the remote function is acceptable. If after explaining the function and benefits, the customer does not agree, then disable it via SP mode.

How to Enable/Disable RemoteConnect Support

- 1.** Log in to Screen SP mode.
- 2.** Select "Screen Device Settings".

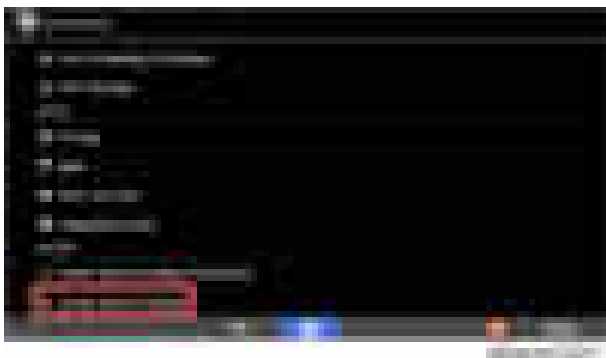

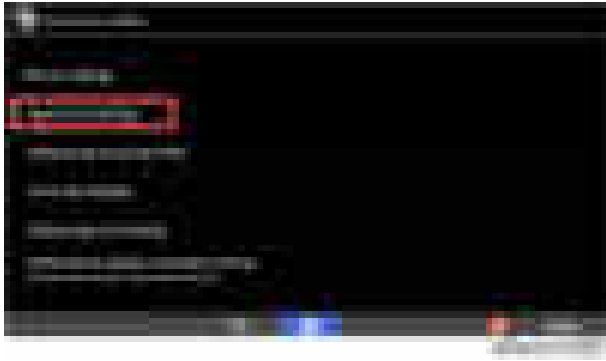
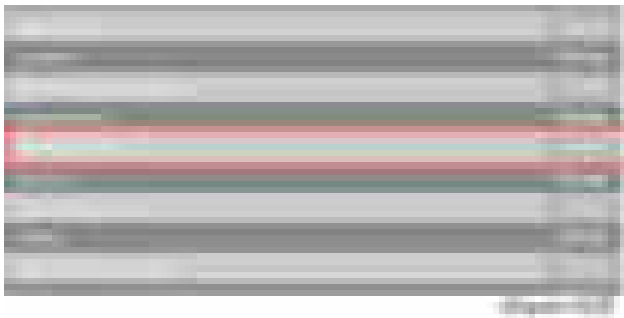
3. Select "Application Settings".**4.** Select "Settings" in "RemoteSupportService" and check "Service availability".

- The application is enabled by default on machines produced from August 2018.
- The setting is located in RemoteSupport Service. However, the name of settings menu is RemoteConnect Support settings, You can find "RemoteConnectSupport" in the applications list, however, it does not have any settings, be sure to open the settings of "RemoteSupportService".

**5.** Confirm if a connection can be established.

To confirm if RemoteConnect Support is working properly, open the application from the "Check Status" menu or by pressing down on the status bar on the Smart Operation Panel for over five

2.Installation

seconds.

After pressing down for over five seconds, stop pressing on the panel and RemoteConnect Support will open.



If setup was done correctly, four digits will be displayed on the panel. If the setup was not done correctly, the four digits will not be displayed.



RemoteConnect Service needs an Internet connection, so the following error message might appear after long-pressing the status bar if an Internet connection is not detected. To check the connection, open the web browser in Smart Operation Panel and navigate to a webpage to confirm that the machine is connected to the Internet.



- If a webpage cannot be connected to via the web browser, check the general network configuration settings, such as the IP address and proxy settings.

Uninstalling RemoteConnect Support

Some customers might ask for this feature to be disabled because of security precautions. In many cases, disabling RemoteConnect Support should be sufficient.

However, if a customer asks for RemoteConnect Support to be completely uninstalled, remove it by conducting the following procedure:

- 1.** Log in to Screen SP mode.
- 2.** Select Apps > Install.
- 3.** Select Uninstall for the following two applications:

Firmware Type	Part Number	Version
RemoteConnectSupport	D2411470A	1.0.5
RemoteSupportService	D1961459A	1.0.1

"Remote Panel Operation" Settings

Overview

Remote Panel Operation will be pre-installed in models that have Smart Operation Panel G2.5. This is a built-in function.

Using Web Image Monitor, you can view on your computer screen the operation panels of devices on the same network as well as remotely control such devices. For example, in a large company, the machine administrator can use remote control to check for errors, operate machines, and change settings to provide support and manage machines easily.



[A]: Smart Operation Panel G2.5

[B]: Web browser

[C]: IT manager/ administrator

- Eliminating a trip to device
- Reducing end-user's wait time

Usage

- Remote Panel Operation enables the IT manager or in-house help desk staff to remotely view and operate the Smart Operation Panel G2 screen through a Web UI.
- It can be used to provide real-time interactive user support and also facilitate customer training.

Start Up

- 1.** Log in to Web Image Monitor as the administrator.

2. Click [Device Management] > [Remote Panel Operation]

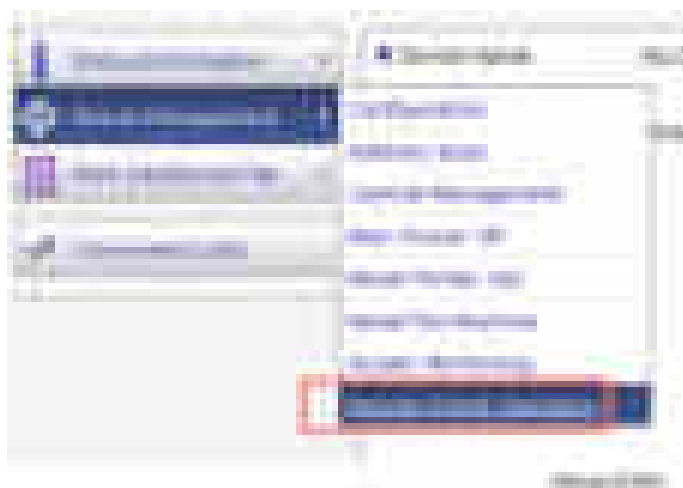

Notes

- When connected by the Remote Panel Operation function, the machine does not automatically switch to Sleep mode, and the Auto Logout and System Auto Reset functions do not operate.
- You cannot connect to a single unit from multiple computers and operate it by the Remote Panel Operation function.
- The Remote Panel Operation function is supported by Internet Explorer 11 and later versions, Google Chrome 62 and later versions, Firefox 56 and later versions, and Microsoft Edge 40 and later versions.

About the Settings

- This function has been preinstalled. (Its icon does not appear on the operation panel.)
- For security reasons, the settings have not been specified by default. Enable or disable each setting according to the customer's request.

How to Enable/Disable Remote Panel Operation/Monitoring

1. Enable machine administrator authentication and login as administrator.
2. Press the "Settings" icon on the HOME screen.
3. Press "Basic Settings for Extended Devices".



2. Installation

4. Press "Remote Panel Operation".

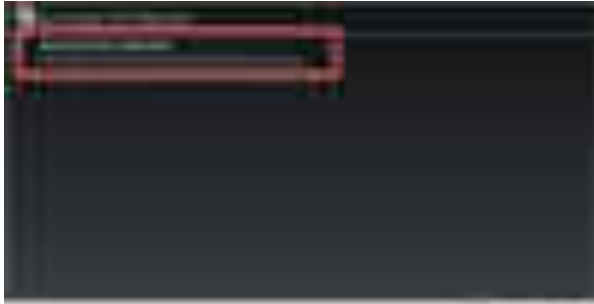

5. Enable "Remote Operation/Monitoring Functions".

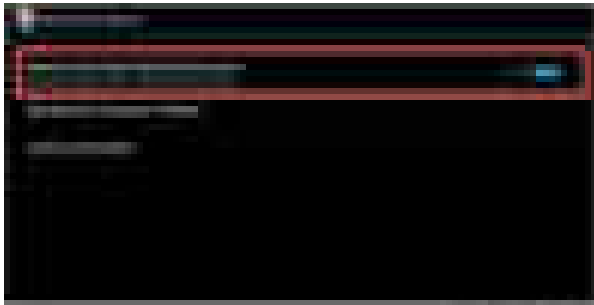

- "Remote Operation/Monitoring" Functions is disabled at default. When it is disabled, Remote Panel Operation is not displayed in the Web Image Monitor.

Operation Guidance for Users

Provide guidance for the following operations.

Be sure to explain that the user can always check the Help by the Web Help Support function.

Basic Operations

- Copy
- Fax
- Registering, editing and removing the address book
- Scan
- Register Scan to Folder destinations
- Print
- Manage Files via Document Server
- Configure/manage the machine via the web browser (Web Image Monitor)

Load paper and configure paper settings

- Load paper in the bypass tray
- Load paper in the paper tray
- Configure paper tray settings on the operation panel
- Replace consumables

Install the printer driver

- Install the downloaded printer driver (Windows)
- Install the downloaded printer driver (OS X / macOS)

Checking the Connection of Peripherals and Options

Peripherals

You can check the connection of peripherals by printing the configuration page (system summary).

- "Settings" icon > Machine Features > Printer Settings> List/Test Print > Configuration Page

The names printed on the configuration page are not the product name but names on the user interface. For example, 1 Bin Tray BN3130 is printed as "Internal Tray 2".

Printed Item	Peripherals That Are Printed If Connected
Device Connection	Wireless LAN, IEEE 1284
Attached Equipment	Paper Feed Unit PB3280 / B3300 (D3FY / D3FZ), Paper Feed Unit PB3270 (D3G0), LCIT PB3290 (D3G2), LCIT RT3040 (D3G1), 1 Bin Tray BN3130 (D3CQ), Internal Shift Tray SH3080 (D3FV), Side Tray Type M37 (D3FX), Booklet Finisher SR3290 (D3FN) / Finisher SR3280 (D3G4), Booklet Finisher SR3270 (D3FQ), Finisher SR3260 (D3FR), Internal Finisher SR3250 (D3FG), Internal Finisher SR3300 (D3FT), Internal Multi-Fold Unit FD3010 (D3FS)

2. Installation

Printer Language SD Card

Check the connection of the optional printer language SD card not printed as follows.

- Is it possible to switch to the printer language added by the printer application?
- Does the information about the added printer language appear in the Web Image Monitor home > Status/Information > Device Info.?



Figure 2-10

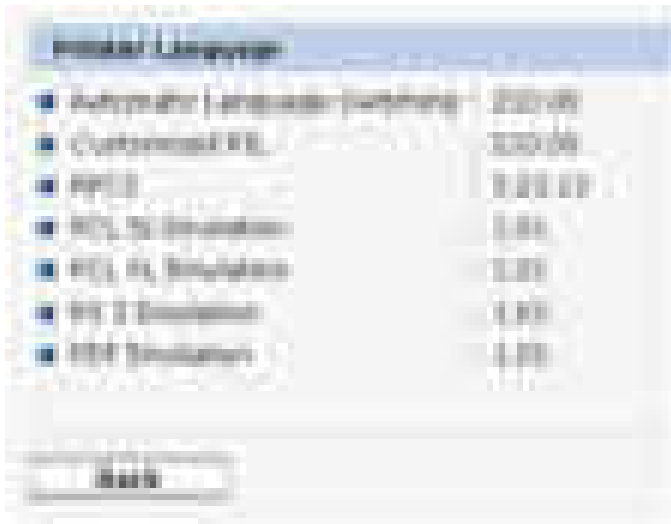

Figure 2-11

- Check if the software serial number/version of the added printer language appears on SP-5-990-005 (Diagnostic Report).

3. Preventive Maintenance

PM Parts Settings

Replacement Procedure of the PM Parts

There are two ways to reset the PM counter for this machine.

"Method 2 By [PM Counter / New Unit Set] Menu" is recommended for its ease of operation.



- After the PM counter for the fusing sleeve belt unit reaches its PM life (400K pages or 313,153,000 mm), the machine stops the operation automatically. Replace the fusing sleeve belt unit, or fusing unit before the machine stops its operation (stop warning: 415K pages or 302,229,000 mm, stop: 430K pages or 313,153,000 mm).



- For the following units, there is a new unit detection mechanism. It is not necessary to set SPs (New Unit Detection).
 - PCDU as a complete unit
 - Fusing Unit as a complete unit
 - Waste Toner Bottle (When the machine stopped because the waste toner bottle was full)
 - Image Transfer Unit as a complete unit (Image Transfer Belt Unit+Image Transfer Cleaning Unit)

Method 1: By SP3701

1. Enter the SP mode.

2. Output the SMC logging data with SP5-990-004.

Make sure to shut down and reboot the machine once before printing the SMC. Otherwise, the latest settings may not be collected when the SMC is printed.

3. Set the following SPs (New Unit Detection) to "1".

Item	SP	Replacement procedure
Development unit	Black: SP3-701-003 Yellow: SP3-701-072 Cyan: SP3-701-026 Magenta: SP3-701-049	PCU/Development Unit
PCU	Black: SP3-701-002 Yellow: SP3-701-071	PCU/Development Unit

3.Preventive Maintenance

Item	SP	Replacement procedure
	Cyan: SP3-701-025 Magenta: SP3-701-048	
Fusing sleeve belt unit	SP3-701-116	Fusing Sleeve Belt Unit
Pressure Roller	SP3-701-118	Pressure Roller
Image Transfer Belt Unit	SP3-701-093	Image Transfer Belt Unit
Image Transfer Belt Cleaning Unit	SP3-701-102	Image Transfer Cleaning Unit
Paper Transfer Roller Unit	SP3-701-109	Paper Transfer Roller
Waste Toner Bottle (When the bottle is replaced before the machine detects bottle full and stops)	SP3-701-142	-
Exhaust Filter	SP3-701-131	Exhaust Filter
ADF	Pick-Up Roller: SP3-701-206 Feed Belt:SP3-701-207 Separation Roller: SP3-701-208	-

- 4.** Turn the main power switch OFF, and disconnect the power cord from the outlet.
- 5.** Replace the PM parts and turn the main power ON.
The machine will reset the PM counters automatically. In the case of the development unit, developer initialization will also be done automatically.
- 6.** Exit the SP mode.

Method 2: By [PM Counter / New Unit Set] Menu

- 1.** Enter the SP mode.
- 2.** Output the SMC logging data with SP5-990-004.
Make sure to shut down and reboot the machine once before printing the SMC. Otherwise, the latest settings may not be collected when the SMC is printed.

- 3.** Press [PM Counter / New Unit Set].



- 4.** Press [All PM Parts List: New Unit Set].

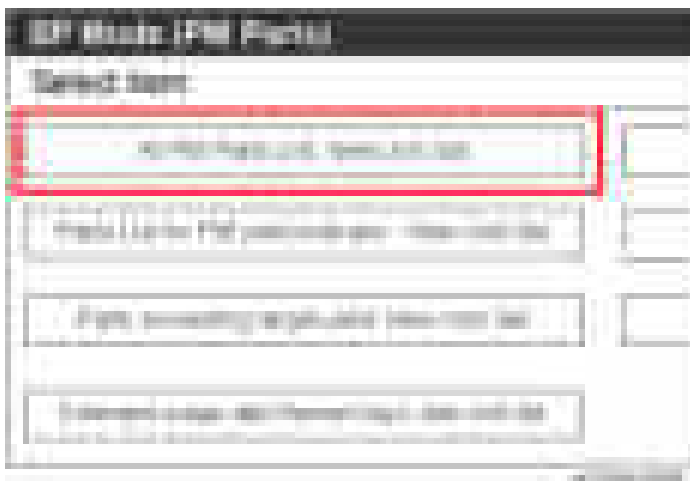

- 5.** Set the PM part that you want to replace to "YES" under "New Unit Set".
After pressing "YES", the [Exit] key will not be available.



- 6.** Turn OFF the main power and unplug the power cord from the wall outlet.
7. Replace the PM parts and turn the main power ON.
The machine will reset the PM counters automatically. In the case of the development unit,

3.Preventive Maintenance

developer initialization will also be done automatically.

After Installing the New PM Parts

- 1.** Output the SMC logging data with SP5-990-004 and check the counter values.
Make sure to shut down and reboot the machine once before printing the SMC. Otherwise, the latest settings may not be collected when the SMC is printed.
- 2.** Make sure that the PM counters for the replaced units are "0" with SP7-621 or SP7-944. If the PM counter for a unit was not reset, then execute the new unit detect setting with SP3-701 again and turn the machine OFF/ON.
- 3.** Make sure that the exchange counter counts up with SP7-853.
- 4.** Make sure that the counters for the previous units (SP7-908) on the new SMC logging data list (from step 2 above) are equal to the counters (SP7-621, or SP7-944) for these units on the previous SMC logging data list (the list that was output in the "Before removing the old parts" section).
- 5.** Make sure that the unit replacement date is updated with SP7-950.

SP Descriptions

- **SP7-621-001 (PM Counter Display: Paper)**
Displays the number of sheets printed for each current maintenance unit.
When a unit is replaced, the machine automatically detects that the new unit is installed.
Then, the current PM counter value is automatically moved to the PM Counter – Previous (SP7-906-1 to 10) and is reset to "0".
- **SP7-853 (Replace Counter)**
Displays the number of times each PM part has been replaced.
- **SP7-908 (Previous Unit Counter: Pages (%))**
Displays the PM counter of the previous PM Part which was replaced last time.
- **SP7-950 (Unit Replacement Date)**
Displays the replacement date of each PM unit.
- **SP5-990**
Prints the configuration sheets of the system and user settings: SMC.
Make sure to shut down and reboot the machine once before printing the SMC. Otherwise, the latest settings may not be collected when the SMC is printed.

Operation Check

- Clean the exposure glasses with the cleaning cloth before the operation check.
- Perform the operation check in the following order: Color Registration > Auto Color Calibration (ACC) > Sample Image Check

Color Registration

- 1.** Press [Settings] on the HOME screen.

2. Press [Machine Features Settings] > [Maintenance] > [Color Registration].



3. Press [OK].



4. After the adjustment is complete, press [Exit].

Auto Color Calibration (ACC)

Do the "Auto Color Calibration (ACC)" for the copier mode & printer mode as follows:

- Copier mode -

1. Press [Settings] on the HOME screen.
2. Press [Machine Features Settings] > [Maintenance] > [Auto Color Calibration]



3. Press [Start] for Copier Function.
4. Press [Start Printing] to print the test pattern.
5. Put the test pattern on the exposure glass.

3.Preventive Maintenance

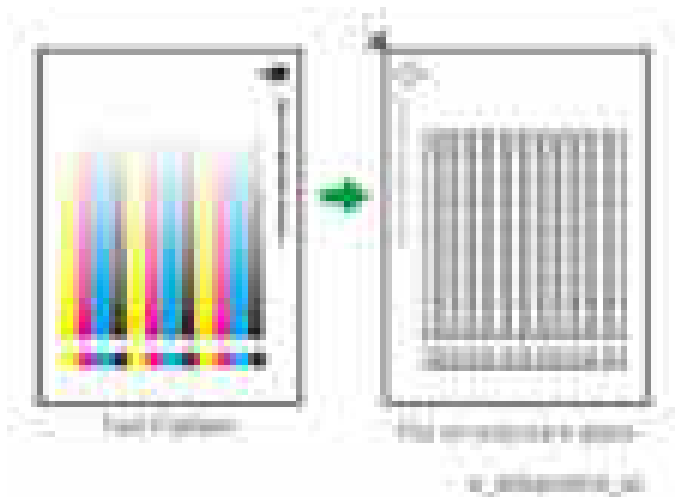

6. Put 10 sheets of white paper on the test chart. This ensures the precise ACC adjustment.

7. Close the SPDF/ARDF or the platen cover.

8. Press [Start Scanning].

The machine starts the ACC.

- Printer mode -

1. Then, Press [Start] for Printer Function.

2. Press [Start Printing] to print the test pattern.

3. Press [Quick Test Pattern], then press [Start Printing] to print the test pattern.

The test pattern is printed after self-checking.



4. Put the printout on the exposure glass.

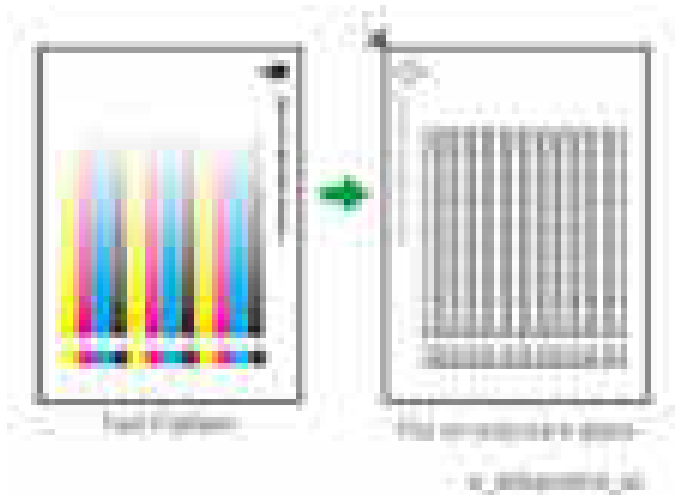

- 5.** Put 10 sheets of white paper on the test chart. This ensures the precise ACC adjustment.
- 6.** Close the SPDF/ARDF or the platen cover.
- 7.** Press [Start Scanning].
The machine starts the ACC.
- 8.** Confirm that the execution result is displayed.
For the Quick Test Pattern, the execution result is recorded with all resolutions (patterns 1 to 5).



Sample Image Check

- 1.** Check if the sample image has been copied normally.

3.Preventive Maintenance

PM Parts List

See "Appendices" for the following information:

- Preventive Maintenance Items

4. Replacement and Adjustment

Notes on the Main Power Switch

Push Switch

The main power button of this machine has been changed to a push-button switch (push button) from the conventional rocker switch. The push switch has characteristics and specifications different from the rocker switch. Care must be taken when replacing and adjusting parts.

Characteristics of the Push Switch (DC Switch)

Power is supplied to the machine even when the main power switch is turned OFF.

The push switch in this machine uses DC (direct current). Therefore, if the AC power cord is connected to an electrical outlet, power is supplied to the controller board, the operation unit, and other modules even when the main power is turned OFF. When replacing the controller board and the operation unit in this state, not only these boards, it will damage other electrical components.

So, when performing maintenance work such as replacing parts, in addition to turning off the main power with the push switch, always unplug the AC power cord.

When you disconnect the power cord from the AC wall outlet, inside the machine there is still residual charge.

When you disconnect the power cord from the AC wall outlet, inside the machine for a while there is still residual charge. Therefore, if you remove boards in this state, it can cause a blown fuse or memory failure.

- How to remove the residual charge inside the machine
After you unplug the power cord from the AC wall outlet, in order to remove the residual charge from inside the machine, be sure to press the main power switch. Thus, the charge remaining in the machine is released, and it is possible to remove boards.

When you reconnect the AC power cord into an AC wall outlet, the machine will start automatically.

In order to remove the residual charge, push the main power switch while you disconnect the AC power cord. At that time, the power ON flag inside the machine is set. Therefore, after you finish work on the machine and reconnect the power cord to the AC, even if you do not press the main power switch, the machine will start automatically and the moving parts will begin to move. When working on moving parts, be careful that fingers or clothes do not get caught.



- Automatic restart deals with cases when you accidentally unplugged the AC power cord or unexpected power outages. By keeping the power flag ON, after the resumption of power, the

4.Replacement and Adjustment

machine will start up automatically.

In rare cases, when you reconnect the AC power cord to a power outlet, the machine does not start automatically. In this case, the machine has not failed. The cause is due to the timing of releasing the residual charge. If you press the main power switch while the residual charge was already released, the power ON flag will not be set. At this time, start the machine manually by pressing the main power switch.

Shutdown Method

1. Press the main power switch [A] on the machine.



2. The shutdown message appears. After the shutdown process, the main power is turned off automatically.

The operation panel and the main power indicator are turned off when the machine completes the shutdown.



- Even after the shutdown message disappears, do not disconnect the power cord while the main power indicator [A] is flashing to indicate that the machine is still shutting down.



- Before removing and adjusting electrical boards, do the following procedure. Otherwise, the board can be damaged by the residual charge inside the machine and must be replaced.
 1. Take out the power cord after shutdown.
 2. Press the power switch for a second to remove the residual charge inside the machine.

Forced Shutdown

In case normal shutdown does not complete for some reason, the machine has a forced shutdown function.

To make a forced shutdown, press and hold the main power switch for 6 seconds.

In general, do not use the forced shutdown.



- A forced shutdown may damage the hard disk and memory, and can cause damage to the machine. Use a forced shutdown only if it is unavoidable.

4.Replacement and Adjustment

Beforehand



- Turn off the main power switch and disconnect the power cord.
- After replacing, make sure that all harnesses that were removed are connected up again and secured in their clamps.

Special Tools and Lubricants

Special Tools and Lubricants

The following special tools should be prepared for the maintenance of the new model in the field:

Unique or Common:

U: Unique for this model

C: Common with listed model

Item	Part Number	Description	Q'ty	Unique or Common
1	B6455030	SD Card 2GB	1	C (General)
2	B6455040	SD Card 8GB	1	C (General)
3	B6455060	SD Card (16GB)	1	C (General)
4	52039502	Silicone Grease G-501	1	C (General)
5	A2579300	Grease Barrierta – S552R	1	C (General)
6	C4019503	20× Magnification Scope	1	C (General)
7	VSSG9002	FLUOTRIBO MG GREASE: 100G	1	C (General)
8	VSST9003	C-5Y COLOR TEST CHART (2 SHEETS / 3 sets)	1	C (General)
9	-	Quick Migration Tool (SD Card)	1	C (General)



- A PC (Personal Computer) is required for creating the Encryption key file to an SD card when replacing the controller board for a model in which HDD encryption has been enabled.
- 16GB SD card is necessary to capture the debug logs from 16S and later models except for MP C306.

Where to Apply Noise-Reduction Grease

Drive Train at Duplex Unit Paper Exit

Apply an appropriate amount to the teeth of 4 of the 6 drive gears (as shown below in red) at the rear of the duplex unit.

- One spot on teeth of the one-way clutch gear
- One spot on teeth of the idler gear
- One spot on teeth of the by-pass feed transport roller gear
- One spot on teeth of the by-pass separator drive gear

4.Replacement and Adjustment



Lubrication parts

4 gears (4 parts)

Lubrication amount

Maximum [A] and minimum [B]

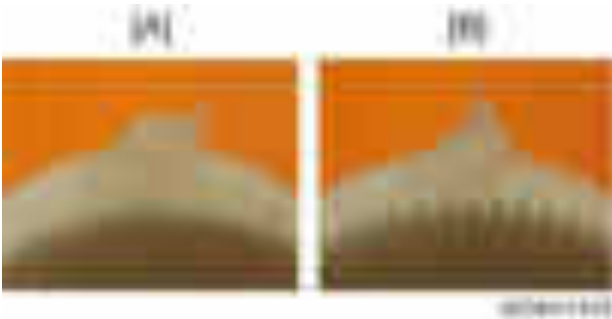

Duplex (on Machine's Side): Duplex Drive on Machine's Side: Gear Shaft at Duplex Unit Paper Exit

Lubricate the stud on the bracket of the right door open/close sensor (parts in yellow circles in following diagram).

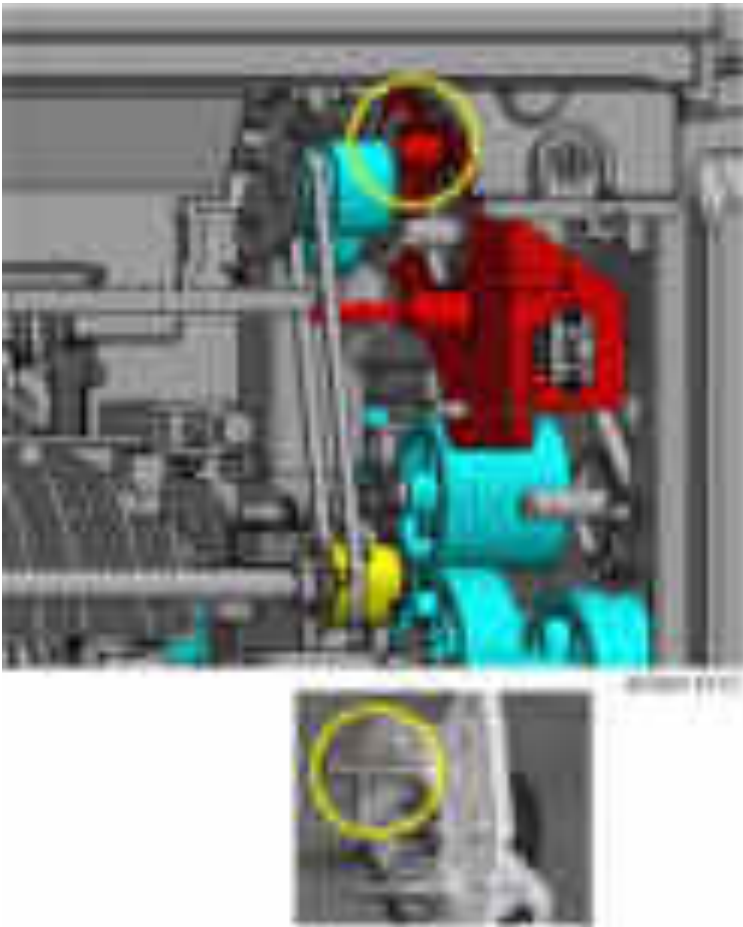

Lubrication parts

Stud (2 parts)

Lubrication amount

Maximum [A] and minimum [B]



Laser: Laser Unit: Laser Optics Positioning Motor Shaft

Apply an appropriate amount to the screws at the tips of the laser optics positioning motor shafts used for adjusting the tilt of the second mirrors for CMY.

(Parts in yellow circles in the following diagram. These worm gears are revealed by removing the adjusters [A] pressing the mirrors.)

4.Replacement and Adjustment

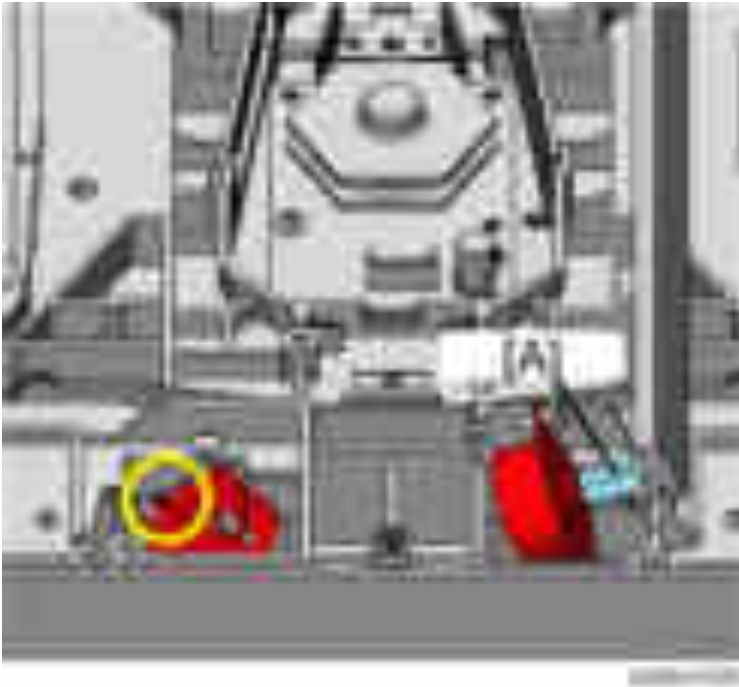

Lubrication parts

3 screws (3 motors)

Lubrication amount

Maximum [A] and minimum [B]

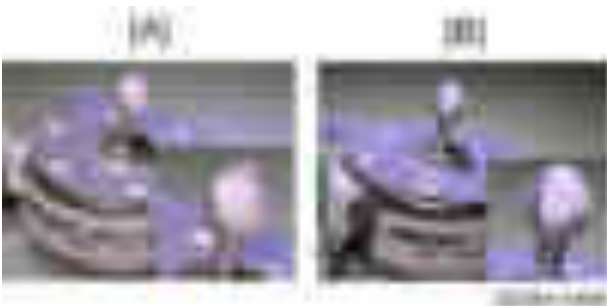

Paper Feed: Slide Bearings of Registration Roller

Of the 3 slide bearings on the registration roller, apply an appropriate amount to the registration roller shaft that is in contact with the slide bearing at the rear end (part in the yellow circle in the following diagram). (Do not lubricate the part of the shaft and bearings in the paper path.)

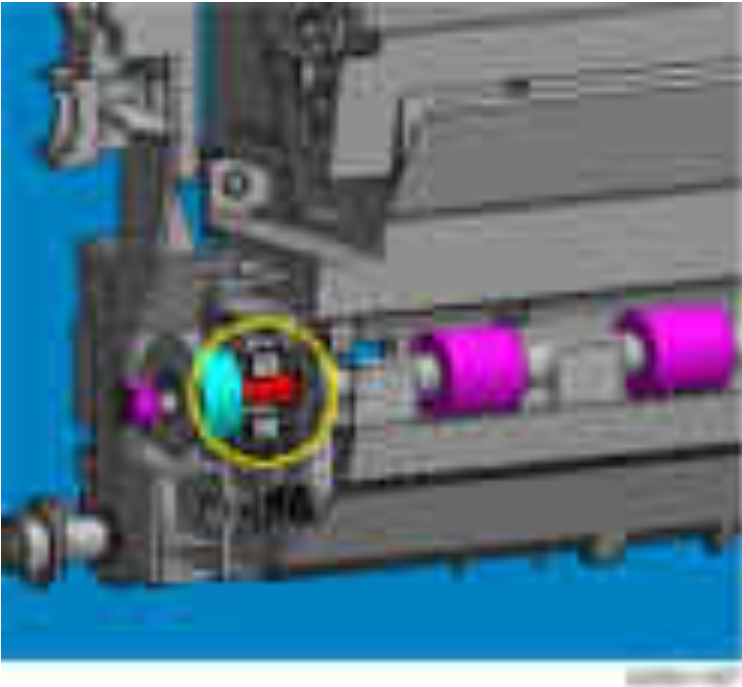

Lubrication parts

Bearing (shaft) (1 part)

Lubrication amount

Maximum [A] and minimum [B]



Drive: Registration Motor

Lubrication for preventing noise and vibration and for extending life (red part in the following diagram).

- Registration motor gear: 2 circumferences × 2 spots (4 spots)
- Registration motor stud: on both sides of the groove (2 spots)

4.Replacement and Adjustment



Lubrication parts

- Gear (4 spots)
- Shaft (stud) (2 spots)

Lubrication amount

Maximum [A] and minimum [B]

Gear



Stud



Drive Unit for Paper Feed

Lubrication to the top lands of the teeth of each gear and housing studs (indicated in red in the following diagram).

- Gears and idlers
- Studs of the drive unit for paper feed

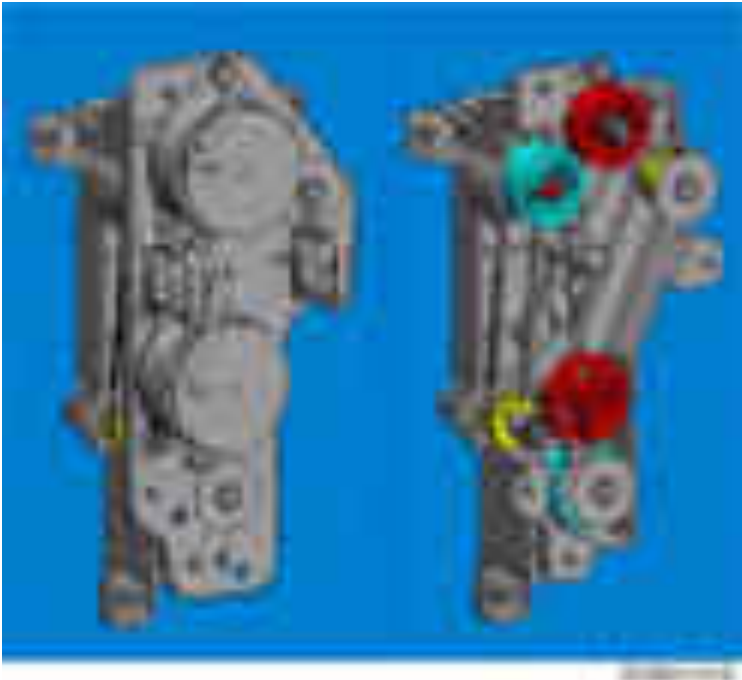

Apply the specified amount to the lubrication spots.

Lubricate the top lands of the teeth of each gear (shown by red frame) in the directions of the arrow.



If the grease substantially soils the timing belt, clean the belt and adjust the amount of grease on the studs.

Lubrication parts

- 2 gears (4 spots)
- Shaft (stud) (2 spots)

4.Replacement and Adjustment

Lubrication amount

Maximum [A] and minimum [B]

Gears



Amount of grease on studs



Drive: Fusing Delivery Drive Unit

Lubrication for preventing noise and vibration and for extending life (indicated in red in the following diagram).

1. Paper exit/pressure release motor gear: gear teeth (1 spot) located in area 0-10 mm from the tip of the shaft
2. End surface of gear boss (1 spot)
3. End surface of gear boss (1 spot)
4. End surfaces of gear teeth (2 spots)
5. Stud center (1 spot)
6. Area 45 mm from the tip of the stud (1 spot)

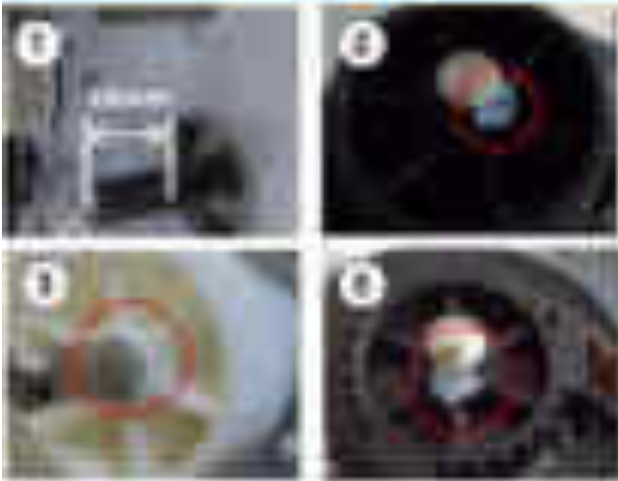

Lubrication parts

- 4 gears (5 spots)
- Shaft (stud) (2 spots)

Lubrication amount

Maximum [A] and minimum [B]

Gears

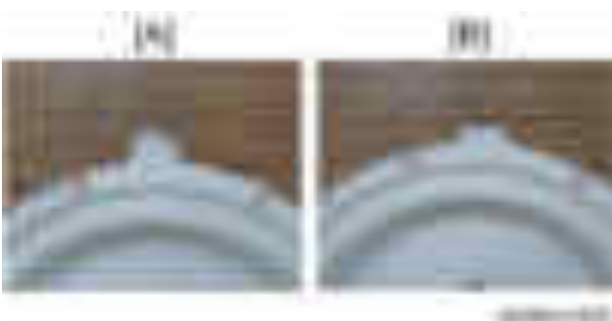

Amount of grease on studs

4.Replacement and Adjustment



Waste Toner Drive at Machine's Front Side Plate

Apply an appropriate amount to 2 spots on the intermediate gear. (Indicated in red in the following diagram)

(Area around the bottom front part of K color PCDU inside the frame)

- Gear teeth (2 spots)

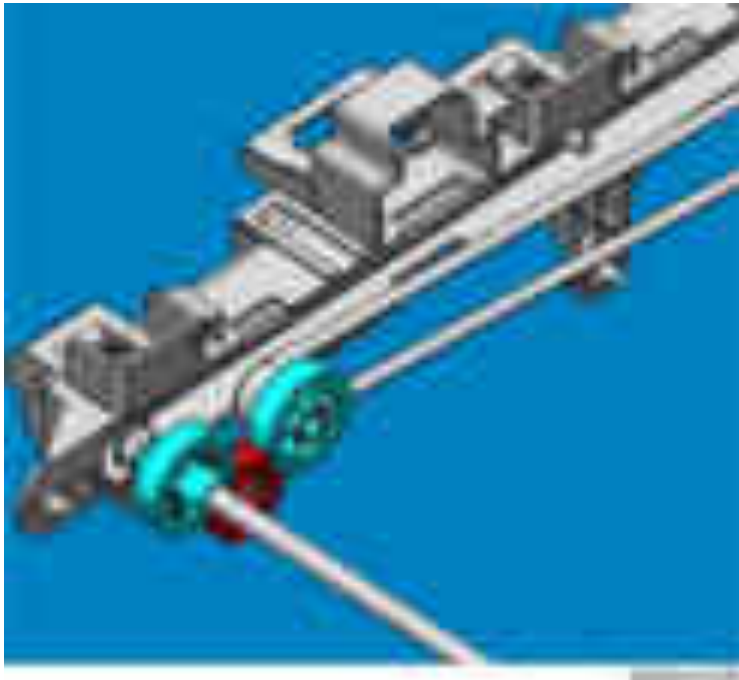

Lubrication parts

Gear (2 spots)

Lubrication amount

Maximum [A] and minimum [B]

4.Replacement and Adjustment

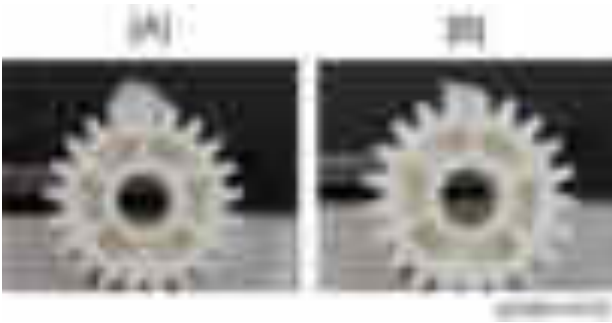

4.Replacement and Adjustment

Exterior Covers

Precaution Concerning Stabilizers

The stabilizers are necessary for meeting the requirements of IEC60950-1, the international standard for safety.

The aim of these stabilizers is to prevent the products, which are heavy, from toppling as a result of people running into or leaning onto the products, which can lead to serious accidents such as persons becoming trapped under the product. (U.S.: UL60950-1, Europe: EN60950-1)

Therefore, the removal of such stabilizers must always be with the consent of the customer.

Do not remove them using only your own judgment.

Overview

Front and Rear Side Covers



No.	Cover name
1	Waste toner cover
2	Proximity sensor cover
3	Front cover
4	Main power switch cover
5	Rear cover
6	Rear lower cover

Right and Left Side Covers



4.Replacement and Adjustment

No.	Cover name
1	Right upper cover
2	Right door
3	Right rear cover
4	Left rear cover
5	Controller cover
6	Left cover
7	Upper left cover

Paper Exit Covers

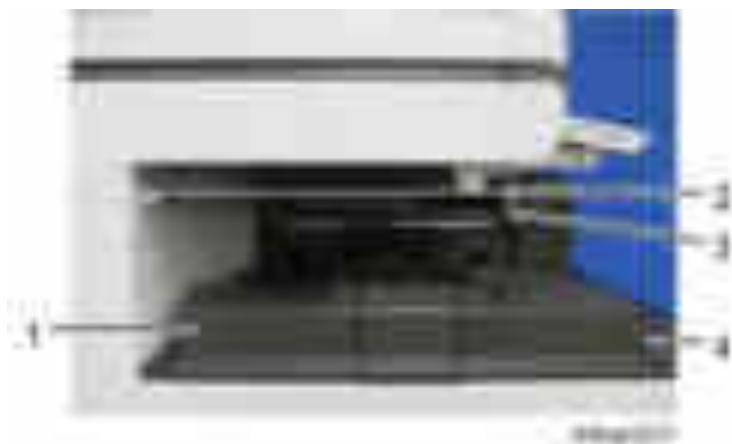

No.	Cover name
1	Paper exit tray
2	Inverter tray
3	Paper exit cover
4	Paper exit lower cover

Inner Covers



No.	Cover name
1	Paper exit front cover
2	Inner upper cover

4.Replacement and Adjustment

No.	Cover name
3	Inner lower cover

Front Cover

1. Open the front cover [A].



2. Unhook the belt's tip and detach the belt [A].



3. Press down the stopper, and then slide the front cover [A] to the right and detach it.



Controller Cover

1. Remove the controller cover [A].



Upper Left Cover

CAUTION

- Areas marked with blue circles, show the location of the tabs. Be careful not to damage when attaching and detaching.



1. Open the front cover. ([Front Cover](#))
2. Remove the paper exit tray. ([Paper Exit Tray](#))
3. Remove the upper left cover [A].
Slide the cover in the direction of the blue arrow.

4.Replacement and Adjustment



Left Rear Cover

1. Remove the upper left cover. ([Upper Left Cover](#))
2. Remove the left rear cover [A].



Left Cover

CAUTION

- Areas marked with blue circles, show the location of the tabs. Be careful not to damage when attaching and detaching.

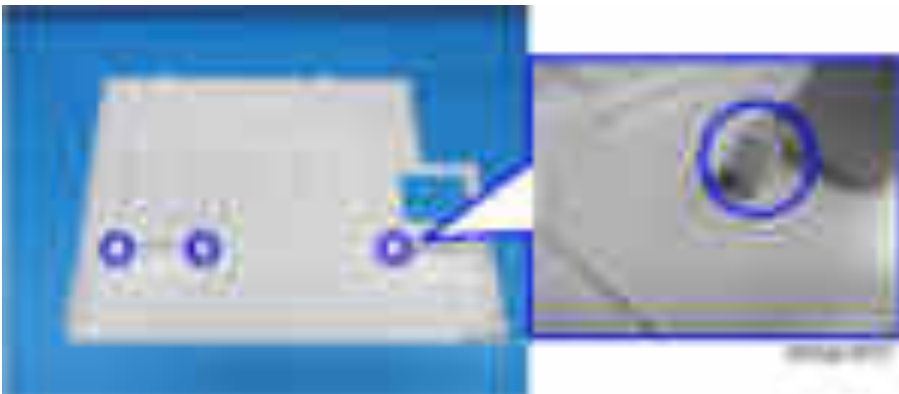

4.Replacement and Adjustment

- 1.** Remove the controller cover. ([Controller Cover](#))
- 2.** Remove the ozone filter/dust filter box. ([Exhaust Filter](#))
- 3.** Remove the upper left cover. ([Upper Left Cover](#))
- 4.** Remove the left rear cover. ([Left Rear Cover](#))
- 5.** Open the second paper feed tray slightly.



- 6.** Remove the Left cover.
Remove it while pressing down.



4.Replacement and Adjustment

Order to remove



1. Paper exit tray
2. Controller cover
3. Ozone filter/Dust filter box
4. Front cover
5. Upper left cover
6. Left rear cover
7. Second paper feed tray
8. Left cover

Rear Cover

CAUTION

- There are tabs (left-facing) on the back face of the rear cover. When fitting or removing the cover, take care not to damage it.

- 1.** Remove the rear cover [A].

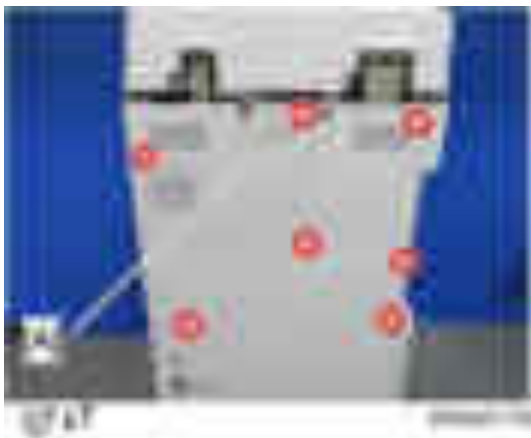

Slightly bend the cover to release the tabs behind the parts indicated by red circles and release the cover.



Rear Lower Cover

1. Remove the rear cover. ([Rear Cover](#))
2. Remove the rear lower cover [A].



Right Rear Cover

1. Open the right door. ([Duplex Unit](#))

4.Replacement and Adjustment

2. Remove the right rear cover [A]. (Screw x4, among them, tapping screw x1)



- When installing, insert the projections [A] in the holes [B], taking care not to trap the harness inside.

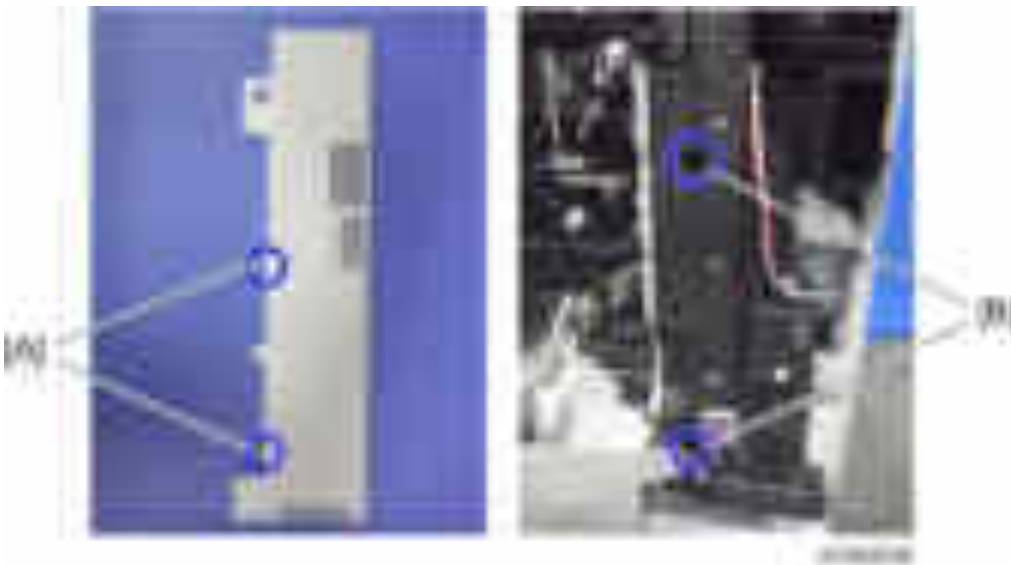

Right Upper Cover

1. Remove the proximity sensor cover. ([Proximity Sensor Cover](#))

2. Remove the right upper cover [A].



Proximity Sensor Cover

1. Open the right door. (Duplex Unit)
2. Remove the left proximity sensor cover [A].



3. Remove the small cover [A].



4.Replacement and Adjustment

4. Remove the proximity sensor cover [A].



- Remember that there is a tab at the positions of the red arrows.
- Rotate the operation panel [B] upward to a horizontal position, and then detach the proximity sensor cover [A].



Proximity Sensor (S49)

1. Remove the proximity sensor cover. ([Proximity Sensor Cover](#))

- 2.** Remove the two connectors.

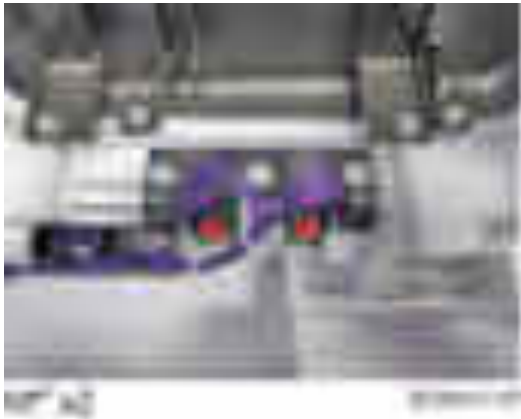

- 3.** Remove the bracket [A].



- 4.** Remove the proximity sensor (S49) [A].



4.Replacement and Adjustment

Main Power Switch Cover

1. Pull out the paper trays 1 and 2.

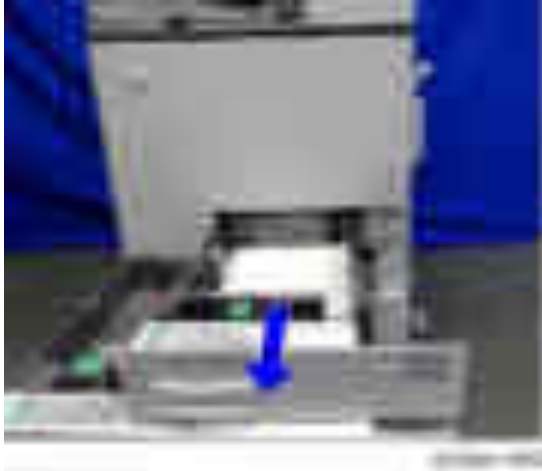

2. Remove the main power switch cover [A].



Waste Toner Cover

1. Remove the front cover. ([Front Cover](#))
2. Open the waste toner cover [A].



3. Remove the waste toner cover [A].



Inverter Tray

1. Remove the inverter tray [A].

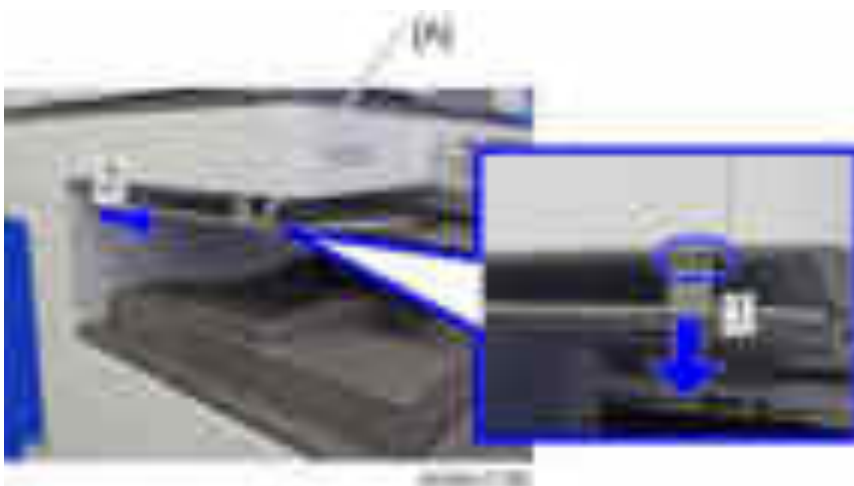

Paper Exit Tray

1. Remove the paper exit tray [A].



4.Replacement and Adjustment

Paper Exit Cover

- 1.** Remove the proximity sensor cover. ([Proximity Sensor Cover](#))
- 2.** Remove the paper exit tray. ([Paper Exit Tray](#))
- 3.** Remove the inverter tray. ([Inverter Tray](#))
- 4.** Remove the paper exit cover [A].



Paper Exit Lower Cover

- 1.** Remove the left rear cover. ([Left Rear Cover](#))
- 2.** Remove the paper exit cover. ([Paper Exit Cover](#))
- 3.** Remove the connector cover [A].



4. Remove the paper exit lower cover [A].



Paper Exit Front Cover

1. Remove the proximity sensor cover. ([Proximity Sensor Cover](#))
2. Remove the paper exit lower cover. ([Paper Exit Lower Cover](#))
3. Remove the paper exit front cover [A].



Inner Upper Cover

1. Open the front door, and remove the belt. ([Front Cover](#))
2. Open the right door. ([Duplex Unit](#))
3. Remove the paper exit front cover. ([Paper Exit Front Cover](#))
4. Remove the image transfer unit. ([Image Transfer Unit](#))

4.Replacement and Adjustment

- 5.** Remove the inner upper cover [A].



Inner Lower Cover

- 1.** Remove the front cover. ([Front Cover](#))
- 2.** Remove the inner upper cover. ([Inner Upper Cover](#))
- 3.** Remove the waste toner cover. ([Waste Toner Cover](#))
- 4.** Remove the inner lower cover [A].



Operation Panel (PCB13)



- The machine's operation panel is a flat touchscreen. When you remove the panel and set it aside temporarily, be sure to lay it down with the screen face up so as not to damage the screen.
- When you dismantle the removed operation panel (PCB13), be sure to do it on the service mat [A] spread on the exposure glass.



- If you place the operation panel (PCB13) directly on the exposure glass or other flat surface and apply strong pressure to the entire panel, air may leak from the gap in the panel, causing such problems as a coordinate deviation and detection error.

Operation Panel Unit

1. Remove the scanner front cover. ([Scanner Front Cover](#))
2. Holding down both the sides of the operation panel upper cover [A], unhook the tabs (indicated by blue circles) and remove the cover.



4.Replacement and Adjustment

- 3.** Remove the operation panel [A].

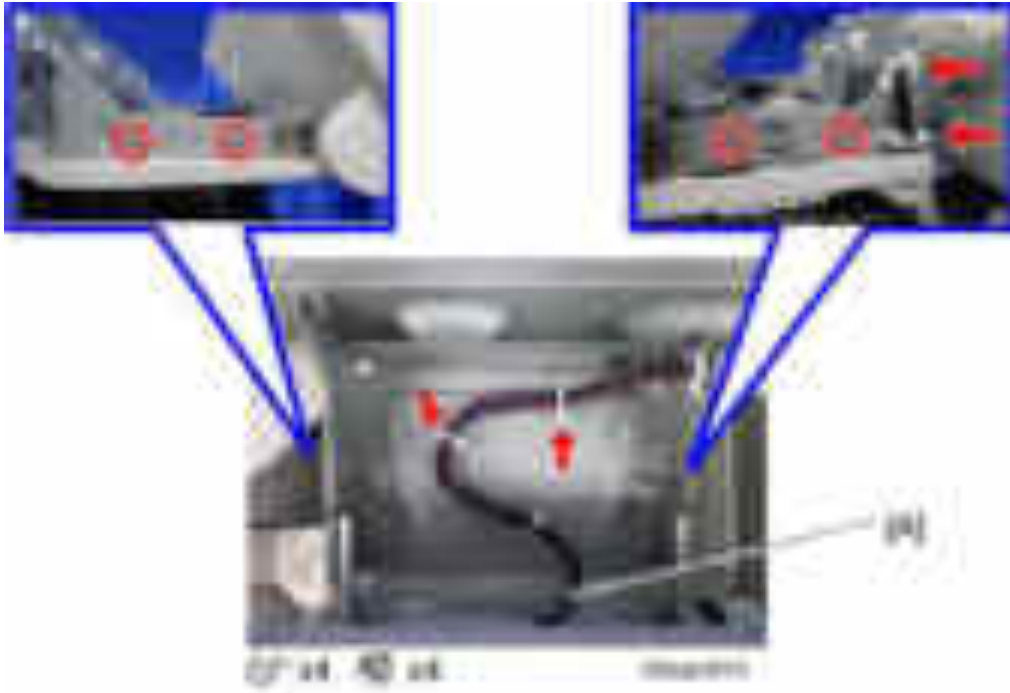

- 4.** Open the platen cover or ADF.

- 5.** Spread a cloth or service mat [A] on the exposure glass to protect the display. Place the operation panel on the exposure glass so that the display faces down.



- 6.** Remove the rear center cover [A].



- 7.** Disconnect the connectors [A] [B].



- 8.** Remove the small cover [B] and the hinge covers [A] [C].



- 9.** Remove the hinges [A] [B].



4.Replacement and Adjustment

USB Cable

- 1.** Remove the rear cover. ([Rear Cover](#))
- 2.** Remove the scanner right cover. ([Scanner Right Cover](#))
- 3.** Remove the controller box cover. ([Controller Box Cover](#))
- 4.** Disconnect the connectors [A] [B].



- 5.** Remove the clamps on the cables under the scanner unit.



When removing a clamp, insert a long flathead screwdriver or such a tool from the side to remove it.

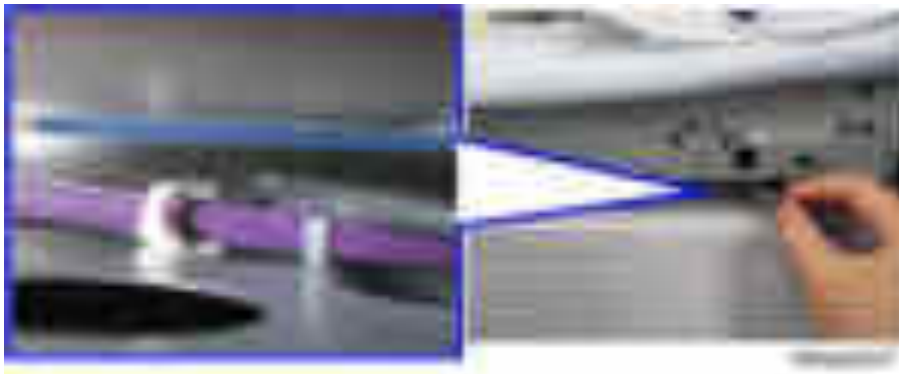

- The cable has a set of 2 cable ties. When attaching the cable, position the clamp between the

two cable ties.



ADF

ADF Removal

1. Remove the rear cover. ([Rear Cover](#))
2. Remove the controller box cover. ([Controller Box Cover](#))
3. Remove the cable bracket and connectors.

SPDF DF3120

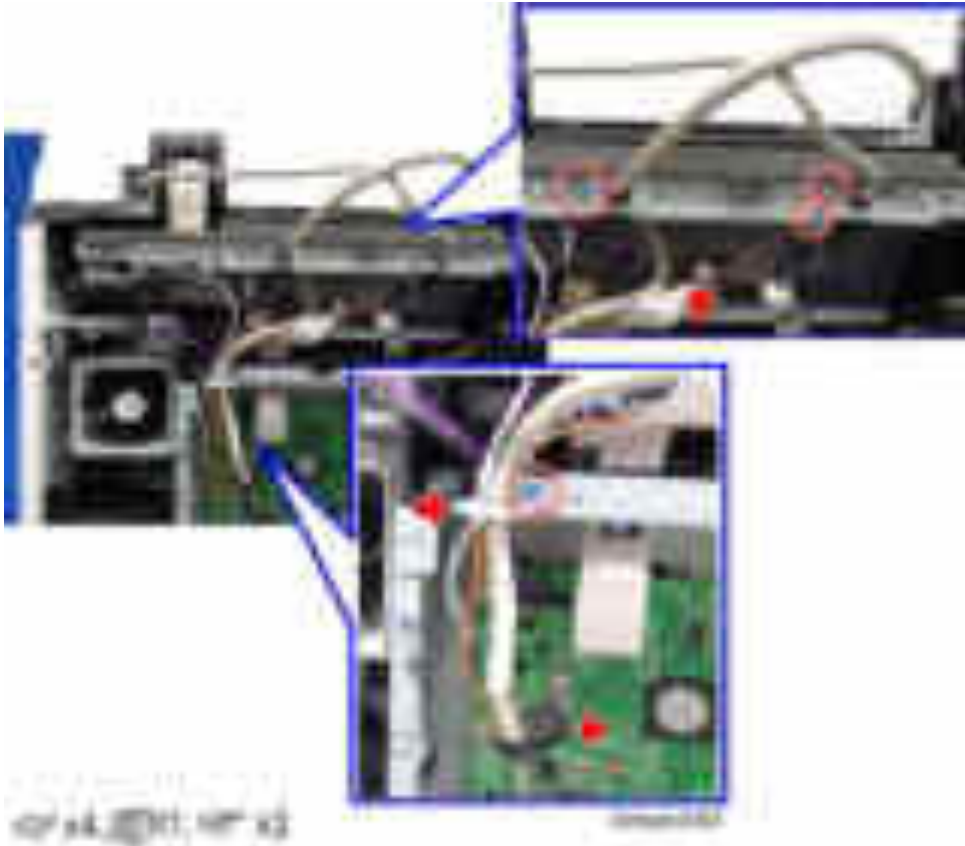

ARDF DF3110



4. Remove the screws on the ADF base.

SPDF DF3120



ARDF DF3110



- 5.** Slowly and carefully (the ADF is heavy) lift the ADF [A].
Set the ADF on its edge on the floor, and then lean it against a wall [B].



- To prevent damage to the fragile feelers [A] of the ADF/Platen cover sensor (S43), never lay the ADF on a flat surface as shown below.



- If the SPDF DF3120 is being replaced, do SP4-730-002 after the new SPDF has been installed.

4.Replacement and Adjustment

SP descriptions

- **SP4-730-002 (FROM Main Factory Setting Execution ON/OFF)**
Copies the parameters written in FROM in the SPDF to the engine board in the MFP. This SP is only for the SPDF models.

Scanner Unit

Before You Begin

There is no IPU in this machine. The functions of the IPU of the previous machine are controlled by the BICU (PCB10).

Harnesses of the scanner unit connect directly to the BICU in the controller box on the back of the machine.



Scanner Exterior

Scanner Front Cover

- 1.** Remove the scanner front cover [A].



4.Replacement and Adjustment

Scanner Right Cover

- 1.** Remove the screw.



- 2.** Remove the scanner right cover [A].
Remove the hook at the top, and then slide the cover towards the rear.

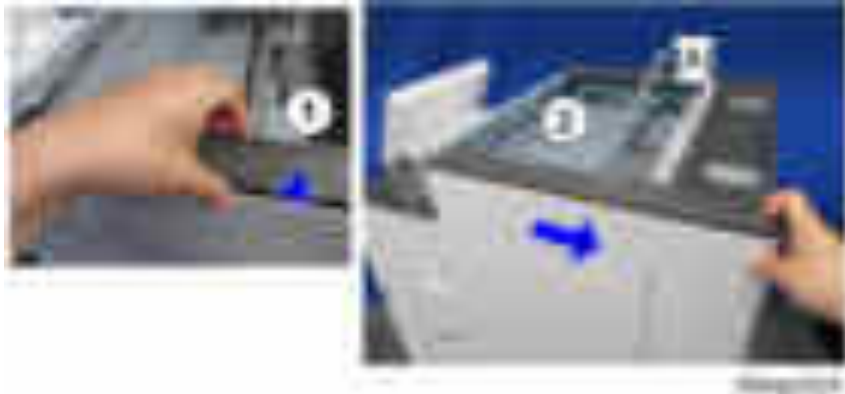

Scanner Left Cover

- 1.** Remove the scanner front cover. ([Scanner Front Cover](#))

2. Remove the scanner left cover [A].



Scanner Upper Cover

1. Remove the platen cover or ADF. ([ADF Removal](#))
2. Remove the rear cover. ([Rear Cover](#))
3. Remove the scanner upper cover [A].



Exposure Glass

1. Open the platen cover or ADF.
2. Remove the scanner right cover. ([Scanner Right Cover](#))

4.Replacement and Adjustment

3. Remove the scale [A].



4. Remove the sheet-through exposure glass [A].



5. Remove the rear scale [A].



6. Remove the left scale and exposure glass [A].



- The exposure glass and the left scale are attached with double-sided tape.

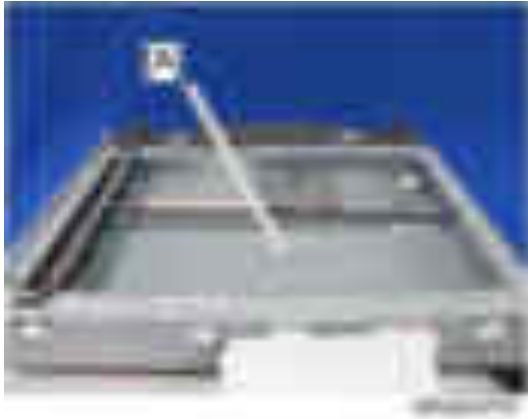

- When installing, please follow the points below:
- Install the sheet-through exposure glass with the mark [A] at the rear left corner.
- Set so that the locating hole of the left scale fits over the locating boss of the front/rear frame.



Scanner Carriage

1. Remove the exposure glass. ([Exposure Glass](#))
2. Remove the scanner front cover. ([Scanner Front Cover](#))
3. Remove the scanner carriage front cover [A].



4.Replacement and Adjustment

- 4.** Move the scanner carriage [A] to the indicated position as shown.



- 5.** Loosen the screw, remove the spring [A], and then remove the belt [B].

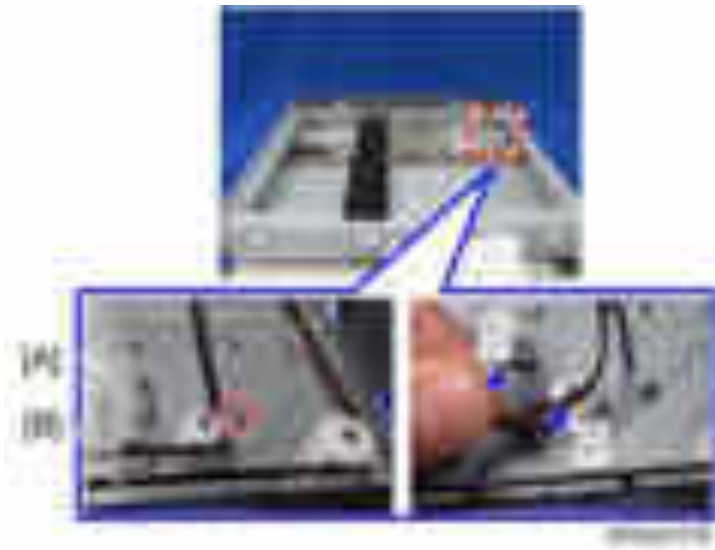

- 6.** Turn the scanner carriage over and place it on the frame [A].



- When holding the scanner carriage, be careful not to touch the circuit board [A], lens [B],

and mirror [C].



7. Remove the Belt [A].



8. Lower the lock lever [A] and disconnect the FFC [B].



9. Remove the ferrite core [A] and the sheet [B] (Hook x4).

4.Replacement and Adjustment



10. Remove the scanner carriage.



Important

- When attaching the scanner carriage, hold the carriage with the screw [A] loosened and move the carriage back and forth to the sides twice to have the belt stretch evenly. Then, fasten the screw [A].



Important

- After replacing the scanner carriage, enter the values supplied with the carriage in the following SP
 - SP4-871-002 (Distortion Correction Distortion Initialization)
 - SP4-880-001 (Dot shift amount between R Line and G Line).
 - SP4-880-002 (Dot shift amount between G Line and B Line).

4.Replacement and Adjustment

To apply the specified settings, turn the power off and then back on.

The specified values are cleared when the NVRAM is initialized, so be sure to keep the supplied sheet showing the values in the machine.

Cleaning the scanner carriage mirror

- 1.** Remove the exposure glass. ([Exposure Glass](#))
- 2.** Remove the scanner carriage front cover [A].



- 3.** Move the scanner carriage [A] to the indicated position as shown.

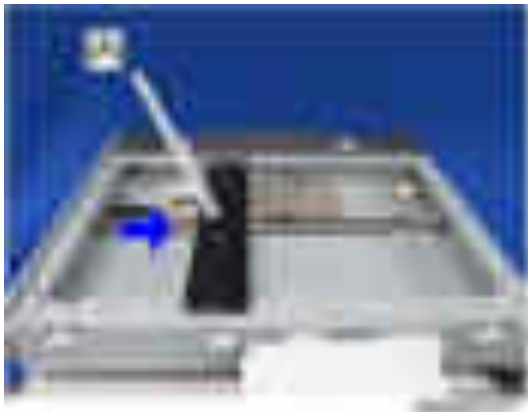

- 4.** Remove the resin cover [A] (Hook x3).



4.Replacement and Adjustment

5. Open the metal cover [A].



6. Wipe clean the mirror with a dry cloth.



Important

- When reattaching the metal cover [A], fasten the screws in the order of "1", "2", and "3".





- When attaching the resin cover, insert its tip under the metal frame.



Scanner Motor (M26)

1. Remove the scanner upper cover. ([Scanner Upper Cover](#))
2. Remove the rear cover. ([Rear Cover](#))
3. Remove the grounding plate [A].



4.Replacement and Adjustment

4. Remove the spring [A].



5. Remove the scanner motor (M26) with bracket [A].



6. Remove the bracket [A].



APS Sensors (S44)(S45)

1. Remove the exposure glass. ([Exposure Glass](#))

2. Remove the APS sensor harness cover [A].



3. Remove the APS sensors (S44) (S45) [A] (Hook x2).



Scanner Home Position Sensor (S42)

1. Remove the exposure glass. ([Exposure Glass](#))
2. Remove the slide the scanner carriage [A] in the direction of the arrow.



4.Replacement and Adjustment

- 3.** Remove the scanner home position sensor (S42) [A] (Hook x 3).

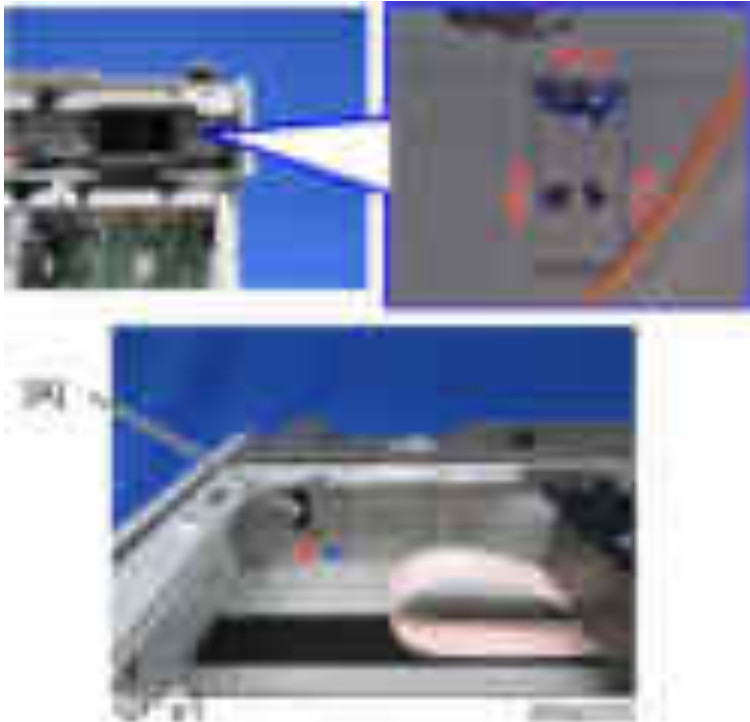

ADF/Platen Cover Sensor (S43)

- 1.** Remove the scanner upper cover. ([Scanner Upper Cover](#))
- 2.** Remove the ADF/Platen cover sensor (S43) [A].

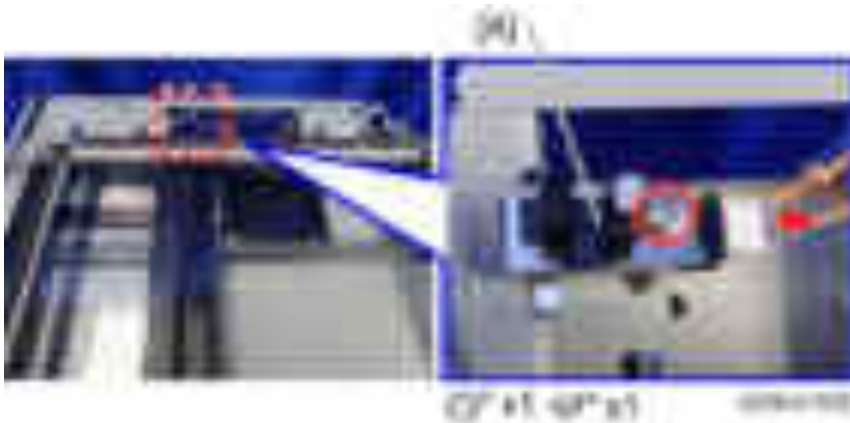

Scanner FFC

- 1.** Remove the exposure glass. ([Exposure Glass](#))
- 2.** Remove the FFC from the scanner carriage. ([Scanner Carriage](#))

- 3.** Remove the APS sensor harness cover [A].



- 4.** Remove the double-sided tape.



When reattaching the same part, apply a double-sided tape again.

- 5.** Remove the rear cover. ([Rear Cover](#))
6. Remove the controller box cover. ([Controller Box Cover](#))
7. While pressing the lock release lever, pull out the FFC [A].



When changing the FFC

When changing the FFC, stick the sheet [A] to the new FFC.

4.Replacement and Adjustment



When attaching the sheet, follow the steps below.

- 1.** Feed the FFC through the ferrite core [A].



- 2.** Connect the FFC to the scanner carriage's connector, and then lift the lever [A] to lock it.

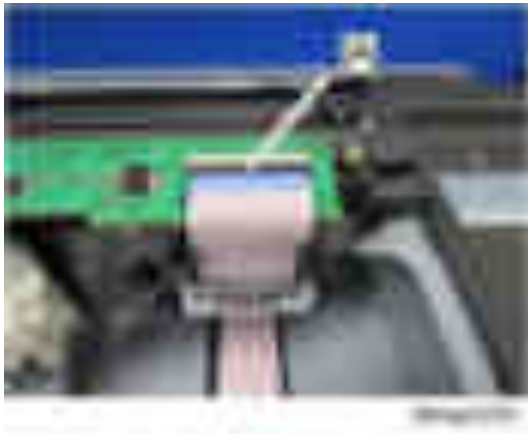

- 3.** Attach the sheet [A] to the FFC from above, and then insert the tabs at both ends of the sheet into

4.Replacement and Adjustment

the gaps in the FFC holder to secure it in position.



When applying the sheet, be sure not to stretch the FFC.

Applying the sheet while stretching the FFC causes the circuit board to be deformed.



4.Replacement and Adjustment

Laser Unit



- Turn off the main power switch and unplug the machine before beginning any of the procedures in this section. Laser beams can cause serious eye injury.
- Caution Decals



- Decal Location



Laser Unit



- A polygon mirror motor (M27) protection bracket and a red tag are attached to each new laser unit. Remove these before you install the new unit.

Before Replacement

- 1.** Remove the polygon mirror motor cover [A] from the new laser unit.



- 2.** Remove the polygon mirror motor bracket [A] and the red tag [B].

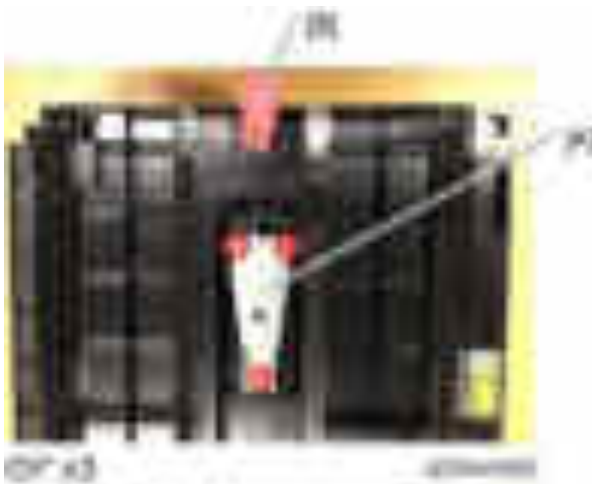

- 3.** Reattach the polygon mirror motor cover.

Removing

- 1.** Remove the left cover. ([Left Cover](#))

4.Replacement and Adjustment

2. Remove the laser unit [A].

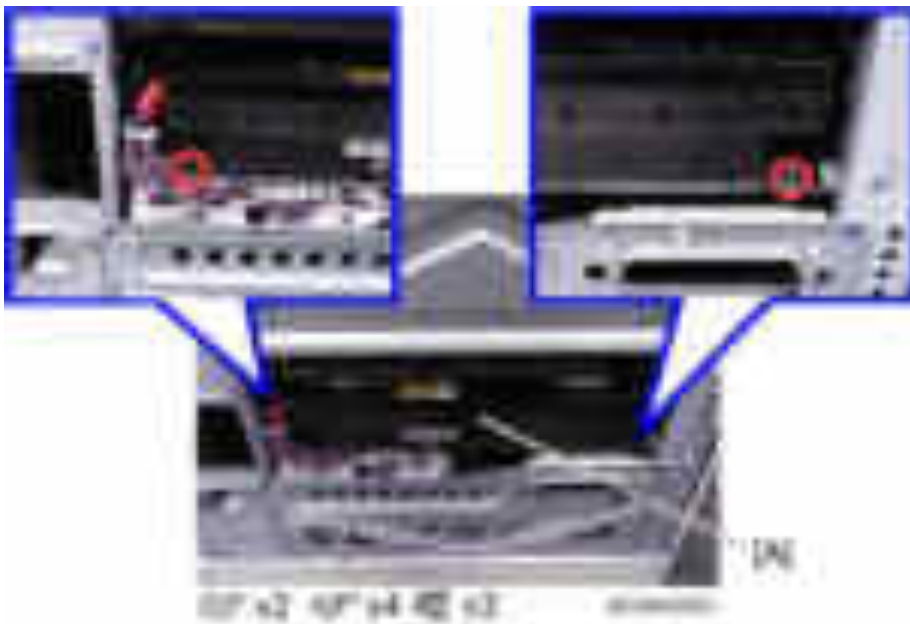

Installing a New Laser Unit

1. Insert the new laser unit in the main body carefully.
2. Connect all harnesses except the harness [A] (2nd from right) of the laser optics positioning motor harness (M23) (M24) (M25).



3. Reassemble the machine.

Adjustment after replacing the laser unit

1. Close the front cover and attach the left cover.



- Attach the left cover before turning on the main power switch. Laser beams can seriously damage your eyes.

2. Plug in and turn on the main power switch.
3. Download the data of the new laser unit to the main body with SP2-110-005.

4. Check that SP2-119-001 to 003 is "0."



- If it is not "0", perform SP2-110-005 again.
- If it is not executed correctly, outputs will be abnormal (magnification and color registration errors), and SC 285 may occur.

5. Turn off the main power switch and disconnect the power cord.

6. Remove the left cover and attach the harness [A] of the laser optics positioning motor (M23) (M24) (M25).



7. Close the left cover.

8. Plug in and turn on the main power switch.

9. Select [14: Trimmed area] in SP2-109-003, and then press [OK].

10. Press [Copy Window], and then print the test pattern in the copy screen.

- Check if the margin on either side on the output (14: Trimmed area) is less than 4 ± 1 mm or not. If it is not within these limits, change the reference value (Bk) of the registration adjustment (SP2-101-001).



- Adjust the values of the main scanning magnification only for Bk (black). It is not necessary to adjust other color's values (cyan, magenta, yellow) because other colors are automatically adjusted in relation to the setting for Bk.
- Input the same value for each SP (SP2-102-001 to -003) even though there are three SPs of the main scanning magnification adjustment for the standard, middle and low line speed which are used for each paper type.
- Check if the margin on the left side on the output (14: Trimmed area) is less than 2 ± 1 mm or not. If it is not within these limits, change the reference value (Bk) of the registration adjustment (SP2-101-001).

11. Set SP2-109-003 to "0: None" after adjusting the main scanning magnification and registration.

12. Perform line adjustment.

SP2-111-004: Forced Line Position Adj. Mode d

The result can be checked with SP2-194-007 (MUSIC Execution Result Execution Result) (0:

4.Replacement and Adjustment

Success, 1: Failure).

Also, results for each color can be checked with SP2-194-010 to 013 (1: Completed successfully).

13. Exit the SP mode.

Polygon Mirror Motor (M27)

- 1.** Remove the laser Unit. ([Laser Unit](#))
- 2.** Remove the polygon mirror motor cover [A].



- 3.** Remove the polygon mirror motor holder [A] and the Polygon mirror motor (M27) [B].



Adjustment after replacing the polygon mirror motor

SP2-111-004: Forced Line Position Adj. Mode d

The result can be checked with SP2-194-007 (MUSIC Execution Result Execution Result) (0: Success, 1: Failure).

Also, results for each color can be checked with SP2-194-010 to 013.

SP descriptions

SP2-110-005 (Writing Unit Adj. Transfer)

Execution flag to download adjustment values of the laser unit to the main machine's SP.

Must be executed when replacing the laser unit or assembling the main machine.

SP2-119-001 to 003 (Skew Adjustment Display)

Displays the current skew correction value for each color.

SP2-109-003 (Test Pattern: Pattern Selection)

Selects the test pattern.

SP2-101-001 (Registration Correction: Color Main Dot: Bk)

Adjusts main scan registration for BK.

Value increase: image shifts to the right facing the paper.

Value decrease: image shifts to the left facing the paper.

CMY colors are adjusted to the BK color position if MUSIC is done after this SP.

SP2-111-004 (Forced Line Position Adj. Mode d)

Executes the fine line position adjustment and rough line position adjustment.

SP2-194-007 (MUSIC Execution Result Execution Result)

Displays the result of MUSIC adjustment.

0: Success, 1: Failure

SP2-194-010 to 013 (MUSIC Execution Result: Error Result C, M, Y, K)

Displays the result code of MUSIC adjustment for each color.

Detection Result	Meaning
0	MUSIC not executed
1	Correction Succeeded: Sampling is conducted correctly and the correction is completed
2	Sampling Failed (When the MUSIC pattern failed to be detected)
3	Detection Patterns Lacking (When the number of lines detected is smaller than the fixed number)
4	The sampled data is beyond the correction range. (Calculated correction value is just out of range)
5	The sampled data is beyond the correction range.

PCDU

Notes when replacing a PCDU



- When replacing a PCDU, remove the seal from the new PCDU. The procedure about removing the seal differs between models as follows.

The procedure about removing the seal

Models	CMY	Bk
IM C6000/C5500/C4500	Wound automatically when turning on the power	
IM C3500/C3000	Pulled out by hand	Wound automatically when turning on the power
IM C2500/C2000	Pulled out by hand	

- Make sure that the cap of the toner supply opening [A] is removed before installing a new PCDU in the machine. Otherwise, the toner may be scattered inside the machine.



Note for IM C6000/5500



- From the new PCDU, remove the one component that prevents compatibility with the IM C6000/5500, and then adjust the spring pressure before installing a new PCDU in the machine.

Releasing the spring pressure

1. Remove the seal [A].

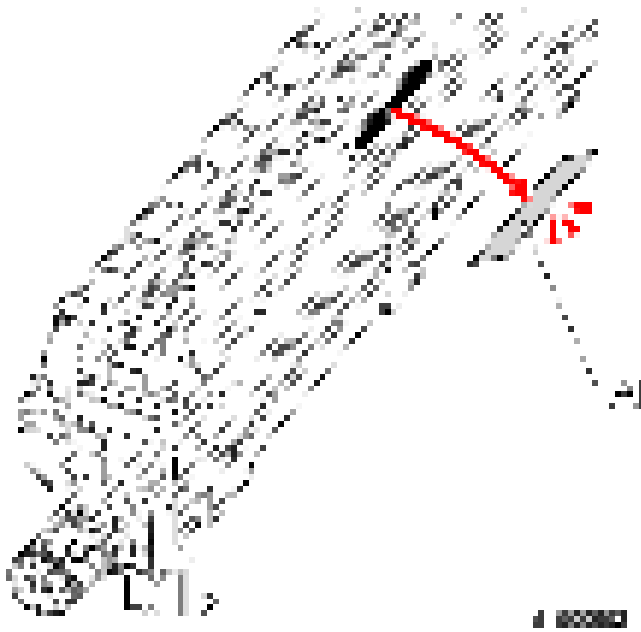

2. Insert a flathead screwdriver into the hooked end of the pin as shown.



CAUTION

- Make sure to use a small flathead screwdriver, as the spring is under very high tension. Do not do this step by hand.

4.Replacement and Adjustment

- 3.** Move the screw driver and pin slowly over to the opposite side, which will disengage the spring.

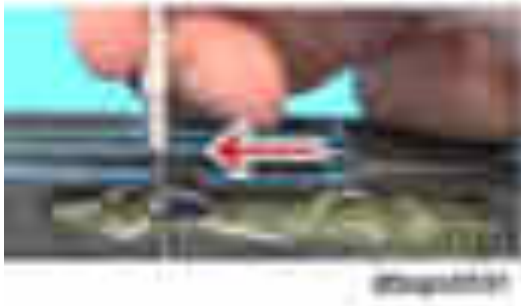

- 4.** Remove the screwdriver slowly from the pin.



Precaution

- Do not insert the screwdriver for incorrect direction. If you do so, the screwdriver slips off the pin when releasing the spring pressure and then it may damage parts inside the unit. Make sure to insert the screwdriver so that the bent tip of the pin is under the driver.

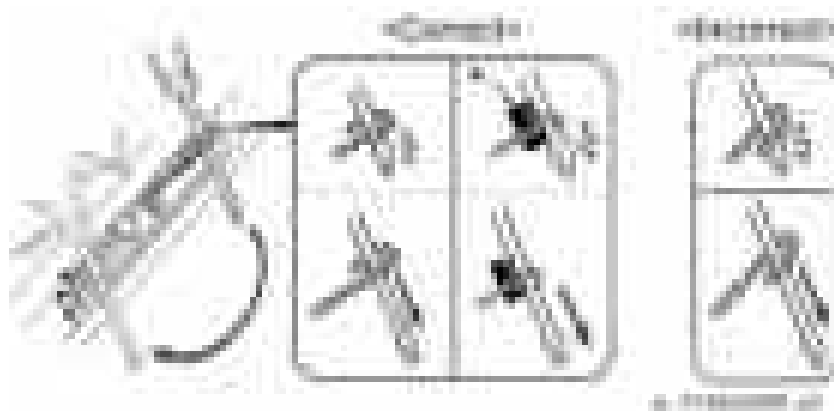

- There are two types of pins for the spring pressure. One is with the direction regulation (* black seal) at the tip of a pin, another is without the direction regulation. This procedure is effective for both types of pins.

- 5. When the spring is released, gently pull the knob out.
- 6. Confirm that the spring pressure is released correctly.

<Correct>



<Incorrect>



If the spring is not attached properly, reattach the spring according to "[Restore the spring pressure](#)".

- 7. Affix the seal [A] on the upper right of the provided sheet to the unit.



4.Replacement and Adjustment

Restore the spring pressure

- 1.** Remove the PCDU rear cover [A].



- 2.** Rotate the PCDU 90 degrees to the right.



- 3.** Remove the cover [A] (3 hooks).



4.Replacement and Adjustment

- 4.** Remove the lubricant bar [A], and then remove the springs one by one from the outside.



- 5.** Attach the pin between springs as shown below, and then reinstall the springs in the lubricant bar.



4.Replacement and Adjustment

6. Reinstall the lubricant bar [A] in the PCU, and then reattach the cover [B] to the PCU.



7. Reattach the PCDU rear cover.

PCDU

Replacement



- When replacing the PCDU, remove the seal from the new PCDU. For details about removing the seal, see [Removing the PCDU Seals and Spacer](#).
- When installing a new PCDU or a new development unit, take out the unit from the package and shake it 5 or 6 times horizontally. This will reduce the chances of SC324-01 and SC324-05.

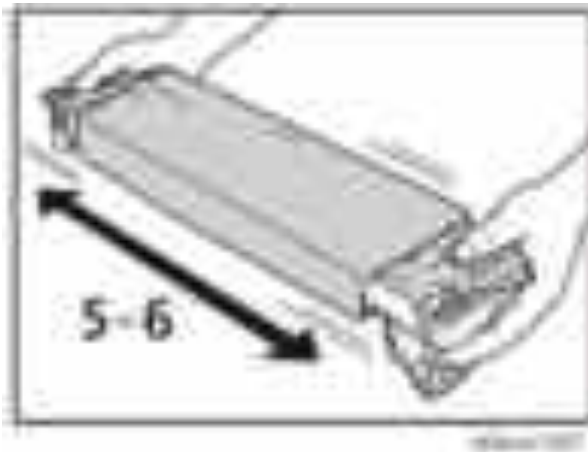

- IM C2500/C2000 PCDUs feature the new unit detection function, so it is not necessary to reset the PM counter manually when replacing the PCU and development unit together. When installing a complete brand-new PCDU, it is not necessary to set SP3-701: New Development Unit detection.

1. Open the front cover [A].

- 2.** Unlock the image transfer front cover [A].

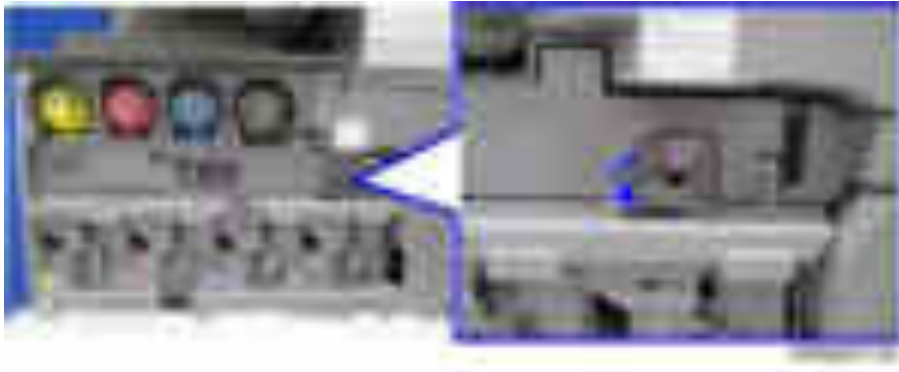

- 3.** Open the image transfer front cover.



- 4.** Release the lock and then remove the PCDU.



Adjustment after Replacing the PCDU

After replacing the PCDU, execute the following. For the details of the procedure, refer to "[Color Registration and Auto Color Calibration \(ACC\)](#)".

- Do the "Auto Color Calibration (ACC)" for the copier mode & printer mode.
- Do the Color Registration.

4.Replacement and Adjustment

PCU/Development Unit

Before Replacing a PCU or Development Unit

Replacing a PCU

Before replacing a PCU, do the procedure shown below.

- Set SP3-701: New PCU detection to “1”.

	SPs for the manual new unit
Black	SP3-701-002
Cyan	SP3-701-025
Magenta	SP3-701-048
Yellow	SP3-701-071

- Check the correction value printed on the label attached to the new PCU. Input the correction value into the SP number corresponding to the color to be replaced. (For the label, refer to the following.)

	SPs for correction value
Black	SP2-005-235
Cyan	SP2-005-236
Magenta	SP2-005-237
Yellow	SP2-005-238

After doing the above procedure, turn the power OFF and replace the PCU.

Information on the Label Attached to the New PCU (Only IM C2500/C2000)

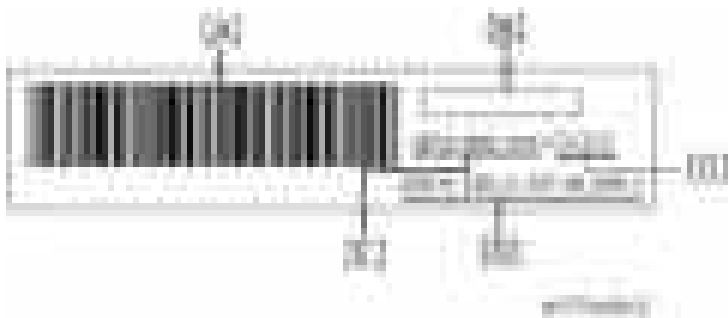

A	Barcode
B	PCU Lot No.
C	Correction value
D	Last three digits of SP number
E	SP No.

Replacing the PCU without Inputting the Correction Value

Judge whether or not you set New PCU detection, do the following procedure:

Case 1: When you set SP3-701 to “1”

- Input the PCU correction value.
- Execute process control manually with SP3-011-001 in order to adjust the machine settings with the PCU correction value.



- If you replace the PCU by entering the PCU correction value, the process control is automatically executed.

Case 2: When you did not set SP3-701 to “1”

- Set SP3-701 to “1”.
- Check the correction value printed on the label attached to the new PCU. Input the correction value into the SP number corresponding to the color to be replaced. (For the label and the correction value, refer to the following.)

After doing the above procedure, turn the power OFF. Note that process control will start automatically.

Before Replacing a Development Unit



- Replacing the development unit resets not only the development unit counter but also the PCU counter. However, if you change the SP setting (SP3-701) before you replace the development unit, the PM counter of the development unit is reset, but the PM counter of the PCU is not reset.
- Therefore, before you replace the development unit, the manual new unit setting SP3-701 must be done. Doing these in the wrong order will reset the counter of the PCU also.

Before replacing the development unit, do the procedure shown below.

- Set SP3-701: New unit detection to “1”.

	SPs for manual new unit
Black	SP3-701-003
Cyan	SP3-701-026
Magenta	SP3-701-049
Yellow	SP3-701-072

Replacement



- Remove carefully so as not to damage the part of the rear end block shown by the red circle (removed in Step 4). If the parts are bent or deformed, electrical contact may become poor, and this may cause poor image quality.

4.Replacement and Adjustment



- 1.** Remove the PCDU. (PCDU)
- 2.** Remove the PCDU front cover [A].



- 3.** Remove the Front end block [A].



- 4.** Remove the PCDU rear cover [A].



- 5.** Remove the gear [A].
6. Remove the joint (rear side) [B] with a knob screwdriver.



Important

- When attaching the joint, hold down the side of the PCU. Be careful not to hold down the development unit.

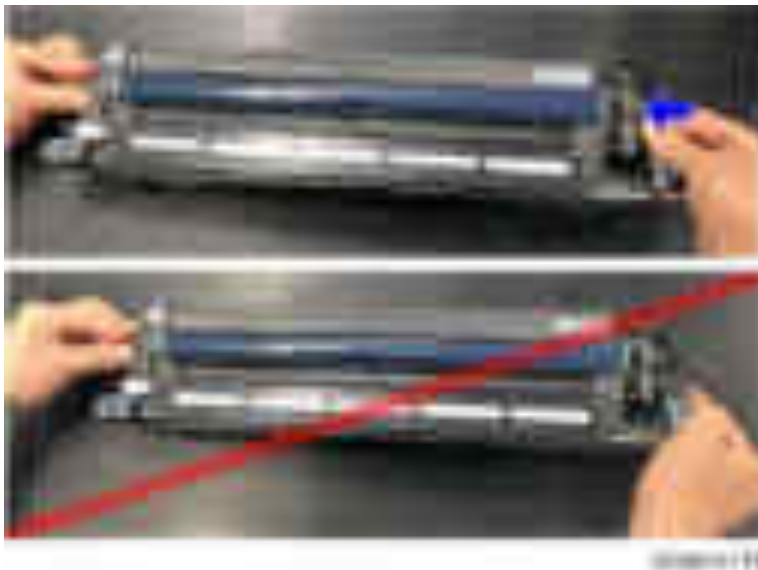

4.Replacement and Adjustment

7. Separate the PCU [A] and Development Unit [B].

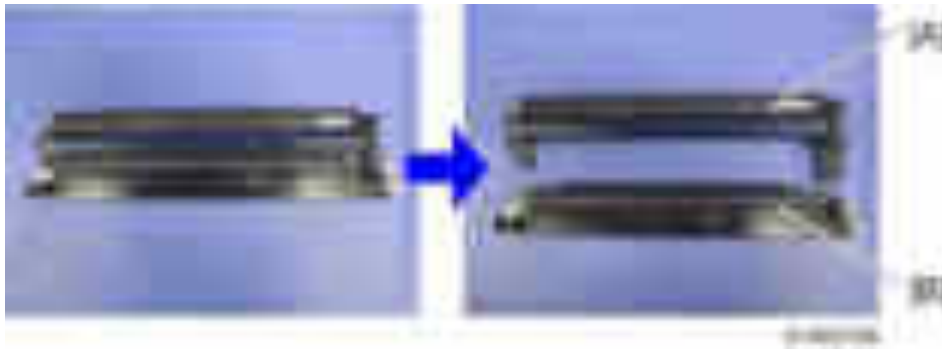

CAUTION

- When holding the development unit, be sure to obey the following.
- DO NOT touch the doctor blade and the development roller housing.

Hold the development unit as shown below:



Doctor Blade



DO NOT touch the doctor blade. The doctor blade is an extremely sharp-edged blade, made with a high precision to work properly. So touching the blade causes physical injury as well as deformation of the blade assembly which causes a malfunction of the development unit.

Development Roller Housing



DO NOT touch the red frame part of the image. Doing so will deform the development roller housing, which causes the development roller to be scratched.

Precautions when joining the PCU and the development Unit

Note that if these are joined while pressing the drum, the cleaning blade [A] may turn over in the opposite direction to the original. If this happens, toner lines may appear on prints.

4.Replacement and Adjustment



- Make sure that the cap of the toner supply opening is removed before installing a new PCDU in the machine. Otherwise, the toner may be scattered inside the machine.



Method for Checking after Replacement

Before installing, rotate the drum in the blue arrow direction, to ensure that toner lines do not occur.

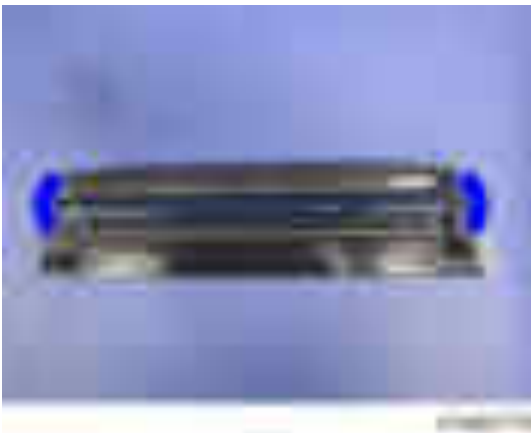

Adjustment after Replacing the PCU or Development Unit

After replacing the PCDU, execute the following adjustments. For details , refer to "[Color Registration and Auto Color Calibration \(ACC\)](#)".

- Do the "Auto Color Calibration (ACC)" for the copier mode & printer mode.
- Do the Color Registration.

Imaging Temperature Sensor (Thermistor) (S33)

- 1.** Open the controller box. ([Imaging IOB \(PCB2\)](#))
- 2.** Remove the toner supply cooling fan (FAN5). ([Toner Supply Cooling Fan \(FAN5\)](#))
- 3.** Remove the screw (indicated by the red circle) of the duct [A].



- 4.** Remove the duct [A].

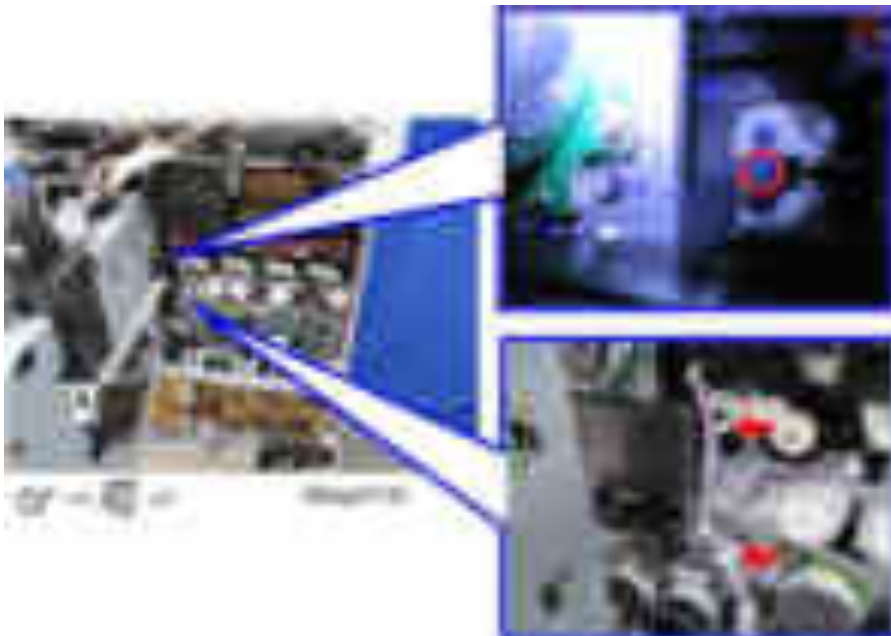

4.Replacement and Adjustment

- 5.** Remove the connector [A].



- 6.** Remove the image transfer belt unit. ([Image Transfer Belt Unit](#))
- 7.** Remove the PCDU (Bk). ([PCDU](#))
- 8.** Remove the imaging temperature sensor harness guide [A] and imaging temperature sensor (S33) [B].



Waste Toner

Before Replacing the Waste Toner Bottle

When the bottle is replaced after the machine detects that the waste toner bottle is full and stops, the counter for the Waste Toner Bottle is reset automatically.

When the bottle is replaced before the machine stops due to a full bottle, it is necessary to reset the PM counter manually (set SP3-701-142 to "1" before replacing the bottle, then switch the power off).

SP3-701 (Manual New Unit Set)

This SP is the new unit detection flag.

0: new unit detection flag OFF, 1: new unit detection flag ON

Item	SP
Waste toner bottle	SP3-701-142

Replacement

1. Open the waste toner cover [A].



2. Pull out the waste toner bottle [A].



3. Replace the waste toner bottle.

The counter for the Waste Toner Bottle is reset automatically.

4.Replacement and Adjustment

Waste Toner Bottle Full Sensor (S34), Waste Toner Bottle Set Sensor (S35)

- 1.** Remove the waste toner bottle. ([Waste Toner](#))
- 2.** Remove the rear lower cover. ([Rear Lower Cover](#))
- 3.** Remove the left cover. ([Left Cover](#))
- 4.** Remove the ozone exhaust fan (FAN3). ([Ozone Exhaust Fan \(FAN3\)](#))
- 5.** Remove the power supply box. ([Power Supply Box](#))
- 6.** Remove the FFC [A] and CN163 [B] of paper transport IOB (PCB1).



- 7.** Remove the connectors of waste toner bottle full sensor (S34) [A] and waste toner bottle set sensor (S35) [B].



- 8.** Remove the waste toner bottle sensor unit [A].



- 9.** Remove the waste toner bottle full sensor (S34) [A].



- 10.** Remove the waste toner bottle set sensor (S35) [A].



4.Replacement and Adjustment

Image Transfer Unit

Image Transfer Belt Unit

CAUTION

- Note that the image transfer belt unit cannot be attached or detached unless the ITB lock lever [A] and the ITB contact/separation lever [B] are released, and then the cover [C] is released.

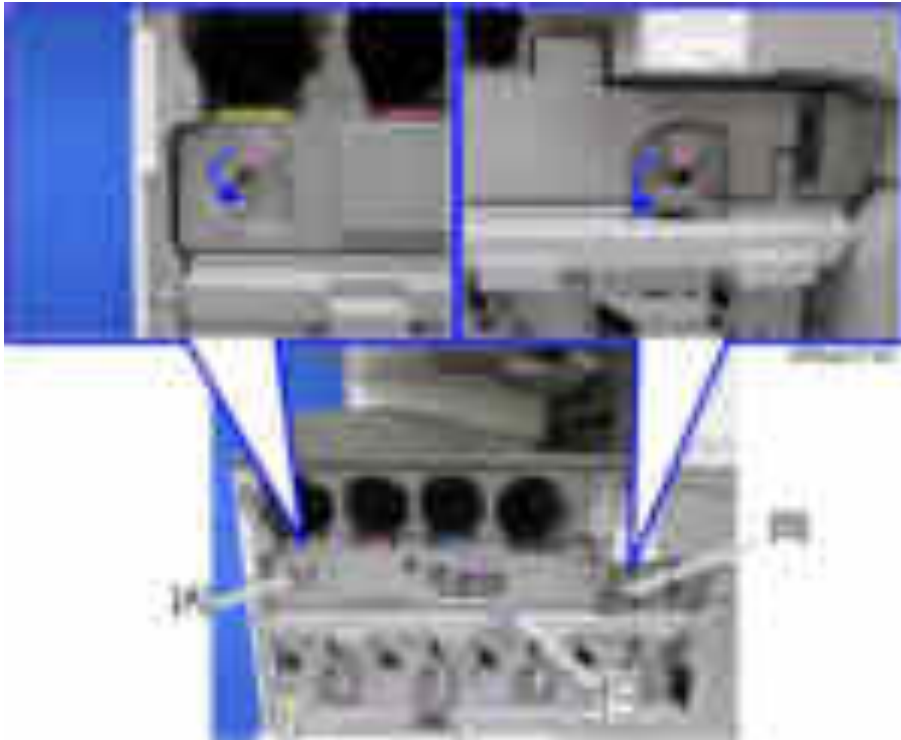

- Before you remove or attach the image transfer belt unit, open the right door and the paper transfer unit.

CAUTION

- **Precautions when attaching the image transfer belt unit:**
- Slowly push the unit until it is inserted all the way, and then give a final strong push one more time. Then lock the ITB lock lever and ITB contact lever.

If the ITB contact lever is locked with the image transfer belt unit not fully inserted into the machine, the paper transfer roller is not set in the correct position when the paper transfer roller unit is closed. This causes shadows on the image or paper jam, and the paper transfer roller unit may not open.

4.Replacement and Adjustment



What to Do before Replacing the Image Transfer Belt

Before replacing the image transfer belt unit and the Image transfer cleaning unit separately, set SP3-701-093 to "1" and switch the power OFF. Then replace the image transfer belt unit and switch the power ON.

This setting is unnecessary when replacing the image transfer belt unit and the Image transfer cleaning unit with a set.

SP3-701 (Manual New Unit Set)

This SP is the new unit detection flag.

0: new unit detection flag OFF, 1: new unit detection flag ON

Item	SP
Image Transfer Belt Unit	SP3-701-093

Replacement

- 1.** Open the front cover.
Release the lock of the ITB lock lever [A], ITB contact/separation lever [B], and cover [C].

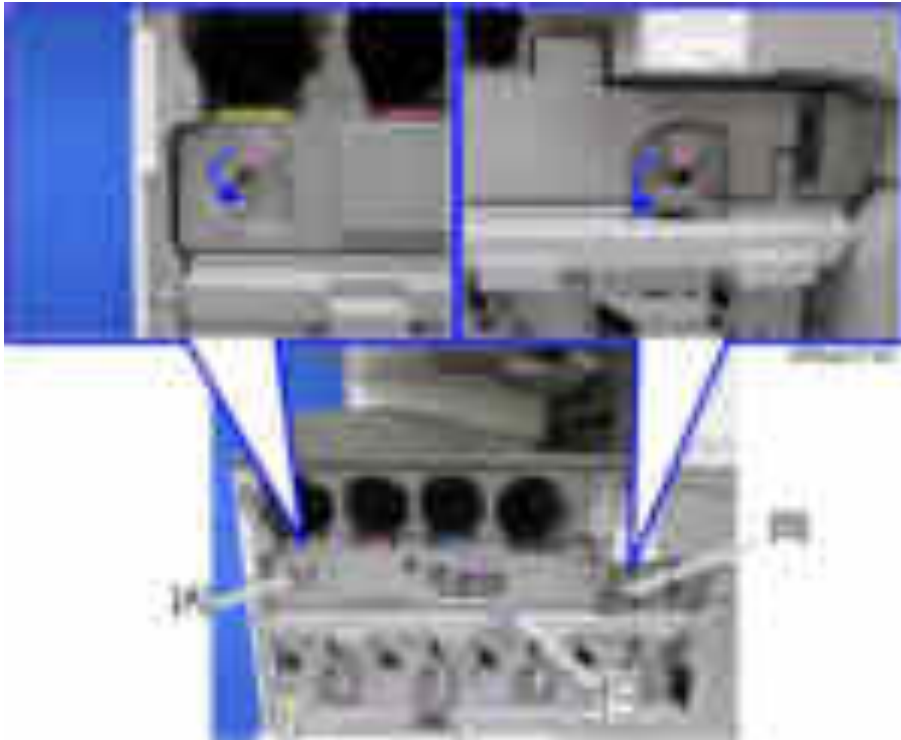

2. Open the right door [A].



3. Pull the paper transfer roller Unit [A].



4.Replacement and Adjustment

4. Pull out the image transfer belt unit [A] fully.



5. Lift the handle [A][B] to release the lock, and remove the image transfer belt unit.



Locking mechanism by a handle



Image Transfer Cleaning Unit

CAUTION

- Before removing the image transfer cleaning unit, turn the assembly upside down (as shown on the right), so that the image transfer cleaning unit is underneath the image transfer belt unit. This prevents scattering of toner.



Precaution

- When replacing the Image Transfer Cleaning Unit, do not touch the cleaning blade edge.



What to Do before Replacing the Image Transfer Cleaning Unit

Before replacing the image transfer belt unit and the Image transfer cleaning unit separately, set SP3-701-102 to "1" and switch the power OFF. Then replace the Image transfer cleaning unit and switch the power ON.

This setting is unnecessary when replacing the image transfer belt unit and the Image transfer cleaning unit with a set.

SP3-701 (Manual New Unit Set)

This SP is the new unit detection flag.

0: new unit detection flag OFF, 1: new unit detection flag ON

# ITB Cleaning Unit	SP3-701-102
---------------------	-------------

Replacement

- 1.** Remove the Image transfer belt unit. ([Image Transfer Belt Unit](#))

4.Replacement and Adjustment

2. Remove the ITB lock lever [A] and ITB contact/separation lever [B].

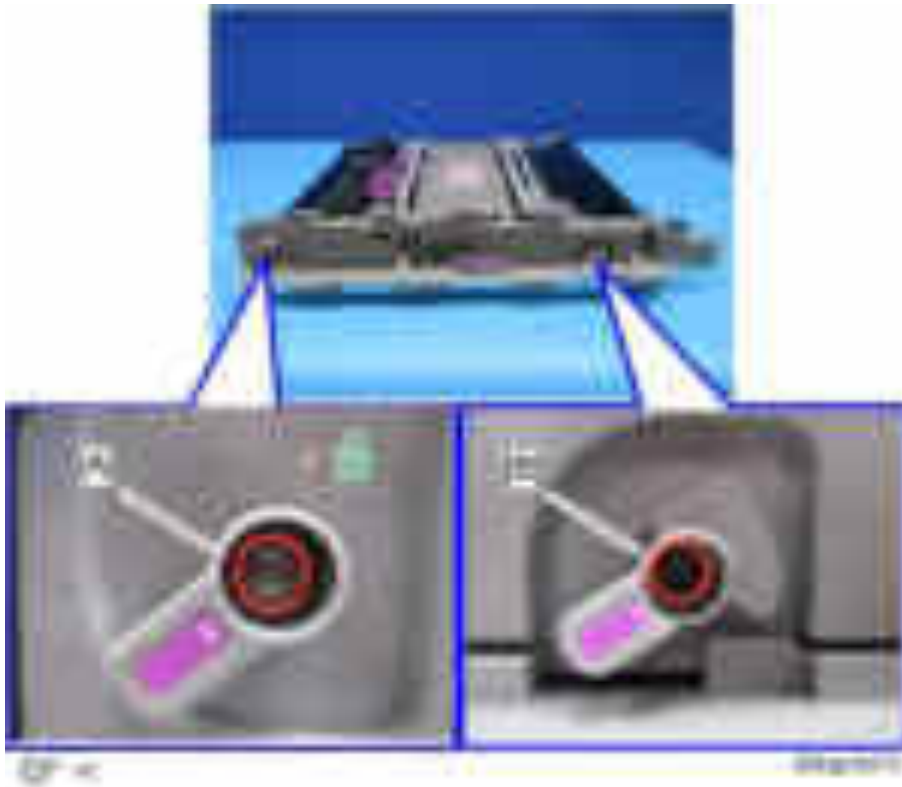

3. Remove the image transfer front cover [A].



4. Remove the image transfer upper cover [A].



- 5.** Remove the image transfer belt lock unit [A].



- 6.** Remove the screws above the image transfer cleaning unit [A].



- 7.** Turn the whole image transfer belt unit over, and remove the screws below the image transfer cleaning unit.



4.Replacement and Adjustment

- 8.** While releasing the hook, lift the image transfer belt unit gently, and remove the image transfer cleaning unit.



- 9.** Put toner on the image transfer belt.



[A]: About 50mm around the Roller [C].

[B]: About 5mm



- It is not necessary to specify the color of the toner, though yellow toner is used in the above example.

- 10.** Attach the new image transfer cleaning unit [A].



- 11.** Rotate the image transfer belt clockwise [A] by approximately 10 mm, and then rotate it

4.Replacement and Adjustment

counterclockwise [B] through one rotation of the belt. Make sure that the belt has not deviated.



Image Transfer Belt

CAUTION

- Do not touch the rollers but hold the upper/lower resin part [A] when you lift the Image Transfer Unit. Touching the rollers may cause poor image quality.



1. Remove the Image transfer belt unit. ([Image Transfer Belt Unit](#))
2. Remove the image transfer front cover. ([Image Transfer Cleaning Unit](#))
3. Remove the image transfer upper cover [A].



4.Replacement and Adjustment

- 4.** Remove the bracket [A].



- 5.** Remove the brackets [A] [B].



- 6.** Remove the image transfer cleaning unit. ([Image Transfer Cleaning Unit](#))

- 7.** Remove the tension fixing frames [A] and [B] (front side: black, rear side: gray).



- 8.** Holding the resin parts on the top and bottom, position the image transfer unit with the front side

underneath.



- 9.** Rotate the gear [A] to change to the OPEN position.
The part in the red circle opens.



- 10.** Release the tension, and remove the belt.

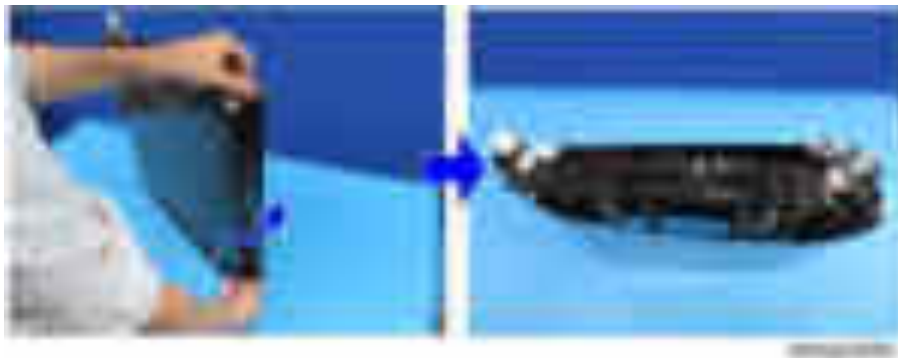

4.Replacement and Adjustment



Attaching the Belt

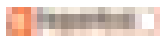

- When attaching the belt, make sure that there is no foreign material on the roller.
- Make sure to attach the belt with the edge with markings (2 white dots) at the unit's rear.
- Be careful not to bend or scratch the belt.

- 1.** Place the image transfer unit upright with its front face down, and then attach the belt from the top. Make sure to have the belt's edge with markings (2 white dots) positioned at the top (unit's rear).



- 2.** Holding the resin parts on the top and bottom, place the unit on its side.
- 3.** Adjust the belt position according to the following two points:
 - The belt must be attached between the flanges [A] at both ends of the tension roller.

4.Replacement and Adjustment

- The belt's edge must be between the two lines [B] on the frame.



- 4.** Apply tension back to normal.

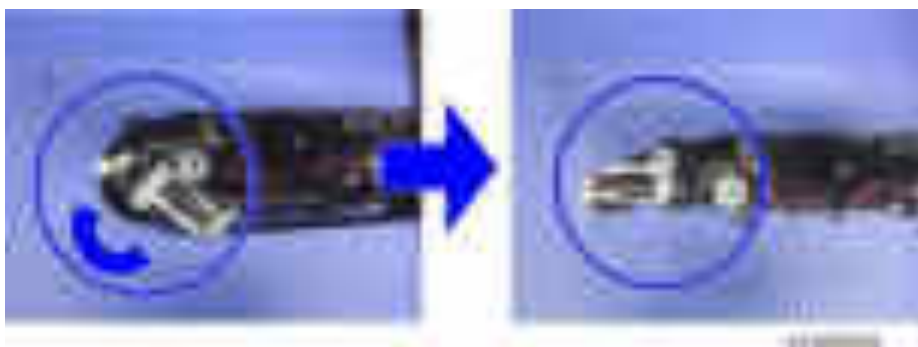

- 5.** Rotate the gear to change to the CLOSED position.
The part in the red circle closes.

4.Replacement and Adjustment



6. Attach the tension fixing frames [A] and [B] (front side: black, rear side: gray).



7. Attach the bracket [A] and [B].



8. Put toner on the image transfer belt.



[A]: About 50mm around the Roller [C].

[B]: About 5mm



- It is not necessary to specify the color of the toner, though yellow toner is used in the example above.

9. Attach the image transfer cleaning unit [A].



10. Rotate the image transfer belt clockwise [A] by approximately 10 mm, and then rotate it counterclockwise [B] through one rotation of the belt. Make sure that the belt has not deviated.



4.Replacement and Adjustment

11. Attach the bracket [A].



12. Attach the image transfer lock unit [A].



13. Attach the image transfer upper cover [A].



14. Attach the image transfer front cover, and then install the image transfer unit on the machine.

Paper Transfer Roller

1. Open the paper transfer unit. ([Paper Transfer Roller Unit](#))

2. Remove the paper transfer roller [A].

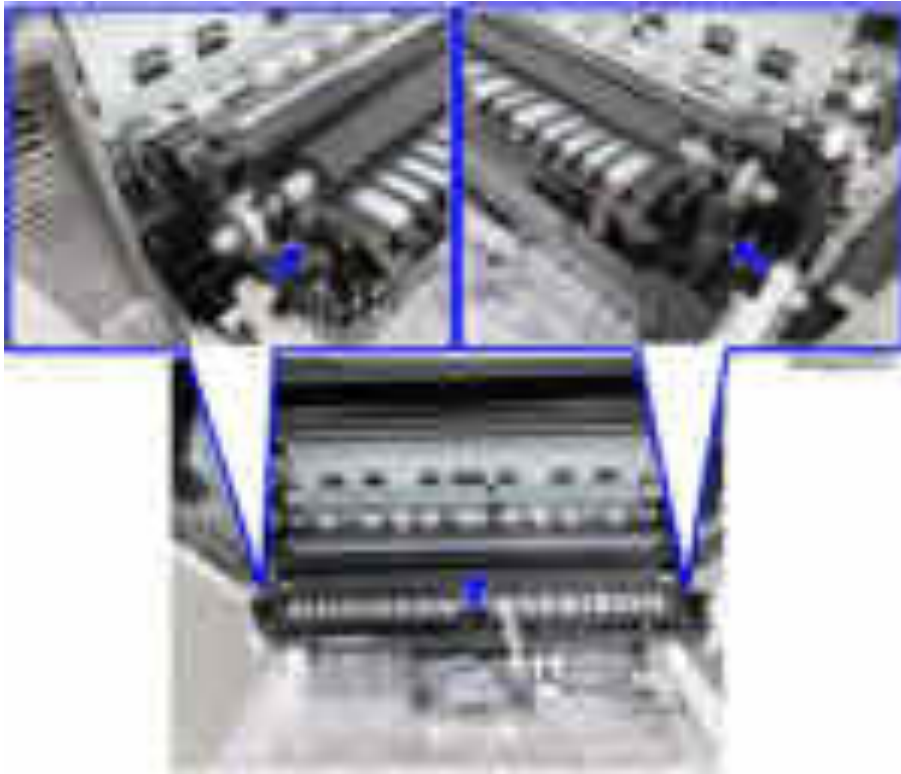

When reinstalling the paper transfer roller

When reinstalling the paper transfer roller, do not install the wrong type of roller.

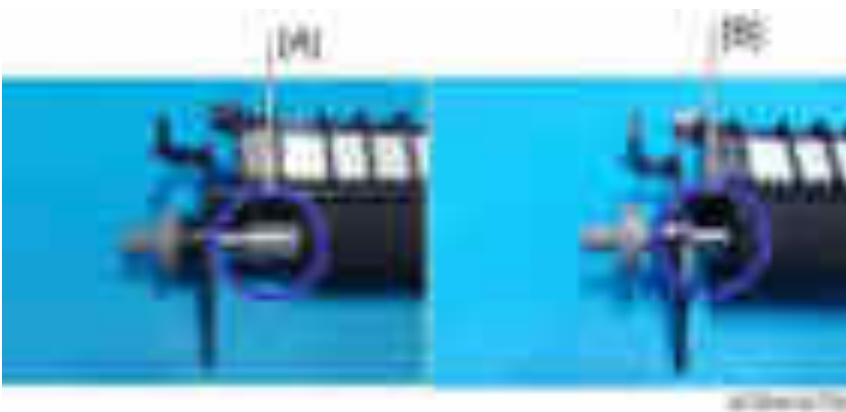

[A]: Standard roller

[B]: Imageable Area Extension Unit Type M19

When attaching the paper transfer roller, make sure that the roller is set in the correct position while referring to the three points described below.



- If the paper transfer roller is set incorrectly, the following problems may occur.
 - Damage to the image transfer belt
 - Roller detachment when opening and closing the paper transfer roller unit to remove a paper jam

4.Replacement and Adjustment

- The paper transfer roller unit does not open

1. Check that the tab [A] on the roller holder is under the guide plate [B].

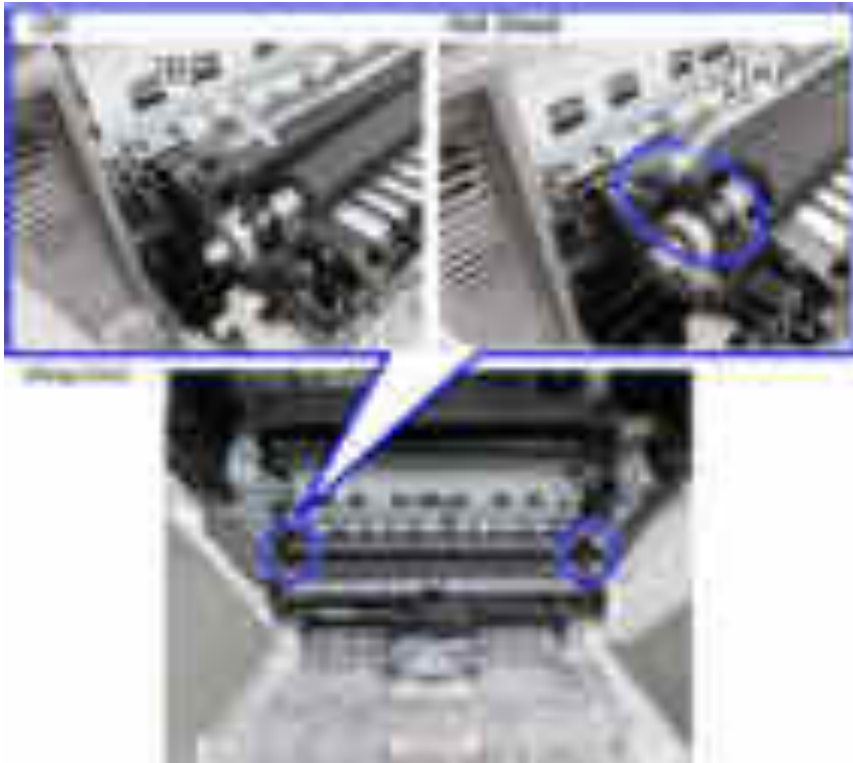

2. Check that the pin [A] on either end of the paper transfer roller is inserted correctly.

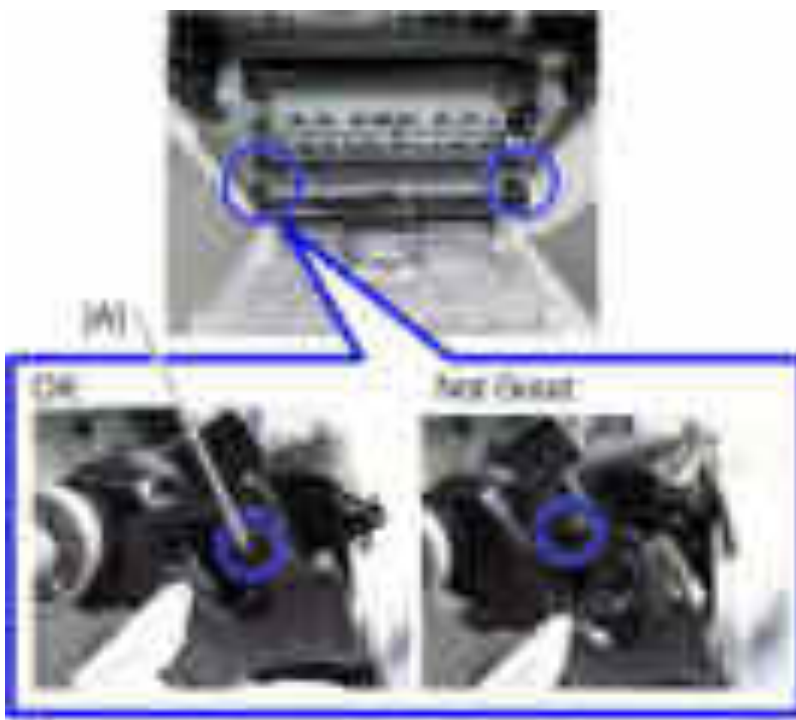

3. Check that the spring [A] at either end of the paper transfer roller unit is in the correct position at

each end.

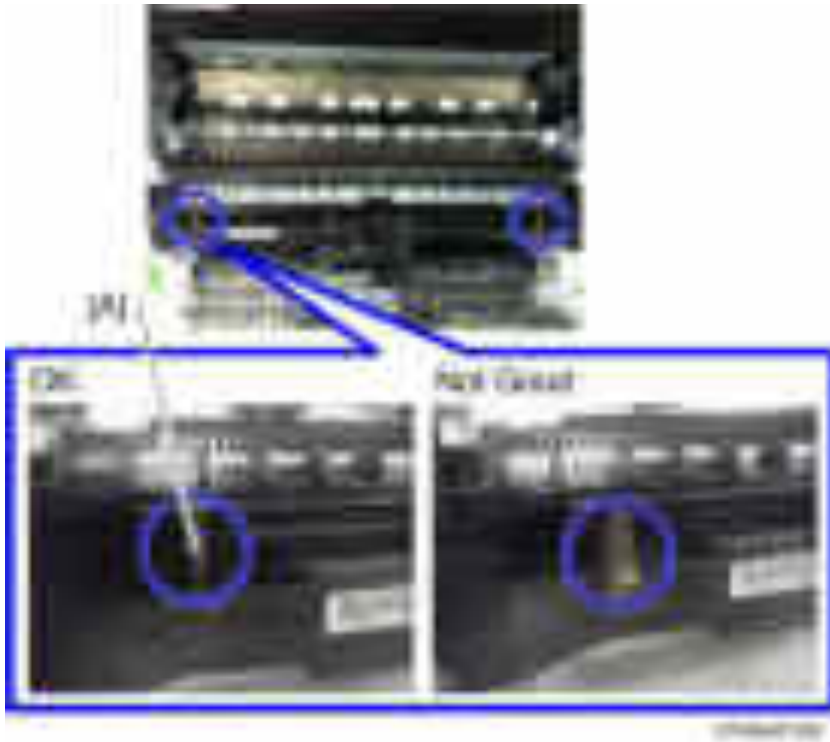

Paper Transfer Roller Unit

What to Do before Replacing the Paper Transfer Roller Unit

Before replacing the Image Paper Transfer Roller Unit, set SP3-701-109 to "1" and switch the power OFF. Then replace the Image Paper Transfer Roller Unit and switch the power ON.

SP3-701 (Manual New Unit Set)

This SP is the new unit detection flag.

0: new unit detection flag OFF, 1: new unit detection flag ON

Item	SP
Paper Transfer Roller Unit	SP3-701-109

Replacement

1. Open the right door.

4.Replacement and Adjustment

2. Remove the right clip ring and connector on the rear side.



3. Open the paper transfer roller unit. ([Paper Transfer Roller Unit](#))

4. Remove the left clip ring at the front side, and remove the paper transfer roller unit [A].



CAUTION

- Note that the sizes of the clip ring differ on the left and right.

INFORMATION

- When attaching a paper transfer roller unit, first attach the bushings [A] to the paper transfer roller unit.

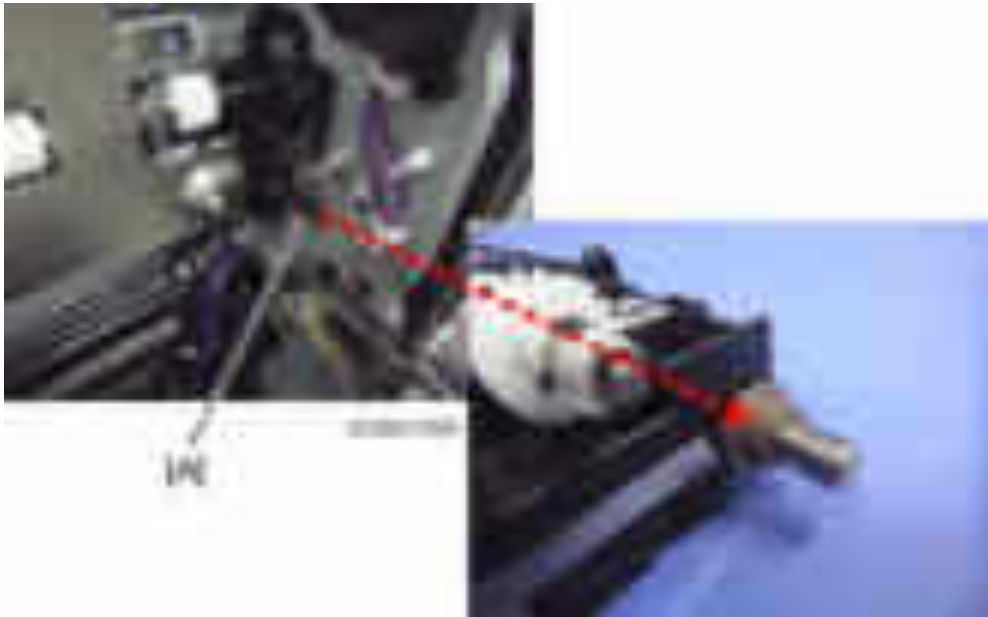

Fusing Entrance Sensor (S1)

- 1.** Open the right door.
- 2.** Remove the fusing entrance sensor unit [A].



- 3.** Remove the fusing entrance sensor (S1) [A].



4.Replacement and Adjustment

TM/ID Sensor (S48)

Before Replacing the TM/ID Sensor (S48)

Each sensor assembly has a list of characteristic values attached to it. Before you replace the TM/ID sensor, you must do the following procedure, or process control/MUSIC will not be done correctly after power is switched on (it will use the values for the old sensor).



- The characteristic values attached to the service part must be entered before replacement. It is recommended that in case Process control/MUSIC after replacement is not completed successfully, take a note of values of SP3-333, SP3-334, and SP3-335.

1. Note the characteristic values that are listed on the barcode label.



- TM/ID Sensor (front): F, TM/ID Sensor (center): C, TM/ID Sensor (rear): R, be careful.

2. Turn on the main power switch, and then go into the SP mode.

3. Input the characteristic values.

Input data for TM/ID Sensor (S48): F into SP3-333. Input data for TM/ID sensor: C into SP3-334.

Input data for TM/ID sensor: R into SP3-335.

SP No.	Classification 1	Classification 2	Value
3-333-001	ID.Sens TestVal:F	K2: Check	TM/ID sensor: F, value of [1]
3-333-002	ID.Sens TestVal:F	Diffuse Corr	TM/ID sensor: F, value of [2]
3-333-003	ID.Sens TestVal:F	Vct_reg Check:Slope	TM/ID sensor: F, value of [3]
3-333-004	ID.Sens TestVal:F	Vct_reg Check:Xint	TM/ID sensor: F, value of [4]
3-333-005	ID.Sens TestVal:F	Vct_dif Check:Slope	TM/ID sensor: F, value of [5]
3-333-006	ID.Sens TestVal:F	Vct_dif Check:Xint	TM/ID sensor: F, value of [6]
3-334-001	ID.Sens TestVal:C	K2: Check	TM/ID sensor: C, value of [1]
3-334-002	ID.Sens TestVal:C	Diffuse Corr	TM/ID sensor: C, value of [2]
3-334-003	ID.Sens TestVal:C	Vct_reg Check:Slope	TM/ID sensor: C, value of [3]
3-334-004	ID.Sens TestVal:C	Vct_reg Check:Xint	TM/ID sensor: C, value of [4]
3-334-005	ID.Sens TestVal:C	Vct_dif Check:Slope	TM/ID sensor: C, value of [5]
3-334-006	ID.Sens TestVal:C	Vct_dif Check:Xint	TM/ID sensor: C, value of [6]
3-335-001	ID.Sens TestVal:R	K2: Check	TM/ID sensor: R, value of [1]
3-335-002	ID.Sens TestVal:R	Diffuse Corr	TM/ID sensor: R, value of [2]

SP No.	Classification 1	Classification 2	Value
3-335-003	ID.Sens TestVal:R	Vct_reg Check:Slope	TM/ID sensor: R, value of [3]
3-335-004	ID.Sens TestVal:R	Vct_reg Check:Xint	TM/ID sensor: R, value of [4]
3-335-005	ID.Sens TestVal:R	Vct_dif Check:Slope	TM/ID sensor: R, value of [5]
3-335-006	ID.Sens TestVal:R	Vct_dif Check:Xint	TM/ID sensor: R, value of [6]

Replacement procedure

- 1.** Remove the Image transfer belt unit. ([Image Transfer Belt Unit](#))
- 2.** Remove the paper transfer roller unit. ([Paper Transfer Roller Unit](#))
- 3.** Remove the fusing unit. ([Fusing Unit](#))
- 4.** Remove the shield position sensor unit. ([Shield Position Sensor \(S50\) \(IM C6000/5500/4500\)](#))
- 5.** Remove the TM/ID sensor unit [A].

CAUTION

- When installing the TM/ID sensor unit.
 - 1. Attach the screw of the front side [B]
 - 2. Attach the screw of the back side [C]
- When installed in reverse order, an SC may occur because the sensor position has shifted.

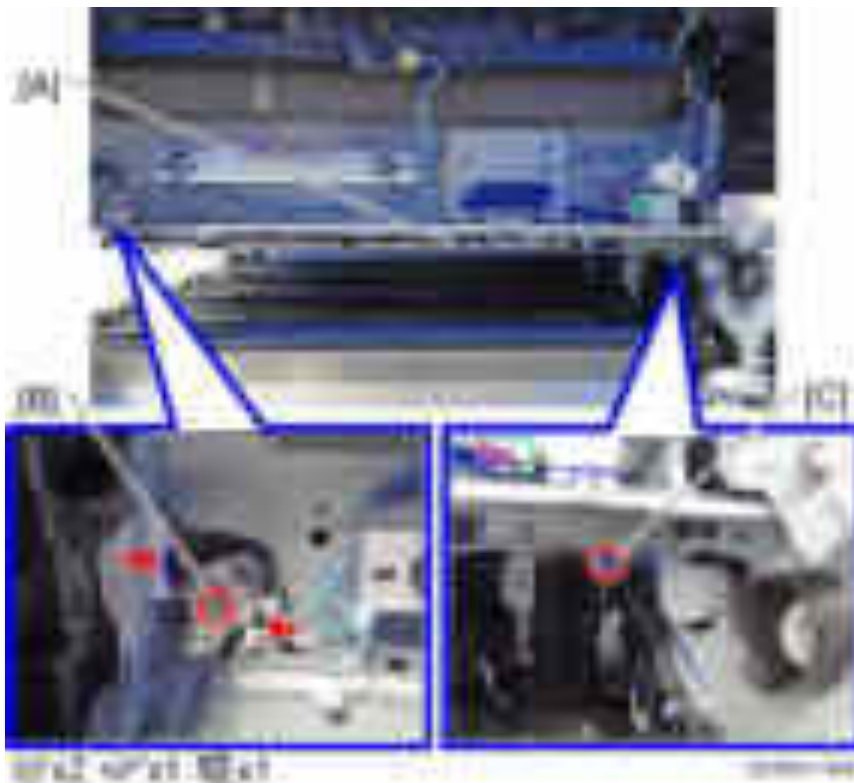

4.Replacement and Adjustment

6. Disconnect the connectors.

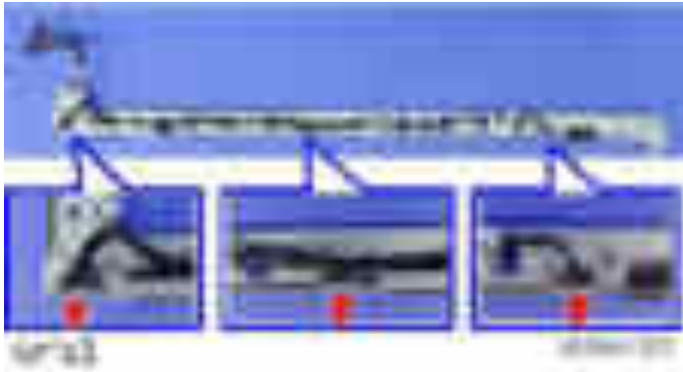

7. Remove the TM/ID sensor [A].



Adjustment after replacing the TM/ID sensor

- 1.** Turn on the main power switch, and then go into the SP mode.
- 2.** Run SP3-011-004 (Manual ProCon: Exe Full MUSIC).
- 3.** Check the result code with SP3-012-001 to 030.

Related SP

- SP3-011-004 (Manual ProCon :Exe: Full MUSIC)
Executes Process Control and full MUSIC.
- SP3-012-001 to 010 (ProCon OK?: Front)
Displays the past 10 Process Control result codes detected by the front TM/ID sensor. The code is 2 digits per color from the left, in the order of YMCK.
- SP3-012-011 to 020 (ProCon OK?: Center)
Displays the past 10 Process Control result codes detected by the center TM/ID sensor. The code is 2 digits per color from the left, in the order of YMCK.
- SP3-012-021 to 030 (ProCon OK?: Rear)
Displays the past 10 Process Control result codes detected by the rear TM/ID sensor. The code is 2 digits per color from left, in the order of YMCK.

ProCon results code

Category	Code	Result name	Description
----------	------	-------------	-------------

4.Replacement and Adjustment

00 and larger	00	Not executed	Factory default setting (SP default)
10 and larger Result (Normal)	11	Succeeded	-
40 and larger ID Sensor	41	ID sensor output error (Max)	Vt > Max
	42	ID sensor output error (Min)	Vt < Min
	43	ID Sensor error (Max)	Development gamma is in target, but Vt value is less than upper limit.
	44	ID Sensor error (Min)	Development gamma is in target, but Vt value is less than lower limit.
45 and larger ID Pattern detection	45	ID Pattern extract error	Cannot detect ID Pattern
	50	Vmin_Bk/K2 error(Max)	K:Vmin_Bk / CMY:K2>Max
	51	Vmin_Bk/K2 error(Min)	K:Vmin_Bk / CMY:K2<Min
	52	K5 error (Max)	K5>Max
	53	K5 error (Min)	K5<Min
	54	K5 calculated approximate point error	K5 calculated approximate point <Min
	55	Development gamma error (Max)	Development gamma >Max
	56	Development gamma error (Min)	Development gamma <Min
	57	Start developing voltage: Vk error(Max)	Start developing voltage: Vk>Max
	58	Start developing voltage: Vk error(Min)	Start developing voltage: Vk<Min
59	Not enough valid data	Adhesion amount data for development gamma calculation point is under 2	
60 and larger Potential adjustment	61	LD won't light	P pattern is not written.
	62	Residual potential: Vr error	Vr>Max
	63	Electrified potential: Vd adjust error	Vd cannot be adjusted in the target range.
	64	Exposure potential: Vpl adjust error	Vpl cannot be adjusted in the target range
90 and larger Result(End)	90	Potential not adjusted	Potential control method is set as [0:FIX]
	99	Stopped	Stopped by door open, power off, error. (Set when to execute.)

4.Replacement and Adjustment



- Execution result example (In order of YMCK from left)
- Factory default (SP default): [00,00,00,00]
- Starting adjust: [99,99,99,99]
- Fail Vsg adjust(Y): [21,99,99,99]
- Error of Development gamma Max(C): [99,99,55,99]
- Succeeded: [11,11,11,11]

Temperature and Humidity Sensor (S41)

- 1.** Remove the 1st and 2nd paper tray. ([Paper Feed Sensor \(S12\) \(S22\) \(IM C6000/5500/4500/3500/3000\)](#))
- 2.** Remove the main power switch cover [A].



- 3.** Insert a screwdriver through the hole in the frame, and detach the temperature and humidity sensor (S41) together with its bracket [A].

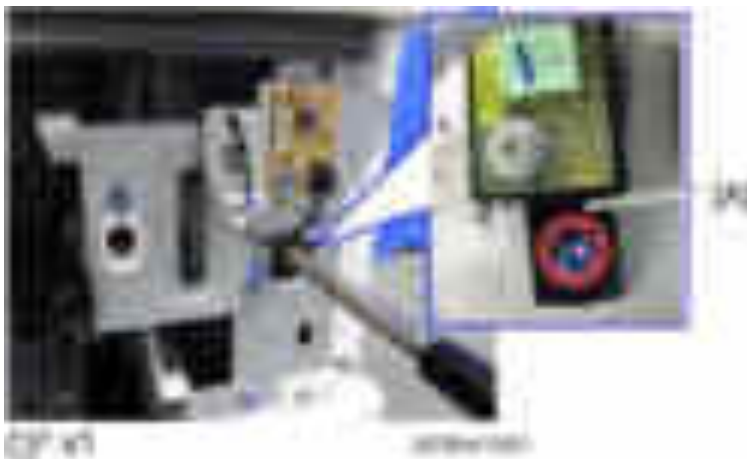

4. Remove the temperature and humidity sensor (S41) [A].



ITB Contact and Release Sensor (S32)

1. Remove the image transfer belt unit. ([Image Transfer Belt Unit](#))
2. Remove the PCDUs. ([PCDU](#))
3. Remove the ITB contact and release sensor (S32) [A] together with the bracket.



4. Remove the ITB contact and release sensor (S32) [A].



4.Replacement and Adjustment

Image Transfer Lock Unit

- 1.** Open the front cover. ([Front Cover](#))
- 2.** Release the image transfer lock levers [A] [B].

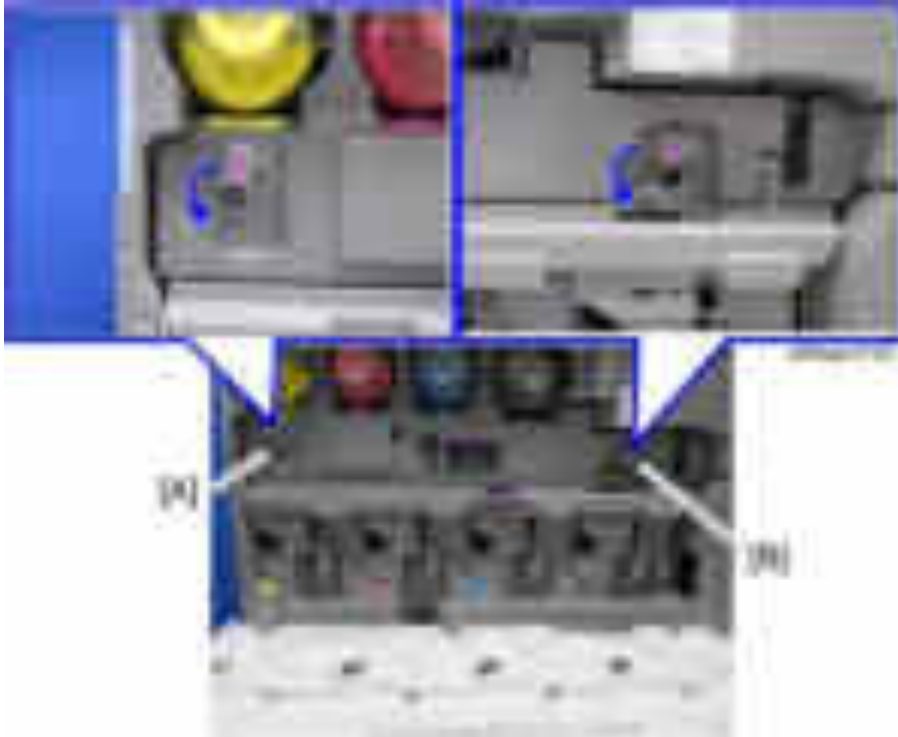

- 3.** Remove the ITB lock lever [A] and ITB contact/separation lever [B].



- 4.** Remove the Image transfer front cover [A].



- 5.** Remove the image transfer lock unit [A].



Installing the Image Transfer Lock Unit

CAUTION

- When installing the image transfer lock unit, release the ITB lock lever and follow the procedures below, taking care to avoid deformation of the pin inside the unit (circled in red below).
If the pin is deformed, the shutter on the waste toner recovery path may not open and waste toner may clog the cleaning unit.

Pin inside the image transfer lock unit (red circle):

4.Replacement and Adjustment



- 1.** Before installing, check that the lever [A] on the image transfer lock unit is in the unlocked position.

Unlocked position:



- 2.** Install the image transfer lock unit [A] so that the gear [B] on the image transfer unit side fits into space in the image transfer lock unit circled in blue below.



- 3.** Return the ITB lock lever to the locked position.

Drive Unit

Overview

IM C6000/C5500/C4500

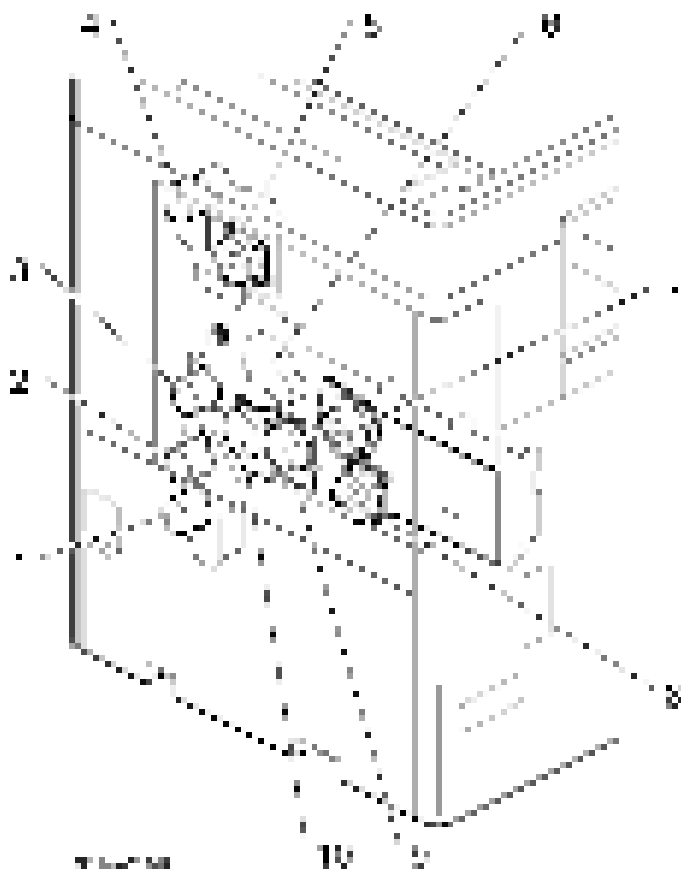

No.	Description	No.	Description
1	Paper feed motor (M6)	6	Paper transfer contact and release motor (M18) with paper transfer contact and release sensor (S36)
2	Transport motor (M5)	7	PCU motor: CMY (M15)
3	Registration motor (M7)	8	Development motor: CMY (M16)
4	Paper exit / pressure release motor (M4)	9	Development motor: Black (M29)
5	Fusing motor (M8)	10	PCU: black / image transfer motor (M17)

4.Replacement and Adjustment

IM C3500/C3000/C2500/C2000

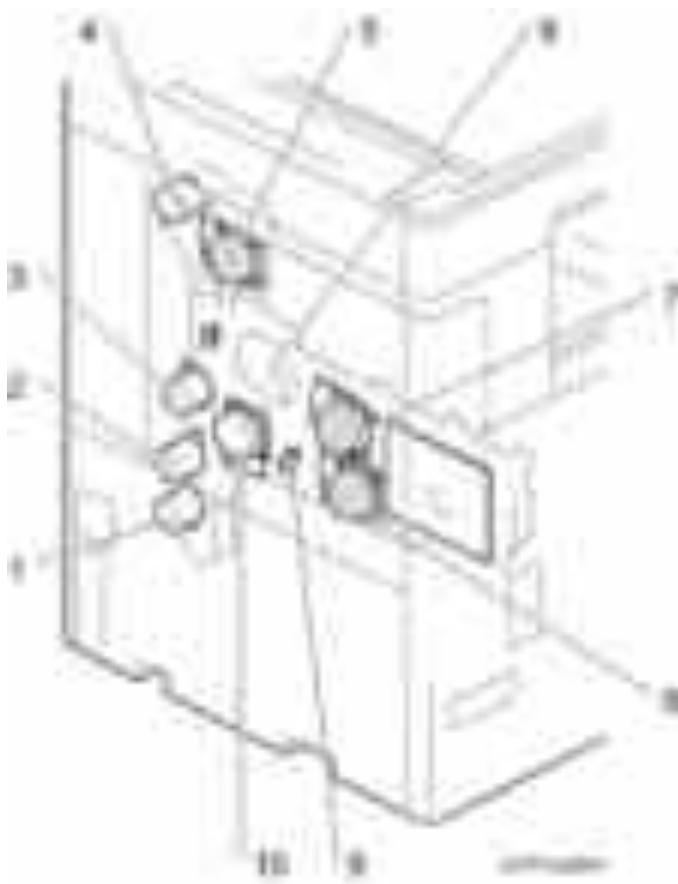

No.	Description	No.	Description
1	Paper feed motor (M6)	6	Paper transfer contact and release motor (M18) with paper transfer contact and release sensor (S36)
2	Transport motor (M5)	7	PCU motor: CMY (M15)
3	Registration motor (M7)	8	Development motor: CMY (M16)
4	Paper exit / pressure release motor (M4)	9	Development solenoid (SOL4)
5	Fusing motor (M8)	10	PCU: Black / image transfer motor (M17)

Paper Feed Motor (M6)

- 1.** Remove the power supply box. ([Power Supply Box](#))

2. Remove the paper feed motor (M6) [A].

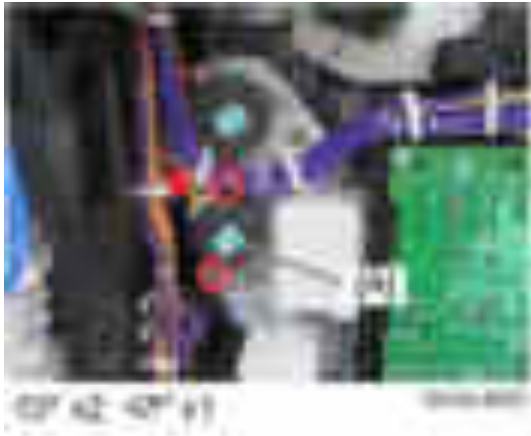

Transport Motor (M5)

1. Remove the power supply box. ([Power Supply Box](#))
2. Remove the transport motor (M5) [A].



Paper Transfer Contact and Release Motor Unit (M18)

1. Remove the controller box. ([Controller Box](#))
2. Remove the paper transfer contact and release motor unit [A].



4.Replacement and Adjustment

Imaging Drive Unit

- 1.** Remove the controller box. ([Controller Box](#))
- 2.** Remove the power supply box. ([Power Supply Box](#))
- 3.** Remove the right rear cover. ([Right Rear Cover](#))
- 4.** Remove the bracket [A].

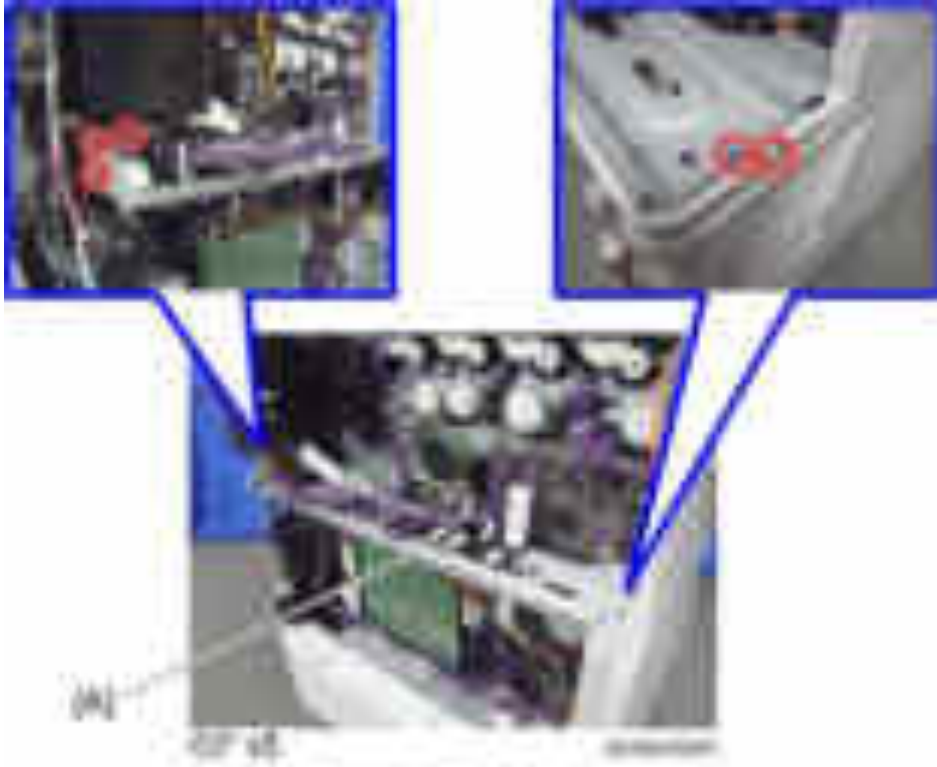

- 5.** Remove the drive cooling fan (FAN9). ([Drive Cooling Fan \(FAN9\) \(IM C6000/C5500/C4500 Only\)](#))

6. Remove the imaging drive unit [A].

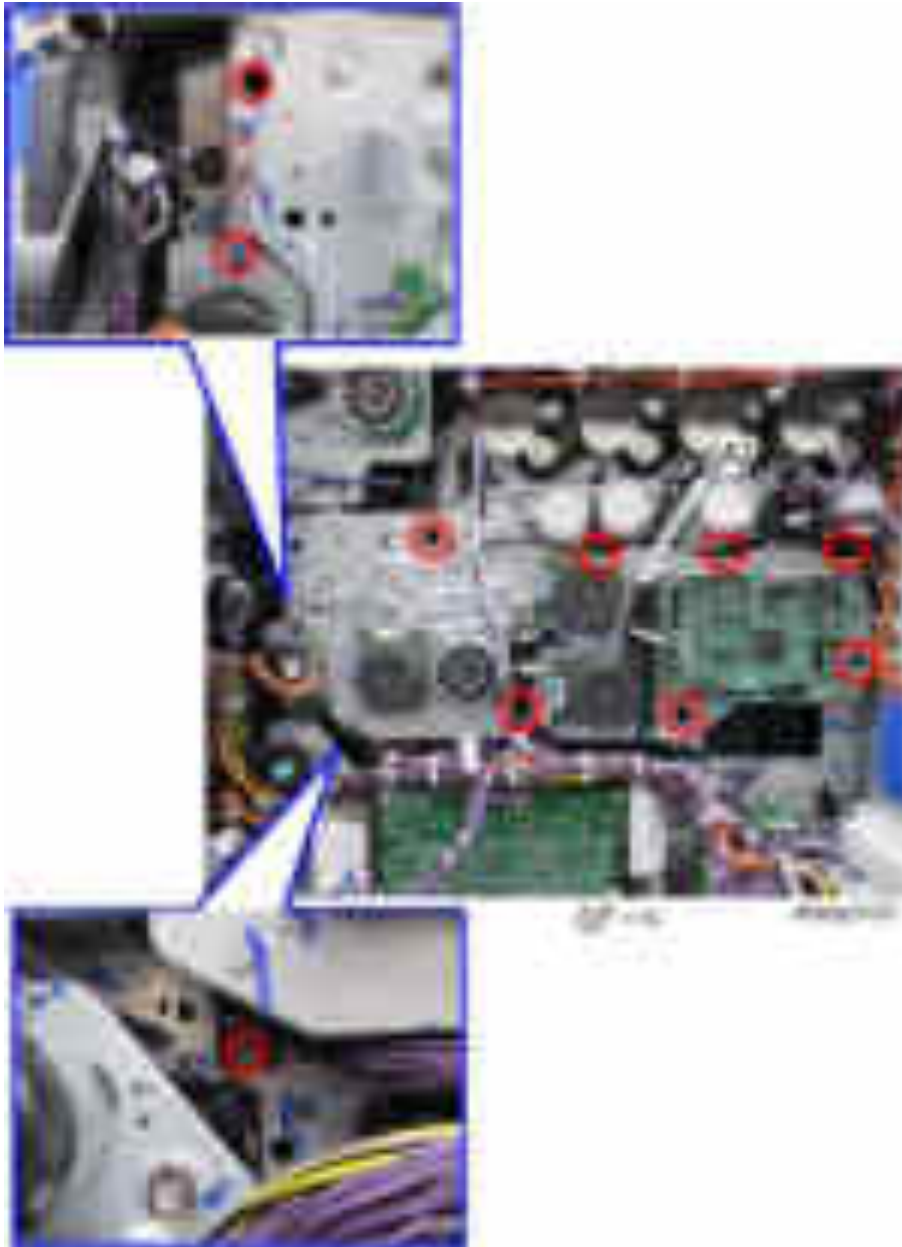

PCU Motor: CMY (M15)

1. Remove the controller box. ([Controller Box](#))

4.Replacement and Adjustment

2. Remove the PCU Motor: CMY (M15) [A].



Development Motor: CMY (M16)

1. Remove the bracket. ([Imaging Drive Unit](#))
2. Remove the development Motor: CMY (M16) [A].



Development Motor: Black (M29)

1. Remove the bracket. ([Imaging Drive Unit](#))
2. Remove the development Motor: Black (M29) [A].



PCU: Black / Image Transfer Motor (M17)

- 1.** Remove the bracket. ([Imaging Drive Unit](#))
- 2.** Remove the PCU: Black / Image Transfer Motor (M17) [A].



Registration Motor (M7)

- 1.** Remove the power supply box. ([Power Supply Box](#))
- 2.** Remove the drive cooling fan (FAN9) ([Drive Cooling Fan \(FAN9\) \(IM C6000/C5500/C4500 Only\)](#))
- 3.** Remove the registration motor (M7) [A].



Fusing Motor (M8)

- 1.** Remove the right rear cover ([Right Rear Cover](#))

4.Replacement and Adjustment

2. Remove the fusing motor (M8) [A].



Paper Exit / Pressure Release Motor (M4)

1. Remove the fusing exhaust fan (FAN1). ([Fusing Exhaust Fan \(FAN1\)](#))
2. Remove the paper exit / pressure release motor (M4) [A].



Duplex Entrance Motor (M1)

1. Remove the paper exit unit. ([Paper Exit Unit](#))
2. Remove the fusing exhaust fan (FAN1). ([Fusing Exhaust Fan \(FAN1\)](#))
3. Remove the duplex entrance motor unit [A].



- 4.** Remove the duplex entrance motor (M1) [A].



Toner Supply Motor (M19) (M20) (M21) (M22)

- 1.** Remove the controller box. ([Controller Box](#))
- 2.** Remove the toner supply cooling fan (FAN5) (Toner Supply Cooling Fan (FAN5) : IM C2500/2000).
- 3.** Remove the duct [A] (IM C2500/2000).



- 4.** Remove the toner supply motor.



[A]	K	x2, x1
[B]	C	x2, x1
[C]	M	x2, x1

4.Replacement and Adjustment

[D]	Y	☒×2, ☒×1
-----	---	----------

Sub Hopper

When removing the sub hopper, be careful not to tilt it to avoid spilling the toner inside the hopper.



When replacing the sub hopper because of clogged toner, replace the toner duct [A], too.

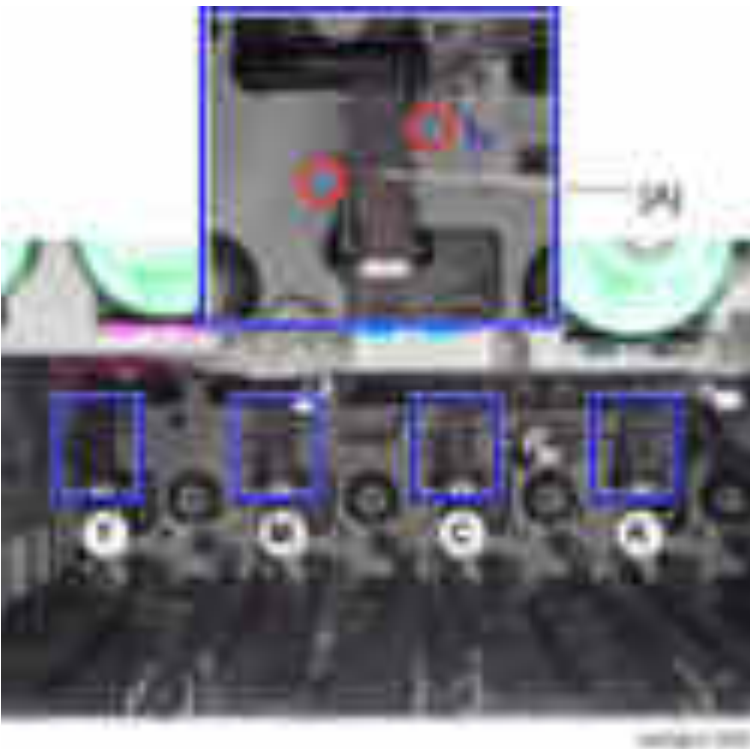

K

- 1.** Pull out the image transfer unit about 5cm.
- 2.** Remove the controller box. ([Controller Box](#))
- 3.** Remove the toner supply cooling fan (FAN5) (Toner Supply Cooling Fan (FAN5) : IM C2500/2000).
- 4.** Remove the duct (IM C2500/2000).

- 5.** Remove the toner supply motor unit (K) [A].



- 6.** Remove the sub hopper (K) [A].



C

- 1.** Pull out the image transfer unit about 5cm.
- 2.** Remove the controller box. ([Controller Box](#))
- 3.** Remove the toner supply cooling fan (FAN5) (Toner Supply Cooling Fan (FAN5) : IM C2500/2000).
- 4.** Remove the duct (IM C2500/2000).
- 5.** Remove the harness guide [A].
- 6.** Remove the toner supply motor unit (C) [B].



4.Replacement and Adjustment

7. Remove the hopper (C) [A].



M

1. Remove the controller box. ([Controller Box](#))
2. Remove the harness guide [A].



3. Remove the toner supply motor unit (M) [A].



- 4.** Remove the hopper (M) [A].



Y

- 1.** Remove the Harness guide [A].



- 2.** Remove the toner supply motor unit (Y) [A].



4.Replacement and Adjustment

- 3.** Remove the hopper (Y) [A].



Toner End Sensor (S18)(S19)(S20)(S21)

- 1.** Remove the hopper. ([Sub Hopper](#))
- 2.** Remove the toner end sensor (S18)(S19)(S20)(S21) [A].



- The toner end sensors are the same for each color.

Toner Bottle Drive Motor

K

- 1.** Remove the toner supply motor (K) (M19). ([Toner Supply Motor \(M19\) \(M20\) \(M21\) \(M22\)](#))

2. Remove the toner bottle drive motor (K) (M11) [A].



C

1. Remove the toner supply motor (C) (M20). (Toner Supply Motor (M19) (M20) (M21) (M22))
2. Remove the toner bottle drive motor (C) (M12) [A].



M

1. Remove the toner supply motor (M) (M21). (Toner Supply Motor (M19) (M20) (M21) (M22))
2. Remove the toner bottle drive motor (M) (M13) [A].



Y

1. Remove the toner supply motor (Y) (M22). (Toner Supply Motor (M19) (M20) (M21) (M22))

4.Replacement and Adjustment

2. Remove the toner bottle drive motor (Y) (M14) [A].



ID Chip Contact Board

K

1. Remove the toner bottle drive motor (K) (M11).
2. Remove the toner bottle drive motor (C) (M12).
3. Remove the ID chip contact board (K) (PCB3) [A].



C

1. Remove the toner bottle drive motor (C) (M12).
2. Remove the toner bottle drive motor (M) (M13).

- 3.** Remove the ID chip contact board (C) (PCB4) [A].

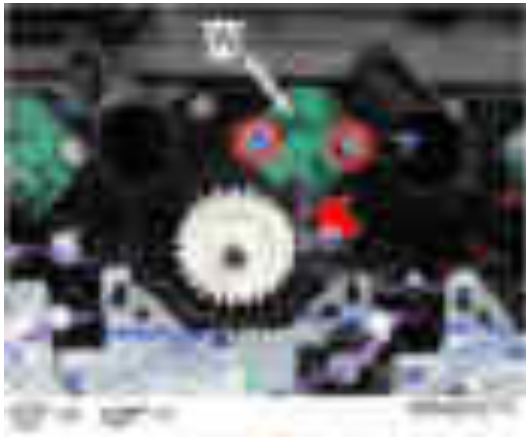

M

- 1.** Remove the toner bottle drive motor (M) (M13).
- 2.** Remove the toner bottle drive motor (Y) (M14).
- 3.** Remove the ID chip contact board (M) (PCB5) [A].



Y

- 1.** Remove the toner bottle drive motor (Y) (M11).
- 2.** Remove the ID chip contact board (Y) (PCB6) [A].



4.Replacement and Adjustment

Transport Coil Unit

Y

- 1.** Remove the image transfer belt unit. ([Image Transfer Belt Unit](#))
- 2.** Remove the PCDU. ([PCDU](#))
- 3.** Remove the toner bottle drive motor unit (K/C/M/Y). ([Toner Bottle Drive Motor](#))
- 4.** Remove the sub hopper (K/C/M/Y). ([Sub Hopper](#))
- 5.** Remove the ID chip contact board. ([ID Chip Contact Board](#))
- 6.** Put a piece of disposable paper [A] on the inside of the machine to avoid damage due to toner spillage.



- 7.** Put a piece of disposable paper [A] under the transport coil to avoid damage due to toner spillage.



- 8.** Remove all the harnesses connecting to the transport coil unit [A].



- 9.** Remove the screws fixing the transport coil units [A] ( ×5, each color).



- 10.** Release the claws for the transport coil units [A] (hook ×1, each color).



- 11.** Remove the screws securing the bracket [A].

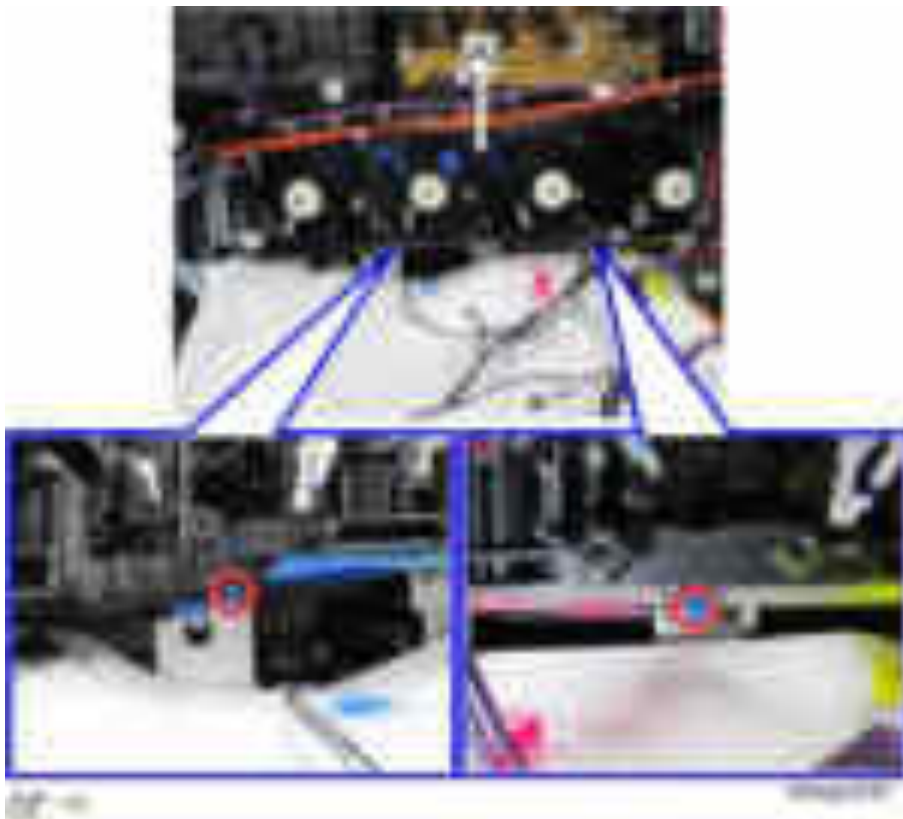

4.Replacement and Adjustment

12. Pull out the whole transport coil unit [A] together with the bracket [B].



- Be sure to put a piece of disposable paper on the floor because toner can spill when you put the transport coil unit down.

13. Remove the transport coil unit for (Y) [A] (tab×1).



M

1. See steps 1 to 13 in the transport coil replacement procedure for “Y”. (Y)
2. Remove the transport coil unit for (M) [A] (tab×1).



C

1. See steps 1 to 13 in the transport coil replacement procedure for “Y”. (Y)
2. Remove the transport coil unit for (C) [A] (tab×1).



4.Replacement and Adjustment

K

1. See steps 1 to 13 in the transport coil replacement procedure for “Y”. (Y)
2. Remove the transport coil unit for (K) [A] (tab×1).



Development Solenoid (Only IM C2500/2000)

1. Remove the controller box. ([Controller Box](#))
2. Remove the power supply box. ([Power Supply Box](#))
3. Remove the right rear cover. ([Right Rear Cover](#))
4. Remove the solenoid cover [A].



- 5.** Remove the development solenoid [A].



Fusing Unit

Fusing Unit

CAUTION

- Because there is a danger of burns on contact with hot parts of the fusing unit, start work when the temperature drops to a low enough temperature.
- To clear SC544-02 or SC554-02, replacing the fusing unit or installing a fuse (provided in the fusing sleeve belt unit) in the fusing unit must be required. Refer to "How to cancel SC544-02/SC554-02 with a new unit detection fuse" in "[Fusing Sleeve Belt Unit](#)".

Clearing SC544-02 or SC554-02 when Replacing the Fusing Unit

1. Install the new fusing unit. (The machine detects the new unit, so a unit previously installed on another machine cannot clear SC544-02 and SC554-02.)
2. Execute SP5-810-002 [SC Reset: Hard High Temp. Detection]. *SP5-810-002 [SC Reset: Hard High Temp. Detection] is new SP.
3. The fusing unit features the new unit detection function, so it is not necessary to reset the PM counter manually when replacing the fusing unit and dust filter together.

The dust filter's PM counter will also be reset.

When replacing only the fusing unit, perform SP3-701-116 [Manual New Unit Set: #Fusing Belt].

Note

- When the fusing unit is used past its target yield (400k), the fusing unit may break, causing a service call. Therefore, the machine displays a warning on the operation panel at 415k pages and stops at 430k pages.

- 1.** Open the paper transfer roller unit [A]. ([Image Transfer Belt Unit](#))



2. Remove the fusing unit [A].



Fusing Entrance Guide Plate

1. Remove the fusing unit. ([Fusing Unit](#))
2. Remove the fusing entrance guide plate [A].

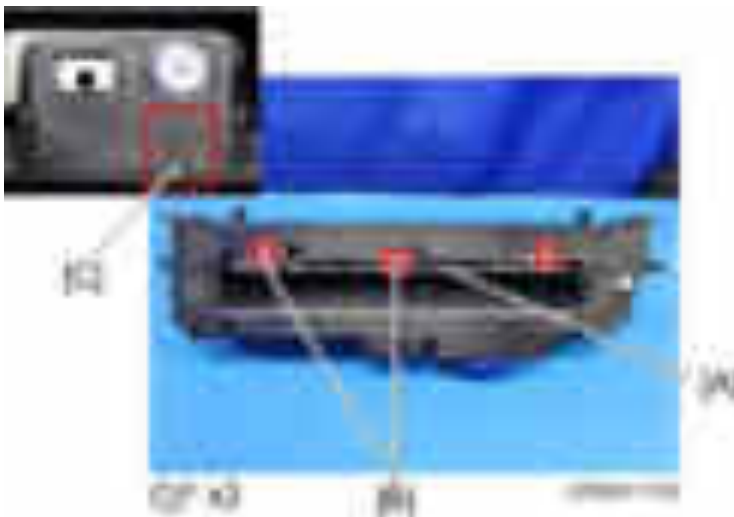

- The screws [B] are threaded screws. When you assemble the unit, take care not to use the wrong screws.
- Fasten the screw in the marked screw hole [C].

4.Replacement and Adjustment

Cleaning the Fusing Entrance Guide Plate

Carefully remove adhering toner as shown in the diagram below with a dry cloth. Then, wipe with a cloth moistened with alcohol.



Fusing Exit Guide Plate

- 1.** Remove the fusing unit. ([Fusing Unit](#))
- 2.** Remove the fusing upper cover. ([Fusing Upper Cover](#))
- 3.** Remove the fusing exit guide plate [A].
Remove the clip ring, and then slide this part to the right to remove it.

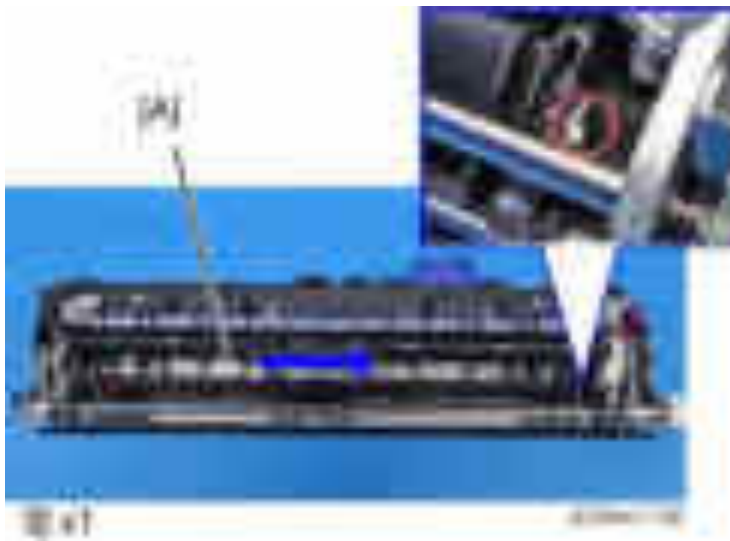

Cleaning the Fusing Exit Guide Plate

1. Open the fusing exit guide plate [A].



2. Wipe clean with a dry cloth. Then wipe clean with a cloth dampened with alcohol.



Fusing Upper Cover

1. Remove the fusing unit. ([Fusing Unit](#))
2. Remove the fusing upper cover [A].



Fusing Lower Cover

1. Remove the fusing unit. ([Fusing Unit](#))

4.Replacement and Adjustment

2. Remove 4 screws on the front and rear sides.



3. Lift the fusing unit to remove the fusing lower cover [A].



Fusing Sleeve Belt Unit

CAUTION

- The fusing sleeve belt unit is designed with a highly soft material. Do not touch the fusing sleeve belt unit with your hands to prevent dents during replacement. If you have touched it and a dent has been made, the dent will gradually become larger during operation and it can cause a fusing malfunction or sleeve belt breakage.

CAUTION

- To cancel SC544-02/SC554-02, it is necessary to replace the fusing unit or install an intact new unit detection fuse included with the fusing sleeve belt unit.
- If you are replacing the fusing sleeve belt unit for PM or any reason other than canceling SC544-02/SC554-02, you can discard the fuse that is packed with the new fusing sleeve belt unit.

Adjustment before Replacing the Fusing Sleeve Belt Unit

Before replacing the fusing sleeve belt unit, set SP3-701-116 to "1" and switch the power OFF. Then replace the fusing sleeve belt unit and switch the power ON.

SP3-701 (Manual New Unit Set)

This SP is the new unit detection flag. 0: new unit detection flag OFF, 1: new unit detection flag ON

Item	SP
Fusing sleeve belt unit	SP3-701-116

Replacement Procedure

1. Remove the fusing upper cover. ([Fusing Upper Cover](#))
2. Remove the fusing lower cover. ([Fusing Lower Cover](#))
3. Remove the left frame [A].



4. Remove the exit guide plate (left) unit [A].



5. Remove the fusing exit driven roller [A].



4.Replacement and Adjustment

6. Remove the side plate [A].



7. Remove the two screws.



- 8.** Release the boss caps on both sides, and then detach the fusing sleeve belt unit [A].



- 9.** Remove the spring, and then remove the separation plate [A] and supports [B].

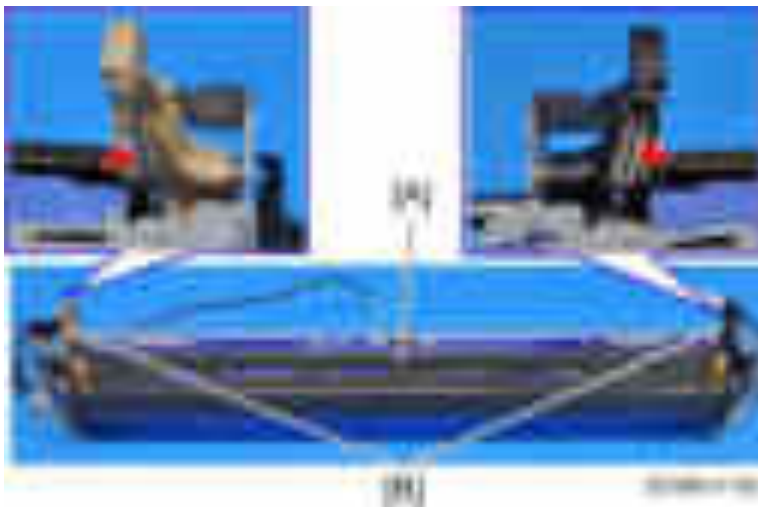

How to cancel SC544-02/SC554-02 with a new unit detection fuse

CAUTION

- To cancel SC544-02/554-02, it is necessary to replace the fusing unit or install an intact new unit detection fuse. If you will cancel these SCs by installing a new unit detection fuse, follow the instruction below.
- If you are replacing the fusing sleeve unit for PM or any reason other than canceling these SCs, you can discard the fuse that is packed with the new heating sleeve unit.

4.Replacement and Adjustment

1. There is a new unit detection fuse packed with the new fusing sleeve belt unit.



2. Connect the new unit detection fuse to the connector [A], and place the fuse in the empty space [B].



3. Execute SP5-810-002 [SC Reset: Hard High Temp. Detection].
4. Execute SP3-701-116 [Manual New Unit Set: #Fusing Belt].

Pressure Roller

Adjustment before replacing the pressure roller

Before replacing the Pressure Roller, set SP3-701-118 to "1" and switch the power OFF. Then replace the Pressure Roller and switch the power ON.

SP3-701 (Manual New Unit Set)

This SP is the new unit detection flag.

0: new unit detection flag OFF, 1: new unit detection flag ON

Item	SP
Pressure Roller	SP3-701-118

Replacement

CAUTION

- Do not remove or adjust the pressure adjusting screws [A] when replacing the pressure roller.
- The fusing unit is adjusted in the factory to match the hardness of the pressure roller, so that the nip width will be correct.



- Do not move the pressure roller to another fusing unit.

- 1.** Remove the fusing sleeve belt unit. ([Fusing Sleeve Belt Unit](#))
- 2.** Remove the pressure roller [A].



- 3.** Apply the grease (FLUOTRIBO MG GREASE) to the rear shaft of the pressure roller at 5-7mm

4.Replacement and Adjustment

from the cut edge.

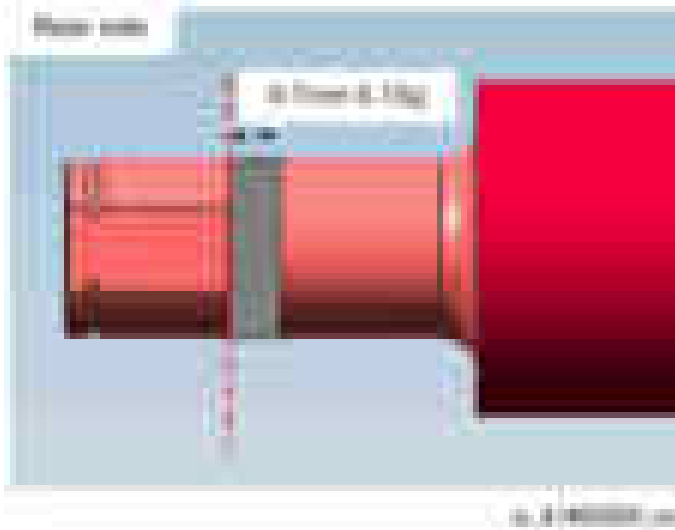

4. Apply the grease (FLUOTRIBO MG GREASE) to the front shaft of the pressure roller at 5-7mm from the C-ring notch.



Fusing Sleeve Thermostat Unit

1. Remove the left frame [A]. ([Fusing Sleeve Belt Unit](#))
2. Remove the fusing sleeve thermostat unit [A].



Non-Contact Thermistor (S46)(S47)

1. Remove the left frame. ([Fusing Sleeve Belt Unit](#))

2. Remove the non-contact thermistor unit [A].



Pressure Roller Thermistor (TH3) (TH4) (TH5)

1. Remove the fusing entrance guide plate. ([Fusing Entrance Guide Plate](#))
2. Remove the fusing upper cover. ([Fusing Upper Cover](#))
3. Remove the fusing lower cover. ([Fusing Lower Cover](#))
4. Remove the pressure roller thermistor (TH3) (TH4) (TH5) [A].



Thermopile Unit

1. Remove the fusing unit. ([Fusing Unit](#))

4.Replacement and Adjustment

2. Remove the thermopile unit [A].



Pressure Roller HP Sensor (S26)

1. Remove the fusing unit. ([Fusing Unit](#))
2. Remove the pressure roller HP sensor unit [A].



3. Remove the pressure roller HP sensor (S26) [A].

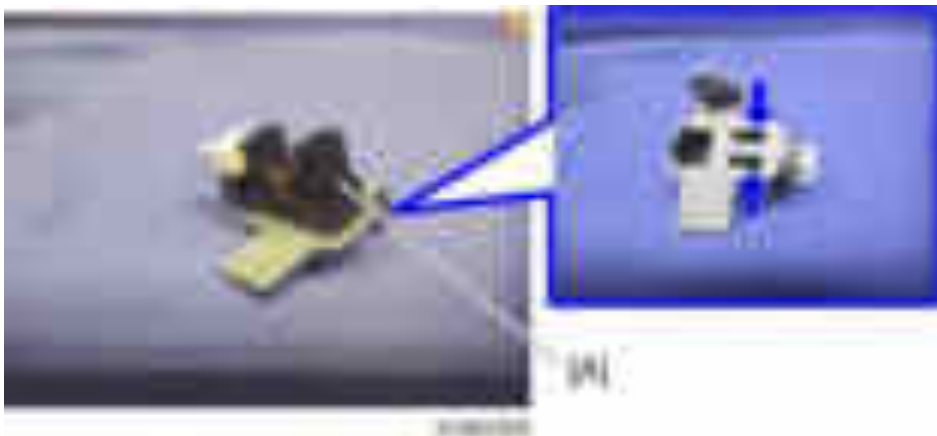

Shield Position Sensor (S50) (IM C6000/5500/4500)

1. Remove the fusing unit. ([Fusing Unit](#))

2. Remove the shield position sensor unit [A].



3. Remove the shield position sensor (S50) [A].

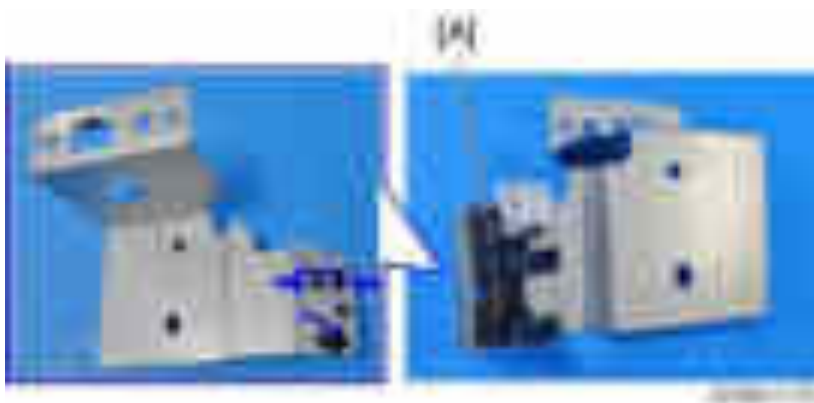

Shield Drive Motor (M28) (IM 6000/5500/4500)

1. Remove the fusing unit. ([Fusing Unit](#))
2. Remove the shield drive motor unit [A].



4.Replacement and Adjustment

3. Remove the shield drive motor (M28) [A].



Fusing Exit Drive Solenoid (SOL3)

1. Remove the paper exit unit. ([Paper Exit Unit](#))
2. Remove the fusing exit drive solenoid (SOL3) [A].



Paper Exit

Paper Exit Unit

1. Remove the fusing unit. ([Fusing Unit](#))
2. Remove the inner cover [A].



3. Remove the screws and connector of the paper exit unit [A].

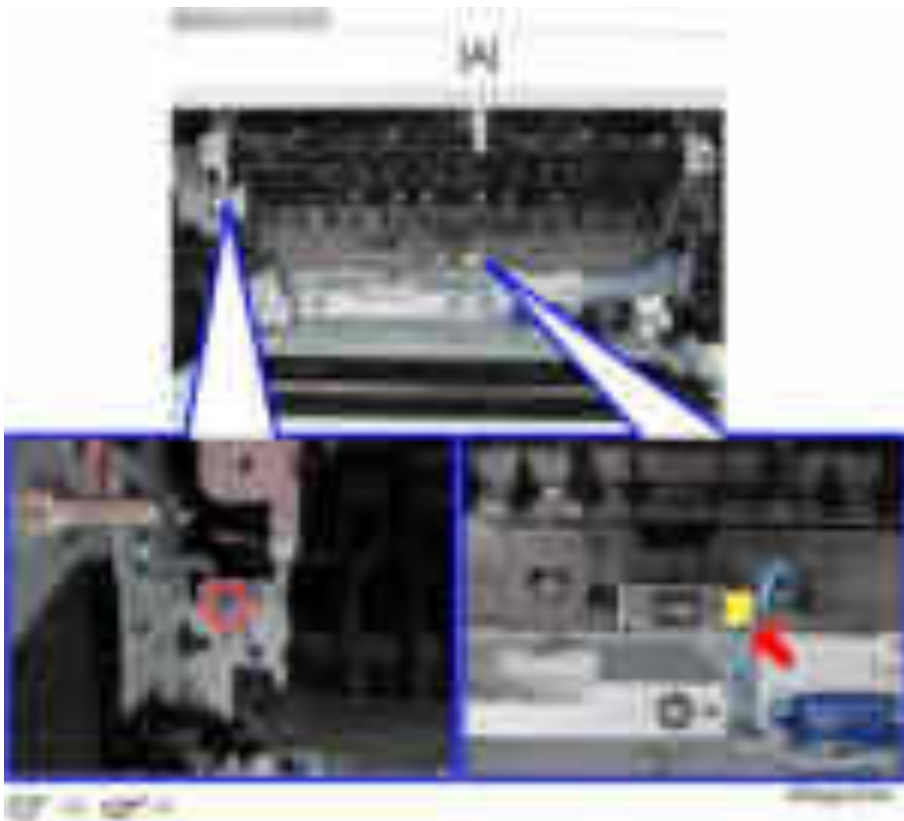

4.Replacement and Adjustment

4. Remove the paper exit unit [A].



Paper Exit Solenoid (SOL2)

1. Remove the paper exit unit. ([Paper Exit Unit](#))
2. Remove the paper exit solenoid (SOL2) [A].



Paper Exit Sensor (S10)

1. Remove the paper exit unit. ([Paper Exit Unit](#))
2. Remove the feeler [A].



- 3.** Remove the harness [A].



- 4.** Remove the paper exit sensor unit [A].

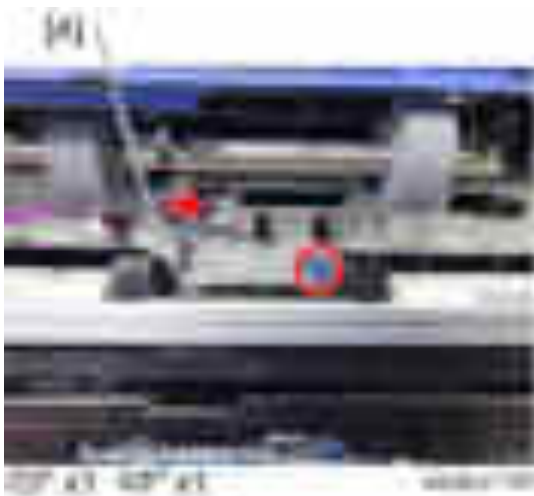

- 5.** Remove the paper exit sensor (S10) [A].



Reverse Sensor (S9)

- 1.** Remove the paper exit unit. ([Paper Exit Unit](#))

4.Replacement and Adjustment

2. Remove the reverse sensor unit [A].



When attaching the reverse sensor (S9), if you screw too tightly in the direction of the blue arrow, it may cause the gap between the guide plates [A] to be too narrow, resulting in paper jams. Make sure that there is a gap [A] of 3mm or more after you fasten the screw.



3. Remove the reverse sensor (S9) [A].

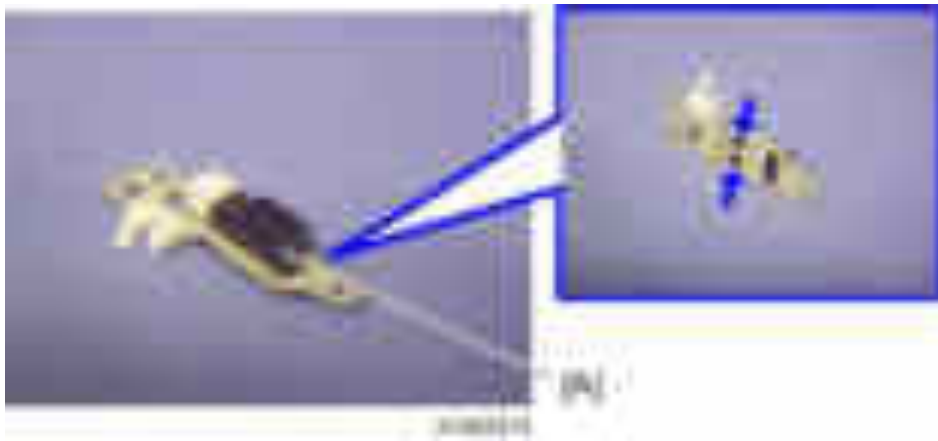

Paper Exit Full Sensor (S11) (IM C6000/C5500/C4500/C3500/C3000)

1. Remove the paper exit unit. ([Paper Exit Unit](#))
2. Remove the paper exit full sensor unit [A].



4.Replacement and Adjustment

3. Remove the paper exit full sensor (S11) [A].



Reverse Motor (M3)

1. Remove the paper exit unit. ([Paper Exit Unit](#))
2. Remove the gear [A] (Tab x1).



3. Remove the reverse motor unit [A].



- 4.** Remove the reverse motor (M3) [A].

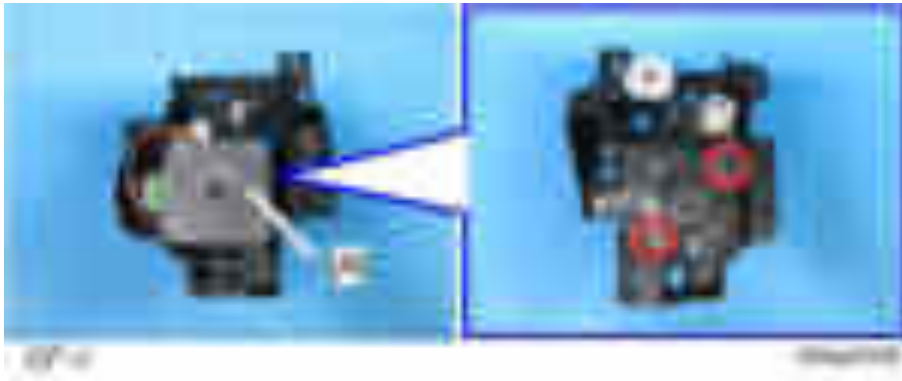

Fusing Exit Sensor (S27)

- 1.** Remove the paper exit unit. ([Paper Exit Unit](#))
2. Remove the fusing exit sensor unit [A].



- 3.** Remove the fusing exit sensor (S27) [A].



4.Replacement and Adjustment

Paper Feed



- The 1st paper feed unit can be removed without removing the duplex unit (just open the right door), and you can remove the paper feed unit after pulling out the paper tray.
- The 1st paper feed unit and 2nd paper feed unit are not interchangeable.
- The 1st paper feed unit for the MP C6004 is not interchangeable with the 1st paper feed unit for other models.

Paper Feed Unit

1st Paper Feed Unit

- 1.** Open the right door wide (Arms [A] [B]).



- 2.** Pull out the 1st paper tray [A].



- 3.** Remove the screws of the 1st paper feed unit [A] and the stopper of the paper feed guide plate [B].



4. Press the tab to release the lock, and remove the paper feed guide plate [A].



5. Remove the 1st paper feed unit [A].

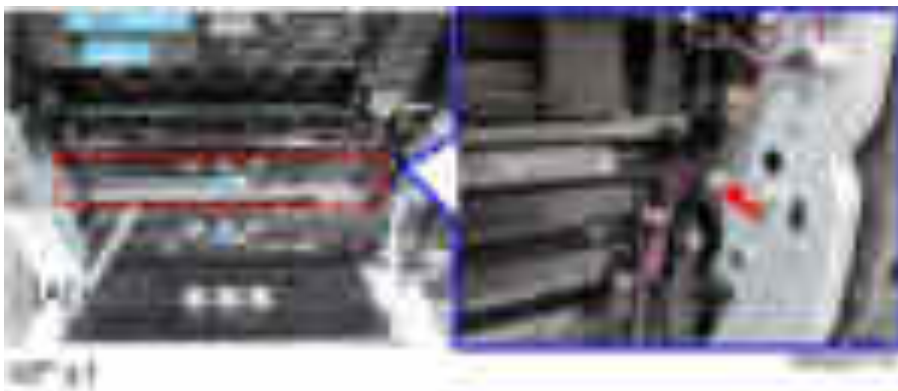

2nd Paper Feed Unit

1. Remove the duplex unit. ([Duplex Unit](#))

4.Replacement and Adjustment

2. Pull out the 2nd paper tray [A].



3. Remove the brackets [A] [B] on both sides.

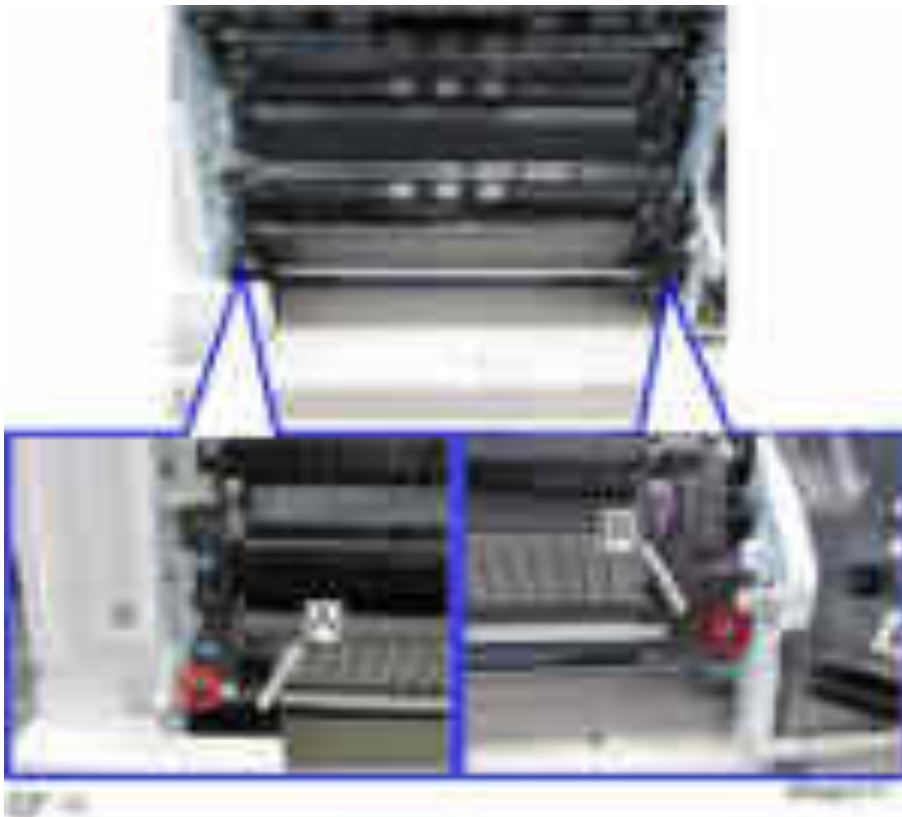

4. Remove the stopper, and then remove the paper feed guide plate [A].



- 5.** Press the tab to release the lock, and remove the paper feed guide plate [A].



- 6.** Remove the 2nd paper feed unit [A].



Paper Dust Collection Unit

- 1.** Open the right door wide (Arms [A] [B]).



4.Replacement and Adjustment

2. Remove the paper dust collection unit [A].



Pick-up Roller, Paper Feed Roller

1. Remove the paper feed unit. ([Paper Feed Unit](#))
2. Remove the retainer [A].



3. Remove the pick-up roller [A] and the paper feed roller [B].



Friction Roller (1st Paper Tray), Torque Limiter

1. Remove the paper feed guide plate of the 1st paper feed unit. ([Paper Feed Unit](#))

2. Remove the friction roller [A] and torque Limiter [B].



Friction Roller (2nd Paper Tray), Torque Limiter

1. Remove the paper feed guide plate of the 2nd paper feed unit. ([Paper Feed Unit](#))
2. Remove the friction roller [A] and torque Limiter [B].



Lift Motor (1st Feed Tray) (M9), Lift Motor (2nd Feed Tray) (M10)

1. Remove the HVP-CB with bracket. ([HVP-CB with Bracket](#))
2. Remove the lift motor (1st feed tray) (M9) [A].



4.Replacement and Adjustment

3. Remove the 2nd tray lift motor (2nd feed tray) (M10) [A].



Paper Feed Sensor (S12) (S22) (IM C6000/5500/4500/3500/3000)

1. Remove the paper feed unit. ([Paper Feed Unit](#))
2. Remove the paper feed sensor unit [A].



3. Remove the paper feed sensor (S12) (S22) [A].

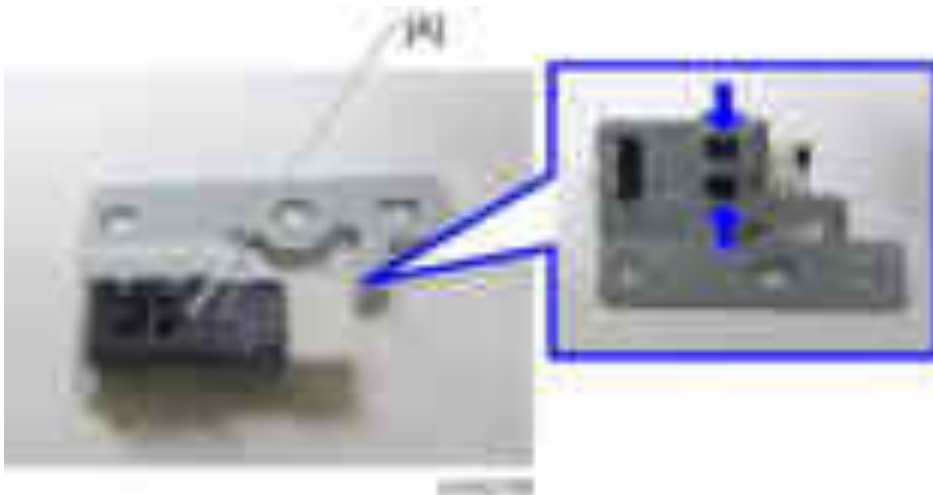

Transport Sensor (S13)(S23)

1. Remove the paper feed unit. ([Paper Feed Unit](#))
2. Remove the transport sensor unit [A].



3. Remove the transport sensor (S13)(S23) [A].



Upper Limit Sensor (S15) (S25)

1. Remove the paper feed unit. ([Paper Feed Unit](#))

4.Replacement and Adjustment

2. Remove the upper limit sensor (S15) (S25) [A].



Paper End Sensor (S14) (S24)

1. Remove the paper feed unit. ([Paper Feed Unit](#))
2. While pressing the tab enclosed by the blue circle, remove the paper end sensor (S14) (S24) [A].

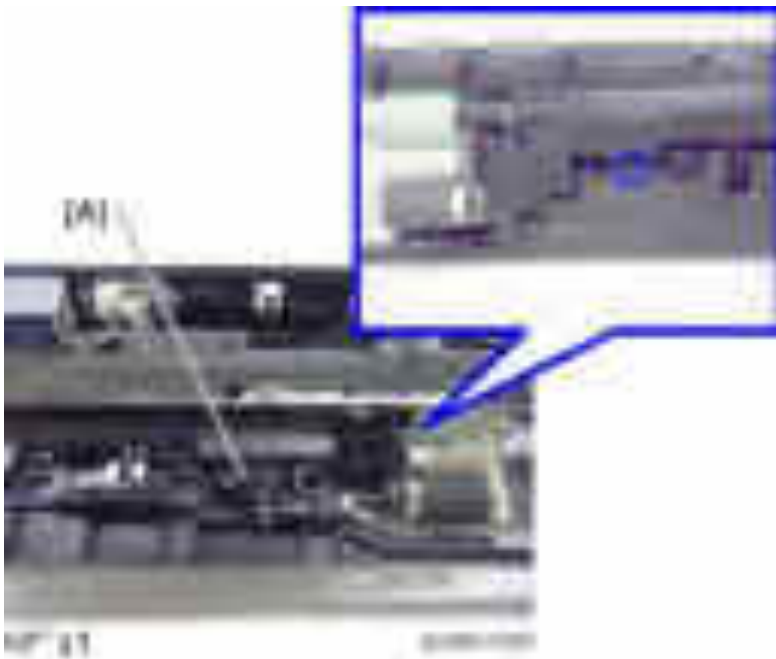

Registration Sensor (S16)

1. Open the right door.
2. Remove the paper transfer roller unit. ([Paper Transfer Roller Unit](#))

- 3.** Remove the inner bracket [A].



- 4.** Remove two screws, then release the tab by inserting a flathead driver behind the registration sensor (S16) [A].



Bypass Tray Unit

Bypass Tray

1. Open the right door. (Duplex Unit)
2. Remove the Arms [A] [B] of the right door.



3. Open the right door wide.
4. Remove the paper transport guide [A] (Tab×2).

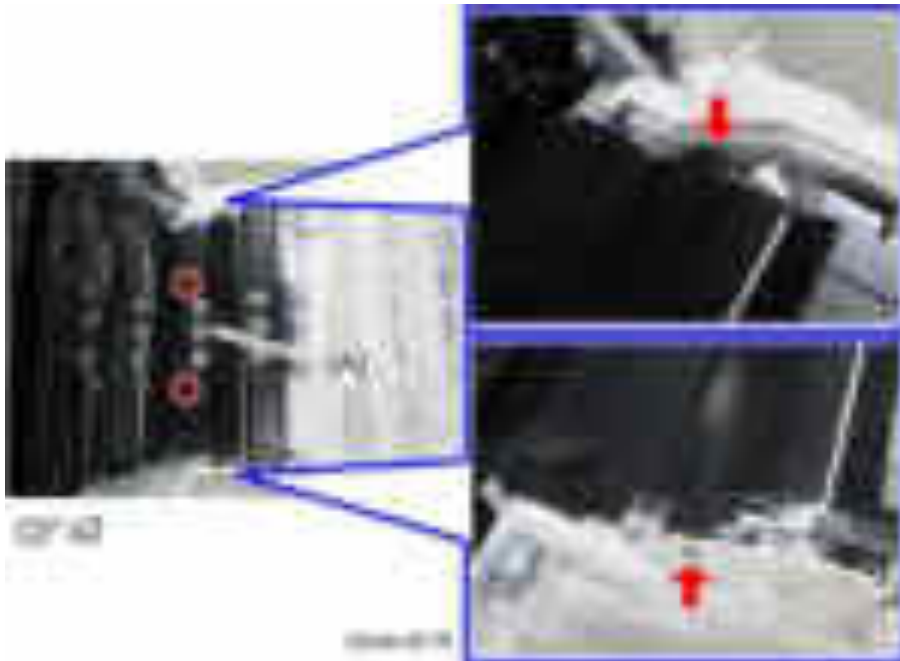

- 5.** Remove the harness.



- 6.** Release the tab and loosen the harness bracket [A].



- 7.** Remove the Bypass tray [A].



4.Replacement and Adjustment



- When attaching the bypass tray, pass the harness through the indicated position as shown.



Bypass Paper End Sensor (S6)

1. Open the bypass tray [A].



2. Remove the bypass paper end sensor cover [A].



- 3.** Remove the bypass paper end sensor unit [A].



- 4.** Remove the bypass paper end sensor (S6) [A].

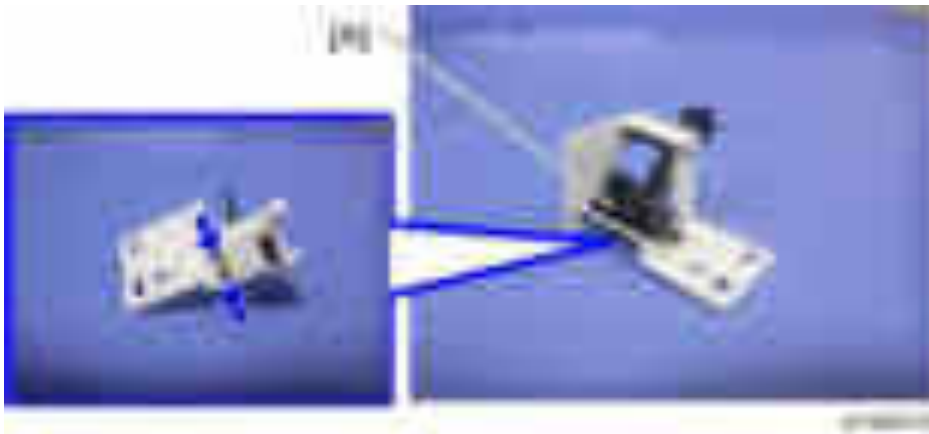

Bypass Pick-up Roller

- 1.** Open the bypass tray. ([Bypass Tray](#))
- 2.** Remove the bypass pick-up roller [A].

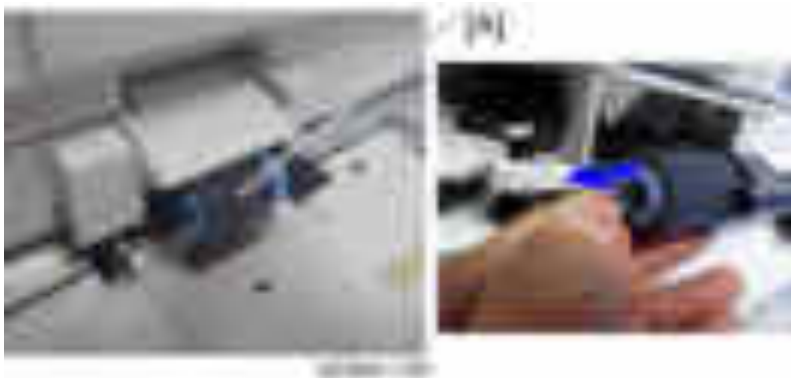

Bypass Paper Feed Roller

- 1.** Remove the bypass paper end sensor unit. ([Bypass Paper End Sensor \(S6\)](#))

4.Replacement and Adjustment

2. Remove the bypass paper feed roller [A].



Bypass Separation Roller/Torque Limiter

1. Remove the paper transport guide. ([Bypass Tray](#))
2. Remove the bypass separation roller [A].



3. Remove the torque limiter [A].



Bypass Width Sensor (S8)

1. Remove the bypass tray. ([Bypass Tray](#))

2. Remove the six screws on the bypass tray [A].



3. Release the hooks around the bypass tray [A].

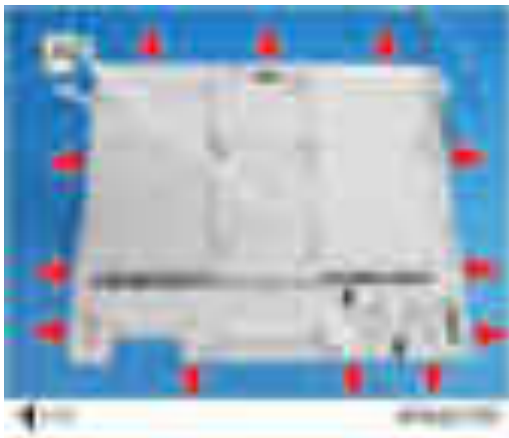

- There is a hook in the tray cover. Be careful not to damage it during removal or installation.



4.Replacement and Adjustment

4. Release the links.



5. Remove the bypass tray upper cover [A] (pin x 1, x1).

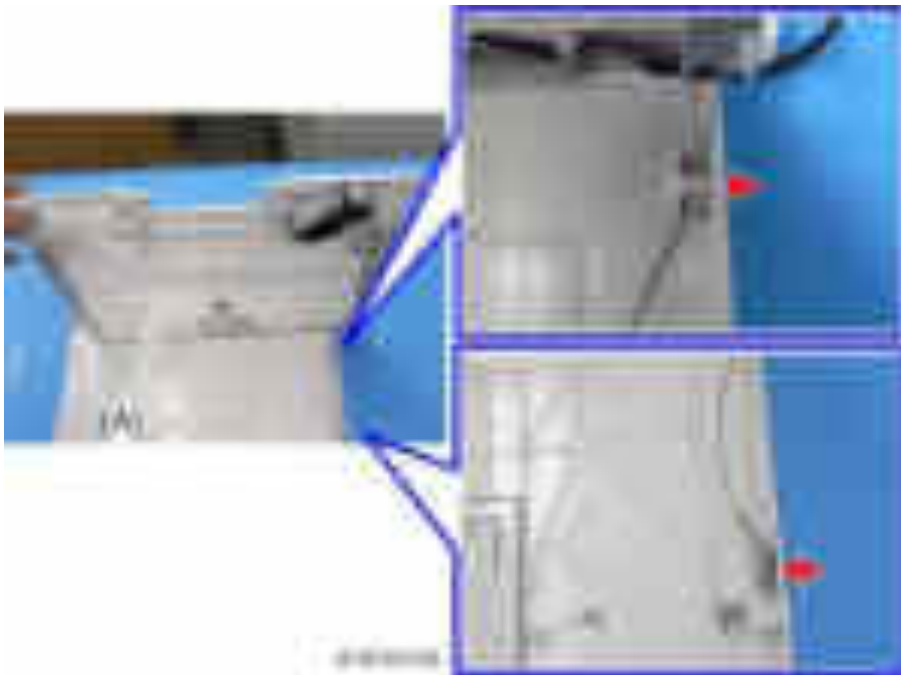

6. Remove the bypass width sensor (S8) [A] (x1, hook x2).





- When installing the bypass width sensor, the holes must align as shown below.



Bypass Length Sensor (S7)

- 1.** Remove the bypass tray. ([Bypass Tray](#))
- 2.** Remove the bypass tray upper cover. ([Bypass Width Sensor \(S8\)](#))
- 3.** Remove the bypass length sensor (S7) [A] ( ×1, hooks).



Bypass Table Calibration

- 1.** Attach the adjustment tool [A] to the bypass table, and then adjust the width of the side fences to that of the adjustment tool using the knobs at the front of the side fences.
Make sure there are no gaps between the side fences and the adjustment tool.



4.Replacement and Adjustment

- 2.** Execute SP1-008-032 [By-Pass Size Detection Adj: Main Scan Size Adj].
- 3.** Confirm that SP1-008-033 [By-Pass Size Detection Adj: Main Scan Size Adj Result (0:Fail 1:Succeed)] is "1:Succeed".

Bypass Pick-up Solenoid

- 1.** Remove the bypass/duplex motor. ([Bypass/Duplex Motor \(M2\)](#))
- 2.** Remove the transport guides [A] and [B].



- 3.** Remove the gears [A], [B], and [C].



- 4.** Remove the bearings [A], [B], and [C].

- 5.** Remove the 2 screws.



- 6.** Remove the two screws on the right side of the bypass paper feed unit [A].

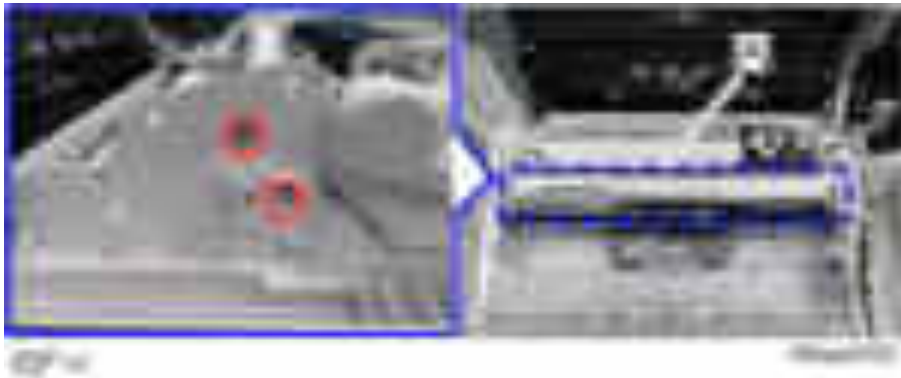

- 7.** Remove the screw and connector.



- 8.** Release the tab and loosen the harness bracket [A].



4.Replacement and Adjustment

9. Remove the bypass paper feed unit [A].



10. Remove the bypass paper end sensor cover [A].



11. Remove the connector of the bypass paper end sensor [A].



12. Remove the harness guide [A].



13. Remove the bypass pick-up solenoid [A] together with the bracket.

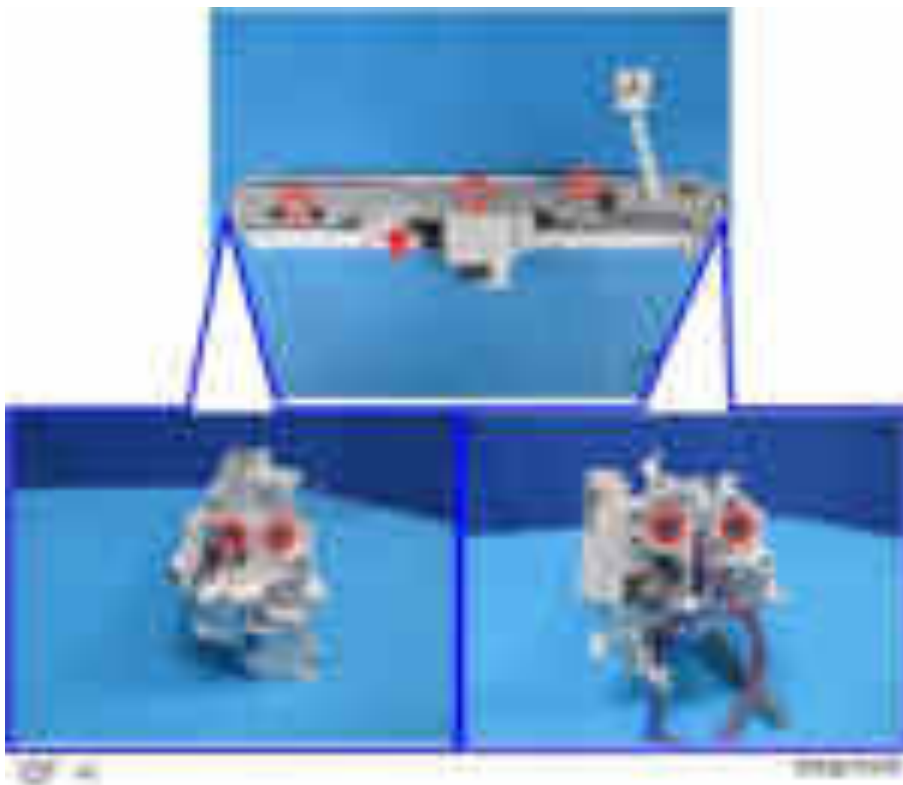

4.Replacement and Adjustment

14. Remove the 2 screws.



15. Remove the bypass pick-up solenoid [A].



Duplex Unit

Duplex Unit

1. Open the right door [A].



2. Remove the arms [A] [B].



3. Remove the right rear cover. ([Right Rear Cover](#))
4. Remove the main power switch cover. ([Main Power Switch Cover](#))

4.Replacement and Adjustment

- 5.** Remove the duplex unit [A].

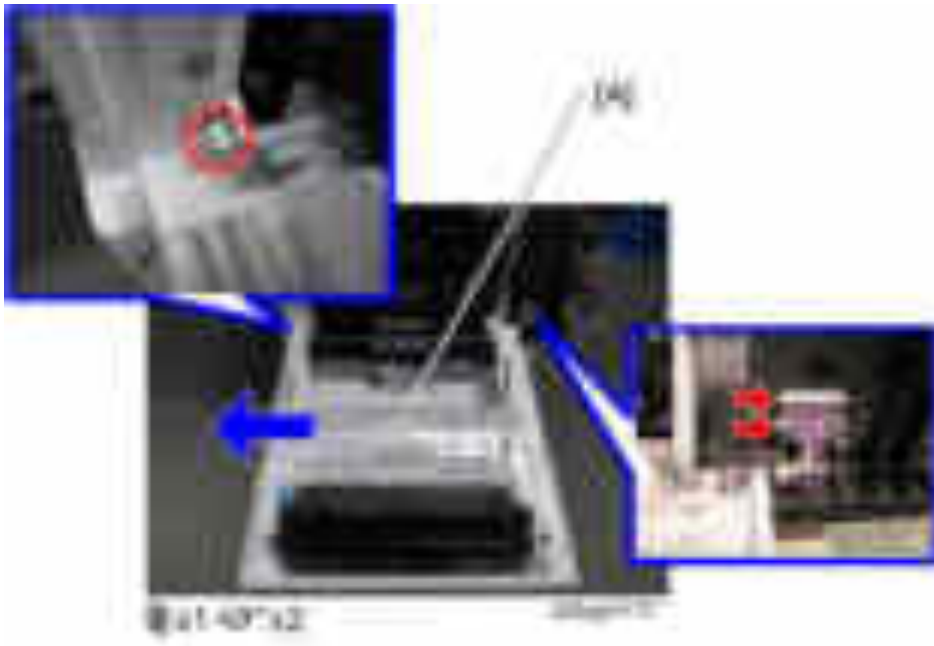

Bypass/Duplex Motor (M2)

- 1.** Remove the duplex unit. (Duplex Unit)
- 2.** Remove the harness guide [A].



- 3.** Remove the bypass/duplex motor unit [A].



- 4.** Remove the bypass/duplex motor (M2) [A].



Duplex Entrance Sensor (S5)

- 1.** Remove the transport guide [A]. (Tabx2)



- Make sure to release the tab on the right [C] first.
- When you reattach this part, make sure to attach it from the tab on the left [B] first.

4.Replacement and Adjustment

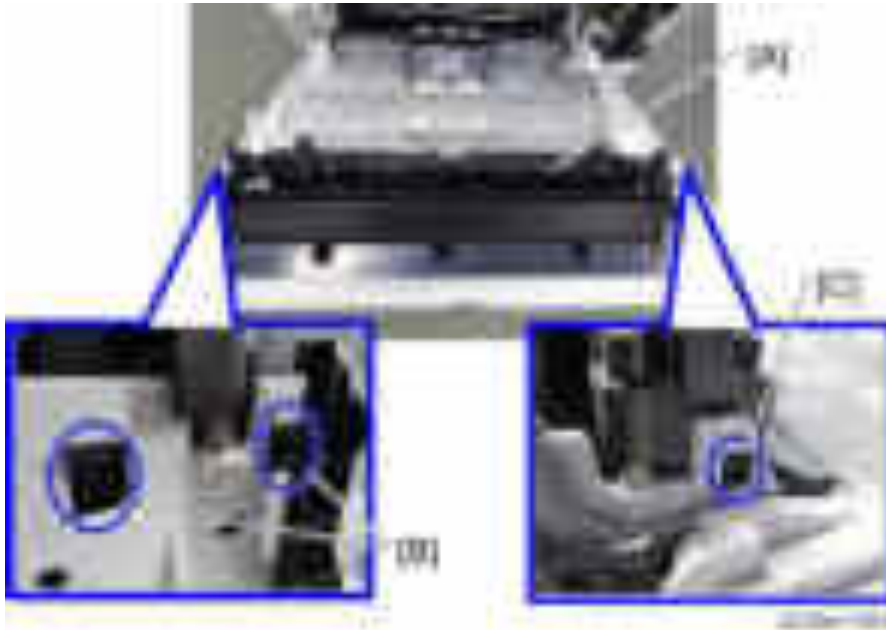

2. Remove the duplex entrance unit [A].

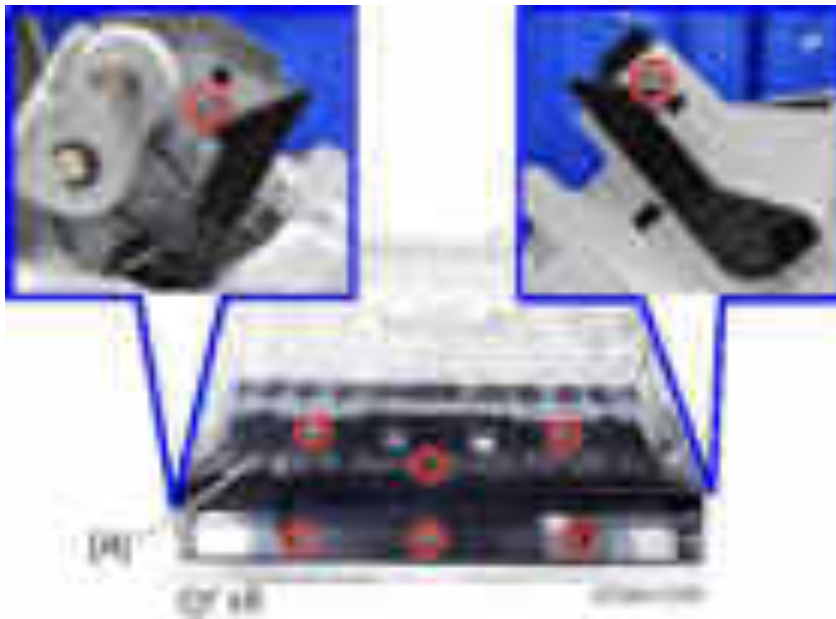

3. Remove the duplex entrance sensor unit [A].

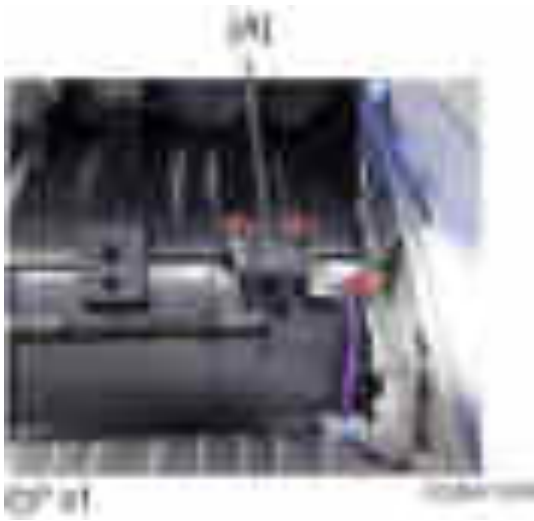

Duplex Exit Sensor (S3)

1. Remove the duplex unit. ([Duplex Unit](#))
2. Remove the duplex exit sensor unit [A].



3. Remove the duplex exit sensor (S3) [A].



4.Replacement and Adjustment

Duplex Guide Plate Open/Close Sensor (S4)

- 1.** Open the right door, and then remove the arms. (Duplex Unit)
- 2.** Remove the duplex guide plate open/close sensor cover [A] .



- 3.** Remove the duplex guide plate open/close sensor (S4) [A] .



Electrical Components

CAUTION

- Before doing any work, touch a metal object to discharge static electricity from the body. There is a possibility that the electrical components may malfunction due to static electricity.
- When disconnecting the FFC, release the lock.
- [A]: Disconnect the scanner FFC for the BICU while pressing the lock release button.
- [B]: Disconnect the other FFC while pressing the lock release levers on its sides.

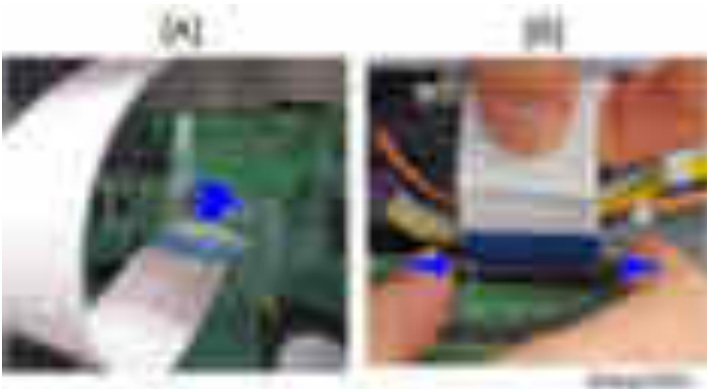

Overview

Printed Circuits/Parts inside the Controller Box



[A]	BICU (PCB10)
[B]	Controller Box Cooling Fan (FAN4)
[C]	Controller Board (PCB11)
[D]	HDD (PCB12)

4.Replacement and Adjustment

Printed Circuits behind the Controller Box

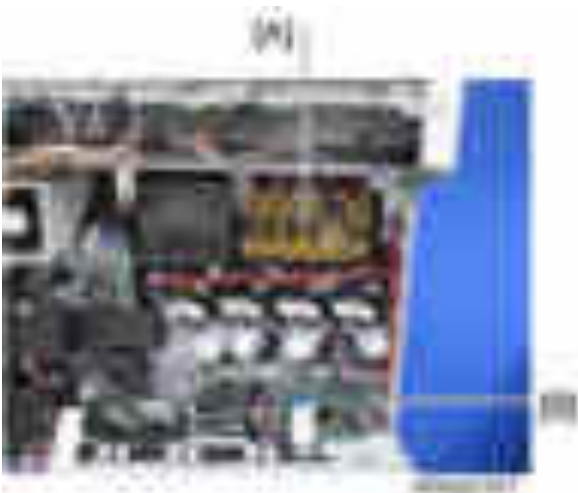

[A]	HVP-TTS (PCB16)
[B]	Imaging IOB (PCB2)

Printed Circuit/Parts inside the Power Box



[A]	PSU (AC controller board) (PCB9)
[B]	PSU (DC Power) (PCB8)
[C]	PSU Cooling Fan (FAN2)

Printed Circuits behind the Power Box

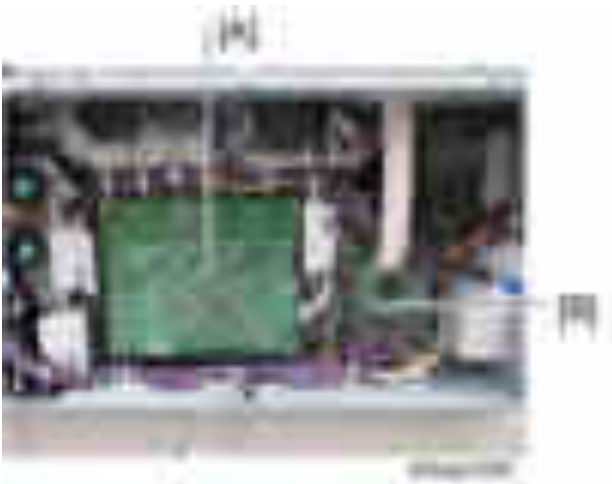

[A]	HVP-CB (PCB19)
[B]	Paper Transport IOB (PCB1)

Controller Box Cover

1. Remove the rear cover. ([Rear Cover](#))
2. Remove the controller box cover [A].

Red circles: Remove / Blue circles: Loosen



BICU (PCB10)

CAUTION

- The FFC connector has a lock mechanism. Do not use force to pull it out.

1. Remove the controller box cover. ([Controller Box Cover](#))
2. Remove the controller board (PCB11). ([Controller Board \(PCB11\)](#))
3. Remove the BICU (PCB10) [A].

Disconnect the upper FFC (scanner) while pressing the lock release button.

Disconnect the lower FFC while pressing the lock release levers on its sides.

4.Replacement and Adjustment

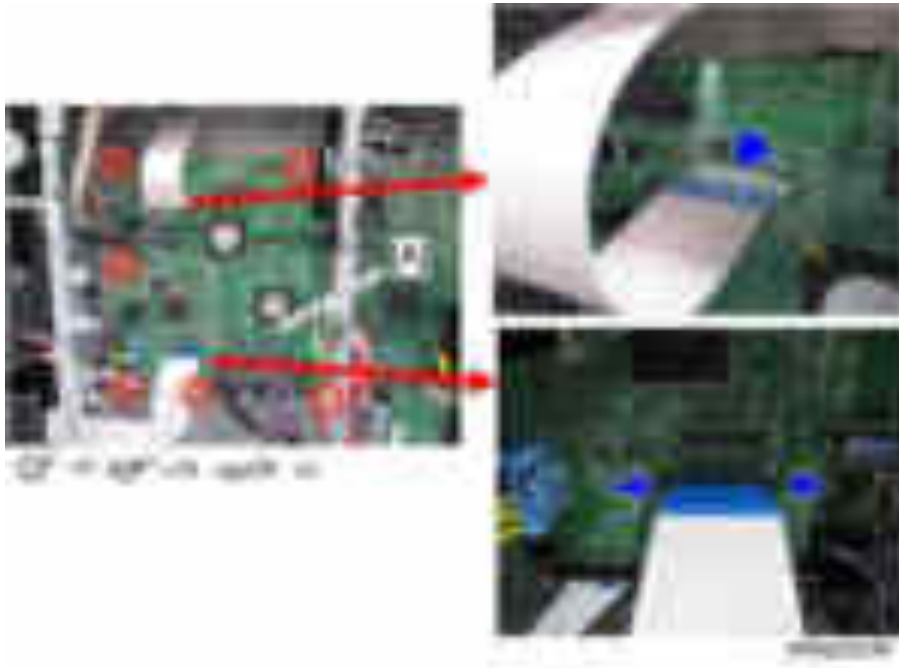

- When replacing the BICU, be sure to remove the EEPROM [A] from the old board and install it on the new board. By doing this, the SP and other settings can be carried across.



- Make sure the serial number is input in the machine for the NVRAM data with SP5-811-004, and then turn the main power off/on, if not, SC995-001 occurs.
- For information on how to configure this SP, contact the supervisor in your branch office.

Replacing the NVRAM (EEPROM) on the BICU

- 1.** Make sure that you have the SMC report (factory settings). This report comes with the machine.
- 2.** Output the SMC data ("ALL") using SP5-990-001/SP5-992-001.
Make sure to shut down and reboot the machine once before printing/exporting the SMC.
Otherwise, the latest settings may not be collected when the SMC is printed/exported.
- 3.** Turn OFF the main power switch.
- 4.** Insert a blank SD card in the SD slot #2, and then turn ON the main power switch.
- 5.** Use SP5-824-001 to upload the NVRAM data from the BICU.
- 6.** Turn off the main power switch and unplug the power cord.

7. Replace the NVRAM on the BICU with a new one.

8. Plug in, and then turn on the main power switch.



- When the power is turned ON, SC195-00 appears, but continue with the following steps.

9. Select the destination setting. (SP5-131-001) (JPN: 0, NA: 1, EU/AA/TWN/CHN: 2)

10. Set the following SP, Machine Serial Set (SP5-811-001), Area Selection (SP5-807-001), and CPM Set (SP5-882-001).



- For information on how to configure this SP, contact the supervisor in your branch office.

11. Turn off the machine, and then turn it back on.

12. Use SP5-801-002 "Memory Clear Engine".



- After changing the EEPROM, Some SPs do not have appropriate initial values. Because of this, steps 10 to 12 are done.

13. Turn off the machine, and then turn it back on.

14. From the SD card where you saved the NV-RAM data in step 5, download the NV-RAM data (SP5-825-001).

15. Turn off the machine, and then remove the SD card from slot #2.

16. Turn on the main power switch.

17. Check the factory setting sheet and the SMC data printout from step 2, and set the user tool and SP settings so they are the same as before.

18. Do ACC (Copier function and Printer function).

SP descriptions

- **SP5-131-001 (Paper Size Type Selection)**
Sets the region setting for paper size/type.
(0: Japan, 1: NA, 2: EU/AA/TWN/CHN)
- **SP5-811-001 (MachineSerial)**
Displays machine serial number.
- **SP5-807-001 (Area Selection)**
Sets the machine destination.
(1: Japan, 2: NA, 3: EU, 4: Taiwan, 5: Asia, 6: China, 7: Korea)
- **SP5-801-002 (Memory Clear: Engine)**
Clears non-volatile memory of engine.
- **SP5-824-001 (NV-RAM Data Upload)**
Uploads the NVRAM data to an SD card.
- **SP5-825-001 (NV-RAM Data Download)**
Downloads data from an SD card to the NVRAM in the machine.

4.Replacement and Adjustment

Controller Board (PCB11)



- Keep NVRAM away from any objects that can cause static electricity. Static electricity can damage NVRAM data.

- 1.** Remove the controller box cover. ([Controller Box Cover](#))
- 2.** Remove the controller bracket [A].



- 3.** Remove the controller board (PCB11) [A].



- 4.** Release the upper and lower locks and remove DIMM [A].



- 5.** Remove the used NVRAM [A] from the old controller board and install them on the new controller

board.

CAUTION

- Make sure that the NVRAM is placed at the right position and orientation when attaching to the new board.
- Incorrect installation of the NVRAM will damage both the controller board and NVRAM.



- When replacing the controller board (PCB11), first check if the SDK applications have been installed. After replacing the controller board, re-install the SDK applications by following the installation instructions for each application.
- After reinstalling the SDK applications, print the SMC (SP-5-990-024/025 (SMC: SDK/Application Info)). Then open the proximity sensor cover. Store the SMC sheet and the SD card(s) that was used to install the SDK application(s).

Replacing the NVRAM on the Controller Board

CAUTION

- Referring to the following procedure, be sure that there are no mistakes in the mounting position and orientation of the NVRAM.
Incorrect installation of the NVRAM will damage both the controller board and NVRAM.
- SC195 (Machine serial number error) will be displayed if you forget to attach the NVRAM.
- Passwords for the Supervisor and Administrator 1 will be discarded later in this procedure.
- The new NVRAM initializes SPs and issues an SC. Reset the SC with the procedure below.

Mounting position and orientation of the NVRAM

4.Replacement and Adjustment



- 1.** Make sure that you have the SMC report (factory settings). This report comes with the machine.
- 2.** Output all the SMC data using SP5-990-001 (SP Print Mode: All (Data List)), or download the SMC data to an SD card using SP5-992-001 (SP Text mode: ALL (Data List))
Make sure to shut down and reboot the machine once before printing/exporting the SMC.
Otherwise, the latest settings may not be collected when the SMC is printed/exported.
- 3.** Turn the main power switch OFF.
- 4.** Insert an SD card into Slot 2 and turn the main power switch ON.
- 5.** Upload the NV-RAM data on the controller board to the SD card using SP5-824-001 (NV-RAM Data Upload).
- 6.** Make sure that the customer has backed up their Address Book data. If they have not, save the Address Book data to an SD card using SP5-846-051 (Backup All Addr Book).



- The address data stored in the machine will be discarded later during this procedure. So be sure to obtain a backup of the customer's address book data.
 - Note that the counters for the user will be reset when doing the backup/restore of the address book data.
 - If they have a backup of the address book data, use their own backup data for restoring. This is because there is a risk that the data cannot be backed up properly depending on the NV-RAM condition.
- 7.** Do the following steps if the machine has the fax unit. If not, skip this step:
 1. Print the Box List with the Settings.
 - [Settings] - [Facsimile Settings] - [General Settings] - [Box Setting: Print List]
 2. Print the Special Sender List by pressing these buttons in the following order.
 - [Settings] - [Facsimile Settings] - [Reception Settings] - [Program Special Sender: Print List]
 3. Write down the following fax settings.
 - [Receiver] in [Settings] - [Facsimile Settings] - [Reception Settings] - [Reception File

Settings] - [Forwarding].

- [Notify Destination] in [Settings] - [Facsimile Settings] - [Reception Settings] - [Reception File Settings] - [Store].
- [Specify User] in [Settings] - [Facsimile Settings] - [Reception Settings] - [Stored Reception File User Setting].
- [Notify Destination] in [Settings] - [Facsimile Settings] - [Reception Settings] - [Folder Transfer Result Report].
- Specified folder in [Settings] - [Facsimile Settings] - [Send Settings] - [Backup File TX Setting].
- [Receiver] in [Settings] - [Facsimile Settings] - [Reception Settings] - [Reception File Settings] - [Output Mode Switch Timer].
- [Store: Notify Destination] in [Settings] - [Facsimile Settings] - [Reception Settings] - [Output Mode Switch Timer].
- All the destination information shown on the display.



- In the fax settings, address book data is stored with entry IDs, which the system internally assigns to each data. The entry IDs may be changed due to re-assigning in backup/restore operations.

4. Make sure that there is no transmission standby file. If any standby file exists, ask the customer to delete it or complete the transmission.

8. Turn the power OFF and unplug the power supply cord.

9. Push the power switch ON again to discharge the residual charge.

10. Replace the NV-RAM with a brand-new one.

11. Turn the power ON with the SD card to which the NV-RAM data has been uploaded in Slot 2.



- SC673 appears at start-up, but this is normal behavior. This is because the controller and the smart operation panel cannot communicate with each other due to changing the SP settings for the operation panel.

12. Change the SP settings for the operation panel.

If you switch the screen to enter the SP mode, SC995-02 is displayed. However, continue the following steps.

- SP5-748-101: (OpePanel Setting: Op Type Action Setting): Change bit 0 from 0 to 1.
- SP5-748-201: (OpePanel Setting: Cheetah Panel Connect Setting): Change the value from 0 to 1.

13. Change the Flair API SP values.

- SP5-752-001 (Copy FlairAPIFunction Setting): Change bit 0 from 0 to 1.
- SP1-041-001 (Scan:FlairAPI Setting): Change bit 0 from 0 to 1.
- SP3-301-001 (FAX:FlairAPI Setting) Change bit 0 from 0 to 1.

4.Replacement and Adjustment

14. Cycle the power OFF/ON.



- The model information is written on the NVRAM (Novita), so SC995-02 does not occur.
- Program/Change Administrator will be displayed in Japanese, but this is normal.

15. Enter the SP mode and specify the following settings manually.

- **a. SP5-985-001 (Device Setting: On Board NIC)** Change the value from 0 to 1.
- **b. SP5-985-002 (Device Setting: On Board USB)** Change the value from 0 to 1.

16. Turn OFF the main power, and then turn ON the main power with the SD card to which the NV-RAM data has been uploaded in Slot 2.

17. Download the NV-RAM data stored in the SD card to the brand-new NV-RAM using SP5-825-001 (NV-RAM Data Download).



- The download will take a couple of minutes.

18. Turn the power OFF and remove the SD card from slot 2.

19. Turn the power ON.

The screen "Program/Change Administrator" will be displayed in the language that is the same language as the time when the data was uploaded to the SD card in step 5.

20. Execute SP5-755-002 (Hide Administrator Password Change Scrn).

After you execute this SP and exit SP mode, the Home screen is displayed and user functions can be used.

21. If the security functions (e.g. Stored file encryption/ Auto Erase Memory Setting) were applied, set the functions again.

22. Ask the customer to restore their address book. Or restore the address book data using SP5-846-052 (UCS Setting: Restore All Addr Book), and ask the customer to ensure the address book data has been restored properly.



- If you obtained the backup of the customer's address book data in step 3, delete the backup immediately after the NV-RAM replacement to avoid accidentally taking out the customer's data.

23. Output all the SMC data with SP5-990-001 and make sure all the SP/UP settings except for counter information are properly restored, by checking the SMC data obtained in step 2.



- The counters will be reset.

24. When equipped with fax, make sure that the list printed in steps 7-1 to 7-2 are the same as the sender information that you wrote down in step 7-3.

If the setting is different from the original setting after the replacement of the NVRAM, then set it again to the original setting.

25. Execute the process control (SP3-011-001).

26. Execute the ACC (Copy).

27. Execute the ACC (Printer).

28. Cycle the power OFF/ON.



- If you cannot execute SP5-824-001 or SP5-825-001 for some reason, try all the following things.
 - Check the changed SP value on the SMC which was output in step 2 and set it manually. Especially, ensure that the values of the following SPs are same as the setting before the replacement.
 - a. SP5-045-001 (Accounting counter: Counter Method)
 - b. SP5-302-002 (Set Time: Time Difference)
- Because the PM counters have been reset during NV-RAM replacement, it is necessary to replace all the PM parts for proper PM management.



- If a message tells you need a SD card to restore displays after the NV-RAM replacement, create a "SD card for restoration" and restore with the SD card.

SP descriptions

- **5-846-051 (UCS Setting: Backup All Addr Book)**
Uploads all directory information to the SD card.
- **SP5-748-201 (OpePanel Setting: Cheetah Panel Connect Setting)**
0: OFF
1: ON
- **SP5-752-001 (Copy: FlairAPIFunction Setting)**
Sets Copy FlairAPI Function enable / disable.
- **SP1-041-001 (Scan: FlairAPI Setting)**
Sets Scanner FlairAPI Function enable / disable.
- **SP3-301-001 (FAX: FlairAPI Setting)**
Sets Fax FlairAPI Function enable / disable.

Bit Switches for FlairAPI Settings

Bit	Item	0	1	Description	Initial value
0	Flair API Server Boot	Disabled	Enabled	Specifies whether to start the HTTP server for Flair API. "0" disables all the Flair API functions (Remote UI).	0
1	Access Permission	Enabled	Disabled	Setting this value to "0" permits only internal access in the machine (MFP browser). Setting this value to "1" permits to access from external devices such as PC, Remote UI, IT-	0

4.Replacement and Adjustment

Bit	Item	0	1	Description	Initial value
				BOX.	
2	Select IPv6/IPv4	IPv6	IPv4	Setting this value to "0" permits only accessing with IPv6. Setting this value to "1" permits accessing with IPv4 or IPv6.	0
3	Remote UI	Not use	Use	Sets whether to use the Remote UI.	0
4	Reserved	-	-	N/A	N/A
5	Reserved	-	-	N/A	N/A
6	Reserved	-	-	N/A	N/A
7	Reserved	-	-	N/A	N/A

- SP5-985-001/002 (Device Setting: On Board NIC/On Board USB)**
 The NIC and USB support features are built into the GW controller. Use this SP to enable and disable these features. In order to use the NIC and USB functions built into the controller board, these SP codes must be set to "1".
- SP5-824-001 (NV-RAM Data Upload)**
 Uploads the NVRAM data to an SD card.
- SP5-825-001 (NV-RAM Data Download)**
 Downloads data from an SD card to the NVRAM in the machine.
- SP5-755-002 (Hide Administrator Password Change Scrn)
 Hides the input screen of the administrator password temporarily.
- SP5-193-001 (External Controller Info. Settings)
 Sets the model of the external controller connected to the main unit.
 0: External Controller is not installed
 1: EFI
 2: Ratio
 3: Egret
 4: GJ
 5: Creo
 6: QX-100
 7: Kurofune
 8 to 10: Reserved
- SP5-846-052 (UCS Setting: Restore All Addr Book)**
 Downloads all directory information from the SD card.
- SP5-045-001 (Accounting counter: Counter Method)**
 Sets the counter methods as follows; Developments, Prints or Coverage.
- SP5-302-002 (Set Time: Time Difference)**
 Adjusts the RTC (real time clock) time setting for the local time zone.

Examples: For Japan (+9 GMT), enter 540 (9 hours x 60 min.)

Japan: +540 (Tokyo)

NA: -300 (New York)

EU: + 60 (Paris)

CHN: +480 (Beijing)

TWN: +480 (Taipei)

AA: +480 (Hong Kong)

KO: +540 (Korea)

HDD (PCB12)



- Before replacing the HDD (PCB12), copy the address book data to an SD card with SP5846-051 (Backup All Addr Book) if possible.
- If the customer is using the Data Overwrite Security, the Data Encryption feature or OCR Scanned PDF, these applications must be installed again.

1. Remove the controller box cover. ([Controller Box Cover](#))
2. Remove the HDD (PCB12) [A].



Adjustment after Replacement

1. Run SP5-832-001, to initialize the hard disk.
Even if you use an HDD that is already formatted, it is recommended that you re-initialize.
2. Run SP5-853-001, to install the fixed stamps.
3. Run SP5-846-052, to copy the address book from the SD card to the HDD.
4. Turn off the machine, and then turn it back on.

SP descriptions

- **SP5-832-001 (HDD Formatting: HDD Formatting (ALL))**
Initializes the hard disk.
- **SP5-853-001 (Stamp Date Download)**
Downloads the fixed stamp data from the machine ROM onto the hard disk. Then these stamps

4.Replacement and Adjustment

can be used by the Settings menu. If this is not done, the user will not have access to the fixed stamps ("Confidential", "Secret", etc.).

You must always execute this SP after replacing the HDD or after formatting the HDD.

- **SP5-846-052 (UCS Setting: Restore All Addr Book)**

Downloads all directory information from the SD card.

Controller Box

1. Remove the controller box cover. ([Controller Box Cover](#))

2. Remove the bracket [A].



3. Remove the controller box [A].

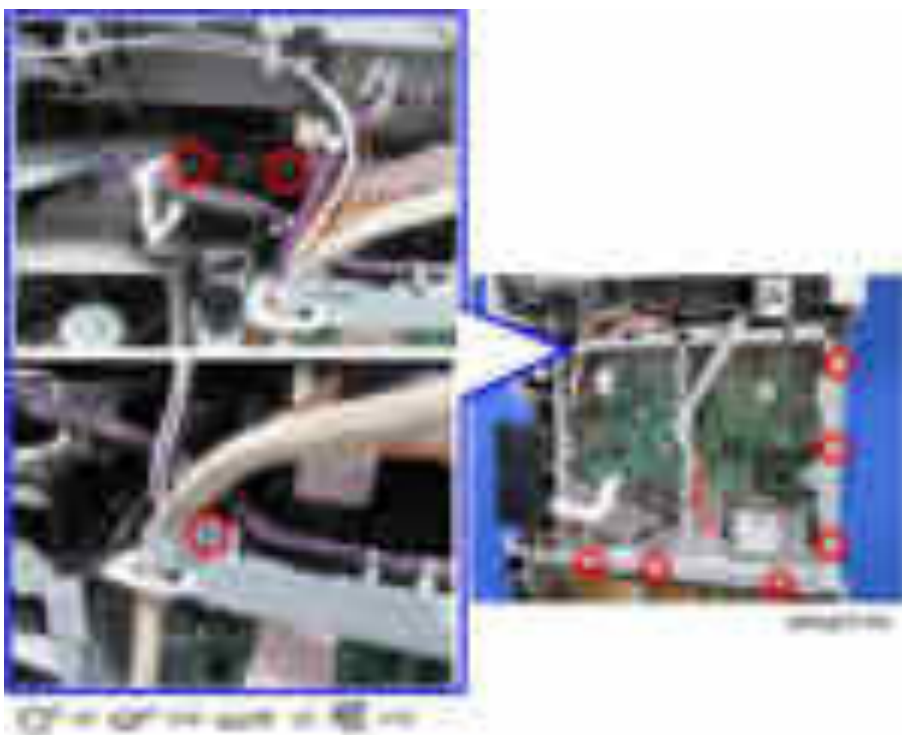

Imaging IOB (PCB2)

1. Remove the controller box cover. ([Controller Box Cover](#))

- 2.** Disconnect the FFC between BICU-Scanner Unit.



Pull out FFC [A] while pressing the lock release lever.



- 3.** Open the controller box [A].



- 4.** Remove the imaging IOB (PCB2) [A].

Disconnect the FFC while pressing the lock release levers on its sides. Disconnecting the FFC without releasing the lock may cause the FFC or connector to be damaged, resulting in an SC670 error.



4.Replacement and Adjustment

HVP-TTS (PCB16)

- 1.** Remove the controller box cover. ([Controller Box Cover](#))
- 2.** Open the controller box [A].



- 3.** Remove the HVP-TTS (PCB16) [A].



PSU (AC Controller Board) (PCB9)

CAUTION

- Turn off the main power switch and unplug the power cord before replacing the PSU.
- Do not touch the areas outlined in red in the following diagrams when replacing the PSU.

Residual charge on the board may cause electric shock.



1. Remove the rear lower cover. ([Rear Lower Cover](#))
2. PSU (AC Controller Board) (PCB9) [A].







PSU (DC Power)

CAUTION

- Turn OFF the main power switch and unplug the power cord before replacing the PSU.
- Do not touch the areas outlined in red in the following diagrams when replacing the PSU.
Residual charge on the board may cause electric shock.

4.Replacement and Adjustment

	100V	200V
IM C3500/C3000/C2500/C2000		
IM C6000/C5500/C4500		

- 1.** Remove the Rear lower cover. ([Rear Lower Cover](#))
- 2.** Remove the PSU (DC Power) (PCB8) [A].



Power Supply Box

1. Remove the rear lower cover. ([Rear Lower Cover](#))
2. Remove the power supply box [A].



- You can hang the power box [A] on the machine by using 3 tabs.

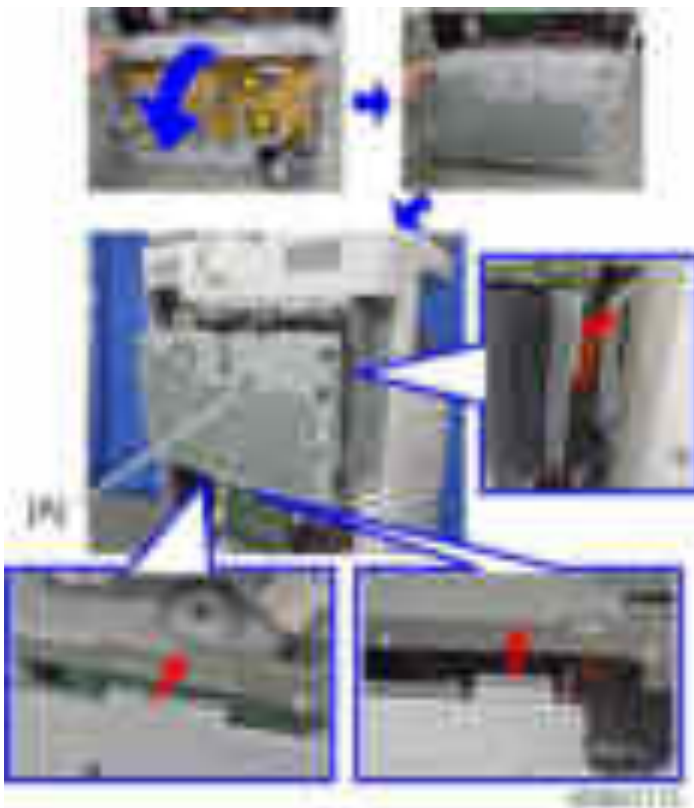

4.Replacement and Adjustment

Paper Transport IOB (PCB1)

1. Remove the power supply box. (Power Supply Box)



- You can hang the power box [A] on the machine by using 3 tabs.

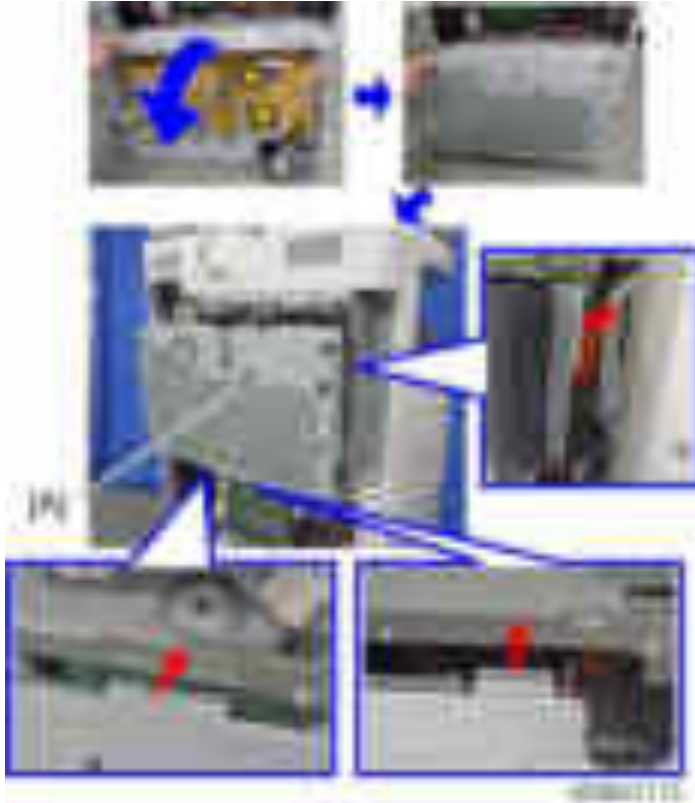

2. Remove the paper transport IOB (PCB1) [A].



HVP-CB (PCB19)

1. Remove the power supply box. (Power Supply Box)

- 2.** Remove the HVP-CB (PCB19) [A].



HVP-CB with Bracket

- 1.** Release the 5 clamps.



4.Replacement and Adjustment

2. Remove the HVP-CB with bracket [A]. (Tab x2)

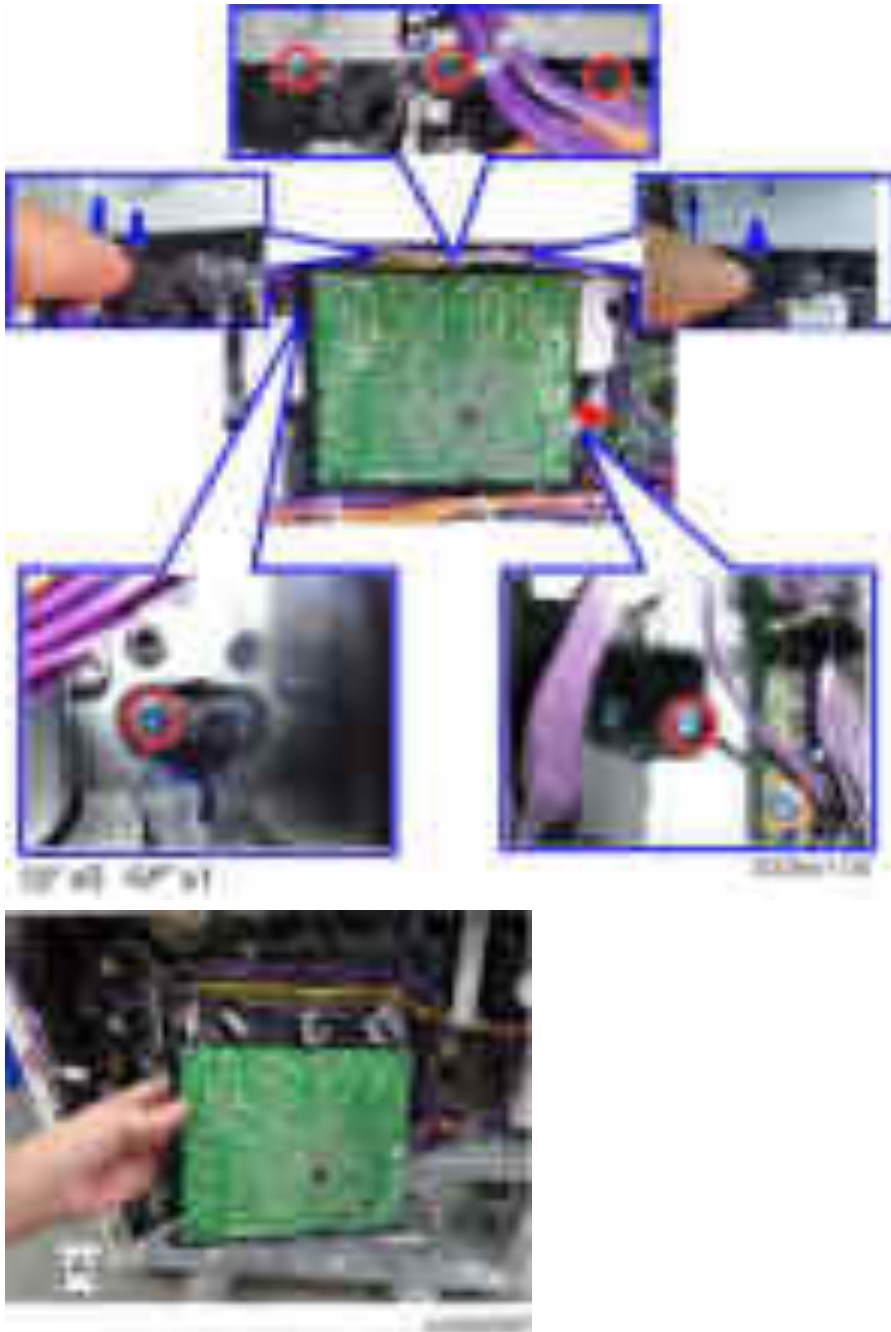

Proximity Sensor Board (PCB18)

1. Remove the proximity sensor cover. ([Proximity Sensor Cover](#))

2. Remove the proximity sensor board (PCB18) [A].

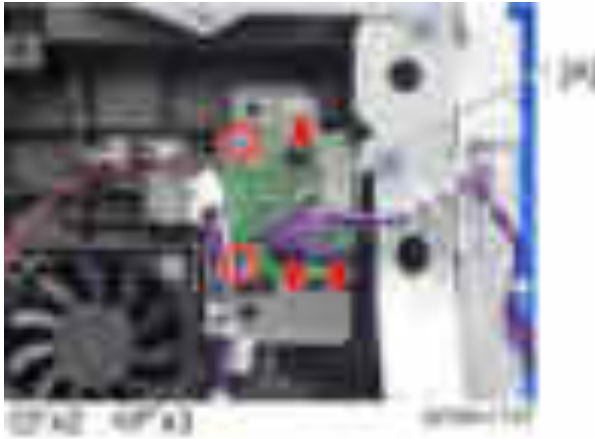

Fans/Filters

Exhaust Filter

Adjustment before Replacing the Exhaust Filter

Before replacing the exhaust filter, set SP3-701-131 (Manual New Unit Set: Dust Filter) to "1" and switch the power OFF. Then replace the exhaust filter and switch the power ON.

Replacement

1. Remove the exhaust filter [A].



- The structure of service parts of Exhaust Filter may be different from the Filter originally installed.

Deodorization Filter

1. Remove the deodorization filter box [A].



2. Remove the deodorization filter [A].

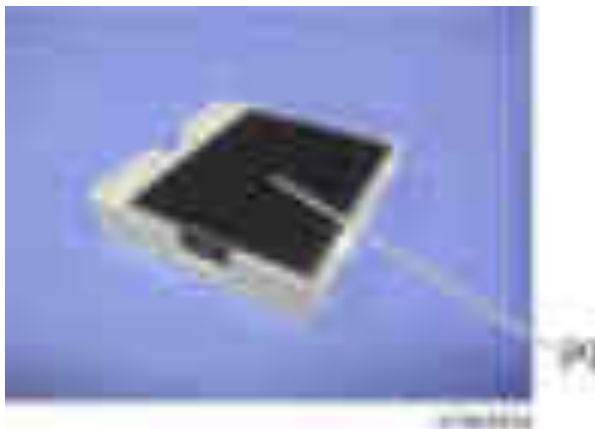

Development Intake Fan (FAN6)

1. Remove the inner lower cover ([Inner Lower Cover](#)).

4.Replacement and Adjustment

2. Remove the development intake fan unit [A].



3. Remove the development intake fan (FAN6) [A].



Ozone Exhaust Fan (FAN3)

1. Remove the power supply box. ([Paper Transport IOB \(PCB1\)](#))

- 2.** Remove the screws and connector inside the ozone exhaust fan unit [A].



- 3.** Remove the clamps.



4.Replacement and Adjustment

- 4.** Remove the ozone exhaust fan unit [A].



- 5.** Remove the exhaust duct [A].



- 6.** Remove the duct cover [A].

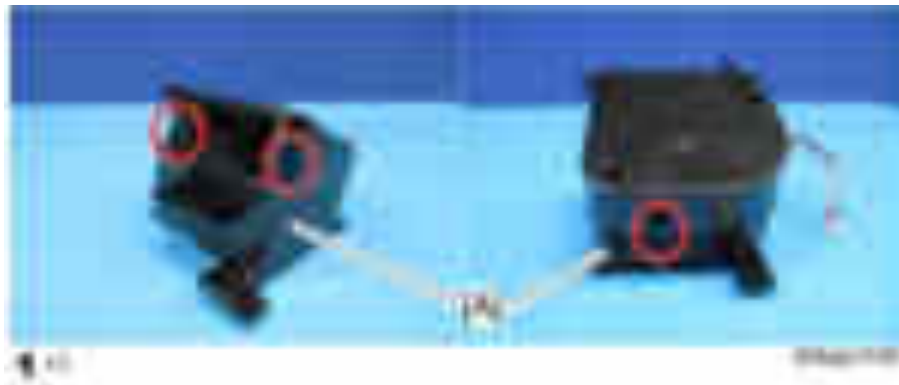

7. Remove the ozone exhaust fan (FAN3) [A].



Paper Exit Cooling Fan (FAN7)

1. Remove the proximity sensor cover. ([Proximity Sensor Cover](#))
2. Remove the paper exit cooling fan (FAN7) [A].



Fusing Exhaust Fan (FAN1)

1. Remove the rear cover. ([Rear Cover](#))
2. Remove the right rear cover. ([Right Rear Cover](#))
3. Remove the fusing exhaust fan unit [A].



4.Replacement and Adjustment

- 4.** Remove the fusing exhaust fan (FAN1) [A].



Drive Cooling Fan (FAN9) (IM C6000/C5500/C4500 Only)

- 1.** Remove the rear cover. ([Rear Cover](#))
- 2.** Remove the right rear cover. ([Right Rear Cover](#))
- 3.** Remove the drive cooling fan unit [A].

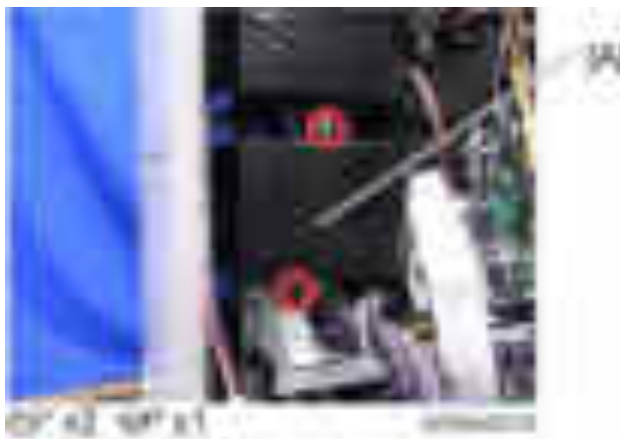

- 4.** Remove the drive cooling fan (FAN9) [A].



Main Exhaust Fan (FAN8) (IM C6000/C5500/C4500 Only)

- 1.** Remove the rear cover. ([Rear Cover](#))

2. Remove the main exhaust fan unit [A].

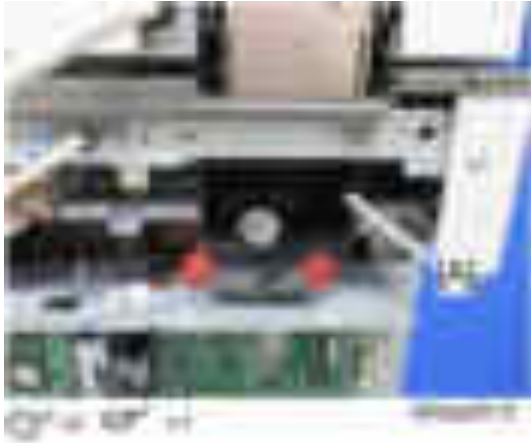

3. Remove the main exhaust fan (FAN8) [A].

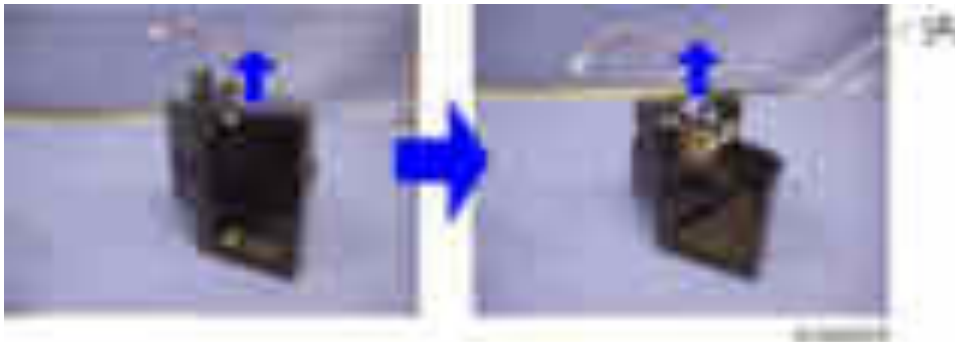

Toner Supply Cooling Fan (FAN5)

1. Remove the rear cover. ([Rear Cover](#))
2. Remove the right rear cover. ([Right Rear Cover](#))
3. Remove the drive cooling fan (FAN9). (Only for IM C6000/C5500/C4500) ([Drive Cooling Fan \(FAN9\) \(IM C6000/C5500/C4500 Only\)](#))
4. Remove the toner supply cooling fan unit [A].



4.Replacement and Adjustment

- 5.** Remove the Toner supply cooling fan (FAN5) [A].

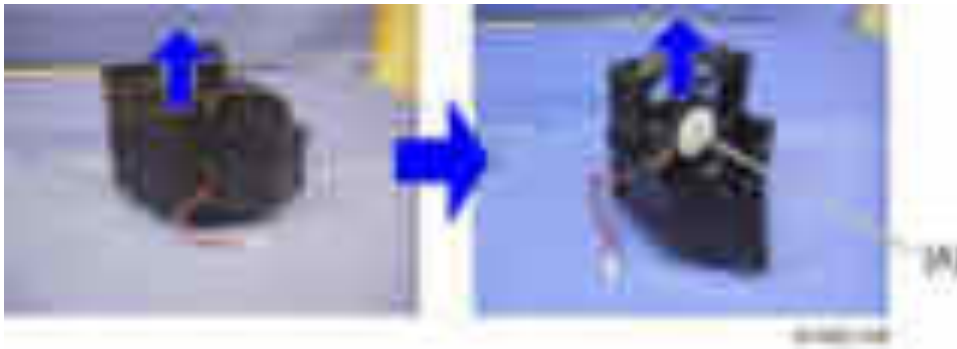

PSU Cooling Fan (FAN2)

- 1.** Remove the rear lower cover. ([Rear Lower Cover](#))
- 2.** Remove the PSU cooling fan unit [A].



- 3.** Remove the PSU cooling fan (FAN2) [A].

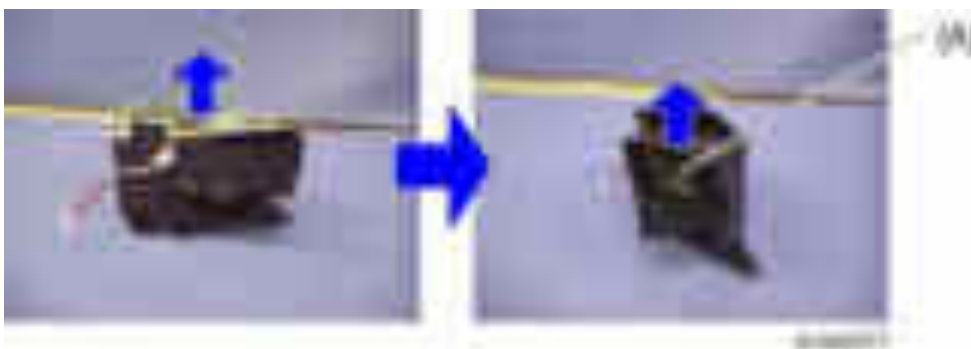

Controller Box Cooling Fan (FAN4)

- 1.** Remove the controller box cover. ([Controller Box Cover](#))

2. Remove the controller box cooling fan (FAN4) [A].



Image Adjustment

Auto Color Calibration

For the best image quality, this is done during installation and should be done periodically by the customer. It is accessed with the "Settings" as follows.

Settings -> Machine Features Settings -> Maintenance -> Auto Color Calibration



- When you set the adjustment sheet on the exposure glass, put about 10 pieces of white paper on the adjustment sheet in order for the original to contact the exposure glass sufficiently. Instruct the customer to periodically execute the ACC.



	Description
[A]	Output adjustment sheets. You must execute both for copy and printer functions.
[B]	Roll back to the previous value.
[C]	Displays the last date/time ACC was executed.

About the printer ACC

It is difficult to keep constant printing density due to the environment of the machine, individual differences between devices, and the passage of time. The printer ACC reads the current printing density using the scanner, and then compares the result with the time when it was in a normal state, and makes the printing density close to the normal state.

Issues possibly solved by the printer ACC

- When the printed image looks strongly red, blue, or yellow because the density of the cyan,

magenta, and yellow are not balanced.



- When the printed image looks too dark or light.



Issues cannot be solved by the printer ACC

The tone differences from other types of machine or machines of other manufacturers cannot be solved by the printer ACC. The tone differences from the machines of other manufactures occur due to the differences in color reproduction caused by the difference in the engine and color profile specifications so it may not be solved even after performing the printer ACC.

Refer to "[Adjustment by Changing the Machine's Profile Setting](#)" for the color tone differences from the other types of the machine.

Adjusting the Tone of the Printed Image

If a customer wishes to have the tone of the printed image corrected, you can adjust it as follows.

For details about the adjustment procedures, see the corresponding sections.

Adjustment Method	Outline
Adjustment by Changing the Printer Driver Setting (Adjustment by Changing the Printer Driver Setting)	Perform this to adjust the tone for each print job. This can be adjusted by the user.
Adjustment by Changing the Machine's Profile Setting (Adjustment by Changing the Machine's Profile Setting)	Perform this to make the tone similar to that of another model. Doing this changes the tone of all images printed by the machine's printer function.
Adjustment by Printer Gamma Correction	Basically, we recommend the default setting. Doing

4.Replacement and Adjustment

Adjustment Method	Outline
(Printer Gamma Correction)	this changes the tone of all images printed by the machine's printer function.

Adjustment by Changing the Printer Driver Setting

Using the printer driver, you can change the color balance for each print job as follows.

- 1.** Open the printer driver's "Color Balance Details" window. ([Opening the Printer Driver's "Color Balance Details" Window](#))
- 2.** Adjust the tone (color gamut). ([Adjusting the Tone in the "Color Balance Details" Window](#))

Opening the Printer Driver's "Color Balance Details" Window

PCL6 driver / PS driver

- 1.** Click [Detailed Setting] tab -> [Print Quality].
- 2.** Click [Details...] in "Color Balance".

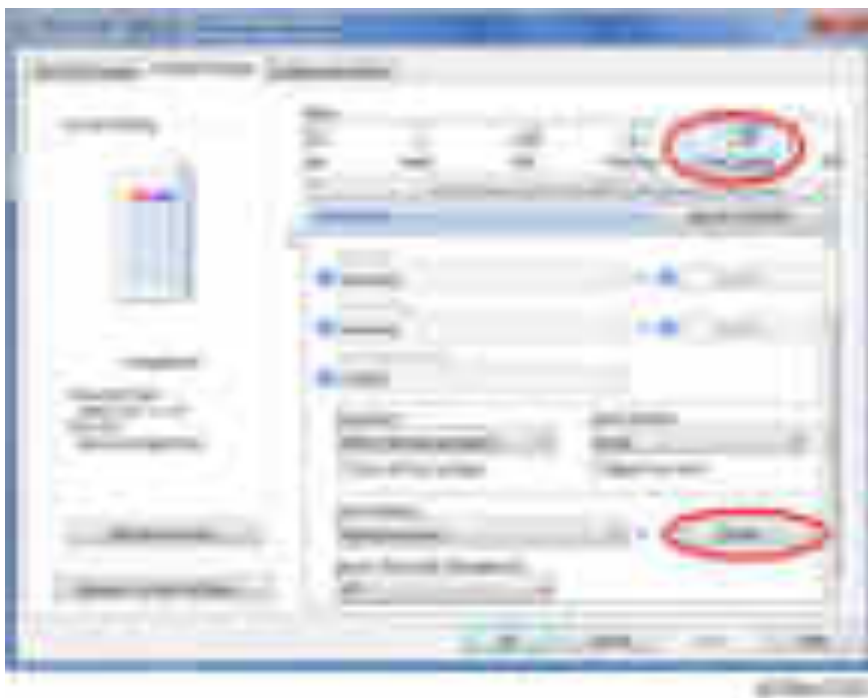

- 3.** "Color Balance Details" window appears. ([Color Balance Details Window](#))

PCL6 Universal driver / PS Universal driver

- 1.** Click [Detailed Setting] tab -> [Print Quality:Advanced].

2. Click [Details...] in "Color Balance".



3. "Color Balance Details" window appears. ([Color Balance Details Window](#))

Mac PS driver

1. On the print dialog box, open the context menu (right click menu), then select [Color Balance Details].



2. "Color Balance Details" window appears. ([Color Balance Details Window](#))

4.Replacement and Adjustment

Color Balance Details Window

RPCS/PCL6 driver



PS driver



Mac PS driver

Adjusting the Tone in the "Color Balance Details" Window

Brightness

- Decrease the value to make the printed image darker and increase it to make the printed image brighter.
- If you increase the value too much, overexposure of bright areas may occur.
- If you decrease the value too much, underexposure of dark areas may occur
- Can be specified using the RPCS/PCL/PS drivers.

**Contrast**

- Increasing the contrast makes bright areas brighter and dark areas darker.
- Decreasing the contrast makes bright areas darker and dark areas brighter.
- To make the printed image sharper, increase the value.
- To prevent white halation in bright parts and black crush in dark parts, decrease the value.
- If you increase the value too much, overexposure of bright areas and underexposure of dark areas may occur.
- If you decrease the value too much, the printed image may become unclear.
- Can be specified using the RPCS/PCL/PS drivers.

4.Replacement and Adjustment



Saturation

- Increasing the saturation makes the printed image more vivid.
- Decreasing the saturation makes the printed image blander.
- If you increase the value too much, it may lower the color gradient, resulting in a difficulty to distinguish colors.
- The printer's color gamut is limited, so even if you increase the value, it may not make any difference.
- Can be specified using the RPCS/PCL driver only.



RGB Adjustment (Adjust Each Color)

When using the RPCS/PCL driver, adjust the tone (color gamut) by this method.

- Increasing "Red" makes "M" and "Y" more vivid and "C" less so.
- Decreasing "Red" makes "M" and "Y" less vivid and "C" more so.
- Increasing "Green" makes "C" and "Y" more vivid and "M" less so.
- Decreasing "Green" makes "C" and "Y" less vivid and "M" more so.
- Increasing "Blue" makes "C" and "M" more vivid and "Y" less so.
- Decreasing "Blue" makes "C" and "M" less vivid and "Y" more so.



CMYK Adjustment (Adjust Each Color)

When using the PS driver, adjust the tone (color gamut) by this method.

- Increasing and decreasing the value in "Black" corresponds with "K".
- Increasing and decreasing the value in "Cyan" corresponds with "C".

4.Replacement and Adjustment

- Increasing and decreasing the value in "Magenta" corresponds with "M".
- Increasing and decreasing the value in "Yellow" corresponds with "Y".



Adjustment Examples

The following shows adjustment examples. Be sure to check the printed image when changing values.

If the printed image is dark:

Increase the brightness by 20.



If the printed image is faint:

Decrease the brightness by 20.

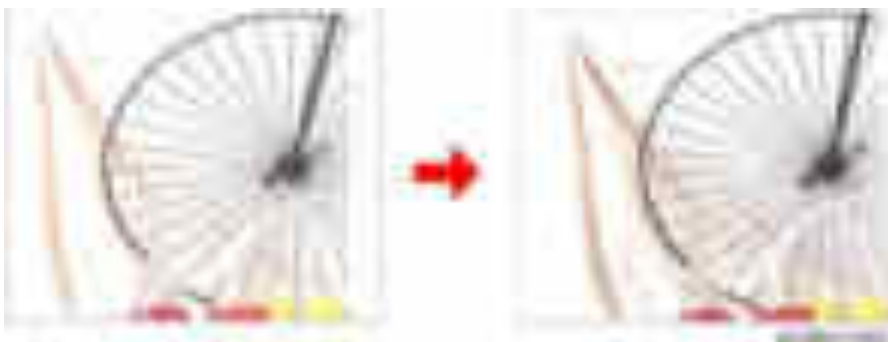

4.Replacement and Adjustment

If the printed image is too bluish:

Increase "Red" or "Magenta" by 20.



If the printed image is too reddish:

Increase "Blue" or "Cyan" by 20.



If the printed image is unclear:

Increase the contrast by 15.



Adjustment by Changing the Machine's Profile Setting

You can change the printer's profile setting by specifying a bit switch in SP mode.



- By changing the profile setting, you can change the tone of all images printed by the machine's printer function.
- By changing the profile setting, you can make the tone (image gamut) of the printed image similar to that of another model. However, due to factors such as the image gamut difference between different models, individual differences, and aging of components, you may not achieve exactly the same tone.

Procedure to Change the Profile Setting

- 1.** Enter the printer SP mode.

2. Change the values of bit switches with the following SP numbers.

Desired tone (color gamut)	SP to change	Value to select
2009 Spring model or those before it	SP1-001-002	00000001 [01H]
2009 Autumn to 2011 Spring model		00010000 [10H]
2011 Autumn model or later		00000000 [00H]
Fuji Xerox product	SP1-001-001	10000000 [80H]

3. Turn the machine's power off and then back on.

The specified setting is applied.

Patterns and Tendency of the Tone for Each Profile

Model with the desired tone	Image (Photo)	Graphic (Picture / Diagram)	Text
2009 Spring model or earlier	Color A	Color A	Color A
2009 Autumn to 2011 Spring model	Color B	Color B	Color B
2011 Autumn model or later	Color B	Color C	Color C
Fuji Xerox product	Color D	Color D	Color D

Color A

Standard profile for MP C2030/C2050/C2030/C2530/C2800/C3300/C4000/C5000 and their preceding models

Color B

Standard profile for MP C2051/C2551/C3001/C3501/C4501/C5501.

Compared to Color A, the following changes have been applied:

- Yellow tint of the skin color is reduced.
- Redness is enhanced to prevent it from appearing like vermilion.
- Green and blue-green appear darker.
- Uses the pure cyan toner on graphics to prevent muddiness.
- Pink in the printed image appears darker.

Color C

Standard profile for MP C3002/C3502/C4502/C5502 up to the present model.

Compared to Color B, the difference between colors have become more recognizable. On the other hand, the printed image has become slightly less vivid.

If you receive a comment that the printed image is less vivid compared to that of a Color B-standard model, we recommend changing the setting to Color B.

4.Replacement and Adjustment

Color D

Profile with a tone similar to that of the prints by the FX products.

- Bluish colors appear slightly purplish. (Image of the sky appears with a slight tint of red.)
- Pink in the printed image appears with a tint of magenta.

Printer Gamma Correction



- We recommend that you keep the printer gamma correction values at the default values.
- The values adjusted/saved in the printer SP mode are applied after the machine's power is turned off and then back on.
- After adjusting/saving the values in the printer SP mode, make sure not to perform the printer's Auto Color Calibration (ACC). Doing so will reset the values.
- To change multiple resolutions, perform this procedure for each resolution.

1. Enter the SP mode.
2. Select the mode you want to change in the printer SP1102-001: Resolution Setting.

1102	[Resolution Setting]		
	Selects the printing mode (resolution) for the printer gamma adjustment.		
001	Resolution Setting	CTL	[0 to 9 / 0 / 1/step] 0: 1200x1200 Photo (2bit/4col) 1: 1200x1200 Photo (1bit/4col) 2: 600x600 Photo (4bit/4col) 3: 600x600 Photo (2bit/4col) 4: 600x600 Photo (1bit/4col) 5: 1200x1200 Text (2bit/4col) 6: 1200x1200 Text (1bit/4col) 7: 600x600 Text (4bit/4col) 8: 600x600 Text (2bit/4col) 9: 600x600 Text (1bit/4col)

3. Change the gamma correction value for each color in the printer SP1104: Gamma Adjustment.



- When adjusting the value, be sure to follow the sequence: I (IDmax) ■ M (Middle) ■ S (Shadow) ■ H (Highlight).
- To lower the print density, reduce and save the H/M/S/I value for each color.
- To heighten the print density, increase and save the H/M/S/I value for each color.

1104	[Gamma Adjustment]		
	Adjusts the printer gamma for the mode selected in the "Mode Selection" menu.		
001	Black: Highlight	CTL	[0 to 30 / 00 / 1/step]
002	Black: Shadow	CTL	

4.Replacement and Adjustment

003	Black: Middle	CTL	
004	Black: IDmax	CTL	
021	Cyan: Highlight	CTL	
022	Cyan: Shadow	CTL	
023	Cyan: Middle	CTL	
024	Cyan: IDmax	CTL	
041	Magenta: Highlight	CTL	
042	Magenta: Shadow	CTL	
043	Magenta: Middle	CTL	
044	Magenta: IDmax	CTL	
061	Yellow: Highlight	CTL	
062	Yellow: Shadow	CTL	
063	Yellow: Middle	CTL	
064	Yellow: IDmax	CTL	

Gamma Correction Sheet

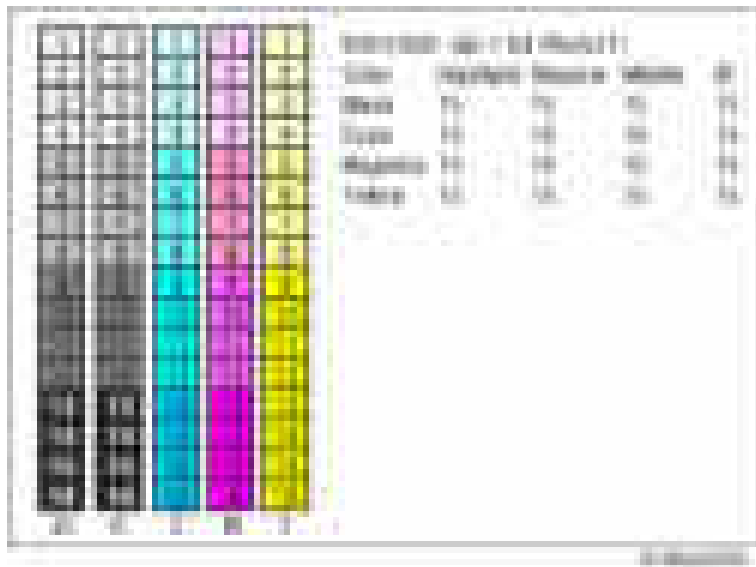

4.Replacement and Adjustment

Range where each value affects

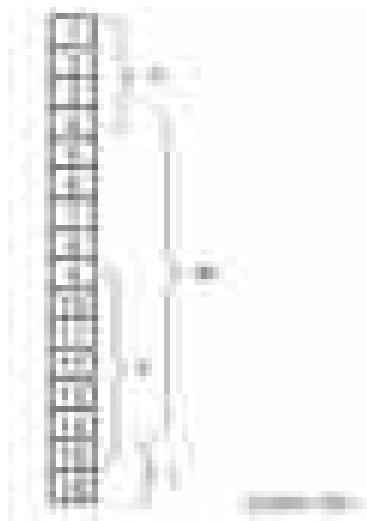

4. Execute the SP1105-001: Save Tone Control Value.



- If you exit the SP mode without saving the values, any changes made in the printer SP1104: Gamma Adjustment will be lost.
- You can check the color balance before and after the gamma adjustment in the printer SP1103-001: Test Page - Color Gray Scale.

5. Turn the machine's power off and then back on.

The changed gamma correction setting is applied.

6. Check the output image and repeat steps 1 - 4 until the desired image is obtained.

Color Registration

Adjust color registration with the following procedure when color registration errors occurred.

Check the Occurrence of Color Registration Errors

Prepare some A3 sheets.

1. Enter the SP mode.

2. Execute SP2-111-004 (Forced line Position Adj.: Mode d).

3. Make sure that execution completed successfully with using SP2-194-007 (MUSIC).

If the value of SP2-194-007 is "0", it indicates that the result of SP2-111-004 was successful.

If the value of SP2-194-007 is "1", it indicates that the result of SP2-111-004 was a failure, which you need to fix the color registration errors (See "Ways to fix color registration errors" [Judgment for Type of Color Registration Error](#)).

4. Execute SP2-109-003 (Test Pattern: Pattern Selection).

5. With a loupe, check the details of the color registration errors on the printed test pattern ([Judgment for Type of Color Registration Error](#)).

- Specification: Main/Sub is smaller than 180.0um
- No color registration errors: Adjustment completed.

- Color registration errors occurred: Adjust the color registration errors (See "Ways to fix color registration errors" in [Judgment for Type of Color Registration Error](#))

Judgment for Type of Color Registration Error

In the following diagrams, solid lines represent "K" and dotted lines indicate any of "C", "M" or "Y".

1. Pattern 1

This is a case in which there is a shift in the sub-scan direction at the leading edge of the paper. The following diagram shows "C", "M" or "Y" lines closer to the leading edge than "K" lines.



2. Pattern 2

This is a case in which there is a shift in the sub-scan direction at the trailing edge of the paper. The following diagram shows "C", "M" or "Y" lines farther away from the leading edge than "K" lines.



3. Pattern 3

This is a case in which a color registration error is found in the main-scan direction and size of the error is the same at the left, center and right.



4.Replacement and Adjustment

4. Pattern 4

This is a case in which a color registration error is found in the main-scan direction and the size of the error is different at the left, center and right. For "M", the largest error will be at the right, followed by the center and then the left. For "C" or "Y", the order will be reversed. This is because the writing direction of the laser beam for "K" and "M" is different from "C" and "Y".

Case "M"

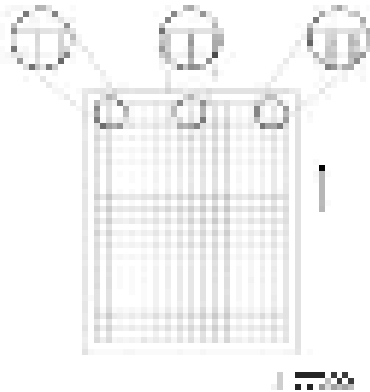

Case "C" or "Y"

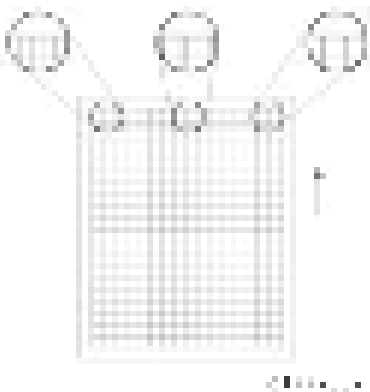

5. Pattern 5

This is a case in which a color registration error is found in the sub-scan direction, but it is not the same as the Pattern 1 or 2. The error appears and disappears at intervals down the page.

Ways to fix color registration errors

SP2-111-004 (Forced Line Position Adj. : Mode D) Execution		
Result: Failed Case: SP2-194-007: 1 (Failed)		
SP2-194-010, 011, 012 shows "2" or "3"	Result of Check	Blank image, abnormal image, low image density
	Causes	1. Image Processing failure 2. Pattern density low 3. BICU failure
	Solution	1. Replace PCU, Intermediate Transfer Belt, Power pack 2. Execute process control, supply toner

4.Replacement and Adjustment

		3. Replace the BICU (PCB10)
	Pattern	-
Failed to read the pattern of Line position Adj.	Result of Check	Normal (but color registration errors occur)
	Causes	1. ID Sensor failure 2. BICU failure
	Solution	1. Replace the TM/ID Sensor (S48) 2. Replace the BICU (PCB10)
	Pattern	-
Any of SP2-194-010 or 011 or 012 shows "5"	Result of Check	Image density low
	Causes	Pattern density low
	Solution	Execute the process control Supply toner
	Pattern	-
Any of SP2-194-010 or 011 or 012 shows "5"	Result of Check	Leading edge registration for "M", "C", and/or "Y" shifts over $\pm 1.4\text{mm}$ from that of "K".
	Causes	1. Laser unit failure 2. BICU failure
	Solution	1. Execute SP2-111-003 (Forced Line Position Adj.: Mode c) 2. Replace Laser unit 3. Replace the BICU (PCB10)
	Pattern	3
Out of line position correction range	Result of Check	Leading edge registration of "M", "C", and/or "Y" shifts over $\pm 1.4\text{mm}$ from that of "K".
	Causes	1. Normal 2. Image Transfer Belt failure 3. Drive Section failure 4. BICU failure
	Solution	1. Execute SP2-111-003 (Forced Line Position Adj.: Mode c) 2. Replace Image Transfer Belt 3. Replace PCU/Drum motor 4. Replace the BICU (PCB10)
	Pattern	1, 2
	Result of	The main scan magnification is OK, but the color

4.Replacement and Adjustment

	Check	registration in the center of the image shifts over 0.66mm.
	Causes	1.ID Sensor(Center) failure 2. Significant movement of Image Transfer Belt (Center) 3.BICU failure
	Solution	1. Replace the TM/ID Sensor (S48) 2. Replace Image Transfer Belt 3. Replace the BICU (PCB10)
	Pattern	-
Out of line position correction range	Result of Check	Skew of "M", "C" and/or "Y" shifts over ± 0.75 mm against that of "K"
	Causes	1. PCU installation failure 2. Laser Unit failure 3. BICU failure
	Solution	1. Reset/Replace PCU 2. Replace Laser Unit 3. Replace the BICU (PCB10)
	Pattern	-
	Result of Check	Other
	Causes	1. The upper skew correction value is abnormal 2. BICU failure
	Solution	1. Reset skew correction value (*1) 2. Replace the BICU (PCB10)
	Pattern	-

*1 Method for resetting the skew correction value.

- 1.** Turn the power OFF.
- 2.** Remove the left cover. ([Left Cover](#))
- 3.** Remove the harness of the laser optics positioning motor (M23) (M24) (M25) attached to the laser

unit (15-pin).



- 4.** Turn the power ON, and then execute the following SPs to set the skew correction mechanism to the origin.
 SP2-220-001 (Skew Origin Set M: Skew Motor)
 SP2-220-002 (Skew Origin Set C: Skew Motor)
 SP2-220-003 (Skew Origin Set Y: Skew Motor)
- 5.** Turn the power OFF.
- 6.** Connect the harness of the skew correction motor to the laser unit.
- 7.** Turn the power ON.

SP2-111-001 (Forced Line Position Adj.: Mode A) execution (or Color Registration via the Maintenance menu in Settings)		
Result: OK Case: SP2-194-007: 0 (Success)		
No color registration errors	Result of Check	Side-to-side registration for K shifted
	Causes	Abnormal SP value of main scan color registration (K)
	Solution	Adjust SP2-101-001
	Pattern	-
Color registration errors found	Result of Check	Image density low
	Causes	Pattern density low
	Solution	Execute process control, Supply toner
	Pattern	-
Color registration errors found	Result of Check	The main scan magnification of "M", "C" and/or "Y" is not correct.
	Causes	1. Laser Unit failure 2. ID Sensor failure 3. BICU failure

4.Replacement and Adjustment

		4. Normal
	Solution	1. Replace Laser Unit 2. Replace the TM/ID Sensor (S48) 3. Replace the BICU (PCB10)
	Pattern	4
Color registration errors found	Result of Check	Although main scan magnification is OK, the color registration in the center of the image is shifted
	Causes	1. Significant movement of Image Transfer Belt (Center) 2. ID Sensor (Center) failure 3. BICU failure
	Solution	1. Replace Image Transfer Belt 2. Replace the TM/ID Sensor (S48) 3. Replace the BICU (PCB10)
	Pattern	-
Color registration errors found	Result of Check	The side-to-side registration of "M", "C", and/or "Y" is not correct.
	Causes	1.ID Sensor(Center) failure 2. Significant movement of Image Transfer Belt (Center) 3. BICU failure
	Solution	1. Replace Laser Unit 2. Replace the TM/ID Sensor (S48) 3. Replace the BICU (PCB10)
	Pattern	3
Color registration errors found	Result of Check	The leading edge registration of "M", "C" and/or "Y" is not correct.
	Causes	1. Image Transfer Belt failure 2. Drive Section failure 3. ID Sensor failure 4. BICU failure 5. Normal
	Solution	1. Replace Image Transfer Belt 2. Replace PCU, Drum motor 3. Replace the TM/ID Sensor (S48) 4. Replace the BICU (PCB10)
	Pattern	1, 2
Color registration errors found	Result of Check	The skew of "M", "C" and/or "Y" is not correct.
	Causes	1. PCU installation failure

4.Replacement and Adjustment

		<ul style="list-style-type: none"> 2. Laser Unit failure 3. IOB failure
	Solution	<ul style="list-style-type: none"> 1. Reset/Replace PCU 2. Replace Laser Unit 3. Replace IOB
	Pattern	-
Color registration errors found	Result of Check	Shifted Drum phase.
	Causes	<ul style="list-style-type: none"> 1. PCU installation failure 2. Drive Section failure 3. Phase adjustment failure
	Solution	<ul style="list-style-type: none"> 1. Reset/Replace PCU 2. Check/Replace Drive Section 3. Execute SP1-902-001
	Pattern	5

Adjustment after Replacement

Image Adjustment After Replacing Parts

The following items need to be adjusted after the replacement of parts.

- [Auto Color Calibration](#)
- [Adjusting the Tone of the Printed Image](#)
- [Adjustment by Changing the Printer Driver Setting](#)
- [Adjustment by Changing the Machine's Profile Setting](#)
- [Printer Gamma Correction](#)
- [Color Registration](#)

In addition to adjustment of the settings listed above, adjustment of the following settings is required after executing SP5-801 or after replacement of the following parts:

Parts	Implementation items
<ul style="list-style-type: none"> • Scanner Carriage • Laser Unit • Scanner Motor (M26) • Polygon Mirror Motor (M27) • Paper Feed Unit • Bypass Tray Unit • Duplex Unit 	<ul style="list-style-type: none"> • Image Position Adjustment • Scanning Adjustment
<ul style="list-style-type: none"> • ADF 	ADF Image Adjustment

Image Position Adjustment



- Before you start adjustment, make sure that the paper in each tray is loaded correctly.
- Use the same paper type and size as those used by customers.
- Use "14: Trimmed area" in SP2-109-003 to print a test pattern, and set SP2-109-003 back to "0" after you finish adjustment.

Standard

- Leading Edge (A) : 4.2 mm ±1.5mm (plain paper, thin paper)
- Side to Side (B): 0.5mm to 4.0mm
- Trailing Edge (C): 0.5mm to 6.0mm (duplex mode: 3.0 to 6.0mm)

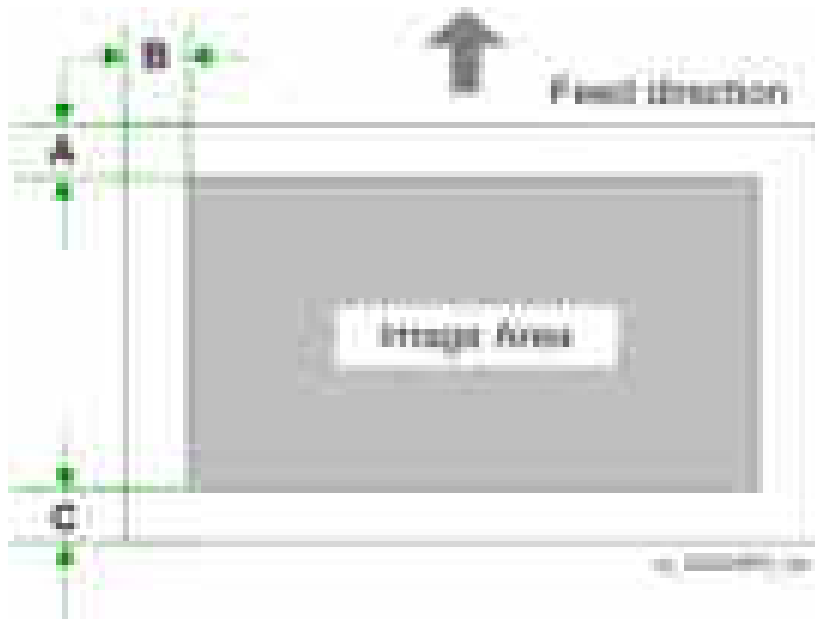

Main/Sub Scan Registration Adjustment

Adjustment Standard

- Leading edge (sub-scan direction): 4.2 ± 1.5 mm
- Side to side (main-scan direction): 2 ± 1 mm

Make sure that the registration is adjusted within the adjustment standard range as shown below.

Leading Edge	Adjusts the leading edge registration for each paper type and process line speed.
Side to Side	Adjusts the side-to-side registration for each paper feed station. Use SP mode (SP1-002) to adjust the side-to-side registration for the optional paper feed unit, LCT, and duplex unit.

Adjustment Procedure



- Registration may be changed slightly in each sheet. Print some test pattern "14: Trimmed area", then average the leading edge and side-to-side registration values, and adjust each SP mode.

1. Print out the test pattern (14: Trimmed area) with SP2-109-003.
2. Do the leading edge registration [A] adjustment.
 - 1) Check the leading edge registration and adjust it with **SP1-001**.
 - 2) Select the adjustment conditions (paper type and process line speed).
 - 3) Input the value. Then press the [#] key.

4.Replacement and Adjustment

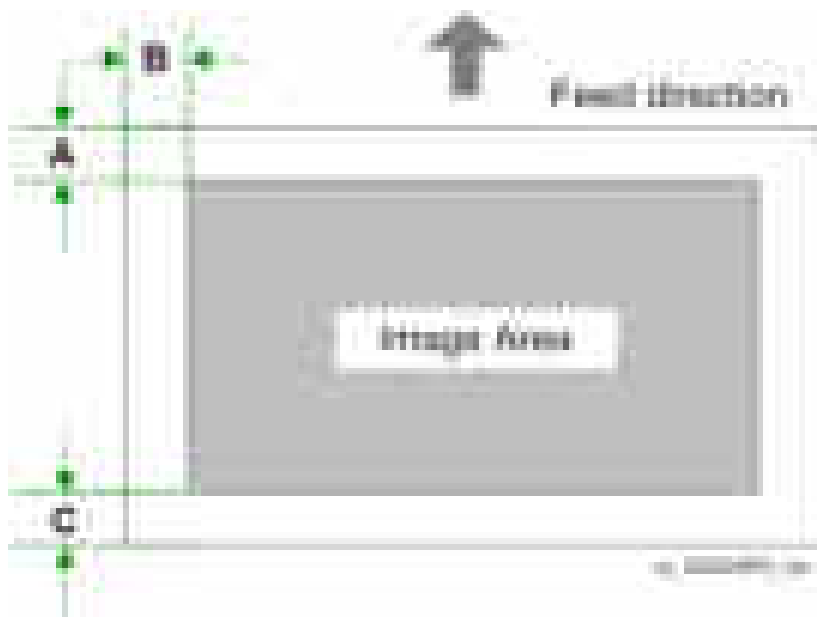

- 3.** After the leading edge registration adjustment, print out the new test pattern.
- 4.** Do the side-to-side registration [B] adjustment.
 - 1) Check the side-to-side registration and adjust it with **SP1-002**.
 - 2) Select the adjustment conditions (paper feed station).
 - 3) Input the value. Then press the [#] key.
 - 4) Generate a trim pattern to check the leading edge adjustment.

Erase Margin Adjustment



- Adjust the erase margin C and D only if the registration (main scan and sub-scan) cannot be adjusted within the standard values.
 - Do the registration adjustment after adjusting the erase margin C and D, and then adjust the erase margin A and B.
- 1.** Print out the test pattern (14: Trimmed area) with SP2-109-003.
 - 2.** Check the erase margin A and B, and then adjust them with SP2-103-001 to -015 if necessary.

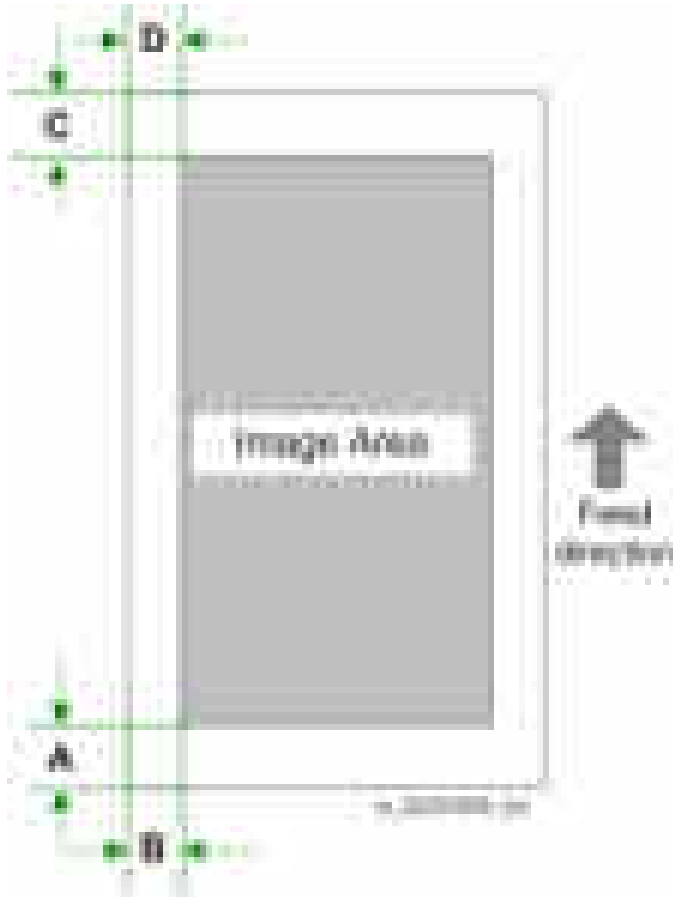

Scanning Adjustment



- Check and perform the image position adjustment before you do the following scanner adjustments. (Refer to [Image Position Adjustment](#))
- Use a C4 test chart to do the following adjustments.

Scanner leading edge and side-to-side registration

1. Put the test chart on the exposure glass. Then make a copy from one of the feed stations.

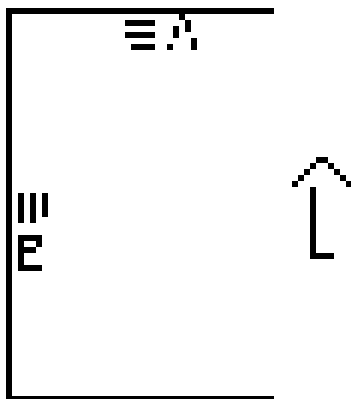

A: Leading Edge Registration

B: Side-to-side Registration

4.Replacement and Adjustment

2. Check the leading edge and side-to-side registration.

A: $4.2 \pm 2\text{mm}$

B: $2.0 \pm 1\text{mm}$

3. Adjust the following SP modes if necessary.

Name	SP mode
Leading edge registration (Home Position Adj Value)	SP4-803-001
Side-to-Side Registration (Main Scan Reg)	SP4-011-001

Scanner magnification

1. Put the test chart on the exposure glass. Then make a copy from one of the feed stations.

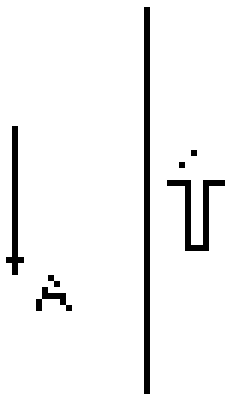

A: Sub-scan magnification

2. Check the magnification ratio.

Standard:

- Normal mode for main-scan: $\pm 0.55\%$ or less
- Normal mode for sub-scan: $\pm 1.00\%$ or less
- Reduction mode for main-scan: $\pm 1.00\%$ or less
- Enlargement mode for main-scan: $\pm 1.00\%$ or less

3. Adjust with SP4-008 if necessary.

Scanner shading correction

1. Turn the power OFF and then ON.

The shading correction is executed automatically when the machine is rebooted.

ADF Image Adjustment

ADF side-to-side, leading edge registration and trailing edge

1. Use A3/DLT paper to make a temporary test chart as shown below.

A: Leading edge registration

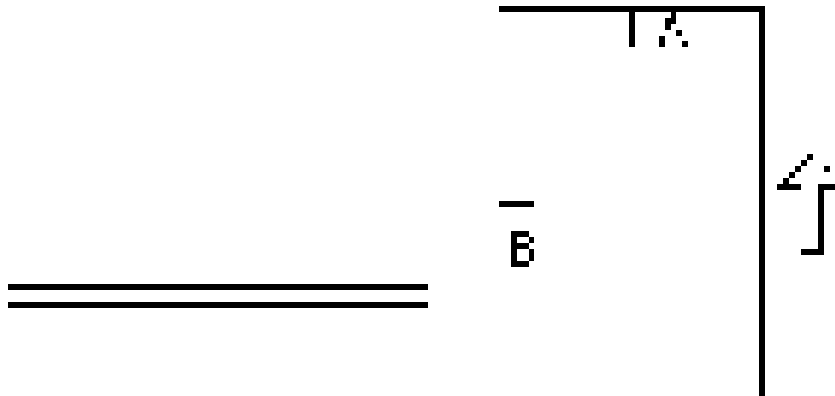

2. Put the temporary test chart on the ADF, and then make a copy from one of the feed stations.
3. Check the registration. Check the leading edge and side-to-side registration. Adjust the following SP modes if necessary.

Standard: 4.2 ± 2 mm for the leading edge registration, 2 ± 1 mm for the side-to-side registration.

Use the following SP modes to adjust if necessary.

SP Code	What It Does	Adjustment Range
SP6-006-001	Side-to-Side Regist: Front	± 3.0 mm
SP6-006-003	Leading Edge Registration	± 5.0 mm
SP6-006-005	Buckle: Duplex Front	± 3.0 mm
SP6-006-006	Buckle: Duplex Rear	± 2.5 mm
SP6-006-007	Rear Edge Erase (Trailing Edge)	± 10.0 mm

ADF sub-scan magnification

1. Put the temporary test chart on the ADF, and then make a copy from one of the feed stations.
2. Check the magnification ratio. Adjust with SP6-017-001 if necessary.

Specification (magnification error)

- Sub-scan without magnification: $\pm 2.75\%$
- Sub-scan with magnification: $\pm 2.75\%$

5. Troubleshooting

Self-Diagnostic Mode

SC Automatic Reboot

When an ordinary SC (pattern D) is generated, automatically reboot is performed. Automatic reboot or reboot by user operation can be set by SP5-875-001 (SC automatic reboot setting out) (default value: 0 "Automatic reboot").

When a type D occurs, an automatic reboot is done or the machine display asks the customer if it can reboot. However, when the SC occurs twice in a short time, the machine sends a report to the @Remote server without rebooting. This is because just rebooting may not be a good solution if an SC occurs twice.

When an automatic reboot is performed, a confirmation screen is displayed after reboot. The confirmation screen can be canceled by pressing the [OK] key (display is not canceled only when the main power switch is switched OFF to ON).

Screen display during reboot

- Status display on the current screen
 - Post-processing Post-processing during printing, etc.
 - Automatic reboot After operation end

Post-processing

■ ■ 7 7 7 7 7 7 7 7 7 7

Until automatic reboot

7 7 7 7 7 7 7 7 7 7

- Reset key (Reboot key)
Key to perform the reboot
Cancel key is not displayed.
- Turn on spanner LED (same as when an SC is generated).

Operation during SC reboot

- The timing of SC reboot
When @Remote is enabled, and when an NRS alarm*1 is not generated, the corresponding SC is the object of an automatic reboot.
*1 NRS alarm: Issued when an ordinary SC (type D) is generated twice while the total counter counts 10 times.
- Time to automatic reboot
Reboot is performed 30 seconds after an engine reboot is possible, after the end of post-processing during printing, etc.

At that time, a reboot is performed even if the MFP is operating. The engine does not start process control when a reboot is possible.

- Automatic reboot

See the flowchart below.

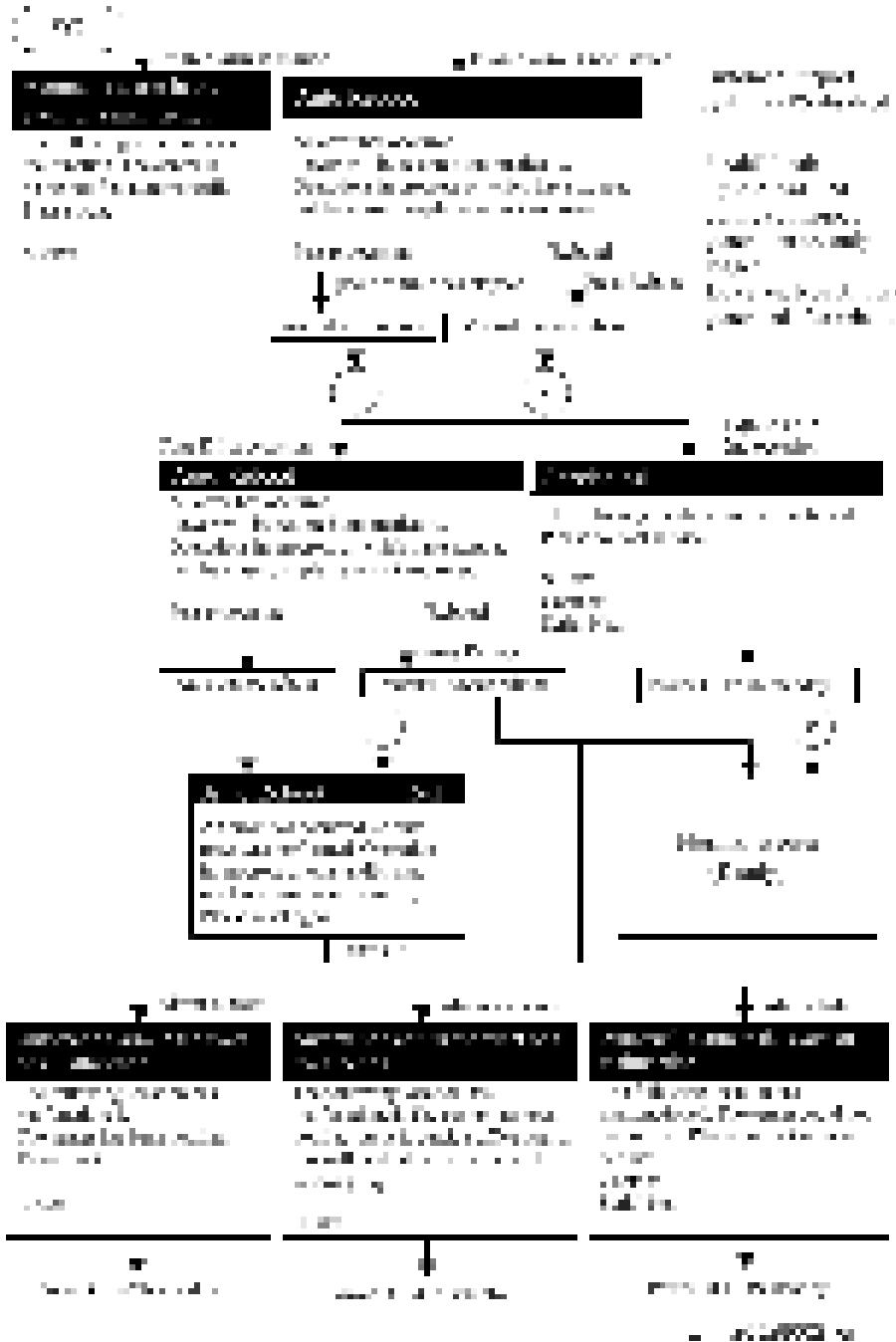

- For the SC list of the automatic reboot, refer to [List of Automatic Reboot Target SC](#).

HDD-related Messages

If there is an HDD problem, “HDD error” message will be displayed on the operation panel and the user will be taken to the HDD format screen.

5.Troubleshooting

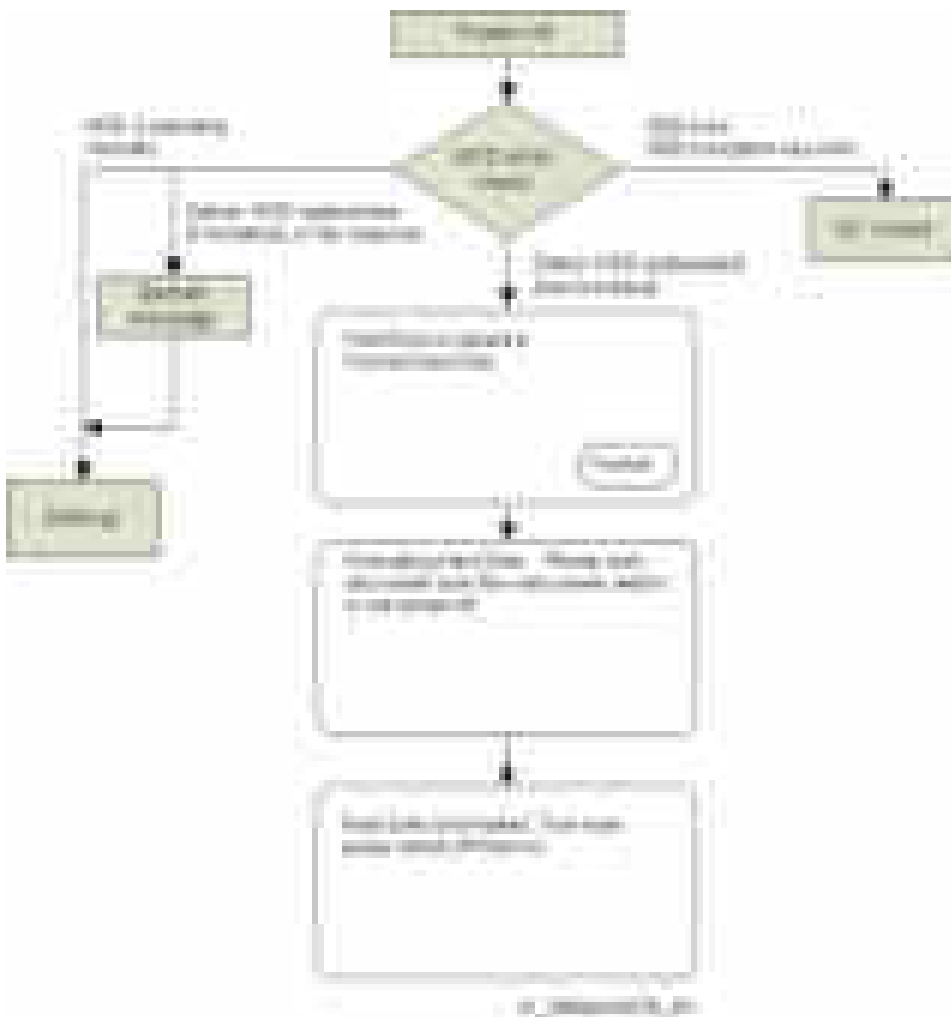

Even when replacing the controller board, a banner "Hard Disk is replaced." appears. It is because the machine recognizes HDD has been replaced when the controller board that does not hold the HDD identification information is attached.

Message list

Message (Display Type)	Status	Error Condition	Major Cause	/ Solution
SC86-00 (Pop-up)	Abnormal	The HDD cannot be accessed at power-on.	NVRAM is replaced.	Turn the main power off/on to initialize the machine. *When replacing the NVRAM, if possible, back up the address book before replacing the NVRAM and restore it after

Message (Display Type)	Status	Error Condition	Major Cause	/ Solution
				replacing the NVRAM.
SC860-01 (Pop-up)	Abnormal	The file system can not be mounted.	HDD is defective.	Replace the HDD (PCB12).
SC860-02 (Pop-up)	Abnormal	The management file on the HDD cannot be read.	HDD is defective.	Replace the HDD (PCB12).
SC860-03 (Pop-up)	Abnormal	Problem with the Encryption Key for Hard Disk.	HDD is defective.	Replace the HDD (PCB12).
Hard Disk is replaced. Format Hard Disk. (Pop-up with "Format" button.)	Normal	A new HDD is attached.	A new HDD attached.	Push the formatting button.
Hard Disk is replaced. (Banner)	Abnormal	The HDD is replaced (Data can be read).	<ul style="list-style-type: none"> Controller board replaced. After starting the machine without an HDD, a new HDD is attached to the machine and then restart the machine. 	Turn the main power off/on.
Formatting Hard Disk... Please wait, also make sure the main power switch is not turned off. (Pop-up)	Abnormal	Formatting the HDD	Formatting the HDD	-
Hard Disk is formatted. Turn the main power		Formatting the HDD is finished.	-	Turn the main power off/on.

5.Troubleshooting

Message (Display Type)	Status	Error Condition	Major Cause	/ Solution
switch off then on.				

Service Call Conditions

Summary

The 'SC Table' section shows the SC codes for controller errors and other errors. The latter are put into four types. The type is determined by their reset procedures. The table shows the classification of the SC codes.

Type	Display	How to reset
A	<p>The SC is immediately displayed on the operation panel when SC occurs.</p> <p>The error involves the fusing unit. The machine operation is disabled. The user cannot reset the error.</p>  <ul style="list-style-type: none"> When canceling a fusing unit SC, (SC544-00/ SC554-00/ SC564-00/ SC574-00), perform part replacement in accordance with the above procedure. 	Reset the SC (set SP5-810-1) and then cycle the main power off and on.
B	<p>When a function is selected, the SC is displayed on the operation panel.</p> <p>The machine cannot be used (down-time mitigation).</p>	Turn the operation switch off and on.
C	<p>No display on the operation panel.</p> <p>The machine operates as usual.</p>	Only the SC history is updated.
D	<p>The SC is displayed on the operation panel.</p> <p>The machine cannot be used (machine-error SC).</p>	Turn the main n power switch off and on.

- When an ordinary SC (type D) is generated, an automatic reboot is performed. When an event is reported by the customer support system, even in the event of an ordinary SC, reboot is not performed. During automatic reboot, a confirmation screen is displayed after the reboot.
- When automatic reboot occurs twice continuously, an SC is displayed without rebooting, and logging count is performed. Also, when an SMC print is output, an * mark is added alongside the SC number for clarity.
- Automatic reboot can be enabled or disabled with SP5-875-001 (SC automatic reboot setting) (default value: ON).

SP descriptions

- SP5-875-001 (SC automatic reboot: Reboot Setting)**

Enables or disables the automatic reboot function when an SC error occurs.

0: The machine reboots automatically when the machine issues an SC error and logs the SC error code. If the same SC occurs again, the machine does not reboot.

1: The machine does not reboot when an SC error occurs.

The reboot is not executed for the pattern A or C.

5.Troubleshooting

SC Logging

When an SC is generated, the "total count value when the SC is generated" and the "SC code" are logged. However, if the total count value during the SC is the same as last time, logging is not performed.

Logged data can be checked by outputting an administrative report (SMC print). The SC history is logged up to the last 10 entries, and if there are more than 10 entries, data are progressively deleted starting from the oldest.

List of Automatic Reboot Target SC

Engine SC

For details of Automatic reboot, refer to [SC Automatic Reboot](#).

SC100 (Engine: Scanning)

SC code	Name	Automatic Reboot
101-01	Lamp Error (Scanning)	Yes
101-02	Lamp Error (LED illumination adjustment)	Yes
102-00	LED Illumination Adjustment Error	Yes
120-00	Scanner Home Position Error 1	Yes
121-00	Scanner Home Position Error 2	Yes
141-00	Black level detection error	Yes
142-00	White level detection error	Yes
144-00	SBU Communication Error	Yes
151-00	Black Level Error: Side 2	Yes
152-00	White Level Error: Side 2	Yes
154-00	Scanner Communication Error: Side 2	Yes
161-02	IPU error (Lsync Error: Side 2)	Yes
161-20	IPU error (DRAM initialization failure)	Yes
195-00	Machine serial number error	No

SC200 (Engine: Image Writing)

SC code	Name	Automatic Reboot
202-00	Polygon Mirror Motor: ON Timeout Error	Yes
203-00	Polygon Mirror Motor: OFF Timeout Error	Yes
204-00	Polygon Mirror Motor: XSCRDY Signal Error	Yes
220-01	Leading Edge: LD1 synchronization detection error: Bk	Yes
220-04	Leading Edge: LD1 synchronization detection error: Ye	Yes

SC code	Name	Automatic Reboot
230-01	FGATE ON error: Bk	Yes
230-02	FGATE ON error: Cy	Yes
230-03	FGATE ON error: Ma	Yes
230-04	FGATE ON error: Ye	Yes
231-01	FGATE OFF error: Bk	Yes
231-02	FGATE OFF error: Cy	Yes
231-03	FGATE OFF error: Ma	Yes
231-04	FGATE OFF error: Ye	Yes
240-01	LD error: Bk	Yes
240-02	LD error: Cy	Yes
240-03	LD error: Ma	Yes
240-04	LD error: Ye	Yes
272-01	LD driver communication error: Bk	Yes
272-02	LD driver communication error: Cy	Yes
272-03	LD driver communication error: Ma	Yes
272-04	LD driver communication error: Ye	Yes
272-10	LD driver communication error: Other	Yes
285-01	Skew Motor (in LD unit) Power Control Error	No
285-02	MUSIC error	No
285-03	Insufficient MUSIC patterns	No

SC300 (Engine: Charge, Development)

SC code	Name	Automatic Reboot
312-01	Charge Roller HVP_CB Output Error (K)	Yes
312-02	Charge Roller HVP_CB Output Error (C)	Yes
312-03	Charge Roller HVP_CB Output Error (M)	Yes
312-04	Charge Roller HVP_CB Output Error (Y)	Yes
324-01	Development motor: Bk: Lock	Yes
324-05	Development motor: CMY: Lock	Yes
360-01	TD sensor adjustment error (K)	Yes
360-02	TD sensor adjustment error (C)	Yes
360-03	TD sensor adjustment error (M)	Yes
360-04	TD sensor adjustment error (Y)	Yes
361-01	TD sensor output error: Upper Limit (K)	No
361-02	TD sensor output error: Upper Limit (C)	No

5.Troubleshooting

SC code	Name	Automatic Reboot
361-03	TD sensor output error: Upper Limit (M)	No
361-04	TD sensor output error: Upper Limit (Y)	No
362-01	TD sensor output error: Lower limit (K)	No
362-02	TD sensor output error: Lower limit (C)	No
362-03	TD sensor output error: Lower limit (M)	No
362-04	TD sensor output error: Lower limit (Y)	No
370-01	TM (ID) sensor calibration error (F)	No
370-02	TM (ID) sensor calibration error (C)	No
370-03	TM (ID) sensor calibration error (R)	No
371-01	TM/ID sensor output error (front): Background area output (regular reflection)	No
371-02	TM/ID sensor output error (center): Background area output (regular reflection)	No
371-03	TM/ID sensor output error (rear): Background area output (regular reflection)	No
375-01	TM/ID sensor output error (front) :Detection of belt breakage	No
375-03	TM/ID sensor output error (rear) :Detection of belt breakage	No
396-05	Drum motor (CMY) Lock	Yes

SC400 (Engine: Scanning)

SC code	Name	Automatic Reboot
441-00	Drum transfer motor: Lock	Yes
442-00	ITB Lift Error	Yes
452-00	Paper transfer contact and release motor error	Yes
491-00	High voltage power source: charge/development: output error	Yes
492-00	High voltage power source: image transfer/paper transfer: output error	No
497-00	Machine temperature detection thermistor error	No
498-00	Temperature and humidity sensor error	No

SC500

SC code	Name	Automatic Reboot
501-01	1st Tray Lift Error (Main Machine)	No
501-02	1st Tray Descent Error (Main Frame)	No
502-01	2nd Tray Lift Error (Main Frame)	No
502-02	2nd Tray Descent Error (Main Frame)	No
503-01	3rd Tray Lift Error (One-tray paper feed unit)	No
503-02	3rd Tray Descent Error (One-tray paper feed unit)	No

SC code	Name	Automatic Reboot
503-11	3rd Tray Lift Error (Two-tray paper feed unit)	No
503-12	3rd Tray Descent Error (Two-tray paper feed unit)	No
503-31	3rd Tray Lift Error (Tandem paper feed unit)	No
503-32	3rd Tray Descent Error (Tandem paper feed unit)	No
503-33	3rd Tray Paper Overload Error (Tandem paper feed unit)	No
503-34	3rd Tray Paper Position Error (Tandem paper feed unit)	No
503-35	3rd Tray Transfer Error (Tandem paper feed unit)	No
503-36	3rd Tray Transfer HP Error (Tandem paper feed unit)	No
504-21	4th Tray Lift Error (Two-tray paper feed unit)	No
504-22	4th Tray Descent Error (Two-tray paper feed unit)	No
505-41	Side LCIT Limit Detection Error (Side LCIT)	No
505-42	Side LCIT Lower Limit Detection Error (Side LCIT)	No
505-43	Side LCIT Paper Overload Error (Side LCIT)	No
508-00	Bypass Tray Size Detection Error	No
520-01	Registration Motor (M7): Lock	No
520-02	Paper feed Motor: Lock	No
520-03	Transport Motor: Lock	No
521-01	Duplex Entrance Motor: Lock	No
521-02	Duplex By-pass Motor: Lock	No
522-00	Paper Exit Motor: Lock	No
530-00	Fusing Exhaust Fan Lock	No
531-01	Development Intake Fan/Right Lock	Yes
531-03	Drive Cooling Fan Lock	Yes
533-01	PSU Exhaust Fan Lock	Yes
533-03	PSU Cooling Fan Lock	Yes
533-04	Controller Box Cooling Fan Lock	Yes
534-01	Main Exhaust Fan Lock	Yes
534-02	Toner Supply Cooling Fan Lock	Yes
534-03	Ozone Exhaust Fan Lock	Yes
535-00	Paper Exit Cooling Fan Lock	Yes
540-00	Fusing Motor: Lock	Yes
541-01	Thermopile (Center) Disconnection	No
541-02	Non-contact Thermistor (Center) Disconnection	No
541-03	Non-contact Thermistor (Center) short-circuit	No
542-02	Thermopile (Center) does not reload	No
542-03	Thermopile (Center) does not reload	No

5.Troubleshooting

SC code	Name	Automatic Reboot
542-05	Thermopile (Center) does not reload (Low Power)	Yes
542-06	Thermopile (Center) does not reload (Low Power)	Yes
543-00	Thermopile (Center) high temperature detection (software)	No
544-01	Thermopile (Center) high temperature detection (hardware)	No
544-02	Non-contact Thermistor (Center) high temperature detection (hardware)	No
545-01	Fusing Central Lamp Continuously Heat	No
545-05	Fusing Central Lamp Continuously Heat (Low Power)	Yes
547-01	Zero cross error (relay-contact soldering)	Yes
547-02	Zero cross error (relay contact error)	Yes
547-03	Zero cross error (low-frequency error)	Yes
549-02	Fusing Shield Operation Error	Yes
549-03	Fusing Shield Operation Error	Yes
549-04	Fusing Shield Operation Error	Yes
549-05	Fusing Shield Operation Error	No
549-05	Fusing Shield Operation Error	No
551-01	Thermopile (Edge) Disconnection	No
551-02	Non-contact Thermistor (Edge) Disconnection	No
551-03	Non-contact Thermistor (Edge) Short-circuit	No
552-02	Thermopile (Edge) Does Not Reload	No
552-03	Thermopile (Edge) Does Not Reload	No
552-05	Thermopile (Center) Does Not Reload (Low Power)	Yes
552-06	Thermopile (Center) Does Not Reload (Low Power)	Yes
553-00	Thermopile (Edge) High Temperature Detection (software)	No
554-01	Thermopile (Edge) high temperature detection (hardware)	No
554-02	Non-contact Thermistor (Edge) high temperature detection (hardware)	No
555-01	Fusing Edge Lamp Continuously Heat	No
555-05	Fusing Edge Lamp Continuously Heat (Low Power)	Yes
557-00	Zero Cross Frequency Exceeded	No
558-01	Low Input Voltage	No
559-00	Fusing Jam Detected for 3 Times Consecutively	No
561-01	Pressure Roller Thermistor (Center) Disconnection	No
561-05	Pressure Roller Thermistor (Center) Disconnection (Low Power)	Yes
562-05	Pressure Roller Thermistor (Center) Does Not Reload (Low Power)	Yes
563-00	Pressure Roller Thermistor (Center) High Temperature Detection (software)	No
564-00	Pressure Roller Thermistor (Center) High Temperature Detection (Hardware)	No
569-00	Paper Exit/ Pressure Release Motor Error Detection	Yes

SC code	Name	Automatic Reboot
571-01	Pressure Roller Thermistor (Edge) Disconnection	No
571-05	Pressure Roller Thermistor (Edge) Disconnection	Yes
572-05	Pressure Roller Thermistor (Edge) Does Not Reload (Low Power)	Yes
573-00	Pressure Roller Thermistor (Edge) High Temperature Detection (software)	No
574-00	Pressure Roller Thermistor (edge) High Temperature Detection (hardware)	No
581-01	Pressure Roller Thermistor (Full-bleed edge) Thermistor Disconnection	No
581-05	Pressure Roller Thermistor (Full-Bleed Edge) Disconnection (Low Power)	Yes
582-04	Pressure Roller Thermistor (Full-bleed edge) Does Not Reload	No
582-05	Pressure Roller Thermistor (Full-Bleed Edge) Does Not Reload (Low Power)	Yes
583-00	Pressure Roller Thermistor (Full-bleed edge) High Temperature Detection (software)	No
584-00	Pressure Roller Thermistor (Full-bleed edge) High Temperature Detection (hardware)	No

SC600

SC code	Name	Automatic Reboot
620-01	ADF Communication error 1	Yes
620-02	ADF Communication error 2	Yes
620-03	ADF Communication error 3	Yes
620-04	ADF Communication error 4	Yes
621-00	Finisher communication error	Yes
622-01	Paper bank 1 communication error for the one-tray paper feed unit	Yes
622-11	Paper bank 1 communication error for the tandem tray paper feed unit	Yes
622-31	Paper bank 1 communication error for the two-tray paper feed unit	Yes
623-00	Paper bank 2 communication error for the side LCIT	Yes
663-01	Reset Detection: Imaging IOB: Software hangup occurs	Yes
663-02	Reset Detection: Imaging IOB: Power ON reset occurs	Yes
663-03	Reset Detection: Imaging IOB: Software reset occurs	Yes
663-11	Reset Detection: Paper Transport IOB: Software hangup occurs	Yes
663-12	Reset Detection: Paper Transport IOB: Power ON reset occurs	Yes
663-13	Reset Detection: Paper Transport IOB: Software reset occurs	Yes
664-01	VODKA1 (Paper Transport Vodka) access permission error to VODKA SRAM	No
664-02	VODKA1 (Paper Transport Vodka) write error to VODKA SRAM	No
664-03	VODKA1 (Paper Transport Vodka) VODKA program launch error	No

5.Troubleshooting

SC code	Name	Automatic Reboot
664-11	VODKA2 (Imaging Vodka) access permission error to VODKA SRAM	No
664-12	VODKA2 (Imaging Vodka) write error to VODKA SRAM	No
664-13	VODKA2 (Imaging Vodka) VODKA program launch error	No
665-04	IOB does not start up	No
665-05	Master Device Communication Error	No
665-06	IPU and IOB signal Communication Error	No
665-07	IPU signal Communication Error	No
665-08	IOB signal Communication Error	No
665-11	Vodka1 Communication Error	No
665-12	Vodka2 Communication Error	No
665-41	Macaron1 Communication Error	No
665-42	Macaron2 Communication Error	No
665-61	Vodka1 Communication Error (Continuous Monitoring)	No
665-62	Vodka2 Communication Error (Continuous Monitoring)	No
667-01	Master Device Mode Setting Error	No
667-10	Slave1 Device Mode Setting Error	No
667-11	Slave2 Device Mode Setting Error	No
667-40	Macaron1 Mode Setting Error	No
667-41	Macaron2 Mode Setting Error	No
668-01	Vodka1 Version Setting Error	No
668-02	Vodka2 Version Setting Error	No
668-03	Vodka1,2 Version Setting Error	No
669-01	EEPROM OPEN: ID error	Yes
669-02	EEPROM OPEN: Channel error	Yes
669-03	EEPROM OPEN: Device error	Yes
669-04	EEPROM OPEN: Communication abort error	Yes
669-05	EEPROM OPEN: Communication timeout error	Yes
669-06	EEPROM OPEN: Operation stopped error	Yes
669-07	EEPROM OPEN: Buffer full	Yes
669-08	EEPROM OPEN: No error code	Yes
669-09	EEPROM CLOSE: ID error	Yes
669-10	EEPROM CLOSE: No error code	Yes
669-11	EEPROM Data write: ID error	Yes
669-12	EEPROM Data write: Channel error	Yes
669-13	EEPROM Data write: Device error	Yes
669-14	EEPROM Data write: Communication abort error	Yes

SC code	Name	Automatic Reboot
669-15	EEPROM Data write: Communication timeout error	Yes
669-16	EEPROM Data write: Operation stopped error	Yes
669-17	EEPROM Data write: Buffer full	Yes
669-18	EEPROM Data write: No error code	Yes
669-19	EEPROM Data read: ID error	Yes
669-20	EEPROM Data read: Channel error	Yes
669-21	EEPROM Data read: Device error	Yes
669-22	EEPROM Data read: Communication abort error	Yes
669-23	EEPROM Data read: Communication timeout error	Yes
669-24	EEPROM Data read: Operation stopped error	Yes
669-25	EEPROM Data read: Buffer full	Yes
669-26	EEPROM Data read: No error code	Yes
669-36	Verification error	Yes
669-37	Error Detection	Yes
681-01	Toner bottle: IDChip Communication error: Invalid device ID :K	Yes
681-02	Toner bottle: IDChip Communication error: Invalid device ID :M	Yes
681-03	Toner bottle: IDChip Communication error: Invalid device ID :C	Yes
681-04	Toner bottle: IDChip Communication error: Invalid device ID :Y	Yes
681-06	Toner bottle: IDChip Communication error: Channel error :K	Yes
681-07	Toner bottle: IDChip Communication error: Channel error :M	Yes
681-08	Toner bottle: IDChip Communication error: Channel error :C	Yes
681-09	Toner bottle: IDChip Communication error: Channel error :Y	Yes
681-11	Toner bottle: IDChip Communication error: Device Error :K	Yes
681-12	Toner bottle: IDChip Communication error: Device Error :M	Yes
681-13	Toner bottle: IDChip Communication error: Device Error :C	Yes
681-14	Toner bottle: IDChip Communication error: Device Error :Y	Yes
681-16	Toner bottle: IDChip Communication error: Communication error (interrupted) :K	Yes
681-17	Toner bottle: IDChip Communication error: Communication error (interrupted) :M	Yes
681-18	Toner bottle: IDChip Communication error: Communication error (interrupted) :C	Yes
681-19	Toner bottle: IDChip Communication error: Communication error (interrupted) :Y	Yes
681-21	Toner bottle: IDChip Communication error: Communication timeout :K	Yes
681-22	Toner bottle: IDChip Communication error: Communication timeout :M	Yes

5.Troubleshooting

SC code	Name	Automatic Reboot
681-23	Toner bottle: IDChip Communication error: Communication timeout :C	Yes
681-24	Toner bottle: IDChip Communication error: Communication timeout :Y	Yes
681-26	Toner bottle: IDChip Communication error: Device stops (logically) :K	Yes
681-27	Toner bottle: IDChip Communication error: Device stops (logically) :M	Yes
681-28	Toner bottle: IDChip Communication error: Device stops (logically) :C	Yes
681-29	Toner bottle: IDChip Communication error: Device stops (logically) :Y	Yes
681-31	Toner bottle: IDChip Communication error: Full of buffer (request) :K	Yes
681-32	Toner bottle: IDChip Communication error: Full of buffer (request) :M	Yes
681-33	Toner bottle: IDChip Communication error: Full of buffer (request) :C	Yes
681-34	Toner bottle: IDChip Communication error: Full of buffer (request) :Y	Yes
681-36	Toner bottle: IDChip Communication error: Verification error:K	Yes
681-37	Toner bottle: IDChip Communication error: Verification error:M	Yes
681-38	Toner bottle: IDChip Communication error: Verification error:C	Yes
681-39	Toner bottle: IDChip Communication error: Verification error:Y	Yes
682-01	TD sensor communication error: Invalid device ID :K	Yes
682-02	TD sensor communication error: Invalid device ID :M	Yes
682-03	TD sensor communication error: Invalid device ID :C	Yes
682-04	TD sensor communication error: Invalid device ID :Y	Yes
682-06	TD sensor communication error: Channel error :K	Yes
682-07	TD sensor communication error: Channel error :M	Yes
682-08	TD sensor communication error: Channel error :C	Yes
682-09	TD sensor communication error: Channel error :Y	Yes
682-11	TD sensor communication error: Device Error :K	Yes
682-12	TD sensor communication error: Device Error :M	Yes
682-13	TD sensor communication error: Device Error :C	Yes
682-14	TD sensor communication error: Device Error :Y	Yes
682-16	TD sensor communication error: Communication error (interrupted) :K	Yes
682-17	TD sensor communication error: Communication error (interrupted) :M	Yes
682-18	TD sensor communication error: Communication error (interrupted) :C	Yes
682-19	TD sensor communication error: Communication error (interrupted) :Y	Yes
682-21	TD sensor communication error: Communication timeout :K	Yes
682-22	TD sensor communication error: Communication timeout :M	Yes
682-23	TD sensor communication error: Communication timeout :C	Yes
682-24	TD sensor communication error: Communication timeout :Y	Yes
682-26	TD sensor communication error: Device stops (logically) :K	Yes
682-27	TD sensor communication error: Device stops (logically) :M	Yes

SC code	Name	Automatic Reboot
682-28	TD sensor communication error: Device stops (logically) :C	Yes
682-29	TD sensor communication error: Device stops (logically) :Y	Yes
682-31	TD sensor communication error: Full of buffer (request) :K	Yes
682-32	TD sensor communication error: Full of buffer (request) :M	Yes
682-33	TD sensor communication error: Full of buffer (request) :C	Yes
682-34	TD sensor communication error: Full of buffer (request) :Y	Yes
682-36	TD sensor communication error: Verification error:K	Yes
682-37	TD sensor communication error: Verification error:M	Yes
682-38	TD sensor communication error: Verification error:C	Yes
682-39	TD sensor communication error: Verification error:Y	Yes
687-00	PER Not Received Error	Yes

SC700

SC code	Name	Automatic Reboot
700-01	SPDF: Base Plate Lift Motor Error	Yes
700-02	SPDF: Original Pick-up Error	Yes
700-04	SPDF: Paper Feed Motor Error	Yes
700-05	SPDF: Pullout Motor Error	Yes
700-06	SPDF: Intermediate Motor Error	Yes
700-07	SPDF: Scanning Motor Error	Yes
700-09	SPDF: Paper Exit Motor Error	Yes
701-03	SPDF: Paper Feed Motor Driver Error	Yes
701-08	SPDF: Paper Exit Motor Driver Error	Yes
702-01	ARDF: Protection Device Intercept Error 1	Yes
702-02	ARDF: Protection Device Intercept Error 2	Yes
702-03	ARDF: Protection Device Intercept Error 3	Yes
702-04	SPDF: Protection Device Intercept Error 4	Yes
702-05	SPDF: Protection Device Intercept Error 5	Yes
703-01	Double Feed Sensor error (SPDF)	No
720-03	Protection Device Intercept Error 1	No
720-06	Access error to NVRAM	No
720-10	Entrance Transport Motor Error	No
720-11	Horizontal Transport Motor Error	No
720-13	Intermediate Transport Motor Error	No
720-15	Prestack Transport Motor Error	No

5.Troubleshooting

SC code	Name	Automatic Reboot
720-17	Paper Exit Motor Error	No
720-20	Lower Junction Gate Motor Error	No
720-24	Paper Exit Open/Close Guide Plate Motor Error	No
720-25	Punching Motor Error	No
720-27	Punch Displacement Motor Error	No
720-28	Horizontal Registration Detection Displacement Motor Error	No
720-30	Jogger Motor Error	No
720-33	Positioning Roller Drive Motor Error	No
720-34	Positioning Transport Motor Error	No
720-35	Rear End Press Motor Error	No
720-41	Release Motor Error	No
720-42	Edge Stapler Retreat Motor Error	No
720-44	Edge Stapler Motor Error	No
720-50	Booklet Jogger Motor Error	No
720-51	Booklet Adjustment Claw Displacement Motor Error	No
720-52	Press Folding Motor Error	No
720-53	Booklet Reference Fence Motor Error	No
720-54	Folding Transport Motor Error	No
720-60	Booklet Stapler Motor Error	No
720-70	Folding Transport Motor Error	No
720-71	Shift Motor Error	No
720-72	Shift Jogger Front Motor Error	No
720-73	Shift Jogger Rear Motor Error	No
720-74	Shift Jogger Retreat Motor Error	No
720-75	Reverse Roller Rocking Motor Error	No
720-80	Protection Device Intercept Error 3	No
720-81	Transfer Roller Transport Motor Error	No
720-82	Edge Guide Motor Error	No
720-83	Paper Guide Motor Error	No
721-03	Protection Device Intercept Error 1	No
721-04	Protection Device Intercept Error 2	No
721-06	Access error to NVRAM	No
721-10	Transport Motor 1 Error	No
721-11	Transport Motor 2 Error	No
721-17	Paper Eject Motor 2 Error	No
721-24	Paper Exit Guide Plate Open/Close motor Error	No

5.Troubleshooting

SC code	Name	Automatic Reboot
721-25	Punch Drive Motor Error	No
721-27	Punch Movement Motor Error	No
721-28	Punch Horizontal Registration Detection Error	No
721-30	Jogger Motor 1 Error	No
721-33	Positioning Roller Motor Error	No
721-41	Release Motor Error	No
721-42	Stapler Retreat Motor Error	No
721-44	Stapler Motor Error	No
721-52	Folding Plate Drive Motor Error	No
721-53	Rear End Fence Displacement Motor Error	No
721-58	Bundle Transport 1 Release Motor Error	No
721-59	Bundle Transport 2 Release Motor Error	No
721-70	Tray 1 Lift Motor Error	No
721-71	Shift Motor 1 Error	No
721-80	Folding Transport Motor Error	No
721-81	Paper Guide Drive Motor Error	No
722-03	Protection Device Intercept Error 1	No
722-04	Protection Device Intercept Error 2	No
722-06	See the deriptions next table below.	No
722-10	Transport Motor 1 Error	No
722-11	Transport Motor 2 Error	No
722-17	Paper Eject Motor 2 Error	No
722-24	Paper Exit Guide Plate Open/Close motor Error	No
722-25	Punch Drive Motor Error	No
722-27	Punch Movement Motor Error	No
722-28	Punch Horizontal Registration Detection Error	No
722-30	Jogger Motor 1 Error	No
722-33	Positioning Roller Motor Error	No
722-41	Release Motor Error	No
722-42	Stapler Retreat Motor Error	No
722-44	Stapler Motor Error	No
722-45	Stapleless Stapler Transfer Motor Error	No
722-46	Stapleless Stapler Motor Error	No
722-47	Paper Guide Drive Motor Error	No
722-70	Tray 1 Lift Motor Error	No
722-71	Shift Motor 1 Error	No

5.Troubleshooting

SC code	Name	Automatic Reboot
722-81	Paper Guide Motor	No
723-03	Power Supply Error	No
723-10	Transport Motor Error	No
723-20	Junction Gate Motor Error	No
723-24	Exit Paper Pressure Motor Error	No
723-44	Stapler Motor Error	No
723-71	Shift Motor Error	No
724-03	Protection Device Intercept Error 1 (Internal Finisher)	No
724-04	Protection Device Intercept Error 2 (Internal Finisher)	No
724-24	Paper Exit Guide Plate Open/Close Motor Error	No
724-25	Punch Motor Error	No
724-27	Punch Displacement Motor Error	No
724-28	Punch Horizontal Registration Detection Motor Error	No
724-31	Jogger Front Motor Error	No
724-32	Jogger Rear Motor Error	No
724-33	Positioning Roller Motor Error	No
724-38	Paper Press Motor Error	No
724-42	Stapler Displacement Movable Motor Error	No
724-70	Shift Tray Lift/Descent Motor Error	Not
724-71	Shift Motor Error (Internal Shift Tray SH3080)	No
724-80	Shift Motor Error	No
724-81	Cooling Fan Motor Lock	No
724-86	Stapler Motor Error	No
727-01	Connection Error to Downstream Unit	No
727-03	Protection Device Intercept Error 1	No
727-04	Protection Device Intercept Error 2	No
727-06	NVRAM Error 1	No
727-10	Transport Motor Error	No
727-12	Registration Motor Error	No
727-20	JG Crease Motor Error 1	No
727-39	1st Fold Motor Error	No
727-41	JG Crease Motor Error 2	No
727-71	2nd Fold Motor Error	No
727-72	The power supply for the sensor is defective.	No
761-03	Protection Device Intercept Error 5V	No
761-04	Protection Device Intercept Error 24V	No

SC code	Name	Automatic Reboot
780-01	Bank 1 (Upper optional paper tray) Protection Device Intercept Error	Yes
781-01	Bank 2 (Lower optional paper tray) Protection Device Intercept Error	Yes
791-00	No bridge unit when finisher is present	No
792-00	No finisher, bridge unit provided	No

SC900

SC code	Name	Automatic Reboot
940-01	Toner supply motor (K) defective	No
940-02	Toner supply motor (C) defective	No
940-03	Toner supply motor (M) defective	No
940-04	Toner supply motor (Y) defective	No
940-50	Key counter device defective	No
940-81	Load SW1: Overcurrent detection	No
940-82	Load SW2: Overcurrent detection	No
940-83	Load SW3: Overcurrent detection	No
995-01	CPM setting error 1	No
995-02	CPM setting error 2	No
995-03	CPM setting error 3	No
995-04	CPM setting error 4	No

Controller SC

For details of Automatic reboot, refer to [SC Automatic Reboot](#).

SC600

SC code	Name	Automatic reboot
632-00	Counter device error 1	Yes
633-00	Counter device error 2	Yes
634-00	Counter device error 3	Yes
635-00	Counter device error 4	Yes

5.Troubleshooting

SC code	Name	Automatic reboot
636-01	IC Card Error (Expanded authentication module error)	Yes
636-02	IC Card Error (Version error)	Yes
637-01	Tracking Information Notification Error (Tracking application error)	Yes
637-02	Tracking Information Notification Error (Management server error)	Yes
641-00	Communication error between BICU and Controller board	Yes
641-01	Communication error between BICU and Controller board: Timeout	Yes
641-02	Communication error between BICU and Controller board: retry over	Yes
641-03	Communication error between BICU and Controller board: download error	Yes
641-04	Communication error between BICU and Controller board: UART error	Yes
650-01	Remote Service Modem Communication Error (Dialup authentication failure)	No
650-04	Remote Service Modem Communication Error (dialup failing because of incorrect modem configuration)	No
650-05	Remote Service Modem Communication Error (insufficient current or connection error)	No
650-13	Remote Service Modem Communication Error (RC Gate Type M was installed but modem is not present (detected during operation))	No
650-14	Remote Service Modem Communication Error (RC Gate Type N was installed but modem is present or wired/wireless LAN is not working correctly)	No
651-01	Illegal Remote Service Dial-up (Chat program parameter error)	No
651-02	Illegal Remote Service Dial-up (Chat program execution error)	No
652-00	Remote service ID2 mismatching	No
653-00	Incorrect remote service ID2	No

SC code	Name	Automatic reboot
670-01	Engine does not start up during the starting up	Yes
670-02	Engine does not start up after the starting up	Yes
670-03	IPU power does not start up	Yes
670-04	Communication is not linked up	Yes
670-05	Link up error	No
672-00	Controller start up error	No
672-10	Controller start up error	No
672-11	Controller start up error	No
672-12	Controller start up error	No
672-13	Controller start up error	No
672-20	Controller start up error	No
672-21	Controller start up error	No
673-10	Operation panel Flair communication error (Smart Operation Panel)	No
674-01	Transfer Error (M2P error)	Yes
674-02	Transfer Error (PCI error)	Yes

SC800

SC code	Name	Automatic reboot
816-00	Energy save I/O subsystem error	Yes
816-01	Subsystem error	Yes
816-02	Sysarch (LPUX_GET_PORT_INFO) error	Yes

5.Troubleshooting

SC code	Name	Automatic reboot
816-03	Transition to STR was denied.	Yes
816-04	Interrupt in kernel communication driver	Yes
816-05	Preparation for transition to STR failed.	Yes
816-06	Preparation for transition to STR failed.	No
816-07	Sysarch (LPUX_GET_PORT_INFO) error	Yes
816-08	Sysarch (LPUX_ENGINE_TIMERCTRL) error	Yes
816-09	Sysarch (LPUX_RETURN_FACTOR_STR) error	Yes
816-10 to 12	Sysarch (LPUX_GET_PORT_INFO) error	Yes
816-13	open() error	Yes
816-14	Memory address error	Yes
816-15 to 18	open() error	Yes
816-19	Double open() error	Yes
816-20	open() error	Yes
816-22	Parameter error	Yes
816-23	read() error	Yes
816-24	read() error	Yes
816-25	write () error	Yes
816-26	write() communication retry error	Yes
816-27	write() communication retry error	Yes
816-28	write() communication retry error	Yes
816-29	read() communication retry error	Yes
816-30	read() communication retry error	Yes
816-35	read() error	Yes
816-36 to 69	Subsystem error	Yes
816-70	Subsystem error	No
816-71 to 94	Subsystem error	Yes
816-95	Subsystem error	No
816-96	Subsystem error	No
816-98	Subsystem error	Yes
817-00	Monitor error: File detection / Digital signature error	No
818-00	Watchdog timer error	Yes
819-00	Kernel halt error	No

SC code	Name	Automatic reboot
821-00	Self-diagnostics error: ASIC	Yes
822-00	Self-diagnostic error: HDD	No
823-00	Self-diagnostics error: NIC	Yes
824-00	Self-diagnostics error: NVRAM (resident)	No
827-00	Self-diagnostics error: RAM	Yes
828-00	Self-diagnostics error: ROM	Yes
829-00	Self-diagnostics error: Optional Serial	Yes
833-00	Self-diagnostic error: Engine I/F ASIC	Yes
834-00	Self-diagnostic error: Optional memory	No
838-00	Self-diagnostic Error: Clock Generator	No
839-00	Self-diagnostic Error: Serial Flash	Yes
840-00	EEPROM access error	Yes
841-00	EEPROM read data error	Yes
842-00	Nand-Flash updating verification error	No
842-01	Insufficient Nand-Flash blocks (threshold exceeded)	No
842-02	Number of Nand-Flash block deletions exceeded	No
843-02	eMMC rewrite frequency exceeded the threshold (Smart Operation Panel)	No
845-01	Engine Board	No
845-02	Controller Board	No
845-03	Operation Panel (Normal)	No
845-04	Operation Panel (Smart Panel)	No
845-05	FCU	No
845-50	DMM or hard disk failure	Yes
845-51	Network, DIMM or hard disk failure	No
850-00	Network I/F Error	Yes
851-00	IEEE 1394 I /F error	No
855-01	Wireless LAN board error (driver attachment failure)	No
855-02	Wireless LAN board error (driver initialization failure)	No
857-00	USB I/F Error	No
858-00	Data encryption conversion error (Key Setting Error)	No
858-01	Data encryption conversion error (HDD Key Setting Error)	No
858-02	Data encryption conversion error (NVRAM Read/Write Error)	No
858-30	Data encryption conversion error (NVRAM Before Replace Error)	No
858-31	Data encryption conversion error (Other Error)	No
859-00	Data encryption conversion HDD conversion error	No
859-01	Data encryption conversion HDD conversion error (HDD check error)	No

5.Troubleshooting

SC code	Name	Automatic reboot
859-02	Data encryption conversion HDD conversion error (Power failure during conversion)	No
859-10	Data encryption conversion HDD conversion error (Data read/write command error)	No
860-00	HDD startup error at main power on (HDD error)	No
860-01	HDD file system error at main power on (HDD error)	No
860-02	HDD label error at main power on (HDD error)	No
860-03	HDD encryption key error at main power on (HDD error)	No
861-00	HDD re-try failure	Yes
862-00	Number of the defective sector reaches the maximum count	Yes
863-00 to 23	HDD data read failure	Yes
864-00 to 23	HD data CRC error	Yes
865-00 to 23	HDD access error	Yes
865-50 to 73	HDD time-out error	Yes
866-00	SD card authentication error	No
867-00	SD card removed	No
867-01	SD card removed	No
867-02	SD card removed	No
868-00 to 02	SD card authentication error	Yes
869-01	Continuously detecting malfunction	No
869-02	Continuously non-detecting malfunction	No
870-00 to 60	Address Book data error	No
871-01	FCU error	Yes
871-02	FCU job error (Recovery possible)	Yes
871-03	FCU job error (Recovery not possible)	No
872-00	HDD mail reception error	No
873-00	HDD mail reception error	No
874-XX	Delete all error	No
875-01	Delete all error (HDD erasure) (hddcheck -i error)	Yes
875-02	Delete all error (HDD erasure) (Data deletion failure)	Yes

SC code	Name	Automatic reboot
875-03	Delete all error (HDD erasure)	Yes
876-00	Log Data Error	No
876-01	Log Data Error 1	No
876-02	Log Data Error 2	No
876-03	Log Data Error 3	No
876-04	Log Data Error 4	No
876-05	Log Data Error 5	No
877-00	Data Overwrite Security card error	No
878-00	TPM authentication error	No
878-01	USB flash error	No
878-02	TPM error	No
878-03	TCSD error	No
878-20	DESS self-test error	Yes
878-21	Random Number Generator Error	Yes
880-00	MLB error	Yes
882-01	Smart Operation panel software error	No
890-01	PaaS* function: Tampering detection	No
890-02	PaaS function: Suspended	No
899-00	Software performance error (signal reception end)	Yes

SC900

SC code	Name	Automatic reboot
900-00	Electric counter error	No
910-00	External controller error 1	No
910-XX	External controller error	No
911-XX	External controller error 2	No
912-00	External controller error	No
913-00	External controller error	No
914-00	External controller error	No
919-00	External controller down	Yes
920-02	Printer error (WORK memory not acquired)	No
920-04	Printer error (Filter process not started)	No
921-00	Printer error (Resident font not found)	No
925-00	NetFile function error	No
925-01	HDD defective	No

5. Troubleshooting

SC code	Name	Automatic reboot
990-00	Software operation error	Yes
991-00	Recoverable software operation error	No
992-00	Undefined SC issued.	Yes
994-00	Operation error caused by abnormalities that are normally undetectable.	No
997-00	Application function selection error	Yes
998-00	Application start error	Yes

SC Code Classification

The table shows the classification of the SC codes:

Class	Section
SC1xx	Scanning
SC2xx	Exposure
SC3xx	Image Processing 1
SC4xx	Image Processing 2
SC5xx	Paper feed and Fusing
SC6xx	Communication
SC7xx	Peripherals
SC8xx	Overall System
SC9xx	Others

SC100 (Engine: Scanning)

SC No.	Type	Error Name/Error Condition/Major Cause/Solution
SC101-01	D	LED Error (Scanning)
		The white level peak did not reach the prescribed threshold when the white guide plate was scanned.
		<ul style="list-style-type: none"> • Condensation in scanner unit • Connector defective (disconnected, loose) • Scanner Carriage defective • Harness defective • White Reference Seal dirty or installed incorrectly (sheet-through exposure glass) • White Guide Plate, or White Roller dirty or installed incorrectly (SPDF/ARDF) • BICU defective
		<p>Check if the SC occurs by turning the power OFF then ON. If the SC occurs again, do the following steps. Check if the SC reoccurs by cycling the power after each step.</p> <ol style="list-style-type: none"> 1. Clean the white guide plate, or white roller (SPDF/ARDF). 2. Reconnect the following connectors: <ul style="list-style-type: none"> • Scanner Carriage - BICU harness (FFC) • SBU - LEDB harness (FFC) 3. Check the white reference seal that attached back of sheet-through exposure glass. Replace the sheet-through exposure glass, if dirty or damaged. 4. Replace the white guide plate, or white roller (SPDF/ARDF). 5. Replace the Scanner Carriage. 6. Replace the following harnesses: <ul style="list-style-type: none"> • Scanner Carriage - BICU harness (FFC) 7. Replace the BICU (PCB10).
SC101-02	D	LED Error (LED illumination adjustment)
		LED error was detected.
		<ul style="list-style-type: none"> • Condensation in scanner unit • Connector defective (disconnected, loose) • Scanner Carriage defective • Harness defective • White Reference Seal dirty or installed incorrectly (sheet-through exposure

5.Troubleshooting

SC No.	Type	Error Name/Error Condition/Major Cause/Solution
		<p>glass)</p> <ul style="list-style-type: none"> • BICU defective
		<p>Check if the SC occurs by turning the power OFF then ON. If the SC occurs again, do the following steps. Check if the SC reoccurs by cycling the power after each step.</p> <ol style="list-style-type: none"> <u>1.</u> Reconnect the following connectors: <ul style="list-style-type: none"> • Scanner Carriage - BICU harness (FFC) • SBU - LEDB harness (FFC) <u>2.</u> Check the white reference seal that attached back of sheet-through exposure glass. Replace the sheet-through exposure glass, if dirty or damaged. <u>3.</u> Replace the Scanner Carriage.f <u>4.</u> Replace the following harnesses: <ul style="list-style-type: none"> • Scanner Carriage - BICU harness (FFC) <u>5.</u> Replace the BICU (PCB10).

SC No.	Type	Error Name/Error Condition/Major Cause/Solution
SC102-00	D	<p>LED Illumination Adjustment Error</p> <p>The white level peak reached the prescribed threshold when the white plate was scanned after a specified number of adjustments.</p> <ul style="list-style-type: none"> • Connector defective (disconnected, loose) • Scanner Carriage defective • Harness defective • BICU defective <p>Check if the SC occurs by turning the power OFF then ON. If the SC occurs again, do the following steps. Check if the SC reoccurs by cycling the power after each step.</p> <ol style="list-style-type: none"> <u>1.</u> Reconnect the following connectors: <ul style="list-style-type: none"> • Scanner Carriage - BICU harness (FFC) • SBU - LEDB harness (FFC) <u>2.</u> Check the white reference seal that attached back of sheet-through exposure glass. Replace the sheet-through exposure glass, if dirty or damaged. <u>3.</u> Replace the Scanner Carriage. <u>4.</u> Replace the following harnesses: <ul style="list-style-type: none"> • Scanner Carriage - BICU harness (FFC) <u>5.</u> Replace the BICU (PCB10).

SC No.	Type	Error Name/Error Condition/Major Cause/Solution
SC120-	D	Scanner Home Position Error 1

SC No.	Type	Error Name/Error Condition/Major Cause/Solution
00		<p>The scanner home position sensor (S42) does not go OFF.</p> <p>Details:</p> <p>Error detection timing</p> <ul style="list-style-type: none"> • During homing (when the machine is turned ON or when it returns from energy saving mode) • During an automatic adjustment (when the machine is turned ON or when it returns from energy saving mode) • During a scan from the ADF/ARDF or exposure glass.
		<ul style="list-style-type: none"> • Scanner motor driver defective • Scanner motor (M26) defective • Scanner home position sensor (S42) defective • Harness defective • Timing belt, pulley, wire, or carriage not installed correctly
		<p>Check if the SC occurs by turning the power OFF then ON. If the SC occurs again, do the following steps.</p> <p>1. Replace the following parts:</p> <ul style="list-style-type: none"> • Replace the HP sensor • Replace the scanner motor (M26) • Replace the harness.

SC No.	Type	Error Name/Error Condition/Major Cause/Solution
SC121-00	D	<p>Scanner Home Position Error 2</p> <p>The scanner home position sensor (S42) does not go ON.</p> <p>Details:</p> <p>Error detection timing</p> <ul style="list-style-type: none"> • During homing • During an automatic adjustment • During a scan from the ADF/ARDF or exposure glass.
		<ul style="list-style-type: none"> • Scanner motor driver defective • Scanner motor defective • Scanner home position sensor (S42) defective • Harness defective • Timing belt, pulley, wire, or carriage not installed correctly
		<p>Check if the SC occurs by turning the power OFF then ON. If the SC occurs again, do the following steps.</p> <p>1. Replace the following parts:</p> <ul style="list-style-type: none"> • Replace the scanner home position sensor (S42). • Replace the scanner motor (M26)

5.Troubleshooting

SC No.	Type	Error Name/Error Condition/Major Cause/Solution
		<ul style="list-style-type: none"> • Replace the harness.

SC No.	Type	Error Name/Error Condition/Major Cause/Solution
SC141-00	D	Black level detection error
		The black level cannot be reached the target during auto gain control.
		<ul style="list-style-type: none"> • Scanner Carriage defective • Harness defective • BICU defective
		<p>Check if the SC occurs by turning the power OFF then ON. If the SC occurs again, do the following steps. Check if the SC reoccurs by cycling the power after each step.</p> <ol style="list-style-type: none"> <u>1.</u> Reconnect the following connectors: <ul style="list-style-type: none"> • Scanner Carriage - BICU harness (FFC) <u>2.</u> Replace the Scanner Carriage. <u>3.</u> Replace the following harnesses: <ul style="list-style-type: none"> • Scanner Carriage - BICU harness (FFC) <u>4.</u> Replace the BICU (PCB10).

SC No.	Type	Error Name/Error Condition/Major Cause/Solution
SC142-00	D	White level detection error
		The white level cannot be adjusted to the second target level within the target during auto gain control.
		<ul style="list-style-type: none"> • Condensation in scanner unit • Scanner Carriage defective • Harness defective • Connector defective (disconnected, loose) • White plate dirty or installed incorrectly
		<p>Check if the SC occurs by turning the power OFF then ON. If the SC occurs again, do the following steps. Check if the SC reoccurs by cycling the power after each step.</p> <ol style="list-style-type: none"> <u>1.</u> Reconnect the following connectors: <ul style="list-style-type: none"> • Scanner Carriage - BICU harness (FFC) • SBU - LEDB harness (FFC) <u>2.</u> Check the white reference seal that attached back of sheet-through exposure glass. Replace the sheet-through exposure glass, if dirty or damaged.

SC No.	Type	Error Name/Error Condition/Major Cause/Solution
		<ol style="list-style-type: none"> 3. Replace the scanner carriage. 4. Replace the following harnesses: <ul style="list-style-type: none"> • Scanner Carriage - BICU harness (FFC) 5. Replace the BICU (PCB10).

SC No.	Type	Error Name/Error Condition/Major Cause/Solution
SC144-00	D	SBU Communication Error
		<ul style="list-style-type: none"> • The machine cannot detect that the Scanner Carriage is connected. • The machine cannot communicate with the Scanner Carriage. • The communication data is incorrect.
		<ul style="list-style-type: none"> • Scanner Carriage defective • BICU defective • Harness defective
		<p>Check if the SC occurs by turning the power OFF then ON. If the SC occurs again, do the following steps. Check if the SC reoccurs by cycling the power after each step.</p> <ol style="list-style-type: none"> 1. Reconnect the following connectors: <ul style="list-style-type: none"> • Scanner Carriage - BICU harness (FFC) 2. Replace the Scanner Carriage. 3. Replace the BICU (PCB10). 4. Replace the following harnesses: <ul style="list-style-type: none"> • Scanner Carriage - BICU harness (FFC)

SC No.	Type	Error Name/Error Condition/Major Cause/Solution
SC151-00	D	Black Level Error: Side 2
		The black level scanned is not specified range.
		<ul style="list-style-type: none"> • CIS for SPDF defective • SPDF main board defective • Harness defective
		<p>Check if the SC occurs by turning the power OFF then ON. If the SC occurs again, do the following steps. Check if the SC reoccurs by cycling the power after each step.</p> <ol style="list-style-type: none"> 1. Reconnect the SPDF main board - CIS connectors if they are disconnected, or loose. 2. Replace the CIS for SPDF 3. Replace the following harnesses:

5.Troubleshooting

SC No.	Type	Error Name/Error Condition/Major Cause/Solution
		<ul style="list-style-type: none"> • SPDF main board - CIS • BICU -SPDF main board <p>4. Replace the SPDF main board.</p>

SC No.	Type	Error Name/Error Condition/Major Cause/Solution
SC152-00	D	White Level Error: Side 2
		<ul style="list-style-type: none"> • The shading data peak value read out from the CIS is not specified range from the target value.
		<ul style="list-style-type: none"> • CIS defective • White roller defective • SPDF main board defective • Harness defective
		<p>Check if the SC occurs by turning the power OFF then ON. If the SC occurs again, do the following steps. Check if the SC reoccurs by cycling the power after each step.</p> <p>1. Reconnect the SPDF main board - CIS connectors if they are disconnected, or loose.</p> <p>2. Replace the CIS for SPDF</p> <p>3. Replace the following harnesses:</p> <ul style="list-style-type: none"> • SPDF main board - CIS • BICU -SPDF main board <p>4. Replace the SPDF main board.</p>

SC No.	Type	Error Name/Error Condition/Major Cause/Solution
SC154-00	D	Scanner Communication Error: Side 2
		The value read out from the ASIC and FROM area inside the CIS is different from the expected value.
		<ul style="list-style-type: none"> • CIS defective • "FROM" area error • SPDF main board defective • Connector defective (loose, broken)
		<p>Check if the SC occurs by turning the power OFF then ON. If the SC occurs again, do the following steps. Check if the SC reoccurs by cycling the power after each step.</p> <p>1. Reconnect the SPDF main board - CIS connectors if they are disconnected, or</p>

SC No.	Type	Error Name/Error Condition/Major Cause/Solution
		<p>loose.</p> <p>2. Replace the CIS for SPDF</p> <p>3. Replace the following harnesses:</p> <ul style="list-style-type: none"> • SPDF main board - CIS • BICU -SPDF main board <p>4. Replace the SPDF main board.</p>

SC No.	Type	Error Name/Error Condition/Major Cause/Solution
SC161-02	D	<p>IPU (BICU) error (Lsync Error: Side 2)</p> <p>The machine detects the error from the results of self-diagnostic test before scanning the side 2.</p> <ul style="list-style-type: none"> • harness defective between CIS and BICU (disconnected, loose) • CIS defective • BICU defective (ASIC: Macaron error) <p>Check if the SC occurs by turning the power OFF then ON. If the SC occurs again, do the following steps. Check if the SC reoccurs by cycling the power after each step.</p> <p>1. Reconnect the BICU - CIS connectors if they are disconnected, or loose.</p> <p>2. Replace the CIS for SPDF.</p> <p>3. Replace the BICU - CIS harness.</p> <p>4. Replace the BICU (PCB10).</p>

SC No.	Type	Error Name/Error Condition/Major Cause/Solution
SC161-20	D	<p>IPU (BICU) error (DRAM initialization failure)</p> <p>An error occurred during performed every time the machine is turned on, or returns to full operation from energy saving mode.</p> <ul style="list-style-type: none"> • BICU defective (Macaron/ DRAM device connection error) • DRAM device defective <p>Check if the SC occurs by turning the power OFF then ON. If the SC occurs again, do the following steps. Check if the SC reoccurs by cycling the power after each step.</p> <p>1. Reconnect the all connectors on BICU board if they are disconnected, or loose.</p> <p>2. Replace the BICU (PCB10).</p>

SC No.	Type	Error Name/Error Condition/Major Cause/Solution
SC195-	D	Machine serial number error

5.Troubleshooting

SC No.	Type	Error Name/Error Condition/Major Cause/Solution
00		Comparison of the product identification code in the machine serial number (11 digits).
		The product identification code in the machine serial number (11 digits) does not match.
		Re-enter the machine serial number.

SC200 (Engine: Image Writing)

SC No.	Type	Error Name/Error Condition/Major Cause/Solution
SC202-00	D	Polygon Motor: ON Timeout Error
		After the polygon mirror motor (M27) turned on, or within the specified time (sec.) after the rpm's changed, the motor did not turn normally.
		<ul style="list-style-type: none"> • Polygon mirror motor (M27) or polygon motor driver defective • The interface harness to the polygon motor driver damaged or not connected correctly. • BICU defective • Polygon mirror motor (M27) drive pulse cannot be output correctly. (Polygon controller) • PSU defective (polygon power supply, fuse defective) • AC power supply voltage error
		<ol style="list-style-type: none"> 1. Check if the SC occurs by turning the power OFF then ON with the front door open. If the SC occurs again, do the following steps. 2. Reconnect the following connectors: <ul style="list-style-type: none"> • Laser Unit - BICU • Paper Transport IOB - BICU (CN587 / CN574 connectors on the BICU) 3. Reconnect the relay connector of the laser unit. 4. Replace the polygon mirror motor (M27). 5. Replace the BICU (PCB10). 6. Replace the harness between the laser unit and the BICU. 7. Replace the laser unit. 8. Check the output voltage (if there are any defects, replace the fuse). 9. Check the following harnesses: <ul style="list-style-type: none"> • Paper Transport IOB - BICU • Paper Transport IOB - PSU (CN164/CN152) 10. Replace the harness between the BICU and the Paper Transport IOB.

SC No.	Type	Error Name/Error Condition/Major Cause/Solution
SC203-00	D	Polygon Motor: OFF Timeout Error
		The polygon motor fails to stop within the specified time after receiving the signal to stop.
		<ul style="list-style-type: none"> • Polygon mirror motor (M27) or polygon motor driver defective • The interface harness to the polygon motor driver damaged or not connected

5.Troubleshooting

SC No.	Type	Error Name/Error Condition/Major Cause/Solution
		<p>correctly.</p> <ul style="list-style-type: none"> • BICU defective
		<ol style="list-style-type: none"> <u>1.</u> Check if the SC occurs by turning the power OFF then ON. If the SC occurs again, do the following steps. <u>2.</u> Check the following harnesses: <u>3.</u> Laser Unit - BICU (CN587/CN574 connectors on the BICU) <u>4.</u> Replace the polygon mirror motor (M27). <u>5.</u> Replace the BICU (PCB10). <u>6.</u> Replace the harness between the laser unit and the BICU. <u>7.</u> Replace the laser unit.

SC No.	Type	Error Name/Error Condition/Major Cause/Solution
SC204-00	D	<p>Polygon Motor: XSCRDY Signal Error</p> <p>The polygon motor fails to rotate correctly when running (printing).</p> <ul style="list-style-type: none"> • The interface harness to the polygon motor driver damaged or not connected correctly. • Polygon mirror motor (M27) or polygon motor driver defective • BICU defective • PSU defective • AC power supply voltage error <p>Check if the SC occurs by turning the power OFF then ON. If the SC occurs again, do the following steps. Check if the SC reoccurs by cycling the power after each step.</p> <ol style="list-style-type: none"> <u>1.</u> Reconnect the following connectors: <ul style="list-style-type: none"> • Laser Unit - BICU • Paper Transport IOB - BICU (CN587 / CN574 connectors on the BICU) <u>2.</u> Reconnect the relay connector of the laser unit. <u>3.</u> Replace the polygon mirror motor (M27). <u>4.</u> Replace the BICU (PCB10). <u>5.</u> Replace the harness between the laser unit and the BICU. <u>6.</u> Replace the laser unit. <u>7.</u> Check the output voltage (if there are any defects, replace the fuse). <u>8.</u> Check the following harnesses: <ul style="list-style-type: none"> • Paper Transport IOB - BICU • Paper Transport IOB - PSU (CN164/CN152) <u>9.</u> Replace the harness between the BICU and the Paper Transport IOB.

SC No.	Type	Error Name/Error Condition/Major Cause/Solution
SC220-01	D	Leading Edge: LD1 synchronization detection error: Bk
SC220-04	D	Leading Edge: LD1 synchronization detection error: Ye
		<p>The synchronization detection signal (periodic write/scan signal) absent.</p> <ul style="list-style-type: none"> • The interface harness to the synchronization detection unit damaged or not connected correctly. • Synchronization detection board defective • Beam does not enter photo detector. • LDB defective <ol style="list-style-type: none"> 1. Check if the SC occurs by turning the power OFF then ON. If the SC occurs again, do the following steps. 2. Remove the laser unit, and then check for condensation. 3. Reconnect the connectors between LDB (Synchronizing detector board) and BICU. 4. Replace the BICU (PCB10). 5. Replace the Laser unit. 6. Replace the harness between LDB (Synchronizing detector board) and BICU.

SC No.	Type	Error Name/Error Condition/Major Cause/Solution
SC230-01	D	FGATE ON error: Bk
SC230-02	D	FGATE ON error: Cy
SC230-03	D	FGATE ON error: Ma
SC230-04	D	FGATE ON error: Ye
		<p>Write image length signal (FGATE signal) absent even at the time to start writing.</p> <ul style="list-style-type: none"> • BICU defective • Harness between BICU and controller board defective <ol style="list-style-type: none"> 1. Check if the SC occurs by turning the power OFF then ON. If the SC occurs again, do the following steps. 2. Reconnect the connectors between BICU and controller board. 3. Replace the BICU (PCB10). 4. Replace the controller board (PCB11).

5.Troubleshooting

SC No.	Type	Error Name/Error Condition/Major Cause/Solution
		5. In the case of image quality degradation (horizontal streaks), also check SC220.

SC No.	Type	Error Name/Error Condition/Major Cause/Solution
SC231-01	D	FGATE OFF error: Bk
SC231-02	D	FGATE OFF error: Cy
SC231-03	D	FGATE OFF error: Ma
SC231-04	D	FGATE OFF error: Ye
		Write image length signal (FGATE signal) absent even at the time to start writing.
		<ul style="list-style-type: none"> • BICU defective • Harness between BICU and controller board defective
		<ol style="list-style-type: none"> 1. Check if the SC occurs by turning the power OFF then ON. If the SC occurs again, do the following steps. 2. Reconnect the connectors between BICU and controller board. 3. Replace the BICU (PCB10). 4. Replace the controller board (PCB11).

SC No.	Type	Error Name/Error Condition/Major Cause/Solution
SC240-01	D	LD error: Bk
SC240-02	D	LD error: Cy
SC240-03	D	LD error: Ma
SC240-04	D	LD error: Ye
		<ul style="list-style-type: none"> • If LD error terminal of LD driver of corresponding color is asserted after LD initialization. • If an error is detected during initialization of LD driver which detects lth/leta of LD of corresponding color.
		<ul style="list-style-type: none"> • LD degradation (LD broken, shift of output characteristics etc.) • The interface harness damaged or not connected correctly. • LD driver defective

SC No.	Type	Error Name/Error Condition/Major Cause/Solution
		<p>1. Check if the SC occurs by turning the power OFF then ON. If the SC occurs again, do the following steps.</p> <p>2. Check the value in SP2-110-001 to 004 (LD Driver), the default is "0h".</p> <ul style="list-style-type: none"> • If current value is "0", perform step 4. • If current value is "1", perform steps 3 and 5. • If current value is "2" to "FF", perform step 4. <p>3. Reconnect the connectors between LDB and BICU. (CN579 / CN580 / CN581 / CN582 / CN583 / CN584 / CN588 / CN589 connectors on the BICU, and relay connector of the laser unit)</p> <p>4. Replace the Laser unit</p> <p>5. Replace the harness between LDB to BICU.</p>

SC No.	Type	Error Name/Error Condition/Major Cause/Solution
SC272-01	D	LD driver communication error: Bk
SC272-02	D	LD driver communication error: Cy
SC272-03	D	LD driver communication error: Ma
SC272-04	D	LD driver communication error: Ye
		<p>Communication between the CPU and LD driver was not performed correctly.</p> <ul style="list-style-type: none"> • LDB defective • BICU defective • Harness defective <p>Check if the SC occurs by turning the power OFF then ON. If the SC occurs again, do the following steps. Check if the SC reoccurs by cycling the power after each step.</p> <p>1. Reconnect the following connectors:</p> <ul style="list-style-type: none"> • LDB - BICU (CN583/CN584/CN588/CN589 connectors on the BICU, and relay connector of the laser unit) <p>2. Replace the BICU (PCB10).</p> <p>3. Replace the laser unit.</p> <p>4. Replace the following harness:</p> <ul style="list-style-type: none"> • LDB - BICU harness

5.Troubleshooting

SC No.	Type	Error Name/Error Condition/Major Cause/Solution
SC272-10	D	LD driver communication error: Other
		LD voltage does not satisfy the specified voltage (5 V).
		<ul style="list-style-type: none"> • BICU defective (LD5V Power error) • LDB defective (LD drive error) • LDB connector defective (loose, broken) • Interlock switch defective
		<p>1. Check if the SC occurs by turning the power OFF then ON. If the SC occurs again, do the following steps.</p> <p>2. Check SP2-110-010. In the case of lower 3-bit 111: Power supply voltage is normal => Perform Step 4, 8, 10, and then 9. In the case of lower 3-bit 100: BISU/LSU error => Perform Step 8 and then 9, and then perform Step 2 again. In the case of lower 3-bit 110: Writing unit error / harness error => Perform Step 4, 9, 10, and then 8. In the case of lower 3-bit 000: Voltage defect / power supply line defect between IOB and BICU => Perform Step 4, 5, 6, and then 7, and then perform Step 2 again.</p> <p>3. Disconnect the harness between the LDB and BICU (CN583/CN584/CN588/CN589 connectors on BICU), and then perform Step 1 and then 2 to check whether the value of SP changes.</p> <p>4. Reconnect the following connectors:</p> <ul style="list-style-type: none"> • LDB - BICU (CN583/CN584/CN588/CN589 connectors on the BICU, and relay connector of the laser unit) <p>5. Reconnect the following connectors:</p> <ul style="list-style-type: none"> • Laser Unit - BICU • Paper Transport IOB - BICU (CN574 on the BICU) <p>6. Check the following harnesses:</p> <ul style="list-style-type: none"> • Paper Transport IOB - BICU • Paper Transport IOB - PSU (CN164/CN152) <p>7. Check whether the interlock switch is assembled correctly.</p> <p>8. Replace the BICU (PCB10).</p> <p>9. Replace the laser unit.</p> <p>10. Replace the following harness:</p> <ul style="list-style-type: none"> • Laser Unit - BICU harness

SC No.	Type	Error Name/Error Condition/Major Cause/Solution
SC285-01	C	Skew Motor (in LD unit) Power Control Error
		The power supply from PSU is not supplied to the skew motors.
		<ul style="list-style-type: none"> • Software error • Imaging IOB defective • BICU defective
		<p>Check if the SC occurs by turning the power OFF then ON. If the SC occurs again, do the following steps. Check if the SC reoccurs by cycling the power after each step.</p> <ol style="list-style-type: none"> 1. Update the firmware. 2. Replace the imaging IOB (PCB2). 3. Replace the BICU (PCB10).

SC No.	Type	Error Name/Error Condition/Major Cause/Solution
SC285-02	C	MUSIC error
		The results of MUSIC pattern reading failed 4 times. (even if mode e (real time MUSIC) fails, the error count is not incremented (+1))
		For details about cause and solution, refer to " When SC285-02 (MUSIC Error) is displayed ".

SC No.	Type	Error Name/Error Condition/Major Cause/Solution
SC285-03	C	Insufficient MUSIC patterns
		The results of MUSIC pattern reading failed 4 times.
		For details about cause and solution, refer to " When SC285-03 (Insufficient MUSIC patterns) is Displayed ".

SC300 (Engine: Charge, Development)

SC No.	Type	Error Name/Error Condition/Major Cause/Solution
SC312-01	D	Charge Roller HVP-CB Output Error (K)
SC312-02	D	Charge Roller HVP-CB Output Error (C)
SC312-03	D	Charge Roller HVP-CB Output Error (M)
SC312-04	D	Charge Roller HVP-CB Output Error (Y)
		Charging AC is set to ON at the standard speed, and the FB voltage of the charging AC of each color is monitored for 200 ms at 20ms intervals (10 times) after 80ms of charge AC_ON, and below 0.3V is detected continuously for 200ms (10 times), the SC of the corresponding color lights up, and machine operation is suspended.
		<ul style="list-style-type: none"> • High voltage harness defective or shorted. • PCU setting fault or damage • HVP-CB fault • Connector disconnected • Harness broken • Imaging IOB defective

Check if the SC occurs by turning the power OFF then ON. If the SC occurs again, do the following steps. Check if the SC reoccurs by cycling the power after each step.

1. Check the PCU for the following points and recover or replace the PCU if there are any defects.

- Checking contaminants on the Charge Roller terminal [A]
- Checking damage or deformation of the Charge Roller terminal [A]
- Checking continuity to the Charge Roller terminal core bar [B]



2. Check if all connectors related to PCDU are connected securely. Replace the connectors if they are disconnected, or loose.

3. Recover or replace the parts of the main machine if there are any defects after checking the following points.

- Checking contaminants on the charged power supplying plate [C]
- Checking damage or deformation of the charged power supplying plate [C]

SC No.	Type	Error Name/Error Condition/Major Cause/Solution
		<ul style="list-style-type: none"> Checking continuity between the Charge Roller terminal core bar and the HVP (CB)  <p>4. Replace the HVP (CB).</p> <p>5. If SC occurs again, replace the Imaging IOB (PCB2).</p>

SC No.	Type	Error Name/Error Condition/Major Cause/Solution
SC324-01	D	<p>Development motor: Bk: Lock</p> <p>Motor status is observed at 100ms intervals during motor ON, and the unlock status is detected at least 20 times</p> <ul style="list-style-type: none"> Motor defective Connector disconnected Harness broken IOB defective Development unit torque increased <p>1. Taking care not to spill the developer, shake the development unit horizontally to spread the developer evenly.</p> <p>2. Replace the motor.</p> <p>3. Reconnect the connector.</p> <p>4. Replace the harness.</p> <p>5. Replace the Imaging IOB (PCB2).</p> <p>6. Replace the PCDU.</p>

SC No.	Type	Error Name/Error Condition/Major Cause/Solution
SC324-05	D	<p>Development motor: CMY: Lock</p> <p>Motor status is observed at 100ms intervals during motor ON, and the unlock status is detected at least 20 times.</p> <ul style="list-style-type: none"> Motor defective Connector disconnected Harness broken IOB defective

5.Troubleshooting

SC No.	Type	Error Name/Error Condition/Major Cause/Solution
		<ul style="list-style-type: none"> Development unit torque increased
		<ol style="list-style-type: none"> 1. Taking care not to spill the developer, shake the development unit horizontally to spread the developer evenly. 2. Replace the motor. 3. Reconnect the connector. 4. Replace the harness. 5. Replace the Imaging IOB (PCB2). 6. Replace the PCDU.

SC No.	Type	Error Name/Error Condition/Major Cause/Solution
SC360-01	D	TD sensor adjustment error (K)
SC360-02	D	TD sensor adjustment error (C)
SC360-03	D	TD sensor adjustment error (M)
SC360-04	D	TD sensor adjustment error (Y)
		<ol style="list-style-type: none"> 1. Mu count is higher than the threshold which detects no developer. 2. Mu count is lower than the upper/lower target thresholds three consecutive times.
		<ul style="list-style-type: none"> TD sensor (S37)(S38)(S39)(S40) defective Loose connection Harness broken Developer toner density differs from initial developer
		<p>Check if the SC occurs by turning the power OFF then ON. If the SC occurs again, do the following steps. Check if the SC reoccurs by cycling the power after each step.</p> <ol style="list-style-type: none"> 1. Check if all connectors related to TD sensor (S37)(S38)(S39)(S40) are connected securely. Replace the connectors if they are disconnected, or loose. 2. Check the Development Unit for the following points and recover or replace it if there are any defects. <ul style="list-style-type: none"> • Gear came off • PCDU seal was not removed • Not initial developer 3. Check the TD sensor (S37)(S38)(S39)(S40) and recover or replace it if there are any defects.

SC No.	Type	Error Name/Error Condition/Major Cause/Solution
		<p>4. Check the harness for TD sensor (S37)(S38)(S39)(S40). Replace the harness if it is disconnected, or damaged.</p> <p>5. Replace the BICU (PCB10) if the SC cannot be recovered even after executing steps 1 to 4.</p>

SC No.	Type	Error Name/Error Condition/Major Cause/Solution
SC361-01	D	TD sensor output error: Upper Limit (K)
SC361-02	D	TD sensor output error: Upper Limit (C)
SC361-03	D	TD sensor output error: Upper Limit (M)
SC361-04	D	TD sensor output error: Upper Limit (Y)
		TD sensor output: Vt (SP3-210-001 to 004) > output upper limit error threshold (SP3-211-002) continuously exceeded the upper limit occurrence threshold value (SP3-211-003).
		TD sensor (S37)(S38)(S39)(S40) connector dropout (connection fault)
		<p>Check if the SC occurs by turning the power OFF then ON. If the SC occurs again, do the following steps. Check if the SC reoccurs by cycling the power after each step.</p> <p>1. Check if all connectors related to TD sensor (S37)(S38)(S39)(S40) are connected securely. Replace the connectors if they are disconnected, or loose.</p> <p>2. Check the Development Unit for the following points and recover or replace it if there are any defects.</p> <ul style="list-style-type: none"> • Gear comes off • Development unit is not installed correctly <p>3. Check the TD sensor (S37)(S38)(S39)(S40) and recover or replace it if there are any defects.</p> <p>4. Check the values of SP3-030-061 to 064 (Init TD Sensor :Exe Initial mu count). If they are initial, perform the TD sensor adjustment (SP3-030-001 to 006).</p> <p>5. Check the Toner Supply Unit and recover or replace it if there are any defects. (When the image density is excessively low, the supply unit may have a possibility of abnormality)</p> <ul style="list-style-type: none"> • Toner bottle is empty • Toner bottle drive error

5.Troubleshooting

SC No.	Type	Error Name/Error Condition/Major Cause/Solution
		<ul style="list-style-type: none"> • Clogging in the supplying path <p>6. Check the harness for TD sensor (S37)(S38)(S39)(S40). Replace the harness if it is disconnected, or damaged.</p> <p>7. Replace the BICU (PCB10) if the SC cannot be recovered even after executing steps 1 to 6.</p> <p>Recovery Confirmation Procedure</p> <p>1. Turn ON the main power, and then print a sheet.</p> <p>2. Execute SP3-320-***(TD.Sens:Vt :Disp: Current: CMYK) to check the output value of the TD sensor (S37)(S38)(S39)(S40).</p> <p>3. Execute SP3-211-004 (Vt Limits Err :Disp Lower Threshold) to check the lower limit value.</p> <ul style="list-style-type: none"> • Abnormal if the TD sensor output value is lower than the lower limit value • Normal if the TD sensor output value is equal to or larger than the lower limit value

SC No.	Type	Error Name/Error Condition/Major Cause/Solution
SC362-01	D	TD sensor output error: Lower limit (K)
SC362-02	D	TD sensor output error: Lower limit (C)
SC362-03	D	TD sensor output error: Lower limit (M)
SC362-04	D	TD sensor output error: Lower limit (Y)
		TD sensor output: Vt (SP3-210-001 to 004) < output lower limit error threshold (SP3-211-004) is continuously below the lower limit occurrence threshold value (SP3-211-005)
		TD sensor (S37)(S38)(S39)(S40) connector missing/dropout
		<p>Check if the SC occurs by turning the power OFF then ON. If the SC occurs again, do the following steps. Check if the SC reoccurs by cycling the power after each step.</p> <p>1. Check if all connectors related to TD sensor (S37)(S38)(S39)(S40) are connected securely. Replace the connectors if they are disconnected, or loose.</p> <p>2. Check the Development Unit for the following points and recover or replace it if there are any defects.</p> <ul style="list-style-type: none"> • Gear comes off • Development unit is not installed correctly

SC No.	Type	Error Name/Error Condition/Major Cause/Solution
		<p>3. Check the TD sensor (S37)(S38)(S39)(S40) and recover or replace it if there are any defects.</p> <p>4. Check the values of SP3-030-061 to 064 (Init TD Sensor :Exe Initial mu count). If they are initial, perform the TD sensor adjustment (SP3-030-001 to 006).</p> <p>5. Check the Toner Supply Unit and recover or replace it if there are any defects.</p> <ul style="list-style-type: none"> • Toner bottle driving error (left rotating) <p>6. Check the harness for TD sensor (S37)(S38)(S39)(S40). Replace the harness if it is disconnected, or damaged.</p> <p>7. Replace the BICU (PCB10) if the SC cannot be recovered even after executing steps 1 to 6.</p> <p>Recovery Confirmation Procedure</p> <p>1. Turn ON the main power, and then print a sheet.</p> <p>2. Execute SP3-320-***(TD.Sens:Vt :Disp: Current: CMYK) to check the output value of the TD sensor (S37)(S38)(S39)(S40).</p> <p>3. Execute SP3-211-004 (Vt Limits Err :Disp Lower Threshold) to check the lower limit value.</p> <ul style="list-style-type: none"> • Abnormal if the TD sensor output value is lower than the lower limit value • Normal if the TD sensor output value is equal to or larger than the lower limit value

SC No.	Type	Error Name/Error Condition/Major Cause/Solution
SC370-01	C	TM (ID) sensor calibration error (F)
SC370-02	D	TM (ID) sensor calibration error (C)
SC370-03	C	TM (ID) sensor calibration error (R)
		Regular reflection optical output voltage of the Front or Center or Rear TM (ID) sensor: Vsg_reg cannot be adjusted to within target range. Upper limit (SP3-320-013: initial value 4.5V) Lower limit (SP3-320-014: initial value 3.5V) Note: In the case of -01/-02, SC375 is displayed in precedence.
		For details about cause and solution, refer to When SC370 (TM (ID) sensor calibration error) is Displayed.

SC No.	Type	Error Name/Error Condition/Major Cause/Solution
SC371-	D	TM/ID sensor output error (front): Background area output (regular reflection)

5.Troubleshooting

SC No.	Type	Error Name/Error Condition/Major Cause/Solution
01		
SC371-02	D	TM/ID sensor output error (center): Background area output (regular reflection)
SC371-03	D	TM/ID sensor output error (rear): Background area output (regular reflection)
		The output voltage of specular-reflected light of the TM/ID sensor is below the lower limit value. Lower limit value: 0.3 (V)
		<ul style="list-style-type: none"> • TM (ID) sensor connector missing/connection error • TM (ID) sensor malfunction
		For details about cause and solution, refer to When SC371 (TM/ID Sensor Output Error: Background Output (Regular Reflection)) is Displayed .

SC No.	Type	Error Name/Error Condition/Major Cause/Solution
SC375-01	D	TM/ID sensor output error (front) :Detection of belt breakage
SC375-03	D	TM/ID sensor output error (rear) :Detection of belt breakage
		The output voltage of specular-reflected light (Vsg_reg) of the TM/ID sensor is below the lower limit value displayed in the following SP. Lower limit value (SP3-320-016) Note: This SC is displayed in precedence over SC370.
		<ul style="list-style-type: none"> • TM (ID) sensor connector missing/connection error • TM (ID) sensor detection window dirt • TM (ID) sensor malfunction • Undulation in the ITB, or belt slippage
		For details about cause and solution, refer to " When SC375 (TM/ID sensor output error, belt damage detected) is Displayed ".

SC No.	Type	Error Name/Error Condition/Major Cause/Solution
SC396-05	D	Drum motor (CMY) Lock
		Motor status is observed at 100ms intervals during motor ON, and the unlock status is detected at least 20 times
		<ul style="list-style-type: none"> • Motor defective • Connector disconnected • Harness broken • IOB defective

SC No.	Type	Error Name/Error Condition/Major Cause/Solution
		<ul style="list-style-type: none"><li data-bbox="400 248 727 282">• Unit torque increased<li data-bbox="400 300 695 333">• Replace the motor.<li data-bbox="400 349 775 383">• Reconnect the connector.<li data-bbox="400 398 727 432">• Replace the harness.<li data-bbox="400 448 879 481">• Replace the Imaging IOB (PCB2).<li data-bbox="400 497 703 530">• Replace the PCDU.

SC400 (Engine: Around the Drum)

SC No.	Type	Error Name/Error Condition/Major Cause/Solution
SC441-00	D	Drum transfer motor: Lock
		Motor status is observed at 100ms intervals during motor ON, and the unlock status is detected at least 20 times.
		<ul style="list-style-type: none"> • Motor defective • Connector disconnected • Harness broken • Imaging IOB defective • Unit torque increased.
		<ul style="list-style-type: none"> • Replace the motor • Reconnect the connector • Replace the harness • Replace the Imaging IOB (PCB2). • Check the load on the motor (PCDU, Image transfer unit, Paper transfer unit, Waste toner bottle). • Replace the PCDU, Image transfer unit, Paper transfer unit or Waste toner bottle.

SC No.	Type	Error Name/Error Condition/Major Cause/Solution
SC442-00	D	ITB Lift Error
		Even though the ITB contact and release motor (toner bottle drive motor (M) (M13) rotates, the ITB contact and release sensor (S32) failed to detect the specified sensor feeler status within specified time.
		<ul style="list-style-type: none"> • Contact/separation operation: If not detected in 2000msec • Home position operation: If not detected in 5000msec Signal detection sampling period: 10msec
		<ul style="list-style-type: none"> • Image transfer unit not set/faulty setting • Sensor dirt • Sensor defective • Motor defective • Unit load large
		<ol style="list-style-type: none"> <u>1.</u> Reset the Image Transfer Belt Unit properly. <u>2.</u> Clean the ITB contact and release sensor (S32). <u>3.</u> Check the harness (disconnected, loose connectors). <u>4.</u> Replace the ITB contact and release sensor (S32). <u>5.</u> Replace the Image Transfer Belt Unit.

SC No.	Type	Error Name/Error Condition/Major Cause/Solution
		6. Replace the contact/separation drive unit.

SC No.	Type	Error Name/Error Condition/Major Cause/Solution
SC452-00	D	Paper transfer contact and release motor error
		Even though the paper transfer contact and release motor (M18) rotates, the ITB contact and release sensor (S32) failed to detect the specified sensor feeler status within specified time.
		<ul style="list-style-type: none"> • Contact operation: If not detected in 2000msecITB contact and release sensor (S32) • Home position operation: If not detected in 5000msec Signal detection sampling period: 10msec
		<ul style="list-style-type: none"> • Sensor dirt • Sensor defection • Motor defection • Unit load large
		<ul style="list-style-type: none"> • Replace the contact drive unit • Replace the image transfer unit • Check the harness

SC No.	Type	Error Name/Error Condition/Major Cause/Solution
SC491-00	D	High voltage power source: charge/development: output error
		SC detection signal (charge/development) is L (abnormal) for 200 ms consecutively during high voltage (charge/development) output.
		H/W error <ul style="list-style-type: none"> • Output contact setting fault • Controller connector set fault • Ground fault of output high voltage path • Surface/air clearance insufficient (arc discharge) • Controller harness disconnection, short-circuit • PCU setting fault • Control board _IOB error (related signal error) • HVP-CB error Load error <ul style="list-style-type: none"> • Grounding fault of charging output, short-circuit with other outputs • Surface/air clearance insufficient in charging output path (including distance from other outputs) • Abnormal deterioration of drum, and over current due to pinholes • Drum vs charge roller gap error (PCU error).

5.Troubleshooting

SC No.	Type	Error Name/Error Condition/Major Cause/Solution
		<ul style="list-style-type: none"> • Over current due to drum surface condensation • Grounding fault of developing output, short-circuit with other outputs • Surface/air clearance insufficient in developing output path (including distance from other outputs) • Other
		<p>Check if the SC occurs by turning the power OFF then ON. If the SC occurs again, do the following steps. Check if the SC reoccurs by cycling the power after each step.</p> <ol style="list-style-type: none"> <u>1.</u> Reset the PCU. <u>2.</u> Replace the PCU. <u>3.</u> Reconnect the CN211 connector on the IOB. <u>4.</u> Reconnect the CN800 connector on the HVP-CB. <u>5.</u> Reset the HVP-CB. <u>6.</u> Replace the HVP-CB (PCB19). <u>7.</u> Replace the Imaging IOB (PCB2). <u>8.</u> Replace the harness between the IOB and HVP-CB.

SC No.	Type	Error Name/Error Condition/Major Cause/Solution
SC492-00	C	<p>High voltage power source: image transfer/paper transfer: output error</p> <p>SC detection signal (transfer) is L (abnormal) for 200 ms consecutively during high voltage (transfer) output.</p> <p>H/W error</p> <ul style="list-style-type: none"> • Output power connector setting fault • Controller connector setting fault • Output high voltage Harness disconnection • Controller harness disconnection, short-circuit • Transfer unit setting fault • Control board_ IOB error (related signal error) • HVP-TTS error <p>Load error</p> <ul style="list-style-type: none"> • Increase in paper transfer roller impedance (low temperature environment/impedance rise/impedance rise due to dirt) • Operation fault of paper transfer contact mechanism • Increase in image transfer belt impedance • Opening in load power supply path <ul style="list-style-type: none"> • Reset or replacement the harness of high voltage power supply feed path • Reset or replace the harness between the imaging IOB (PCB2) and HVP-TTS.

SC No.	Type	Error Name/Error Condition/Major Cause/Solution
		<ul style="list-style-type: none"> Reset or replace the transfer unit. Check operation of the contact mechanism. Replace the HVP-TTS (PCB16). Replace the Imaging IOB (PCB2).

SC No.	Type	Error Name/Error Condition/Major Cause/Solution
SC497-00	C	Machine temperature detection thermistor error
		Temperature sensor output error: Below 0.56V, or above 3.0V
		<ul style="list-style-type: none"> Connector disconnection or broken Sensor (Thermistor) defective
		<p>Check if the SC occurs by turning the power OFF then ON. If the SC occurs again, do the following steps. Check if the SC reoccurs by cycling the power after each step.</p> <ol style="list-style-type: none"> 1. Check if all connectors related to the Imaging Temperature Sensor (Thermistor) (S33) are connected securely. Reconnect the connectors if they are disconnected, or loose. 2. Replace the Imaging Temperature Sensor (Thermistor) (S33).

SC No.	Type	Error Name/Error Condition/Major Cause/Solution
SC498-00	C	Temperature and humidity sensor error
		Temperature sensor output error: Below 0.76V, or above 2.90V, or Moisture sensor output error: more than 2.4V
		<ul style="list-style-type: none"> Sensor not setting (disconnection or broken) Sensor defective
		<p>Check if the SC occurs by turning the power OFF then ON. If the SC occurs again, do the following steps. Check if the SC reoccurs by cycling the power after each step.</p> <ol style="list-style-type: none"> 1. Check if all connectors related to the Temperature and Humidity Sensor (S41) are connected securely. Reconnect the connectors if they are disconnected, or loose. 2. Replace the Temperature and Humidity Sensor (S41).

SC500**Engine: Paper transport 1 (Paper Feed, Duplex, Transport)**

SC No.	Type	Error Name/Error Condition/Major Cause/Solution
SC501-01	B	1st Tray Lift Error (Main Machine)
		The 1st tray lift motor error detection count reaches 3 times. (Up to 2 times, reset instruction is displayed)
		<ul style="list-style-type: none"> The connector of upper limit sensor (1st feed tray) (S15) missing, malfunction, dirt The connector of lift motor (1st feed tray) (M9) missing, disconnection, malfunction. Foreign object, such as paper scrap, is caught between the paper feed tray and the tray lift motor. Paper set incorrectly
		<ul style="list-style-type: none"> Reload the paper. Remove the foreign object. <p>Upper limit sensor (1st feed tray) (S15), lift motor (1st feed tray) (M9)</p> <ul style="list-style-type: none"> Check the harness of the Upper limit sensor (1st feed tray) (S15), or lift motor (1st feed tray) (M9). Reconnect the connector of the Upper limit sensor (1st feed tray) (S15), or lift motor (1st feed tray) (M9). Replace the Upper limit sensor (1st feed tray) (S15), or lift motor (1st feed tray) (M9). <p>1st paper feed unit, 1st tray</p> <ul style="list-style-type: none"> Replace the 1st paper feed unit, 1st tray. <p>Paper Transport IOB (PCB1)</p> <ul style="list-style-type: none"> Replace the paper transport IOB (PCB1).
SC501-02	B	1st Tray Descent Error (Main Frame)
		The 1st tray descent motor error detection count reaches 5. (Up to 4, reset instruction is displayed.)
		<ul style="list-style-type: none"> The connector of upper limit sensor (1st feed tray) (S15) missing, malfunction, dirt The connector of lift motor (1st feed tray) (M9) missing, disconnection, malfunction Foreign object, such as paper scrap, is caught between the paper feed tray and the tray lift motor.

SC No.	Type	Error Name/Error Condition/Major Cause/Solution
		<ul style="list-style-type: none"> Paper set incorrectly Paper overload
		<ul style="list-style-type: none"> Reset the paper. Remove the foreign object. <p>Upper limit sensor (1st feed tray) (S15), lift motor (1st feed tray) (M9)</p> <ul style="list-style-type: none"> Check the harness of the Upper limit sensor (1st feed tray) (S15), or lift motor (1st feed tray) (M9). Reconnect the connector of the Upper limit sensor (1st feed tray) (S15), or lift motor (1st feed tray) (M9). Replace the Upper limit sensor (1st feed tray) (S15), or lift motor (1st feed tray) (M9). <p>1st feed tray</p> <ul style="list-style-type: none"> Replace the 1st paper feed unit, 1st tray. <p>Paper Transport IOB (PCB1)</p> <ul style="list-style-type: none"> Replace the paper transport IOB (PCB1).

SC No.	Type	Error Name/Error Condition/Major Cause/Solution
SC502-01	B	2nd Tray Lift Error (Main Frame)
		The 2nd tray lift motor error detection count reaches 3. (Up to 2, reset is displayed.)
		<ul style="list-style-type: none"> The connector of upper limit sensor (2nd feed tray) (S25) missing, malfunction, dirt The connector of lift motor (2nd feed tray) (M10) missing, disconnection, malfunction Foreign object, such as paper scrap, is caught between the paper feed tray and the tray lift motor Paper set incorrectly
		<ul style="list-style-type: none"> Reset the paper. Remove the foreign object. <p>Upper limit sensor (2nd feed tray) (S25), lift motor (2nd feed tray) (M10)</p> <ul style="list-style-type: none"> Check the harness of the Upper limit sensor (2nd feed tray) (S25), or lift motor (2nd feed tray) (M10). Reconnect the connector of the Upper limit sensor (2nd feed tray) (S25), or lift motor (2nd feed tray) (M10). Replace the Upper limit sensor (2nd feed tray) (S25), or lift motor (2nd feed tray) (M10). <p>2nd feed tray</p>

5.Troubleshooting

SC No.	Type	Error Name/Error Condition/Major Cause/Solution
		<ul style="list-style-type: none"> Replace the 2nd paper feed unit, or 2nd tray. <p>Paper Transport IOB (PCB1)</p> <ul style="list-style-type: none"> Replace the paper transport IOB (PCB1).
SC502-02	B	2nd Tray Descent Error (Main Frame)
		The detection count of 2nd tray descent motor descent errors reaches a total of 5. (Up to 4, reset is displayed.)
		<ul style="list-style-type: none"> The connector of upper limit sensor (2nd feed tray) (S25) missing, malfunction, and dirt The connector of lift motor (2nd feed tray) (M10) missing, disconnection, malfunction Foreign object, such as paper scrap, is caught between the paper feed tray and the tray lift motor Paper set incorrectly Paper overload
		<ul style="list-style-type: none"> Reset the paper. Remove the foreign object. <p>Upper limit sensor (2nd feed tray) (S25), lift motor (2nd feed tray) (M10)</p> <ul style="list-style-type: none"> Check the harness of the Upper limit sensor (2nd feed tray) (S25), or lift motor (2nd feed tray) (M10). Reconnect the connector of the Upper limit sensor (2nd feed tray) (S25), or lift motor (2nd feed tray) (M10). Replace the Upper limit sensor (2nd feed tray) (S25), or lift motor (2nd feed tray) (M10). <p>2nd paper feed unit, 2nd tray</p> <ul style="list-style-type: none"> Replace the 2nd paper feed unit, or 2nd tray. <p>Paper Transport IOB (PCB1)</p> <ul style="list-style-type: none"> Replace the paper transport IOB (PCB1).

SC No.	Type	Error Name/Error Condition/Major Cause/Solution
SC503-01	B	3rd Tray Lift Error (One-tray paper feed unit)
		<ul style="list-style-type: none"> Lift motor ascent error detection <p>During tray initialization (upper limit not detected/lower limit detection), the tray base plate is raised to check the tray base plate position, and the upper limit sensor (S15) (S25) is not detected although a predetermined time elapsed, for 3 times consecutively.</p> <p>(Up to 2 times consecutively, the bank transmits a "tray set incorrectly" to the</p>

SC No.	Type	Error Name/Error Condition/Major Cause/Solution
		main machine.)
		<ul style="list-style-type: none"> • Lift motor error/connector missing • Limit sensor error/connector missing • Harness broken • Bank control board defective • Foreign object, such as paper scrap, is caught between the paper feed tray and the tray lift motor • Paper set incorrectly
		<p>Remove the jammed paper or slip of paper from the tray, and check if the SC occurs by turning the main power OFF then ON. If the SC occurs again, do the following steps. Check if the SC reoccurs by cycling the power after each step.</p> <ol style="list-style-type: none"> 1. Check if all connectors in Tray 3 are connected securely. Reconnect the connectors if they are disconnected, or loose. 2. Check the harness in Tray 3. Replace the harnesses if it is disconnected, or damaged. 3. Check if the motor runs, sensors turn OFF/ON, has no overloads, and is properly driven. Replace the parts if there are any defects. 4. Check if there are any signs of a short circuit. Replace the parts if there are any defects.
SC503-02	B	3rd Tray Descent Error (One-tray paper feed unit)
		<ul style="list-style-type: none"> • Lift motor descent error detection <p>During tray initialization, the tray base plate is lowered to check the tray base plate position, and the upper limit sensor (S15) (S25) is detected although a predetermined time elapsed, for 3 times consecutively.</p> <p>(Up to 2 times consecutively, the bank transmits a "tray set incorrectly" to the main machine.)</p>
		<ul style="list-style-type: none"> • Lift motor error/connector missing • Upper limit sensor error/connector missing • Harness broken • Bank control board defective • Paper overload • Foreign object, such as paper scrap, is caught between the paper feed tray and the tray lift motor • Paper set incorrectly
		<p>Remove the jammed paper or slip of paper from the tray, and check if the SC occurs by turning the main power OFF then ON. If the SC occurs again, do the following steps. Check if the SC reoccurs by cycling the power after each step.</p>

5.Troubleshooting

SC No.	Type	Error Name/Error Condition/Major Cause/Solution
		<ol style="list-style-type: none"> 1. Check if all connectors in Tray 3 are connected securely. Reconnect the connectors if they are disconnected, or loose. 2. Check the harness in Tray 3. Replace the harnesses if it is disconnected, or damaged. 3. Check if the motor runs, sensors turn OFF/ON, has no overloads, and is properly driven. Replace the parts if there are any defects. 4. Check if there are any signs of a short circuit. Replace the parts if there are any defects.
SC503-11	B	3rd Tray Lift Error (Two-tray paper feed unit)
		<ul style="list-style-type: none"> • Lift motor ascent error detection During tray initialization (upper limit not detected/lower limit detection), the tray base plate is raised to check the tray base plate position, and the upper limit sensor (S15) (S25) is not detected although a predetermined time elapsed, for 3 times consecutively. (Up to 2 times consecutively, the bank transmits a "tray set incorrectly" to the main machine.)
		<ul style="list-style-type: none"> • Lift motor error/connector missing • Upper limit sensor error/connector missing • Harness broken • Bank control board defective • Foreign object, such as paper scrap, is caught between the paper feed tray and the tray lift motor • Paper set incorrectly
		<p>Remove the jammed paper or slip of paper from the tray, and check if the SC occurs by turning the main power OFF then ON. If the SC occurs again, do the following steps. Check if the SC reoccurs by cycling the power after each step.</p> <ol style="list-style-type: none"> 1. Check if all connectors in Tray 3 are connected securely. Reconnect the connectors if they are disconnected, or loose. 2. Check the harness in Tray 3. Replace the harnesses if it is disconnected, or damaged. 3. Check if the motor runs, sensors turn OFF/ON, has no overloads, and is properly driven. Replace the parts if there are any defects. 4. Check if there are any signs of a short circuit. Replace the parts if there are any defects.
SC503-12	B	3rd Tray Descent Error (Two-tray paper feed unit)
		<ul style="list-style-type: none"> • Lift motor descent error detection

SC No.	Type	Error Name/Error Condition/Major Cause/Solution
		<p>During tray initialization, the tray base plate is lowered to check the tray base plate position; the upper limit sensor (S15) (S25) is detected although a predetermined time elapsed, for 3 times consecutively.</p> <p>(Up to 2 times consecutively, the bank transmits a "tray set incorrectly" to the main machine.)</p>
		<ul style="list-style-type: none"> • Lift motor error/connector missing • Upper limit sensor error/connector missing • Harness broken • Bank control board defective • Paper overload • Foreign object, such as paper scrap, is caught between the paper feed tray and the tray lift motor • Paper set incorrectly
		<p>Remove the jammed paper or slip of paper from the tray, and check if the SC occurs by turning the main power OFF then ON. If the SC occurs again, do the following steps. Check if the SC reoccurs by cycling the power after each step.</p> <ol style="list-style-type: none"> 1. Check if all connectors in Tray 3 are connected securely. Reconnect the connectors if they are disconnected, or loose. 2. Check the harness in Tray 3. Replace the harnesses if it is disconnected, or damaged. 3. Check if the motor runs, sensors turn OFF/ON, has no overloads, and is properly driven. Replace the parts if there are any defects. 4. Check if there are any signs of a short circuit. Replace the parts if there are any defects.
SC503-31	B	3rd Tray Lift Error (Tandem paper feed unit)
		<ul style="list-style-type: none"> • Upper limit detection error (during descent) During tray initialization (upper limit detection/lower limit not detected), the tray base plate is lowered to check the tray base plate position, and the upper limit sensor (S15) (S25) is detected although a predetermined time elapsed, for 3 times consecutively. • Upper limit detection error (during ascent) During tray initialization (upper limit not detected/lower limit detection), the tray base plate is raised to check the tray base plate position, and the upper limit sensor (S15) (S25) is not detected although a predetermined time elapsed, for 3 times consecutively. <p>(Up to 2 times consecutively, LCIT transmits "tray set incorrectly" to the main machine.)</p>

5.Troubleshooting

SC No.	Type	Error Name/Error Condition/Major Cause/Solution
		<ul style="list-style-type: none"> • Lift motor error/connector missing • Upper limit sensor error/connector missing • Harness broken • Bank control board defective • Foreign object, such as paper scrap, is caught between the right tray and the tray lift motor • Paper set incorrectly • Timing belt damage/dropout • Timing pulley damage/dropout • Base plate damage/not horizontal • Paper feed roller missing item • Pick-up arm damage • Foreign object, such as paper scrap, is caught inside the right tray
		<p>Remove the jammed paper or slip of paper from the tray, and check if the SC occurs by turning the main power OFF then ON. If the SC occurs again, do the following steps. Check if the SC reoccurs by cycling the power after each step.</p> <ol style="list-style-type: none"> 1. Check if all connectors in Tray 3 are connected securely. Reconnect the connectors if they are disconnected, or loose. 2. Check the harness in Tray 3. Replace the harnesses if it is disconnected, or damaged. 3. Check if the motor runs, sensors turn OFF/ON, has no overloads, and is properly driven. Replace the parts if there are any defects. 4. Check if there are any signs of a short circuit. Replace the parts if there are any defects.
SC503-32	B	3rd Tray Descent Error (Tandem paper feed unit)
		<ul style="list-style-type: none"> • Lower limit detection error (during descent) During tray initialization (upper limit not detected/lower eject limit detection), the tray base plate is lowered to check the tray base plate position, and the lower limit sensor is not detected although a predetermined time elapsed. Alternatively, at paper end, the tray base plate is lowered, but the lower limit sensor is not detected although a predetermined time elapsed. • Lower limit error (during ascent) During tray initialization (upper limit eject detection/lower limit detection), the tray base plate is raised to check the tray base plate position, and the lower limit sensor is detected although a predetermined time elapsed. *If an error occurs 3 times consecutively: LCIT transmits "3rd tray lower limit detection error" to the main machine. Up to 2 times consecutively, LCIT

SC No.	Type	Error Name/Error Condition/Major Cause/Solution
		transmits "tray set incorrectly" to the main machine.
		<ul style="list-style-type: none"> • Lift motor error/connector missing • Lower limit sensor error/connector missing • Harness broken • Bank control board defective • Foreign object, such as paper scrap, is caught between the right tray and the tray lift motor • Paper set incorrectly • Timing belt damage/dropout • Timing pulley damage/dropout • Base plate damage/not horizontal • Foreign object, such as paper scrap, is caught inside the right tray
		<p>Remove the jammed paper or slip of paper from the tray, and check if the SC occurs by turning the main power OFF then ON. If the SC occurs again, do the following steps. Check if the SC reoccurs by cycling the power after each step.</p> <ol style="list-style-type: none"> 1. Check if all connectors in Tray 3 are connected securely. Reconnect the connectors if they are disconnected, or loose. 2. Check the harness in Tray 3. Replace the harnesses if it is disconnected, or damaged. 3. Check if the motor runs, sensors turn OFF/ON, has no overloads, and is properly driven. Replace the parts if there are any defects. 4. Check if there are any signs of a short circuit. Replace the parts if there are any defects.
SC503-33	B	3rd Tray Paper Overload Error (Tandem paper feed unit)
		<p>During tray initialization, both the upper limit and lower limit are detected 3 times consecutively.</p> <p>(Up to 2 times consecutively, LCIT transmits "tray set incorrectly" to the main machine)</p>
		<ul style="list-style-type: none"> • Paper overload • Paper set incorrectly • Limit sensor error/connector missing • Lower limit sensor error/connector missing • Harness broken • Bank control board defective • Foreign object, such as paper scrap, is caught inside the right tray
		Remove the jammed paper or slip of paper from the tray, and check if the SC occurs by turning the main power OFF then ON. If the SC occurs again, do the

5.Troubleshooting

SC No.	Type	Error Name/Error Condition/Major Cause/Solution
		<p>following steps. Check if the SC reoccurs by cycling the power after each step.</p> <ol style="list-style-type: none"> 1. Check if all connectors in Tray 3 are connected securely. Reconnect the connectors if they are disconnected, or loose. 2. Check the harness in Tray 3. Replace the harnesses if it is disconnected, or damaged. 3. Check if the motor runs, sensors turn OFF/ON, has no overloads, and is properly driven. Replace the parts if there are any defects. 4. Check if there are any signs of a short circuit. Replace the parts if there are any defects.
SC503-34	B	3rd Tray Paper Position Error (Tandem paper feed unit)
		<p>During left/right tray set, or when power is switched ON, or when transfer is complete, "open" is detected 3 times consecutively by end fence open/close detection.</p> <p>(Up to 2 times consecutively, LCIT transmits "tray set incorrectly" to the main machine.)</p>
		<ul style="list-style-type: none"> • Paper set incorrectly (paper is offset from position for pushing end fence) • Foreign object entry (foreign object is caught in the position for pushing end fence) • End fence open/close sensor error/connector missing • Harness broken • Bank control board defective
		<p>Remove the jammed paper or slip of paper from the tray, and check if the SC occurs by turning the main power OFF then ON. If the SC occurs again, do the following steps. Check if the SC reoccurs by cycling the power after each step.</p> <ol style="list-style-type: none"> 1. Check if all connectors in Tray 3 are connected securely. Reconnect the connectors if they are disconnected, or loose. 2. Check the harness in Tray 3. Replace the harnesses if it is disconnected, or damaged. 3. Check if the motor runs, sensors turn OFF/ON, has no overloads, and is properly driven. Replace the parts if there are any defects. 4. Check if there are any signs of a short circuit. Replace the parts if there are any defects.
SC503-35	B	3rd Tray Transfer Error (Tandem paper feed unit)
		<ul style="list-style-type: none"> • Transfer end detection error <p>At right tray paper end (right tray lower limit detection, left tray paper detection), left tray paper is transferred to the right tray, but the left tray paper</p>

SC No.	Type	Error Name/Error Condition/Major Cause/Solution
		<p>sensor is detected although a predetermined time elapsed (paper missing is not detected), for 3 times consecutively.</p> <p>(Up to 2 times consecutively, LCIT transmits "tray set incorrectly" to the main machine.)</p>
		<ul style="list-style-type: none"> • Transfer motor error/connector missing • Left tray paper sensor error/connector missing • Harness broken • Bank control board defective • Paper overload • Foreign object, such as paper scrap, is caught between the left tray and the tray transfer motor • Paper set incorrectly • Timing belt damage/dropout • Timing pulley damage/dropout • Transfer fence defective • Foreign object, such as paper scrap, is caught inside the left tray
		<p>Remove the jammed paper or slip of paper from the tray, and check if the SC occurs by turning the main power OFF then ON. If the SC occurs again, do the following steps. Check if the SC reoccurs by cycling the power after each step.</p> <ol style="list-style-type: none"> 1. Check if all connectors in Tray 3 are connected securely. Reconnect the connectors if they are disconnected, or loose. 2. Check the harness in Tray 3. Replace the harnesses if it is disconnected, or damaged. 3. Check if the motor runs, sensors turn OFF/ON, has no overloads, and is properly driven. Replace the parts if there are any defects. 4. Check if there are any signs of a short circuit. Replace the parts if there are any defects.
SC503-36	B	<p>3rd Tray Transfer HP Error (Tandem paper feed unit)</p> <ul style="list-style-type: none"> • HP detection error (during transfer start) At right tray paper end (right tray lower limit detection, left tray paper detection), left tray paper is transferred to the right tray, but the left tray transfer fence HP sensor is detected although a predetermined time elapsed (HP sensor missing cannot be detected). • HP detection error (during transfer fence HP return) During left tray transfer fence HP not detected (stop after paper transfer, during power supply ON, during left tray set), the left tray transfer fence is moved to HP, but the left tray HP sensor is not detected although a predetermined time elapsed.

5.Troubleshooting

SC No.	Type	Error Name/Error Condition/Major Cause/Solution
		<p>*If an error occurs 3 times consecutively: LCIT transmits "3rd paper feed tray transfer HP error" to the main machine.</p> <p>(Up to 2 times consecutively, LCIT transmits "tray set incorrectly" to the main machine.)</p>
		<ul style="list-style-type: none"> • Transport motor (M5) error/connector missing • Left tray transfer fence HP sensor error/connector missing • Harness broken • Bank control board defective • Paper overload • Foreign object, such as paper scrap, is caught between the left tray and the tray transport motor • Paper set incorrectly • Timing belt damage/dropout • Timing pulley damage/dropout • Transfer fence defective • Foreign object, such as paper scrap, is caught inside the left tray
		<p>Remove the jammed paper or slip of paper from the tray, and check if the SC occurs by turning the main power OFF then ON. If the SC occurs again, do the following steps. Check if the SC reoccurs by cycling the power after each step.</p> <ol style="list-style-type: none"> 1. Check if all connectors in Tray 3 are connected securely. Reconnect the connectors if they are disconnected, or loose. 2. Check the harness in Tray 3. Replace the harnesses if it is disconnected, or damaged. 3. Check if the motor runs, sensors turn OFF/ON, has no overloads, and is properly driven. Replace the parts if there are any defects. 4. Check if there are any signs of a short circuit. Replace the parts if there are any defects.

SC No.	Type	Error Name/Error Condition/Major Cause/Solution
SC504-21	B	4th Tray Lift Error (Two-tray paper feed unit)
		<ul style="list-style-type: none"> • Lift motor ascent error detection <p>During tray initialization (upper limit not detected/lower limit detection), the tray base plate is raised to check the tray base plate position, but the upper limit sensor (S15) (S25) is not detected although a predetermined time elapsed, for 3 times consecutively.</p> <p>(Up to 2 times consecutively, the bank transmits a "tray set incorrectly" to the main machine.)</p>

SC No.	Type	Error Name/Error Condition/Major Cause/Solution
		<ul style="list-style-type: none"> • Lift motor error/connector missing • Upper limit sensor error/connector missing • Harness broken • Bank control board defective • Foreign object, such as paper scrap, is caught between the paper feed tray and the tray lift motor • Paper set incorrectly
		<p>Remove the jammed paper or slip of paper from the tray, and check if the SC occurs by turning the main power OFF then ON. If the SC occurs again, do the following steps. Check if the SC reoccurs by cycling the power after each step.</p> <ol style="list-style-type: none"> 1. Check if all connectors in Tray 4 are connected securely. Reconnect the connectors if they are disconnected, or loose. 2. Check the harness in Tray 4. Replace the harnesses if it is disconnected, or damaged. 3. Check if the motor runs, sensors turn OFF/ON, has no overloads, and is properly driven. Replace the parts if there are any defects. 4. Check if there are any signs of a short circuit. Replace the parts if there are any defects.
SC504-22	B	4th Tray Descent Error (Two-tray paper feed unit)
		<ul style="list-style-type: none"> • Lift motor descent error detection <p>During tray initialization, the tray base plate is lowered to check the tray base plate position, but the upper limit sensor (S15) (S25) is detected although a predetermined time elapsed, for 3 times consecutively. (Up to 2 times consecutively, the bank transmits a "tray set incorrectly" to the main machine.)</p>
		<ul style="list-style-type: none"> • Lift motor error/connector missing • Upper limit sensor error/connector missing • Harness broken • Bank control board defective • Paper overload • Foreign object, such as paper scrap, is caught between the paper feed tray and the tray lift motor • Paper set incorrectly
		<p>Remove the jammed paper or slip of paper from the tray, and check if the SC occurs by turning the main power OFF then ON. If the SC occurs again, do the following steps. Check if the SC reoccurs by cycling the power after each step.</p> <ol style="list-style-type: none"> 1. Check if all connectors in Tray 4 are connected securely. Reconnect the

5.Troubleshooting

SC No.	Type	Error Name/Error Condition/Major Cause/Solution
		<p>connectors if they are disconnected, or loose.</p> <p>2. Check the harness in Tray 4. Replace the harnesses if it is disconnected, or damaged.</p> <p>3. Check if the motor runs, sensors turn OFF/ON, has no overloads, and is properly driven. Replace the parts if there are any defects.</p> <p>4. Check if there are any signs of a short circuit. Replace the parts if there are any defects.</p>

SC No.	Type	Error Name/Error Condition/Major Cause/Solution
SC505-41	B	Side LCIT Limit Detection Error (Side LCIT)
		<ul style="list-style-type: none"> • Upper limit detection error (during descent) During tray initialization (upper limit detection/lower limit not detected), the tray base plate is lowered to check the tray base plate position, but the upper limit sensor (S15) (S25) is detected although a predetermined time elapsed. • Upper limit detection error (during ascent) During tray initialization (upper limit not detected /lower limit detection), the tray base plate is raised to check the tray base plate position, but the upper limit sensor (S15) (S25) is not detected although a predetermined time elapsed. <p>*If an error occurs for 3 times consecutively: the side LCIT transmits a "5th paper feed tray upper limit detection error" to the main machine.</p> <p>Up to 2 times consecutively, the side LCIT transmits a "tray set incorrectly" to the main machine.</p>
		<ul style="list-style-type: none"> • Lift motor error/connector missing • Upper limit sensor error/connector missing • Harness broken • Bank control board defective • Paper set incorrectly • Timing belt damage/dropout • Timing pulley damage/dropout • Base plate damage/not horizontal • Paper feed roller missing item • Pick-up arm defective • Foreign object, such as paper scrap, is caught inside the tray
		Remove the jammed paper or slip of paper from the tray, and check if the SC occurs by turning the main power OFF then ON. If the SC occurs again, do the following steps. Check if the SC reoccurs by cycling the power after each step.

SC No.	Type	Error Name/Error Condition/Major Cause/Solution
		<ol style="list-style-type: none"> 1. Check if all connectors in the side LCIT are connected securely. Reconnect the connectors if they are disconnected, or loose. 2. Check the harness in the side LCIT. Replace the harnesses if it is disconnected, or damaged. 3. Check if the motor runs, sensors turn OFF/ON, has no overloads, and is properly driven. Replace the parts if there are any defects. 4. Check if there are any signs of a short circuit. Replace the parts if there are any defects.
SC505-42	B	Side LCIT Lower Limit Detection Error (Side LCIT)
		<ul style="list-style-type: none"> • Lower limit detection error (during descent) During tray initialization (upper limit not detected /lower limit eject detection), the tray base plate is lowered to check the tray base plate position, but the lower limit sensor is not detected although a predetermined time elapsed. Alternatively, at paper end, the tray base plate is lowered, but the lower limit sensor is not detected although a predetermined time elapsed. • Lower limit detection error (during ascent) During tray initialization (upper limit not detected/lower limit detection), the tray base plate is raised to check the tray base plate position, but the lower limit sensor is detected although a predetermined time elapsed. *If an error occurs for 3 times consecutively: the side LCIT transmits a "5th paper feed tray upper limit detection error" to the main machine. Up to 2 times consecutively, the side LCIT transmits a "tray set incorrectly" to the main machine.
		<ul style="list-style-type: none"> • Lift motor error/connector missing • Lower limit sensor error/connector missing • Harness broken • Bank control board defective • Paper set incorrectly • Timing belt damage/dropout • Timing pulley damage/dropout • Base plate damage/not horizontal • Foreign object, such as paper scrap, is caught inside the tray
		<p>Remove the jammed paper or slip of paper from the tray, and check if the SC occurs by turning the main power OFF then ON. If the SC occurs again, do the following steps. Check if the SC reoccurs by cycling the power after each step.</p> <ol style="list-style-type: none"> 1. Check if all connectors in the side LCIT are connected securely. Reconnect the connectors if they are disconnected, or loose.

5.Troubleshooting

SC No.	Type	Error Name/Error Condition/Major Cause/Solution
		<p>2. Check the harness in the side LCIT. Replace the harnesses if it is disconnected, or damaged.</p> <p>3. Check if the motor runs, sensors turn OFF/ON, has no overloads, and is properly driven. Replace the parts if there are any defects.</p> <p>4. Check if there are any signs of a short circuit. Replace the parts if there are any defects.</p>
SC505-43	B	Side LCIT Paper Overload Error (Side LCIT)
		During tray initialization, both the upper limit and lower limit are detected for 3 times consecutively (up to 2 times consecutively, the side LCIT transmits a "tray set incorrectly" to the main machine).
		<ul style="list-style-type: none"> • Paper overload • Paper set incorrectly • Upper limit sensor error/connector missing • Lower limit sensor error/connector missing • Harness broken • Bank control board defective • Foreign object, such as paper scrap, is caught inside the tray
		<p>Remove the jammed paper or slip of paper from the tray, and check if the SC occurs by turning the main power OFF then ON. If the SC occurs again, do the following steps. Check if the SC reoccurs by cycling the power after each step.</p> <p>1. Check if all connectors in the side LCIT are connected securely. Reconnect the connectors if they are disconnected, or loose.</p> <p>2. Check the harness in the side LCIT. Replace the harnesses if it is disconnected, or damaged.</p> <p>3. Check if the motor runs, sensors turn OFF/ON, has no overloads, and is properly driven. Replace the parts if there are any defects.</p> <p>4. Check if there are any signs of a short circuit. Replace the parts if there are any defects.</p>

SC No.	Type	Error Name/Error Condition/Major Cause/Solution
SC508-00	B	Bypass Tray Size Detection Error
		The paper size detected on the bypass tray is different from any of the pattern of automatic size detection.
		<ul style="list-style-type: none"> • Bypass length sensor (S7) or bypass width sensor (S8) malfunction • Bypass length sensor (S7) or bypass width sensor (S8) harness disconnected • Paper transport IOB disconnected

SC No.	Type	Error Name/Error Condition/Major Cause/Solution
		<ol style="list-style-type: none"> 1. Check the Bypass Width Sensor (S8) harness. 2. Reconnect the Bypass Length Sensor (S7) on the Paper transport IOB. 3. Replace parts in the following order of precedence: <ul style="list-style-type: none"> • Bypass Length Sensor (S7) • Bypass Width Sensor (S8) harness (connector on bypass tray) • Paper transport IOB • Bypass Width Sensor harness (connector on IOB) 4. If replacing the bypass length sensor (S7), be sure to perform calibration (by attaching the adjustment tool to the bypass tray and executing SP1-008-032) afterward.

SC No.	Type	Error Name/Error Condition/Major Cause/Solution
SC520-01	C	Registration Motor (M7): Lock
SC520-02	C	Paper feed Motor: Lock
SC520-03	C	Transport Motor: Lock
		During motor ON, after checking the motor error notification registers (err_velo and err_posi) for 500msec, the error state of either register was detected at least 5 times.
		<ul style="list-style-type: none"> • Motor defective • Connector disconnected • Harness broken • IOB defective • Encoder defective
		<ul style="list-style-type: none"> • Replace the motor. • Reset the connector. • Replace the harness. • Replace the paper transport IOB (PCB1).

SC No.	Type	Error Name/Error Condition/Major Cause/Solution
SC521-01	C	Duplex Entrance Motor: Lock
SC521-02	C	Duplex By-pass Motor: Lock
		During motor ON, after checking the motor error notification registers (err_velo and

5.Troubleshooting

SC No.	Type	Error Name/Error Condition/Major Cause/Solution
		err_posi) for 500msec, the error state of either register was detected at least 5 times.
		<ul style="list-style-type: none"> • Motor defective • Connector disconnected • Harness broken • IOB defective • Encoder defective
		<ul style="list-style-type: none"> • Replace the duplex entrance motor (M1). • Reset the connector. • Replace the harness. • Replace the paper transport IOB (PCB1).

SC No.	Type	Error Name/Error Condition/Major Cause/Solution
SC522-00	C	Paper Exit Motor: Lock
		During motor ON, after checking the motor error notification registers (err_velo and err_posi) for 500msec, the error state of either register was detected at least 5 times.
		<ul style="list-style-type: none"> • Motor defective • Connector disconnected • Harness broken • IOB defective • Encoder defective
		<ul style="list-style-type: none"> • Replace the motor. • Reset the connector. • Replace the harness. • Replace the paper transport IOB (PCB1).

SC No.	Type	Error Name/Error Condition/Major Cause/Solution
SC530-00	D	Fusing Exhaust Fan Lock
		In the motor ON state, the value of the lock sensor is checked every 100msec. If a lock signal is not obtained for 50 times consecutively.
		<ul style="list-style-type: none"> • Motor defective • Connector disconnected • Harness broken • IOB defective
		<ul style="list-style-type: none"> • Replace the fusing exhaust fan.

SC No.	Type	Error Name/Error Condition/Major Cause/Solution
		<ul style="list-style-type: none"> Reset the connector. Replace the harness. Replace the paper transport IOB (PCB1).

SC No.	Type	Error Name/Error Condition/Major Cause/Solution
SC531-01	D	Development Intake Fan/Right Lock
SC531-03	D	Drive Cooling Fan Lock
		In the motor ON state, the value of the lock sensor is checked every 100msec. If a lock signal is not obtained for 50 times consecutively.
		<ul style="list-style-type: none"> Motor defective Connector disconnected Harness broken Imaging IOB defective
		<ul style="list-style-type: none"> Replace the development intake fan/right for SC531-01, or drive cooling fan for SC531-03. Reset the connector. Replace the harness. Replace the paper imaging IOB.

SC No.	Type	Error Name/Error Condition/Major Cause/Solution
SC533-03	D	PSU Cooling Fan Lock
SC533-04	D	Controller Box Cooling Fan Lock
		In the motor ON state, the value of the lock sensor is checked every 100msec. If a lock signal is not obtained for 50 times consecutively.
		<ul style="list-style-type: none"> Motor defective Connector disconnected Harness broken IOB defective
		<ul style="list-style-type: none"> Replace the cooling fan for SC533-04 or controller box cooling fan for SC533-04. Reset the connector. Replace the harness. Replace the Paper Transport IOB (for SC533-03).

5.Troubleshooting

SC No.	Type	Error Name/Error Condition/Major Cause/Solution
		<ul style="list-style-type: none"> • Replace the Imaging IOB (for SC533-04).

SC No.	Type	Error Name/Error Condition/Major Cause/Solution
SC534-01	D	Main Exhaust Fan Lock
SC534-02	D	Toner Supply Cooling Fan Lock
SC534-03	D	Ozone Exhaust Fan Lock
		In the motor ON state, the value of the lock sensor is checked every 100msec. If a lock signal is not obtained for 50 times (140 times for SC543-03) consecutively.
		<ul style="list-style-type: none"> • Motor defective • Connector disconnected • Harness broken • IOB defective
		<ul style="list-style-type: none"> • Replace the development intake fan/right for SC534-01, or drive cooling fan for SC534-03. • • Reconnect the connector. • • Replace the harness. • • Replace the Imaging IOB (SC534-01, -02). • • Replace the Paper Transport IOB (for SC534-03).

SC No.	Type	Error Name/Error Condition/Major Cause/Solution
SC535-00	D	Paper Exit Cooling Fan Lock
		In the motor ON state, the value of the lock sensor is checked every 100msec. If a lock signal is not obtained for 50 times consecutively.
		<ul style="list-style-type: none"> • Motor defective • Connector disconnected • Harness broken • IOB defective
		<ul style="list-style-type: none"> • Replace the paper exit cooling fan. • Reconnect the connector. • Replace the harness. • Replace the Imaging IOB.

SC No.	Type	Error Name/Error Condition/Major Cause/Solution
SC540-00	D	Fusing Motor: Lock
		Motor status is observed at 100ms intervals during motor ON, and the unlock status is detected at least 20 times.
		<ul style="list-style-type: none"> • Motor defective • Connector disconnected • Harness broken • IOB defective
		<ul style="list-style-type: none"> • Replace the fusing motor. • Reconnect the connector. • Replace the harness. • Replace the Paper Transport IOB.

Engine: Fusing

Fusing Sleeve (Center) Error (SC54*-**)

SC No.	Type	Error Name/Error Condition/Major Cause/Solution
SC541-01	A	Thermopile (Center) Disconnection
		In Machine Condition A, after turning the fusing lamp on, the thermopile (center) (TH1) has detected the temperature of -50°C or below continuously for 0.1 second Machine Condition A refers to any of the following conditions: <ul style="list-style-type: none"> • In Warm-up mode • At start-up and restart-up • Rotation after reload • Before/while/after printing • In Ready mode • In Panel Off mode • In Low Power mode
		<ul style="list-style-type: none"> • Thermopile disconnection • Thermistor disconnection • Connector error (disconnected, loose)
		<ol style="list-style-type: none"> <u>1.</u> Reconnect the connectors (main machine side, BICU side). <u>2.</u> Replace the thermopile (center) (TH1). <u>3.</u> Replace the harness between the fusing unit and the BICU. <u>4.</u> Replace the BICU (PCB10), or PSU (AC controller board) (PCB9).
SC541-02	A	Non-contact Thermistor (Center) Disconnection
		In Machine Condition A, after turning the fusing lamp on, the non-contact thermistor (center) (S46) has detected the temperature of 36°C or higher

5.Troubleshooting

		<p>continuously for 1 second.</p> <p>Machine Condition A refers to any of the following conditions:</p> <ul style="list-style-type: none"> • In Warm-up mode • At start-up and restart-up • Rotation after reload • Before/while/after printing • In Ready mode • In Panel Off mode • In Low Power mode
		<ul style="list-style-type: none"> • Thermopile disconnection • Thermistor disconnection • Connector error (disconnected, loose)
		<ol style="list-style-type: none"> <u>1.</u> Check the power supply voltage and reconnect the cable to the outlet. <u>2.</u> Replace the fusing sleeve thermostat (center) <u>3.</u> Replace the fusing unit. <u>4.</u> Replace the thermopile (center) (TH1). <u>5.</u> Replace the BICU (PCB10), or PSU (AC controller board) (PCB9)
SC541-03	A	<p>Non-contact Thermistor (Center) short-circuit</p> <p>In Machine Condition A, after turning the fusing lamp on, the non-contact thermistor (center) (S46) has detected the AD value of 8 or below continuously for 1 second.</p> <p>Machine Condition A refers to any of the following conditions:</p> <ul style="list-style-type: none"> • In Warm-up mode • At start-up and restart-up • Rotation after reload • Before/while/after printing • In Ready mode • In Panel Off mode • In Low Power mode
		<ul style="list-style-type: none"> • Thermopile disconnection • Thermistor disconnection • Connector error (disconnected, loose)
		<ol style="list-style-type: none"> <u>1.</u> Check the power supply voltage and reconnect the cable to the outlet. <u>2.</u> Replace the fusing sleeve thermostat (center) <u>3.</u> Replace the fusing unit. <u>4.</u> Replace the thermopile (center) (TH1). <u>5.</u> Replace the BICU (PCB10), or PSU (AC controller board) (PCB9)

SC No.	Type	Error Name/Error Condition/Major Cause/Solution
--------	------	---

SC542-02	A	Thermopile (Center) does not reload
		In Machine Condition B, after turning the fusing lamp (center) on, the thermopile (center) (TH1) has failed to reach 65°C in 10 seconds. Machine Condition B refers to any of the following conditions: <ul style="list-style-type: none"> • In Warm-up mode • At start-up and restart-up
SC542-03	A	Thermopile (Center) does not reload
		In Machine Condition B, after turning the fusing lamp (center) on, the thermopile (center) (TH1) has failed to reach the "permissible temperature for reloading" in 35 seconds. Machine Condition B refers to any of the following conditions: <ul style="list-style-type: none"> • In Warm-up mode • At start-up and restart-up
SC542-05	D	Thermopile (Center) does not reload (Low Power)
		In Machine Condition B, after turning the fusing lamp (center) on, the thermopile (center) (TH1) has failed to reach 65°C in 10 seconds. Machine Condition B refers to any of the following conditions: <ul style="list-style-type: none"> • In Warm-up mode • At start-up and restart-up
SC542-06	D	Thermopile (Center) does not reload (Low Power)
		In Machine Condition B, after turning the fusing lamp (center) on, the thermopile (center) (TH1) has failed to reach the "permissible temperature for reloading" in 35 seconds. Machine Condition B refers to any of the following conditions: <ul style="list-style-type: none"> • In Warm-up mode • At start-up and restart-up
		<ul style="list-style-type: none"> • Thermopile lens dirt • Thermopile modification/float • After excessive temperature rise prevention unit operation <ol style="list-style-type: none"> <u>1.</u> Check the power supply voltage and reconnect the cable to the outlet. <u>2.</u> Replace the fusing sleeve thermostat (center) <u>3.</u> Replace the fusing unit. <u>4.</u> Replace the thermopile (center) (TH1). <u>5.</u> Replace the BICU (PCB10), or PSU (AC controller board) (PCB9)

SC No.	Type	Error Name/Error Condition/Major Cause/Solution
SC543-00	A	Thermopile (Center) high temperature detection (software)
		The thermopile (center) (TH1) has detected the temperature of 240°C or higher

5.Troubleshooting

		continuously for 1 second.
		<ul style="list-style-type: none"> • Triac short-circuit • IOB board defective • BICU board defective
		<ol style="list-style-type: none"> <u>1.</u> Reconnect the harnesses between the fusing unit and BICU or the PSU (AC controller board). <u>2.</u> Replace the thermopile (center) (TH1). <u>3.</u> Replace the harnesses between the fusing unit and BICU or the PSU (AC controller board). <u>4.</u> Replace the BICU (PCB10). <u>5.</u> Replace the PSU (AC controller board) (PCB9). <u>6.</u> If the problem cannot be solved after performing the above steps, replace the fusing unit.

SC No.	Type	Error Name/Error Condition/Major Cause/Solution
SC544-01	A	Thermopile (Center) high temperature detection (hardware)
		In the event of an error
		<ul style="list-style-type: none"> • Triac short-circuit • IOB board defective • BICU board defective
		<ol style="list-style-type: none"> <u>1.</u> Reconnect the harnesses between the fusing unit and BICU or the PSU (AC controller board). <u>2.</u> Replace the thermopile (center) (TH1). <u>3.</u> Replace the harnesses between the fusing unit and BICU or the PSU (AC controller board). <u>4.</u> Replace the BICU (PCB10). <u>5.</u> Replace the PSU (AC controller board) (PCB9). <u>6.</u> If the problem cannot be solved after performing the above steps, replace the fusing unit.

SC No.	Type	Error Name/Error Condition/Major Cause/Solution
SC544-02	A	Non-contact Thermistor (Center) high temperature detection (hardware)
		In the event of an error
		<ul style="list-style-type: none"> • Triac short-circuit • IOB board defective • BICU board defective
		<ol style="list-style-type: none"> <u>1.</u> Inspect the fusing sleeve belt unit, and replace if damaged. <u>2.</u> Check the paper settings.

		<p>3. Check the paper position in the paper feed tray.</p> <p>4. Reconnect the connectors (main machine side, BICU side).</p> <p>5. Remove the jammed paper between the thermopile and fusing unit.</p> <p>6. Clean or Replace the thermopile (center) (TH1).</p> <p>7. Replace the fusing unit.</p> <p>8. Inspect the pressure roller HP sensor (S26) with SP5-803-047.</p> <p>9. Replace the harness between the fusing unit and the BICU or the PSU (AC controller board).</p> <p>10. Replace the BICU (PCB10).</p> <p>11. Replace the PSU (AC controller board) (PCB9).</p>
--	--	--

SC No.	Type	Error Name/Error Condition/Major Cause/Solution
SC545-01	A	Fusing Central Lamp Continuously Heat
SC545-05	D	<p>Fusing Central Lamp Continuously Heat (Low Power)</p> <p>After waiting for full power for more than 5 sec continuously.</p> <ul style="list-style-type: none"> • Definition of fusing lamp full power <p>Continuously heating rate set point (maximum heating rate)</p> <ul style="list-style-type: none"> • Measurement start point <p>After reload (after fusing lamp extinguished, after rotation complete) below the standby temperature (target temperature), measurement starts after a fusing lamp heat-up request is issued.</p> <ul style="list-style-type: none"> • Measurement stop condition <p>Rotation started due to a print signal during measurement or other.</p> <ul style="list-style-type: none"> • Maximum heat-up duty (SP interlinked value) 0% is excluded. • Outside input voltage guarantee • Jammed paper between the thermopile and fusing unit • Thermopile lens dirt • Thermopile modification/float • After excessive temperature rise prevention unit operation • Fusing lamp disconnection • Harness disconnection between the fusing unit and the BICU or the PSU (AC controller board) • BICU defective • AC controller board defective <ul style="list-style-type: none"> • Thermistor modification/float • Fusing lamp disconnection • After excessive temperature rise prevention unit operation <p>1. Check the power supply voltage and reconnect the cable to the outlet.</p>

5.Troubleshooting

		<ol style="list-style-type: none"> 2. Remove the jammed paper between the thermopile and fusing unit. 3. Clean or Replace the thermopile (center) (TH1). 4. Replace the fusing sleeve thermostat. 5. Replace the fusing sleeve belt unit. 6. Reconnect or replace the harness between the fusing unit and the BICU or the PSU (AC controller board). 7. Replace the BICU (PCB10). 8. Replace the PSU (AC controller board) (PCB9).
--	--	--

SC No.	Type	Error Name/Error Condition/Major Cause/Solution
SC547-01	D	Zero cross error (relay-contact soldering)
		Zero-cross signal is detected while the fusing relay is OFF.
		<ul style="list-style-type: none"> • Fusing relay defective (contact soldering) • Fusing relay drive circuit error
		<ol style="list-style-type: none"> 1. Reconnect the connectors between PSU (AC controller board) and paper transport IOB (PCB1). 2. Replace the PSU (AC controller board) (PCB9). 3. Replace the paper transport IOB (PCB1).
SC547-02	D	Zero cross error (relay contact error)
		Zero-cross signal is not detected while the fusing relay is ON.
		<ul style="list-style-type: none"> • Fusing relay damage (contact open) • Fusing relay drive circuit error • PSU fuse (24 VS) blowout
		<ol style="list-style-type: none"> 1. Reconnect the connectors between PSU (AC controller board) and Paper transport IOB. 2. Replace the PSU (AC controller board) (PCB9). 3. Replace the paper transport IOB (PCB1). 4. Replace the harness between PSU (AC controller board) and paper transport IOB (PCB1).
SC547-03	D	Zero cross error (low-frequency error)
		Mains power supply frequency is determined to be 44 Hz or lower.
		Frequency instability of mains power supply
		<ol style="list-style-type: none"> 1. Check that the mains power supply frequency is higher than 44 Hz. If it is equal to or lower than 44 Hz, infrastructure may have defects to be dealt with. 2. Replace the PSU (AC controller board) (PCB9).

SC No.	Type	Error Name/Error Condition/Major Cause/Solution
SC549-	D	Fusing Shield Operation Error

02		
		During HP detection operation, shield sensors detect "High" for 2 sec. continuously.
SC549-03	D	Fusing Shield Operation Error
		During shield basic operation, shield motor does not stop even if 2 sec. elapsed from rotation start.
SC549-04	D	Fusing Shield Operation Error
		During HP detection operation, HP detection fails 5 times consecutively.
SC549-05	C	Fusing Shield Operation Error
		-
		<ul style="list-style-type: none"> • Fusing Shield Plate Position Sensor is loose, or disconnected. • Shield Drive Motor (M28) is disconnected. • Fusing Unit is damaged. <ol style="list-style-type: none"> 1. Check the Shield Plate Position Sensor with SP5-803-097 (SSP). If there is no response, reconnect the Fusing Shield Plate Position Sensor harness. 2. Reconnect the harness of the Shield Drive Motor (M28). 3. Replace the Fusing Unit. <p>Also, refer to When SC549 (Shield Operation Error Detection) is Displayed</p>

Fusing Sleeve (Edge) Error (SC55*-**)

SC No.	Type	Error Name/Error Condition/Major Cause/Solution
SC551-01	A	<p>Thermopile (Edge) Disconnection</p> <p>In Machine Condition A, after turning the fusing lamp on, the thermopile (edge) (TH2) has detected the temperature of -50°C or below continuously for 0.1 second. Machine Condition A refers to any of the following conditions:</p> <ul style="list-style-type: none"> • In Warm-up mode • At start-up and restart-up • Rotation after reload • Before/while/after printing • In Ready mode • In Panel Off mode • In Low Power mode <ul style="list-style-type: none"> • Thermopile disconnection • Thermistor disconnection • Connector error (disconnected, loose) <ol style="list-style-type: none"> 1. Reconnect the connectors (main machine side, BICU side).

5.Troubleshooting

		<p>2. Replace the thermopile (edge) (TH2).</p> <p>3. Replace the harness between the fusing unit and the BICU.</p> <p>4. Replace the BICU (PCB10), or the PSU (AC controller board) (PCB9).</p>
SC551-02	A	Non-contact Thermistor (Edge) Disconnection
		<p>In Machine Condition A, after turning the fusing lamp on, the non-contact thermistor (edge) (S47) has detected the temperature of 36°C or higher continuously for 1 second.</p> <p>Machine Condition A refers to any of the following conditions:</p> <ul style="list-style-type: none"> • In Warm-up mode • At start-up and restart-up • Rotation after reload • Before/while/after printing • In Ready mode • In Panel Off mode • In Low Power mode
		<ul style="list-style-type: none"> • Thermopile disconnection • Thermistor disconnection • Connector error (disconnected, loose)
		<p>1. Reconnect the connectors (between the fusing unit and the BICU).</p> <p>2. Replace the non-contact thermistor (S46) (S47) with the harness.</p> <p>3. Replace the fusing unit.</p> <p>4. Replace the harness between the fusing unit and the BICU.</p> <p>5. Replace the BICU (PCB10).</p>
SC551-03	A	Non-contact Thermistor (Edge) Short-circuit
		<p>In Machine Condition A, after turning the fusing lamp on, the non-contact thermistor (edge) (S47) has detected the AD value of 8 or below continuously for 1 second.</p> <p>Machine Condition A refers to any of the following conditions:</p> <ul style="list-style-type: none"> • In Warm-up mode • At start-up and restart-up • Rotation after reload • Before/while/after printing • In Ready mode • In Panel Off mode • In Low Power mode
		<ul style="list-style-type: none"> • Thermopile disconnection • Thermistor disconnection • Connector error (disconnected, loose)
		<p>1. Reconnect the connectors (between the fusing unit and the BICU).</p>

		<ol style="list-style-type: none"> <u>2.</u> Replace the non-contact thermistor (S46) (S47) with the harness. <u>3.</u> Replace the fusing unit. <u>4.</u> Replace the harness between the fusing unit and the BICU. <u>5.</u> Replace the BICU (PCB10).
--	--	--

SC No.	Type	Error Name/Error Condition/Major Cause/Solution
SC552-02	A	Thermopile (Edge) Does Not Reload
		<p>In Machine Condition B, after turning the fusing lamp (edge) on, the thermopile (edge) (TH2) has failed to reach 65°C in 14 seconds.</p> <p>Machine Condition B refers to any of the following conditions:</p> <ul style="list-style-type: none"> • In Warm-up mode • At start-up and restart-up
SC552-03	A	Thermopile (Edge) Does Not Reload
		<p>In Machine Condition B, after turning the fusing lamp (edge) on, the thermopile (edge) (TH2) has failed to reach the "permissible temperature for reloading" in 28 seconds.</p> <p>Machine Condition B refers to any of the following conditions:</p> <ul style="list-style-type: none"> • In Warm-up mode • At start-up and restart-up
SC552-05	D	Thermopile (Edge) Does Not Reload (Low Power)
		The detection criteria is the same as that for SC552-02.
SC552-06	D	Thermopile (Edge) Does Not Reload (Low Power)
		The detection criteria is the same as that for SC552-03.
		<ul style="list-style-type: none"> • Thermopile lens dirt • Thermopile modification/float • After excessive temperature rise prevention unit operation • Outside input voltage guarantee <ol style="list-style-type: none"> <u>1.</u> Check the power supply voltage and reconnect the cable to the outlet. <u>2.</u> Remove the jammed paper between the thermopile and fusing unit. <u>3.</u> Clean or replace the thermopile (edge). <u>4.</u> Replace the fusing sleeve thermostat. <u>5.</u> Reconnect the fusing sleeve belt unit. <u>6.</u> Reconnect or replace the harness between the fusing unit and the BICU or the PSU (AC controller board). <u>7.</u> Replace the BICU (PCB10). <u>8.</u> Replace the PSU (AC controller board) (PCB9).

SC No.	Type	Error Name/Error Condition/Major Cause/Solution
--------	------	---

5.Troubleshooting

SC553-00	A	Thermopile (Edge) High Temperature Detection (software)
		The thermopile (edge) (TH2) has detected the temperature of 240°C or higher continuously for 1 second.
		<ul style="list-style-type: none"> • Triac short-circuit • IOB board defective • BCU board defective
		<ol style="list-style-type: none"> 1. Inspect the fusing sleeve belt unit, and replace if damaged. 2. Check the paper settings. 3. Check the paper position in the paper feed tray. 4. Reconnect the connectors (main machine side, BICU side). 5. Inspect or replace the gears in the fusing unit or main machine. 6. Replace the thermopile (edge) (TH2). 7. Replace the harness between the fusing unit and the BICU or the PSU (AC controller board). 8. Replace the BICU (PCB10). 9. Replace the PSU (AC controller board) (PCB9). <p>If the problem cannot be solved after performing the above steps, replace the fusing unit.</p>

SC No.	Type	Error Name/Error Condition/Major Cause/Solution
SC554-01	A	Thermopile (Edge) high temperature detection (hardware)
		In the event of an error
		<ul style="list-style-type: none"> • Triac short-circuit • IOB board defective • BCU board defective
		<ol style="list-style-type: none"> 1. Inspect the fusing sleeve belt unit, and replace if damaged. 2. Check the paper settings. 3. Check the paper position in the paper feed tray. 4. Reconnect the connectors (main machine side, BICU side). 5. Inspect or replace the gears in the fusing unit or main machine. 6. Inspect the pressure roller HP sensor (S26) with SP5-803-047. 7. Replace the thermopile (edge) (TH2). 8. Replace the harness between the fusing unit and the BICU or the PSU (AC controller board). 9. Replace the BICU (PCB10). 10. Replace the PSU (AC controller board) (PCB9). <p>If the problem cannot be solved after performing the above steps, replace the fusing unit.</p>

SC No.	Type	Error Name/Error Condition/Major Cause/Solution
SC554-02	A	Non-contact Thermistor (Edge) high temperature detection (hardware)
		In the event of an error
		<ul style="list-style-type: none"> • Triac short-circuit • IOB board defective • BICU board defective
		<ol style="list-style-type: none"> <u>1.</u> Inspect the fusing sleeve belt unit, and replace if damaged. <u>2.</u> Check the paper settings. <u>3.</u> Check the paper position in the paper feed tray. <u>4.</u> Reconnect the connectors (main machine side, BICU side). <u>5.</u> Remove the jammed paper between the thermopile and fusing unit. <u>6.</u> Clean or replace the thermopile (edge) (TH2). <u>7.</u> Replace the fusing unit. <u>8.</u> Inspect the pressure roller HP sensor (S26) with SP5-803-047. <u>9.</u> Replace the harness between the fusing unit and the BICU or the PSU (AC controller board). <u>10.</u> Replace the BICU (PCB10). <u>11.</u> Replace the PSU (AC controller board) (PCB9).

SC No.	Type	Error Name/Error Condition/Major Cause/Solution
SC555-01	A	Fusing Edge Lamp Continuously Heat
SC555-05	D	Fusing Edge Lamp Continuously Heat (Low Power)
		<p>After waiting for full power for more than 5 sec continuously.</p> <ul style="list-style-type: none"> • Definition of fusing lamp full power Continuously heating rate set point (maximum heating rate) • Measurement start point After reload (after fusing lamp extinguished, after rotation complete) below the standby temperature (target temperature), measurement starts after a fusing lamp heat-up request is issued. • Measurement stop condition Rotation started due to a print signal during measurement or other Maximum heat-up Duty (SP interlinked value) 0% is excluded <ul style="list-style-type: none"> • Thermistor modification/float • Fusing lamp disconnection • After excessive temperature rise prevention unit operation <ol style="list-style-type: none"> <u>1.</u> Check the power supply voltage and reconnect the cable to the outlet. <u>2.</u> Remove the jammed paper between the thermopile and fusing unit.

5.Troubleshooting

		<p>3. Clean or replace the thermopile (edge) (TH2).</p> <p>4. Replace the fusing sleeve thermostat.</p> <p>5. Replace the fusing sleeve belt unit.</p> <p>6. Reconnect or replace the harness between the fusing unit and the BICU or the PSU (AC controller board).</p> <p>7. Replace the BICU (PCB10).</p> <p>8. Replace the PSU (AC controller board) (PCB9).</p>
--	--	--

SC No.	Type	Error Name/Error Condition/Major Cause/Solution
SC557-00	C	Zero Cross Frequency Exceeded
		In the event of an error
		Frequency instability of mains power supply /Noise
		-

SC No.	Type	Error Name/Error Condition/Major Cause/Solution
SC558-01	C	Low Input Voltage
		Input voltage below the specification is detected on the mains power supply
		Low input of mains power supply
		-

SC No.	Type	Error Name/Error Condition/Major Cause/Solution
SC559-00	A	Fusing Jam Detected for 3 Times Consecutively
		<p>Fusing jam (does not reach fusing exit sensor (S27)) is detected for 3 times consecutively.</p> <ul style="list-style-type: none"> Detection conditions <p>Displays the SC559-00 at the time of integrating the counter each time fusing jam occurs, became fusing jam counter value = 3.</p> <p>The counter value is retained without fusing jam also reset by OFF/ON the power supply.</p> <ul style="list-style-type: none"> Control ON/OFF <p>And enables ON / OFF is this SC, the default is set to OFF, then ON at the time of customer requirements.</p> <p>SP1-142-001 0: OFF (default), 1: ON (Set at the time of customer requirements)</p> <ul style="list-style-type: none"> Counter reset condition occurs fusing jam <ol style="list-style-type: none"> Normal paper exit has been done during this continuous fusing jam, fusing jam counter is reset. When "1" is changed to "0" SP1-142-001, to reset the (SP9-912-001) fusing jam counter.

		3. When after displaying SC559, SC release is made, reset the (SP9912-001) fusing jam counter.
		Fusing unit paper jam
		<ol style="list-style-type: none"> 1. Inspect or replace the stripper plate. 2. Replace the gears in the fusing unit or main machine. 3. Replace the fusing motor (M8). 4. Replace the fusing unit.

Pressure Roller Thermistor (Center) Error (SC56*-**)

SC No.	Type	Error Name/Error Condition/Major Cause/Solution
SC561-01	A	Pressure Roller Thermistor (Center) Disconnection
SC561-05	D	Pressure Roller Thermistor (Center) Disconnection (Low Power)
		<p>In Machine Condition A, after turning the fusing lamp on, the pressure roller thermistor (center) (TH3) has detected the temperature of 0°C or below continuously for 20 seconds.</p> <p>Machine Condition A refers to any of the following conditions:</p> <ul style="list-style-type: none"> • In Warm-up mode • At start-up and restart-up • Rotation after reload • Before/while/after printing • In Ready mode • In Panel Off mode • In Low Power mode
		<ul style="list-style-type: none"> • Thermopile disconnection • Thermistor disconnection • Connector error (disconnected, loose)
		<ol style="list-style-type: none"> 1. Check the power supply voltage and reconnect the cable to the outlet. (-05 only) 2. Reconnect the connectors (between the fusing unit and the BICU). 3. Replace the pressure roller thermistor (center) (TH3). 4. Replace the fusing unit. 5. Replace the harness between the fusing unit and the BICU or the PSU (AC controller board). 6. Replace the BICU (PCB10). 7. Replace the fusing sleeve belt unit. 8. Replace the PSU (AC controller board) (PCB9).

5.Troubleshooting

SC No.	Type	Error Name/Error Condition/Major Cause/Solution
SC562-02	A	Pressure Roller Thermistor (Center) Does Not Reload
SC562-05	D	Pressure Roller Thermistor (Center) Does Not Reload (Low Power)
		<p>In Machine Condition B, after turning the fusing lamp (center) on, the pressure roller thermistor (center) (TH3) has failed to reach 40°C in 12 seconds. Machine Condition B refers to any of the following conditions:</p> <ul style="list-style-type: none"> • In Warm-up mode • At start-up and restart-up <hr/> <ul style="list-style-type: none"> • Thermistor dirt • Thermistor modification/float • Outside input voltage guarantee • After excessive temperature rise prevention unit operation <hr/> <ol style="list-style-type: none"> <u>1.</u> Check the power supply voltage and reconnect the cable to the outlet. <u>2.</u> Clean or replace the pressure roller thermistor (center) (TH3). <u>3.</u> Replace the fusing sleeve thermostat. <u>4.</u> Replace the fusing sleeve belt unit. <u>5.</u> Replace the harness between the fusing unit and the BICU or the PSU (AC controller board). <u>6.</u> Replace the thermopile (center) (TH1). <u>7.</u> Replace the BICU (PCB10). <u>8.</u> Replace the PSU (AC controller board) (PCB9).

SC No.	Type	Error Name/Error Condition/Major Cause/Solution
SC563-00	A	Pressure Roller Thermistor (Center) High Temperature Detection (software)
		<p>The pressure roller thermistor (center) (TH3) has detected the temperature of 230°C or higher continuously for 1 second.</p> <ul style="list-style-type: none"> • Triac short-circuit • IOB board defective • BICU board defective <hr/> <ol style="list-style-type: none"> <u>1.</u> Check the paper settings. <u>2.</u> Check the paper position in the paper feed tray. <u>3.</u> Reconnect the connectors (main machine side, BICU side). <u>4.</u> Remove the jammed paper between the center thermopile and fusing unit. <u>5.</u> Clean or replace the thermopile (center) (TH1). <u>6.</u> Replace the harness between the fusing unit and the BICU or the PSU (AC controller board). <u>7.</u> Replace the BICU (PCB10).

		<p>8. Replace the PSU (AC controller board) (PCB9).</p> <p>9. If the problem cannot be solved after performing the above steps, replace the fusing unit.</p>
--	--	--

SC No.	Type	Error Name/Error Condition/Major Cause/Solution
SC564-00	A	Pressure Roller Thermistor (Center) High Temperature Detection (Hardware)
		Above 240 degrees C detected.
		<ul style="list-style-type: none"> • Triac short-circuit • IOB board defective • BICU board defective
		<p>1. Check the paper settings.</p> <p>2. Check the paper position in the paper feed tray.</p> <p>3. Reconnect the connectors (main machine side, BICU side).</p> <p>4. Remove the jammed paper between the center thermopile and fusing unit.</p> <p>5. Clean or replace the thermopile (center) (TH1).</p> <p>6. Inspect the pressure roller HP sensor (S26) with SP5-803-047.</p> <p>7. Replace the harness between the fusing unit and the BICU or the PSU (AC controller board).</p> <p>8. Replace the BICU (PCB10).</p> <p>9. Replace the PSU (AC controller board) (PCB9).</p> <p>10. If the problem cannot be solved after performing the above steps, replace the fusing unit.</p>

SC No.	Type	Error Name/Error Condition/Major Cause/Solution
SC569-00	D	Paper Exit/ Pressure Release Motor Error Detection
		Retry operation fails 3 times consecutively.
		<ul style="list-style-type: none"> • Pressure roller HP sensor (S26) disconnected • Pressure release encoder modification • Fusing unit defective • Paper exit/ pressure release motor disconnected
		<p>Inspect the pressure roller HP sensor (S26) with SP5-803-047.</p> <p>If no response from the sensor, perform steps 1 and 2.</p> <p>1. Check the connection of the pressure roller HP sensor (S26).</p> <p>2. Inspect the pressure roller HP sensor (S26).</p> <p>3. Inspect the pressure release encoder.</p> <p>4. Replace the fusing unit.</p> <p>5. Check the connectors of the paper exit/ pressure release motor (M4).</p>

5.Troubleshooting

Pressure Roller Thermistor (Edge) Error (SC57*-**)

SC No.	Type	Error Name/Error Condition/Major Cause/Solution
SC571-01	A	Pressure Roller Thermistor (Edge) Disconnection
SC571-05	D	Pressure Roller Thermistor (Edge) Disconnection (Low Power)
		<p>In Machine Condition A, after turning the fusing lamp on, the pressure roller thermistor (edge) (TH4) has detected the temperature of 0°C or below continuously for 40 seconds.</p> <p>Machine Condition A refers to any of the following conditions:</p> <ul style="list-style-type: none"> • In Warm-up mode • At start-up and restart-up • Rotation after reload • Before/while/after printing • In Ready mode • In Panel Off mode • In Low Power mode
		<ul style="list-style-type: none"> • Thermopile disconnection • Thermistor disconnection • Connector error (disconnected, loose)
		<ol style="list-style-type: none"> <u>1.</u> Check the power supply voltage and reconnect the cable to the outlet. (-05 only) <u>2.</u> Reconnect the connectors (between the fusing unit and the BICU or the PSU (AC controller board). <u>3.</u> Replace the pressure roller thermistor (edge) (TH4). <u>4.</u> Replace the fusing unit. <u>5.</u> Replace the harness between the fusing unit and the BICU or the PSU (AC controller board). <u>6.</u> Replace the BICU (PCB10). <u>7.</u> Replace the fusing sleeve belt unit. <u>8.</u> Replace the PSU (AC controller board) (PCB9).

SC No.	Type	Error Name/Error Condition/Major Cause/Solution
SC572-04	A	Pressure Roller Thermistor (Edge) Does Not Reload
SC572-05	D	Pressure Roller Thermistor (Edge) Does Not Reload (Low Power)
		After starting to print a job with the paper width of 257 mm or more, the pressure

		roller thermistor (edge) (TH4) has failed to reach 0°C in 100 seconds.
		<ul style="list-style-type: none"> • Thermistor dirt • Thermistor modification/float • Outside input voltage guarantee • After excessive temperature rise prevention unit operation
		<ol style="list-style-type: none"> <u>1.</u> Check the power supply voltage and reconnect the cable to the outlet. <u>2.</u> Replace the fusing sleeve thermostat. <u>3.</u> Replace the fusing sleeve belt unit. <u>4.</u> Replace the thermistor. <u>5.</u> Replace the BICU (PCB10) or PSU (AC controller board).

SC No.	Type	Error Name/Error Condition/Major Cause/Solution
SC573-00	A	Pressure Roller Thermistor (Edge) High Temperature Detection (software)
		The pressure roller thermistor (edge) (TH4) has detected the temperature of 230°C or higher continuously for 1 second.
		<ul style="list-style-type: none"> • Triac short-circuit • IOB board defective • BICU board defective
		<ol style="list-style-type: none"> <u>1.</u> Reconnect the connector. <u>2.</u> Clean or replace the thermopile (edge) (TH2). <u>3.</u> Replace the harness between the fusing unit and the BICU or the PSU (AC controller board). <u>4.</u> Replace the BICU (PCB10). <u>5.</u> If the problem cannot be solved after performing the above steps, replace the fusing unit.

SC No.	Type	Error Name/Error Condition/Major Cause/Solution
SC574-00	A	Pressure Roller Thermistor (edge) High Temperature Detection (hardware)
		Above 240 degrees C detected
		<ul style="list-style-type: none"> • Triac short-circuit • IOB board defective • BICU board defective
		<ol style="list-style-type: none"> <u>1.</u> Reconnect the connector. <u>2.</u> Clean or replace the thermopile (edge) (TH2). <u>3.</u> Replace the harness between the fusing unit and the BICU or the PSU (AC controller board). <u>4.</u> Replace the BICU (PCB10). <u>5.</u> If the problem cannot be solved after performing the above steps, replace the

5.Troubleshooting

		fusing unit.
--	--	--------------

Pressure Roller Thermistor (Full-Bleed Edge) Error (SC58*-**)

SC No.	Type	Error Name/Error Condition/Major Cause/Solution
SC581-01	A	Pressure Roller Thermistor (Full-bleed edge) Thermistor Disconnection
SC581-05	D	Pressure Roller Thermistor (Full-bleed edge) Disconnection (Low Power)
		<p>In Machine Condition A, after turning the fusing lamp on, the pressure roller thermistor (full-bleed edge) (TH5) has detected the temperature of 0°C or below continuously for 40 seconds.</p> <p>Machine Condition A refers to any of the following conditions:</p> <ul style="list-style-type: none"> • In Warm-up mode • At start-up and restart-up • Rotation after reload • Before/while/after printing • In Ready mode • In Panel Off mode • In Low Power mode
		<ul style="list-style-type: none"> • Thermopile disconnection • Thermistor disconnection • Connector error (disconnected, loose)
		<ol style="list-style-type: none"> <u>1.</u> Check the power supply voltage and reconnect the cable to the outlet. (-05 only) <u>2.</u> Replace the fusing sleeve thermostat (edge/center). <u>3.</u> Replace the pressure roller thermistor (full-bleed edge) (TH5). <u>4.</u> Replace the fusing sleeve belt unit. <u>5.</u> Replace the thermopile (edge) (TH2) <u>6.</u> Replace the BICU (PCB10). <u>7.</u> Replace the PSU (AC controller board) (PCB9).

SC No.	Type	Error Name/Error Condition/Major Cause/Solution
SC582-04	A	Pressure Roller Thermistor (Full-bleed edge) Does Not Reload
SC582-05	D	Pressure Roller Thermistor (Full-bleed edge) Does Not Reload (Low Power)
		<p>After starting to print a job with the paper width of 257 mm or more, the pressure roller thermistor (full-bleed edge) (TH5) has failed to reach 0°C in 100 seconds.</p> <ul style="list-style-type: none"> • Thermistor dirt

		<ul style="list-style-type: none"> • Thermistor modification/float • Outside input voltage guarantee • After excessive temperature rise prevention unit operation
		<ol style="list-style-type: none"> <u>1.</u> Check the power supply voltage and reconnect the cable to the outlet. <u>2.</u> Clean or replace the pressure roller thermistor (full-bleed edge) (TH5). <u>3.</u> Replace the fusing sleeve thermostat. <u>4.</u> Replace the fusing sleeve belt unit. <u>5.</u> Replace the harness between the fusing unit and the BICU or the PSU (AC controller board). <u>6.</u> replace the thermopile (edge) (TH2). <u>7.</u> Replace the BICU (PCB10). <u>8.</u> Replace the PSU (AC controller board) (PCB9).

SC No.	Type	Error Name/Error Condition/Major Cause/Solution
SC583-00	A	Pressure Roller Thermistor (Full-bleed edge) High Temperature Detection (software)
		The pressure roller thermistor (full-bleed edge) (TH4) has detected the temperature of 230°C or higher continuously for 1 second.
		<ul style="list-style-type: none"> • Triac short-circuit • IOB board defective • BICU board defective
		<ol style="list-style-type: none"> <u>1.</u> Check the paper settings. <u>2.</u> Check the paper position in the paper feed tray. <u>3.</u> Reconnect the connectors (main machine side, BICU side). <u>4.</u> Remove the jammed paper between the thermopile and fusing unit. <u>5.</u> Clean or replace the thermopile (edge) (TH2). <u>6.</u> Replace the harness between the fusing unit and the BICU or the PSU (AC controller board). <u>7.</u> Replace the BICU (PCB10). <u>8.</u> Replace the PSU (AC controller board) (PCB9). <u>9.</u> If the problem cannot be solved after performing the above steps, replace the fusing unit.

SC No.	Type	Error Name/Error Condition/Major Cause/Solution
SC584-00	A	Pressure Roller Thermistor (Full-bleed edge) High Temperature Detection (hardware)
		Above 240 degrees C detected
		<ul style="list-style-type: none"> • Triac short-circuit • IOB board defective

5.Troubleshooting

	<ul style="list-style-type: none">• BICU board defective
	<ol style="list-style-type: none"><u>1.</u> Check the paper settings.<u>2.</u> Check the paper position in the paper feed tray.<u>3.</u> Reconnect the connectors (main machine side, BICU side).<u>4.</u> Remove the jammed paper between the thermopile and fusing unit.<u>5.</u> Clean or replace the thermopile (edge) (TH2).<u>6.</u> Inspect the pressure roller HP sensor (S26) with SP5-803-047.<u>7.</u> Replace the harness between the fusing unit and the BICU or the PSU (AC controller board).<u>8.</u> Replace the BICU (PCB10).<u>9.</u> Replace the PSU (AC controller board) (PCB9).<u>10.</u> If the problem cannot be solved after performing the above steps, replace the fusing unit.

SC600**SC600 (Engine: Communication and Others)**

SC No.	Type	Error Name/Error Condition/Major Cause/Solution
SC620-01	D	ADF Communication error 1
		After ADF connection was recognized on startup, an error is detected. (disconnection detection)
		<ul style="list-style-type: none"> • ADF connection error • ADF deflection • BICU deflection • Noise contamination
		<p>Check if the SC occurs by turning the main power OFF then ON. If the SC occurs again, do the following steps. Check if the SC reoccurs by cycling the power after each step.</p> <ol style="list-style-type: none"> 1. Check if all connectors related to SPDF/ARDF are connected securely. Reconnect the connectors if they are disconnected, or loose. 2. Check the machine and ADF firmware version. <ul style="list-style-type: none"> • Proceed to Step 3 if there is no new firmware released. • Run the firmware update when there is a new firmware released. 3. Check the harness. Replace the harness if it is disconnected, or damaged. 4. Replace the BICU (PCB10). 5. Check if there are any signs of a short circuit on the SPDF/ARDF Main Board. If there are any defects, replace the board.

SC No.	Type	Error Name/Error Condition/Major Cause/Solution
SC620-02	D	ADF Communication error 2
		After ADF connection was recognized on startup, an error is detected. (Retry out due to communication error)
		<ul style="list-style-type: none"> • ADF connection error • ADF deflection • Noise contamination
		Follow the solution for SC620-01.

SC No.	Type	Error Name/Error Condition/Major Cause/Solution
SC620-03	D	ADF Communication error 3
		SC is displayed when CIS initialization complete command is not received for

5.Troubleshooting

SC No.	Type	Error Name/Error Condition/Major Cause/Solution
		certain time.
		<ul style="list-style-type: none"> • ADF connection error • ADF defection • BICU board defection • Noise contamination • Unsupported ADF is connected
		<p>Check if the SC occurs by turning the main power OFF then ON. If the SC occurs again, do the following steps. Check if the SC reoccurs by cycling the power after each step.</p> <ol style="list-style-type: none"> 1. Check if all connectors related to SPDF/ARDF are connected securely. Reconnect the connectors if they are disconnected, or loose. 2. Check the harness. Replace the harness if it is disconnected, or damaged. 3. Check if there are any signs of a short circuit on the SPDF Main Board. If there are any defects, replace the board.

SC No.	Type	Error Name/Error Condition/Major Cause/Solution
SC620-04	D	ADF Communication error 4
		Communication error detected between ADF connected by ASAP and machine. (When changing the baud rate, the machine failed to detect the break signal of the ADF within the specified time or the break signal of the ADF continued beyond the specified time.)
		<ul style="list-style-type: none"> • ADF connection error • ADF defection • BICU board defection • Noise contamination
		<p>Check if the SC occurs by turning the main power OFF then ON. If the SC occurs again, do the following steps. Check if the SC reoccurs by cycling the power after each step.</p> <ol style="list-style-type: none"> 1. Check if all connectors related to SPDF/ARDF are connected securely. Reconnect the connectors if they are disconnected, or loose. 2. Check the machine and ADF firmware version. <ul style="list-style-type: none"> • Proceed to Step 3 if there is no new firmware released. • Run the firmware update when there is a new firmware released. 3. Check the harness. Replace the harness if it is disconnected, or damaged. 4. Replace the BICU (PCB10). 5. Check if there are any signs of a short circuit on the SPDF Main Board. If there are any defects, replace the board.

SC No.	Type	Error Name/Error Condition/Major Cause/Solution
SC621-00	D	Finisher communication error
		<ul style="list-style-type: none"> • Detected an error when connecting the communication line. • Received a communication error notification from the URAT.
		<ul style="list-style-type: none"> • Finisher control board defective. • BICU defective • IOB defective • Connection error between finisher and main machine.
		<ul style="list-style-type: none"> • Reconnect the Finisher interface cable. • Replace the BICU (PCB10). • Replace the Imaging IOB (PCB2). • Replace the finisher. • Turn the power off/on.

SC No.	Type	Error Name/Error Condition/Major Cause/Solution
SC622-01	D	Paper bank 1 communication error for Paper Feed Unit PB3270
SC622-11	D	Paper bank 1 communication error for Paper Feed Unit PB3300/Paper Feed Unit PB3280
SC622-12	D	Paper bank 1 communication error for Paper Feed Unit PB3300/Paper Feed Unit PB3280
SC622-31	D	Paper bank 1 communication error for LCIT PB3290
		<ul style="list-style-type: none"> • Detected an error when connecting the communication line. • Received a communication error notification from the URAT.
		<ul style="list-style-type: none"> • Paper bank control board defective • BICU defective • IOB defective • Paper bank-main machine connection error
		<p>Check if the SC occurs by turning the main power OFF then ON. If the SC occurs again, do the following steps. Check if the SC reoccurs by cycling the power after each step.</p> <ol style="list-style-type: none"> 1. Check if all connectors in tray 1, 2, and optional paper tray are connected securely. Reconnect the connectors if they are disconnected, or loose. 2. Check the harness in tray 1, 2, and optional paper tray. Replace the harness if it is disconnected, or damaged. 3. Check if there are any signs of a short circuit on the Bank Main Board. If there

5.Troubleshooting

SC No.	Type	Error Name/Error Condition/Major Cause/Solution
		are any defects, replace the board.

SC No.	Type	Error Name/Error Condition/Major Cause/Solution
SC623-00	D	Paper bank 2 communication error for LCIT RT3040
		During superposition of single bank - double bank, double bank - side LICT, and LCIT - side LCIT, <ol style="list-style-type: none"> 1. When the upper bank side recognizes the lower bank, the break of the lower bank is not canceled within the specified time (ms.). 2. After the upper bank side recognizes the lower bank, there is no ACK within the specified time (ms.) after transmission of a data frame to the lower bank, and a timeout error occurs for 3 times consecutively even if retransmission is performed
		<ul style="list-style-type: none"> • Bank control board error • Connector disconnected
		Check if the SC occurs by turning the main power OFF then ON. If the SC occurs again, do the following steps. Check if the SC reoccurs by cycling the power after each step. <ol style="list-style-type: none"> 1. Check if all connectors in the one-tray paper feed unit or two-tray paper feed unit are connected securely. Reconnect the connectors if they are disconnected, or loose. 2. Check the harness in the one-tray paper feed unit or two-tray paper feed unit. Replace the harness if it is disconnected, or damaged. 3. Check if there are any signs of a short circuit on Paper Transport IOB (PCB1), or side LCIT. If there are any defects, replace the board.

SC No.	Type	Error Name/Error Condition/Major Cause/Solution
SC663-01	D	Reset Detection: Imaging IOB: Software hang-up occurs
SC663-02	D	Reset Detection: Imaging IOB: Power ON reset occurs
SC663-03	D	Reset Detection: Imaging IOB: Software reset occurs
SC663-11	D	Reset Detection: Paper Transport IOB: Software hang-up occurs
SC663-12	D	Reset Detection: Paper Transport IOB: Power ON reset occurs

SC No.	Type	Error Name/Error Condition/Major Cause/Solution
SC663-13	D	Reset Detection: Paper Transport IOB: Software reset occurs
		SC is displayed when unexpected reset from Imaging IOB/Paper Transport IOB (PCB1) is detected while standby/operation.
		<ul style="list-style-type: none"> • Unexpected noise from inside the machine gets into Paper Transport IOB (PCB1). • Parts defect and implementation defect of Imaging IOB/ Paper Transport IOB (PCB1). • Software ran reset to ASIC when there was a bug in the software or unexpected signal was input (-03/-13 only).
		<ol style="list-style-type: none"> <u>1.</u> Turn the main power OFF/ON. <u>2.</u> Replace the Paper Transport IOB (PCB1) (-01 to -03) <u>3.</u> Replace the Imaging IOB (PCB2) (-11 to -13)

SC No.	Type	Error Name/Error Condition/Major Cause/Solution
SC664-01	D	VODKA1 (Paper Transport Vodka) access permission error to VODKA SRAM
SC664-02	D	VODKA1 (Paper Transport Vodka) write error to VODKA SRAM
SC664-03	D	VODKA1 (Paper Transport Vodka) VODKA program launch error
SC664-11	D	VODKA2 (Imaging Vodka) access permission error to VODKA SRAM
SC664-12	D	VODKA2 (Imaging Vodka) write error to VODKA SRAM
SC664-13	D	VODKA2 (Imaging Vodka) VODKA program launch error
		The machine detects the communication error between VODKA and SRAM when starting up, or recovery from energy saving mode.
		<p>The following board defects (Parts implementation defect, solder scrap, implemented parts defect, etc.);</p> <ul style="list-style-type: none"> • BICU • Imaging IOB (PCB2) • Paper Transport IOB (PCB1)
		<p>-01 to 03</p> <ol style="list-style-type: none"> <u>1.</u> Turn the main power OFF/ON. <u>2.</u> Replace the Paper Transport IOB (PCB1).

5.Troubleshooting

SC No.	Type	Error Name/Error Condition/Major Cause/Solution
		<ol style="list-style-type: none"> 3. Replace the BICU (PCB10). 4. Replace the Imaging IOB (PCB2). <p>-11 to 13</p> <ol style="list-style-type: none"> 1. Turn the main power OFF/ON. 2. Replace the Imaging IOB (PCB2). 3. Replace the BICU (PCB10).

SC No.	Type	Error Name/Error Condition/Major Cause/Solution
SC665-04	D	IOB does not start up
		The IOB does not start up when starting up, or recovery from energy saving mode.
		<ul style="list-style-type: none"> • Connector disconnected • Harness disconnected • The following board defects (Parts implementation defect, solder scrap, implemented parts defect, etc.) <ul style="list-style-type: none"> • BICU • Imaging IOB (PCB2) • Paper Transport IOB (PCB1)
		<ol style="list-style-type: none"> 1. Turn the main power OFF/ON. 2. Reconnect the following FFC; <ul style="list-style-type: none"> • BICU - Imaging IOB • Imaging IOB (PCB2) - Paper Transport IOB (PCB1) 3. Replace the following FFC; <ul style="list-style-type: none"> • BICU - Imaging IOB • Imaging IOB (PCB2) - Paper Transport IOB (PCB1) 4. Replace the BICU (PCB10). 5. Replace the Imaging IOB (PCB2). 6. Replace the Paper Transport IOB (PCB1).

SC No.	Type	Error Name/Error Condition/Major Cause/Solution
SC665-05	D	Master Device Communication Error
		The machine detects the communication error between CPU and Slave1 when starting up, or recovery from energy saving mode.
		<ul style="list-style-type: none"> • FFC connection error • FFC defective (disconnected, foreign object, etc.) • The following board defects (Parts implementation defect, solder scrap,

SC No.	Type	Error Name/Error Condition/Major Cause/Solution
		<p>implemented parts defect, etc.);</p> <ul style="list-style-type: none"> • BICU • Imaging IOB (PCB2) • Paper Transport IOB (PCB1).
		<ol style="list-style-type: none"> 1. Turn the main power OFF/ON. 2. Reconnect the following FFC; <ul style="list-style-type: none"> • BICU - Imaging IOB • Imaging IOB (PCB2) - Paper Transport IOB (PCB1) 3. Replace the following FFC; <ul style="list-style-type: none"> • BICU - Imaging IOB • Imaging IOB (PCB2) - Paper Transport IOB (PCB1) 4. Disconnect and then reconnect all the harnesses connecting the PSU and IOB. 5. Replace all the harnesses connecting the PSU and IOB. 6. Replace the BICU (PCB10). 7. Replace the Imaging IOB (PCB2). 8. Replace the Paper Transport IOB (PCB1).

SC No.	Type	Error Name/Error Condition/Major Cause/Solution
SC665-06	D	IPU and IOB signal Communication Error
		The machine detects the communication error between CPU and Slave1 when starting up, or recovery from energy saving mode.
		<ul style="list-style-type: none"> • FFC connection error • FFC defective (disconnected, foreign object, etc.) • The following board defects (Parts implementation defect, solder scrap, implemented parts defect, etc.); <ul style="list-style-type: none"> • BICU • Imaging IOB (PCB2) • Paper Transport IOB (PCB1).
		<ol style="list-style-type: none"> 1. Turn the main power OFF/ON. 2. Reconnect the following FFC; <ul style="list-style-type: none"> • BICU - Imaging IOB • Imaging IOB (PCB2) - Paper Transport IOB (PCB1) 3. Replace the following FFC; <ul style="list-style-type: none"> • BICU - Imaging IOB

5.Troubleshooting

SC No.	Type	Error Name/Error Condition/Major Cause/Solution
		<ul style="list-style-type: none"> • Imaging IOB (PCB2) - Paper Transport IOB (PCB1) <ol style="list-style-type: none"> 4. Replace the BICU (PCB10). 5. Replace the Imaging IOB (PCB2). 6. Replace the Paper Transport IOB (PCB1).

SC No.	Type	Error Name/Error Condition/Major Cause/Solution
SC665-07	D	IPU signal Communication Error
		The machine detects the communication error between CPU and Slave device when starting up, or recovery from energy saving mode.
		<ul style="list-style-type: none"> • FFC connection error • FFC defective (disconnected, foreign object, etc.) • The following board defects (Parts implementation defect, solder scrap, implemented parts defect, etc.); <ul style="list-style-type: none"> • BICU
		<ol style="list-style-type: none"> 1. Turn the main power OFF/ON. 2. Replace the BICU (PCB10).

SC No.	Type	Error Name/Error Condition/Major Cause/Solution
SC665-08	D	IOB signal Communication Error
		The machine detects the communication error between CPU and Slave1 when starting up, or recovery from energy saving mode.
		<ul style="list-style-type: none"> • FFC connection error • FFC defective (disconnected, foreign object, etc.) • The following board defects (Parts implementation defect, solder scrap, implemented parts defect, etc.); <ul style="list-style-type: none"> • BICU • Imaging IOB (PCB2) • Paper Transport IOB (PCB1).
		<ol style="list-style-type: none"> 1. Turn the main power OFF/ON. 2. Reconnect the following FFC; <ul style="list-style-type: none"> • BICU - Imaging IOB • Imaging IOB (PCB2) - Paper Transport IOB (PCB1) 3. Replace the following FFC; <ul style="list-style-type: none"> • BICU - Imaging IOB • Imaging IOB (PCB2) - Paper Transport IOB (PCB1)

SC No.	Type	Error Name/Error Condition/Major Cause/Solution
		<ol style="list-style-type: none"> 4. Replace the BICU (PCB10). 5. Replace the Imaging IOB (PCB2). 6. Replace the Paper Transport IOB (PCB1).

SC No.	Type	Error Name/Error Condition/Major Cause/Solution
SC665-11	D	Vodka1 Communication Error
		The machine detects the communication error between CPU and Vodka1 when starting up, or recovery from energy saving mode.
		<ul style="list-style-type: none"> • FFC connection error • FFC defective (disconnected, foreign object, etc.) • The following board defects (Parts implementation defect, solder scrap, implemented parts defect, etc.); <ul style="list-style-type: none"> • BICU • Paper Transport IOB (PCB1).
		<ol style="list-style-type: none"> 1. Turn the main power OFF/ON. 2. Reconnect the following FFC; <ul style="list-style-type: none"> • BICU - Imaging IOB • Imaging IOB (PCB2) - Paper Transport IOB (PCB1) 3. Replace the following FFC; <ul style="list-style-type: none"> • BICU - Imaging IOB • Imaging IOB (PCB2) - Paper Transport IOB (PCB1) 4. Replace the BICU (PCB10) and Imaging IOB (PCB2). 5. Replace the Paper Transport IOB (PCB1).

SC No.	Type	Error Name/Error Condition/Major Cause/Solution
SC665-12	D	Vodka2 Communication Error
		The machine detects the communication error between CPU and Vodka2 when starting up, or recovery from energy saving mode.
		<ul style="list-style-type: none"> • FFC connection error • FFC defective (disconnected, foreign object, etc.) • The following board defects (Parts implementation defect, solder scrap, implemented parts defect, etc.); <ul style="list-style-type: none"> • BICU • Imaging IOB (PCB2).
		<ol style="list-style-type: none"> 1. Turn the main power OFF/ON.

5.Troubleshooting

SC No.	Type	Error Name/Error Condition/Major Cause/Solution
		<ol style="list-style-type: none"> <u>2.</u> Reconnect the FFC between BICU and Imaging IOB (PCB2). <u>3.</u> Replace the FFC between BICU and Imaging IOB (PCB2). <u>4.</u> Replace the BICU (PCB10). <u>5.</u> Replace the Imaging IOB (PCB2).

SC No.	Type	Error Name/Error Condition/Major Cause/Solution
SC665-41	D	Macaron1 Communication Error
		The machine detects the communication error between CPU and Macaron1 when starting up, or recovery from energy saving mode.
		<ul style="list-style-type: none"> • FFC connection error • FFC defective (disconnected, foreign object, etc.) • The following board defects (Parts implementation defect, solder scrap, implemented parts defect, etc.); <ul style="list-style-type: none"> • BICU
		<ol style="list-style-type: none"> <u>1.</u> Turn the main power OFF/ON. <u>2.</u> Replace the BICU (PCB10).

SC No.	Type	Error Name/Error Condition/Major Cause/Solution
SC665-42	D	Macaron2 Communication Error
		The machine detects the communication error between CPU and Macaron2 when starting up, or recovery from energy saving mode.
		<ul style="list-style-type: none"> • FFC connection error • FFC defective (disconnected, foreign object, etc.) • The following board defects (Parts implementation defect, solder scrap, implemented parts defect, etc.); <ul style="list-style-type: none"> • BICU
		<ol style="list-style-type: none"> <u>1.</u> Turn the main power OFF/ON. <u>2.</u> Replace the BICU (PCB10).

SC No.	Type	Error Name/Error Condition/Major Cause/Solution
SC665-61	D	Vodka1 Communication Error (Continuous Monitoring)
		The machine detects the communication error between CPU and Vodka1 in continuous monitoring.
		<ul style="list-style-type: none"> • FFC connection error

SC No.	Type	Error Name/Error Condition/Major Cause/Solution
		<ul style="list-style-type: none"> • FFC defective (disconnected, foreign object, etc.) • The following board defects (Parts implementation defect, solder scrap, implemented parts defect, etc.); <ul style="list-style-type: none"> • BICU • Paper Transport IOB (PCB1).
		<ol style="list-style-type: none"> 1. Turn the main power OFF/ON. 2. Reconnect the following FFC; <ul style="list-style-type: none"> • BICU - Imaging IOB • Imaging IOB (PCB2) - Paper Transport IOB (PCB1) 3. Replace the following FFC; <ul style="list-style-type: none"> • BICU - Imaging IOB • Imaging IOB (PCB2) - Paper Transport IOB (PCB1) 4. Replace the BICU (PCB10) and Imaging IOB (PCB2). 5. Replace the Paper Transport IOB (PCB1).

SC No.	Type	Error Name/Error Condition/Major Cause/Solution
SC665-62	D	Vodka2 Communication Error (Continuous Monitoring)
		The machine detects the communication error between CPU and Vodka2 in continuous monitoring.
		<ul style="list-style-type: none"> • FFC connection error • FFC defective (disconnected, foreign object, etc.) • The following board defects (Parts implementation defect, solder scrap, implemented parts defect, etc.); <ul style="list-style-type: none"> • BICU • Imaging IOB (PCB2).
		<ol style="list-style-type: none"> 1. Turn the main power OFF/ON. 2. Reconnect the FFC between BICU and Imaging IOB (PCB2). 3. Replace the FFC between BICU and Imaging IOB (PCB2). 4. Replace the BICU (PCB10). 5. Replace the Imaging IOB (PCB2).

SC No.	Type	Error Name/Error Condition/Major Cause/Solution
SC665-41	D	Macaron1 Communication Error (Continuous Monitoring)
		The machine detects the communication error between CPU and Macaron1 in continuous monitoring.

5.Troubleshooting

SC No.	Type	Error Name/Error Condition/Major Cause/Solution
		<ul style="list-style-type: none"> • FFC connection error • FFC defective (disconnected, foreign object, etc.) • The following board defects (Parts implementation defect, solder scrap, implemented parts defect, etc.); <ul style="list-style-type: none"> • BICU
		<ol style="list-style-type: none"> 1. Turn the main power OFF/ON. 2. Replace the BICU (PCB10).

SC No.	Type	Error Name/Error Condition/Major Cause/Solution
SC665-42	D	Macaron2 Communication Error (Continuous Monitoring)
		The machine detects the communication error between CPU and Macaron2 in continuous monitoring.
		<ul style="list-style-type: none"> • FFC connection error • FFC defective (disconnected, foreign object, etc.) • The following board defects (Parts implementation defect, solder scrap, implemented parts defect, etc.); <ul style="list-style-type: none"> • BICU
		<ol style="list-style-type: none"> 1. Turn the main power OFF/ON. 2. Replace the BICU (PCB10).

SC No.	Type	Error Name/Error Condition/Major Cause/Solution
SC667-01	D	Master Device Mode Setting Error
		The machine detects the CPU mode error when starting up, or recovery from energy saving mode.
		The following board defects (Parts implementation defect, solder scrap, implemented parts defect, etc.); <ul style="list-style-type: none"> • BICU
		<ol style="list-style-type: none"> 1. Turn the main power OFF/ON. 2. Replace the BICU (PCB10).

SC No.	Type	Error Name/Error Condition/Major Cause/Solution
SC667-10	D	Slave1 Device Mode Setting Error
		The machine detects the Slave1 mode error when starting up, or recovery from

SC No.	Type	Error Name/Error Condition/Major Cause/Solution
		energy saving mode.
		The following board defects (Parts implementation defect, solder scrap, implemented parts defect, etc.); <ul style="list-style-type: none"> • BICU • Paper Transport IOB (PCB1)
		<ol style="list-style-type: none"> <u>1.</u> Turn the main power OFF/ON. <u>2.</u> Replace the BICU (PCB10). <u>3.</u> Replace the Paper Transport IOB (PCB1).

SC No.	Type	Error Name/Error Condition/Major Cause/Solution
SC667-11	D	Slave2 Device Mode Setting Error
		The machine detects the Slave2 mode error when starting up, or recovery from energy saving mode.
		The following board defects (Parts implementation defect, solder scrap, implemented parts defect, etc.); <ul style="list-style-type: none"> • BICU • Paper Transport IOB (PCB1)
		<ol style="list-style-type: none"> <u>1.</u> Turn the main power OFF/ON. <u>2.</u> Replace the BICU (PCB10). <u>3.</u> Replace the Paper Transport IOB (PCB1).

SC No.	Type	Error Name/Error Condition/Major Cause/Solution
SC667-40	D	Macaron1 Mode Setting Error
		The machine detects the Macaron1 mode error when starting up, or recovery from energy saving mode.
		The following board defects (Parts implementation defect, solder scrap, implemented parts defect, etc.); <ul style="list-style-type: none"> • BICU
		<ol style="list-style-type: none"> <u>1.</u> Turn the main power OFF/ON. <u>2.</u> Replace the BICU (PCB10).

SC No.	Type	Error Name/Error Condition/Major Cause/Solution
SC667-41	D	Macaron2 Mode Setting Error
		The machine detects the Macaron2 mode error when starting up, or recovery from

5.Troubleshooting

SC No.	Type	Error Name/Error Condition/Major Cause/Solution
		energy saving mode.
		The following board defects (Parts implementation defect, solder scrap, implemented parts defect, etc.); <ul style="list-style-type: none"> • BICU
		<ol style="list-style-type: none"> <u>1.</u> Turn the main power OFF/ON. <u>2.</u> Replace the BICU (PCB10).

SC No.	Type	Error Name/Error Condition/Major Cause/Solution
SC668-01	D	Vodka1 Version Setting Error
		The machine detects the version settings error in Vodka1 when starting up, or recovery from energy saving mode.
		The following board defects (Parts implementation defect, solder scrap, implemented parts defect, etc.); <ul style="list-style-type: none"> • BICU • Paper Transport IOB (PCB1)
		<ol style="list-style-type: none"> <u>1.</u> Turn the main power OFF/ON. <u>2.</u> Replace the BICU (PCB10). <u>3.</u> Replace the Paper Transport IOB (PCB1).

SC No.	Type	Error Name/Error Condition/Major Cause/Solution
SC668-02	D	Vodka2 Version Setting Error
		The machine detects the version settings error in Vodka2 when starting up, or recovery from energy saving mode.
		The following board defects (Parts implementation defect, solder scrap, implemented parts defect, etc.); <ul style="list-style-type: none"> • BICU • Imaging IOB (PCB2)
		<ol style="list-style-type: none"> <u>1.</u> Turn the main power OFF/ON. <u>2.</u> Replace the BICU (PCB10). <u>3.</u> Replace the Imaging IOB (PCB2).

SC No.	Type	Error Name/Error Condition/Major Cause/Solution
SC668-03	D	Vodka1,2 Version Setting Error
		The machine detects the version settings error in both Vodka 1 and Vodka2 when

SC No.	Type	Error Name/Error Condition/Major Cause/Solution
		starting up, or recovery from energy saving mode.
		The following board defects (Parts implementation defect, solder scrap, implemented parts defect, etc.); <ul style="list-style-type: none"> • BICU • Imaging IOB (PCB2) • Paper Transport IOB (PCB1)
		<ol style="list-style-type: none"> 1. Turn the main power OFF/ON. 2. Replace the BICU (PCB10). 3. Replace the Imaging IOB (PCB2). 4. Replace the Paper Transport IOB (PCB1).

SC No.	Type	Error Name/Error Condition/Major Cause/Solution
SC669		EEPROM Communication Error
SC669-01	D	EEPROM OPEN: ID error
SC669-02	D	EEPROM OPEN: Channel error
SC669-03	D	EEPROM OPEN: Device error
SC669-04	D	EEPROM OPEN: Communication abort error
SC669-05	D	EEPROM OPEN: Communication timeout error
SC669-06	D	EEPROM OPEN: Operation stopped error
SC669-07	D	EEPROM OPEN: Buffer full
SC669-08	D	EEPROM OPEN: No error code
SC669-09	D	EEPROM CLOSE: ID error
SC669-10	D	EEPROM CLOSE: No error code
SC669-11	D	EEPROM Data write: ID error
SC669-12	D	EEPROM Data write: Channel error

5.Troubleshooting

SC No.	Type	Error Name/Error Condition/Major Cause/Solution
SC669-13	D	EEPROM Data write: Device error
SC669-14	D	EEPROM Data write: Communication abort error
SC669-15	D	EEPROM Data write: Communication timeout error
SC669-16	D	EEPROM Data write: Operation stopped error
SC669-17	D	EEPROM Data write: Buffer full
SC669-18	D	EEPROM Data write: No error code
SC669-19	D	EEPROM Data read: ID error
SC669-20	D	EEPROM Data read: Channel error
SC669-21	D	EEPROM Data read: Device error
SC669-22	D	EEPROM Data read: Communication abort error
SC669-23	D	EEPROM Data read: Communication timeout error
SC669-24	D	EEPROM Data read: Operation stopped error
SC669-25	D	EEPROM Data read: Buffer full
SC669-26	D	EEPROM Data read: No error code
SC669-36	D	Verification error
SC669-37	D	Error Detection
		The TD sensor (S37)(S38)(S39)(S40) cannot be recovered after retrying N*1 times for EEPROM communication error. (*1 SC669-01 to 26: 3, SC669-36: 2, SC669-37: 1)
		<ul style="list-style-type: none"> • Electrical noise • EEPROM not connected fully

SC No.	Type	Error Name/Error Condition/Major Cause/Solution
		<ul style="list-style-type: none"> • EEPROM not installed • EEPROM damaged • BICU damaged
		<ol style="list-style-type: none"> 1. Turn the main power OFF/ON. 2. Reconnect the EEPROM. 3. Replace the EEPROM. 4. Replace the BICU (PCB10).

No.	Type	Error Name/Error Condition/Major Cause/Solution
681- **	D	Toner bottle: ID Chip Communication error
		When error notification was received during communication with the tag and operation is not resumed after N*1 retries. *1 See the detailed table below.
		<ul style="list-style-type: none"> • Corrupted ID data • Disconnected ID chip • No ID chip • Noise
		<p>Turn the main power off, and then do the following.</p> <ol style="list-style-type: none"> 1. Clean ID chip connections inside the toner bottle, and check if any of the ID Chip Contact Board (PCB3) (PCB4) (PCB5) (PCB6) connector pins have snapped. If there are any snapped pin, replace the ID Chip Contact Board (PCB3) (PCB4) (PCB5) (PCB6). 2. Reconnect the connectors between Imaging IOB (PCB2) and ID Chip Contact Board (PCB3) (PCB4) (PCB5) (PCB6). 3. Reconnect the FFC between Imaging IOB (PCB2) and BICU. 4. Replace the ID Chip Contact Board (PCB3) (PCB4) (PCB5) (PCB6). 5. Reconnect the harness between Imaging IOB (PCB2) and ID Chip Contact Board (PCB3) (PCB4) (PCB5) (PCB6). 6. Replace the FFC between Imaging IOB (PCB2) and BICU. 7. Replace the Imaging IOB (PCB2). 8. Replace the BICU (PCB10).

SC681 Details

No.	Detail	Causes	Retry
01 - 04	Invalid device ID	Noise, Incorrect connection, Malfunction	3
06 - 09	Channel error	Noise, Incorrect connection, Malfunction	3
11 - 14	Device Error	Noise, Incorrect connection	3

5.Troubleshooting

No.	Detail	Causes	Retry
16 - 19	Communication error (interrupted)	Noise, Incorrect connection	3
21 - 24	Communication timeout	Noise, Incorrect connection, Malfunction	3
26 - 29	Device stops (logically)	Noise, Incorrect connection, Malfunction	3
31 - 34	Full of buffer (request)	Noise, Incorrect connection, Malfunction	3
36 - 39	Verification error	Noise, Incorrect connection	2



- **If the last digit of the SC's branch number (-**) is:**

1 or 6, then do the above steps for K

2 or 7, then do the above steps for M

3 or 8, then do the above steps for C

4 or 9, then do the above steps for Y

No.	Type	Error Name/Error Condition/Major Cause/Solution
SC682- **	D	TD sensor communication error
		TD sensor (S37)(S38)(S39)(S40) cannot be recovered after retrying N*1 times for an ID chip communication error. *1 See the detailed table below.
		<ul style="list-style-type: none"> • Corrupted ID data • Disconnected ID chip • No ID chip • Noise
		<p>Turn the main power off, and then do the following.</p> <ol style="list-style-type: none"> 1. Reinstall the PCU. 2. Reconnect the connectors between Imaging IOB (PCB2) and TD sensor (S37)(S38)(S39)(S40). 3. Reconnect the FFC between Imaging IOB (PCB2) and BICU. 4. Replace the PCU. 5. Reconnect the harness between Imaging IOB (PCB2) and TD sensor (S37)(S38)(S39)(S40). 6. Replace the FFC between Imaging IOB (PCB2) and BICU. 7. Replace the Imaging IOB (PCB2). 8. Replace the BICU (PCB10).  <ul style="list-style-type: none"> • If the last digit of the SC's branch number (-**) is: <p>1 or 6, then do the above steps for K</p> <p>2 or 7, then do the above steps for M</p> <p>3 or 8, then do the above steps for C</p> <p>4 or 9, then do the above steps for Y</p>

SC682 Details

No.	Description	Cause	Retry
01 - 04	Invalid device ID	Noise, Incorrect connection, Malfunction	3
06 - 09	Channel error	Noise, Incorrect connection, Malfunction	3
11 - 14	Device Error	Noise, Incorrect connection	3
16 - 19	Communication error (interrupted)	Noise, Incorrect connection	3
21 - 24	Communication timeout	Noise, Incorrect connection, Malfunction	3
26 - 29	Device stops (logically)	Noise, Incorrect connection, Malfunction	3
31 - 34	Full of buffer (request)	Noise, Incorrect connection, Malfunction	3
36 - 39	Verification error	Noise, Incorrect connection	2

SC No.	Type	Error Name/Error Condition/Major Cause/Solution
SC687-00	D	PER Not Received Error
		Unable to receive the PER command from the controller.
		Communication error
		Replace the BICU (PCB10).

[Detach and then reattach the toner bottle.](#)

SC600 (Controller)

SC No.	Type	Error Name/Error Condition/Major Cause/Solution
SC632-00	D	Counter device error 1
		After 3 attempts to send a data frame to the optional counter device via the serial communication line, no ACK signal was received within 100 ms.
		Serial line between the optional counter device, the relay board and copier control board is disconnected or damaged.
		<ol style="list-style-type: none"> 1. Turn the main power off/on. 2. Check the serial communication line.

SC No.	Type	Error Name/Error Condition/Major Cause/Solution
SC633-00	D	Counter device error 2
		After communication was established, the controller received the brake signal from the accounting device.
		Serial line between the optional counter device, the relay board and copier control board is disconnected or damaged.
		<ol style="list-style-type: none"> 1. Turn the main power off/on.

5.Troubleshooting

SC No.	Type	Error Name/Error Condition/Major Cause/Solution
		2. Check the serial communication line.

SC No.	Type	Error Name/Error Condition/Major Cause/Solution
SC634-00	D	Counter device error 3
		A backup RAM error was returned by the counter device.
		Counter device control board or the backup battery of counter device defective
		<ol style="list-style-type: none"> 1. Replace the counter device control board. 2. Replace the backup battery.

SC No.	Type	Error Name/Error Condition/Major Cause/Solution
SC635-00	D	Counter device error 4
		A backup battery error was returned by the counter device.
		Counter device control board or the backup battery of counter device defective
		<ul style="list-style-type: none"> • Replace the counter device control board. • Replace the backup battery.

SC No.	Type	Error Name/Error Condition/Major Cause/Solution
SC636-01	D	IC Card Error (Expanded authentication module error)
		<p>Issued when expanded authentication management is set to "ON" but either of the following occur.</p> <ul style="list-style-type: none"> • There is no expanded authentication module in the machine. • The SD card or the file of the expanded authentication module is broken. • There is no DESS module in the machine.
		<ul style="list-style-type: none"> • There is no DESS module in the machine (models on which the function is optional). • There is no expanded authentication module in the machine. • The SD card or the file of the expanded authentication module is broken.
		<ul style="list-style-type: none"> • Set a working SD card/expanded authentication module file. • Install the DESS module. • In the SSP mode set SP5-401-160 to "0". • In the SSP mode, set SP5-401-161 to "0". • Replace the NVRAM.

SC No.	Type	Error Name/Error Condition/Major Cause/Solution
SC636-02	D	IC Card Error (Version error)
		The version of the expanded authentication module is not correct.

SC No.	Type	Error Name/Error Condition/Major Cause/Solution
		Incorrect module version
		Install the correct file of the expanded authentication module.

SC No.	Type	Error Name/Error Condition/Major Cause/Solution
SC637-01	D	Tracking Information Notification Error (Tracking application error)
		Tracking information was lost.
		<ul style="list-style-type: none"> Tracking SDK application error Internal notification error
		Turn the main power off/on.

SC No.	Type	Error Name/Error Condition/Major Cause/Solution
SC637-02	D	Tracking Information Notification Error (Management server error)
		Tracking information was lost.
		Communication with tracking management server failed. <ul style="list-style-type: none"> Network error tracking management server error Tracking SDK application error
		Turn the main power off/on.

SC No.	Type	Details (Symptom, Possible Cause, Troubleshooting Procedures)
SC641-00	D	Communication error between BICU and Controller board.
		Controller board does not respond after BICU tries to communicate three times.
		<ul style="list-style-type: none"> Controller board software error Connect error between BICU and Controller board Engine board software error
		<ul style="list-style-type: none"> Check connections between Controller board and BICU. Turn the main switch off and on.

SC No.	Type	Details (Symptom, Possible Cause, Troubleshooting Procedures)
SC641-01	D	Communication error between BICU and Controller board (Timeout)
SC641-02	D	Communication error between BICU and Controller board (Timeout)
SC641-03	D	Communication error between BICU and Controller board (Timeout)
SC641-04	D	Communication error between BICU and Controller board (Timeout)
		Perform the same troubleshooting as for SC641-00.

SC No.	Type	Error Name/Error Condition/Major Cause/Solution
SC650-	C	Remote Service Modem Communication Error (Dialup authentication failure)

5.Troubleshooting

SC No.	Type	Error Name/Error Condition/Major Cause/Solution
01		
		<ul style="list-style-type: none"> An error related to communication (dialup connection, modem board etc.) using the RC Gate Type M was detected or an error that prevents RC Gate operation was detected at power on. Displayed only when an error is detected while RC Gate is operating. SC is not issued if an error occurs during RC Gate installation (because it can be referenced using SP).
		Dialup authentication failure
		Check the following SPs. <ul style="list-style-type: none"> SP5-816-156 SP5-816-157

SC No.	Type	Error Name/Error Condition/Major Cause/Solution
SC650-04	C	Remote Service Modem Communication Error (dialup failing because of incorrect modem configuration)
		<ul style="list-style-type: none"> An error related to communication (dialup connection, modem board etc.) using the RC Gate Type M was detected or an error that prevents RC Gate operation was detected at power on. Displayed only when an error is detected while RC Gate is operating. SC is not issued if an error occurs during RC Gate installation (because it can be referenced using SP).
		Dialup failing because of incorrect modem configuration
		Check if the setting of SP5-816-160 is correct. If it is correct, then there is a software bug.

SC No.	Type	Error Name/Error Condition/Major Cause/Solution
SC650-05	C	Remote Service Modem Communication Error (insufficient current or connection error)
		<ul style="list-style-type: none"> An error related to communication (dialup connection, modem board etc.) using the RC Gate Type M was detected or an error that prevents RC Gate operation was detected at power on. Displayed only when an error is detected while RC Gate is operating. SC is not issued if an error occurs during RC Gate installation (because it can be referenced using SP).
		Insufficient current or connection error
		The line is not supported and nothing can be done.

SC No.	Type	Error Name/Error Condition/Major Cause/Solution
SC650-13	C	Remote Service Modem Communication Error (RC Gate Type M was installed but modem is not present (detected during operation))
		<ul style="list-style-type: none"> An error related to communication (dialup connection, modem board etc.) using the RC Gate Type M was detected or an error that prevents RC Gate operation was detected at power on. Displayed only when an error is detected while RC Gate is operating. SC is not issued if an error occurs during RC Gate installation (because it can be referenced using SP).
		RC Gate Type M was installed but modem is not present (detected during operation)
		<ul style="list-style-type: none"> If a modem board is not installed, install it. Check again if the modem driver configurations (SP5-816-160, SP5-816-165 to 171) are correct. If the problem is not solved, replace the modem.

SC No.	Type	Error Name/Error Condition/Major Cause/Solution
SC650-14	C	Remote Service Modem Communication Error (RC Gate Type N was installed but modem is present or wired/wireless LAN is not working correctly)
		<ul style="list-style-type: none"> An error related to communication (dialup connection, modem board etc.) using the RC Gate was detected or an error that prevents RC Gate operation was detected at power on. Displayed only when an error is detected while RC Gate is operating. SC is not issued if an error occurs during RC Gate installation (because it can be referenced using SP).
		RC Gate Type N was installed but modem is present or wired/wireless LAN is not working correctly
		<ul style="list-style-type: none"> If a modem board is attached, remove it. Check if wired/wireless LAN works.

SC No.	Type	Error Name/Error Condition/Major Cause/Solution
SC651-01	C	Illegal Remote Service Dial-up (Chat program parameter error)
		An unexpected error occurred when RC Gate Type M dialed up the NRS Center.
		Software bug
		Logging only.

SC No.	Type	Error Name/Error Condition/Major Cause/Solution
SC651-02	C	Illegal Remote Service Dial-up (Chat program execution error)

5.Troubleshooting

SC No.	Type	Error Name/Error Condition/Major Cause/Solution
		An unexpected error occurred when RC Gate dialed up the NRS Center.
		Software bug
		Logging only.

SC No.	Type	Error Name/Error Condition/Major Cause/Solution
SC652-00	A	Remote service ID2 mismatching
		There was an authentication mismatch between ID2 for @Remote, the controller board, and NVRAM.
		<ul style="list-style-type: none"> Used controller board installed Used NVRAM installed (such action is not allowed.)
		<ul style="list-style-type: none"> If this occurs during RC Gate installation: Check the validity of the certificate and the NVRAM, check the machine serial number, write the common certificate, and then begin installation again. If this occurs after RC Gate installation: Clear the RC Gate install status, check the validity of the certificate and the NVRAM, check the machine serial number, write the common certificate, and then begin installation again.

SC No.	Type	Error Name/Error Condition/Major Cause/Solution
SC653-00	A	Incorrect remote service ID2
		ID2 stored in the NVRAM has either of the following problems. <ul style="list-style-type: none"> Number of characters is not 17. Includes a character that cannot be printed. All spaces NULL
		Replace the NVRAM.
		Clear the RC Gate install status, write the common certificate, and then begin installation again.

SC No.	Type	Error Name/Error Condition/Major Cause/Solution
SC670-01	D	Engine start up error when the machine boots up
		<ul style="list-style-type: none"> /ENGRDY signal was not asserted when the machine was turned on. PCI I/F is not linked up when the machine returns from energy saving mode. EC/PC/SC response was not received within specified time from power on. Writing to Rapi driver failed (the other party not found through PCI).

SC No.	Type	Error Name/Error Condition/Major Cause/Solution
		<ul style="list-style-type: none"> BICU is down / unstable
		Engine board does not start up.
		Refer to When SC670 (Engine start up error) is displayed

SC No.	Type	Error Name/Error Condition/Major Cause/Solution
SC670-02	D	Engine start up error when the machine is in operation
		<ul style="list-style-type: none"> CPU reset by software CPU reset by anomaly CPU CPU reset by hardware defect / noise Hardware defect
		Engine board reset unexpectedly.
		Refer to When SC670 (Engine start up error) is displayed

SC No.	Type	Error Name/Error Condition/Major Cause/Solution
SC670-03	D	IPU start up error when the machine boots up
		VDET_EPCI signal was not asserted when the machine was turned on.
		<ul style="list-style-type: none"> BICU, PSU, and/or CTL defective Incorrect connection between CTL and BICU. Harness of BICU disconnected
		Refer to When SC670 (Engine start up error) is displayed

SC No.	Type	Error Name/Error Condition/Major Cause/Solution
SC670-04	D	Communication error between the engine and controller
		Communication could not linked up.
		<ul style="list-style-type: none"> BICU and/or CTL defective Incorrect connection between CTL and BICU.
		Refer to When SC670 (Engine start up error) is displayed

SC No.	Type	Error Name/Error Condition/Major Cause/Solution
SC670-05	C	Link up error
		Communication could not linked up.
		<ul style="list-style-type: none"> CTL board defective BICU defective Incorrect connection between CTL and BICU.
		Logging only.

5.Troubleshooting

SC No.	Type	Error Name/Error Condition/Major Cause/Solution
SC672-00	D	Controller start up error
		After the machine was powered on, communication between the controller and the operation panel was not established.
		<ul style="list-style-type: none"> • Controller stalled • Board installed incorrectly • Controller board defective • Operation panel connector loose, broken, or defective • Controller late
		Refer to When SC672 (Controller start up error) is displayed.

SC No.	Type	Error Name/Error Condition/Major Cause/Solution
SC672-10	D	Controller start up error
		After the machine was powered on, communication between the controller and the operation panel was not established.
		<ul style="list-style-type: none"> • Assembly fault (controller board, memory (DIMM), operation panel harness connection) • Parts defective (controller board, memory (DIMM), operation panel harness, operation panel, BICU) • Controller stall due to software trouble
		Refer to When SC672 (Controller start up error) is displayed.

SC No.	Type	Error Name/Error Condition/Major Cause/Solution
SC672-11	D	Controller start up error
		After the machine was powered on, communication between the controller and the operation panel was not established, or communication with controller was interrupted after a normal startup.
		<ul style="list-style-type: none"> • Assembly fault (controller board, memory (DIMM), operation panel harness connection) • Parts defective (controller board, memory (DIMM), operation panel harness, operation panel, BICU) • Controller stall due to software trouble
		Refer to When SC672 (Controller start up error) is displayed.

SC No.	Type	Error Name/Error Condition/Major Cause/Solution
SC672-12	D	Controller start up error
		Communication with controller was interrupted after a normal startup.
		<ul style="list-style-type: none"> • Assembly fault (controller board, memory (DIMM), operation panel harness connection) • Parts defective (controller board, memory (DIMM), operation panel harness, operation panel, BICU) • Controller stall due to software trouble
		Refer to When SC672 (Controller start up error) is displayed.

SC No.	Type	Error Name/Error Condition/Major Cause/Solution
SC672-13	D	Controller start up error
		The operation panel detects that the controller is down due to other reason shown in SC672-10, SC672-11, and SC672-12.
		<ul style="list-style-type: none"> • Assembly fault (controller board, memory (DIMM), operation panel harness connection) • Parts defective (controller board, memory (DIMM), operation panel harness, operation panel, BICU) • Controller stall due to software trouble
		Refer to When SC672 (Controller start up error) is displayed.

SC No.	Type	Error Name/Error Condition/Major Cause/Solution
SC672-20	D	Controller start up error
SC672-21	D	Controller start up error
		SC672-20: USB cable defective SC672-21: Controller board defective
		-
		Refer to When SC672 (Controller start up error) is displayed.

SC No.	Type	Error Name/Error Condition/Major Cause/Solution
SC673-01	D	System application communication error (Smart operation panel)
		The system application (Monitor Service) of Smart Operation Panel performed abnormal operation.
		-
		Turn the main switch off and on.

5.Troubleshooting

SC No.	Type	Error Name/Error Condition/Major Cause/Solution
SC673-10	D	Operation panel Flair communication error (Smart Operation Panel)
		<p>This SC is issued only for the machine that has the Smart Operation Panel installed.</p> <ul style="list-style-type: none"> • Communication between Smart Operation Panel and main machine (this is called "Flair communication") is not sent to Smart Operation Panel. • SP setting (SP5-748-201) for Smart Operation Panel is not activated.
		The CATS module (controller) did not see the response to notification of monitoring service module (operation panel).
		<ol style="list-style-type: none"> <u>1.</u> Turn the main power OFF/ON. <u>2.</u> Set SP5-748-201 (OpePanel Setting: Cheetah Panel Connect Setting) to "1: Connect" if the value is "0: Not connect".

SC No.	Type	Error Name/Error Condition/Major Cause/Solution
SC674-01	D	Transfer Error (M2P error)
		<p>The video transfer error has occurred on the controller board. If image data transfer to the engine fails for some reason, an SC occurs.</p>
		Controller Board/software defective
		Turn the main power OFF/ON.
SC674-02	D	Transfer Error (PCI error)
		<p>The expanded engine ASIC has failed in its attempt to access another PCI device. The PCI error may occur simultaneously with the M2P error (SC674-01).</p>
		Controller Board/software defective
		Turn the main power OFF/ON.

SC700 (Engine: Peripherals)

SC No.	Type	Error Name/Error Condition/Major Cause/Solution
SC700		SPDF DF3120 Error
SC700-01	D	Tray Lift Motor error
SC700-02	D	Pick-up Motor error
SC700-04	D	Feed Motor error
SC700-05	D	Entrance Motor error
SC700-06	D	Relay Motor error
SC700-07	D	Transport Motor error
SC700-09	D	Exit Motor error
		<p>-01 Even if the Tray Lift Motor is rotated in the base plate ascent direction, the base plate paper feed correct position sensor does not detect. Even if the Tray Lift Motor is rotated in the base plate descent direction, the base plate home position sensor does not detect.</p> <p>-02 Even if the Pick-up Motor is rotated, the pick-up arm home position sensor does not detect.</p> <p>-04, 05, 06, 07, 09 When an error notification signal is detected during the motor drive period.</p>
		<p>-01</p> <ul style="list-style-type: none"> • Base plate paper feed correct position sensor error (output error) • Base plate home position sensor error (output error) • Tray Lift Motor error (does not rotate) • Controller error <p>-02</p> <ul style="list-style-type: none"> • Pick-up home position sensor error (output error) • Pick-up Motor error (does not rotate) • Controller error <p>-04, 05, 06, 07, 09</p> <ul style="list-style-type: none"> • Motor defective

5.Troubleshooting

SC No.	Type	Error Name/Error Condition/Major Cause/Solution
		<ul style="list-style-type: none"> • Connector disconnected • Harness broken • Overload
		<p>Check if the SC occurs by turning the main power OFF then ON, opening/closing covers, and input/output check. If the SC occurs again, do the following steps. Check if the SC reoccurs by cycling the power after each step.</p> <p>The target parts that need to be checked are as follows;</p> <ul style="list-style-type: none"> • -01: all motors, and Pick-up Roller HP Sensor • -02: all motors, and Bottom Plate Lift Sensor, Bottom Plate HP Sensor • -03, 04, 05, 06, 07, 09: all parts in ADF. <p>1. Check if the connector of the target part is connected securely. Reconnect the connector if it is disconnected, or loose.</p> <p>2. Check the harness for the target part. Replace the harness if it is disconnected, or damaged.</p> <p>3. Check if the motor runs, sensors turn OFF/ON, has no overloads, and is properly driven. Replace the parts if there are any defects.</p> <p>4. Check if there are any signs of a short circuit. Replace the parts if there are any defects.</p>

SC No.	Type	Error Name/Error Condition/Major Cause/Solution
SC701		ARDF DF3110 Error
SC701-03	D	Paper Feed Motor Driver Error
		Detection of error signal from motor driver
SC701-08	D	Paper Exit Motor Driver Error
		Detection of error signal from motor driver.
		<ul style="list-style-type: none"> • Encoder disconnection • Encoder connector dropout • Encoder defective • Overload • Motor deterioration
		<p>Check if the SC occurs by turning the main power OFF then ON, opening/closing covers, and input/output check. If the SC occurs again, do the following steps. Check if the SC reoccurs by cycling the power after each step.</p> <ul style="list-style-type: none"> • The target parts that need to be checked are all motors, all solenoids, all clutches, and all sensors. <p>1. Check if the connector of the target part is connected securely. Reconnect the</p>

SC No.	Type	Error Name/Error Condition/Major Cause/Solution
		<p>connector if it is disconnected, or loose.</p> <p>2. Check the harness for the target part. Replace the harness if it is disconnected, or damaged.</p> <p>3. Check if the motor runs, sensors turn OFF/ON, has no overloads, and is properly driven. Replace the parts if there are any defects.</p> <p>4. Check if there are any signs of a short circuit. Replace the parts if there are any defects.</p>

SC No.	Type	Error Name/Error Condition/Major Cause/Solution
SC702		ARDF DF3110 Error
SC702-01	D	Protection Device Intercept Error
		When original source 5V power supply is ON, protection device intercept of 24V power supply system is detected.
		Any of feed motor, transport motor, reverse solenoid, paper feed solenoid, paper feed clutch and FAN motor defective, a harness short-circuit occurs, and the protection device of the 24V power supply system intercepts.
		<p>Check if the SC occurs by turning the main power OFF then ON, opening/closing covers, and input/output check. If the SC occurs again, do the following steps. Check if the SC reoccurs by cycling the power after each step.</p> <ul style="list-style-type: none"> • The target parts that need to be checked is Original Set Sensor. <p>1. Check if the connector for Original Set Sensor is connected securely. Reconnect the connector if it is disconnected, or loose.</p> <p>2. Check the harness for Original Set Sensor. Replace the harness if it is disconnected, or damaged.</p> <p>3. Check if the Original Set Sensor turns OFF/ON (INPUT Check). Replace the part if there are any defects.</p> <p>4. Check if there are any signs of a short circuit. Replace the parts if there are any defects.</p>
SC702-02	D	Protection Device Intercept Error 2
		When original source 5V power supply is ON, protection device intercept of 24V OUT power supply system is detected.
		Solenoid defective or harness short-circuit occurs in 24VOUT power supply system.
		Check if the SC occurs by turning the main power OFF then ON, opening/closing covers, and input/output check. If the SC occurs again, do the following steps. Check if the SC reoccurs by cycling the power after each step.

5.Troubleshooting

SC No.	Type	Error Name/Error Condition/Major Cause/Solution
		<ul style="list-style-type: none"> • The target parts that need to be checked is Original Set Sensor. 1. Check if the connector for Original Set Sensor is connected securely. Reconnect the connector if it is disconnected, or loose. 2. Check the harness for Original Set Sensor. Replace the harness if it is disconnected, or damaged. 3. Check if the Original Set Sensor turns OFF/ON (INPUT Check). Replace the part if there are any defects. 4. Check if there are any signs of a short circuit. Replace the parts if there are any defects.
SC702-03	D	Protection Device Intercept Error 3
		When original source 5V power supply is ON, protection device intercept of 5VE power supply system is detected.
		Sensor defective or a harness short-circuit occur in 5VE power supply system.
		<p>Check if the SC occurs by turning the main power OFF then ON, opening/closing covers, and input/output check. If the SC occurs again, do the following steps. Check if the SC reoccurs by cycling the power after each step.</p> <ul style="list-style-type: none"> 1. Check if the connector for Original Set Sensor is connected securely. Reconnect the connector if it is disconnected, or loose. 2. Check the harness for Original Set Sensor. Replace the harness if it is disconnected, or damaged. 3. Check if the Original Set Sensor turns OFF/ON (INPUT Check). Replace the part if there are any defects. 4. Check if there are any signs of a short circuit. Replace the parts if there are any defects.

SC No.	Type	Error Name/Error Condition/Major Cause/Solution
SC702		ARDF/SPDF Error
SC702-04	D	Protection Device Intercept Error 4
		Motor defective in any of the pick-up motor, completion stamp, base plate motor or FAN motor, or a harness short-circuit occurs, and the protection device of the non-interlocking power supply system intercepts.
		Motor defective or a harness short-circuit occurs in the non-interlocking power supply system.
		<p>Check if the SC occurs by turning the main power OFF then ON, opening/closing covers, and input/output check. If the SC occurs again, do the following steps. Check if the SC reoccurs by cycling the power after each step.</p>

SC No.	Type	Error Name/Error Condition/Major Cause/Solution
		<ul style="list-style-type: none"> • The target parts that need to be checked are the Pick-up Roller Lift Motor, Stamp Solenoid, and Feed Motor. <ol style="list-style-type: none"> 1. Check if the connector of the target part is connected securely. Reconnect the connector if it is disconnected, or loose. 2. Check the harness for the target part. Replace the harness if it is disconnected, or damaged. 3. Check if the motor runs, has no overloads, and is properly driven. Replace the parts if there are any defects. 4. Check if there are any signs of a short circuit. Replace the parts if there are any defects.
SC702-05	D	Protection Device Intercept Error 5
		Motor defective in the paper feed motor, pullout motor, intermediate motor, scanner motor (M26) or paper exit motor, or a harness short-circuit occurs, and the protection device of the interlocking power supply system intercepts.
		Motor defective or a harness short-circuit occurs in the interlocking power supply system.
		<p>Check if the SC occurs by turning the main power OFF then ON, opening/closing covers, and input/output check. If the SC occurs again, do the following steps. Check if the SC reoccurs by cycling the power after each step.</p> <ul style="list-style-type: none"> • The target parts that need to be checked are the Feed Motor, Pick-up Roller Lift Motor, Relay Motor, Transport Motor (M5), and Exit Motor. <ol style="list-style-type: none"> 1. Check if the connector of the target part is connected securely. Reconnect the connector if it is disconnected, or loose. 2. Check the harness for the target part. Replace the harness if it is disconnected, or damaged. 3. Check if the motor runs, has no overloads, and is properly driven. Replace the parts if there are any defects. 4. Check if there are any signs of a short circuit. Replace the parts if there are any defects.

SC No.	Type	Error Name/Error Condition/Major Cause/Solution
SC703-01	B	Double Feed Sensor error (SPDF)
		Error signal detected during double-feed sensor operation.
		Disconnection, broken harness, erroneous double feed detection (output error), or double-feed sensor board error.
		Check if the SC occurs by turning the main power OFF then ON, opening/closing

5.Troubleshooting

SC No.	Type	Error Name/Error Condition/Major Cause/Solution
		<p>covers, and input/output check. If the SC occurs again, do the following steps. Check if the SC reoccurs by cycling the power after each step.</p> <ol style="list-style-type: none"> 1. Check if the connector for Double Feed Sensor is connected securely. Reconnect the connector if it is disconnected, or loose. 2. Check the harness for Double Feed Sensor r. Replace the harness if it is disconnected, or damaged. 3. Check if there are any signs of a short circuit. Replace the parts if there are any defects.

SC No.	Type	Error Name/Error Condition/Major Cause/Solution
SC720		Booklet Finisher SR3290/Finisher SR3280 Error
SC720-03	B	Protection Device Intercept Error 1
		Protection device intercept error state (fuse break) is detected.
SC722-06	C	See the descriptions next table below.
SC720-10	B	Entrance Transport Motor Error
SC720-11	B	Horizontal Transport Motor Error
SC720-13	B	Intermediate Transport Motor Error
SC720-15	B	Prestack Transport Motor Error
SC720-17	B	Paper Exit Motor Error
		<p>Error Condition of -06, -10, -11, -13, -15, -17 Motor driver detects an error (DC motor control error) (1st time is jam notification, 2nd time is SC notification)</p>
SC720-20	B	Lower Junction Gate Motor Error
SC720-24	B	Paper Exit Open/Close Guide Plate Motor Error
SC720-25	B	Punching Motor Error
SC720-27	B	Punch Displacement Motor Error

SC No.	Type	Error Name/Error Condition/Major Cause/Solution
SC720-28	B	Horizontal Registration Detection Displacement Motor Error
SC720-30	B	Jogger Motor Error
SC720-33	B	Positioning Roller Drive Motor Error
		<p>Error Condition of -20, -24, -25, -27, -28, -30, -33</p> <ul style="list-style-type: none"> • During movement to home, the home position could not be detected within a predetermined pulse (Jam notification for 1st to 4th times, SC notification for 5th time). • During movement from home, the home position was detected for longer than a predetermined pulse (Jam notification for 1st to 4th times, SC notification for 5th time).
SC720-34	B	Positioning Transport Motor Error
		Motor driver detects an error (DC motor control error) (Jam notification for 1st to 4th times, SC notification for 5th time)
SC720-35	B	Rear End Press Motor Error
		<ul style="list-style-type: none"> • Motor driver detects an error (DC motor control error) (Jam notification for 1st to 4th times, SC notification for 5th time). • During movement to home, the home position could not be detected within a predetermined time (Jam notification for 1st to 4th times, SC notification for 5th time). • During movement from home, the home position was detected for longer than a predetermined time (Jam notification for 1st to 4th times, SC notification for 5th time).
SC720-41	B	Release Motor Error
		<ul style="list-style-type: none"> • Motor driver detects an error (DC motor control error) (Jam notification for 1st to 4th times, SC notification for 5th time) • During movement to home, the home position could not be detected within a predetermined pulse (Jam notification for 1st to 4th times, SC notification for 5th time). • During movement from home, the home position was detected for longer than a predetermined pulse (Jam notification for 1st to 4th times, SC notification for 5th time).
SC720-	B	Edge Stapler Retreat Motor Error

5.Troubleshooting

SC No.	Type	Error Name/Error Condition/Major Cause/Solution
42		
		<ul style="list-style-type: none"> During movement to home, the home position could not be detected within a predetermined pulse (Jam notification for 1st to 4th times, SC notification for 5th time). <p>During movement from home, the home position was detected for longer than a predetermined pulse (Jam notification for 1st to 4th times, SC notification for 5th time).</p>
SC720-44	B	Edge Stapler Motor Error
		<ul style="list-style-type: none"> During movement to home, the home position could not be detected within a predetermined time (Jam notification for 1st to 4th times, SC notification for 5th time). During movement from home, the home position was detected for longer than a predetermined time (Jam notification for 1st to 4th times, SC notification for 5th time).
SC720-50	B	Booklet Jogger Motor Error
SC720-51	B	Booklet Adjustment Claw Displacement Motor Error
SC720-52	B	Press Folding Motor Error
SC720-53	B	Booklet Reference Fence Motor Error
		<p>Error Condition of -50, -51, -52, -53</p> <ul style="list-style-type: none"> During movement to home, the home position could not be detected within a predetermined pulse (Jam notification for 1st to 4th times, SC notification for 5th time). During movement from home, the home position was detected for longer than a predetermined pulse (Jam notification for 1st to 4th times, SC notification for 5th time).
SC720-54	B	Folding Transport Motor Error
		Motor driver detects an error (short-circuit and overheating) (1st time is jam notification, 2nd time is SC notification).
SC720-60	B	Booklet Stapler Motor Error
		<ul style="list-style-type: none"> During movement to home, the home position could not be detected within a

SC No.	Type	Error Name/Error Condition/Major Cause/Solution
		<p>predetermined time (Jam notification for 1st to 4th times, SC notification for 5th time).</p> <ul style="list-style-type: none"> • During movement from home, the home position was detected for longer than a predetermined time (Jam notification for 1st to 4th times, SC notification for 5th time).
SC720-70	B	Folding Transport Motor Error
		<ul style="list-style-type: none"> • Motor controller detects an error (overload) (Jam notification for 1st to 4th times, SC notification for 5th time) • During descent, the paper surface sensor still detects paper even after a predetermined time (t0sec) elapses (Jam notification for 1st to 4th times, SC notification for 5th time). • During ascent, the paper surface sensor could not detect the paper surface even after a predetermined time (t1sec) elapses (Jam notification for 1st to 4th times, SC notification for 5th time).
SC720-71	B	Shift Motor Error
SC720-72	B	Shift Jogger Front Motor Error
SC720-73	B	Shift Jogger Rear Motor Error
SC720-74	B	Shift Jogger Retreat Motor Error
		<p>Error Condition of -71, -72, -73, -74</p> <ul style="list-style-type: none"> • During movement to home, the home position could not be detected within a predetermined pulse (Jam notification for 1st to 4th times, SC notification for 5th time). • During movement from home, the home position was detected for longer than a predetermined pulse (Jam notification for 1st to 4th times, SC notification for 5th time).
SC720-75	B	Reverse Roller Rocking Motor Error
		<ul style="list-style-type: none"> • Motor driver detects an error (DC motor control error) (Jam notification for 1st to 4th times, SC notification for 5th time) • During movement to home, the home position could not be detected within a predetermined time (Jam notification for 1st to 4th times, SC notification for 5th time). • During movement from home, the home position was detected for longer than

5.Troubleshooting

SC No.	Type	Error Name/Error Condition/Major Cause/Solution
		a predetermined time (Jam notification for 1st to 4th times, SC notification for 5th time).
SC720-80	B	Protection Device Intercept Error 3
		Fuse blowout is detected
SC720-81	B	Transfer Roller Transport Motor Error
		Motor driver detects an error (DC motor control error) (Jam notification for 1st to 4th times, SC notification for 5th time).
SC720-82	B	Edge Guide Motor Error
SC720-83	B	Paper Guide Motor Error
		<p>Error Condition of -82, -83</p> <ul style="list-style-type: none"> • During movement to home, the home position could not be detected within a predetermined pulse (Jam notification for 1st to 4th times, SC notification for 5th time). • During movement from home, the home position was detected for longer than a predetermined pulse (Jam notification for 1st to 4th times, SC notification for 5th time).
		<ul style="list-style-type: none"> • Harness short-circuit -80 only • Overload • Motor defective • Solenoid defective -03, -80 only • Connector disconnected • Encoder defective -10, -25, -34 -81 only • Home position sensor defective
		<p>Check if the SC occurs by turning the main power OFF then ON. If the SC occurs again, do the following steps. Check if the SC reoccurs by cycling the power after each step.</p> <ul style="list-style-type: none"> • The target parts are the motor and related HP sensor that SC occurred. <ol style="list-style-type: none"> 1. Check if the connector of the target part is connected securely. Reconnect the connector if it is disconnected, or loose. 2. Check the harness for the target part. Replace the harness if it is disconnected, or damaged. 3. Check if the motor runs, sensors turn OFF/ON, has no overloads, and is properly driven. Replace the parts if there are any defects. 4. Check if there are any signs of a short circuit. Replace the parts if there are

SC No.	Type	Error Name/Error Condition/Major Cause/Solution
		any defects.

SC No.	Type	Error Name/Error Condition/Major Cause/Solution
SC720		Booklet Finisher SR3290/Finisher SR3280 Error
SC720-06	C	Access error to NVRAM Error occurs when accessing NV memory. Connection failure or malfunction of NV memory Check if the SC occurs by turning the main power OFF then ON. If the SC occurs again, do the following steps. 1. Pull out and reinsert the NV memory to check if the NV memory is correctly inserted into the IC socket. If the SC cannot be recovered, replace the main board.

SC No.	Type	Error Name/Error Condition/Major Cause/Solution
SC721		Booklet Finisher SR3270 Error
SC721-03	B	Protection Device Intercept Error 1 Fuse blowout is detected
SC721-04	B	Protection Device Intercept Error 2 Fault signal of interlock system protection device (high-side switch) detected when power on.
SC721-06	C	See the descriptions next table below.
SC721-10	B	Transport Motor 1 Error Motor driver detects an error state (DC motor control error) (Jam notification for 1st to 4th times, SC notification for 5th time).
SC721-11	B	Transport Motor 2 Error Motor driver detects an error state (DC motor control error) (Jam notification for 1st to 4th times, SC notification for 5th time).
SC721-17	B	Paper Eject Motor 2 Error Motor driver detects an error state (DC motor control error) (Jam notification for 1st to 4th times, SC notification for 5th time).
SC721-24	B	Paper Exit Guide Plate Open/Close motor Error <ul style="list-style-type: none"> During movement to home, the home position could not be detected within a predetermined pulse (Jam notification for 1st to 4th times, SC notification for 5th time). During movement from home, the home position was detected for longer than

5.Troubleshooting

SC No.	Type	Error Name/Error Condition/Major Cause/Solution
		a predetermined pulse (Jam notification for 1st to 4th times, SC notification for 5th time).
SC721-25	B	<p>Punch Drive Motor Error</p> <ul style="list-style-type: none"> During movement to home, the home position could not be detected within a predetermined time (Jam notification for 1st to 4th times, SC notification for 5th time). During movement from home, the home position was detected even after a predetermined time elapsed (Jam notification for 1st to 4th times, SC notification for 5th time). Output from the encoder could not be counted for a predetermined number of times within a predetermined time (Jam notification for 1st to 4th times, SC notification for 5th time).
SC721-27	B	Punch Movement Motor Error
SC721-28	B	Punch Horizontal Registration Detection Error
SC721-30	B	Jogger Motor 1 Error
SC721-33	B	Positioning Roller Motor Error
SC721-41	B	<p>Release Motor Error</p> <ul style="list-style-type: none"> During movement to home, the home position could not be detected within a predetermined pulse (Jam notification for 1st to 4th times, SC notification for 5th time). During movement from home, the home position was detected even after a predetermined pulse elapsed (Jam notification for 1st to 4th times, SC notification for 5th time).
SC721-42	B	<p>Stapler Retreat Motor Error</p> <ul style="list-style-type: none"> During movement to home, the home position could not be detected within a predetermined pulse (Jam notification for 1st to 4th times, SC notification for 5th time). During movement from home, the home position was detected even after a predetermined pulse elapsed (Jam notification for 1st to 4th times, SC notification for 5th time). During movement from home, retreat sensor ON could not be detected even after a predetermined pulse elapsed (Jam notification for 1st to 4th times, SC notification for 5th time). During initialization, retreat sensor ON was detected simultaneously when the

SC No.	Type	Error Name/Error Condition/Major Cause/Solution
		home position is detected (Jam notification for 1st to 4th times, SC notification for 5th time).
SC721-44	B	<p>Stapler Motor Error</p> <ul style="list-style-type: none"> During movement to home, the home position could not be detected even after a predetermined time elapsed (Jam notification for 1st to 4th times, SC notification for 5th time). During movement from home, the home position was detected even after a predetermined time elapsed (Jam notification for 1st to 4th times, SC notification for 5th time). During motor drive, the output from the encoder could not be counted for a predetermined number of times within a predetermined time (Jam notification for 1st to 4th times, SC notification for 5th time).
SC721-52	B	<p>Folding Plate Drive Motor Error</p> <ul style="list-style-type: none"> Motor driver detects an error (short-circuit and overheating) (1st time is SC). During movement to home, the home position could not be detected within a predetermined pulse (Jam notification for 1st to 4th times, SC notification for 5th time). During movement from home, the home position was detected for longer than a predetermined pulse (Jam notification for 1st to 4th times, SC notification for 5th time).
SC721-53	B	<p>Rear End Fence Displacement Motor Error</p> <ul style="list-style-type: none"> During movement to home, the home position could not be detected within a predetermined pulse (Jam notification for 1st to 4th times, SC notification for 5th time). During movement from home, the home position was detected for longer than a predetermined pulse (Jam notification for 1st to 4th times, SC notification for 5th time).
SC721-58	B	Bundle Transport 1 Release Motor Error
SC721-59	B	<p>Bundle Transport 2 Release Motor Error</p> <ul style="list-style-type: none"> During movement to home, the home position could not be detected within a predetermined pulse (Jam notification for 1st to 4th times, SC notification for 5th time). During movement from home, the home position was detected for longer than a predetermined pulse (Jam notification for 1st to 4th times, SC notification for 5th time).
SC721-80	B	<p>Folding Transport Motor Error</p> <ul style="list-style-type: none"> Motor driver detects an error (short-circuit or overheating) (1st time is SC)

5.Troubleshooting

SC No.	Type	Error Name/Error Condition/Major Cause/Solution
SC721-70	B	Tray 1 Lift Motor Error
		<ul style="list-style-type: none"> Motor driver detects an error (short-circuit or overheating) (1st time is SC). During descent, the paper surface sensor still detects paper even after a predetermined time elapses (Jam notification for 1st to 4th times, SC notification for 5th time). During ascent, the paper surface sensor could not detect the paper surface even after a predetermined time elapses (Jam notification for 1st to 4th times, SC notification for 5th time).
SC721-71	B	Shift Motor 1 Error
		<ul style="list-style-type: none"> During movement to home, the home position could not be detected within a predetermined pulse (Jam notification for 1st to 4th times, SC notification for 5th time). During movement from home, the home position was detected for longer than a predetermined pulse (Jam notification for 1st to 4th times, SC notification for 5th time).
SC721-80	B	Folding Transport Motor Error
		Motor driver detects an error (short-circuit or overheating) (1st time is SC)
SC721-81	B	Paper Guide Drive Motor Error
		<ul style="list-style-type: none"> During movement to home, the home position could not be detected within a predetermined pulse (Jam notification for 1st to 4th times, SC notification for 5th time). During movement from home, the home position was detected for longer than a predetermined pulse (Jam notification for 1st to 4th times, SC notification for 5th time).
		<ul style="list-style-type: none"> Overcurrent (-03 only) Staple jam (-44 only) Encoder error (-11, -11, -25, -44) Motor defective Connector disconnected, or loose Motor overload HP sensor defective Paper surface sensor defective (-70 only)
		<p>Check if the SC occurs by opening/closing covers, and input/output check. If the SC occurs again, do the following steps. Check if the SC reoccurs by cycling the power after each step.</p> <ul style="list-style-type: none"> The target parts are the motor and related HP sensor that SC occurred. <p>1. Check if the connector of the target part is connected securely. Reconnect the</p>

SC No.	Type	Error Name/Error Condition/Major Cause/Solution
		<p>connector if it is disconnected, or loose.</p> <p>2. Check the harness for the target part. Replace the harness if it is disconnected, or damaged.</p> <p>3. Check if the motor runs, sensors turn OFF/ON, has no overloads, and is properly driven. Replace the parts if there are any defects.</p> <p>4. Check if there are any signs of a short circuit. Replace the parts if there are any defects.</p>

SC No.	Type	Error Name/Error Condition/Major Cause/Solution
SC721		Booklet Finisher SR3270 Error
SC721-06	C	Access error to NVRAM
		Error occurs when accessing NV memory.
		Connection failure or malfunction of NV memory
		Check if the SC occurs by turning the main power OFF then ON. If the SC occurs again, do the following steps.
		1. Pull out and reinsert the NV memory to check if the NV memory is correctly inserted into the IC socket. If the SC cannot be recovered, replace the main board.

SC No.	Type	Error Name/Error Condition/Major Cause/Solution
SC722		Finisher SR3260 Error
SC722-03	B	Protection Device Intercept Error 1
		Fuse blowout is detected
SC722-04	B	Protection Device Intercept Error 2
		Fault signal of interlock system protection device (high-side switch) detected when power on.
SC722-06	C	See the descriptions next table below.
SC722-10	B	Transport Motor 1 Error
		Motor driver detects an error state (DC motor control error) (Jam notification for 1st to 4th times, SC notification for 5th time).
SC722-11	B	Transport Motor 2 Error
		Motor driver detects an error state (DC motor control error) (Jam notification for 1st to 4th times, SC notification for 5th time).
SC722-17	B	Paper Eject Motor 2 Error
		Motor driver detects an error state (DC motor control error) (Jam notification for 1st to 4th times, SC notification for 5th time).

5.Troubleshooting

SC No.	Type	Error Name/Error Condition/Major Cause/Solution
SC722-24	B	Paper Exit Guide Plate Open/Close motor Error
		<ul style="list-style-type: none"> • During movement to home, the home position could not be detected within a predetermined pulse (Jam notification for 1st to 4th times, SC notification for 5th time). • During movement from home, the home position was detected for longer than a predetermined pulse (Jam notification for 1st to 4th times, SC notification for 5th time).
SC722-25	B	Punch Drive Motor Error
		<ul style="list-style-type: none"> • During movement to home, the home position could not be detected within a predetermined time (Jam notification for 1st to 4th times, SC notification for 5th time). • During movement from home, the home position was detected even after a predetermined time elapsed (Jam notification for 1st to 4th times, SC notification for 5th time). • Output from the encoder could not be counted for a predetermined number of times within a predetermined time (Jam notification for 1st to 4th times, SC notification for 5th time).
SC722-27	B	Punch Movement Motor Error
SC722-28	B	Punch Horizontal Registration Detection Error
SC722-30	B	Jogger Motor 1 Error
SC722-33	B	Positioning Roller Motor Error
SC722-41	B	Release Motor Error
		<ul style="list-style-type: none"> • During movement to home, the home position could not be detected within a predetermined pulse (Jam notification for 1st to 4th times, SC notification for 5th time). • During movement from home, the home position was detected even after a predetermined pulse elapsed (Jam notification for 1st to 4th times, SC notification for 5th time).
SC722-42	B	Stapler Retreat Motor Error
		<ul style="list-style-type: none"> • During movement to home, the home position could not be detected within a predetermined pulse (Jam notification for 1st to 4th times, SC notification for 5th time). • During movement from home, the home position was detected even after a predetermined pulse elapsed (Jam notification for 1st to 4th times, SC

SC No.	Type	Error Name/Error Condition/Major Cause/Solution
		<p>notification for 5th time).</p> <ul style="list-style-type: none"> • During movement from home, retreat sensor ON could not be detected even after a predetermined pulse elapsed (Jam notification for 1st to 4th times, SC notification for 5th time). • During initialization, retreat sensor ON was detected simultaneously when the home position is detected (Jam notification for 1st to 4th times, SC notification for 5th time).
SC722-44	B	<p>Stapler Motor Error</p> <ul style="list-style-type: none"> • Motor driver detects an error (short-circuit or overheating) (1st time is SC). • During movement to home, the home position could not be detected even after a predetermined time elapsed (Jam notification for 1st to 4th times, SC notification for 5th time). • During movement from home, the home position was detected even after a predetermined time elapsed (Jam notification for 1st to 4th times, SC notification for 5th time). • During motor drive, the output from the encoder could not be counted for a predetermined number of times within a predetermined time (Jam notification for 1st to 4th times, SC notification for 5th time).
SC722-45	B	<p>Stapleless Stapler Transfer Motor Error</p> <ul style="list-style-type: none"> • Motor driver detects an error (short-circuit or overheating) (1st time is SC). • During movement to home, the home position could not be detected within a predetermined pulse (Jam notification for 1st to 4th times, SC notification for 5th time). • During movement from home, the home position was detected even after a predetermined pulse elapsed (Jam notification for 1st to 4th times, SC notification for 5th time).
SC722-46	B	<p>Stapleless Stapler Motor Error</p> <ul style="list-style-type: none"> • Motor driver detects an error (short-circuit or overheating) (1st time is SC). • During movement to home, the home position could not be detected even after a predetermined time elapsed (Jam notification for 1st to 4th times, SC notification for 5th time). • During movement from home, the home position was detected even after a predetermined time elapsed (Jam notification for 1st to 4th times, SC notification for 5th time).
SC722-47	B	<p>Paper Guide Drive Motor Error</p> <ul style="list-style-type: none"> • During movement to home, the home position could not be detected within a predetermined pulse (Jam notification for 1st to 4th times, SC notification for

5.Troubleshooting

SC No.	Type	Error Name/Error Condition/Major Cause/Solution
		<p>5th time).</p> <ul style="list-style-type: none"> .During movement from home, the home position was detected for longer than a predetermined pulse (Jam notification for 1st to 4th times, SC notification for 5th time).
SC722-70	B	<p>Tray 1 Lift Motor Error</p> <ul style="list-style-type: none"> Motor driver detects an error (short-circuit or overheating) (1st time is SC). During descent, the paper surface sensor still detects paper even after a predetermined time (t0sec) elapses (Jam notification for 1st to 4th times, SC notification for 5th time). During ascent, the paper surface sensor could not detect the paper surface even after a predetermined time (t0sec) elapses (Jam notification for 1st to 4th times, SC notification for 5th time).
SC722-71	B	Shift Motor 1 Error
SC722-81	B	Paper Guide Motor
		<ul style="list-style-type: none"> During movement to home, the home position could not be detected within a predetermined pulse (Jam notification for 1st to 4th times, SC notification for 5th time). During movement from home, the home position was detected for longer than a predetermined pulse (Jam notification for 1st to 4th times, SC notification for 5th time).
		<ul style="list-style-type: none"> Overcurrent (-03 only) Staple jam (-44 only) Encoder error (-11, -11, -25, -44) Motor defective Connector disconnected, or loose Motor overload HP sensor defective Paper surface sensor defective (-70 only)
		<p>Check if the SC occurs by opening/closing covers, and input/output check. If the SC occurs again, do the following steps. Check if the SC reoccurs by cycling the power after each step.</p> <ul style="list-style-type: none"> The target parts are the motor and related HP sensor that SC occurred. <ol style="list-style-type: none"> 1. Check if the connector of the target part is connected securely. Reconnect the connector if it is disconnected, or loose. 2. Check the harness for the target part. Replace the harness if it is disconnected, or damaged.

SC No.	Type	Error Name/Error Condition/Major Cause/Solution
		<p>3. Check if the motor runs, sensors turn OFF/ON, has no overloads, and is properly driven. Replace the parts if there are any defects.</p> <p>4. Check if there are any signs of a short circuit. Replace the parts if there are any defects.</p>

SC No.	Type	Error Name/Error Condition/Major Cause/Solution
SC722		Finisher SR3260 Error
SC722-06	C	Access error to NVRAM
		Error occurs when accessing NV memory.
		Connection failure or malfunction of NV memory
		Check if the SC occurs by turning the main power OFF then ON. If the SC occurs again, do the following steps.
		<p>1. Pull out and reinsert the NV memory to check if the NV memory is correctly inserted into the IC socket. If the SC cannot be recovered, replace the main board.</p>

SC No.	Type	Error Name/Error Condition/Major Cause/Solution
SC723		Internal Finisher SR3300 Error
SC723-03	B	Power Supply Error
		When original source 24V power supply is ON, protection device intercept of non-interlock power supply system is detected.
		A motor failure or harness short-circuit occur in the non-interlock power supply system.
		<ul style="list-style-type: none"> • Replace the short-circuited harnesses • Replace the protection devices
SC723-10	B	Transport Motor Error
		The DCM driver error detection is started after reset, and predetermined milliseconds error signal is detected (Jam notification for 1st to 4th times, SC notification for 5th time).
		<ul style="list-style-type: none"> • Transport Motor failure • Harness short-circuit • Circuit board failure • Over current • Abnormal temperature
		<ul style="list-style-type: none"> • Replace the motor • Replace the harness • Replace the circuit board.

5.Troubleshooting

SC No.	Type	Error Name/Error Condition/Major Cause/Solution
SC723-20	B	Junction Gate Motor Error
		When the junction gate HP sensor was not turned off while predetermined seconds applied to the junction gate motor with the HP sensor turned on (Jam notification for 1st to 4th times, SC notification for 5th time). When the junction gate HP sensor was not turned on while predetermined seconds applied to the junction gate motor with the HP sensor turned off (Jam notification for 1st to 4th times, SC notification for 5th time).
		<ul style="list-style-type: none"> • Junction Gate Motor failure • Connector disconnected • Over load • Junction gate HP sensor error
		<ul style="list-style-type: none"> • Check the connection • Replace the motor/sensor • Replace the harness
SC723-24	B	Exit Paper Pressure Motor Error
		When the exit paper pressure HP sensor was not turned off while predetermined seconds applied to the exit pressure release motor with the HP sensor turned on (Jam notification for 1st to 4th times, SC notification for 5th time). When paper output pressure HP sensor was not turned on while predetermined seconds applied to the exit pressure release motor with the HP sensor turned off (Jam notification for 1st to 4th times, SC notification for 5th time).
		<ul style="list-style-type: none"> • Exit Pressure Release Motor failure • Connector disconnected • Over load • Exit pressure release HP sensor error
		<ul style="list-style-type: none"> • Check the connection • Replace the motor/sensor • Replace the harness
SC723-44	B	Stapler Motor Error
		When the stapler drive HP sensor was not turned off while predetermined seconds applied to the stapler motor with the HP sensor turned on (Jam notification for 1st to 4th times, SC notification for 5th time). When stapler drive HP sensor was not turned on while predetermined seconds applied to the stapler motor with the HP sensor turned off (Jam notification for 1st to 4th times, SC notification for 5th time). The STM driver error detection is started after reset, and predetermined seconds error signal is detected (Jam notification for 1st to 4th times, SC notification for 5th time).

SC No.	Type	Error Name/Error Condition/Major Cause/Solution
		<ul style="list-style-type: none"> • Stapler Motor failure • Connector disconnected • Stapler Motor overload • Stapler HP sensor error • Harness short-circuit • Circuit board failure • Excess current • Abnormal temperature <hr/> <ul style="list-style-type: none"> • Check the connection • Replace the motor/sensor • Replace the harness • Replace the circuit board
SC723-71	B	<p data-bbox="391 824 598 857">Shift Motor Error</p> <p data-bbox="391 875 1417 1003">When the shift HP sensor was not turned off while predetermined seconds applied to the shift motor with the HP sensor turned on (Jam notification for 1st to 4th times, SC notification for 5th time).</p> <p data-bbox="391 1021 1401 1149">When shift HP sensor was not turned on while predetermined seconds applied to the shift motor with the HP sensor turned off (Jam notification for 1st to 4th times, SC notification for 5th time).</p> <p data-bbox="391 1167 1414 1294">The STM driver error detection is started after reset, and predetermined seconds error signal is detected (Jam notification for 1st to 4th times, SC notification for 5th time).</p> <hr/> <ul style="list-style-type: none"> • Shift Motor failure • Connector disconnected • Shift Motor overload • Shift HP sensor error • Harness short-circuit • Circuit board failure • Excess current • Abnormal temperature <hr/> <p data-bbox="391 1693 1390 1821">Check if the SC occurs by opening/closing covers, and input/output check. If the SC occurs again, do the following steps. Check if the SC reoccurs by cycling the power after each step.</p> <ul style="list-style-type: none"> • The target parts are the motor and related HP sensor that SC occurred. <ol style="list-style-type: none"> 1. Check if the connector of the target part is connected securely. Reconnect the connector if it is disconnected, or loose. 2. Check the harness for the target part. Replace the harness if it is disconnected, or damaged.

5. Troubleshooting

SC No.	Type	Error Name/Error Condition/Major Cause/Solution
		<p>3. Check if the motor runs, sensors turn OFF/ON, has no overloads, and is properly driven. Replace the parts if there are any defects.</p> <p>4. Check if there are any signs of a short circuit. Replace the parts if there are any defects.</p>

SC No.	Type	Error Name/Error Condition/Major Cause/Solution
SC724		Internal Finisher SR3250 Error
SC724-03	B	<p>Protection Device Intercept Error 1 (Internal Finisher)</p> <p>Failure to supply power to fuse and later circuits (parts) of finisher controller board detected when power on.</p>
SC724-04	B	<p>Protection Device Intercept Error 2 (Internal Finisher)</p> <p>Fault signal of interlock system protection device (high-side switch) detected when power on.</p>
SC724-24	B	<p>Paper Exit Guide Plate Open/Close Motor Error</p> <ul style="list-style-type: none"> When paper exit guide plate open/close motor is driven for specified time (msec.) after paper exit guide plate HP sensor ON, the HP sensor does not switch OFF (Jam notification for 1st to 4th times, SC notification for 5th time). When paper exit guide plate open/close motor is driven for specified time (msec.) after paper exit guide plate HP sensor OFF, the HP sensor does not switch ON (Jam notification for 1st to 4th times, SC notification for 5th time).
SC724-25	B	<p>Punch Motor Error</p> <ul style="list-style-type: none"> When punch motor is driven for specified time (msec.) after punch HP sensor ON, the HP sensor does not switch OFF (Jam notification for 1st to 4th times, SC notification for 5th time). When punch motor is driven for specified time (msec.) after punch HP sensor OFF, the HP sensor does not switch ON (Jam notification for 1st to 4th times, SC notification for 5th time).
SC724-27	B	<p>Punch Displacement Motor Error</p> <ul style="list-style-type: none"> When punch displacement motor is driven for specified time (msec.) when punch displacement HP sensor is ON, the HP sensor does not switch OFF (Jam notification for 1st to 4th times, SC notification for 5th time). When punch displacement motor is driven for specified time (msec.) when punch displacement HP sensor is OFF, the HP sensor does not switch ON (Jam notification for 1st to 4th times, SC notification for 5th time).
SC724-28	B	<p>Punch Horizontal Registration Detection Motor Error</p> <ul style="list-style-type: none"> When horizontal registration displacement motor is driven for specified time (msec.) when horizontal registration displacement HP sensor is ON, the HP

SC No.	Type	Error Name/Error Condition/Major Cause/Solution
		<p>sensor does not switch OFF (Jam notification for 1st to 4th times, SC notification for 5th time).</p> <ul style="list-style-type: none"> When horizontal registration displacement motor is driven for specified time (msec.) when horizontal registration displacement HP sensor is OFF, the HP sensor does not switch ON (Jam notification for 1st to 4th times, SC notification for 5th time).
SC724-31	B	Jogger Front Motor Error
		<ul style="list-style-type: none"> When front jogger motor is driven for specified time (msec.) when front jogger HP sensor is ON, the HP sensor does not switch OFF (Jam notification for 1st to 4th times, SC notification for 5th time). When front jogger motor is driven for specified time (msec.) when front jogger HP sensor is OFF, the HP sensor does not switch ON (Jam notification for 1st to 4th times, SC notification for 5th time).
SC724-32	B	Jogger Rear Motor Error
		<ul style="list-style-type: none"> When rear jogger motor is driven for specified time (msec.) when rear jogger HP sensor is ON, the HP sensor does not switch OFF (Jam notification for 1st to 4th times, SC notification for 5th time). When rear jogger motor is driven for specified time (msec.) when rear jogger HP sensor is OFF, the HP sensor does not switch ON (Jam notification for 1st to 4th times, SC notification for 5th time).
SC724-33	B	Positioning Roller Motor Error
		<ul style="list-style-type: none"> During initialization/positioning roller descent, even when the positioning roller motor is driven for specified time (msec.) when the positioning roller HP sensor is ON, the HP sensor does not switch OFF (Jam notification for 1st to 4th times, SC notification for 5th time). During initialization, even when the positioning roller motor is driven for specified time (msec.) when the positioning roller HP sensor is OFF, the HP sensor does not switch ON (Jam notification for 1st to 4th times, SC notification for 5th time). When the positioning roller is lifted from the press position, even when driven for specified time (msec.), the HP sensor does not switch ON (Jam notification for 1st to 4th times, SC notification for 5th time).
SC724-38	B	Paper Press Motor Error
		<ul style="list-style-type: none"> When the paper press HP sensor is ON and the paper press motor is driven for specified time (msec.), the HP sensor does not switch OFF (Jam notification for 1st to 4th times, SC notification for 5th time). When the paper press HP sensor is OFF and the paper press motor is driven for specified time (msec.), the HP sensor does not switch ON (Jam notification

5.Troubleshooting

SC No.	Type	Error Name/Error Condition/Major Cause/Solution
		for 1st to 4th times, SC notification for 5th time).
SC724-42	B	<p>Stapler Displacement Movable Motor Error</p> <ul style="list-style-type: none"> • Sifter stapler displacement HP sensor ON, even when the stapler retreat motor is driven for specified time (msec.), the HP sensor does not switch OFF (Jam notification for 1st to 4th times, SC notification for 5th time). • After stapler displacement HP sensor OFF, even when the stapler retreat motor is driven for specified time (msec.), the HP sensor does not switch ON (Jam notification for 1st to 4th times, SC notification for 5th time).
SC724-70	B	<p>Shift Tray Ascent/Descent Motor Error</p> <ul style="list-style-type: none"> • During ascent from paper surface sensor ON, even after specified time (msec.) elapses, the paper surface sensor does not switch OFF (Jam notification for 1st to 4th times, SC notification for 5th time). • During descent from paper surface sensor OFF, the paper surface sensor does not switch ON even after specified time (msec.) elapses (Jam notification for 1st to 4th times, SC notification for 5th time). • During descent to the packing position, the full sensor does not switch ON even if the specified time (msec.) elapses.
SC724-71	B	<p>Shift Motor Error (Internal Shift Tray SH3080)</p>
		The level of shift sensor output does not change when the shift motor is driven for 186 msec. after the motor is turned ON.
		<ul style="list-style-type: none"> • Motor defective • Connector disconnected • Motor overload • Home position sensor error • Paper surface sensor error (*SC724-38, 70 only) • Staple jam (*SC724-86 only) <p>Check if the SC occurs by opening/closing covers, and input/output check. If the SC occurs again, do the following steps. Check if the SC reoccurs by cycling the power after each step.</p> <ul style="list-style-type: none"> • The target parts are the motor and related HP sensor that SC occurred. <ol style="list-style-type: none"> 1. Check if the connector of the target part is connected securely. Reconnect the connector if it is disconnected, or loose. 2. Check the harness for the target part. Replace the harness if it is disconnected, or damaged. 3. Check if the motor runs, sensors turn OFF/ON, has no overloads, and is properly driven. Replace the parts if there are any defects. 4. Check if there are any signs of a short circuit. Replace the parts if there are

SC No.	Type	Error Name/Error Condition/Major Cause/Solution
		any defects.

SC No.	Type	Error Name/Error Condition/Major Cause/Solution
SC724		Internal Finisher SR3250 Error
SC724-80	B	Shift Motor Error
		<ul style="list-style-type: none"> When the shift roller HP sensor is ON, the HP sensor does not switch OFF even when the shift roller motor is driven for specified time (msec.) (Jam notification for 1st to 4th times, SC notification for 5th time). When the shift roller HP sensor is OFF, the HP sensor does not switch ON even when the shift roller motor is driven for specified time (msec.) (Jam notification for 1st to 4th times, SC notification for 5th time).
SC724-81	B	Cooling Fan Motor Lock
		In the motor ON state, the value of the lock sensor is checked.
SC724-86	B	Stapler Motor Error
		<ul style="list-style-type: none"> HP sensor does not switch OFF even when the stapler motor is driven for specified time (msec.) after the stapler HP sensor switches ON (Jam notification for 1st to 4th times, SC notification for 5th time). HP sensor does not switch ON even when the stapler motor is driven for specified time (msec.) after the stapler HP sensor switches OFF (Jam notification for 1st to 4th times, SC notification for 5th time).
		<ul style="list-style-type: none"> Motor defective Connector disconnected Motor overload Home position sensor error Paper surface sensor error (*SC724-38, 70 only) Staple jam (*SC724-86 only)
		<p>Check if the SC occurs by opening/closing covers, and input/output check. If the SC occurs again, do the following steps. Check if the SC reoccurs by cycling the power after each step.</p> <ul style="list-style-type: none"> The target parts are the motor and related HP sensor that SC occurred. <ol style="list-style-type: none"> 1. Check if the connector of the target part is connected securely. Reconnect the connector if it is disconnected, or loose. 2. Check the harness for the target part. Replace the harness if it is disconnected, or damaged. 3. Check if the motor runs, sensors turn OFF/ON, has no overloads, and is properly driven. Replace the parts if there are any defects. 4. Check if there are any signs of a short circuit. Replace the parts if there are

5.Troubleshooting

SC No.	Type	Error Name/Error Condition/Major Cause/Solution
		any defects.

SC No.	Type	Error Name/Error Condition/Major Cause/Solution
SC727		Internal Multi-Fold Unit FD3010 Error
SC727-01	B	Connection Error to Downstream Unit
		<p>Communication error has occurred with the serial interface of the downstream unit. This is displayed as an SC code from its initial detection.</p> <ul style="list-style-type: none"> • Harness defective • Downstream unit defective • Controller board defective • I/F connector defective <p>Remove the jammed paper or slip of paper from the tray, and check if the SC occurs by turning the main power OFF then ON. If the SC occurs again, do the following steps. Check if the SC reoccurs by cycling the power after each step.</p> <ol style="list-style-type: none"> 1. Turn the power off, disconnect the interface connector connected to the machine, connect the interface connector of the downstream unit to the machine, and then turn the power on. 2. If the downstream unit does not operate, resulting in connection error, there is a problem with the downstream unit, so repair the downstream unit. 3. Check the harness connections between the controller board and each connector. Replace the harness if it is damaged, or connect it if it is disconnected. 4. Check if there are any signs of a short circuit. Replace the parts if there are any defects.
SC727-03	B	Protection Device Intercept Error 1
		<ul style="list-style-type: none"> • Fuse (FU3) break is detected • 24-V power supply line error <p>This is displayed as an SC code from its initial detection.</p> <ul style="list-style-type: none"> • Fuse (FU3) is blowout • Controller board defective • 24-V harness entrapment (short circuit) <p>Remove the jammed paper or slip of paper from the tray, and check if the SC occurs by turning the main power OFF then ON. If the SC occurs again, do the following steps. Check if the SC reoccurs by cycling the power after each step.</p> <ul style="list-style-type: none"> • The target parts are all the motors and the sensors.

SC No.	Type	Error Name/Error Condition/Major Cause/Solution
		<ol style="list-style-type: none"> 1. Check that the harness between the PCB and motor/solenoid is not stripped or entrapped. Replace the harness if there are any defects. 2. Rotate each motor shaft by hand to check for any overload. Replace the motor if there are any defects. 3. Check if there is any unusual odor from the solenoid or any problem with its appearance. Replace the solenoid if there are any defects. 4. Check if there are any signs of a short circuit on PCB. Replace the PCB if there are any defects.
SC727-04	B	Protection Device Intercept Error 2
		<ul style="list-style-type: none"> • Poly-switch (FU4) break is detected • Limit line disturbances from inrush currents has occurred to the interlock system. <p>This is displayed as an SC code from its initial detection.</p> <ul style="list-style-type: none"> • Poly-switch (FU4) trip (Trip refers to the phenomenon whereby an overcurrent flows into the poly-switch, resulting in high resistance.) • Controller board defective • 24-V harness entrapment (short circuit) <p>Remove the jammed paper or slip of paper from the tray, and check if the SC occurs by turning the main power OFF then ON, submitting a job, feeding paper, opening/closing covers, and input/output check. If the SC occurs again, do the following steps. Check if the SC reoccurs by cycling the power after each step.</p> <ul style="list-style-type: none"> • The target parts are all the motors and the sensors. <ol style="list-style-type: none"> 1. Check that the harness between the PCB and the motor/solenoid is not stripped or entrapped. Replace the harness if there are any defects. 2. Rotate each motor shaft by hand to check for any overload. Replace the motor if there are any defects. 3. Check if there is any unusual odor from the solenoid or any problem with its appearance. Replace the solenoid if there are any defects. 4. Check if there are any signs of a short circuit on PCB. Replace the PCB if there are any defects.
SC727-06	C	NVRAM Error 1
		<p>An error has occurred during an access to the NVRAM.</p> <p>This is displayed as an SC code from its initial detection.</p> <p>NVRAM is disconnected, or defective</p> <p>Turn the main power OFF then ON after checking whether there are no foreign objects (such as remaining paper) in the tray. If the SC occurs again, replace the</p>

5.Troubleshooting

SC No.	Type	Error Name/Error Condition/Major Cause/Solution
		controller board.
SC727-10	B	Transport Motor Error
		<p>Motor error (Encoder error) (Jam notification for 1st to 4th times, SC notification for 5th time)</p> <ul style="list-style-type: none"> • Motor defective • Motor harness entrapped (short circuit or breaking of wire) • Connector disconnected • Controller board defective <p>Remove the jammed paper or slip of paper from the tray, and check if the SC occurs by turning the main power OFF then ON, submitting a job, feeding paper, opening/closing covers, and input/output check. If the SC occurs again, do the following steps. Check if the SC reoccurs by cycling the power after each step</p> <ol style="list-style-type: none"> 1. Check if all connectors between the controller board and the motors are connected securely. Reconnect the connectors if they are disconnected, or loose. 2. Replace the harness if it is disconnected, or damaged. 3. Check if the motor runs, has no overloads, and is properly driven. Replace the parts if there are any defects. 4. Check if there are any signs of a short circuit. Replace the parts if there are any defects.
SC727-12	B	Registration Motor Error
		<p>Motor error (Encoder error) (Jam notification for 1st to 4th times, SC notification for 5th time)</p> <ul style="list-style-type: none"> • Motor defective • Motor harness entrapped (short circuit or breaking of wire) • Connector disconnected • Controller board defective <p>Remove the jammed paper or slip of paper from the tray, and check if the SC occurs by turning the main power OFF then ON, submitting a job, feeding paper, opening/closing covers, and input/output check. If the SC occurs again, do the following steps. Check if the SC reoccurs by cycling the power after each step.</p> <ol style="list-style-type: none"> 1. Check if all connectors between the controller board and the motors are connected securely. Reconnect the connectors if they are disconnected, or loose. 2. Replace the harness if it is disconnected, or damaged. 3. Check if the motor runs, has no overloads, and is properly driven. Replace the

SC No.	Type	Error Name/Error Condition/Major Cause/Solution
		<p>parts if there are any defects.</p> <p>4. Check if there are any signs of a short circuit. Replace the parts if there are any defects.</p>
SC727-20	B	JG Crease Motor Error 1
		<ul style="list-style-type: none"> • Motor error (Encoder error) • The junction gate is not at the HP position. (Jam notification for 1st to 4th times, SC notification for 5th time).
		<ul style="list-style-type: none"> • Motor defective • Motor/sensor harness entrapped (short circuit or breaking of wire) • Connector disconnected • Junction Solenoid HP Sensor defective • Controller board defective
		<p>Remove the jammed paper or slip of paper from the tray, and check if the SC occurs by turning the main power OFF then ON, submitting a job, feeding paper, opening/closing covers, and input/output check. If the SC occurs again, do the following steps. Check if the SC reoccurs by cycling the power after each step.</p> <p>1. Check if all connectors between the controller board and the motors/sensors are connected securely. Reconnect the connectors if they are disconnected, or loose.</p> <p>2. Replace the harness if it is disconnected, or damaged.</p> <p>3. Check if the motor runs, has no overloads, and is properly driven. Replace the parts if there are any defects.</p> <p>4. Check if the sensor turns OFF/ON. Replace the parts if there are any defects.</p> <p>5. Check if there are any signs of a short circuit. Replace the parts if there are any defects.</p>
SC727-39	B	1st Fold Motor Error
		<p>Motor error (Encoder error) (Jam notification for 1st to 4th times, SC notification for 5th time).</p>
		<ul style="list-style-type: none"> • Motor defective • Motor harness entrapped (short circuit or breaking of wire) • Connector disconnected • Controller board defective
		<p>Remove the jammed paper or slip of paper from the tray, and check if the SC occurs by turning the main power OFF then ON, submitting a job, feeding paper, opening/closing covers, and input/output check. If the SC occurs again, do the following steps. Check if the SC reoccurs by cycling the power after each step.</p>

5.Troubleshooting

SC No.	Type	Error Name/Error Condition/Major Cause/Solution
		<ol style="list-style-type: none"> 1. Check if all connectors between the controller board and the motors are connected securely. Reconnect the connectors if they are disconnected, or loose. 2. Replace the harness if it is disconnected, or damaged. 3. Check if the motor runs, has no overloads, and is properly driven. Replace the parts if there are any defects. 4. Check if there are any signs of a short circuit. Replace the parts if there are any defects.
SC727-41	B	JG Crease Motor Error 2
		<ul style="list-style-type: none"> • Motor error (Encoder error) • Crease Roller is not at the HP position. (Jam notification for 1st to 4th times, SC notification for 5th time). <hr/> <ul style="list-style-type: none"> • Motor defective • Motor/sensor harness entrapped (short circuit or breaking of wire) Connector disconnected • Crease HP Sensor defective • Controller board defective <hr/> <p>Remove the jammed paper or slip of paper from the tray, and check if the SC occurs by turning the main power OFF then ON, submitting a job, feeding paper, opening/closing covers, and input/output check. If the SC occurs again, do the following steps. Check if the SC reoccurs by cycling the power after each step.</p> <ol style="list-style-type: none"> 1. Check if all connectors between the controller board and the motors/sensors are connected securely. Reconnect the connectors if they are disconnected, or loose. 2. Replace the harness if it is disconnected, or damaged. 3. Check if the motor runs, has no overloads, and is properly driven. Replace the parts if there are any defects. 4. Check if the sensor turns OFF/ON. Replace the parts if there are any defects. 5. Check if there are any signs of a short circuit. Replace the parts if there are any defects.
SC727-71	B	2nd Fold Motor Error
		<p>Encoder error (Jam notification for 1st to 4th times, SC notification for 5th time).</p> <hr/> <ul style="list-style-type: none"> • Motor defective • Motor harness entrapped (short circuit or breaking of wire) • Connector disconnected

SC No.	Type	Error Name/Error Condition/Major Cause/Solution
		<ul style="list-style-type: none"> Controller board defective <p>Remove the jammed paper or slip of paper from the tray, and check if the SC occurs by turning the main power OFF then ON, submitting a job, feeding paper, opening/closing covers, and input/output check. If the SC occurs again, do the following steps. Check if the SC reoccurs by cycling the power after each step.</p> <ol style="list-style-type: none"> Check if all connectors between the controller board and the motors are connected securely. Reconnect the connectors if they are disconnected, or loose. Replace the harness if it is disconnected, or damaged. Check if the motor runs, has no overloads, and is properly driven. Replace the parts if there are any defects. Check if there are any signs of a short circuit. Replace the parts if there are any defects.
SC727-72	B	The power supply for the sensor is defective.
		<p>The power supply for the sensor (5V_SN) is defective. This is displayed as an SC code from its initial detection.</p> <ul style="list-style-type: none"> Sensor harness entrapped (short circuit or breaking of wire) Sensor defective Controller board defective <p>Turn the main power OFF then ON after checking whether there are no foreign objects (such as remaining paper) in the tray. If the SC occurs again, do the following steps. Check if the SC reoccurs by cycling the power after each step.</p> <ol style="list-style-type: none"> Check if the harness is connected to the wrong sensor. Reconnect the connector if there are any defects. Replace the harness if it is disconnected, or damaged. Check if the sensor turns OFF/ON. Replace the parts if there are any defects. Check if the motor runs, has no overloads, and is properly driven. Replace the parts if there are any defects. Check if there are any signs of a short circuit. Replace the parts if there are any defects.

SC No.	Type	Error Name/Error Condition/Major Cause/Solution
SC761		Bridge Unit BU3090 or Side Tray Type M37 Error
SC761-03	B	Protection Device Intercept Error 5V
SC761-04	B	Protection Device Intercept Error 24V

5.Troubleshooting

SC No.	Type	Error Name/Error Condition/Major Cause/Solution
		Fuse blowout occurs due to over current during power injection (output detected for longer than 2 seconds).
		<ul style="list-style-type: none"> • Over current of bridge unit motor • Over current due to short-circuit in PCB
		<ul style="list-style-type: none"> • Replace the bridge unit or side tray • Replace the PCB of bridge unit or side tray

SC No.	Type	Error Name/Error Condition/Major Cause/Solution
SC780-01	D	Bank 1 (Upper optional paper tray) Protection Device Intercept Error
		When original source of 5V power supply is ON, protection device intercept of 24V power system is detected.
		In 24V power supply system: <ul style="list-style-type: none"> • Motor defective • Solenoid defective • Harness short- circuit
		Remove the jammed paper or slip of paper from the tray, and check if the SC occurs by turning the main power OFF then ON. If the SC occurs again, do the following steps. Check if the SC reoccurs by cycling the power after each step. <ol style="list-style-type: none"> 1. Check if all connectors in tray 1, 2, and optional upper tray are connected securely. Reconnect the connectors if they are disconnected, or loose. 2. Check the harness in tray 1, 2, and optional upper tray. Replace the harness if it is disconnected, or damaged. 3. Check if the motor runs, has no overloads, and is properly driven. Replace the parts if there are any defects. 4. Check if there are any signs of a short circuit. Replace the parts if there are any defects.

SC No.	Type	Error Name/Error Condition/Major Cause/Solution
SC781-01	D	Bank 2 (Lower optional paper tray) Protection Device Intercept Error
		When original source of 5V power supply is ON, protection device intercept of 24V power system is detected.
		In 24V power supply system: <ul style="list-style-type: none"> • Motor defective • Solenoid defective • Harness short- circuit

SC No.	Type	Error Name/Error Condition/Major Cause/Solution
		<p>Remove the jammed paper or slip of paper from the tray, and check if the SC occurs by turning the main power OFF then ON. If the SC occurs again, do the following steps. Check if the SC reoccurs by cycling the power after each step.</p> <ol style="list-style-type: none"> 1. Check if all connectors in tray 1, 2, and optional upper/lower trays are connected securely. Reconnect the connectors if they are disconnected, or loose. 2. Check the harness in tray 1, 2, and optional upper/lower trays. Replace the harness if it is disconnected, or damaged. 3. Check if the motor runs, has no overloads, and is properly driven. Replace the parts if there are any defects. 4. Check if there are any signs of a short circuit. Replace the parts if there are any defects.

SC No.	Type	Error Name/Error Condition/Major Cause/Solution
SC791-00	D	No bridge unit when finisher is present
		<p>When power supply is switched on or paper is transported, finisher set is detected but bridge unit set is not detected. (during internal finisher SR3250 connection, not detected)</p> <ul style="list-style-type: none"> • Bridge unit not attached • Bridge unit defective
		<ul style="list-style-type: none"> • Reset the bridge unit • Turn the main power OFF/ON.

SC No.	Type	Error Name/Error Condition/Major Cause/Solution
SC792-00	B	No finisher, bridge unit provided
		<p>When power supply is switched on, it is recognized there is no finisher, and a bridge unit is fitted.</p> <ul style="list-style-type: none"> • Finisher connector set incorrectly • In a machine which has a bridge unit connected, a finisher is not fitted • Finisher defective
		Connect finisher or disconnect bridge unit, and turn the main power OFF/ON.

SC No.	Type	Error Name/Error Condition/Major Cause/Solution
SC793-01	B	Unsupported device (ADF) attached.

5.Troubleshooting

SC No.	Type	Error Name/Error Condition/Major Cause/Solution
		<p>Unsupported ADF attached.</p> <ul style="list-style-type: none"> • Finisher connector set incorrectly • In a machine which has a bridge unit connected, a finisher is not fitted • Finisher defective <p>This is caused by attaching an unsupported model.</p> <p>Check the product name of the ADF and attach the correct optional ADF.</p>

SC No.	Type	Error Name/Error Condition/Major Cause/Solution
SC793-02	B	<p>Unsupported peripheral device (for paper feeding) attached.</p>
		<p>Unsupported peripheral device (for paper feeding) attached.</p> <ul style="list-style-type: none"> • Finisher connector set incorrectly • In a machine which has a bridge unit connected, a finisher is not fitted • Finisher defective <p>This is caused by attaching an unsupported model.</p> <p>Check the product name of the optional paper tray and attach the correct optional paper tray.</p>

Fault signal of interlock system protection device (high-side switch) detected when power on.

SC800 (Controller)

No.	Type	Error Name/Error Condition/Major Cause/Solution
SC816-**	[0x0000]	Energy saving I/O subsystem error
SC816-01	D	Subsystem error
SC816-02	D	Sysarch (LPUX_GET_PORT_INFO) error
SC816-03	D	Transition to STR was denied.
SC816-04	D	Interrupt in kernel communication driver
SC816-05	D	Preparation for transition to STR failed.
SC816-06	D	Preparation for transition to STR failed.
SC816-07	D	Sysarch (LPUX_GET_PORT_INFO) error
SC816-08	D	Sysarch (LPUX_ENGINE_TIMERCTRL) error
SC816-09	D	Sysarch (LPUX_RETURN_FACTOR_STR) error
SC816-10 to 12	D	Sysarch (LPUX_GET_PORT_INFO) error
SC816-13	D	open() error
SC816-14	D	Memory address error
SC816-15 to 18	D	open() error
SC816-19	D	Double open() error
SC816-20	D	open() error
SC816-22	D	Parameter error
SC816- 23, 24	D	read() error
SC816-25	D	write () error
SC816-26 to 28	D	write() communication retry error
SC816- 29, 30	D	read() communication retry error
SC816-35	D	read() error
SC816-36 to 96	D	Subsystem error
SC 816- 98	D	Subsystem error
SC 816- 99	D	Subsystem error
		Energy saving I/O subsystem detected some abnormality.
		<ul style="list-style-type: none"> • Energy saving I/O subsystem defective • Energy saving I/O subsystem detected a controller board error (non-

5.Troubleshooting

No.	Type	Error Name/Error Condition/Major Cause/Solution
		<p>response).</p> <ul style="list-style-type: none"> Error was detected during preparation for transition to STR. SC816-99 occurs as a subsystem error except any error from -06 to 96. <p>Check if the SC occurs by turning the power OFF then ON. If the SC occurs again, do the following steps. Check if the SC reoccurs by cycling the power after each step.</p> <ol style="list-style-type: none"> Update the "System/Copy" firmware and the other system firmware modules to the latest version. Disable the STR shift function by SP5-191-001 (Power Str Set). Replace the controller board.

No.	Type	Error Name/Error Condition/Major Cause/Solution
SC817-00	D	<p>Monitor error: File detection / Digital signature error</p> <ul style="list-style-type: none"> Bootloader cannot read any of diagnostic module, kernel, or root filesystem. In a bootloader SD card, the digital signature checking for any of diagnostic module, kernel, or root filesystem is failed. Any of the following items does not exist or is broken OS Flash ROM, Diagnostic module in SD card, Kernel, Root filesystem Any of the following items is revised fraudulently: Diagnostic module in SD card, Kernel, Root filesystem ROM update for controller system Use another booting SD card having a valid digital signature

No.	Type	Error Name/Error Condition/Major Cause/Solution
SC819-00	D	<p>Kernel halt error</p> <p>[xxxx]: Detailed error code</p> <p>Due to a control error, a RAM overflow occurred during system processing. One of the following messages was displayed on the operation panel.</p>
	[0x5032]	<p>HAIC-P2 error</p> <p>HAIC-P2 decompression error (An error occurred in the ASIC compression/decompression module.)</p> <ul style="list-style-type: none"> The code data saved in the HDD was broken for an unexpected reason. (HDD device defective) The code data saved to memory was broken for an unexpected reason. (Memory device defective) ASIC defective Data other than code data was unzipped due to a software malfunction.

No.	Type	Error Name/Error Condition/Major Cause/Solution
		<ul style="list-style-type: none"> • Turn the main power OFF/ON. • Replace the HDD (PCB12). • Replace the memory • Replace the controller board. • Fix the software
	[0x5245]	<p>Link up error</p> <p>Link up transaction between Engine ASIC and Veena was not completed within 100 ms.</p> <p>Either one of following message appears on console if Link up error occurs. RESUME:PCI-Express bus ROOT_DL status error RESUME:PCI-Express bus DETUP status error "0x53554D45" -> Link up error Also, error code "0x5245" and detail code ""0x53554D45" -> Link up error" appears on operation panel.</p> <ul style="list-style-type: none"> • Turn the main power OFF/ON. • Replace the controller board or the engine board (BICU)
	[0x5355]	<p>L2 status time out</p> <p>L2 status register between Engine ASIC and Veena was not reached the target value within 1 sec.</p> <p>Engine ASIC during operation was rebooted or shifted to energy saving mode. Machine reboots when SC23x, SC30x occurs. If Engine ASIC is working when rebooting (or shifting to the energy saving mode), L2 status value is not on target. The following message appears on console. SUSPEND:PCI-Express L2 Status Check Error SUSPEND:PCI-Express L2 Status Check Error Also, error code "0x5355" and detail code ""0x5350454E44" -> L2 status time out" appears on operation panel.</p> <ul style="list-style-type: none"> • Turn the main power OFF/ON. • Replace the controller board or the engine board (BICU)
	[0x6261]	<p>HDD defective</p> <p>Received file system data was broken even if the initialization succeeds and there was no error reply from the HDD.</p> <p>Power supply disconnection during data writing to the HDD.</p> <p>Replace the HDD (PCB12).</p> <p>This SC may occur when turning on the machine for the first time with a new</p>

5.Troubleshooting

No.	Type	Error Name/Error Condition/Major Cause/Solution
		HDD. In this case, turn the main power off/on.
	[0x696e]	gwinit processing end
		If the SCS process is ended for some reason
		If an unexpected error occurs at SCS processing end, gwinit processing also halts (this result is judged a kernel stop error, by gwinit specification)
		"0x69742064" -> "init died"
		Turn the main power OFF/ON.
	[0x766d]	VM full error
		Occurs when too much RAM is used during system processing
		"vm_pageout: VM is full"
		Turn the main power OFF/ON.
	Console string	Other error (characters on operation panel)
		System detected internal mismatch error
		<ul style="list-style-type: none"> • Software defective • Insufficient memory • Hardware driver defective (RAM, flash memory)
		<ul style="list-style-type: none"> • Replace with a larger capacity RAM, or flash memory. • Replace the controller board. • Replace the connected controller option with a new one.

No.	Type	Error Name/Error Condition/Major Cause/Solution
SC821-00	D	Self-diagnostics error: ASIC [xxxx]: Detailed error code
	[0B00]	ASIC register check error
		The write-&-verify check has occurred in the ASIC.
		Defective ASIC device
		Replace the controller board.
	[0B06]	ASIC detection error
		Error in the I/O ASIC for system control detection
		<ul style="list-style-type: none"> • Defective ASIC • Defective North Bridge and PCII/F
		Replace the controller board.
	[0D05]	Comparison error of CPU and ASIC timer
		The CPU checks if the ASIC timer works correctly compared with the CPU timer. If the ASIC timer does not function in the specified range, this SC code is displayed.
		<ul style="list-style-type: none"> • Defective ASIC timer device

No.	Type	Error Name/Error Condition/Major Cause/Solution
		<ul style="list-style-type: none"> Defective CPU device
		Replace the controller board.
	[50A1]	Video bridge device detection error
		Video bridge device is not detected.
		<ul style="list-style-type: none"> Video bridge device ASIC (HARP or KLAVIER) defective. Connection error between PCI I / F of the controller ASIC and video bridge device ASIC.
		Replace the controller board
	[50A2]	Video bridge device (ASIC) register error
		The CPU detects the video bridge device, but detects error data from the video bridge device.
		Defective I/F between the video bridge device and the controller
		Replace the controller board.

No.	Type	Details (Symptom, Possible Cause, Troubleshooting Procedures)
SC822-00	D	Self-diagnostic error: HDD [xxxx]: Detailed error code
	[3003]	HDD timeout
		Check performed only when HDD is installed:
		<ul style="list-style-type: none"> HDD device busy for over 31sec. After a diagnostic command is set for the HDD, but the device remains busy for over 6sec.
		<ul style="list-style-type: none"> HDD defective HDD harness disconnected, defective Controller board defective
		<ul style="list-style-type: none"> Replace the HDD (PCB12). Replace the HDD connector. Replace the controller board.
	[3004]	Diagnostic command error
		No response to the self-diagnostic command from the ASIC to the HDD.
		HDD defective
		Replace the HDD (PCB12).
	[3013]	HDD timeout (first machine)
		HDD device busy for over 31 seconds.
		A diagnostic command is set for the HDD, but the device remains busy for over 6 seconds.
		<ul style="list-style-type: none"> Defective HDD device

5.Troubleshooting

No.	Type	Details (Symptom, Possible Cause, Troubleshooting Procedures)
		<ul style="list-style-type: none"> Defective HDD connector Defective ASIC device
		<ul style="list-style-type: none"> Replace or remove the HDD (PCB12). Replace the HDD connector Replace the controller board
	[3014]	Diagnostics command error (First machine)
		Result of the issuance of diagnostic command is error.
		Defective HDD device
		Replace the HDD (PCB12).

No.	Type	Error Name/Error Condition/Major Cause/Solution
SC823-00	B	Self-diagnostics error: NIC [XXXX]: Detailed error code
	[6101]	MAC address check sum error
		The result of the MAC address check sum does not match the check sum stored in ROM.
		<ul style="list-style-type: none"> Defective SEEP ROM Defective I2C bus (connection)
		Replace the controller board.
	[6104]	PHY IC error
		The PHY IC on the controller cannot be correctly recognized.
		<ul style="list-style-type: none"> Defective PHY chip Defective ASIC MII I/F
		Replace the controller board.
	[6105]	PHY IC loop-back error
		An error occurred during the loop-back test for the PHY IC on the controller.
		<ul style="list-style-type: none"> PHY chip Defective MAC of ASIC (SIMAC/COMIC/CELLO) Defective I/F with the PHY board Defective solder on the PHY board
		Replace the controller board.

No.	Type	Error Name/Error Condition/Major Cause/Solution
SC824-00	C	Self-diagnostics error: NVRAM (resident) [XXXX]: Detailed error code
	[1401]	NVRAM verify error
		NVRAM device is missing or NVRAM device is damaged.

No.	Type	Error Name/Error Condition/Major Cause/Solution
		<ul style="list-style-type: none"> • The NVRAM device is missing. • The NVRAM device is damaged. • NVRAM backup battery exhausted • NVRAM socket damaged
		Replace the NVRAM device.

No.	Type	Error Name/Error Condition/Major Cause/Solution
SC828-00	D [0101]	Self-diagnostic Error (ROM): Bootstrap Code Error
		The CRC is calculated for the boot monitor and the OS program, and an error is detected when the result is different from expected. However, checking is not done for card boot.
		<ul style="list-style-type: none"> • The flash ROM in the boot monitor, self-diagnostic program, or the OS program is corrupted or has deteriorated. • The CPU is defective.
		<ul style="list-style-type: none"> • Reinstall the boot monitor, self-diagnostic program, or OS program. • Replace the controller board.

No.	Type	Error Name/Error Condition/Major Cause/Solution
SC829-00	D	Self-diagnostic Errors (Optional RAM)
	[0301]	Optional Memory 0 Verify Error
		<ul style="list-style-type: none"> • For machines with resident RAM, Optional Memory 0 refers the RAM DIMM installed in the RAM Slot. • For machines without resident RAM, Optional Memory 0 refers to the RAM DIMM installed in Slot 0. • This error does not occur with machines that do not have resident RAM.
		<ul style="list-style-type: none"> • The memory is defective. • Replace the controller board (for machines with no resident RAM, replace the RAM-DIMM).
	[0302]	Optional Memory 0 Structural Error
		Every time the main power is turned ON, the structure of the optional RAM is checked.
		If an error is detected at this point, the self-diagnostic module will not check the optional RAM.
		-
		-
	[0401]	Optional Memory 1 Verify Error
		The standard RAM is made up of 1GB of resident RAM and 1GB of the optional

5.Troubleshooting

No.	Type	Error Name/Error Condition/Major Cause/Solution
		RAM.
		-
		-
	[0402]	Optional Memory 1 Structural Error
		Every time the main power is turned ON, the structure of the optional RAM is checked. If an error is detected at this point, the self-diagnostic module will not check the optional RAM. (The standard RAM is made up of 1GB of resident RAM and 1GB of the optional RAM.)
		-
		Replace the controller board.

No.	Type	Error Name/Error Condition/Major Cause/Solution
SC833-00	D	Self-diagnostic error: Engine I/F ASIC [XXXX]: Detailed error code
	[0F30]	Engine I/F ASIC detection error
		ASIC (Mandolin) for engine control could not be detected.
		ASIC (Mandolin) error
		Replace the Engine I/F board (mother board).
	[50B1]	Video device: clock generator detection error
		Could not initialize or read the bus connection.
		<ul style="list-style-type: none"> Defective connection bus Defective SSCG
		Replace the Engine I/F board (mother board).
	[50B2]	Video device: clock generator verify error
		Value of the SSCG register is incorrect.
		<ul style="list-style-type: none"> Defective connection bus Defective SSCG
		Replace the Engine I/F board (mother board).

No.	Type	Error Name/Error Condition/Major Cause/Solution
SC834-00	D	Self-diagnostic error: Optional memory
	[5101]	Engine I/F optional memory verify error
		An error occurs after write/verify check for optional RAM on the engine I/F board (mother board).
		Defective memory device

No.	Type	Error Name/Error Condition/Major Cause/Solution
		Replace the Engine I/F board (mother board).

No.	Type	Error Name/Error Condition/Major Cause/Solution
SC838-00	C	Self-diagnostic Error: Clock Generator [xxxx]: Detailed error code
		[2701] Verify error
		A verify error occurred when setting data was read from the clock generator via the I2C bus.
		<ul style="list-style-type: none"> • Defective clock generator • Defective I2C bus • Defective I2C port on the CPU
		Replace the controller board.

No.	Type	Error Name/Error Condition/Major Cause/Solution
SC840-00	D	EEPROM access error
		<ul style="list-style-type: none"> • During the I/O processing, a reading error occurred. The 3rd reading failure causes this SC code. • During the I/O processing, a writing error occurred.
		<ul style="list-style-type: none"> • Defective EEPROM
		-

No.	Type	Error Name/Error Condition/Major Cause/Solution
SC841-00	D	EEPROM read data error
		Mirrored data of the EEPROM is different from the original data in EEPROM.
		Data in the EEPROM is overwritten for some reason.
		-

No.	Type	Error Name/Error Condition/Major Cause/Solution
SC842-00	C	Nand-Flash updating verification error
		SCS write error (verify error) occurred at the Nand-Flash module when remote ROM or main ROM was updated.
		Nand-Flash defective
		Turn the main power OFF/ON.

No.	Type	Error Name/Error Condition/Major Cause/Solution
SC842-01	C	Insufficient Nand-Flash blocks (threshold exceeded)
		At startup, or when machine returned from low power mode, the Nand-Flash status

5.Troubleshooting

No.	Type	Error Name/Error Condition/Major Cause/Solution
		was read and judged that the number of unusable blocks had exceeded threshold, and then SCS generated the SC code.
		Number of unusable blocks exceeded threshold for Nand-Flash
		Replace the controller board.

No.	Type	Error Name/Error Condition/Major Cause/Solution
SC842-02	C	Number of Nand-Flash block deletions exceeded
		At startup, or when the machined returned from low power mode, the Nand-Flash was read and judged that the number of deleted blocks had exceeded threshold, and then SCS generated this SC code.
		Number of blocks deleted exceeded threshold for Nand-Flash
		Replace the controller board.

SC No.	Type	Error Name/Error Condition/Major Cause/Solution
SC843-02	B	eMMC rewrite frequency exceeded the threshold (Smart Operation Panel)
		At startup, or when the machined returned from energy saving mode, the eMMC was read and judged that the number of rewrote blocks had exceeded the threshold.
		Number of blocks rewrote exceeded threshold for eMMC
		Replace the Smart Operation Panel.

No.	Type	Error Name/Error Condition/Major Cause/Solution
SC845		Hardware Error Detected when the automatic firmware update
SC845-01	D	Engine Board
SC845-02	D	Controller Board
SC845-03	D	Operation Panel (Normal)
SC845-04	D	Operation Panel (Smart Panel)
SC845-05	D	FCU
		When updating the firmware automatically (ARFU), the firmware cannot be read or written normally, and the firmware update cannot be completed even by 3 retries.
		Hardware abnormality of the target board
		Replacing the target board

No.	Type	Error Name/Error Condition/Major Cause/Solution
		For SC852-02, HDD and memory may cause the problem. Replace the HDD or memory if the SC cannot be recovered by replacing the controller board.

No.	Type	Error Name/Error Condition/Major Cause/Solution
SC845-50	D	DMM or hard disk failure
		This SC occurs if auto firmware decompression fails after downloading the package firmware during auto firmware update or receiving reservation setting in SFU. The machine operates normally if you turn the main power off and then back on, but the SC occurs again when firmware decompression fails again during the next auto firmware update.
		Hardware failure (DIMM or hard disk failure) or the package file released via the global server (SERES) is corrupt.
		Replace the DIMM on the controller board. If the problem persists after replacing the DIMM, replace the hard disk.

No.	Type	Error Name/Error Condition/Major Cause/Solution
SC845-51	D	Network, DIMM or hard disk failure
		This SC occurs if auto firmware decompression fails after downloading the package firmware during auto firmware update, update from the application site, or receiving reservation setting in SFU.
		Failure in the customer's network or hardware (DIMM or hard disk) failure.
		<ol style="list-style-type: none"> <u>1.</u> This may be recovered by retrying the firmware update. <u>2.</u> If the problem persists, replace the DIMM on the controller board. <u>3.</u> If the problem persists after replacing the DIMM, replace the hard disk.

No.	Type	Error Name/Error Condition/Major Cause/Solution
SC851-00	B	IEEE 1394 I /F error
		IEEE 1394 I/F cannot be used due to a driver error.
		<ul style="list-style-type: none"> • HY, LINK Module malfunction • PCI Interface malfunction
		<ol style="list-style-type: none"> <u>1.</u> Confirm the IEEE 1394 connection. <u>2.</u> Replace the IEEE 1394 interface board. <u>3.</u> Replace the controller board.

5.Troubleshooting

No.	Type	Error Name/Error Condition/Major Cause/Solution
SC855-01	B	Wireless LAN board error (driver attachment failure)
		Wireless LAN board error (wireless LAN card: 802.11 is covered)
		<ul style="list-style-type: none"> Defective wireless LAN board Loose connection
		<ol style="list-style-type: none"> Turn the main power OFF/ON. Replace wireless LAN board

No.	Type	Error Name/Error Condition/Major Cause/Solution
SC855-02	B	Wireless LAN board error (driver initialization failure)
		Wireless LAN board error (wireless LAN card: 802.11 is covered)
		<ul style="list-style-type: none"> Defective wireless LAN board Loose connection
		<ol style="list-style-type: none"> Turn the main power OFF/ON. Replace wireless LAN board

No.	Type	Error Name/Error Condition/Major Cause/Solution
SC857-00	B	USB I/F Error
		The USB interface is unusable because of a driver error.
		USB driver error (There are three causes of USB error: RX error/CRC error/STALL. SC is issued only in the case of STALL.)
		Replace the controller board.

No.	Type	Error Name/Error Condition/Major Cause/Solution
SC858-00	A	Data encryption conversion error (Key Setting Error)
		A serious error occurred during an attempt to update the encryption key.
		<ul style="list-style-type: none"> USB Flash, other data, corrupted Communication error caused by electrostatic noise Controller board defective
		Replace the controller board.

No.	Type	Error Name/Error Condition/Major Cause/Solution
SC858-01	A	Data encryption conversion error (HDD Key Setting Error)
		A serious error occurred during an attempt to update the encryption key.
		<ul style="list-style-type: none"> USB Flash, other data, corrupted Communication error caused by electrostatic noise Controller board defective
		<ol style="list-style-type: none"> Turn the main power OFF/ON.

No.	Type	Error Name/Error Condition/Major Cause/Solution
		<u>2.</u> If the error persists, replace the controller board.

No.	Type	Error Name/Error Condition/Major Cause/Solution
SC858-02	A	Data encryption conversion error (NVRAM Read/Write Error)
		A serious error occurred after data conversion during an attempt to update the encryption key.
		NVRAM defective
		<u>1.</u> Replace the NVRAM. <u>2.</u> Replace the controller board.

No.	Type	Error Name/Error Condition/Major Cause/Solution
SC858-30	A	Data encryption conversion error (NVRAM Before Replace Error)
		A serious error occurred after data conversion during an attempt to update the encryption key.
		Software error such as conversion parameters being invalid.
		<u>1.</u> Turn the main power OFF/ON. <u>2.</u> If the error persists, replace the controller board.

No.	Type	Error Name/Error Condition/Major Cause/Solution
SC858-31	A	Data encryption conversion error (Other Error)
		A serious error occurred after data conversion during an attempt to update the encryption key.
		Controller board defective
		Replace the controller board.

No.	Type	Error Name/Error Condition/Major Cause/Solution
SC859-00	B	Data encryption conversion HDD conversion error
		When the data encryption key was updated, HDD data was converted, but not correctly. Image displayed at conversion only (this SC is not displayed), but SC is displayed after machine is cycled off/on.
		<ul style="list-style-type: none"> • HDD conversion was set with the data encryption key update function, but the HDD was removed. • Machine lost power during data encryption key update • Electrostatic noise, or an HDD error occurred, during data encryption key update, and data was not encrypted.
		<u>1.</u> Check HDD connection. <u>2.</u> Format the HDD (SP5-832: HDD formatting).

5.Troubleshooting

No.	Type	Error Name/Error Condition/Major Cause/Solution
		3. If there is a problem with the HDD, it has to be replaced.

No.	Type	Error Name/Error Condition/Major Cause/Solution
SC859-01	B	Data encryption conversion HDD conversion error (HDD check error)
		When the data encryption key was updated, HDD data was converted, but not correctly. Image displayed at conversion only (this SC is not displayed), but SC is displayed after machine is cycled off/on.
		<ul style="list-style-type: none"> HDD conversion was set with the data encryption key update function, but the HDD was removed. Machine lost power during data encryption key update Electrostatic noise, or an HDD error occurred, during data encryption key update, and data was not encrypted.
		<ol style="list-style-type: none"> Check HDD connection. Format the HDD (SP5-832: HDD formatting). If there is a problem with the HDD, it has to be replaced.

No.	Type	Error Name/Error Condition/Major Cause/Solution
SC859-02	B	Data encryption conversion HDD conversion error (Power failure during conversion)
		When the data encryption key was updated, HDD data was converted, but not correctly. Image displayed at conversion only (this SC is not displayed), but SC is displayed after machine is cycled off/on.
		Details: NVRAM/HDD conversion is incomplete.
		Power failure occurred during encryption key update.
		None
		The display after restart instructs the user to format the HDD.

No.	Type	Error Name/Error Condition/Major Cause/Solution
SC859-10	B	Data encryption conversion HDD conversion error (Data read/write command error)
		When the data encryption key was updated, HDD data was converted, but not correctly. Image displayed at conversion only (this SC is not displayed), but SC is displayed after machine is cycled off/on. Details: Abnormal DMAC return value has been received two or more times (DMAC timeout, serial communication error etc.)

No.	Type	Error Name/Error Condition/Major Cause/Solution
		HDD was not successfully converted during encryption key update due to HDD errors or cable noises.
		<ol style="list-style-type: none"> 1. Check HDD connection. 2. Format the HDD (SP5-832: HDD formatting). 3. If there is a problem with the HDD, it has to be replaced.

No.	Type	Error Name/Error Condition/Major Cause/Solution
SC860-00	B	HDD startup error at main power on (HDD error)
		<ul style="list-style-type: none"> • The HDD is connected but the driver detected the following errors. • SS_NO.T_READY:/* (-2)HDD does not become READY*/ • SS_BAD_LABEL:/* (-4)Wrong partition type*/ • SS_READ_ERROR:/* (-5)Error occurred while reading or checking the label*/ • SS_WRITE_ERROR:/* (-6)Error occurred while writing or checking the label*/ • SS_FS_ERROR:/* (-7)Failed to repair the filesystem*/ • SS_MOUNT_ERROR:/* (-8)Failed to mount the filesystem*/ • SS_COMMAND_ERROR:/* (-9)Drive not responding to command*/ • SS_KERNEL_ERROR:/* (-10)Internal kernel error*/ • SS_SIZE_ERROR:/* (-11)Drive size too small*/ • SS_NO._PARTITION:/* (-12)The specified partition does not exist*/ • SS_NO._FILE:/* (-13)Device file does not exist*/ • Attempted to acquire HDD status through the driver but there has been no response for 30 seconds or more.
		<ul style="list-style-type: none"> • Unformatted HDD • Label data corrupted • HDD defective
		Format the HDD (SP5-832: HDD formatting) through SP mode.

No.	Type	Error Name/Error Condition/Major Cause/Solution
SC860-01	B	HDD file system error at main power on (HDD error)
		Failed to mount any of the hard disk partitions.
		Power failed while writing files to the hard disk. The machine shut down while writing files to the hard disk.
		Be sure to back up the address book and retrieve the log before formatting the hard disk. 1. Turn the main power OFF/ON.

5. Troubleshooting

No.	Type	Error Name/Error Condition/Major Cause/Solution
		<p>It may take a while to shut down because of the hard disk failure.</p> <p>2. Format the HDD (SP5-832: HDD formatting) through SP mode.</p> <p>3. If there is a problem with the HDD, it has to be replaced.</p>

No.	Type	Error Name/Error Condition/Major Cause/Solution
SC860-02	B	HDD label error at main power on (HDD error)
		Hard disk partition data abnormal.
		Power failed while writing files to the hard disk.
		The machine shut down while writing files to the hard disk.
		<p>Be sure to back up the address book and retrieve the log before formatting the hard disk.</p> <p>1. Turn the main power OFF/ON.</p> <p>It may take a while to shut down because of the hard disk failure.</p> <p>2. Format the HDD (SP5-832: HDD formatting) through SP mode.</p> <p>3. If there is a problem with the HDD, it has to be replaced.</p>

No.	Type	Error Name/Error Condition/Major Cause/Solution
SC860-03	B	HDD encryption key error at main power on (HDD error)
		The encryption key for reading the encrypted hard disk data has failed.
		The controller's ROM (NAND) and NVRAM are both damaged. (Rare)
		<p>Be sure to back up the address book and retrieve the log before formatting the hard disk.</p> <p>1. Turn the main power OFF/ON.</p> <p>It may take a while to shut down because of the hard disk failure.</p> <p>2. Format the HDD (SP5-832: HDD formatting) through SP mode.</p> <p>3. If there is a problem with the HDD, it has to be replaced.</p>

No.	Type	Error Name/Error Condition/Major Cause/Solution
SC861-00	D	HDD re-try failure
		At power on, the HDD is detected. Power supply to the HDD is interrupted after the system has entered the energy saving mode, but after the HDD has been awakened from the energy saving mode, it does not return to the ready status

No.	Type	Error Name/Error Condition/Major Cause/Solution
		within 30 sec.
		<ul style="list-style-type: none"> • Harness between HDD and controller board disconnected, defective • HDD power connector disconnected • HDD defective • Controller board defective
		If the hard disk cannot be detected by turning on the main power again, replace the HDD or controller board.

No.	Type	Error Name/Error Condition/Major Cause/Solution
SC862-00	D	Number of the defective sector reaches the maximum count
		101 defective sectors are generated at the image storage area in the HDD.
		SC863 occurs during the HDD reading and defective sectors are registered up to 101.
		<ol style="list-style-type: none"> <u>1.</u> Format the HDD with SPSP5-832. <u>2.</u> Replace the HDD (PCB12).

No.	Type	Error Name/Error Condition/Major Cause/Solution
SC863-01	D	HDD data read failure
		The data written to the HDD cannot be read normally.
		Bad sectors were generated during operation. (An error occurred in an area that does not belong to a partition, such as the disk label area.)
		<p>Guide for when to replace the HDD</p> <ol style="list-style-type: none"> <u>1.</u> When SC863 has occurred ten times or more <ul style="list-style-type: none"> • The interval is short. • Repeatedly occurs in the same situation (At power-on, etc.). • Startup takes a long time when the main power is turned on. <u>2.</u> It takes a long time after main power on for the operation panel to become ready. HDD access may be consuming time. Normal HDD access time after main power on is about 5 seconds. If the machine is not waiting for the engine to be ready and it still takes 20 to 30 seconds or more, the HDD may be the cause. If there is a problem with the HDD, HDD-related SCs such as SC860 and SC863 will occur frequently. Print the SC log data and check them.

5.Troubleshooting

No.	Type	Error Name/Error Condition/Major Cause/Solution
SC863-02 to 23	D	HDD data read failure
		The data written to the HDD cannot be read normally.
		Bad sectors were generated during operation. (An error occurred in partition "a" (SC863-02) to partition "v" (SC863-23)).
		<p>Guide for when to replace the HDD</p> <p>1. When SC863 has occurred ten times or more</p> <ul style="list-style-type: none"> • The interval is short. • Repeatedly occurs in the same situation (At power-on, etc.). • Startup takes a long time when the main power is turned on. <p>2. It takes a long time after main power on for the operation panel to become ready.</p> <p>HDD access may be consuming time. Normal HDD access time after main power on is about 5 seconds. If the machine is not waiting for the engine to be ready and it still takes 20 to 30 seconds or more, the HDD may be the cause. If there is a problem with the HDD, HDD-related SCs such as SC860 and SC863 will occur frequently. Print the SC log data and check them.</p>

No.	Type	Error Name/Error Condition/Major Cause/Solution
SC864-00	D	HD data CRC error
		During HD operation, the HD cannot respond to a CRC error query. Data transfer did not execute normally while data was being written to the HD.
		HD defective
		-

No.	Type	Error Name/Error Condition/Major Cause/Solution
SC864-01	D	HDD data CRC error
		During HDD operation, the HDD cannot respond to a CRC error query. Data transfer did not execute normally while data was being written to the HDD.
		Bad sectors were generated during operation. (An error occurred in an area that does not belong to a partition, such as the disk label area.)
		<p>1. Format the HDD.</p> <p>2. Replace the HDD (PCB12).</p>

No.	Type	Error Name/Error Condition/Major Cause/Solution
SC864-02 to 23	D	HDD data CRC error
		During HDD operation, the HDD cannot respond to a CRC error query. Data

No.	Type	Error Name/Error Condition/Major Cause/Solution
		transfer did not execute normally while data was being written to the HDD.
		Bad sectors were generated during operation. (An error occurred in partition "a" (SC864-02) to partition "v" (SC864-23)).
		1. Format the HDD. 2. Replace the HDD (PCB12).

No.	Type	Error Name/Error Condition/Major Cause/Solution
SC865-00	D	HD access error
		During HDD operation, the HDD returned an error.
		The HDD returned an error that does not constitute SC863 (bad sector) or SC864 (CRC error).
		Replace the HDD (PCB12).

No.	Type	Error Name/Error Condition/Major Cause/Solution
SC865-01	D	HDD access error
		During HDD operation, the HDD returned an error.
		The HDD returned an error that does not constitute SC863 (bad sector) or SC864 (CRC error). (An error occurred in an area that does not belong to a partition, such as the disk label area.)
		Replace the HDD (PCB12).

No.	Type	Error Name/Error Condition/Major Cause/Solution
SC865-02 to 23	D	HDD access error
		During HDD operation, the HDD returned an error.
		The HDD returned an error that does not constitute SC863 (bad sector) or SC864 (CRC error). (An error occurred in partition "a" (SC865-02) to partition "v" (SC865-23)).
		Replace the HDD (PCB12).

No.	Type	Error Name/Error Condition/Major Cause/Solution
SC865-50 to 73	D	HDD time-out error
		The machine does not detect a reply from the HDD during the HDD operation.
		The HDD does not respond to the read/ write command from the machine.
		1. Check the harness connections between the controller board and HDD. 2. Replace the HDD (PCB12).

5.Troubleshooting

No.	Type	Error Name/Error Condition/Major Cause/Solution
SC866-00	B	SD card authentication error
		A license error of an application that is started from the SD card was detected.
		Invalid program data is stored on the SD card.
		Store a valid program data on the SD card.

No.	Type	Error Name/Error Condition/Major Cause/Solution
SC867-00	C	SD card removed
		The SD card was removed while the machine is on.
		An application SD card has been removed from the slot (mount point of /mnt/sd0).
		Turn the main power OFF/ON.

No.	Type	Error Name/Error Condition/Major Cause/Solution
SC867-01	C	SD card removed
		The SD card was removed while the machine is on.
		An application SD card has been removed from the slot (mount point of /mnt/sd1).
		Turn the main power OFF/ON.

No.	Type	Error Name/Error Condition/Major Cause/Solution
SC867-02	C	SD card removed
		The SD card was removed while the machine is on.
		An application SD card has been removed from the slot (mount point of /mnt/sd2).
		Turn the main power OFF/ON.

No.	Type	Error Name/Error Condition/Major Cause/Solution
SC868-**		SD card access error
SC868-00	D	The SD controller returned an error during operation. (An error occurred at the mount point of /mnt/sd0)
SC868-01	D	The SD controller returned an error during operation. (An error occurred at the mount point of /mnt/sd1)
		<ul style="list-style-type: none"> • SD card defective • SD controller defective
		Slot number is displayed on the sub code. Detail code is described in SMC print can confirm the details of the error.

No.	Type	Error Name/Error Condition/Major Cause/Solution
		<ul style="list-style-type: none"> -13 to -3: File system check error Otherwise (no code, -2) : Device access error
		<p>SD card that starts an application</p> <ol style="list-style-type: none"> Turn the main power off and check the SD card insertion status. If no problem is found, insert the SD card and turn the main power on. If an error occurs, replace the SD card. If the error persists even after replacing the SD card, replace the controller board. <p>SD card for users</p> <ol style="list-style-type: none"> In case of a file system error, reformat the SD card (using the "SD Formatter" made by Panasonic).* <p>In case of a device access error</p> <ol style="list-style-type: none"> Turn the main power off and check the SD card insertion status. If no problem is found, insert the SD card and turn the main power on. If an error occurs, use another SD card. If the error persists even after replacing the SD card, replace the controller board (PCB11).

* Do not format an SD card supplied with the main machine or sold as an option. You may only format SD cards used for Firmware Update by a Service Technician.

No.	Type	Error Name/Error Condition/Major Cause/Solution
SC869- **		Malfunction of the proximity sensor is detected
SC869- 01	C	Continuously detecting malfunction
		The proximity sensor keeps in a detection state and accumulated time exceeds 24 hours.
		The proximity sensor is disabled and is in the detection state at all times.
SC869- 02	C	Continuously non-detecting malfunction
		<p>In the non-detection state, the following operations are detected 20 times continuously.</p> <ul style="list-style-type: none"> Pressing "energy saving" button, or touching the operation panel Opening/closing the plate cover or ADF Setting the original Opening the front cover Opening the paper feed tray

5.Troubleshooting

No.	Type	Error Name/Error Condition/Major Cause/Solution
		The proximity sensor is disabled and is in the non-detection state at all times.
		<ol style="list-style-type: none"> 1. Go to the SP5-102-203 (input check SP for the proximity sensor). 2. Cover the sensor with 10 sheets of plain paper, and then execute the SP. Make sure that it becomes "0". (Do not place your hand near the sensor, even over the paper, when covering the sensor) 3. Remove the paper from the sensor and make sure that it becomes "1". 4. If the sensor reacts normally in step 2 and 3, check if there are any other possible factors around the machine that may cause the temperature change such as a heater or a fan. (Deal with the issue as necessary) 5. Replace the proximity sensors (S49) and proximity sensor board (PCB18) if an abnormal value is detected during steps 2 and 3. 6. Turn on the main power on and perform steps 1, 2, and 3 again. 7. If the SC is not solved, turn the main power off and replace the harness which connects the proximity sensors and the proximity sensor board. 8. If the SC is still not solved, there is a possibility that other parts of the machine such as the connector at the controller side or the harness between proximity sensor board and BICU are broken.

No.	Type	Error Name/Error Condition/Major Cause/Solution
SC870-00	B	Address Book data error (Anytime: Address Book Error.)
SC870-01	B	Address Book data error (On startup: Media required for storing the Address Book is missing.)
SC870-02	B	Address Book data error (On startup: encryption is configured but the module required for encryption (DESS) is missing.)
SC870-03	B	Address Book data error (Initialization: Failed to generate a file to store internal Address Book.)
SC870-04	B	Address Book data error (Initialization: Failed to generate a file to store delivery sender.)
SC870-05	B	Address Book data error (Initialization: Failed to generate a file to store delivery destination.)
SC870-06	B	Address Book data error (Initialization: Failed to generate a file to store information required for LDAP search.)
SC870-07	B	Address Book data error (Initialization: Failed to initialize entries required for machine operation.)
SC870-08	B	Address Book data error (Machine configuration: HDD is present but the space for storing the Address Book is unusable.)

No.	Type	Error Name/Error Condition/Major Cause/Solution
SC870-09	B	Address Book data error (Machine configuration: Inconsistency in the NVRAM area used for storing settings required for Address Book configuration.)
SC870-10	B	Address Book data error (Machine configuration: Cannot make a directory for storing the Address Book in the SD/USB FlashROM.)
SC870-11	B	Address Book data error (On startup: Inconsistency in Address Book entry number.)
SC870-20	B	Address Book data error (File I/O: Failed to initialize file.)
SC870-21	B	Address Book data error (File I/O: Failed to generate file.)
SC870-22	B	Address Book data error (File I/O: Failed to open file.)
SC870-23	B	Address Book data error (File I/O: Failed to write to file.)
SC870-24	B	Address Book data error (File I/O: Failed to read file.)
SC870-25	B	Address Book data error (File I/O: Failed to check file size.)
SC870-26	B	Address Book data error (File I/O: Failed to delete data.)
SC870-27	B	Address Book data error (File I/O: Failed to add data.)
SC870-30	B	Address Book data error (Search: Failed to obtain data from cache when searching in the machine Address Book. delivery destination/sender.)
SC870-31	B	Address Book data error (Search: Failed to obtain data from cache during LDAP search.)
SC870-32	B	Address Book data error (Search: Failed to obtain data from cache while searching the WS-Scanner Address Book.)
SC870-41	B	Address Book data error (Cache: failed to obtain data from cache.)
SC870-50	B	Address Book data error (On startup: Detected abnormality of the Address Book encryption status.)
SC870-51	B	Address Book data error (Encryption settings: Failed to create directory required for conversion between plaintext and encrypted text.)
SC870-52	B	Address Book data error (Encryption settings: Failed to convert from plaintext to encrypted text.)
SC870-	B	Address Book data error (Encryption settings: Failed to convert from encrypted text

5.Troubleshooting

No.	Type	Error Name/Error Condition/Major Cause/Solution
53		to plaintext.)
SC870-54	B	Address Book data error (Encryption settings: Detected data inconsistency when reading the encrypted Address Book.)
SC870-55	B	Address Book data error (Encryption settings: Failed to delete file when changing encryption setting.)
SC870-56	B	Address Book data error (Encryption settings: Failed to erase the file that records the encryption key during an attempt to change the encryption setting.)
SC870-57	B	Address Book data error (Encryption settings: Failed to move a file during an attempt to change the encryption setting.)
SC870-58	B	Address Book data error (Encryption settings: Failed to delete a directory during an attempt to change the encryption setting.)
SC870-59	B	Address Book data error (Encryption settings: Detected a resource shortage during an attempt to change the encryption setting.)
SC870-60	B	Address Book data error (Unable to obtain the on/off setting for administrator authentication (06A and later).)
		<p>When an error related to the Address Book is detected during startup or operation.</p> <ul style="list-style-type: none"> • Software bug • Inconsistency of Address Book source location (machine/delivery server/LDAP server) • Inconsistency of Address Book encryption setting or encryption key (NVRAM or HDD was replaced individually without formatting the Address Book) • Address Book storage device (SD/HDD) was temporarily removed or hardware configuration does not match the application configuration. • Address Book data corruption was detected. <p>Install the device that contains address book information properly, and turn the main power off/on. If SC occurs again, do the following steps.</p> <ol style="list-style-type: none"> 1. After installing the HDD, or SD/USB ROM, execute SP5-846-046 (UCS Setting). 2. Wait more than 3 seconds, then execute SP5-832 (HDD Formatting). 3. Turn the main power OFF/ON. <p>Procedure after SC870 is cleared</p> <ol style="list-style-type: none"> 1. If there is backup data in SD card or Web Image Monitor, restore the address book data. (To restore from SD card, enter the encryption password which is the same as when you enter to backup.)

No.	Type	Error Name/Error Condition/Major Cause/Solution
SC871-01	D	FCU error

No.	Type	Error Name/Error Condition/Major Cause/Solution
		An error occurred when FCS detects FCU defective.
		<ul style="list-style-type: none"> • Time-out error • Abnormal Parameter
		<ol style="list-style-type: none"> 1. Turn the main power OFF/ON. 2. Update the firmware if more recent firmware was released.

No.	Type	Error Name/Error Condition/Major Cause/Solution
SC871-02	D	FCU job error (Recovery possible)
		This SC occurs when the FCU has detected a job error (failure to start or complete a job) that may be recovered by auto reboot.
		-
		<ol style="list-style-type: none"> 1. Turn the main power OFF/ON. 2. Update the firmware if more recent firmware was released.

No.	Type	Error Name/Error Condition/Major Cause/Solution
SC871-03	D	FCU job error (Recovery not possible)
		This SC occurs when the FCU has detected a job error (failure to start or complete a job) that will not be recovered by auto reboot.
		-
		<ol style="list-style-type: none"> 1. Turn the main power OFF/ON. 2. Update the firmware if more recent firmware was released.

No.	Type	Error Name/Error Condition/Major Cause/Solution
SC872-00	B	HDD mail reception error
		An error was detected on the HDD immediately after the machine was turned on.
		<ul style="list-style-type: none"> • HDD defective • Power was turned off while the machine used the HDD.
		<ol style="list-style-type: none"> 1. Format the HDD (SP5-832-007: HDD Formatting: Mail RX Data.). 2. Replace the HDD (PCB12).
		When you do the above, the following information will be initialized.
		<ol style="list-style-type: none"> 1. Partly received partial mail messages. 2. Already-read statuses of POP3-received messages (All messages on the mail server are handled as new messages).

No.	Type	Error Name/Error Condition/Major Cause/Solution
SC873-00	B	HDD mail reception error

5.Troubleshooting

No.	Type	Error Name/Error Condition/Major Cause/Solution
		An error was detected on the HDD immediately after the machine was turned on.
		<ul style="list-style-type: none"> • HDD defective • Power was turned off while the machine used the HDD.
		<ol style="list-style-type: none"> 1. Format the HDD (SP5-832-007 : HDD Formatting: Mail RX Data). 2. Replace the HDD (PCB12). <p>When you do the above, the following information will be initialized.</p> <ol style="list-style-type: none"> 1. Sender's mail text 2. Default sender name/password (SMB/FTP/NCP) 3. Administrator mail address 4. Scanner delivery history

No.	Type	Error Name/Error Condition/Major Cause/Solution
SC874-05	D	Delete all error (Delete data area) : Read error
SC874-06	D	Delete all error (Delete data area) : Write error
SC874-09	D	Delete all error (Delete data area) : No response from HDD
SC874-10	D	Delete all error (Delete data area) : Error in Kernel
SC874-12	D	Delete all error (Delete data area) : No designated partition
SC874-13	D	Delete all error (Delete data area) : No device file
SC874-14	D	Delete all error (Delete data area) : Start option error
SC874-15	D	Delete all error (Delete data area) : No designated sector number
SC874-16	D	Delete all error (Delete data area) : failure in performing HDD erase
SC874-41	D	Delete all error (Delete data area) : Other fatal errors
SC874-42	D	Delete all error (Delete data area) : End by cancellation
SC874-61 to -65	D	Delete all error (Delete data area) : library error
SC874-66	D	Delete all error (Delete data area) : Unavailable
SC874-67	D	Delete all error (Delete data area) : Erasing not finished
SC874-68	D	Delete all error (Delete data area) : HDD format failure (Normal)
SC874-69	D	Delete all error (Delete data area) : HDD format failure (Abnormal)
SC874-70	D	Delete all error (Delete data area) : Unauthorized library
SC874-99	D	Delete all error (Delete data area) : other errors
		An error occurred while data was being erased on HDD or NVRAM.
		<ul style="list-style-type: none"> • Error detected in HDD data delete program • Error detected in NVRAM data delete program • The "Delete All" option was not set
		<ul style="list-style-type: none"> • Turn the main power switch off and back on, and then execute "Erase All Memory" under UP mode again. (However, if there is a defective sector or

No.	Type	Error Name/Error Condition/Major Cause/Solution
		<p>other problem with the hard disk, the error will persist even after trying the above.)</p> <ul style="list-style-type: none"> If the "Delete All" option is not installed when this error occurs, install the option.

No.	Type	Error Name/Error Condition/Major Cause/Solution
SC875-01	D	Delete all error (HDD erasure) (hddchack -i error)
SC875-02	D	Delete all error (HDD erasure) (Data deletion failure)
		<p>An error was detected before HDD/data erasure starts. (Failed to erase data/failed to logically format HDD)</p> <ul style="list-style-type: none"> HDD logical formatting failed. The modules failed to erase data. <p>Turn the main power OFF/ON.</p>

No.	Type	Error Name/Error Condition/Major Cause/Solution
SC876-00	D	<p>Log Data Error</p> <p>An error was detected in the handling of the log data at power on or during machine operation.</p> <ul style="list-style-type: none"> Damaged log data file. Log encryption is enabled but encryption module is not installed. Inconsistency of encryption key between NV-RAM and HDD. Software bug. <p>Try the SC876-01 to -99 solutions listed below. If it is not solved, do the following steps (for when only an HDD is replaced):</p> <ol style="list-style-type: none"> 1. Disconnect the HDD and turn ON the main power. 2. Execute SP5-801-019 (Memory Clear: LCS Memory Clr) to Initialize the LCS settings. 3. Turn OFF the main power. 4. Connect the HDD and turn ON the main power. 5. Execute SP5-832-004 (HDD Formatting (Job Log)). 6. Turn OFF the main power. <p>* The following step is to configure the logging/encryption setting again.</p> <ol style="list-style-type: none"> 7. Turn ON the main power.

5.Troubleshooting

No.	Type	Error Name/Error Condition/Major Cause/Solution
SC876-01	D	Log Data Error 1
		An error was detected in the handling of the log data at power on or during machine operation.
		Damaged log data file
		Initialize the HDD (SP5-832-004).

No.	Type	Error Name/Error Condition/Major Cause/Solution
SC876-02	D	Log Data Error 2
		An error was detected in the handling of the log data at power on or during machine operation.
		Log encryption is enabled but encryption module is not installed.
		<ol style="list-style-type: none"> 1. Replace or set again the encryption module. 2. Disable the log encryption setting.

No.	Type	Error Name/Error Condition/Major Cause/Solution
SC876-03	D	Log Data Error 3
		An error was detected in the handling of the log data at power on or during machine operation.
		Inconsistency of encryption key between NV-RAM and HDD.
		<ol style="list-style-type: none"> 1. Disable the log encryption setting. 2. Initialize LCS memory (SP5801-019). 3. Initialize the HDD (SP5-832-004).

No.	Type	Error Name/Error Condition/Major Cause/Solution
SC876-04	D	Log Data Error 4
		An error was detected in the handling of the log data at power on or during machine operation.
		<ul style="list-style-type: none"> • Log encryption key is disabled but the log data file is encrypted. (NVRAM data corruption) • Log encryption key is enabled but the log data file is not encrypted. (NVRAM data corruption)
		Initialize the HDD (SP5-832-004).

No.	Type	Error Name/Error Condition/Major Cause/Solution
SC876-05	D	Log Data Error 5
		An error was detected in the handling of the log data at power on or during machine operation.

No.	Type	Error Name/Error Condition/Major Cause/Solution
		<ul style="list-style-type: none"> Only the NV-RAM has been replaced with one previously used in another machine. Only the HDD has been replaced with one previously used in another machine.
		<ol style="list-style-type: none"> Attach the original NV-RAM. Attach the original HDD. With the configuration that caused the SC, initialize the HDD (SP5-832-004).

No.	Type	Error Name/Error Condition/Major Cause/Solution
SC876-99	D	Log Data Error 99
		An error was detected in the handling of the log data at power on or during machine operation.
		Other causes
		-

No.	Type	Error Name/Error Condition/Major Cause/Solution
SC877-00	B	Data Overwrite Security card error
		The "Auto Erase Memory" function of the Data Overwrite Security is set to on but it cannot be done.
		<ul style="list-style-type: none"> Data Overwrite Security option SD card is broken. Data Overwrite Security option SD card has been removed.
		<ul style="list-style-type: none"> If the SD card is broken, prepare a new Data Overwrite Security option SD card and replace the NVRAM. If the SD card has been removed, turn the main power off and reinstall a working Data Overwrite Security option SD card.

No.	Type	Error Name/Error Condition/Major Cause/Solution
SC878-00	D	TPM authentication error
		TPM electronic recognition failure
		<ul style="list-style-type: none"> Update of system module attempted without correct update path USB flash memory not operating correctly
		Replace the controller board (PCB11).

Trusted Platform Module

- In computing, Trusted Platform Module (TPM) is both the name of a published specification detailing a secure crypto processor that can store cryptographic keys that protect information, as well as the general name of implementations of that specification often called the "TPM chip" or "TPM Security Device" (as designated in certain Dell BIOS settings).

5.Troubleshooting

No.	Type	Error Name/Error Condition/Major Cause/Solution
SC878-01	D	USB flash error
		There is a problem in the file system of the USB flash memory.
		USB Flash system files corrupted
		Replace the controller board (PCB11).

No.	Type	Error Name/Error Condition/Major Cause/Solution
SC878-02	D	TPM error
		An error occurred in either TPM or the TPM driver
		TPM not operating correctly
		Replace the controller board (PCB11).

No.	Type	Error Name/Error Condition/Major Cause/Solution
SC878-03	D	TCSD error
		An error occurred in the TPM software stack.
		<ul style="list-style-type: none"> • TPM, TPM software cannot start • A file required by TPM is missing
		Replace the controller board (PCB11).

SC No.	Type	Error Name/Error Condition/Major Cause/Solution
SC878-20	D	DESS self-test error
		The power-on self-test for TPM failed at startup when the controller encryption software was tested.
		TPM is defective
		<ol style="list-style-type: none"> 1. Cycle the power off/on. 2. Replace the controller board.

SC No.	Type	Error Name/Error Condition/Major Cause/Solution
SC878-21	D	Random Number Generator Error
		An error occurred when doing self-check against seed for random number generated.
		TPM is defective
		<ol style="list-style-type: none"> 1. Cycle the power off/on. 2. Replace the controller board.

No.	Type	Error Name/Error Condition/Major Cause/Solution
SC880-00	D	MLB error
		Reply to MLB access was not returned within a specified time.

No.	Type	Error Name/Error Condition/Major Cause/Solution
		MLB defective
		<ol style="list-style-type: none"> 1. Replace the MLB. 2. Remove the MLB.

No.	Type	Error Name/Error Condition/Major Cause/Solution
SC882-00	A	Smart Operation Panel software verification error
		Smart Operation Panel verification was executed and an invalid result returned.
		<ul style="list-style-type: none"> • The Smart Operation Panel software has corrupted the memory. • An unauthorized application has been installed on Smart Operation Panel.
		<ul style="list-style-type: none"> • Reinitialize Smart Operation Panel or rewrite the firmware.

No.	Type	Error Name/Error Condition/Major Cause/Solution
SC890-01	A	PaaS* function: Tampering detection
		PaaS data in NVRAM and on USB flash drive do not match at startup.
		-
		Activate PaaS => Install => After successful installation, reboot. Notes on application: Before attempting recovery, check whether the device is registered to PaaS-PF. If it is, cancel the registration. The SC is resolved by rebooting after successful installation.

No.	Type	Error Name/Error Condition/Major Cause/Solution
SC890-02	A	PaaS function: Suspended
		This SC occurs when the PaaS function is suspended because of an internal or external factor (receiving a request from PaaS-PF to suspend).
		- The warning dialog box displayed when this SC occurs contains instructions. Follow the instructions to solve the problem.

* PaaS stands for "Printer as a Service". It is a remote service like the @remote service.

No.	Type	Error Name/Error Condition/Major Cause/Solution
SC899-00	D	Software performance error (signal reception end)
		Unknown software error occurred.
		Occurs when an internal program behaves abnormally.
		In the case of a hardware defect <ul style="list-style-type: none"> • Replace the hardware. In the case of a software error

5.Troubleshooting

No.	Type	Error Name/Error Condition/Major Cause/Solution
		<ul style="list-style-type: none">• Turn the main power OFF/ON.• Try updating the firmware.

SC900

SC900 (Engine: Others)

SC No.	Type	Error Name/Error Condition/Major Cause/Solution
SC940-01	D	Toner supply motor (K) defective
SC940-02	D	Toner supply motor (C) defective
SC940-03	D	Toner supply motor (M) defective
SC940-04	D	Toner supply motor (Y) defective
		Toner supply motor connector missing, disconnection Toner supply motor harness get caught. Toner supply motor malfunction, or the driver of the toner supply motor is defective.
		<ul style="list-style-type: none"> • Reconnect the connectors. • Replace the imaging IOB (PCB2).

SC No.	Type	Error Name/Error Condition/Major Cause/Solution
SC940-50	C	Key counter device defective
		When the key counter is ON, the value of the register of the key counter set detection signal is zero three times in a row.
		The driver of the key counter device is defective.
		Replace the BICU, the imaging IOB (PCB2), or the paper transport IOB (PCB1).

SC No.	Type	Error Name/Error Condition/Major Cause/Solution
SC940-81	D	Load SW1: Overcurrent detection
		The load SW has detected and limited overcurrent.
		<ul style="list-style-type: none"> • Short circuit on the BICU board. • Short circuit in the TM/ID sensor • Short circuit on the synchronizing detector board • Short circuit in the harness connected to the TM/ID sensor or synchronizing detector board
		1. Turn the main power switch OFF, and disconnect the CN106 and CN587 connectors on BICU. Then turn the main power ON again.

5.Troubleshooting

		<p>If started normally:</p> <p>The 3.3V L of an item (harness or electrical component) connected to one of the abovementioned connectors may be short-circuited. To determine which component has failed, press the connectors one at a time and then turn the power off and then back on. Then replace the harness or failed component.</p> <p>If SC-940-81 occurs repeatedly:</p> <p>Replace the BICU.</p>
--	--	--

SC No.	Type	Error Name/Error Condition/Major Cause/Solution
SC940-82	D	Load SW2: Overcurrent detection
		The load SW has detected and limited overcurrent.
		<p>Short-circuit of the following units:</p> <ul style="list-style-type: none"> • Paper Transport IOB (PCB1) • Paper exit/Pressure release motor (M4) or its harness • Transport motor (M5) or its harness • Paper feed motor (M6) or its harness • Registration motor (M7) or its harness • Paper feed sensor (2nd Feed Tray) (S22) or its harness • Transport sensor (2nd Feed Tray) (S23) or its harness • Paper end sensor (2nd feed tray) (S24) or its harness • Upper Limit sensor (2nd feed tray) (S25) or its harness • Paper feed sensor (1st Feed Tray) (S12) or its harness • Transport sensor (1st Feed Tray) (S13) or its harness • Paper end sensor (1st feed tray) (S14) or its harness • Upper Limit sensor (1st feed tray) (S15) or its harness • PTR open/close LED (LED1) or its harness • Fusing entrance sensor (S1) or its harness • PTR open/close sensor (S2) or its harness • Duplex entrance motor (M1) or its harness • Bypass/duplex motor(M2) or its harness • Duplex entrance sensor (S5) or its harness • Bypass length sensor (S7) or its harness • Reverse sensor (S9) or its harness • Paper exit sensor (S10) or its harness • Paper exit full sensor (S11) or its harness • Pressure roller HP sensor (S26) or its harness
		1. Turn the main power switch OFF, and disconnect the CN177, CN156, CN176,

		<p>CN157, CN158, CN159, CN161, CN162, CN166 connectors on the paper transport IOB (PCB1). Then turn the main power ON again.</p> <p>If started normally:</p> <p>The 5V IO of an item (harness or electrical component) connected to one of the abovementioned connectors may be short-circuited. To determine which component has failed, press the connectors one at a time and then turn the power off and then back on. Then replace the harness or failed component.</p> <p>If SC-940-82 occurs repeatedly:</p> <p>Replace the paper transport IOB (PCB1).</p>
--	--	--

SC No.	Type	Error Name/Error Condition/Major Cause/Solution
SC940-83	D	Load SW3: Overcurrent detection
		The load SW has detected and limited overcurrent.
		<p>Short-circuit of the following units:</p> <ul style="list-style-type: none"> • Imaging IOB (PCB2) • Waste toner bottle full sensor (S34) or its harness • ITB contact and release sensor (S32) or its harness • Toner end sensor (S28)(S29)(S30)(S31) or its harness
		<p>1. Turn the main power switch OFF, and disconnect the CN201, CN205 connectors on the imaging IOB (PCB2). Then turn the main power ON again.</p> <p>If started normally:</p> <p>The 5V IO of an item (harness or electrical component) connected to one of the abovementioned connectors may be short-circuited. To determine which component has failed, press the connectors one at a time and then turn the power off and then back on. Then replace the harness or failed component.</p> <p>If SC-940-83 occurs repeatedly:</p> <p>Replace the imaging IOB (PCB2).</p>

SC No.	Type	Error Name/Error Condition/Major Cause/Solution
SC995-01	D	CPM setting error 1
		<p>Comparison of machine serial number (11 digits) and machine identification code.</p> <p>Details:</p> <ul style="list-style-type: none"> • Machine serial number cannot be identified because of BICU replacement or malfunctioning. • Machine serial number cannot be identified because of NV-RAM replacement
		<p>Machine serial number (11 digits) or machine identification code does not match.</p> <ul style="list-style-type: none"> • Enter the machine serial number using SP5-811(MachineSerial), and then turn the power on/off.

5.Troubleshooting

SC No.	Type	Error Name/Error Condition/Major Cause/Solution
		<ul style="list-style-type: none"> Attach the NV-RAM that was installed previously.

SC No.	Type	Error Name/Error Condition/Major Cause/Solution
SC995-02	D	CPM setting error 2
		Comparison of machine serial number (11 digits) and machine identification code. Details: Machine serial number cannot be identified because of NV-RAM replacement or malfunctioning.
		Machine serial number (11 digits) or machine identification code does not match.
		<ul style="list-style-type: none"> Attach the NV-RAM that was installed previously. Download data on the NV-RAM using SP5-825 (NV-RAM Data Download).

SC No.	Type	Error Name/Error Condition/Major Cause/Solution
SC995-03	D	CPM setting error 3
		Comparison of machine serial number (11 digits) and machine identification code. Details: Unable to recognize machine identification code because the controller was replaced incorrectly or is malfunctioning.
		Machine serial number (11 digits) or machine identification code does not match.
		Replace it with a specified controller.

SC No.	Type	Error Name/Error Condition/Major Cause/Solution
SC995-04	D	CPM setting error 4
		Comparison of machine serial number (11 digits) and machine identification code.
		Machine serial number (11 digits) or machine identification code does not match.
		Return the parts to the original configuration, and then replace them according to the manual.

SC900 (Controller)

SC No.	Type	Error Name/Error Condition/Major Cause/Solution
SC900-00	A	Electric counter error
		The electric total counter value is out of specification. Error is detected when increasing the total counter.
		<ul style="list-style-type: none"> Unexpected NV-RAM is attached. NV-RAM defective NV-RAM data corrupted. Data written to unexpected area because of external factor etc.

SC No.	Type	Error Name/Error Condition/Major Cause/Solution
		<ul style="list-style-type: none"> The count requested by the SRM on receiving PRT is not completed.
		Replace the NV-RAM.

SC No.	Type	Error Name/Error Condition/Major Cause/Solution
SC910-00	B	External controller error 1
		-
		-
		Turn the main power OFF/ON.

SC No.	Type	Error Name/Error Condition/Major Cause/Solution
SC910-01	C	External controller error 1
SC910-02	C	External controller error 2
SC910-03	C	External controller error 3
		-01 The external controller receives the unexpected command from the engine side.
		-02 The external controller wrongly receives the command from the engine side.
		-03 The external controller receives the engine status out of specification.
		Refer to the instructions for the external controller
		Turn the main power OFF/ON.

SC No.	Type	Error Name/Error Condition/Major Cause/Solution
SC910-10	C	External controller error 10
		The external controller error is detected due to other reason shown in SC910-01 to -03.
		Refer to the instructions for the external controller
		Turn the main power OFF/ON.

SC No.	Type	Error Name/Error Condition/Major Cause/Solution
SC911-00	B	External controller error 2
		The external controller alerted the machine about an error.
		Refer to the instructions for the external controller
		Turn the main power off/on.

5.Troubleshooting

SC No.	Type	Error Name/Error Condition/Major Cause/Solution
SC911-06	B	Ethernet TCP/IP: Invalid configuration during enable
		Configuration error involved in the communication with the IPDS host system (only occurs when IPDS is installed on the external controller)
		If rebooting the external controller does not solve the problem, replace the motherboard of the external controller.

SC No.	Type	Error Name/Error Condition/Major Cause/Solution
SC911-10	B	Internal printing: File system error
		File system error of the internal print (such as file corruption)
		If rebooting the external controller does not solve the problem, re-install the system software of the external controller.

SC No.	Type	Error Name/Error Condition/Major Cause/Solution
SC911-11	B	Unexpected network condition
		<ul style="list-style-type: none"> • Unexpected errors for the network environment • Motherboard of the external controller is defective • Configuration file or device driver corruption
		If rebooting the external controller does not solve the problem, re-install the system software of the external controller. Then if the problem is not solved, replace the motherboard of the external controller.

SC No.	Type	Error Name/Error Condition/Major Cause/Solution
SC911-20	B	Program check - Type 1
SC911-21	B	Program check - Type 2
SC911-22	B	Program check - Type 3
		Programming error
		Reboot the external controller.

SC No.	Type	Error Name/Error Condition/Major Cause/Solution
SC911-24	B	CPU0 Temperature Alert
		CPU0 temperature error by H/W checking
		<ul style="list-style-type: none"> • CPU or CPU cooling fan of the external controller is defective • Connection error between the CPU and CPU cooling fan of the external controller • Exhaust heat port of the external controller is blocked
		<ul style="list-style-type: none"> • Check the connection between the CPU and CPU cooling fan of the external controller.

SC No.	Type	Error Name/Error Condition/Major Cause/Solution
		<ul style="list-style-type: none"> • Check the exhaust heat port of the external controller and clean it up. • Replace the CPU and CPU cooling fan of the external controller. • Replace the motherboard of external the controller.

SC No.	Type	Error Name/Error Condition/Major Cause/Solution
SC911-26	B	<p>CPU1 Temperature Alert</p> <p>CPU1 temperature error by H/W checking</p> <ul style="list-style-type: none"> • CPU or CPU cooling fan of external controller is defective • Connection error between the CPU and CPU cooling fan of the external controller • Exhaust heat port of external controller is blocked <p>• Check the connection between the CPU and CPU cooling fan of the external controller.</p> <ul style="list-style-type: none"> • Check the exhaust heat port of the external controller and clean it up. • Replace the CPU and CPU cooling fan of the external controller. • Replace the motherboard of the external controller.

SC No.	Type	Error Name/Error Condition/Major Cause/Solution
SC911-42	B	<p>Memory configuration has changed.</p> <p>This error occasionally occurs at the initial startup after the software installation of the external controller because of a memory shortage.</p> <p>If rebooting the external controller does not solve the problem, replace the DIMM or the motherboard of the external controller.</p>

SC No.	Type	Error Name/Error Condition/Major Cause/Solution
SC911-43	B	<p>Invalid features defined</p> <p>Invalid features defined</p> <p>Reboot the external controller.</p>

SC No.	Type	Error Name/Error Condition/Major Cause/Solution
SC911-44	B	<p>Recommended amount of memory not found</p> <p>DIMM defective</p> <p>If rebooting the external controller does not solve the problem, replace the DIMM or the motherboard of the external controller.</p>

SC No.	Type	Error Name/Error Condition/Major Cause/Solution
SC911-	B	Recommended number of processors not found

5.Troubleshooting

SC No.	Type	Error Name/Error Condition/Major Cause/Solution
45		CPU or motherboard of external controller defective
		If rebooting the external controller does not solve the problem, replace the CPU/ CPU cooling fan or motherboard of the external controller.

SC No.	Type	Error Name/Error Condition/Major Cause/Solution
SC911-46	D	File read error, hard disk
		System files corruption
		If rebooting the external controller does not solve the problem, do the following. 1. Re-install the system software of the external controller. 2. Replace the HDD of the external controller.

SC No.	Type	Error Name/Error Condition/Major Cause/Solution
SC911-47	B	File write error, hard disk
		System files corruption
		If rebooting the external controller does not solve the problem, do the following. 1. Re-install the system software of the external controller. 2. Replace the HDD of the external controller.

SC No.	Type	Error Name/Error Condition/Major Cause/Solution
SC911-48	B	Checksum error on configuration file.
		System files corruption
		If rebooting the external controller does not solve the problem, re-install the system software of external controller.

SC No.	Type	Error Name/Error Condition/Major Cause/Solution
SC911-49	B	Hard disk backup to USB storage device failure
		Abnormal termination due to incomplete backup to the USB memory of external controller.
		If rebooting the external controller does not solve the problem, replace the USB memory of the external controller for backup.

SC No.	Type	Error Name/Error Condition/Major Cause/Solution
SC911-50	B	Software update failed
		Abnormal termination due to the system software update file failure of external controller
		If rebooting the external controller does not solve the problem, re-install the update file of the external controller.

SC No.	Type	Error Name/Error Condition/Major Cause/Solution
SC911-51	B	RDTU H/W error
		<ul style="list-style-type: none"> RDTU board of external controller is defective Connection fault
		If rebooting the external controller does not solve the problem, replace the RDTU board of the external controller.

SC No.	Type	Error Name/Error Condition/Major Cause/Solution
SC911-55	B	VM option H/W error
		Error (defective, harness disconnected or bad connection, or non-response) relating to the VM option (HDD, controller board, graphic board).
		If rebooting the external controller does not solve the problem, replace the HDD, controller board, graphic board for the VM option.

SC No.	Type	Error Name/Error Condition/Major Cause/Solution
SC911-56	D	Xen VM S/W error
		Xen VM is not started normally or does not work normally.
		There is a possibility that the system file is broken.
		If rebooting the external controller does not solve the problem, re-install the system software of the external controller.

SC No.	Type	Error Name/Error Condition/Major Cause/Solution
SC911-57	B	License key H/W error
		<ul style="list-style-type: none"> USB dongle (includes the license key) of the external controller is defective Connection fault
		<ul style="list-style-type: none"> Reboot the external controller. Re-insert the USB dongle of the external controller. Replace the USB dongle of the external controller.

SC No.	Type	Error Name/Error Condition/Major Cause/Solution
SC911-58	B	License error
		<ul style="list-style-type: none"> License key defective (nonconformity, file corruption and so on) Unauthorized use of USB dongle for external controller (used once to another device, falsification, etc.)
		If rebooting the external controller does not solve the problem, replace the USB dongle of the external controller.

5.Troubleshooting

SC No.	Type	Error Name/Error Condition/Major Cause/Solution
SC911-60	B	Brand mismatch
		An invalid USB dongle is inserted.
		If rebooting the external controller does not solve the problem, re-install the system file of the external controller. Then if the problem is not solved, replace the USB dongle.

SC No.	Type	Error Name/Error Condition/Major Cause/Solution
SC911-61	B	Command timeout communicating with the printer
		No response of command level from the machine to the external controller.
		<ul style="list-style-type: none"> • Check that the main machine is turned on. • Check the cable connection between external controller and main machine. • Restart the main machine and the external controller using the correct procedure.

SC No.	Type	Error Name/Error Condition/Major Cause/Solution
SC911-62	B	Print Engine communication error
		<ul style="list-style-type: none"> • Connection fault • Motherboard (onboard NIC) defective
		<ul style="list-style-type: none"> • Check that the main machine is turned on. • Check the cable connection between external controller and main machine. • Restart the main machine and the external controller using the correct procedure. • Replace the connection cable or motherboard of the external controller.

SC No.	Type	Error Name/Error Condition/Major Cause/Solution
SC911-63	B	A file system access error occurred in the ASCII temporary disk cache.
		System files corruption
		If rebooting the external controller does not solve the problem, re-install the system software of the external controller.

SC No.	Type	Error Name/Error Condition/Major Cause/Solution
SC911-64	B	Page processing timeout
		Time-out error occurs during the page processing for print job.
		If rebooting the external controller does not solve the problem, there may be a problem with the job.

SC No.	Type	Error Name/Error Condition/Major Cause/Solution
SC911-80	-	Turn the main power off/on.
SC911-81	-	
SC911-82	-	
SC911-83	-	
SC911-84	-	
SC911-85	-	
SC911-86	-	
SC911-87	-	
SC911-88	-	
SC911-89	-	

SC No.	Type	Error Name/Error Condition/Major Cause/Solution
SC912-00	B	External controller error 3
SC913-00		External controller error 4
SC914-00		External controller error 5
		The external controller alerted the machine about an error.
		Refer to the instructions for the external controller.
		Turn the main power off/on.

SC No.	Type	Error Name/Error Condition/Major Cause/Solution
SC919-00	D	External controller down
		While EAC (External Application Converter), the conversion module, was operating normally, the receipt of a power line interrupt signal from the FLUTE serial driver was detected, or BREAK signal from the other station was detected.
		<ul style="list-style-type: none"> • Controller power outage • Controller rebooted • Connection to controller loose
		Turn the main power off/on.

SC No.	Type	Error Name/Error Condition/Major Cause/Solution
SC920-02	B	Printer error (WORK memory not acquired)
		When an error is detected in the application, which makes continued operation impossible.
		<ul style="list-style-type: none"> • Software bug • Unexpected hardware configuration (such as insufficient memory)
		<ul style="list-style-type: none"> • Turn the main power off/on. • Increase the memory storage capacity.

5.Troubleshooting

SC No.	Type	Error Name/Error Condition/Major Cause/Solution
SC920-04	B	Printer error (Filter process not started)
		When an error is detected in the application, which makes continued operation impossible.
		<ul style="list-style-type: none"> • Software bug • Unexpected hardware configuration (such as insufficient memory)
		<ul style="list-style-type: none"> • Turn the main power off/on.

SC No.	Type	Error Name/Error Condition/Major Cause/Solution
SC921-00	B	Printer error (Resident font not found)
		Resident font was not found at printer startup
		Preinstalled font files not found.
		Turn the main power off/on.

SC NO.	Type	Error Name/Error Condition/Major Cause/Solution
SC925-00 SC925-01	B	NetFile function error
		The NetFile file management on the HDD cannot be used, or a NetFile management file is corrupted and operation cannot continue.
		<ul style="list-style-type: none"> • HDD defective • HDD inconsistency caused by power failure during HDD access, etc. • Software bug
		<ul style="list-style-type: none"> • If another SC related to HDD errors (SC860 to SC865) is issued at the same time, the HDD is the cause. Solve the other SC. • If SC860 to SC865 is not issued <ol style="list-style-type: none"> 1. Cycle the main power switch off/on. • If this does not work, initialize the HDD NetFile partition (SP5-832-011: HDD Formatting (Ridoc I/F)). Approval by the customer is required because documents waiting to be captured will be lost. The documents stored in the document box (including the documents stored in the scanner) will be retained. (It may take some time to reconstruct the management information when the HDD is accessed from the network for the first time after the initialization.) Procedure: <ol style="list-style-type: none"> 1. In the User Tools mode, do Document Management> Batch Delete Transfer Documents. 2. Do SP5-832-011, then turn the machine power off and on.

SC NO.	Type	Error Name/Error Condition/Major Cause/Solution
		<ul style="list-style-type: none"> If this does not solve the problem, initialize all partitions of the HDD (SP5-832-001: HDD Formatting (ALL)), then turn the machine power off and on. Approval by the customer is required because documents information in the HDD will be lost. If this does not solve the problem, replace the HDD.

SC No.	Type	Error Name/Error Condition/Major Cause/Solution
SC990-00	D	Software operation error
		Software attempted an unexpected operation.
		<ul style="list-style-type: none"> Parameter error Internal parameter error Insufficient work memory Operation error caused by abnormalities that are normally undetectable.
		<ul style="list-style-type: none"> Turn the main power off/on. Reinstall the software of the controller and BICU board.

SC No.	Type	Error Name/Error Condition/Major Cause/Solution
SC991-00	C	Recoverable software operation error
		Software attempted an unexpected operation. SC991 covers recoverable errors as opposed to CS990.
		<ul style="list-style-type: none"> Parameter error Internal parameter error Insufficient work memory Operation error caused by abnormalities that are normally undetectable.
		Logging only

SC No.	Type	Error Name/Error Condition/Major Cause/Solution
SC992-00	D	Undefined SC issued.
		An SC, that is not controlled by the system, occurred.
		<ul style="list-style-type: none"> An SC for the previous model was used mistakenly, etc. Basically a software bug.
		Turn the main power OFF/ON.

SC No.	Type	Error Name/Error Condition/Major Cause/Solution
SC994-00	C	Operation error caused by abnormalities that are normally undetectable.
		An error occurred because the number of records exceeded the limit for images managed in the service layer of the firmware.

5.Troubleshooting

SC No.	Type	Error Name/Error Condition/Major Cause/Solution
		This can occur if there are too many application screens open on the operation panel.
		Logging only.

SC No.	Type	Error Name/Error Condition/Major Cause/Solution
SC997-00	D	Application function selection error
		The application selected by the operation panel key operated abnormally (No response, abnormal ending).
		Software bug (mainly the application)
		<ul style="list-style-type: none"> • Check the optional RAM, DIMM, boards required by the application program. • Check if the combination of downloaded programs are correct.

SC No.	Type	Error Name/Error Condition/Major Cause/Solution
SC998-00	D	Application start error
		<ul style="list-style-type: none"> • No application was registered to system within a specified time after the main power was turned on. (No application starts/All applications have been terminated abnormally) • Application started but cannot be drawn now for some reason.
		<ul style="list-style-type: none"> • Software bug (mainly the application) • The optional RAM, DIMM, boards required by the application program. Are not installed correctly.
		<ul style="list-style-type: none"> • Turn the main power OFF/ON. • Check the optional RAM, DIMM, boards • Check the combination of programs • Replace the controller board.

Troubleshooting for SC Errors

When SC285-02 (MUSIC Error) is displayed

Cause:

- The ID sensor cannot detect the MUSIC pattern
- Color registration error is larger than the specified value

[Assumed Cause]

1. **Large drifting**

"Large drifting" is the state where the color registration error is larger than the specified value.

In the "Large drifting" state, the MUSIC pattern is shifted a long distance in the main scan direction (side to side), and is moved to the position where the MUSIC Sensor (TM/ID sensor) cannot be detected, or each pattern cannot be detected due to the pattern overlapping.

2. **MUSIC Pattern Density Error**

Pattern with the lower density

3. **Defective Image Transfer Belt/Image Transfer Unit**

- Belt scratched
- Belt corrugation, belt skew
- Cleaning failure
- Background stains
- Filming

"Filming" is a phenomenon where surface properties change over time.

Glossiness is one of the surface properties. In the "Filming" state, the whole or part (belt shaped) of the Image Transfer Belt surface becomes foggy. "Filming" changes reflected light, and the MUSIC Sensor (TM/ID sensor) may detect the input wrongly, which causes an error.

4. **MUSIC Sensor (TM/ID sensor) defective**

- Connector/ harness disconnected
- Sensor surface dirty
- Sensor malfunction
- BICU malfunction

5. **Paper Transfer contact/release mechanism defective**

- Connector/ harness disconnected
- Motor / Sensor malfunction
- Imaging IOB malfunction

6. **Laser Optics Positioning Motor (M23) (M24) (M25) in Laser Unit defective**

- Connector/ harness disconnected
- Motor malfunction
- Imaging IOB malfunction

5.Troubleshooting

Solution:

As SC285-02 is a logging SC (SC Type C), it is not displayed at once when an error occurs. Though the equipment can be operated, check the SC history and perform a recovery operation if the SC has occurred.

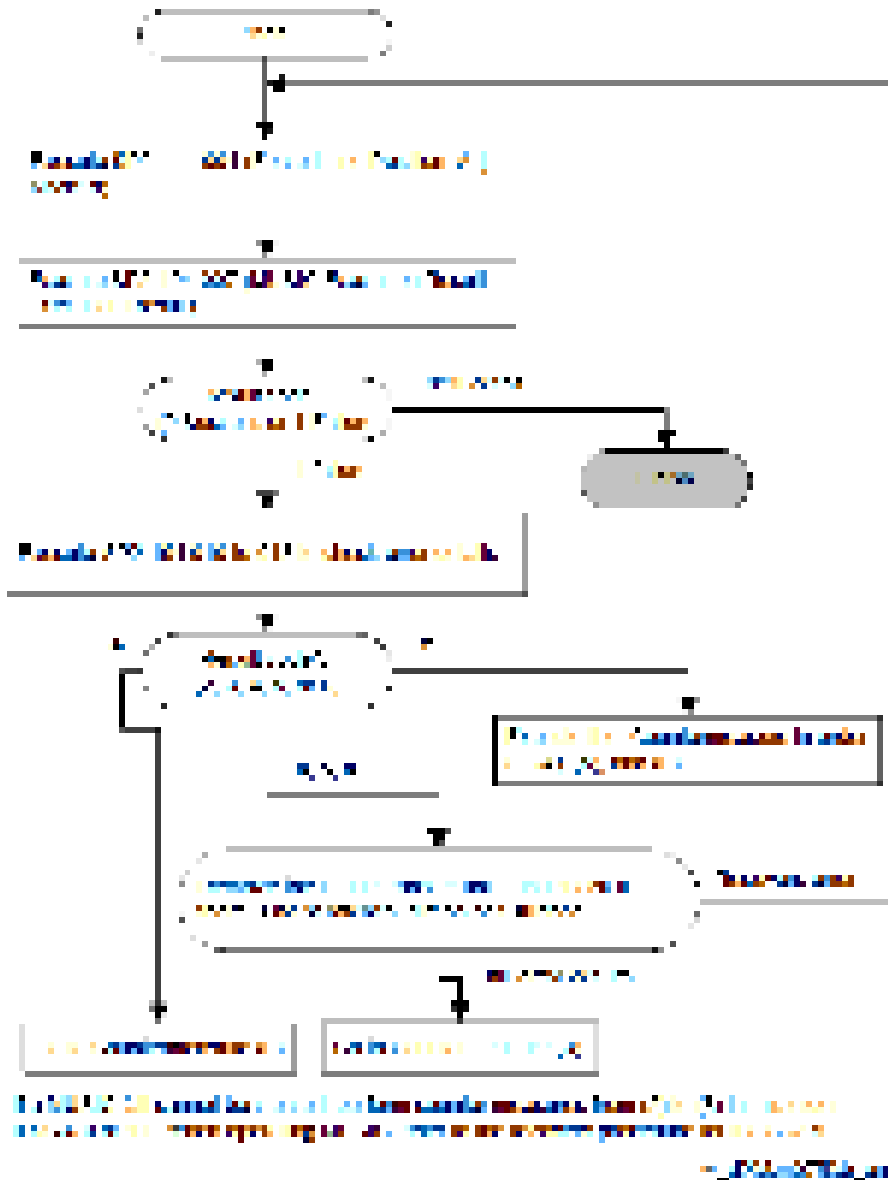

Countermeasure (1): Large Drifting

An abnormal value may be contained in the SP where the MUSIC corrected result is saved.

1. Execute SP2-180-001 (Line Pos. Adj.: Clear Color Regist.).
2. Execute SP2-111-004 (Forced Line Position: Adj. Mode d).
3. Execute SP2-194-007 (MUSIC Execution Result: Execution Result).

Countermeasure (2): MUSIC pattern density Error

Execute MUSIC and check the result.

1. Execute SP3-011-001 (Manual ProCon :Exe : Normal ProCon).
2. Execute SP2-111-004 (Forced Line Position: Adj. Mode d).
3. Execute SP2-194-007 (MUSIC Execution Result: Execution Result).

Countermeasure (3): Image Transfer Belt/ Image Transfer Unit Defective

1. Execute SP2-112-001 (TM/ID Sensor Check Execute).
2. Check SP2-112-010 (TM/ID Sensor Test General:FCR).
 - Normal If the result is "111"
-->Execute other countermeasures.
 - Vsg adjustment is failed if the result is "2xx", "x2x", or "xx2"
-->Execute recovery operation for SC370
 - There is a high probability that contaminants, scars, or irregularities may exist on the belt if the result is "3xx", "x3x", or "xx3"
-->Execute the following procedure;
 1. Remove the Image Transfer Unit, and check for abnormalities such as contaminants or scars, and set it after cleaning.
 2. Execute SP2-111-004 (Forced Line Position: Adj. Mode d).
 3. Execute SP2-194-007 (MUSIC Execution Result: Execution Result).
 4. If it fails, replace the Image Transfer Belt/ Image Transfer Unit.
 - There is a high probability that contaminants or curls may exist on the belt if the result is "5xx", "6xx", "7xx", "8xx", "x5x", "x6x", "x7x", "x8x", "xx5", "xx6", "xx7", or "xx8".
--> Execute the following procedure
 1. Remove the Image Transfer Unit, and check for abnormalities such as contaminants or scars, and set it after cleaning.
 2. Execute SP2-111-004 (Forced Line Position: Adj. Mode d).
 3. Execute SP2-194-007 (MUSIC Execution Result: Execution Result).
 4. If it fails, replace the Image Transfer Belt/ Image Transfer Unit.

Countermeasure (4): TM/ID Sensor (S48) Defective

Follow the next step if executing SP2-111-004 (Forced Line Position: Adj. Mode d) and SP2-194-007 (MUSIC Execution Result: Execution Result) fails.

1. Clean the TM/ID Sensor (S48).
2. Check the harness and connector for TM/ID sensor (S48).
3. Replace the TM/ID sensor (S48).
4. Replace the BICU (PCB10).

Countermeasure (5): Paper Transfer contact/release Mechanism Defective

Check if the MUSIC/ProCon Pattern is attached on the Paper Transfer Roller. If it is attached, separating may be defective.

1. Execute SP5-804-255(OUTPUT Check: Paper Transfer Contact Operation) to operate the Paper

5. Troubleshooting

Transfer Contact Motor to check the separating operation of the Paper Transfer Roller.

2. Check for a broken harness or connector disconnection.
3. If the problem cannot be solved, replace the Imaging IOB (PCB2).

Countermeasure (6): Laser Optics Positioning Motor (M23) (M24) (M25) in Laser Unit Error

1. Check the operation of the laser optics positioning motor (M23) (M24) (M25) and check for a broken harness or connector disconnection. If an abnormality is detected, replace the Laser Unit.
2. If the problem cannot be solved, replace the Imaging IOB (PCB2).

When SC285-03 (Insufficient MUSIC patterns) is Displayed

Solution

- 1.** Print the image and make sure the density is not low.
- 2.** Execute SP2-112-001 (TM/ID Sensor Check Execute).
- 3.** Check SP2-112-010 (TM/ID Sensor Test General:FCR).
 - Normal If the result is "111"
--> Execute other countermeasures.
 - Vsg adjustment has failed if the result is "2xx", "x2x", or "xx2"
-->Execute recovery operation for SC370
 - It is highly likely that contaminants, scars, or irregularities exist on the belt if the result is "3xx", "x3x", or "xx3"
- 4.** Execute SP2-112-001 (TM/ID Sensor Check Execute) again.
- 5.** Check SP2-112-010 (TM/ID Sensor Test General:FCR).
 - If the problem persists, replace the image transfer belt unit/image transfer belt.
 - If the result is "5xx", "6xx", "7xx", "8xx", "x5x", "x6x", "x7x", "x8x", "xx5", "xx6", "xx7", or "xx8":
The belt may be stained or twisted. Remove the image transfer belt and check whether its surface is stained or scratched. If it is stained, clean it.
- 6.** Execute SP2-112-001 (TM/ID Sensor Check Execute) again.
- 7.** Check SP2-112-010 (TM/ID Sensor Test General:FCR).
- 8.** If the problem persists, replace the image transfer belt unit/image transfer belt.

When SC370 (TM (ID) sensor calibration error) is Displayed

Cause:

- TM/ID sensor connector missing/connection error
- TM/ID sensor detection window dirt
- TM/ID sensor malfunction
- Undulation in the ITB, or belt slippage

Solution:

Check if the SC occurs by turning the power OFF then ON. If the SC occurs again, do the following steps.

- 1.** Check if all connectors related to TM/ID sensor are connected securely. Reconnect the connectors if they are disconnected, or loose.
If TM/ID sensor is contaminated, clean it (never use a dry cloth).
- 2.** Execute SP5-804-255 (OUTPUT Check: Paper Transfer Contact Operation) to operate the Paper Transfer Contact and Release Motor (M18)) to check opening/closing of the shutter.
- 3.** Check if there is an abnormality on the image transfer belt surface.
If any abnormalities are found on the image transfer belt surface, replace the image transfer belt.
 - Belt scratched
 - Belt corrugation, belt skew
 - Cleaning failure
 - Background stains
 - Filming
- 4.** Check the TM/ID sensor (S48) for malfunctions, and recover or replace it if there are any defects.
- 5.** Check the harness. Replace the harness if it is disconnected, or damaged.
- 6.** If the SC is not cleared even after performing steps 1 to 6, replace the BICU (PCB10).

Recovery Check Procedure

- 1.** Execute Vsg adjustment.
- 2.** Execute SP3-323-001(Vsg Adj OK?: Latest) to check the code.
 - If code is "1": Recovered
 - If code is not "1": Not recovered

Adjustment after Recovery

After performing recovery on SC370, execute the following adjustment procedures.

- 1.** Execute SP2-111-004 (Forced Line Position: Adj. Mode d).
- 2.** Execute the following SPs and check the results:
 - SP2-194-007 (Execution Result)
 - SP2-194-010 (Error Result: C)
 - SP2-194-011 (Error Result: M)
 - SP2-194-012 (Error Result: Y)

Execute result sample
Factory default: 0
Success: 1
- 3.** Execute SP3-011-001 (Manual ProCon :Exe).
- 4.** Execute the following SPs and check the results.
 - SP3-012-001 to 010 (Front)

5.Troubleshooting

- SP3-012-011 to 020 (Center)
- SP3-012-021 to 030 (Rear)

Execute result sample (In order of YMCK from left)

- Factory default:[00,00,00,00]
- Starting adjust:[99,99,99,99]
- Fail Vsg adjust(Y):[21,99,99,99]
- Error of Development gamma Max(C):[99,99,55,99]
- Succeed:[11,11,11,11]

When SC371 (TM/ID Sensor Output Error: Background Output (Regular Reflection)) is Displayed

Cause:

- TM/ID sensor connector missing/connection error
- TM/ID sensor malfunction

Solution:

Change the value in SP3-322-021 to 023 to "30mA", and then check if the SC occurs by turning the power OFF then ON. If the SC occurs again, do the following steps.

- 1.** Check if all connectors related to TM/ID sensor are connected securely. Reconnect the connectors if they are disconnected, or loose.
- 2.** If TM/ID sensor is contaminated, clean it (never use a dry cloth).
- 3.** Check the harness. Replace the harness if it is disconnected, or damaged.
- 4.** Check if there is an abnormality on the image transfer belt surface.
- 5.** If any abnormalities are found on the image transfer belt surface, replace the image transfer belt.
 - Belt scratched
 - Belt corrugation, belt skew
 - Cleaning failure
 - Background stains
 - Filming
- 6.** If the SC is not cleared even after performing steps 1 to 5, replace the BICU (PCB10).

Recovery Check Procedure

- 1.** Execute Vsg adjustment.
- 2.** Execute SP3-323-001(Vsg Adj OK?: Latest) to check the code.
 - If code is "1": Recovered
 - If code is not "1": Not recovered

When SC375 (TM/ID sensor output error, belt damage detected) is Displayed

Cause:

- TM/ID sensor connector missing/connection error
- TM/ID sensor detection window dirt
- TM/ID sensor malfunction
- Undulation in the ITB, or belt slippage

Solution:

Check if the SC occurs by turning the power OFF then ON. If the SC occurs again, do the following steps.

- 1.** Check if all connectors related to TM/ID sensor are connected securely. Reconnect the connectors if they are disconnected, or loose.
If TM/ID sensor is contaminated, clean it (never use a dry cloth).
- 2.** Execute SP5-804-255 (OUTPUT Check: Paper Transfer Contact Operation) to operate the Paper Transfer Contact and Release Motor (M18) to check opening/closing of the shutter.
- 3.** Check if there is an abnormality on the image transfer belt surface.
If any abnormalities are found on the image transfer belt surface, replace the image transfer belt.
 - Belt scratched
 - Belt corrugation, belt skew
 - Cleaning failure
 - Background stains
 - Filming
- 4.** Check the TM/ID sensor (S48) for malfunctions, and recover or replace it if there are any defects.
- 5.** Check the harness. Replace the harness if it is disconnected, or damaged.
- 6.** If the SC is not cleared even after performing steps 1 to 6, replace the BICU (PCB10).

Recovery Check Procedure

- 1.** Execute Vsg adjustment.
- 2.** Execute SP3-323-001(Vsg Adj OK?: Latest) to check the code.
 - If code is "1": Recovered
 - If code is not "1": Not recovered

When SC501, SC502, SC503, or SC504 (Paper Tray Lift/Descent Error) is Displayed

SC501, SC502, SC503, or SC504 occurs.

Lift error: A pop-up window appears on the first or second error detections. The SC appears the third time.

Descent error: A pop-up window appears on the first to fourth error detections. The SC appears the fifth time.

1. Place the fusing unit on a flat place and tilt it towards the drawer connector [A].



2. Move the shield **drive gear** with your hands to put the upper surface of the feeler [A] in a horizontal position.
 - It is necessary to move the **gear** to move the feeler.
 - Moving the feeler directly will affect smooth operation, so be sure to move the **gear**.



3. Keep your fingers off the shield drive gear.

5. Troubleshooting

4. Make sure that the shield detection feeler [A] moves down to the lowest point by its own weight.

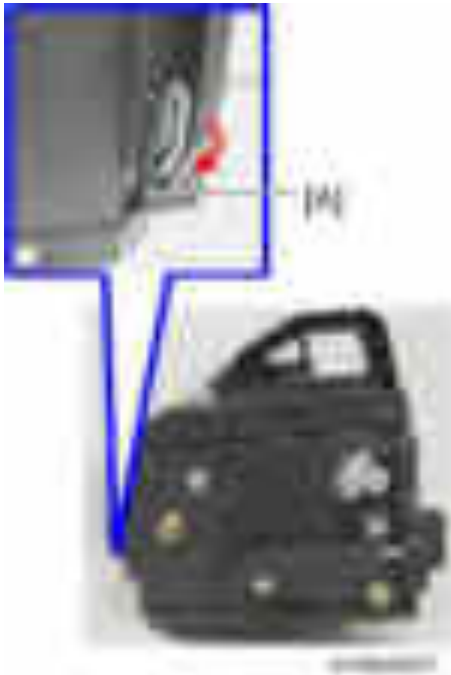

- The feeler moves smoothly: OK
- The feeler does not move / stops during moving / moves slowly: NG

Procedure 2: Operation check for the upper side of the shield detection feeler

1. Place the fusing unit on a flat place with the drawer connector [A] turned up and the handle [B] touching a flat surface.



2. Move the shield drive gear with your hands to put the upper surface of the feeler [A] in a vertical position.
 - It is necessary to move the **gear** to move the feeler.
 - Moving the feeler directly will affect smooth operation, so be sure to move the **gear**.



- 3.** Keep your fingers off of the shield drive gear.
- 4.** Make sure that the shield detection feeler [A] moves up to the highest point by its own weight.



- The feeler moves smoothly: OK
- The feeler does not move / stops during moving / moves slowly: NG

Results

- Both Procedure 1 and 2 are OK: No problem.
- Either Procedure 1 or 2 is NG: The mechanism is blocked.
- The shield detection feeler never moves while moving the shield drive gear by hands or fingers: Locked.

Solution

By tilting the fusing unit, you can check whether the feeler does not move smoothly due to burrs on a part in the unit, and remove the burrs.

5. Troubleshooting

1. Tilt the fusing unit [A] approx. 30°.



2. Put the fusing unit back to the horizontal position.
3. Perform the checking procedures (Fusing Shield Check).
There is no blockage: Resolved
There is a blockage: Not resolved
4. Tilt the fusing unit [A] approx. 30° in the opposite direction from step 1.



There is no blockage: Resolved
There is a blockage: Not resolved

When SC670 (Engine start up error) is displayed

Cause

The engine board resets at an unexpected time, and does not start up again.
This occurs in the priority order of SC670-03 > 04 > 05 > 01 > 02.

Solution

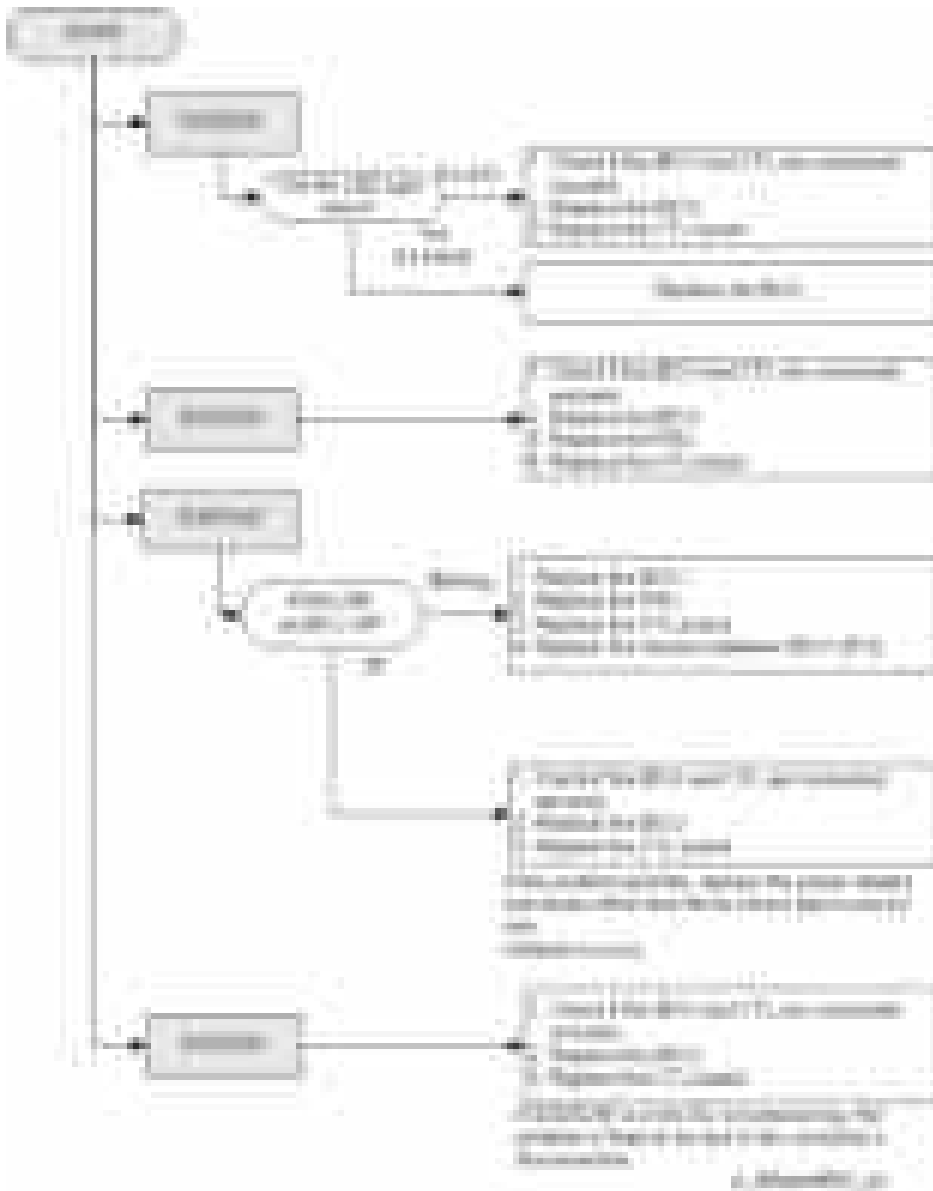

When SC672 (Controller start up error) is displayed

Overview

Smart Operation Panel communicates with the controller via the USB cable [Fig.1-A] and harness [Fig.1-B].

SC672 is displayed upon detecting that communication failure between Smart Operation Panel and the controller.



- If SC672 occurs when Smart Operation Panel is off [Fig.2], handle the problem according to this procedure, not those for the SC brunch number.

5.Troubleshooting



Fig. 3: Smart Operation Panel block diagram

[A]: USB cable

[B]: Harness

[C]: DIMM

[D]: LED

[E]: Fuse

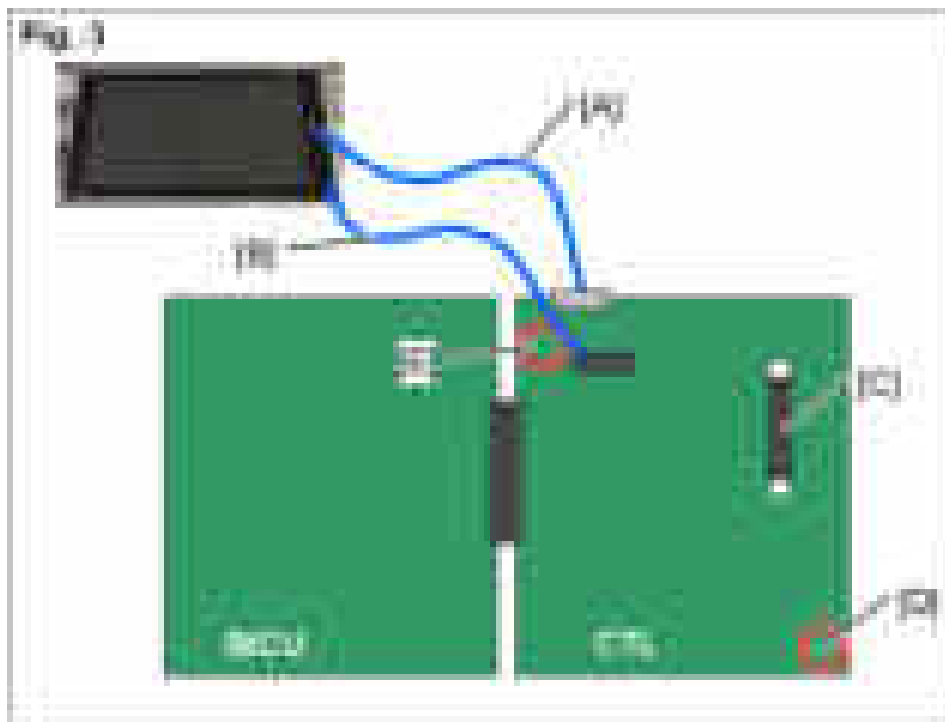

SC	Cause
SC672-00	Communication error between operation panel and controller after machine is powered on.
SC672-10	Communication error (receive) between operation panel and controller after machine is powered on.
SC672-11	Communication error (send) between operation panel and controller after machine is powered on.
SC672-12	Communication error between operation panel and controller after normal start-up.
SC672-13	If communication error between the operation panel and controller is detected due to a cause other than those stated above (-00, -10, -11, and -12).
SC672-20	Harness connection error on the operation panel.
SC672-21	Controller board error.
SC672-99	Unexpected shutdown of the operation panel's software (OCS).

5.Troubleshooting

Flowchart for Identifying the Cause of the Problem

Flowchart for Identifying the Cause of the Problem when SC672 Occurs (Fig.4)



Flowchart for Identifying the Cause of the Problem when the Operation Panel is Not Lit

(Fig.5)



Solutions

CAUTION

- Before replacing parts, be sure to turn the main power off and disconnect the power plug from the receptacle.

Checking if the problem reoccurs

1. Before replacing the board, cable and operation panel, check if the problem reoccurs.

Disconnecting, reconnecting and replacing the USB cable

1. Disconnect and then reconnect both ends of the USB cable and check if the problem persists.
2. If the problem persists, identify the cause of the problem according to the flowchart.
3. For information about how to remove and reattach the PCBs, control panel and cables, see Chapter 4 "Replacement and Adjustment".

Replacing DIMM

1. Unlock the DIMM socket, and then remove the DIMM.

5.Troubleshooting

- 2.** With the locks at the sides of the DIMM socket lowered outward, insert the new DIMM. Be sure to insert the DIMM vertical to the socket.
- 3.** Insert the DIMM all the way through until it clicks.

DIMM replacement procedure (excerpts from the manufacturer's specification sheet)

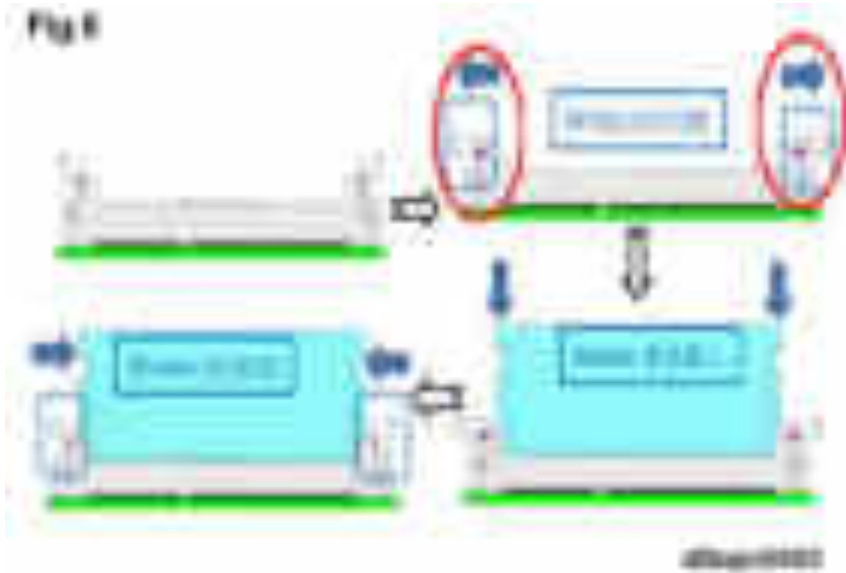

DIMM locking status (A: unlocked, B: locked)



LED/POSTCODE Display

1. POSTCODE

When the power is turned on or when the machine recovers from the STR state, the BIOS self-diagnostic code appears.

LED after BIOS is completed

POSTCODE1,2,3,4,5,6	Lighting up
POSTCODE7	Lighting up
POSTCODE8	Blinking

In case of DIMM loose connection or BIOS error, POSTCODE 7 does not blink and part or all of the LEDs light up.

Device status and LED indication

Status	LED
--------	-----

	BIOS/OS LED (Red)	POST CODE LED(Red)
Normal (at the startup)	Undefined	Undefined
Normal (waiting)	Slow blink (every 1 second)	Slow blink (every 1 second)
DIMM error	Off	Part or all LEDs light up.
Controller board error (BIOS error)	Off	All LEDs light up.
Controller board error	Slow blink (every 1 second)	POST CODE8 Slow blink (every 1 second)

Fig.8: LED area

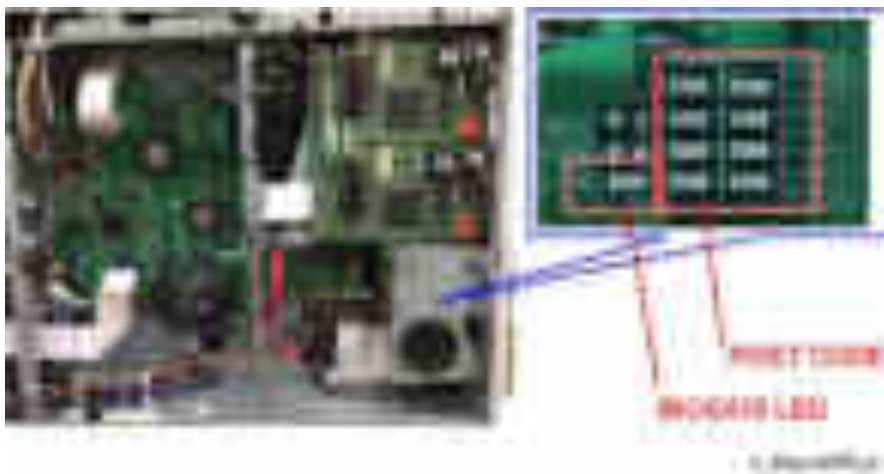

Fig.9: Normal (waiting) (POSTCODE_8 and BIOS/OS LED blinking every 1 second.)

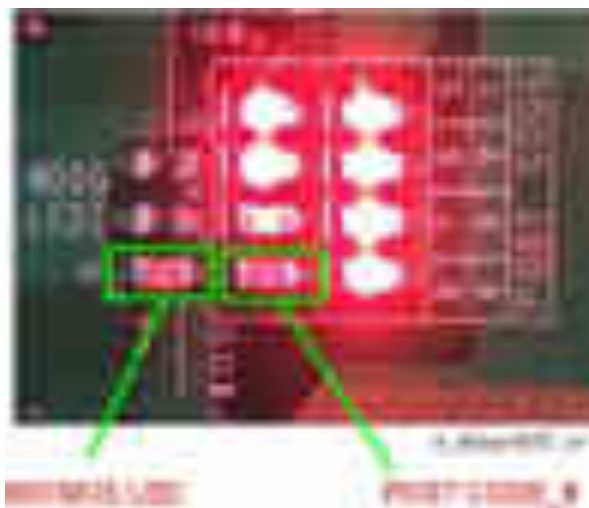

Fig. 10: Error status

[A]: LEDs 1, 3, 5, and 7 light up.

[B]: LEDs 1 to 8 all light up.

5. Troubleshooting



Checking the Fuse

Check the voltage at the OUT (operation panel).



Jam Detection

Jam Display

When a jam occurs, the cause position will blink.

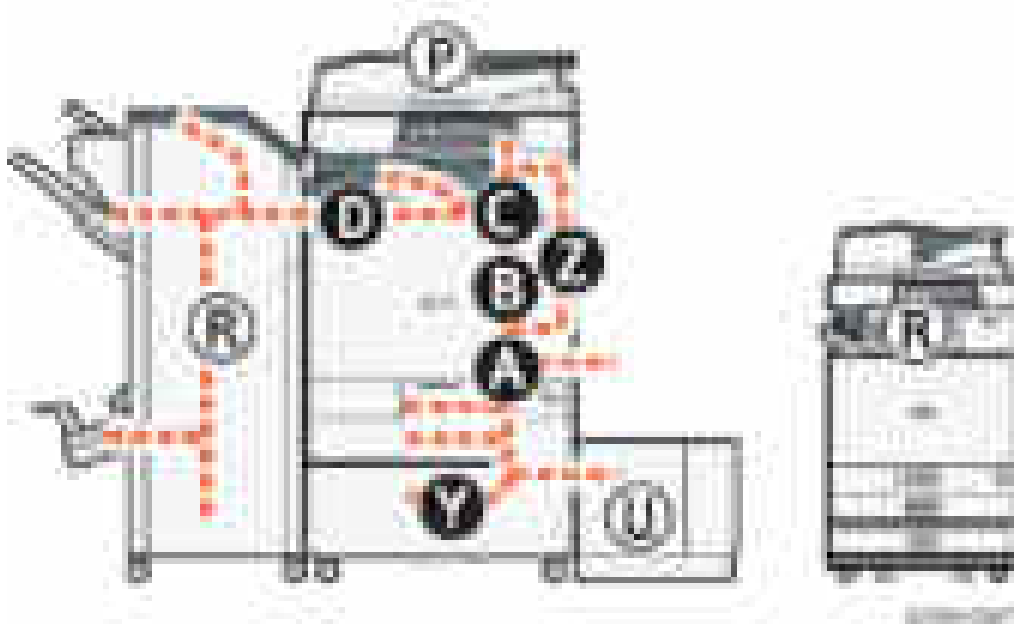

Clearing a Paper Jam

CAUTION

- Do not touch any components except the specified parts for removing jammed paper. Some parts can burn you because they become hot during operation.

Note

- Do not turn the power off during removal of jammed paper. If you turned the power off, functions or values that were previously set will be deleted.
- Be sure not to tear paper up, and that you remove all pieces. Remaining scraps of paper in the machine could cause another paper jam or machine failure.
- If there are multiple jam locations, check all the locations that are displayed at the same time.

Paper Jam History

How to Check the Jam History

Plotter (print engine) jam history can be displayed using SP7-507.

- SP7-507-001 "Plotter Jam: History Latest"
- SP7-507-002 "Plotter Jam: History Latest1"
- SP7-507-003 "Plotter Jam: History Latest2"
- SP7-507-004 "Plotter Jam: History Latest3"

5. Troubleshooting

- SP7-507-005 "Plotter Jam: History Latest4"
- SP7-507-006 "Plotter Jam: History Latest5"
- SP7-507-007 "Plotter Jam: History Latest6"
- SP7-507-008 "Plotter Jam: History Latest7"
- SP7-507-009 "Plotter Jam: History Latest8"
- SP7-507-010 "Plotter Jam: History Latest9"

Paper Jam Display



- CODE: Indicates the jam code.
- SIZE: Indicates the paper size code.
- TOTAL: Indicates the total counter (SP7-502-001).
- DATE: Indicates the date when the jam occurred.



- The jam history of the 10 latest jams is displayed.
- The first jam is not included in the history record.

Jam Codes and Display Codes



- Cause code: Jam cause code displayed by log data
- Display code: Jam position displayed on control panel

Late jam

The paper has failed to arrive within the prescribed time due to a jam that has occurred upstream of the referenced sensor.

Lag jam

The paper has failed to leave the location of the referenced sensor within the prescribed time due to a jam downstream of the referenced sensor.

Stay jam

The paper is within the location of the referenced sensor.

ARDF DF3110

Cause code	Cause of jam	Late Jam	Lag Jam	Stay Jam	Display code
014	Skew Correction Sensor (Front)	■			P

Cause code	Cause of jam	Late Jam	Lag Jam	Stay Jam	Display code
018	Skew Correction Sensor (Rear)	■			P
064	Skew Correction Sensor		■		P
016	Registration Sensor	■			P
066	Registration Sensor		■		P
017	Exit Sensor	■			P
067	Exit Sensor		■		P
239	Misfeed: Original Removed			■	P

SPDF DF3120

Cause code	Cause of jam	Late Jam	Lag Jam	Stay Jam	Display code
013	Separation Sensor	■			P
063	Separation Sensor		■		P
014	Skew Correction Sensor	■			P
064	Skew Correction Sensor		■		P
015	Pre-Scanning Entrance Sensor	■			P
065	Pre-Scanning Entrance Sensor		■		P
016	Registration Sensor	■			P
066	Registration Sensor		■		P
017	Exit Sensor	■			P
067	Exit Sensor		■		P
099	Double Feed Sensor		■		P
239	Misfeed: Original Removed			■	P
001	Initial jam	■			P
001	Overload jam	■			P

Main Machine

Cause code	Cause of jam	Late Jam	Lag Jam	Stay Jam	Display code
001	Transport Sensor 1			■	A
001	Transport Sensor 2			■	A
001	Registration Sensor			■	B
001	Fusing Entrance Sensor			■	C
001	Fusing Exit Sensor			■	C
001	Paper Exit Sensor			■	C
001	Reverse Sensor			■	C
001	Duplex Exit Sensor			■	Z

5.Troubleshooting

Cause code	Cause of jam	Late Jam	Lag Jam	Stay Jam	Display code
001	Duplex Entrance Sensor			■	Z
003	Paper not fed from tray 1	■			A1
004	Paper not fed from tray 2	■			A2
008	Paper not fed from bypass tray	■			A
009	Paper not transported to duplex unit	■			Z
096	Disappearance of the detection Timing Only remaining paper position information displayed				
011	Transport Sensor 1	■			A
012	Transport Sensor 2	■			A
017	Registration Sensor	■			A
018	Fusing Entrance Sensor	■			B
019	Fusing Exit Sensor	■			C
020	Paper Exit Sensor	■			C
051	Transport Sensor 1 (when paper not fed from Tray 1)		■		A
052	Transport Sensor 2		■		A
048	Transport Sensor 1 (when paper not fed from Bypass Tray)		■		A
057	Registration Sensor		■		B
060	Paper Exit Sensor		■		C
024	Reverse Sensor	■			C
064	Reverse Sensor		■		C
025	Duplex Exit Sensor	■			Z
025	Duplex Exit Sensor & No Paper at Duplex Entrance Sensor	■			Z
065	Duplex Exit Sensor		■		Z
027	Duplex Entrance Sensor	■			C
027	Duplex Entrance Sensor & No Paper at Reverse Sensor	■			Z
067	Duplex Entrance Sensor		■		A

Paper Feed Unit PB3270

Cause code	Cause of jam	Late Jam	Lag Jam	Stay Jam	Display code
005	Paper not fed from tray 3	■			Y1
013	Vertical Transport Sensor (Tray 3)	■			Y

Cause code	Cause of jam	Late Jam	Lag Jam	Stay Jam	Display code
053	Vertical Transport Sensor (Tray 3)		■		Y
001	Vertical Transport Sensor (Tray 3)			■	Y

Paper Feed Unit PB3280/Paper Feed Unit PB3300

Cause code	Cause of jam	Late Jam	Lag Jam	Stay Jam	Display code
005	Paper not fed from tray 3	■			Y1
013	Vertical Transport Sensor (Tray 3)	■			Y
053	Vertical Transport Sensor (Tray 3)		■		Y
001	Vertical Transport Sensor (Tray 3)			■	Y
006	Paper not fed from tray 4	■			Y2
014	Vertical Transport Sensor (Tray 4)	■			Y
054	Vertical Transport Sensor (Tray 4)		■		Y
001	Vertical Transport Sensor (Tray 4)			■	Y

LCIT PB3290

Cause code	Cause of jam	Late Jam	Lag Jam	Stay Jam	Display code
005	Paper not fed from tray 3	■			Y1
013	Vertical Transport Sensor (Tray 3)	■			Y
053	Vertical Transport Sensor (Tray 3)		■		Y
001	Vertical Transport Sensor (Tray 3)			■	Y

LCIT RT3040

Cause code	Cause of jam	Late Jam	Lag Jam	Stay Jam	Display code
007	Paper not fed from side LCT	■			U1
015	Transport Sensor (Side LCT)	■			U
058	Transport Sensor (Side LCT)		■		U
001	Transport Sensor (Side LCT)			■	U

Bridge Unit BU3090

Cause code	Cause of jam	Late Jam	Lag Jam	Stay Jam	Display code
021	Paper Exit Sensor (Bridge Unit)	■			D
022	Relay Transport Sensor (Bridge Unit)	■			D
061	Paper Exit Sensor (Bridge Unit)		■		D

5.Troubleshooting

Cause code	Cause of jam	Late Jam	Lag Jam	Stay Jam	Display code
062	Relay Transport Sensor (Bridge Unit)		■		D

Internal Finisher SR3250

Cause code	Cause of jam	Late Jam	Lag Jam	Stay Jam	Display code
001	Punch Entrance Sensor	■		■	R1-R2
100	Inlet Sensor	■			R1-R2
101	Inlet Sensor		■		R1-R2
102	Transport sensor	■			R1-R2
103	Transport sensor		■		R1-R2
104	Paper Exit Unit		■		R1-R2
105	Jogger fence motor (front)			■	R1-R2
106	Jogger fence motor (rear)			■	R1-R2
107	Shift Roller Motor			■	R1-R2
108	Positioning Roller Motor			■	R1-R2
109	Paper Exit Guide Plate Open/Close Motor			■	R1-R2
110	Stapler Retreat Motor			■	R1-R2
111	Shift Tray Ascent/Descent Motor			■	R1-R2
112	Stapler Motor			■	R1-R2
113	Paper Press Motor			■	R1-R2
114	Punch Motor			■	R1-R2
115	Punch Displacement Motor			■	R1-R2
116	Horizontal Registration Displacement Motor			■	R1-R2
148	Paper exit end not responding			■	R1-R2
149	Main instruction data defect			■	R1-R2

Finisher SR3280

Cause code	Cause of jam	Late Jam	Lag Jam	Stay Jam	Display code
001	Entrance Sensor			■	R1-R5
001	Horizontal Transport Sensor			■	R1-R5
001	Switchback Transport Sensor			■	R1-R5
001	Proof Exit Sensor			■	R1-R5
001	Shift Exit Sensor			■	R1-R5
001	Middle Transport Paper Sensor			■	R1-R5
150	Entrance Sensor	■			R1-R5
151	Entrance Sensor		■		R1-R5

5.Troubleshooting

Cause code	Cause of jam	Late Jam	Lag Jam	Stay Jam	Display code
152	Horizontal Transport Sensor	☒			R1-R5
153	Horizontal Transport Sensor		☒		R1-R5
154	Switchback Transport Sensor	☒			R1-R5
155	Switchback Transport Sensor		☒		R1-R5
156	Proof Exit Sensor	☒			R1-R5
157	Proof Exit Sensor		☒		R1-R5
158	Shift Exit Sensor	☒			R1-R5
159	Shift Exit Sensor		☒		R1-R5
162	Jam in Entrance Transport Motor	☒	☒		R1-R5
163	Jam in Horizontal Transport Motor	☒	☒		R1-R5
164	Jam in Pre-stack Transport Motor	☒	☒		R1-R5
165	Jam in Middle Transport Motor	☒	☒		R1-R5
166	Jam in Tray Exit Motor	☒	☒		R1-R5
167	Jam in Trailing Edge Pressure Plate Motor	☒	☒		R1-R5
168	Jam in Paper Exit Gate Motor	☒	☒		R1-R5
169	Jam in Horizontal registration unit displace motor	☒	☒		R1-R5
170	Jam in Punch unit drive motor	☒	☒		R1-R5
171	Jam in Horizontal registration correction motor	☒	☒		R1-R5
172	Jam in Lower Junction Gate Motor	☒	☒		R1-R5
173	Jam in Jogger Motor	☒	☒		R1-R5
174	Jam in Positioning Roller Motor	☒	☒		R1-R5
175	Jam in Paper release Motor	☒	☒		R1-R5
176	Jam in Corner Stapler Movement Motor	☒	☒		R1-R5
177	Jam in Corner Stapler Drive Motor	☒	☒		R1-R5
185	Jam in Tray Lift Motor	☒	☒		R1-R5
186	Jam in Shift Motor	☒	☒		R1-R5
187	Jam in Shift Jogger Motor (Front)	☒	☒		R1-R5
188	Jam in Shift Jogger Motor (Rear)	☒	☒		R1-R5
189	Jam in Shift Jogger Retraction Motor	☒	☒		R1-R5
190	Jam in Reverse Roller Motor	☒	☒		R1-R5
191	Jam in Leading Edge Guide Motor	☒	☒		R1-R5
192	Jam in Positioning Transport Motor	☒	☒		R1-R5
193	Jam in Drove Motor	☒	☒		R1-R5
194	Main instruction data defect	☒	☒		R1-R5

5.Troubleshooting

Booklet Finisher SR3290

Cause code	Cause of jam	Late Jam	Lag Jam	Stay Jam	Display code
001	Entrance Sensor			☒	R1-R5
001	Horizontal Transport Sensor			☒	R1-R5
001	Switchback Transport Sensor			☒	R1-R5
001	Proof Exit Sensor			☒	R1-R5
001	Shift Exit Sensor			☒	R1-R5
001	Saddle Stitch Exit Sensor			☒	R6-R11
001	Paper transport sensor			☒	R1-R5
001	Booklet Paper Sensor (Upper)			☒	R6-R11
001	Booklet Paper Sensor (Lower)			☒	R6-R11
150	Entrance Sensor	☒			R1-R5
151	Entrance Sensor		☒		R1-R5
152	Horizontal Transport Sensor	☒			R1-R5
153	Horizontal Transport Sensor		☒		R1-R5
154	Switchback Transport Sensor	☒			R1-R5
155	Switchback Transport Sensor		☒		R1-R5
156	Jam in proof exit unit	☒			R1-R5
157	Jam in proof exit unit		☒		R1-R5
158	Jam in shift exit unit	☒			R6-R11
159	Jam in shift exit unit		☒		R1-R5
160	Jam in Booklet exit	☒			R1-R5
161	Jam in Booklet exit		☒		R1-R5
162	Jam in Entrance Transport Motor	☒	☒		R1-R5
163	Jam in Horizontal Transport Motor	☒	☒		R1-R5
164	Jam in Pre-stack Transport Motor	☒	☒		R1-R5
165	Jam in Middle Transport Motor	☒	☒		R1-R5
166	Jam in Tray Exit Motor	☒	☒		R1-R5
167	Jam in Trailing Edge Pressure Plate Motor	☒	☒		R1-R5
168	Jam in Paper Exit Gate Motor	☒	☒		R1-R5
169	Jam in Horizontal registration unit displace motor	☒	☒		R1-R5
170	Jam in Punch unit drive motor	☒	☒		R1-R5
171	Jam in Horizontal registration correction motor	☒	☒		R1-R5
172	Jam in Lower Junction Gate Motor	☒	☒		R1-R5
173	Jam in Jogger Motor	☒	☒		R1-R5

Cause code	Cause of jam	Late Jam	Lag Jam	Stay Jam	Display code
174	Jam in Positioning Roller Motor	☒	☒		R1-R5
175	Jam in Paper release Motor	☒	☒		R6-R11
176	Jam in Corner Stapler Movement Motor	☒	☒		R6-R11
177	Jam in Corner Stapler Drive Motor	☒	☒		R6-R11
178	Jam in Booklet Jogger Motor	☒	☒		R6-R11
179	Jam in Booklet Jogger Plate Motor	☒	☒		R6-R11
180	Jam in Booklet Stapler reference fence Motor	☒	☒		R6-R11
181	Booklet Stapler Motor	☒	☒		R6-R11
182	Jam in Positioning Roller Transport Motor	☒	☒		R6-R11
183	Jam in Holding transport Motor	☒	☒		R1-R5
184	Jam in Square Fold Motor	☒	☒		R1-R5
185	Jam in Tray Lift Motor	☒	☒		R1-R5
186	Jam in Shift Motor	☒	☒		R1-R5
187	Jam in Shift Jogger Motor (Front)	☒	☒		R1-R5
188	Jam in Shift Jogger Motor (Rear)	☒	☒		R1-R5
189	Jam in Shift Jogger Retraction Motor	☒	☒		R1-R5
190	Jam in Reverse Roller Motor	☒	☒		R1-R5
191	Jam in Leading Edge Guide Motor	☒	☒		R1-R5
192	Jam in Positioning Transport Motor	☒	☒		R1-R5
193	Jam in Paper Guide Drive Motor	☒	☒		R1-R5
194	Main instruction data defect	☒	☒		R1-R5,R6-R11

Booklet Finisher SR3270 / Finisher SR3260

Cause code	Cause of jam	Late Jam	Lag Jam	Stay Jam	Display code
200	Paper Entrance	☒			R1-R4
201	Paper Entrance		☒		R1-R4
202	Proof Exit	☒			R1-R4
203	Proof Exit		☒		R1-R4
204	Intermediate transport (right)	☒			R1-R4
205	Intermediate transport (left)	☒			R1-R4
206	Intermediate transport (left)		☒		R1-R4
207	Shift Exit	☒			R1-R4
208	Shift Exit		☒		R1-R4

5.Troubleshooting

Cause code	Cause of jam	Late Jam	Lag Jam	Stay Jam	Display code
209	Stack Transport	☒			R5-R10
210	Rear Edge Stopper Transport	☒			R5-R10
211	Rear Edge Stopper Transport		☒		R5-R10
212	Paper did not reach middle folding exit	☒			R5-R10
213	Middle Folding exit		☒		R5-R10
220	Jam in inlet transport motor	☒	☒	☒	R1-R4
221	Jam in proof transport motor	☒	☒	☒	R1-R4
222	Jam in exit transport/positioning/approach roller motor	☒	☒	☒	R1-R4
223	Jam in shift motor	☒	☒	☒	R1-R4
224	Jam in jogger motor	☒	☒	☒	R1-R4
225	Jam in exit guide plate open/close motor	☒	☒	☒	R1-R4
226	Jam release motor	☒	☒	☒	R1-R4
227	Jam in tray ascent/descent motor	☒	☒	☒	R1-R4
228	Jam in positioning roller motor	☒	☒	☒	R1-R4
229	Jam in stapler retreat motor	☒	☒	☒	R1-R4
230	Jam in stapler motor	☒	☒	☒	R1-R4
231	Jam in punch system motor	☒	☒	☒	R1-R4
232	Jam in stack transport motor	☒	☒	☒	R5-R10
233	Jam in rear edge stopper motor	☒	☒	☒	R5-R10
234	Jam in folding brade motor	☒	☒	☒	R5-R10
235	Jam in paper exit guide drive motor	☒	☒	☒	R1-R4
236	Jam in stapleless stapler transfer motor	☒	☒	☒	R1-R4
237	Jam in staple motor (stapleless)	☒	☒	☒	R1-R4
238	Jam in paper guide motor	☒	☒	☒	R1-R4
239	Jam in return roller motor	☒	☒	☒	R1-R4
248	Paper exit end is not responding	☒	☒	☒	R1-R4
249	Main instruction data defect	☒	☒	☒	R1-R4

Internal Finisher SR3300

Cause code	Cause of jam	Late Jam	Lag Jam	Stay Jam	Display code
300	Entrance sensor	☒			R
301	Entrance sensor		☒		R
302	Paper exit sensor	☒			R
303	Paper exit sensor		☒		R

Cause code	Cause of jam	Late Jam	Lag Jam	Stay Jam	Display code
304	Shift motor			☒	R
305	Junction gate motor			☒	R
306	Paper exit pressure release motor			☒	R
307	Stapler motor			☒	R
348	Paper exit end not responding			☒	R

Internal Multi-Fold Unit FD3010

Cause code	Cause of jam	Late Jam	Lag Jam	Stay Jam	Display code
350	Registration sensor	☒			N1
351	Registration sensor		☒		N1
352	1st Fold sensor	☒			N2-N4
353	1st Fold sensor		☒		N2-N4
354	2nd Fold Sensor	☒			N6-N8
355	2nd Fold Sensor		☒		N6-N8
356	Crease Sensor	☒			N6-N8
357	Crease Sensor		☒		N6-N8
358	Folder Tray Exit Sensor	☒			N2-N4
359	Folder Tray Exit Sensor		☒		N2-N4
360	Horizontal Path Exit Sensor	☒			N2-N4, N5
361	Horizontal Path Exit Sensor		☒		N5
370	Jam in mechanisms driven by Registration Motor	☒	☒	☒	N1
371	Jam in mechanisms driven by JG Crease Motor	☒	☒	☒	N2-N4
372	Jam in mechanisms driven by Transport Motor	☒	☒	☒	N2-N4
373	Jam in mechanisms driven by 1st Fold Motor	☒	☒	☒	N6-N8
374	Jam in mechanisms driven by 2nd Fold Motor	☒	☒	☒	N6-N8
375	Jam in mechanisms driven by JG Crease Motor	☒	☒	☒	N6-N8
398	Paper exit end is not responding	☒	☒		N1
399	Main instruction data defect	☒	☒		N1

5.Troubleshooting

Paper Size Code

Size Code	Paper Size	Size Code	Paper Size
005	A4 LEF	141	B4 SEF
006	A5 LEF	142	B5 SEF
014	B5 LEF	160	DLT SEF
038	LT LEF	164	LG SEF
044	HLT LEF	166	LT SEF
132	A3 SEF	172	HLT SEF
133	A4 SEF	255	Others
134	A5 SEF		

Troubleshooting for Transport/Paper Feeding of the Machine

Curled Paper

Make sure that the following SPs are set to their default values, and keep them at these values at all time.

- **SP1-113-001 (Curl Correction): Keep at default value of 0 (OFF)**
This is because printing productivity drops to about 65 to 80% when this SP is ON. It is not effective in reducing curl on these models.
- **SP1-115-xxx (Print Target Temp): Keep at default value.**
This is because fusing offset may occur when the fusing temperature is reduced. This SP is not effective for improving image quality on these models.

Solution:

Installing the tray heaters for the mainframe paper bank and optional paper banks. ([Dehumidification Heater for Paper Feed Trays](#))

Initial Jam

If the error occurs periodically, do the following steps. If the result is as shown in the "Problem Judgement" column, follow the solutions.

Initial Jam: Cause Code 001 / Location Code A

Target Part/SP No.: Transport Sensor (1st Feed Tray) (S13)/ SP5-803-003 (Transport Sensor 1)

Cause verification	Problem Judgement
Execute an INPUT check when there is no paper at the position of the referenced sensor.	0: Paper detected
Execute an INPUT check when there is paper at the position of the referenced sensor.	1: Paper not detected

Solution:

- Clean the sensor.
- Reconnect the connector.
- Replace the sensor.
- Replace the Paper Transport IOB (PCB1).
- Replace the harness.

Target Part/SP No.: Transport Sensor (2nd Feed Tray) (S23)/ SP5-803-005 (Transport Sensor 2)

Cause verification	Problem Judgement
Execute an INPUT check when there is no paper at the position of the	0: Paper detected

Cause verification	Problem Judgement
referenced sensor.	
Execute an INPUT check when there is paper at the position of the referenced sensor.	1: Paper not detected

Solution:

- Clean the sensor.
- Reconnect the connector.
- Replace the sensor.
- Replace the Paper Transport IOB (PCB1).
- Replace the harness.

Initial Jam: Cause Code 001 / Location Code B

Target Part/SP No.:Registration Sensor (S16) / SP5-803-001

Cause verification	Problem Judgement
Execute an INPUT check when there is no paper at the position of the referenced sensor.	0: Paper detected
Execute an INPUT check when there is paper at the position of the referenced sensor.	1: Paper not detected

Solution:

- Clean the sensor.
- Reconnect the connector.
- Replace the sensor.
- Replace the Paper Transport IOB (PCB1).
- Replace the harness.

Initial Jam: Cause Code 001 / Location Code C

Target Part/SP No.:Fusing Entrance Sensor (S1) / SP5-803-006

Cause verification	Problem Judgement
Execute an INPUT check when there is no paper at the position of the referenced sensor.	0: Paper detected
Execute an INPUT check when there is paper at the position of the referenced sensor.	1: Paper not detected

Solution:

- Clean the sensor.
- Reconnect the connector.
- Replace the sensor.
- Replace the Paper Transport IOB (PCB1).
- Replace the harness.

5.Troubleshooting

Target Part/SP No.:Fusing Exit Sensor (S27) / SP5-803-007

Cause verification	Problem Judgement
Execute an INPUT check when there is no paper at the position of the referenced sensor.	0: Paper detected
Execute an INPUT check when there is paper at the position of the referenced sensor.	1: Paper not detected

Solution:

- Clean the sensor.
- Reconnect the connector.
- Replace the sensor.
- Replace the Paper Transport IOB (PCB1).
- Replace the harness.

Target Part/SP No.: Paper Exit Sensor (S10) / SP5-803-008

Cause verification	Problem Judgement
Execute an INPUT check when there is no paper at the position of the referenced sensor.	0: Paper detected
Execute an INPUT check when there is paper at the position of the referenced sensor.	1: Paper not detected

Solution:

- Clean the sensor.
- Reconnect the connector.
- Replace the sensor.
- Replace the Paper Transport IOB (PCB1).
- Replace the harness.

Target Part/SP No.: Reverse Sensor (S9) / SP5-803-009 (Inverter Sensor)

Cause verification	Problem Judgement
Execute an INPUT check when there is no paper at the position of the referenced sensor.	0: Paper detected
Execute an INPUT check when there is paper at the position of the referenced sensor.	1: Paper not detected

Solution:

- Clean the sensor.
- Reconnect the connector.
- Replace the sensor.
- Replace the Paper Transport IOB (PCB1).
- Replace the harness.

Initial Jam: Cause Code 001 / Location Code Z

Target Part/SP No.: Duplex Entrance Sensor (S5) / SP5-803-011

Cause verification	Problem Judgement
Execute an INPUT check when there is no paper at the position of the referenced sensor.	0: Paper detected
Execute an INPUT check when there is paper at the position of the referenced sensor.	1: Paper not detected

Solution:

- Clean the sensor.
- Reconnect the connector.
- Replace the sensor.
- Replace the Paper Transport IOB (PCB1).
- Replace the harness.

Target Part/SP No.: Duplex Exit Sensor (S3) / SP5-803-010

Cause verification	Problem Judgement
Execute an INPUT check when there is no paper at the position of the referenced sensor.	0: Paper detected
Execute an INPUT check when there is paper at the position of the referenced sensor.	1: Paper not detected

Solution:

- Clean the sensor.
- Reconnect the connector.
- Replace the sensor.
- Replace the Paper Transport IOB (PCB1).
- Replace the harness.

Jam

If the error occurs periodically, do the following steps. If the result is as shown in the "Problem Judgement" column, follow the solutions.

1st Feed Tray No Feeding: Late Jam : Cause Code 003

Target Part/SP No.:Limit Sensor (1st Feed Tray) (S15) / SP5-803-014 (Tray 1: Upper Limit Sensor)

Cause verification	Problem Judgement
Execute an INPUT check when there is no paper at the position of the referenced sensor.	1: Limit

5.Troubleshooting

Cause verification	Problem Judgement
Execute an INPUT check when there is paper at the position of the referenced sensor.	0: Not limit

Solution:

- Clean the sensor.
- Reconnect the connector.
- Replace the sensor.
- Replace the Paper Transport IOB (PCB1).
- Replace the harness.

Target Part/SP No.:Paper End Sensor (1st Feed Tray) (S12) / SP5-803-015 (Tray 1: Paper End Detection)

Cause verification	Problem Judgement
Execute an INPUT check when there is no paper at the position of the referenced sensor.	1: Paper detected
Execute an INPUT check when there is paper at the position of the referenced sensor.	0: Paper not detected

Solution:

- Clean the sensor.
- Reconnect the connector.
- Replace the sensor.
- Replace the Paper Transport IOB (PCB1).
- Replace the harness.

Target Part/SP No.: Tray Set Switch (1st Feed Tray) (S19) / SP 5-803-016 (Tray 1: Set Sensor)

Cause verification	Problem Judgement
Manually press the referenced switch (Done after removing paper feed tray 1 from the machine.)	1: Not set
Pull out paper feed tray 1 from the machine	0: Set

Solution:

- Clean the sensor.
- Reconnect the connector.
- Replace the sensor.
- Replace the Paper Transport IOB (PCB1).
- Replace the harness.

Target Part/SP No.: Paper Feed Sensor (1st Feed Tray) (S12) / SP5-803-002 (Paper Feed

Sensor 1)

Cause verification	Problem Judgement
Execute an INPUT check when there is no paper at the position of the referenced sensor.	0: Paper detected
Execute an INPUT check when there is paper at the position of the referenced sensor.	1: Paper not detected

Solution:

- Clean the sensor.
- Reconnect the connector.
- Replace the sensor.
- Replace the Paper Transport IOB (PCB1).
- Replace the harness.

Target Part/SP No.:Paper Feed Motor (M6) / SP5-804-016 (Feed Motor: CW:Standard Speed)

Cause verification	Problem Judgement
Turn the referenced motor OFF with OUTPUT check	Drive sound heard
Turn the referenced motor ON with OUTPUT check	Drive sound not heard

Solution:

- Reconnect the connector.
- Replace the motor.
- Replace the Paper Transport IOB (PCB1).
- Replace the harness.

Checking Paper Status, Pick-up Roller, Feed Roller, and Friction Roller for 1st Feed Tray

Check the paper position (Check whether or not the leading edge of the paper, side paper guide, and end paper guide are positioned according to the manual.)	<ul style="list-style-type: none"> • Check the paper orientation. • Turn the paper in the feed tray upside down.
Check if the paper has reached the maximum stackable limit of the side paper guide.	Reduce the paper to below the stackable limit.
Check if the sheets are stuck to each other due to edge roughness, coating, stain, or temperature.	Fan the paper.
Check if extra thin paper or thick paper exceeding the supported paper thickness is being used.	Use supported paper types.
Check if the paper thickness and size are detected correctly.	Set the paper thickness and size to the correct value.
Check if the paper being used produces a lot of paper dust.	Change the paper type (if possible).
Check if the paper feed tray is not stained with paper dust.	Clean the paper feed tray.
Check if the paper roller is not stained with paper dust.	Clean the pick-up roller, feed

5.Troubleshooting

	roller, and friction roller for 1st feed tray.
--	--

2nd Feed Tray No Feeding: Late Jam : Cause Code 004

Target Part/SP No.:Limit Sensor (2nd Feed Tray) (S25) / SP5-803-018 (Tray 2: Upper Limit Sensor)

Cause verification	Problem Judgement
Execute an INPUT check when there is no paper at the position of the referenced sensor.	1: limit
Execute an INPUT check when there is paper at the position of the referenced sensor.	0: Not limit

Solution:

- Clean the sensor.
- Reconnect the connector.
- Replace the sensor.
- Replace the Paper Transport IOB (PCB1).
- Replace the harness.

Target Part/SP No.:Paper End Sensor (2nd Feed Tray) (S24) / SP5-803-019 (Tray 2: Paper End Detection)

Cause verification	Problem Judgement
Execute an INPUT check when there is no paper at the position of the referenced sensor.	1: Paper detected
Execute an INPUT check when there is paper at the position of the referenced sensor.	0: Paper not detected

Solution:

- Clean the sensor.
- Reconnect the connector.
- Replace the sensor.
- Replace the Paper Transport IOB (PCB1).
- Replace the harness.

Target Part/SP No.:Tray Set Switch (2nd Feed Tray) (S21) / SP 5-803-020 (Tray 2: Set Sensor)

Cause verification	Problem Judgement
Manually press the referenced switch (Done after removing paper feed tray 2 from the machine.)	1: Not set
Pull out the paper feed tray 2 from the machine.	0: Set

Solution:

- Clean the sensor.
- Reconnect the connector.
- Replace the sensor.
- Replace the Paper Transport IOB (PCB1).
- Replace the harness.

Target Part/SP No.:Paper Feed Sensor (2nd Feed Tray) (S22) / SP5-803-004 (Paper Feed Sensor 2)

Cause verification	Problem Judgement
Execute an INPUT check when there is no paper at the position of the referenced sensor.	0: Paper detected
Execute an INPUT check when there is paper at the position of the referenced sensor.	1: Paper not detected

Solution:

- Clean the sensor.
- Reconnect the connector.
- Replace the sensor.
- Replace the Paper Transport IOB (PCB1).
- Replace the harness.

Target Part/SP No.:Paper Feed Motor (M6) / SP5-804-016 (Feed Motor: CW: Standard Speed)

Cause verification	Problem Judgement
Turn the referenced motor OFF with OUTPUT check	Drive sound heard
Turn the referenced motor ON with OUTPUT check	Drive sound not heard

Solution:

- Reconnect the connector.
- Replace the motor.
- Replace the Paper Transport IOB (PCB1).
- Replace the harness.

Checking Paper Status, Pick-up Roller, Feed Roller, and Friction Roller for 1st Feed Tray

Check the paper position (Check whether or not the leading edge of the paper, side paper guide, and end paper guide are positioned according to the manual.)	<ul style="list-style-type: none"> • Check the paper orientation. • Turn the paper in the feed tray upside down.
Check if the paper has reached the maximum stackable limit of the side paper guide.	Reduce the paper to below the stackable limit.
Check if the sheets are stuck to each other due to edge roughness, coating, stain, or temperature.	Fan the paper
Check if extra thin paper or thick paper exceeding the supported	Use supported paper types.

5.Troubleshooting

paper thickness is being used.	
Check if the paper thickness and size are detected correctly.	Set the paper thickness and size to the correct value.
Check if the paper being used produces a lot of paper dust.	Change the paper type (if possible).
Check if the paper roller is not stained with paper dust.	Clean the pick-up roller, feed roller, and friction roller for 1st feed tray.

Transport Sensor (1st Feed Tray) (S13) : Late Jam : Cause Code 011

Target Part/SP No.:Transport Sensor (1st Feed Tray) (S13) / SP5-803-003 (Transport Sensor 1)

Cause verification	Problem Judgement
Execute an INPUT check when there is no paper at the position of the referenced sensor.	0: Paper detected
Execute an INPUT check when there is paper at the position of the referenced sensor.	1: Paper not detected

Solution:

- Clean the sensor.
- Reconnect the connector.
- Replace the sensor.
- Replace the Paper Transport IOB (PCB1).
- Replace the harness.

Target Part/SP No.:Paper Feed Sensor (1st Feed Tray) (S12) / SP5-803-002 (Paper Feed Sensor1)

Cause verification	Problem Judgement
Execute an INPUT check when there is no paper at the position of the referenced sensor.	1: Paper detected
Execute an INPUT check when there is paper at the position of the referenced sensor.	0: Paper not detected

Solution:

- Clean the sensor.
- Reconnect the connector.
- Replace the sensor.
- Replace the Paper Transport IOB (PCB1).
- Replace the harness.

Target Part/SP No.:Bypass Pick-up Solenoid (SOL1) / SP5-803-016 (Bypass Pick-up

Solenoid)

Cause verification	Problem Judgement
Turn the referenced solenoid OFF with OUTPUT check	Drive sound heard
Turn the referenced solenoid ON with OUTPUT check	Drive sound not heard

Solution:

- Reconnect the connector.
- Replace the solenoid.
- Replace the Paper Transport IOB (PCB1).
- Replace the harness.

Checking Paper Status, Pick-up Roller, Feed Roller, and Friction Roller for 1st Feed Tray

Check the paper position (Check whether or not the leading edge of the paper, side paper guide, and end paper guide are positioned according to the manual.)	<ul style="list-style-type: none"> • Check the paper orientation. • Turn the paper in the feed tray upside down.
Check if the paper has reached the maximum stackable limit of the side paper guide.	Reduce the paper to below the stackable limit.
Check if the sheets are stuck to each other due to edge roughness, coating, stain, or temperature.	Fan the paper
Check if extra thin paper or thick paper exceeding the supported paper thickness is being used.	Use a supported paper type.
Check if the paper thickness and size are detected correctly.	Set the paper thickness and size to the correct value.
Check if the paper being used produces a lot of paper dust.	Change the paper type (if possible).
Check if the paper roller is not stained with paper dust.	Clean the pick-up roller, feed roller, and friction roller for 1st feed tray.

Transport Sensor (2nd Feed Tray) (S23): Late Jam : Cause Code 012

Target Part/SP No.:Transport Sensor (2nd Feed Tray) (S23) / SP5-803-005 (Transport Sensor 2)

Cause verification	Problem Judgement
Execute an INPUT check when there is no paper at the position of the referenced sensor.	0 :Paper detected
Execute an INPUT check when there is paper at the position of the referenced sensor.	1: Paper not detected

Solution:

- Clean the sensor.

5.Troubleshooting

- Reconnect the connector.
- Replace the sensor.
- Replace the Paper Transport IOB (PCB1).
- Replace the harness.

Target Part/SP No.:Paper Feed Sensor (2nd Feed Tray) (S22) / SP5-803-004 (Paper Feed Sensor 2)

Cause verification	Problem Judgement
Execute an INPUT check when there is no paper at the position of the referenced sensor.	1 Paper detected
Execute an INPUT check when there is paper at the position of the referenced sensor.	0: Paper not detected

Solution:

- Clean the sensor.
- Reconnect the connector.
- Replace the sensor.
- Replace the Paper Transport IOB (PCB1).
- Replace the harness.

Checking Paper Status, Pick-up Roller, Feed Roller, and Friction Roller for 2nd Feed Tray

Check the paper position (Check whether or not the leading edge of the paper, side paper guide, and end paper guide are positioned according to the manual.)	<ul style="list-style-type: none"> • Check the paper orientation. • Turn the paper in the feed tray upside down.
Check if the paper has reached the maximum stackable limit of the side paper guide.	Reduce the paper to below the stackable limit.
Check if the sheets are stuck to each other due to edge roughness, coating, stain, or temperature.	Fan the paper.
Check if extra thin paper or thick paper exceeding the supported paper thickness is being used.	Use a supported paper type.
Check if the paper thickness and size are detected correctly.	Set the paper thickness and size to the correct value.
Check if the paper being used produces a lot of paper dust.	Change the paper type (if possible).
Check if the paper roller is not stained with paper dust.	Clean the pick-up roller, feed roller, and friction roller for 2nd feed tray.

Registration Sensor (S16): Late Jam : Cause Code 017

Target Part/SP No.:Registration Sensor (S16) / SP5-803-001

Cause verification	Problem Judgement
Execute an INPUT check when there is no paper at the position of the referenced sensor.	0 :Paper detected
Execute an INPUT check when there is paper at the position of the referenced sensor.	1: Paper not detected

Solution:

- Clean the sensor.
- Reconnect the connector.
- Replace the sensor.
- Replace the Paper Transport IOB (PCB1).
- Replace the harness.

Checking Paper Status, or Transport Sensor (1st feed tray) (S13)

Check if extra thin paper or thick paper exceeding the supported paper thickness is being used.	Use a supported paper type.
Check if the paper thickness and size are detected correctly.	Set the paper thickness and size to the correct value.
Check if the paper feed tray is not stained with a lot of paper dust.	Clean the 1st transport roller.

Fusing Entrance Sensor (S1): Late Jam : Cause Code 018

Target Part/SP No.:Fusing Entrance Sensor (S1) / SP5-803-001

Cause verification	Problem Judgement
Execute an INPUT check when there is no paper at the position of the referenced sensor.	0 :Paper detected
Execute an INPUT check when there is paper at the position of the referenced sensor.	1: Paper not detected

Solution:

- Clean the sensor.
- Reconnect the connector.
- Replace the sensor.
- Replace the Paper Transport IOB (PCB1).
- Replace the harness.

Target Part/SP No.: PCU: Black / Image Transfer Motor (M17) / SP5-804-136 (Transfer Drum

5.Troubleshooting

Motor K: Standard Speed)

Cause verification	Problem Judgement
Turn the referenced motor OFF with OUTPUT check	Drive sound heard
Turn the referenced motor ON with OUTPUT check	Drive sound not heard

Solution:

- Reconnect the connector.
- Replace the motor.
- Replace the Imaging IOB (PCB2).
- Replace the harness.

Checking Paper Jam, or Paper Transfer Unit

Check if there is no double feeding.	Fan the paper.
Check the edges of the discharge plate to see if it is deformed or broken.	Reattach or replace the discharge plate.

Paper Exit Sensor (S10): Late Jam : Cause Code 020

Target Part/SP No.: Paper Exit Sensor (S10) / SP5-803-008

Cause verification	Problem Judgement
Execute an INPUT check when there is no paper at the position of the referenced sensor.	0 :Paper detected
Execute an INPUT check when there is paper at the position of the referenced sensor.	1: Paper not detected

Solution:

- Clean the sensor.
- Reconnect the connector.
- Replace the sensor.
- Replace the Paper Transport IOB (PCB1).
- Replace the harness

Target Part/SP No.: Paper Exit Solenoid (SOL2) / SP5-804-004 (Exit Junction Solenoid)

Cause verification	Problem Judgement
Turn the referenced solenoid OFF with OUTPUT check	Drive sound heard
Turn the referenced solenoid ON with OUTPUT check	Drive sound not heard

Solution:

- Reconnect the connector.
- Replace the solenoid.
- Replace the Paper Transport IOB (PCB1).
- Replace the harness.

Checking Paper Jam, or Paper Status

Check if the leading edge of the paper and the paper feed guide are wet.	If condensation has occurred inside the machine, leave the machine idle for a few minutes to remove condensation.
Check if the paper is curled too much.	If the paper is curled too much, switch on the anti-condensation heater for paper tray.
Check if extra thin paper or thick paper exceeding the supported paper thickness is being used.	Use a supported paper type.
Check if the paper thickness and size are detected correctly.	Set the paper thickness and size to the correct value.

Transport Sensor (1st Feed Tray) (S13): Lag Jam : Cause Code 051

Target Part/SP No.:Transport Sensor (1st Feed Tray) (S13) / SP5-803-003 (Transport Sensor 1)

Cause verification	Problem Judgement
Execute an INPUT check when there is no paper at the position of the referenced sensor.	0 :Paper detected
Execute an INPUT check when there is paper at the position of the referenced sensor.	1: Paper not detected

Solution:

- Clean the sensor.
- Reconnect the connector.
- Replace the sensor.
- Replace the Paper Transport IOB (PCB1).
- Replace the harness.

Target Part/SP No.:Paper Feed Motor (M6) / SP5-804-016 (Feed Motor: CW: Standard Speed)

Cause verification	Problem Judgement
Turn the referenced motor OFF with OUTPUT check	Drive sound heard
Turn the referenced motor ON with OUTPUT check	Drive sound not heard

Solution:

- Reconnect the connector.
- Replace the motor.
- Replace the Paper Transport IOB (PCB1).
- Replace the harness.

5.Troubleshooting

Target Part/SP No.:Bypass V-Transport Motor / SP5-804-028

Cause verification	Problem Judgement
Turn the referenced motor OFF with OUTPUT check	Drive sound heard
Turn the referenced motor ON with OUTPUT check	Drive sound not heard

Solution:

- Reconnect the connector.
- Replace the motor.
- Replace the Paper Transport IOB (PCB1).
- Replace the harness.

Target Part/SP No.:Reverse Motor (M3) / SP5-804-047 (Inverter Motor: CW: Standard Speed)

Cause verification	Problem Judgement
Turn the referenced motor OFF with OUTPUT check	Drive sound heard
Turn the referenced motor ON with OUTPUT check	Drive sound not heard

Solution:

- Reconnect the connector.
- Replace the motor.
- Replace the Paper Transport IOB (PCB1).
- Replace the harness.

Target Part/SP No.:Bypass Original Length Sensor / SP5-803-024 (By-pass: Sub Scan Length Sensor)

Cause verification	Problem Judgement
Execute an INPUT check when there is no paper at the position of the referenced sensor.	1: Paper detected
Execute an INPUT check when there is paper at the position of the referenced sensor.	0: Paper not detected

Solution:

- Clean the sensor.
- Reconnect the connector.
- Replace the sensor.
- Replace the Paper Transport IOB (PCB1).
- Replace the harness.

Checking Paper Jam, or Paper Status

Check the paper position (Check whether or not the leading edge of the paper, side paper guide, and end paper guide are positioned according to the manual.)	<ul style="list-style-type: none"> • Check the paper orientation. • Turn the paper in the feed tray upside down.
Check if the paper has reached the maximum stackable limit of	Reduce the paper to below the

the side paper guide.	stackable limit.
Check if extra thin paper or thick paper exceeding the supported paper thickness is being used.	Use a supported paper type.
Check if the paper thickness and size are detected correctly.	Set the paper thickness and size to the correct value.
Check if the paper being used produces a lot of paper dust.	Change the paper type (if possible).
Check if there is no double feeding.	Fan the paper.
Check if the paper feed tray is not stained with a lot of paper dust.	Clean the paper feed tray.
Check if the paper roller is not stained with paper dust.	Clean the pick-up roller, feed roller, and friction roller for 1st feed tray.

Transport Sensor (2nd Feed Tray) (S23): Lag Jam: Cause Code 052

Target Part/SP No.:Transport Sensor (2nd Feed Tray) (S23)/ SP5-803-005 (Transport Sensor 2)

Cause verification	Problem Judgement
Execute an INPUT check when there is no paper at the position of the referenced sensor.	0 :Paper detected
Execute an INPUT check when there is paper at the position of the referenced sensor.	1: Paper not detected

Solution:

- Clean the sensor.
- Reconnect the connector.
- Replace the sensor.
- Replace the Paper Transport IOB (PCB1).
- Replace the harness.

Target Part/SP No.: Paper Feed Motor (M6) / SP5-804-016 (Feed Motor:CW:Standard Speed)

Cause Verification	Problem Judgement
Turn the referenced motor OFF with OUTPUT check	Drive sound heard
Turn the referenced motor ON with OUTPUT check	Drive sound not heard

Solution:

- Clean the sensor.
- Reconnect the connector.
- Replace the sensor.
- Replace the Paper Transport IOB (PCB1).
- Replace the harness.

5.Troubleshooting

Target Part/SP No.:Transport Motor (M5) / SP5-804-028 (Bypass V-Transport Motor)

Cause verification	Problem Judgement
Turn the referenced motor OFF with OUTPUT check	Drive sound heard
Turn the referenced motor ON with OUTPUT check	Drive sound not heard

Solution:

- Reconnect the connector.
- Replace the motor.
- Replace the Paper Transport IOB (PCB1).
- Replace the harness.

Checking Paper Jam, or Paper Status

Check the paper position (Check whether or not the leading edge of the paper, side paper guide, and end paper guide are positioned according to the manual.)	<ul style="list-style-type: none"> • Check the paper orientation. • Turn the paper in the feed tray upside down.
Check if the paper has reached the maximum stackable limit of the side paper guide.	Reduce the paper to below the stackable limit.
Check if extra thin paper or thick paper exceeding the supported paper thickness is being used.	Use a supported paper type.
Check if the paper thickness and size are detected correctly.	Set the paper thickness and size to the correct value.
Check if the paper being used produces a lot of paper dust.	Change the paper type (if possible).
Check if there is no double feeding.	Fan the paper.
Check if the paper feed tray is not stained with a lot of paper dust.	Clean the paper feed tray.
Check if the paper roller is not stained with paper dust.	Clean the pick-up roller, feed roller, and friction roller for 2nd feed tray.

Registration Sensor (S16): Lag Jam: Cause Code 057

Target Part/SP No.:Registration Sensor (S16) / SP5-803-001

Cause verification	Problem Judgement
Execute an INPUT check when there is no paper at the position of the referenced sensor.	0 :Paper detected
Execute an INPUT check when there is paper at the position of the referenced sensor.	1: Paper not detected

Solution:

- Clean the sensor.
- Reconnect the connector.

- Replace the sensor.
- Replace the Paper Transport IOB (PCB1).
- Replace the harness.

Target Part/SP No.:Bypass/Duplex Motor (M2) / SP5-804-071 (Duplex Bypass Motor: CW: Standard Speed)

Cause verification	Problem Judgement
Turn the referenced motor OFF with OUTPUT check	Drive sound heard
Turn the referenced motor ON with OUTPUT check	Drive sound not heard

Solution:

- Reconnect the connector.
- Replace the motor.
- Replace the Paper Transport IOB (PCB1).
- Replace the harness.

Target Part/SP No.:Reverse Motor (M3) / SP5-804-047 (Inverter Motor: CW: Standard Speed)

Cause verification	Problem Judgement
Turn the referenced motor OFF with OUTPUT check	Drive sound heard
Turn the referenced motor ON with OUTPUT check	Drive sound not heard

Solution:

- Reconnect the connector.
- Replace the motor.
- Replace the Paper Transport IOB (PCB1).
- Replace the harness.

Checking Paper Jam, or Paper Status

Check if there is no double feeding.	Fan the paper.
--------------------------------------	----------------

Paper Exit Sensor (S10): Lag Jam: Cause Code 060

Target Part/SP No.: Paper Exit Sensor (S10) / SP5-803-008

Cause verification	Problem Judgement
Execute an INPUT check when there is no paper at the position of the referenced sensor.	0 :Paper detected
Execute an INPUT check when there is paper at the position of the referenced sensor.	1: Paper not detected

Solution:

- Clean the sensor.
- Reconnect the connector.
- Replace the sensor.
- Replace the Paper Transport IOB (PCB1).

5.Troubleshooting

- Replace the harness.

Checking Paper Jam, or Paper Status

Check if the leading edge of the paper and the paper feed guide are wet.	If condensation has occurred inside the machine, leave the machine idle for a few minutes to remove condensation.
Check if there is no double feeding.	Fan the paper.
Check if the paper is curled too much.	If the paper is curled too much, switch on the anti-condensation heater for paper tray.
Check if extra thin paper or thick paper exceeding the supported paper thickness is being used.	Use a supported paper type.
Check if the paper thickness and size are detected correctly.	Set the paper thickness and size to the correct value.

Reverse Sensor (S9): Late Jam: Cause Code 024

Target Part/SP No.:Reverse Sensor (S9)/ SP5-803-009 (Inverter Sensor)

Cause verification	Problem Judgement
Execute an INPUT check when there is no paper at the position of the referenced sensor.	0 :Paper detected
Execute an INPUT check when there is paper at the position of the referenced sensor.	1: Paper not detected

Solution:

- Clean the sensor.
- Reconnect the connector.
- Replace the sensor.
- Replace the Paper Transport IOB (PCB1).
- Replace the harness.

Target Part/SP No.: Reverse Motor (M3)/ SP5-804-047 (Inverter Motor: CW:Standard Speed)

Cause verification	Problem Judgement
Turn the referenced motor OFF with OUTPUT check	Drive sound heard
Turn the referenced motor ON with OUTPUT check	Drive sound not heard

Solution:

- Reconnect the connector.
- Replace the motor.
- Replace the Paper Transport IOB (PCB1).
- Replace the harness.

Target Part/SP No.:Paper Exit Solenoid (SOL2)/ SP5-804-004 (Exit Junction Solenoid)

Cause verification	Problem Judgement
Turn the referenced solenoid OFF with OUTPUT check	Drive sound heard
Turn the referenced solenoid ON with OUTPUT check	Drive sound not heard

Solution:

- Reconnect the connector.
- Replace the solenoid.
- Replace the Paper Transport IOB (PCB1).
- Replace the harness.

Checking Paper Jam, or Paper Status

Check if the leading edge of the paper and the paper feed guide are wet.	If condensation has occurred inside the machine, leave the machine idle for a few minutes to remove condensation.
Check if there is no double feeding.	Fan the paper.
Check if the paper is curled too much.	If the paper is curled too much, switch on the anti-condensation heater for paper tray.
Check if extra thin paper or thick paper exceeding the supported paper thickness is being used.	Use a supported paper type.
Check if the paper thickness and size are detected correctly.	Set the paper thickness and size to the correct value.

Reverse Sensor (S9): Lag Jam : Cause Code 064

Target Part/SP No.:Reverse Sensor (S9) / SP5-803-009 (Inverter Sensor)

Cause verification	Problem Judgement
Execute an INPUT check when there is no paper at the position of the referenced sensor.	0 :Paper detected
Execute an INPUT check when there is paper at the position of the referenced sensor.	1: Paper not detected

Solution:

- Clean the sensor.
- Reconnect the connector.
- Replace the sensor.
- Replace the Paper Transport IOB (PCB1).
- Replace the harness.

Target Part/SP No.:Duplex Entrance Motor (M1) / SP5-804-065 (Duplex Entrance

5.Troubleshooting

Motor: CW: Standard Speed)

Cause verification	Problem Judgement
Turn the referenced motor OFF with OUTPUT check	Drive sound heard
Turn the referenced motor ON with OUTPUT check	Drive sound not heard

Solution:

- Clean the sensor.
- Reconnect the connector.
- Replace the sensor.
- Replace the Paper Transport IOB (PCB1).
- Replace the harness.

Checking Paper Jam, or Paper Status

Check if the leading edge of the paper and the paper feed guide are wet.	If condensation has occurred inside the machine, leave the machine idle for a few minutes to remove condensation.
Check if there is no double feeding.	Fan the paper.
Check if the paper is curled too much.	If the paper is curled too much, switch on the anti-condensation heater for paper tray.
Check if extra thin paper or thick paper exceeding the supported paper thickness is being used.	Use a supported paper type.
Check if the paper thickness and size are detected correctly.	Set the paper thickness and size to the correct value.

Duplex Exit Sensor (S3): Late Jam: Cause Code 025

Target Part/SP No.: Duplex Exit Sensor (S3) / SP5-803-010

Cause verification	Problem Judgement
Execute an INPUT check when there is no paper at the position of the referenced sensor.	0 :Paper detected
Execute an INPUT check when there is paper at the position of the referenced sensor.	1: Paper not detected

Solution:

- Clean the sensor.
- Reconnect the connector.
- Replace the sensor.
- Replace the Paper Transport IOB (PCB1).
- Replace the harness.

Target Part/SP No.: Bypass/Duplex Motor (M2) / SP5-804-071 (Duplex Bypass

Motor: CW: Standard Speed)

Cause verification	Problem Judgement
Turn the referenced motor OFF with OUTPUT check	Drive sound heard
Turn the referenced motor ON with OUTPUT check	Drive sound not heard

Solution:

- Reconnect the connector.
- Replace the motor.
- Replace the Paper Transport IOB (PCB1).
- Replace the harness.

Checking Paper Jam, or Paper Status

Check if there is no double feeding.	Fan the paper.
Check if the paper is curled too much.	If the paper is curled too much, switch on the anti-condensation heater for paper tray.
Check if extra thin paper or thick paper exceeding the supported paper thickness is being used.	Use a supported paper type.
Check if the paper thickness and size are detected correctly.	Set the paper thickness and size to the correct value.

Duplex Exit Sensor (S3): Lag Jam: Cause Code 065

Target Part/SP No.: Duplex Exit Sensor (S3) / SP5-803-010

Cause verification	Problem Judgement
Execute an INPUT check when there is no paper at the position of the referenced sensor.	0 :Paper detected
Execute an INPUT check when there is paper at the position of the referenced sensor.	1: Paper not detected

Solution:

- Clean the sensor.
- Reconnect the connector.
- Replace the sensor.
- Replace the Paper Transport IOB (PCB1).
- Replace the harness.

Checking Paper Jam, or Paper Status

Check if there is no double feeding.	Fan the paper.
Check if the paper is curled too much.	If the paper is curled too much, switch on the anti-condensation heater for paper tray.
Check if extra thin paper or thick paper exceeding the supported paper thickness is being used.	Use a supported paper type.

5.Troubleshooting

Check if the paper thickness and size are detected correctly.	Set the paper thickness and size to the correct value.
---	--

Duplex Entrance Sensor (S5): Late Jam: Cause Code 027

Target Part/SP No.:Duplex Entrance Sensor (S5) / SP5-803-011

Cause verification	Problem Judgement
Execute an INPUT check when there is no paper at the position of the referenced sensor.	0 :Paper detected
Execute an INPUT check when there is paper at the position of the referenced sensor.	1: Paper not detected

Solution:

- Clean the sensor.
- Reconnect the connector.
- Replace the sensor.
- Replace the Paper Transport IOB (PCB1).
- Replace the harness.

Target Part/SP No.:Duplex Entrance Motor (M1) / SP5-804-065 (Duplex Entrance Motor: CW: Standard Speed)

Cause verification	Problem Judgement
Turn the referenced motor OFF with OUTPUT check	Drive sound heard
Turn the referenced motor ON with OUTPUT check	Drive sound not heard

Solution:

- Clean the sensor.
- Reconnect the connector.
- Replace the sensor.
- Replace the Paper Transport IOB (PCB1).
- Replace the harness.

Target Part/SP No.:Paper Exit Solenoid (SOL2) / SP5-804-004 (Exit Junction Solenoid)

Cause verification	Problem Judgement
Turn the referenced solenoid OFF with OUTPUT check	Drive sound heard

Solution:

- Reconnect the connector.
- Replace the solenoid.
- Replace the Paper Transport IOB (PCB1).
- Replace the harness.

Checking Paper Jam, or Paper Status

Check if there is no double feeding.	Fan the paper.
Check if the paper is curled too much.	If the paper is curled too much, switch on the anti-condensation heater for paper tray.
Check if extra thin paper or thick paper exceeding the supported paper thickness is being used.	Use a supported paper type.
Check if the paper thickness and size are detected correctly.	Set the paper thickness and size to the correct value.

Duplex Entrance Sensor (S5): Lag Jam: Cause Code 067

Target Part/SP No.:Duplex Entrance Sensor (S5) / SP5-803-011

Cause verification	Problem Judgement
Execute an INPUT check when there is no paper at the position of the referenced sensor.	0 :Paper detected
Execute an INPUT check when there is paper at the position of the referenced sensor.	1: Paper not detected

Solution:

- Clean the sensor.
- Reconnect the connector.
- Replace the sensor.
- Replace the Paper Transport IOB (PCB1).
- Replace the harness.

Target Part/SP No.:Duplex Entrance Motor (M1) / SP5-804-065 (Duplex Entrance Motor: CW: Standard Speed)

Cause verification	Problem Judgement
Turn the referenced motor OFF with OUTPUT check	Drive sound heard
Turn the referenced motor ON with OUTPUT check	Drive sound not heard

Solution:

- Reconnect the connector.
- Replace the sensor.
- Replace the Paper Transport IOB (PCB1).
- Replace the harness.

Target Part/SP No.:Bypass/Duplex Motor (M2) / SP5-804-071 (Duplex Bypass Motor: CW: Standard Speed)

Cause verification	Problem Judgement
Turn the referenced motor OFF with OUTPUT check	Drive sound heard
Turn the referenced motor ON with OUTPUT check	Drive sound not heard

5.Troubleshooting

Solution:

- Reconnect the connector.
- Replace the sensor.
- Replace the Paper Transport IOB (PCB1).
- Replace the harness.

Checking Paper Jam, or Paper Status

Check if there is no double feeding.	Fan the paper.
Check if the paper is curled too much.	If the paper is curled too much, switch on the anti-condensation heater for paper tray.
Check if extra thin paper or thick paper exceeding the supported paper thickness is being used.	Use a supported paper type.
Check if the paper thickness and size are detected correctly.	Set the paper thickness and size to the correct value.

Duplex No Feeding: Cause Code 009

Target Part/SP No.:Registration Sensor (S16) / SP5-803-001 (Registration Sensor)

Cause verification	Problem Judgement
Execute an INPUT check when there is no paper at the position of the referenced sensor.	0 :Paper detected
Execute an INPUT check when there is paper at the position of the referenced sensor.	1: Paper not detected

Solution:

- Clean the sensor.
- Reconnect the connector.
- Replace the sensor.
- Replace the Paper Transport IOB (PCB1).
- Replace the harness.

Checking Paper Jam, or Paper Status

Check if there is no double feeding.	Fan the paper.
Check if the paper is curled too much.	If the paper is curled too much, switch on the anti-condensation heater for the paper tray.
Check if extra thin paper or thick paper exceeding the supported paper thickness is being used.	Use a supported paper type.
Check if the paper thickness and size are detected correctly	Set the paper thickness and size to the correct value.

Bypass Transport Sensor 1: Lag Jam: Cause Code 048

Target Part/SP No.:Transport Sensor (1st Feed Tray) (S13) / SP5-803-003 (Transport Sensor 1)

Cause verification	Problem Judgement
Execute an INPUT check when there is no paper at the position of the referenced sensor.	0 :Paper detected
Execute an INPUT check when there is paper at the position of the referenced sensor.	1: Paper not detected

Solution:

- Clean the sensor.
- Reconnect the connector.
- Replace the sensor.
- Replace the Paper Transport IOB (PCB1).
- Replace the harness.

Target Part/SP No.: Transport Motor (M5) / SP5-804-028 (Bypass V-Transport Motor: CW: Std Speed)

Cause verification	Problem Judgement
Turn the referenced motor OFF with OUTPUT check	Drive sound heard
Turn the referenced motor ON with OUTPUT check	Drive sound not heard

Solution:

- Reconnect the connector.
- Replace the motor.
- Replace the Paper Transport IOB (PCB1).
- Replace the harness.

Display Error

"No paper in Tray 1" is displayed even when the paper is in

Target Part/SP No.:Paper End Sensor (1st Feed Tray) (S14) / SP5-803-015 (Tray 1: Paper End Detection)

Cause verification	Problem Judgement
Execute an INPUT check when there is no paper at the position of the referenced sensor.	1: Paper detected
Execute an INPUT check when there is paper at the position of the referenced sensor.	0: Paper not detected

Solution:

5.Troubleshooting

- Reconnect the connector.
- Replace the sensor.
- Replace the Paper Transport IOB (PCB1).
- Replace the harness.

Feeler for Paper End Sensor (S14)

Cause verification	Problem Judgement
Check if the feeler for 1st paper end sensor is unfastened.	Feeler is unfastened.

Solution:

- Reinstall the feeler.
- Check if there are any defects in the 1st paper feed unit.

"No paper in Tray 2" is displayed even when the paper is in

Target Part/SP No.:Paper End Sensor (2nd Feed Tray) (S24)/ SP5-803-019 (Tray 2: Paper End Detection)

Cause verification	Problem Judgement
Execute an INPUT check when there is no paper at the position of the referenced sensor.	1: Paper detected
Execute an INPUT check when there is paper at the position of the referenced sensor.	0: Paper not detected

Solution:

- Reconnect the connector.
- Replace the sensor.
- Replace the Paper Transport IOB (PCB1).
- Replace the harness.

Feeler for Paper End Sensor (2nd Feed Tray) (S24)

Cause verification	Problem Judgement
Check if the feeler for 2nd paper end sensor is unfastened.	Feeler is unfastened.

Solution:

- Reinstall the feeler.
- Check if there are any defects in the 2nd paper feed unit.

"Tray 1 not set" is displayed even when the tray is set

Target Part/SP No.:Tray Set Switch (1st Feed Tray) (S19) / SP5-803-016 (Tray 1: Set Sensor)

Cause verification	Problem Judgement
Manually press the referenced switch (Done after detaching paper feeding tray 1 from the machine.)	1: Not set

Cause verification	Problem Judgement
Pull out paper feed tray 1 from the machine.	0: Set

Solution:

- Reconnect the connector.
- Replace the sensor.
- Replace the Paper Transport IOB (PCB1).
- Replace the harness.

1st Paper Feed Tray

Replace the 1st paper feed tray.	Replace the 1st paper feed tray.
----------------------------------	----------------------------------

"Tray 2 not set" is displayed even when the tray is set

Target Part/SP No.:Tray Set Switch (2nd Feed Tray) (S21) / SP5-803-020 (Tray 2: Set Sensor)

Cause verification	Problem Judgement
Manually press the referenced switch (Done after detaching paper feeding tray 2 from the machine.)	1: Not set
Pull out paper feed tray 2 from the machine.	0: Set

Solution:

- Reconnect the connector.
- Replace the sensor.
- Replace the Paper Transport IOB (PCB1).
- Replace the harness.

2nd Paper Feed Tray

Check the 2nd tray set sensor to see if there are any defects.	Replace the 2nd paper feed tray.
--	----------------------------------

Wrong paper size displayed on the operation panel

Target Part/SP No.:Size Switch (2nd Feed Tray) / SP5-803-021 (Tray 2: Size Sensor)

Cause verification	Problem Judgement
Press the 1st switch from the right on the size switch of paper feed tray 2 when seen from the front of the machine (Done after detaching paper feed tray 2)	Parameter other than 00001111
Press the 2nd switch from the right on the size switch of paper feed tray 2 when seen from the front of the machine (Done after detaching paper feed tray 2)	Parameter other than 00001011
Press the 3rd switch from the right on the size switch of paper feed tray 2 when seen from the front of the machine (Done after detaching paper feed tray 2)	Parameter other than 00001101

5.Troubleshooting

Cause verification	Problem Judgement
tray 2)	
Press the 4th switch from the right on the size switch of paper feed tray 2 when seen from the front of the machine (Done after detaching paper feed tray 2)	Parameter other than 00001110
Pull out paper feed tray 2 from the machine.	Parameter other than 00001111

Solution:

- Reconnect the connector.
- Replace the sensor.
- Replace the Paper Transport IOB (PCB1).
- Replace the harness.

2nd Paper Feed Tray

Check the 2nd tray set sensor to see if there are any defects.	Replace the switch for the pick-up arm.
--	---

Does not Shift to Right Door Open Status

Target Part/SP No.:Right Door Open/Close Sensor (S17) / SP5-803-026 (Right Door Open/Close Sensor)

Cause verification	Problem Judgement
Manually press the referenced switch (Done after opening the right door)	1: Open
Open the right door	0: Close

Solution:

- Reconnect the connector.
- Replace the sensor.
- Replace the Paper Transport IOB (PCB1).
- Replace the harness.

Target Part/SP No.:Duplex Guide Plate Open/Close Sensor (S4) / SP5-803-027 (Tray Full Exit Sensor)

Cause verification	Problem Judgement
Manually press the referenced switch (Done after opening the duplex guide plate)	1: Open
Open the duplex guide plate.	0: Close

Solution:

- Reconnect the connector.
- Replace the sensor.

- Replace the Paper Transport IOB (PCB1).
- Replace the harness.

Pick-up Arm

Check the switch for the pick-up arm to see if there are any defects.	Replace the 2nd paper feed tray.
---	----------------------------------

Cannot Detect Paper Full

Target Part/SP No.:Paper Exit Full Sensor (S11) / SP5-803-012 (Tray Full Exit Sensor)

Cause verification	Problem Judgement
Execute an INPUT check when there is no paper at the position of the referenced sensor.	1: Full
Execute an INPUT check when there is paper at the position of the referenced sensor.	0: Not full

Solution:

- Reconnect the connector.
- Replace the sensor.
- Replace the Paper Transport IOB (PCB1).
- Replace the harness.

Feeler for Paper Exit Full Sensor (S11)

Cause verification	Problem Judgement	Solution
Check if the feeler for paper full detection is unfolded at the operating position. (Check that it is not folded.)	The feeler is not in the operating position.	Unfold the feeler.
Check if the feeler for paper full detection is unfastened.	Feeler is unfastened.	Reattach the feeler.

Cannot Print as Paper Full Alert Cannot be Turned Off

Target Part/SP No.:Paper Exit Full Sensor (S11) / SP5-803-012 (Tray Full Exit Sensor)

Cause verification	Problem Judgement
Execute an INPUT check when there is no paper at the position of the referenced sensor.	1: Full
Execute an INPUT check when there is paper at the position of the referenced sensor.	0: Not full

Solution:

- Reconnect the connector.
- Replace the sensor.

5.Troubleshooting

- Replace the Paper Transport IOB (PCB1).
- Replace the harness.

Feeler for Paper Exit Full Sensor (S11)

Check if the operation of the feeler for the paper exit full sensor (S11) is prevented due to the presence of foreign material.	Remove the cause of the malfunction.
---	--------------------------------------

Others

If the error occurs periodically, do the following steps. If the result is as shown in the "Problem Judgement" column, follow the solutions.

"Replace the waste toner bottle" is displayed even when it is clear that the waste toner bottle is not full

Target Part/SP No.: Waste Toner Bottle Full Sensor (S34) / SP5-803-032 (Toner Collection Full Sensor)

Cause verification	Problem Judgement
Execute an INPUT check with no feeler in the sensor detection range (Done after detaching the waste toner bottle)	1: Full

Solution:

- Clean the sensor.
- Reconnect the connector.
- Replace the sensor.
- Replace the Imaging IOB (PCB2).
- Replace the harness.

Waste toner bottle is never full

Target Part/SP No.: Waste Toner Bottle Full Sensor (S34) / SP5-803-032 (Toner Collection Full Sensor)

Cause verification	Problem Judgement
Execute an INPUT check with feeler within the sensor detection range (Done after removing the waste toner bottle)	0: Not full

Solution:

- Clean the sensor.
- Reconnect the connector.
- Replace the sensor.
- Replace the Imaging IOB (PCB2).
- Replace the harness.

No waste toner bottle set is displayed on controller board even when it is clear that is set

Target Part/SP No.:Waste Toner Bottle Set Switch / SP5-803-033 (Toner Collection Bottle Set Sensor)

Cause verification	Problem Judgement
Execute an INPUT check with the feeler within the sensor detection range (Done after removing the waste toner bottle)	1: Not set

Solution:

- Reconnect the connector.
- Replace the sensor.
- Replace the Imaging IOB (PCB2).
- Replace the harness.

Waste toner bottle is not detected even when it is set

Target Part/SP No.:Waste Toner Bottle Set Switch / SP5-803-033 (Toner Collection Bottle Set Sensor)

Cause verification	Problem Judgement
Detach the waste toner bottle from the machine.	0: Set

Solution:

- Reconnect the connector.
- Replace the sensor.
- Replace the Imaging IOB (PCB2).
- Replace the harness.

PTR Open/Close LED (LED1) not lit & Paper Transfer Unit Open

Target Part/SP No.:Paper Transfer Unit Open/Close Sensor / SP5-803-028 (PTR Open/Close Sensor)

Cause verification	Problem Judgement
Execute an INPUT check with an object (e.g. paper) placed within the sensor detection range.	1: Close
Execute an INPUT check without an object (e.g. paper) placed within the sensor detection range.	0: Open

Solution:

- Clean the sensor.
- Reconnect the connector.
- Replace the sensor.
- Replace the Paper Transport IOB (PCB1).

5.Troubleshooting

- Replace the harness.

Paper Transfer Unit Open/Close LED not lit

Target Part/SP No.:PTR Open/Close LED (LED1) / SP5-804-206 (PTR Open/Close LED)

Cause verification	Problem Judgement
Turn ON the paper transfer unit open/close LED with OUTPUT check	1: Close
Execute an OUTPUT check without an object (e.g. paper) placed within the sensor detection range.	0: Open

Solution:

- Clean the LED.
- Reconnect the connector.
- Replace the LED.
- Replace the Paper Transport IOB (PCB1).
- Replace the harness.

PTR Open/Close LED (LED1) always lit

Target Part/SP No.:Paper Transfer Unit Open/Close Sensor / SP5-803-028 (PTR Open/Close Sensor)

Cause verification	Problem Judgement
Execute an INPUT check with an object (e.g. paper) placed within the sensor detection range	1: Close
Execute an INPUT check without an object (e.g. paper) placed within the sensor detection range	0: Open

Solution:

- Clean the sensor.
- Reconnect the connector.
- Replace the sensor.
- Replace the Paper Transport IOB (PCB1).
- Replace the harness.

Target Part/SP No.PTR Open/Close LED (LED1) / SP5-804-206 (PTR Open/Close LED)

Cause verification	Problem Judgement
Turn OFF the paper transfer unit open/close LED with OUTPUT check	LED lit

Solution:

- Clean the LED.
- Reconnect the connector.
- Replace the LED.

- Replace the Paper Transport IOB (PCB1).
- Replace the harness.

Troubleshooting for Finishing Options

Side-to-side Registration Error (Finisher Registration Adjustment)

A side-to-side registration error can be produced when the paper is being fed from the mainframe to the finisher.

Booklet Finisher SR3290/Finisher SR3280

The docking bracket [A] for Booklet Finisher SR3290/Finisher SR3280 [A] (and its screw [B]) can adjust the side-to-side registration.



Procedure

- 1.** Deliver some A3/DLT or A4 LEF paper to the proof tray and check how much the edge of the paper is shifted from the center scale.



- **If the paper shifts towards the front**

Slide the docking bracket towards the front side by the amount of shift, to move the finisher in the same direction.

e.g.: When the paper has shifted by 4 mm towards the front from the center mark (2 mm/division of the scale), move the docking bracket towards the front by 4 mm (2 divisions). The divisions move towards the rear.



[A]: Proof tray

[B]: Docking Bracket Screw

- **If the paper shifts towards the rear**

Slide the docking bracket towards the rear by the amount of shift, to move the finisher in the same direction.

e.g.: When the paper has shifted by 4 mm towards the rear from the center mark (2 mm/division of the scale), move the docking bracket towards the rear by 4 mm (2 divisions). The divisions move towards the front.

5. Troubleshooting



[A]: Proof tray

[B]: Docking Bracket Screw



- After the adjustment, check the side-to-side registration by feeding paper out to the proof tray. If the shift has not been solved, adjust the docking bracket (screw for the docking bracket) slightly again.

Booklet Finisher SR3270/Finisher SR3260

Side-to-side registration can be adjusted by the docking bracket [A] for Booklet Finisher SR3270/Finisher SR3260 (and the docking bracket screw [B]).



Procedure

1. Deliver some A3/DLT or A4 LEF paper to the proof tray and check how much the edge of the paper is shifted from the center scale.



- **If the paper shifts towards the front**

Slide the docking bracket towards the front side by the amount of shift, to move the finisher in the same direction.

e.g.: When the paper has shifted by 4 mm towards the front from the center mark (2 mm/division of the scale), move the docking bracket towards the front by 4 mm (2 divisions). The divisions move towards the rear.



[A]: Proof Tray

[B]: Docking Bracket Screw

- **If the paper shifts towards the rear**

Slide the docking bracket towards the rear by the amount of shift, to move the finisher in the same direction.

e.g.: When the paper has shifted by 4 mm towards the rear from the center mark (2 mm/division of the scale), move the docking bracket towards the rear by 4 mm (2 divisions). The divisions move towards the front.

5. Troubleshooting



[A]: Proof Tray

[B]: Docking Bracket Screw



- After the adjustment, check the side-to-side registration by feeding paper out to the proof tray. If the shift has not been solved, adjust the docking bracket (screw for the docking bracket) slightly again.

Stapling Misalignment of Some Sheets or Last Sheet (Booklet Finisher SR3290 / Finisher SR3280) (Booklet Finisher SR3290/Finisher SR3280)

Corner stapling of some sheets or the last sheet of each bundle is misaligned by approximately 1 mm in the paper feed direction.

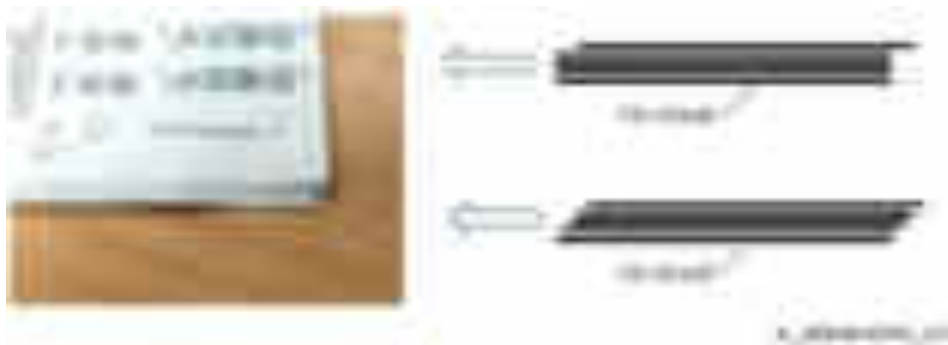

Cause

The paper slackens due to the difference in level between the trailing edge fence and stapling stacking fence, causing misalignment.



Solution

Adjust the position of the trailing edge fence in SP mode.

The factory-set value is displayed at the position indicated by the red frame.



Check the label indicating the initial value. If the value of SP-6-121-003 (NV Adj. Data Mod.: Staple Stacking Fence) is "0", adjust the position of the staple stacking fence gradually (for example, +0.2, +0.4, +0.6, . . .) and check whether the misalignment has been eliminated.

If the initial value is not "0", adjust the value in the positive or negative direction to align the staple stacking fence and trailing edge fence.

- 1.** Using alcohol, clean the part on which to apply the sheet [B] on the back of the support tray [A].

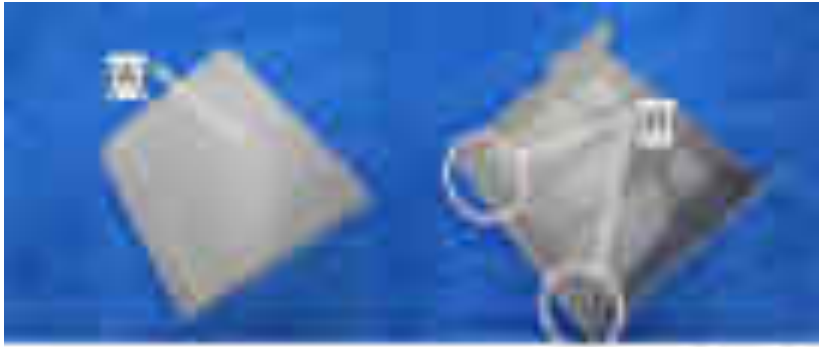

- 2.** Apply the fixing sheets (serial number D6866611) to the back of the support tray [B].



- 3.** Place the sheets flush against the sidewalls [A] of the support tray, hang the foldable part [B] of the sheet on the tip of the tray, and align them.



Installation on Shift Tray

- 1.** Turn the machine's main power on.

5. Troubleshooting

- 2.** Lift the limit sensor feeler [A] of the finisher by hand to turn it on.



- 3.** Open and close the front door [A] or proof tray cover [B] to start initialization. The shift tray starts lowering.

Approximately 3 seconds after the shift starts lowering, “JAM227” appears and the machine stops operating.



- 4.** Even if you remove your hand from the limit sensor feeler, the shift tray [C] remains at the lowered position.
- 5.** Clean the part on which to apply the fixing sheet [A] with alcohol.



- 6.** Attach the support tray [A] to the lowered shift tray. Apply the fixing sheet [B] to the shift tray to secure the support tray.
- 7.** Open and close the front door or proof tray cover to start initialization. The shift tray [C] starts rising and “JAM227” disappears.



Finisher Jogger Problem (Booklet Finisher SR3270/Finisher SR3260)

If a paper alignment problem occurs as shown below, do the following procedure to adjust the jogger width.



Adjust according to the width of the paper used.

This adjustment procedure is explained using SP6-143-004 (A4 LEF) as an example.

- 1.** Place the original (A4 LEF) on the exposure glass.
- 2.** Select the staple function. (You may choose any stapling position.)
- 3.** Press [Start].
Sheets are delivered to the staple tray and stop with a gap of 10 mm on each side.
- 4.** Place the sheets flush against the rear jogger fence.
There will be a gap of 20 mm at the front [A].

5. Troubleshooting

5. Measure the gap between the front jogger fence and paper with the scale.

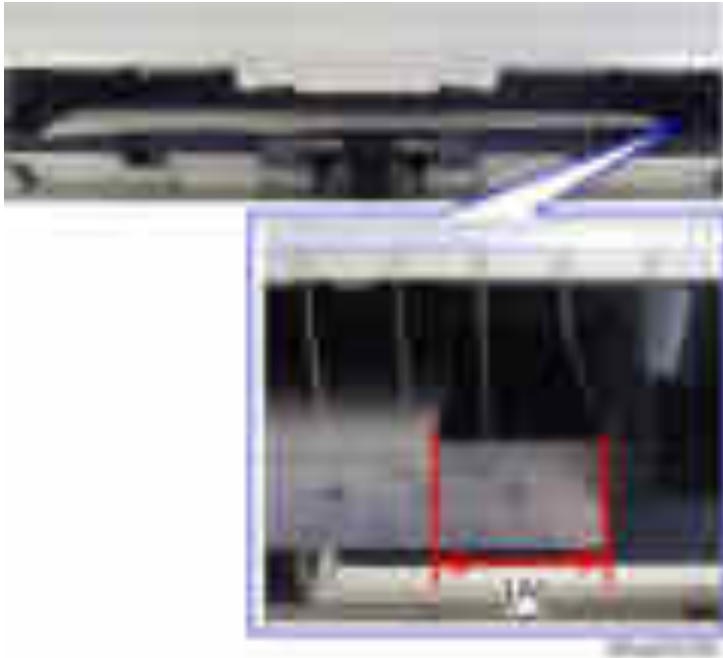

6. After measurement, press [#]. (The paper is delivered.)
7. Using SP6-143-004 (Jogger Pos Adj:1K FIN: A4 LEF), adjust the jogger width so that the front and rear gaps add up to 19.5 mm [A]. (It is possible to adjust by ± 1.5 mm for each paper size.)
8. Repeat Steps 3 to 7 to adjust the jogger width.



- Adjust so that the jogger width is slightly narrower (paper width - 0.5 mm) than the paper size.

Skew Adjustment for Saddle Stitching and Center Folding (Booklet Finisher SR3270)

1. Open the front cover [A], and then pull out the saddle stitch unit [B].



2. Pull and open the lever R10.



- 3.** Loosen the screw [A].



If the paper at the front (top paper on the delivered stack) is misaligned in the lower direction.
Turn the screw [B] clockwise.

5.Troubleshooting



If the paper at the front (top paper on the delivered stack) is misaligned in the upper direction. Turn the screw [B] counterclockwise.



- You can adjust by approximately 1 mm by turning the adjustment screw [B] through 180 degrees.

Early Tray Full Detection Mylar for Internal Finisher SR3250

Delivered sheets may be large curled when output gets to near full. Paste the Mylar to the full detection feeler to detect tray full early before large curl occurs.

Pasting the Mylar

- 1.** Pull the finisher [A]

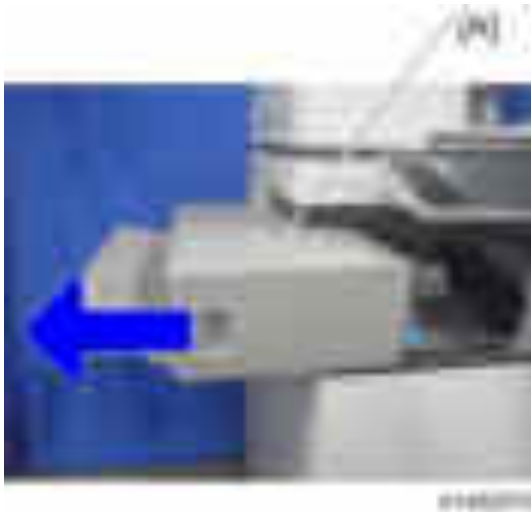

- 2.** Remove the finisher front cover [A] (x2)

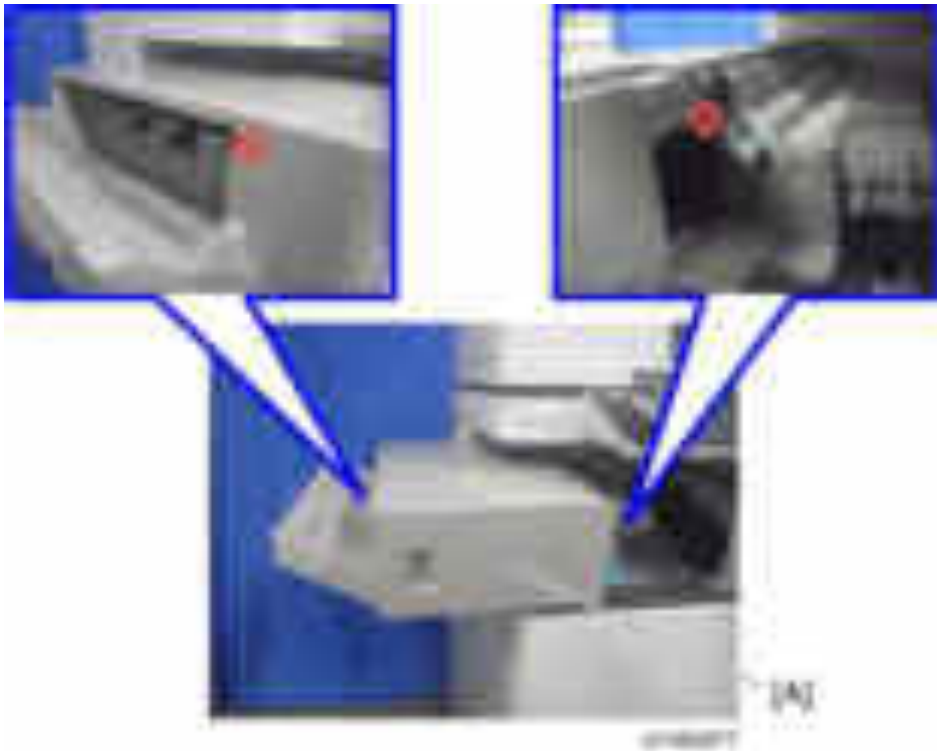

5. Troubleshooting

- 3.** Remove the left lower cover [A] (🔧x2)



- 4.** Rotate the gear [A] to lift down the movable tray [B].



- 5.** Remove the paper exit tray [A] (🔧x2)

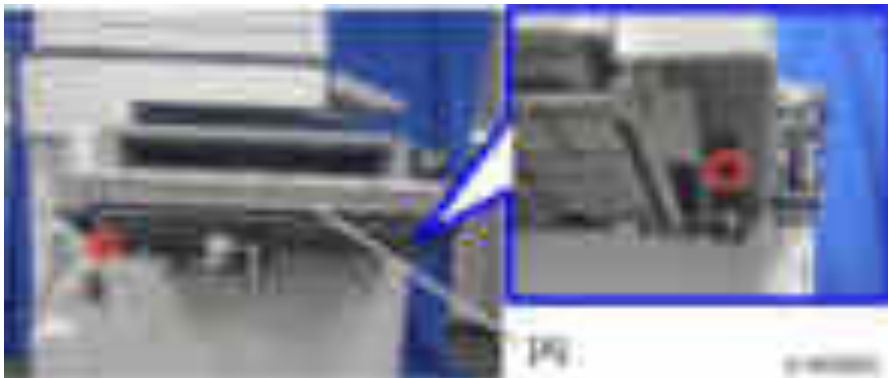

- 6.** Paste the Mylar [A] on the full detection feeler [B].



- 7.** Re-attach the paper exit tray (x2)
- 8.** Move the movable tray [A] up and down to check that the Mylar does go through the sensor

5.Troubleshooting

properly.

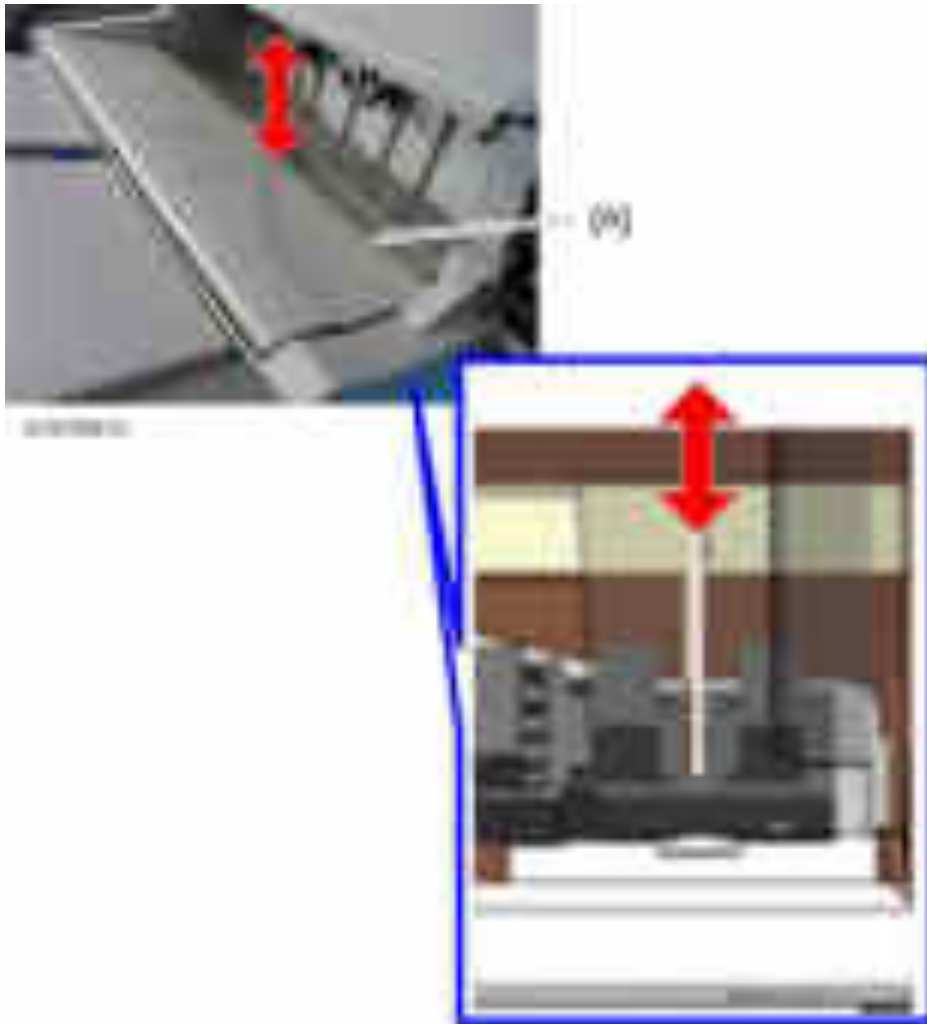

- 9.** Re-attach the left lower cover (x2)
- 10.** Re-attach the finisher front cover (x2)

Paper Curl Problem for Internal Finisher SR3300

When using the mixed mode, duplex (curls towards the lower side) over the simplex (curl towards the upper side) and paper curl occurs, attach the auxiliary tray (D7667010), and disable the paper exit full sensor (S11).

1. Remove the paper exit cover [A] ( ×2)



2. Release the clamp and disconnect the harness of the paper exit full sensor (S11) 1 [A].



3. Loop and clamp the harness [A] as shown.



4. Release the clamp and disconnect the harness of the paper exit full sensor (S11) 2 (Staple) [A].



5. Troubleshooting

5. Loop and clamp the harness [A] as shown.



- If the harness cable [A] is short to loop, clamp the harness without looping.



6. Re-attach the paper exit cover (x2)

7. Attach the auxiliary tray (D7667010) [B] to the paper exit tray [A]



Maximum number of Sheets for Stapling and What Happens when the Job Has Too Many Pages

Specifications: Maximum Sheet Capability for Staple Jobs

Model	Corner Staple	Booklet Staple
Finisher SR3260	50 sheets	-
Booklet Finisher SR3270	50 sheets	15 sheets
Booklet Finisher SR3290	50 sheets	20 sheets
Finisher SR3280	50 sheets	-
Internal Finisher SR3250	50 sheets	-

Behavior: When the Number of Sheets Exceeds the Maximum Staple Capability

When corner stapling

Sheets are fed out without being stapled. First, the maximum number of sheets (50) is stacked in the staple tray and fed out. Following this, any remaining sheets that exceed this maximum are also stacked and fed out without being stapled, in the same way.

Example:

If 60 sheets are set to be stapled, the first 50 are stacked in the staple tray and then fed out without being stapled. The remaining 10 are then stacked in the tray and fed out without being stapled.

When the maximum number of originals for a stapled set has been scanned, "Stapling capacity exceeded" is displayed on the LCD.



There is no message displayed prompting the user to cancel or continue with the 51st original.

When booklet stapling

The following dialog is displayed when the maximum number of sheets in a stapled set is reached during the scanning of the originals. The user is prompted before printing begins.



[Stop] The job is canceled (no further scanning, no printing)

[Continue] Sets are stapled at maximum capacity in batch and fed out.

Example:

The machine stops scanning after 20 out of 30 originals are scanned.

5.Troubleshooting

The message shown above is displayed.

If [Continue] is selected, printing starts and sheets are stapled in batches of 20 sheets and 10 sheets.

Select the Behavior when the Job Has More than the Maximum of Staple Capability with SP5199

SP5-199 sets whether to staple sheets stacked in the staple tray or finisher before feeding out.

0 (default): Behavior depends on the finisher attached.

1: Sheets are fed out without being stapled.

2: Sheets are stapled and fed out.

Electrical Component Defects

Fuses

IM C6000/C5500/C4500

Name	Output connector	Capacity	Part number	Market exchange possible
		Voltage	Part name	Remarks
FU101	CN985 (Fusing center heater) CN986 (Fusing edge heater)	15A(NA)	11071241 (NA)	Yes
		8A	11071366	
		AC	TLC-15A-N4 (NA) FIH 250V 8A(EM)8A	Installed on AC controller board
FU102	CN988 (DC power supply)	15A (NA)	11071241(NA)	Yes
		8A	11071366	
		AC	TLC-15A-N4 (NA) FIH 250V 8A(EM)8A	Installed on AC controller board
FU110	CN921(Heater for Tray1, 2, and optional trays) CN922 (Heater for Scanner and PCU)	2A	11071225	NO
		AC	SLT 250V 2A	Installed on Heater Board (Service Part)
FU105	None	2A	11071362	NO
		AC	SCT2A	Installed on AC controller board
FU1	CN911(IOB)	5A	11071351	NO
		5V	SCT5A	Installed on DC power supply
FU2	CN911(IPU)	5A	11071351	NO
		5V	SCT5A	Installed on DC power supply
FU3	CN912(IOB)	10A	11071283	NO
		24V	FBT 250V 8A(EM)	Installed on DC power supply
FU4	CN917 (Interlock switch [IOB])	10A	11071283	NO
		24V	FBT 250V	Installed on DC power

5.Troubleshooting

Name	Output connector	Capacity	Part number	Market exchange possible
		Voltage	Part name	Remarks
			8A(EM)	supply
FU5	CN917 (Interlock switch [IOB])	10A	11071283	NO
		24V	FBT 250V 8A(EM)	Installed on DC power supply
FU7	CN913(FIN) CN914(BANK)	10A	11071283	NO
		24V	FBT 250V 8A(EM)	Installed on DC power supply

IM C3500/C3000/C2500/C2000

Name	Output connector	Capacity	Part number	Market exchange possible
		Voltage	Part name	Remarks
FU101	CN985 (Fusing center heater) CN986 (Fusing edge heater)	15A (NA) 8A	11071241(NA) 11071366	Yes
		AC	TLC-15A-N4 (NA) FIH 250V 8A(EM)8A	Installed on AC controller board
FU102	CN988 (DC power supply)	15A(NA)	11071241(NA) 11071366	Yes
		AC	TLC-15A-N4 (NA) FIH 250V 8A(EM)8A	Installed on AC controller board
FU110	CN921(Heater for Tray1, 2, and optional trays) CN922 (Heater for Scanner and PCU)	2A	11071225	NO
		AC	SLT 250V 2A	Installed on Heater Board (Service Part)
FU105	None	2A	11071362	NO
		AC	SCT2A	Installed on AC controller board
FU1	CN911(IOB)	5A	11071229	NO
		5V	SLT 250V 5A	Installed on DC power supply
FU2	CN911(IPU)	5A	11071229	NO
		5V	SLT 250V 5A	Installed on DC power supply

Name	Output connector	Capacity	Part number	Market exchange possible
		Voltage	Part name	Remarks
FU3	CN912(IOB)	8A		NO
		24V	51MS(P)080L	Installed on DC power supply
FU4	CN917 (Interlock switch [IOB])	8A		NO
		24V	51MS(P)080L	Installed on DC power supply
FU5	CN917 (Interlock switch [IOB])	8A		NO
		24V	51MS(P)080L	Installed on DC power supply
FU7	CN913(FIN) CN914(BANK)	8A		NO
		24V	51MS(P)080L	Installed on DC power supply

Fuse position

The photograph is an example of IM C6000 / C5500 / C4500 (200V). The fuse position of IM C3500 / C3000 / C2500 / C2000 is also the same.



5.Troubleshooting



Vertical Streaks on Copies due to Scanning Problems

Overview

Marks on prints and copies are mostly due to dirt on the DF exposure glass [A], generally caused by adhesive contaminants (such as ball point pen ink and correction fluid).

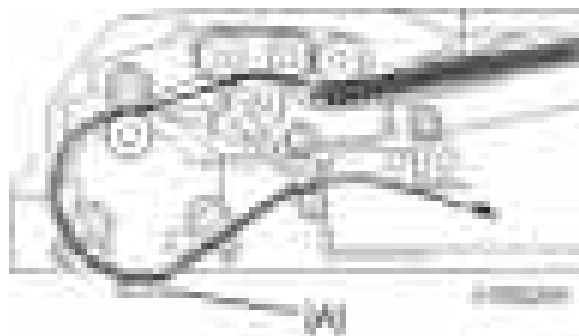

Compared to non-adhesive contaminants (such as paper fragments and eraser dust), adhesive contaminants are more likely to lead to complaints from customers because of the following:

- Vertical streaks caused by adhesive contaminants are more visible in terms of image quality.
- Unless removed by cleaning, adhesive contaminants continue to produce vertical streaks, while non-adhesive contaminants stop producing streaks after they are dislodged.
- Many adhesive contaminants are difficult to remove by cleaning.

The ARDF/SPDF that is provided with this machine "Machine Features Settings" a system (non-contact scanning) to reduce vertical streaks caused by adhesive contaminants.

Contact scanning: Other ADFs/ARDFs	Non-contact scanning: SPDF/ARFDF for this machine
In contact scanning, the whole of the original comes into contact with the DF exposure glass [A] so that non-adhesive contaminants can be removed.	By means of the Mylar sheet [B], originals are kept slightly above the DF exposure glass [A], preventing adhesive contaminants from adhering to the glass.

The SPDF/ARFDF for this machine can be converted from non-contact scanning to contact scanning for users who wish to reduce vertical streaks caused by non-adhesive contaminants.

SP No.	Contact scanning	Non-contact scanning
SP4-688-001 (for ARDF)	103%	104%
SP4-688-002 (for SPDF)	96%	101%
SP4-871-003 (both ARDF and SPDF)	0.00%	0.11%

5. Troubleshooting

Converting the ARDF DF3110 to Contact Scanning

- 1.** Unplug the machine power cord before starting the following procedure.
- 2.** Remove the ARDF front cover [A] ( x1).



- 3.** Remove the Scanning guide plate [B] ( [A]x1).



- 4.** Remove the plastic guides [A] on the sides of the scanning guide plate ( x1).



- 5.** Attach the guides for contact scanning. Each guide has a hole [A].



- 6.** Mount the scanning guide plate, taking care not to damage the sheet [A].



- 7.** Peel off the gap sheet [A] from the DF exposure glass with your hands.



- 8.** Clean the DF exposure glass [A] with alcohol.
To avoid paper jams, make sure adhesive is completely removed.

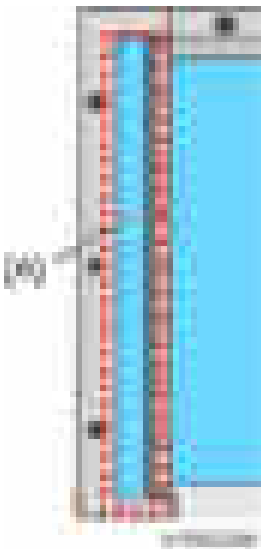

- 9.** Turn the main switch on.
10. Start the SP mode.
11. Select SP4-688-001 (DF Density Adjustment ARDF) and change the setting from "104" to "103" for the contact scanning.
12. Change the DF magnification (SP4-871-003) from [0.11%] to [0.00%].



- When returning the setting back to non-contact scanning, return the SP values also.

5.Troubleshooting

Converting the SPDF3100 to Contact Scanning

- 1.** Open the SPDF and exchange the entrance lower guide unit [A] to a non-contact type part.



- Entrance lower guide unit for non-contact transport: The following areas are black [A].
- Entrance lower guide unit for contact transport: The following areas are clear and colorless [B].



- 2.** Exchange the scanning guide plate [A] to a non-contact type part (hook x 1).



- [A] : The color of the marker of the non-contact type scanning guide plate for this machine is gray.
- [B]: The color of the marker of the contact type scanning guide plate for this machine is white.
- [C]: The color of the marker of the non-contact type scanning guide plate for previous machine

is black.



- 3.** Attach the scanning guide plate for contact transport [A] (hook x 1).
- 4.** Attach the entrance lower guide unit for contact transport [B] (hook x 2).



- 5.** Peel off the gap sheet [A] from the DF exposure glass with your hands.



- 6.** Clean the DF exposure glass [A] with alcohol.
To avoid paper jams, make sure adhesive is completely removed.

5.Troubleshooting

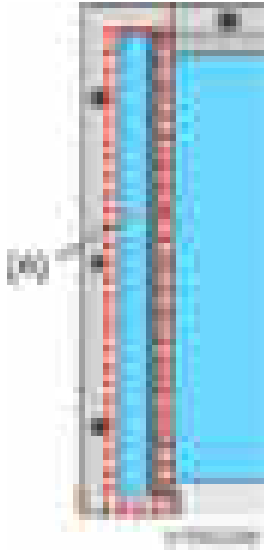

7. Enter the SP mode.

8. Change SP4-688-002 (Scan Image Density Adjustment 1-pass) from "101" to "96".

9. Change the DF magnification (SP4-871-003) from [0.11%] to [0.00%].



- When returning the setting back to non-contact scanning, return the SP values also.

Image Quality Problems

Misrecognition of Auto Color Selection When Scanning Originals

Overview of Auto Color Selection

In Auto Color Selection (ACS) mode, 2 processes are carried out, namely (1) Chromatic Color Recognition and (2) Size Recognition, to determine whether the scanned original is full color or black-and-white.

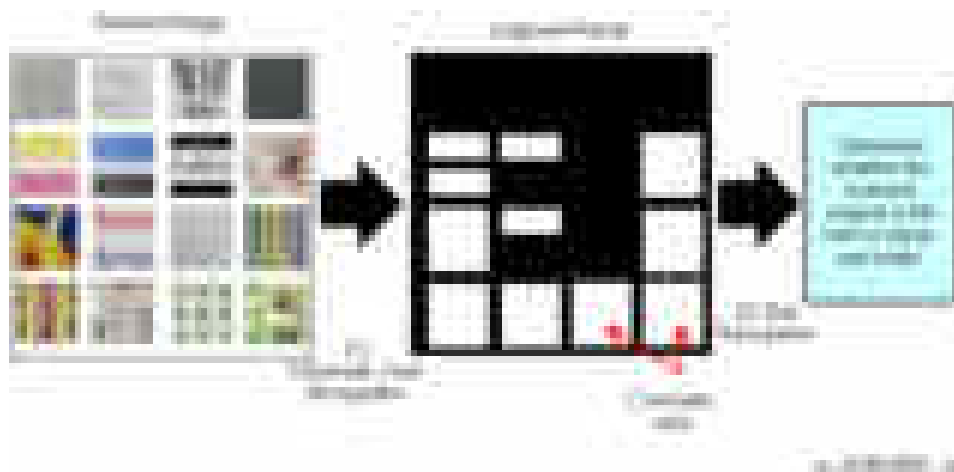

In (1) Chromatic Color Recognition, each pixel is assessed for whether it has a chromatic color or not according to its RGB deviation.

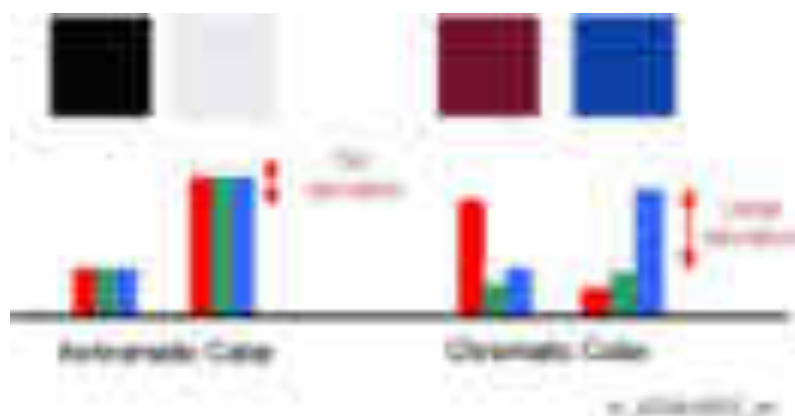

By (2) Size Recognition, whether the original is recognized as full color or black-and-white depends on the continuity of the chromatic color in (1) Chromatic Color Recognition.

The original is recognized to be full color only if chromatic color pixels are detected continually. If interspersed minute chromatic color pixels are detected (as shown below), the original is not recognized as a full color original.

5.Troubleshooting

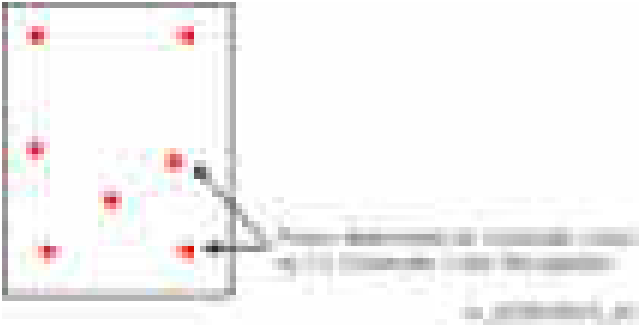

UP settings: Processed according to the color recognition

In “A.C.S. Sensitivity”, you can adjust the level of (2)Size Recognition for recognizing whether the original is full color or black-and-white.

From both Copier or Scanner application, you can specify this setting in the 5-level scale, from 0 (Black & White) to 4 (Full Color).



- Adjust the A.C.S. Sensitivity in Classic (Legacy UI) copier or scanner. There is no 5-level scale in New (Simple UI) Copier or Scanner application.



SP mode: Color Recognition: adjusting the color range

Using SP4-939-001 (ACS:Color Range), you can adjust the level of (1) Chromatic Color Recognition for recognizing whether the original is full color or black-and-white.

This is the SP for both copier and scanner settings, and you can adjust this setting with the 5-level scale from -2 to 2 (Default: 0).

If an original with a colored background fails to be recognized as a black-and-white original by ACS, set the value of this SP to “-1” or “-2”.

If an original with a gray or faintly colored background fails to be recognized as a full color original by ACS, set the value of this SP to “1” or “2”.

Misrecognition of Auto Color Selection (Copy/Scanner)

In the Auto Color Selection (hereafter called ACS) mode, if copying or scanning an original on which color is printed only on the edge, the original will be misrecognized as monochrome. If so, color is not printed on the output.

Error Condition

Copy Application

The misrecognition occurs when copying an original which has color at the edge, and that color is printed on the output 10 mm from the edge in the ACS mode.

When using the copy application, if the original is recognized as monochrome, color on the document may not be printed on the output. When printing the standard 10 colors used in Microsoft Office Word 2013 (an example is shown below), the following colors with the "x" mark will disappear if the document is recognized as monochrome in the ACS mode.



- Colors with the "x" mark will not be printed if the document is recognized as monochrome. The result may differ depending on the equipment status or environment.

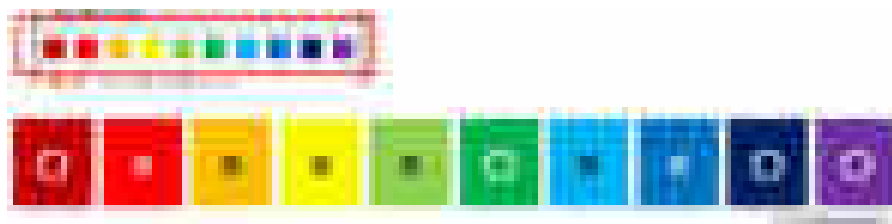

Scanner Application

The misrecognition occurs when scanning an original which has color only 15 mm from the edge (using the original as a standard) in the ACS mode.

Cause

In the ACS mode, the edge of the original is not recognized. Only the center part of the original document is the target area to recognize color or monochrome (in order to prevent misrecognition due to noise).

When copying in the ACS mode, ACS recognition and the image processing equivalent to full color is performed simultaneously. If recognized as monochrome in the ACS recognition, color without a K component will not be printed.

Countermeasure

Change the ACS area excluded from recognition with the following SP settings.

The smaller the value, the smaller the ACS area excluded from recognition becomes, which enables the document to be recognized as color.

5.Troubleshooting

SP No.	SP Name	Def.	Max.	Min.
4-938-001	ACS:Edge Mask Copy:Sub LEdge	10	0	31
4-938-002	ACS:Edge Mask Copy:Sub TEdge	10	0	31
4-938-003	ACS:Edge Mask Copy:Main LEdge	10	0	31
4-938-004	ACS:Edge Mask Copy:Main TEdge	10	0	31
4-938-005	ACS:Edge Mask Scan:Sub LEdge	15	0	31
4-938-006	ACS:Edge Mask Scan:Sub TEdge	15	0	31
4-938-007	ACS:Edge Mask Scan:Main LEdge	15	0	31
4-938-008	ACS:Edge Mask Scan:Main TEdge	15	0	31

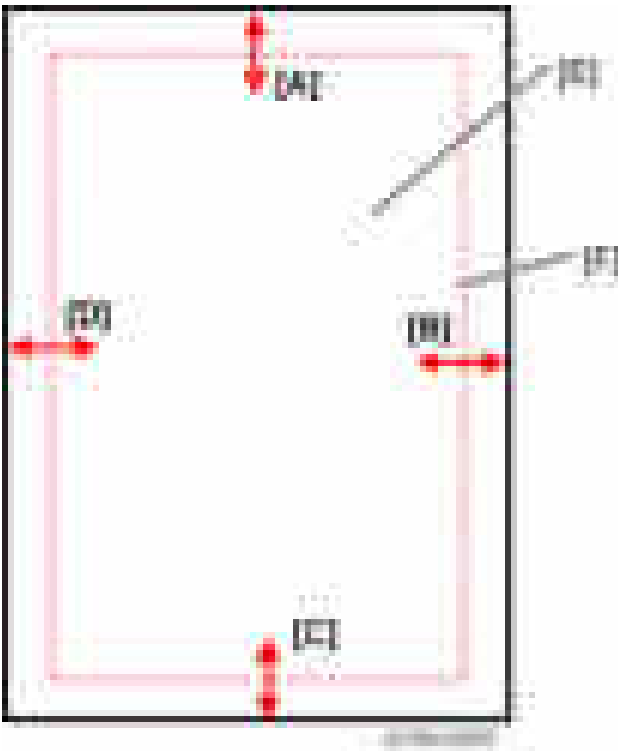

[A]: Sub scan direction: leading edge (left)

[B]: Main scan direction (front)

[C]: Sub scan direction: leading edge (right)

[D]: Main scan direction (rear)

[E]: Paper

[F]: ACS area excluded from recognition



- Because the edge of the original is subject to noise, color misrecognition may occur after setting these SPs smaller than the defaults. In this case, in order to avoid complaints concerning extra cost, be sure to ask the customer for permission before changing these SP settings.

Failure to Reproduce Colored Text During Color Copying

Some colored text is printed in black.

Condition

This occurs when copying an original including faintly colored text or dark colored text in Full Color / Auto Color Selection / Two-Color mode. (The following figure shows an example of colored text being printed in black.)

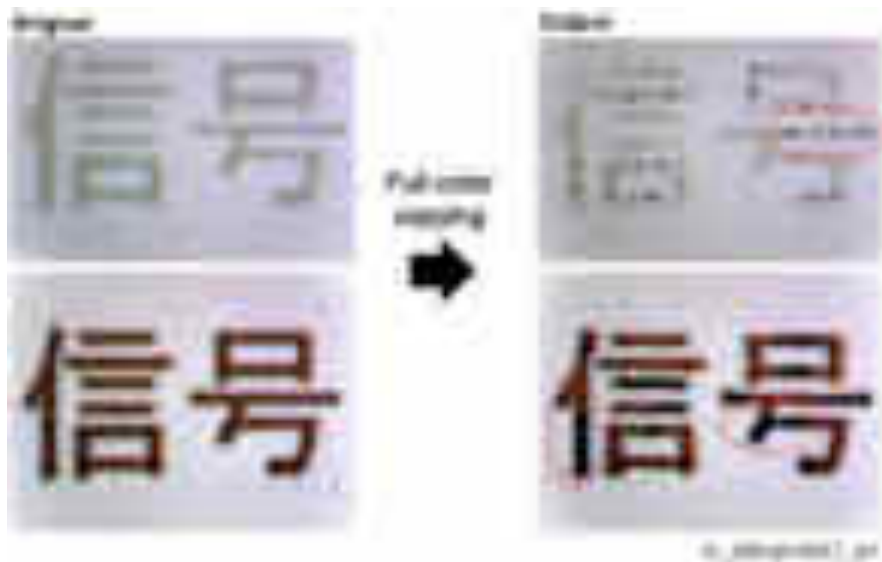

This occurs when copying an original with an image visible from the other side (colored text printed on the paper with relatively thick-colored photos or graphs) in Full Color / Auto Color Selection / Two-Color mode. (The following figure shows an example of an original with an image visible from the other side.)



Cause

In the copier image processing, text areas and color areas are extracted from the scanned image of the original.

This extraction is called “image area separation”. The area recognized as black text (text area and black and white area) is printed in black only.

5. Troubleshooting

Cause 1

To prioritize the image of the black text and prevent erroneously extracting the black text as the colored text area, slight colored areas on scanned black text are recognized as black text.

Therefore, faint colors and low chroma colors (or achromatic color) may be partly erroneously recognized as black text and printed with black only.

Cause 2

Colored text with an image visible from the other side, which is scanned darkly compared to colored text without an image visible from the other side, may be partly erroneously recognized as black text and printed with black only.

Solution

By setting the value closest to [photo], the entire image is equally processed as an image instead of processing areas separately, thus preventing colored text from being printed in black.



- Adjust the Text/Photo Sensitivity in Classic (Legacy UI) copier or scanner. There is no 5-level scale in New (Simple UI) Copier or Scanner application.

- 1.** Press [Edit / Color].
- 2.** Select the [Color] tab.
- 3.** Select [Adjust Color].



- 4.** Select the [Color Quality] tab, and then set the value in [Text/Photo Sensitivity] closest to [Photo].



Flowchart for Identifying Unit Causing Image Quality Degradation

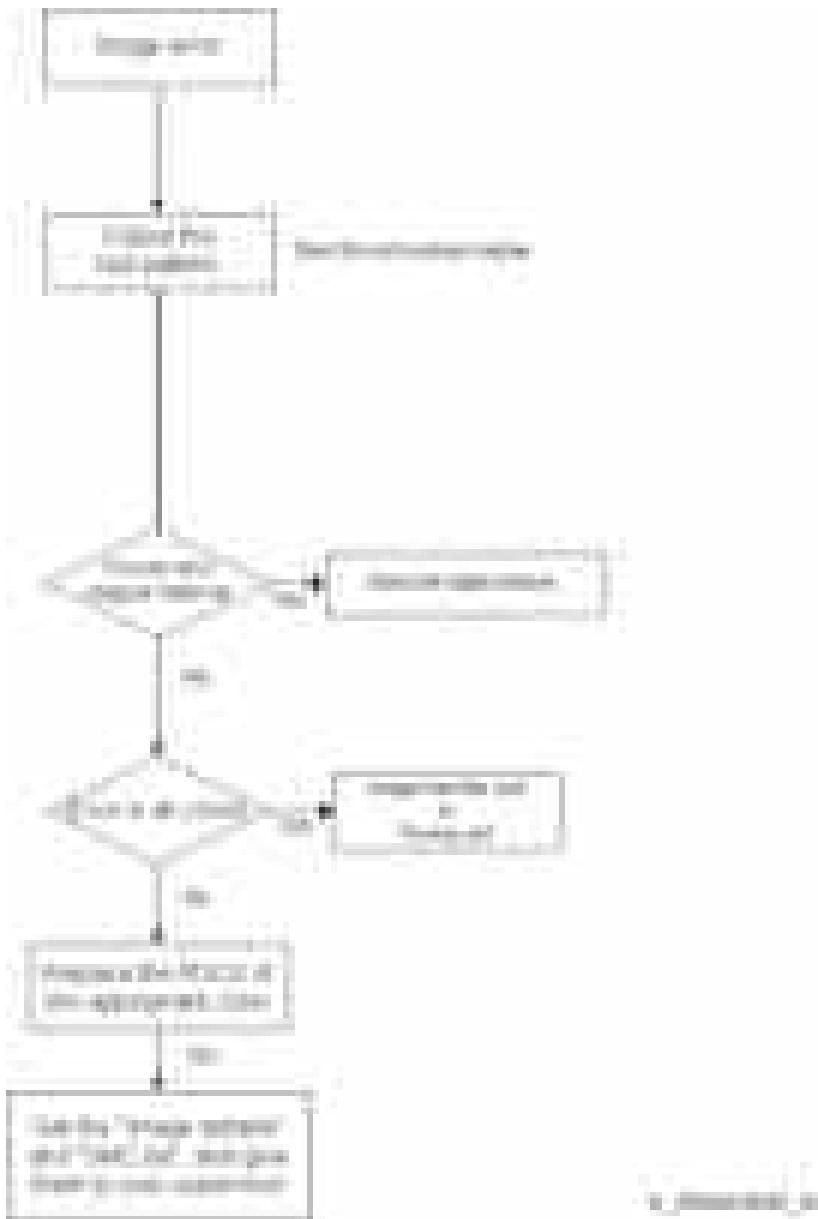

How to Print Test Pattern

- 1.** Enter the SP mode, and then select **SP2-109-003**.
- 2.** Select the test pattern to print from the list, and then press [OK].
 - The following pattern is recommended to identify the problem color.
 IM C6000/C5500/C4500: 13 (Independent Pattern (4dot))
 IM C3500/C3000/C2500/C2000: 12 (Independent Pattern (2dot))
- 3.** Select **SP2-109-005** (1: Full Color, 2: Cyan, 3: Magenta, 4: Yellow, 5: Black) to select the printing color.
- 4.** To change the density of test pattern, select density with **SP2-109-006** to **009** for each color. If select "0" with **SP2-109-006** through 009, the color adjusted so will not show up in the test

5. Troubleshooting

pattern.

- 5.** Press "Copy Window", then specify the settings on the copier application for test print (paper size etc...).
- 6.** Press "Start" to start the test print.

IM C6000/C5500/C4500

Interval	Target part	Replacement part
31.4mm	Charge roller cleaner	PCU
36.1mm	lubricant roller	PCU
39.8mm	Development roller	Development unit
40.2mm	Charge roller	PCU
44.0mm	Paper transfer roller	Paper transfer roller unit
54.8mm	Image transfer drive roller	Image transfer roller unit
94.2mm	Drum	PCU
94.2mm	Fusing sleeve belt	Fusing sleeve belt unit/ Fusing unit
100.5mm	pressure roller	Pressure roller/ Fusing unit
963.8mm	Image transfer belt	Image transfer belt/ Image transfer unit

M C3500/C3000/C2500/C2000

Interval	Target part	Replacement part
31.4mm	Charge roller cleaner	PCU
34.6mm	Development roller	Development unit
37.7mm	Charge roller	PCU
48.7mm	Paper transfer roller	Paper transfer roller unit
54.8mm	Image transfer drive roller	Image transfer roller unit
94.2mm	Drum	PCU
94.2mm	Fusing sleeve belt	Fusing sleeve belt unit/ Fusing unit
100.5mm	Pressure roller	Pressure roller/ Fusing unit
963.8mm	Image transfer belt	Image transfer belt/ Image transfer unit

Scale-Like Density Fluctuation

The following scale-like density fluctuation occurs.



Cause

The charge neutralization capability of the charge neutralization needles of the paper transfer unit may decline due to aging and soiling, resulting in the paper being transferred in an electrically unstable state. When this happens, the static charge on the paper may be discharged on the paper feed path, causing the problem.

Condition in Which the Problem Tends to Occur

At low temperature and humidity

Solution

Clean the needles of the paper transfer unit with the blower brush.

- 1.** Remove the paper transfer unit.
- 2.** Remove the knob [A], and then remove the circlip [B] and bearing [C].



- 3.** Remove the bearing on the other end, and then remove the paper transfer roller [A].

5. Troubleshooting



Be careful not to touch the paper transfer roller.

- 4.** Clean with the blower brush in the direction shown.
Do not rub in a direction other than that indicated by the arrows.

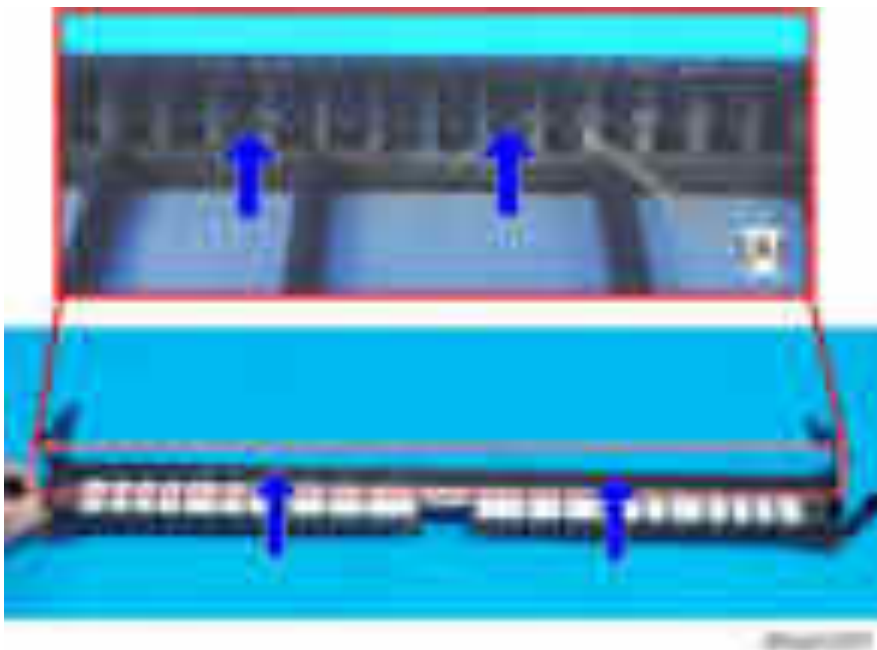

- 5.** After cleaning, install the paper transfer roller, and then reattach the paper transfer unit to the machine.

Other Troubleshooting

When Fluorescent/ LED Lamps Flicker

Symptom

Under the usage environment of this machine, at the placement location, fluorescent and/or LED lamps flicker.

Cause

As a result of the voltage drop occurs, when the fusing lamp is applied an electrical current. It depends on the electrical power environment, at the customer's placement location.

Solution

The procedure varies by the flicker occurrence timing. So check the occurrence timing, and do the procedure that matches the timing.

Occurrence Timing

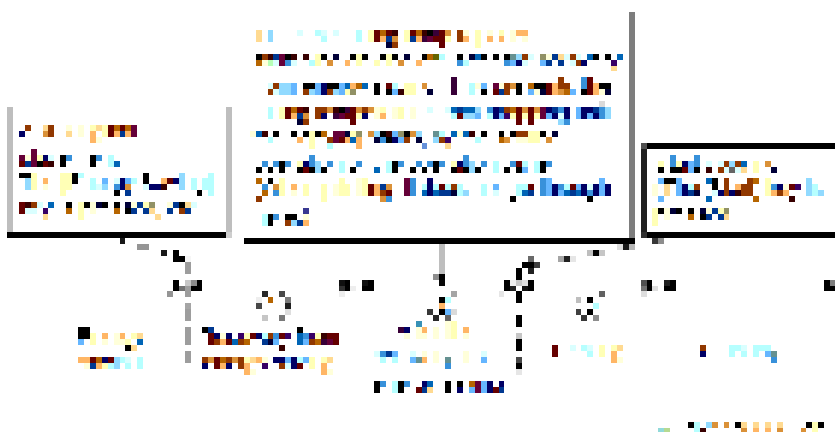

Timing	Solutions	Side effect
① Recovery from energy saving	Set SP1-135-001 (Inrush Control) to "1 (ON)".	Recovery time from energy saving becomes slower approx. 0.4 sec..
① After the recovery from energy saving	Set SP1-135-001 (Inrush Control) to "1 (ON)". Set SP1-135-002 (Flicker Control) to "1 (ON)".	<ul style="list-style-type: none"> Recovery time from energy saving becomes slower approx. 0.4 sec.. In the case of the adhesion amount of an image is large, an offset may occur. In the case of a fusing offset occurs, in the related SP to fusing offsets, setting values must be changed.
	If it has not been improved in the above, do the following procedures in addition;	The fusing temperature drops during the operation. After copying starts, the fusing

5.Troubleshooting

Timing	Solutions	Side effect
	<ul style="list-style-type: none"> Stop the lighting of the fusing lamp after the warmup. Set SP1-121-001(Switch:Rotation Start/Stop:Time:After Reload) to "0 sec". 	temperature is raised up to a printable temperature. Because of that, copying completion time becomes slower (approx. 1-2 sec.).
④ Printing	Set SP1-135-002 (Flicker Control) to "1 (ON)".	<ul style="list-style-type: none"> In the case of the adhesion amount of an image is large, an offset may occur. In the case of a fusing offset occurs, in the related SP to fusing offsets, setting values must be changed.

Related SP to Fusing Offsets

SP Name	SP No.	Value
Print Target Temp.:Plain1:FC:Center	SP1-105-001	As initial values + 10 degrees are the upper limits, change values to improve offsets.
Print Target Temp.:Plain1:BW:Center	SP1-105-003	
Print Target Temp.:Plain2:FC:Center	SP1-105-005	
Print Target Temp.:Plain2:BW:Center	SP1-105-007	
Print Target Temp.: Thin:FC:Center	SP1-105-009	
Print Target Temp.: Thin:BW:Center	SP1-105-011	
Print Target Temp.: M-thick:FC:Center	SP1-105-013	
Print Target Temp.: M-thick:BW:Center	SP1-105-015	

When Abnormal Noise Occurs

When abnormal noise occurs during machine operating, identify the occurrence location, by using various OUTPUT Check. However, about the following two modules, follow the checking procedure flow.

- Check the abnormal noise of the drive unit (peripheral fusing)
- Check the abnormal noise when the toner is supplied or the bottle motor is driving



- Because the damage or contamination of parts can lead to secondary failure, always follow the procedure.
- Take particular care not to be caught in the rotating parts of the motors and/or gears.

Operation Check Procedures of the Toner Supply Motor/Toner Bottle Drive Motor

The operation check of the toner supply motor and/or toner bottle drive motor is performed by a forced toner supply, not OUTPUT Check.

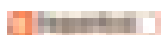

- The operation check of the toner supply motor and/or toner bottle drive motor is performed by a forced toner supply, not OUTPUT Check.

- 1.** Do [Force Tnr Supply: Exe (SP3-050-003 to 006)] for the applicable color twice. If there is enough toner in the toner supply unit, the toner bottle drive motor will not work.

SP No.	SP Name
SP3-050-003	Force Tnr Supply: Exe Execute: K
SP3-050-004	Force Tnr Supply: Exe Execute: C
SP3-050-005	Force Tnr Supply: Exe Execute: M
SP3-050-006	Force Tnr Supply: Exe Execute: Y

- 2.** Do [Manual ProCon :Exe Density Adjustment (SP3-011-002)] once.



- If the operation of the toner bottle drive motor could not be checked, do step1 again after the manual execution of density adjustment.

Procedure of Checking Abnormal Noise of Drive Unit (Peripheral Fusing)

When the abnormal noise of the drive unit (peripheral fusing) has occurred, follow the following flow, and check whether the fusing unit is the cause, by using SP1-153 (Abnormal Noise Confirmation). If the fusing unit is the cause, replace the fusing unit. If the drive module is the cause, in addition, perform the operation check of various motors by using OUTPUT Check, to identify which motor is the cause.

5.Troubleshooting

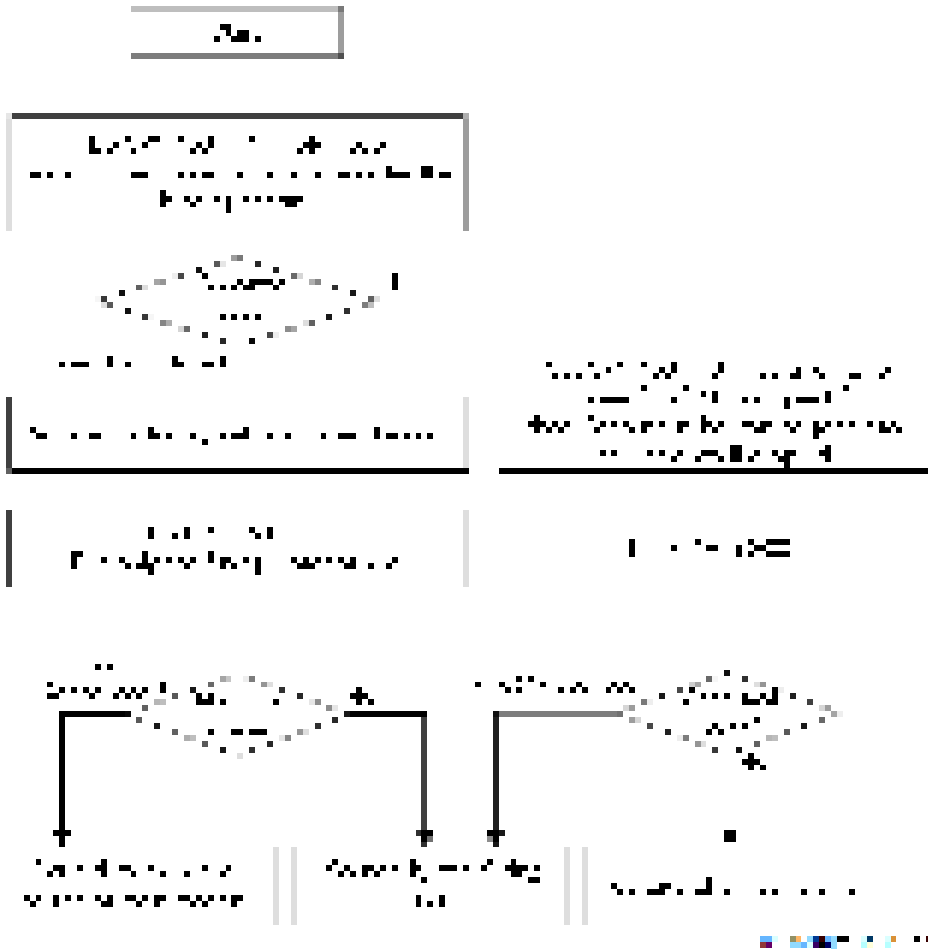

About the setting value of the operation line speed in SP1-153-003

During warming-up or operating on the operation panel, the motors rotate at low line speeds. At the time, if noise occurs, start checking from [2: Low Speed]. Middle speed is for only thick paper 1 printing, so use middle speed if abnormal noise occurs when thick paper 1 is supplied.

Related SP

SP No.	SP Name	Function	Description
SP1-153-001	Abnormal Noise Confirmation: Unit: Execute	The fusing motor rotates with the heating control.	Fails if the fusing unit is not installed or the cover is open
SP1-153-002	Abnormal Noise Confirmation: No Unit: Execute	The fusing motor rotates without the fusing unit.	Fails if the fusing unit is installed or the cover is open
SP1-153-003	Abnormal Noise Confirmation: Operation Line Speed	Line speed at the time of rotation 0: Standard speed 1: Middle speed 2: Low speed	
SP1-153-	Abnormal Noise Confirmation: Operation Time	Rotates during this time. Initial value: 60 sec.	

004			
SP1-153-005	Abnormal Noise Confirmation: Heat Center Target Temp	Temperature setting for SP1-153-001 (Unit: Execute)	Do not change
SP1-153-006	Abnormal Noise Confirmation: Heat End Target Temp	Temperature setting for SP1-153-001 (Unit: Execute)	
SP1-153-007	Abnormal Noise Confirmation: Press Target Temp	Temperature setting for SP1-153-001 (Unit: Execute)	

Error Message ” Replacement of the control panel is now necessary” is Displayed and SC843-02 Occurs

Symptom

“Replacement of the control panel is now necessary” is displayed and SC843-02 occurs.



Cause

The thresholds for eMMC data overwrites is exceeded during operation or while the machine is recovering from Energy Saver mode.

Thresholds:

- 3000 deletions per block on eMMC
- 3,000,000 total deletions for all blocks on eMMC (1000 blocks x 3000).

Solution

Replace the PCB board for the Smart Operation Panel.

Error Message " Invalid firmware is..." Appears after Turning Power ON

Symptom

The following error is displayed at machine installation.



Cause

Corruption of the program files in the operation panel control chip.



- There is no damage to the hardware.

Solution

If the symptom occurs, do the following:

1. Turn the machine main power OFF, and then remove the power cord from the outlet.
2. Press the machine main power button.



- The blue LED (upper right) on the operation panel will light for a moment.

3. Reinsert the power cord into the outlet.
4. Press the main power button while holding down the [EX1] and [EX3] keys.



- This is in order to access Recovery mode.

5. When the blue screen is displayed, hold down the [EX1] and [EX2] keys for four seconds.



6. Once you enter Recovery mode,

- Press the [EX2] key four times, and then
- Move the cursor over to “Wipe free area partition”, and then
- Press the [EX3] key to execute the wipe of the free area partition.

7. Once the “Free area partition wipe complete” message is displayed in the lower left of the LCD,

- Move the cursor over to “Reboot system now”, and then
- Press the [EX3] key to execute the reboot.

6. System Maintenance

SP Tables

See "Appendices" for the following information:

- Engine SP1000
- Engine SP2000
- Engine SP3000
- Engine SP4000
- Engine SP5000
- Engine SP6000
- Engine SP7000
- Controller SP5000
- Controller SP7000
- Controller SP8000
- Printer SP Mode
- Scanner SP Mode
- Input Check
- Output Check

Overview of Firmware Update

Difference from Previous Machine

- In addition to an SD card, a USB flash drive can be used for the firmware update. Firmware update from a USB flash drive can only be performed using the slot on the operation panel.
- When using the slot on the operation panel for the firmware update from removable media (SD card or USB flash drive), it is no longer necessary to turn the machine's main power off and then back on.
- Firmware update from removable media can be executed at the programmed date and time via the package file read from the removable media in advance.
- Firmware update by the module alone is no longer available.

Overview



- The firmware is basically supplied as a package. However, an individual firmware module may be provided on special occasions, such as for correcting a problem.

Each firmware module (such as System/Copy, Engine, etc.) used to be updated individually. However, an all-inclusive firmware package (package_ALL) is now available.

There are four ways to update using the firmware package.

- **Removable media**
By downloading the firmware package to an SD card or USB flash drive in advance, you can update the firmware when there is no network connection.
- **RFU (Remote Firmware Update)**
You can have the firmware package sent from the call center to the machine over the network for automatic firmware update.
- **SFU (Smart Firmware Update)**
Operate the machine to download the firmware package from the server, either immediately or at the programmed date and time.
- **ARFU (Automatic Remote Firmware Update)**
The machine automatically checks the server for firmware packages every 76 hours. If there is a newer package than that on the machine, that package is downloaded for firmware update.

Types of firmware update files, supported update methods:

	SFU	Removable media	RFU	ARFU
Individual firmware* ¹	N/A	Available	Available	N/A

6. System Maintenance

	SFU	Removable media	RFU	ARFU
Firmware package	Available	Available	Available	Available

*1 Not available for this machine.

Firmware Types

Firmware Included in the Firmware Package

Firmware Type	Firmware Location	Message Displayed	
		IM C3500/C3000/C2500/C2000	IM C6000/C5500/C4500
IRIPS Font	Controller Board	GW8d_ips_fntl	
IRIPS Font	Controller Board	GW8e_ips_fntl	
System/Copy	Controller Board	MEMF3ABa_system	METMF3a_system
RemoteFax	Controller Board	METMF3a_fax2	
Scanner	Controller Board	METMF3a_scn	
NetworkDocBox	Controller Board	METMF3a_nfa	
Network Support	Controller Board	METMF3a_net	
Printer	Controller Board	MEMF3Ad_printer	MEMF3d_printer
Printer	Controller Board	MEMF3Ae_printer	MEMF3e_printer
MediaPrint:JPEG	Controller Board	MEMF3Ad_printer	MEMF3d_printer
MediaPrint:TIFFF	Controller Board	MEMF3Ad_printer	MEMF3d_printer
PCL	Controller Board	MEMF3eprt_PCL	
IRIPS PS3	Controller Board	MEMF3dprt_IPS3	
IRIPS PS3	Controller Board	MEMF3eprt_IPS3	
IRIPS PDF	Controller Board	MEMF3dprt_IPDF	
IRIPS PDF	Controller Board	MEMF3eprt_IPDF	
Engine	BiCU	METMF3Aa_eplot	METMF3Ca_eplot
Web Support	Controller Board	METMF3a_web	
Web Uapl	Controller Board	METMF3a_webua	
RPCS	Controller Board	METMF3dprt_RCS	
RPCS	Controller Board	METMF3eprt_RCS	
Option MSIS	Controller Board	METMF3dprt_msi	
RPCS Font	Controller Board	GW16dprt_font	
Font EXP	Controller Board	GW13eprt_SAMf	
Data Erase Onb	Controller Board	GW2a_zoffyxonb	
PSFont JIS2004	Controller Board	GW1d_ps_fntJIS1	
ADF	ADF	COOK-C_eadf	
ADF_SINAI-H	ADF	SINAI-H_eadf	

Firmware Type	Firmware Location	Message Displayed	
		IM C3500/C3000/C2500/C2000	IM C6000/C5500/C4500
Finisher	Finisher	RUBICON-C_efin	
Finisher	Finisher	No Option	VOLGA-E_efin
Finisher	Finisher	AMUR-C_efin	
Finisher	Finisher	AMUR-C-HY_efin	
Finisher	Finisher	UYUNI-B_efin	No Option
Folder	Folder	THAMES-C_efld	
Bank1	Bank	CANARI-D_ebank1	
Bank1	Bank	CANARI-E_ebank1	
Bank1	Bank	GOREE-D_ebank1	No Option
Bank1	Bank	CUBA-C_ebank1	
LCT	LCT	MALTA-B_elct	
PCL	Controller Board	MEMF3dprt_PCL	
Fax	Controller Board	METMF3a_fax	
Option RTIFF	Controller Board	METMF3dprt_RTF	
PS3	Controller Board	METMF3dprt_PS3	
PS3	Controller Board	METMF3eprt_PS3	
PDF	Controller Board	METMF3dprt_PDF	
PDF	Controller Board	METMF3eprt_PDF	
XPS	Controller Board	MEMF3aprt_XPS	
Option Eml	Controller Board	METMF3dprt_eml	
M2a_System	Smart Operation Panel	M2a_System	
M2a_BLEPlugin	Smart Operation Panel	M2a_BLEPlugin	
M2a_BluetoothSe	Smart Operation Panel	M2a_BluetoothSe	
M2a_CAP	Smart Operation Panel	M2a_CAP	
M2a_CAPjavaP	Smart Operation Panel	M2a_CAPjavaP	
M2a_CAPnfcP	Smart Operation Panel	M2a_CAPnfcP	
M2a_CAPumaP	Smart Operation Panel	M2a_CAPumaP	
M2a_CAPuser	Smart Operation Panel	M2a_CAPuser	

6. System Maintenance

Firmware Type	Firmware Location	Message Displayed	
		IM C3500/C3000/C2500/C2000	IM C6000/C5500/C4500
	Panel		
M2a_DeviceHub	Smart Operation Panel	M2a_DeviceHub	
M2a_ELPNX	Smart Operation Panel	M2a_ELPNX	
M2a_HelpService	Smart Operation Panel	M2a_HelpService	
M2a_ICCdDisptch	Smart Operation Panel	M2a_ICCdDisptch	
M2a_InstSetting	Smart Operation Panel	M2a_InstSetting	
GWFCU3.8- 22(WW)	FCU	GW1a_efax_fcu2H	
M2a_KrbServ	Smart Operation Panel	M2a_KrbServ	
M2a_MeidaPrtScn	Smart Operation Panel	M2a_MeidaPrtScn	
M2a_NFCPlugin	Smart Operation Panel	M2a_NFCPlugin	
M2a_PrinterInfo	Smart Operation Panel	M2a_PrinterInfo	
M2a_PrinterSJob	Smart Operation Panel	M2a_PrinterSJob	
M2a_ProgramInfo	Smart Operation Panel	M2a_ProgramInfo	
M2a_QRCode_SDC	Smart Operation Panel	M2a_QRCode_SDC	
M2a_QuickCdAuth	Smart Operation Panel	M2a_QuickCdAuth	
M2a_RemAssist	Smart Operation Panel	M2a_RemAssist	
M2a_RemPnlOpe	Smart Operation Panel	M2a_RemPnlOpe	
M2a_RemSptSvc	Smart Operation Panel	M2a_RemSptSvc	

Firmware Type	Firmware Location	Message Displayed	
		IM C3500/C3000/C2500/C2000	IM C6000/C5500/C4500
M2a_SimpleWFD	Smart Operation Panel	M2a_SimpleWFD	
M2a_SmartCopy	Smart Operation Panel	M2a_SmartCopy	
M2a_SmartFAX	Smart Operation Panel	M2a_SmartFAX	
M2a_SmartScan	Smart Operation Panel	M2a_SmartScan	
M2a_SmartScanEx	Smart Operation Panel	M2a_SmartScanEx	
M2a_USBCdPlugin	Smart Operation Panel	M2a_USBCdPlugin	
M2a_WEcolInfo	Smart Operation Panel	M2a_WEcolInfo	
M2a_WFaxInfo	Smart Operation Panel	M2a_WFaxInfo	
M2a_WLanguage	Smart Operation Panel	M2a_WLanguage	
M2a_WStopKey	Smart Operation Panel	M2a_WStopKey	
M2a_WTonner	Smart Operation Panel	M2a_WTonner	
M2a_WTray	Smart Operation Panel	M2a_WTray	
M2a_cspf	Smart Operation Panel	M2a_cspf	
M2a_iWnn	Smart Operation Panel	M2a_iWnn	
M2a_iWnn_Hang	Smart Operation Panel	M2a_iWnn_Hang	
M2a_iWnn_Hans	Smart Operation Panel	M2a_iWnn_Hans	
M2a_iWnn_Hant	Smart Operation Panel	M2a_iWnn_Hant	
M2a_zoo	Smart Operation Panel	M2a_zoo	

6. System Maintenance

Firmware Type	Firmware Location	Message Displayed	
		IM C3500/C3000/C2500/C2000	IM C6000/C5500/C4500
	Panel		
GraphicData	Smart Operation Panel	METMF3Aa_Graph	METMF3Ca_Graph
MovieData	Smart Operation Panel	MEMF3ABa_Movie	METMF3a_Movie
MovieData2	Smart Operation Panel	MEMF3ABa_Movie2	METMF3a_Movie2
MovieData3	Smart Operation Panel	MEMF3ABa_Movie3	METMF3a_Movie3
PowerSaving Sys	Controller Board	METMF3Aa_subcpu	METMF3Ca_subcpu

Firmware not included in the package

Firmware Type	Firmware Location	Message Displayed	
		IM C3500/C3000/C2500/C2000	IM C6000/C5500/C4500
Animation	Smart Operation Panel	MEMF3ABa_animat	METMF3a_animat



- Like the previous model, animation is updated by inserting the SD card into the SD card slot (bottom) at the back of the main unit.

Firmware Update (Removable Media)

Overview



- Removable media (SD card or USB flash drive) are a precision device, so when you handle them, respect the following.
- When the power is switched ON, do not insert or remove the removable media.
- During installation, do not switch the power OFF.
- Since the removable media is manufactured to high precision, do not store it in a hot or humid location, or in direct sunlight.
- Do not bend the removable media, scratch it, or give it a strong shock.
- Before downloading firmware to an SD card, check whether write-protection of the SD card is canceled. If write-protection is enabled, an error code (error code 44, etc.) will be displayed during download, and the download will fail.
- Before updating the firmware, remove the network cable from this machine.
- During software update, disconnect network cables and interface cables, remove wireless boards, etc., (so that they are not accessed during the update).

Media slot to use when updating

Using the SD card

Use SD Card Slot 2 [E: Lower Slot] on the back of the machine or the SD card slot [F] on the left side of the operation panel.



- When inserting into the slot, push the SD card until it clicks.
- Check whether the card is properly in the SD card slot. When an SD card is inserted, a click is heard, and it is locked.
- To remove the card, release by pressing once.

6. System Maintenance

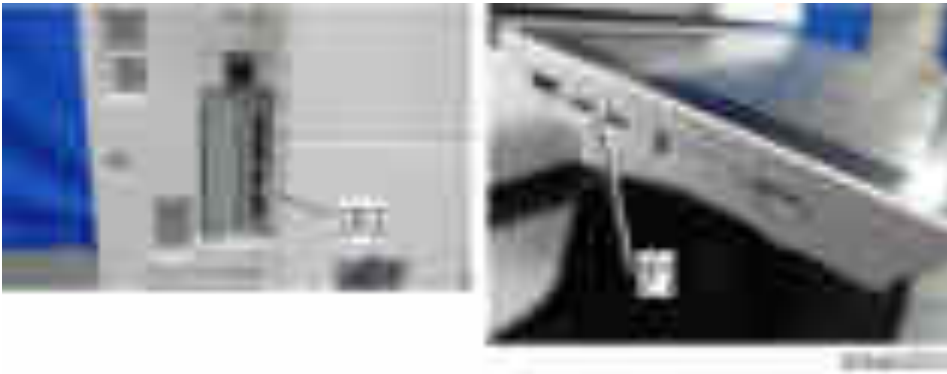

To use the SD card slot [E], remove the SD card slot cover [G] in the figure below.

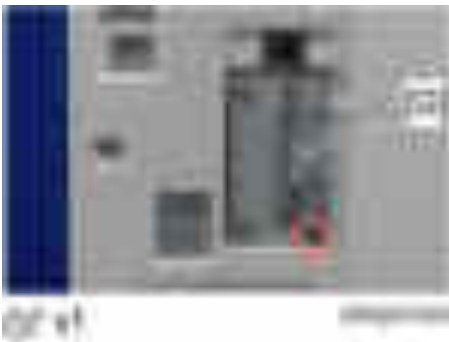

Using the USB Flash Drive

Use the USB slot [A] on the left side of the operation panel.



Update Procedure

Preparation

Download the latest version firmware to the removable media in advance.

Create a folder called “package” on the removable media, and then download the package firmware (xxxxxxx.pkg) to it.



- Do not put multiple machine firmware programs on the same SD card. Copy the only model firmware you want.
- If you download the firmware package to the “romdata” folder, which is the one normally used, the firmware package cannot be updated.
- When updating the firmware package of the same model, be sure to download each version separately. If you download multiple versions for the same model, only one of these versions is displayed on the machine’s operation panel, but which version is displayed is unpredictable.

Note for Update



- When the power supply is switched OFF during firmware update, the update is interrupted, and the power is switched ON again, normal operation cannot be guaranteed.
- To guarantee operation, an update error continues to be displayed until the update is successful.

In this case, insert the removable media again, switch the power ON, and continue download of firmware from the removable media automatically.

- The PS3 firmware program is included in the preinstalled PDF firmware. In the default state, although the PS3 firmware program is hidden in the disabled state, the function is enabled by installing the PS3 card. (The program installed in the PS3 card is a dongle (key) for enabling the PS3 function).
- Due to the above specification, the self-diagnosis result report shows the ROM module number /software version of the PDF firmware at the PS location.

Using the Slot on the Back of the Machine

- 1.** Turn OFF the main power.
- 2.** Insert the SD card into the SD card slot on the back of the machine.
- 3.** Turn ON the main power.

6. System Maintenance

Wait until the update screen starts (about 30 seconds).

When it appears, "Please Wait" is displayed.

- 4.** Select the package, and then press [Execute].



Display	Contents
ROM:	Display installed module number/version information.
NEW:	Display module number/version information in the card.

*The upper row corresponds to the module name, the lower row corresponds to the version number.

- 5.** After the data waiting screen is displayed, the update is automatically started. When the firmware update is complete, "Update done" is displayed.





The figures at the lower right of the display indicate "Number of updated items/ All items to be updated".

- 6.** Turning the main power OFF.
- 7.** Remove the SD card.
- 8.** Turn the main power ON again, and check whether the machine is operating normally.
- 9.** Return the SD card slot cover to the original position.

Using the Slot on the Operation Panel (Immediate Update)

- 1.** Enter the SP mode.
- 2.** Touch [Firmware Update].



- 3.** Touch [Media Update].



- 4.** When the following screen is displayed, insert the removable media into the slot on the operation panel and touch [OK].



6. System Maintenance

5. Touch [Execute].



6. Select the package, and then press [Execute].



7. After the data waiting screen is displayed, the update is automatically started. When the firmware update is complete, "Update done" is displayed.





The figures at the lower right of the display indicate "Number of updated items/ All items to be updated".

- 8.** Turning the main power OFF.
- 9.** Remove the removable media from the slot on the operation panel.
- 10.** Turn the main power ON again, and check whether the machine is operating normally.

Using the Slot on the Operation Panel (Reserve)

Firmware update can be executed at the programmed date and time.

- 1.** Enter the SP mode.
- 2.** Touch [Firmware Update].

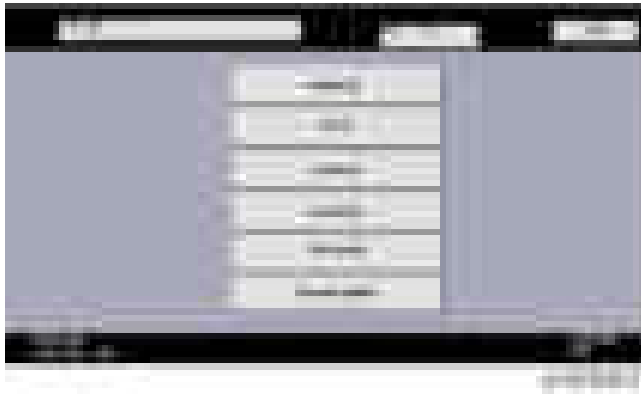

- 3.** Touch [Media Update].



- 4.** When the following screen is displayed, insert the removable media into the slot on the operation panel and touch [OK].



- 5.** Touch [Execute].

6. System Maintenance



6. Select the package, and then press [Execute].



7. Enter update date and time and specify the Retry Setting, then touch [Set].



In "Retry setting", it is set whether or not to retry when updating cannot be started depending on the state of the machine.

8. When the following screen is displayed, pull out the removable media from the slot on the

operation panel, and then touch [OK].



Firmware update is executed at the programmed date and time.



Whether updating is possible or not depends on ARFU setting. However, whether to start updating does not depend on SP5-886-111 (automatic update setting) setting.

Error Screens During Updating



EXX shows an error code.

For error codes, refer to the following table:

Error Code List

Code	Contents	Solutions
20	Physical address mapping cannot be performed.	<ul style="list-style-type: none"> Switch the main power supply off and on to try again. Re-insert the removable media to reboot it. Replace the controller board if the above solutions do not solve the problem.
21	Insufficient memory for the download	<ul style="list-style-type: none"> Switch the main power supply off and on to try again. Replace the controller board if the updating cannot be done by switching the power off and on.
22	Decompression of compressed data failed.	<ul style="list-style-type: none"> Switch the main power supply off and on to try again. Replace the removable media used for the

6. System Maintenance

Code	Contents	Solutions
		<p>update.</p> <ul style="list-style-type: none"> Replace the controller board if the above solutions do not solve the problem.
24	Removable media access error	<ul style="list-style-type: none"> Re-insert the removable media. Switch the main power supply off and on to try again. Replace the removable media used for the update. Replace the controller board if the above solutions do not solve the problem.
32	<p>The removable media used after download suspension is incorrect. Removable media is different between the one which was inserted before power interruption and the one which was inserted after the power interruption.</p>	<ul style="list-style-type: none"> Insert the removable media containing the same program as when the firmware update was suspended, and then switch the main power supply off and on to try again. There is a possibility that the removable media is damaged if the update cannot be done after the correct removable media has been inserted. In this case, try again with a different removable media. Replace the controller board if the above solutions do not solve the problem. Replace all relevant boards if the update is done for the BICU and FCU. Replace the operation panel unit if the update is done for the operation panel. After replacing the unit, update it using the same removable media. If the update is successful, this error code disappears.
33	<p>Removable media version error. The wrong removable media version is downloaded.</p>	<ul style="list-style-type: none"> Install the correct ROM update data for each version in the removable media.
34	<p>Destination error. A removable media for the wrong destination is inserted.</p>	<ul style="list-style-type: none"> Install the correct ROM update data for each destination (JPN/ EXP/ OEM) in the removable media.
35	<p>Model error. A removable media for the wrong model is inserted.</p>	<ul style="list-style-type: none"> Install the correct ROM update data for each model in the removable media.
36	Module error.	<ul style="list-style-type: none"> Install the program to be updated in advance.

Code	Contents	Solutions
	<p>The program to be downloaded does not exist on the main machine.</p> <p>The download destination specified by the removable media does not match up to the destination for the main machine's program.</p>	<ul style="list-style-type: none"> • There is a possibility that the removable media containing the program to be updated has not been mounted. Check to confirm that the removable media has been correctly mounted. • The removable media is incorrect if the program to be updated has been correctly installed. In this case, insert the correct removable media.
38	<p>The version of the downloaded program has not been authorized for the update.</p>	<ul style="list-style-type: none"> • Make sure that the program to be overwritten is the specified version.
40	<p>Engine download fails.</p>	<ul style="list-style-type: none"> • Switch the main power supply off and on to try again. • If this error occurs while using the media slot on the left side of the operation panel, perform a retry using the media slot on the back of the machine. • If the download fails again, replace the controller board and the BICU. • After replacing the unit, update it using the same removable media. If the update is successful, this error code disappears.
41	<p>Fax download fails.</p>	<ul style="list-style-type: none"> • Switch the main power supply off and on to try again. • If the download fails again, replace the controller board and the FCU board. • After replacing the unit, update it using the same removable media. If the update is successful, this error code disappears.
42	<p>Control panel/language download fails.</p>	<ul style="list-style-type: none"> • Switch the main power supply off and on to try again. • If the download fails again, replace the controller board and the operation panel unit. • After replacing the unit, update it using the same removable media. If the update is successful, this error code disappears.
43	<p>Printing download fails.</p>	<ul style="list-style-type: none"> • Switch the main power supply off and on to try

6. System Maintenance

Code	Contents	Solutions
		<p>again.</p> <ul style="list-style-type: none"> The removable media is damaged if the update fails again. Replace the removable media.
44	The data to be overwritten cannot be accessed when controller-related programs are downloaded.	<ul style="list-style-type: none"> Switch the main power supply off and on to try again. Install the correct ROM update data in the removable media. Replace the controller board if the data to be overwritten is contained on the controller board.
49	Firmware updates are currently prohibited.	<ul style="list-style-type: none"> The setting of Update Firmware in the Administrator Tools has been set to [Prohibit] by an administrator. Amend the setting to [Do not Prohibit] and try again.
50	The results of the electronic authorization check have rejected the update data.	<ul style="list-style-type: none"> Install the correct ROM update data in the removable media.
57	@Remote is not connected at the date/time reserved for receiving the package firmware update from the network.	<ul style="list-style-type: none"> Check the @Remote connection.
58	Update cannot be done due to a reception route problem.	<ul style="list-style-type: none"> Check the @Remote connection.
59	HDD is not mounted.	<ul style="list-style-type: none"> Check the HDD connection.
60	HDD could not be used during the package firmware update.	<ul style="list-style-type: none"> Try again. Replace the HDD if the download fails again.
61	The module ID for the package firmware update is incorrect.	<ul style="list-style-type: none"> Prepare the correct package files.
62	The configuration of the package firmware update files is incorrect.	<ul style="list-style-type: none"> Prepare the correct package files.
63	Reception fails due to the power off at the reserved date/time of the remote firmware update from the network.	<ul style="list-style-type: none"> Update is to be done automatically when the next reception time has elapsed.
64	Reception fails due to the power off at the reserved date/time of the package firmware update from the network.	<ul style="list-style-type: none"> Reset the reservation date/time for the remote update.
65	Reception fails due to the status error	<ul style="list-style-type: none"> Update is to be done automatically when the

Code	Contents	Solutions
	of the machine at the reserved date/time of the remote firmware update from the network.	next reception time has elapsed.
66	Reception failed due to the status error of the machine at the reserved date/time of the package firmware update from the network.	<ul style="list-style-type: none"> Reset the reservation date/time for the remote update.
67	Acquisition of the latest version information from the Gateway fails at the reserved date/time of the remote firmware update from the network.	<ul style="list-style-type: none"> Check that the network is connected correctly.
68	Acquisition of the latest version information from the Gateway fails.	<ul style="list-style-type: none"> Check that the network is connected correctly.
69	Download fails at the reserved date/time of the remote firmware update from the network.	<ul style="list-style-type: none"> Check that the network is connected correctly.
70	Package firmware download from the network fails.	<ul style="list-style-type: none"> Check that the network is connected correctly.
71	Network communication error occurs at the reserved date/time of the package firmware update from the network.	<ul style="list-style-type: none"> Check that the network is connected correctly.
72	The setting of @Remote is invalid at the reserved date/time of the package firmware update from the network.	<ul style="list-style-type: none"> Set the setting of @Remote Service in the Administrator Tools to [Do not Prohibit].
74	Package file decompression has failed.	<ul style="list-style-type: none"> If this occurred during the update by the removable media, check that the removable media is not defective, download the package again, and retry the update. If this occurred during the remote firmware update (WIM and utility) in the local environment, replace the package file in the local environment with the correct one and retry the update. If this has occurred on other occasions or keeps occurring even on the abovementioned occasions, replace the DIMM of the controller board. If it persists, replace the hard disk.

6. System Maintenance

Code	Contents	Solutions
75	The amount of update data has exceeded the limit. There is too much data in the removable media.	<ul style="list-style-type: none">• Move “fwu” in the “/romdata” directory out of that directory so that the same modules are not located in the same directory.
83	Package RFU reception has been canceled by the user.	<ul style="list-style-type: none">• Package RFU reception has been canceled by the user.
84	Package RFU reception timeout. The reception time has exceeded the limit (100 minutes).	<ul style="list-style-type: none">• Check the network connection.

Firmware Update (Smart Firmware Update)



- A HDD unit must be installed on the machine to enable the SFU or the package firmware update via media device.

Overview

Smart firmware update (SFU) is a system to download a firmware package. Since downloading the package takes time, SFU lets you schedule the download to take place when the machine is not in use, such as at night or at the weekend.

There are the following methods of updating using SFU.

1. Immediate Update: To update and download the firmware when visiting.
2. Update at the next visit: To set the date and time for firmware downloading. The firmware will be automatically downloaded beforehand and updated at the following visit.

"Update at the next visit" is recommended since firmware download may take some minutes due to the network condition.



- SFU requires the connection to @Remote via a device which has the embedded @Remote communicating function. When a machine is connected to @Remote via an intermediate device (RC Gate), the SFU function is disabled.

Immediate Update

Enter the [Firmware Update] menu in the SP mode and update the package firmware.



- The [Firmware Update] button will appear even when a machine is connected to @Remote with a device which does not have an embedded @Remote communicating function.
- If an error code is displayed, refer to [Error Screens During Updating](#).

- 1.** Enter the SP mode.

6. System Maintenance

2. Touch [Firmware Update].



3. Touch [Network Update].



4. Touch [Execute Update].

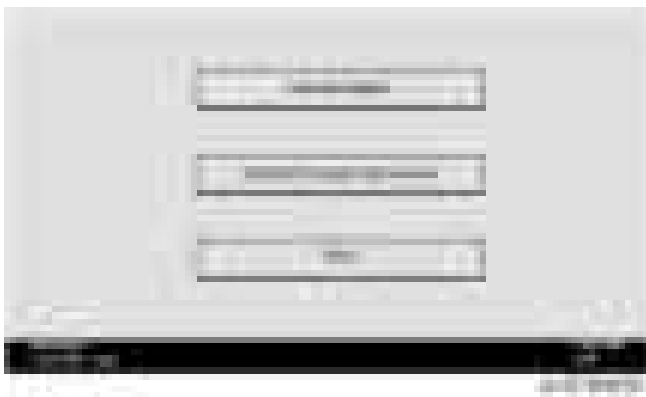

5. Touch [YES].



6. The following will be displayed.



- If the error code E66, which indicates that the download of the firmware has failed, is displayed, go back to step 1.
- The update will be started automatically after the download is finished.
- When the machine is in the update mode, the automatic update is suspended if a print job is started. After the print job is finished, touch [YES] button on the display, shown below, to restart updating.



7. [Update done] is displayed. The machine will automatically reboot itself.

6. System Maintenance



- The figures at the lower right of the display indicate "Number of updated items/ All items to be updated".

Update at the Next Visit (Reserve)

It is possible to set the machine to download the package firmware which is necessary for SFU in advance, and then perform the actual installation at the next service visit. This saves waiting time for the firmware to download at the service visit.

How to Set the Machine to Download Firmware Later (Reserve)

Enter the [Firmware Update] menu in the SP mode and update the package firmware.



- The [Firmware Update] button will appear even when a machine is connected to @Remote with a device which does not have an embedded @Remote communicating function. If an error code is displayed, refer to [Error Screens During Updating](#).

1. Enter the SP mode.

2. Touch [Firmware Update].

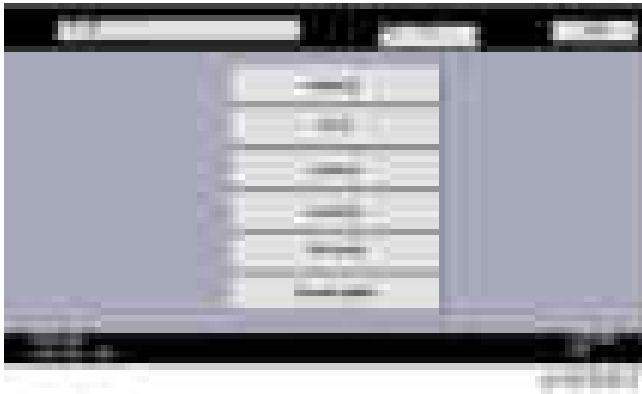

3. Touch [Reserve].



4. Touch [Reservation setting].



5. Enter the dates and times of the next visit and the start of receiving data.

- "Next time to visit this customer": The package firmware will be automatically downloaded by this time/date.
- "When to receive? (1-7)": The download of the package firmware will begin this number of days before the next visit.

6. System Maintenance



When reservation update by the media device is set, the update date and time is displayed.



Successful Download

In the two diagrams below, the firmware is set to be downloaded by the day before the next scheduled visit. In the first diagram, the download is successful on the first try. In the second diagram, the download fails three times and is successful on the fourth try.

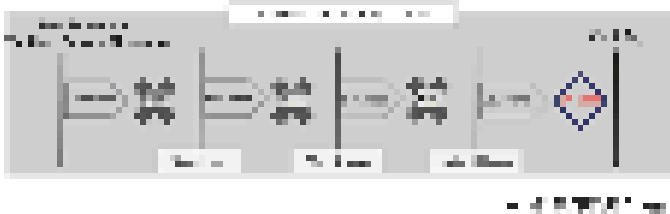

- If the firmware download fails or cannot be completed due to the network settings/condition, no power to the machine, or other reason, the machine will continue retrying every six hours until the scheduled deadline (up to a maximum of four tries). For example, if the download is set for the day before the next visit, the machine will attempt the download at 24 hours before the visit, and then continue trying every six hours (max. four tries total).
- The retry is only performed in cases when the firmware download has failed.
- If the machine is in Energy Saver mode when the download is scheduled to begin, the download

will be performed in the background and the machine/panel will stay in Energy Saver mode.

- The download will continue uninterrupted even if the customer initiates a print job, copy job, fax receiving or other operation while the download is in progress.
- The download will be terminated if the customer turns the power off while the download is in progress.
- If the download cannot be completed successfully by the time of the next scheduled visit, the machine will stop trying to download the firmware.

How to Check if the Firmware Downloaded with Reserve

- 1.** Enter the SP mode.
- 2.** Touch [Firmware Update].



- 3.** Touch [Reserve].



- 4.** Touch [Reserved package information].



- 5.** Check the information displayed.

When the package firmware was downloaded successfully, the details of the download result are displayed as the following picture shows.

6. System Maintenance



- This information will only be displayed if the reserved firmware has already been downloaded. If not, all the data items are indicated with "-".
- When reservation update by the media device is set, the package firmware information reserved from the media device is displayed.



How to Install Firmware Downloaded with Reserve

- 1.** Enter the SP mode.
- 2.** Touch [Firmware Update].



3. Touch [Network Update].



4. Touch [Execute Update].

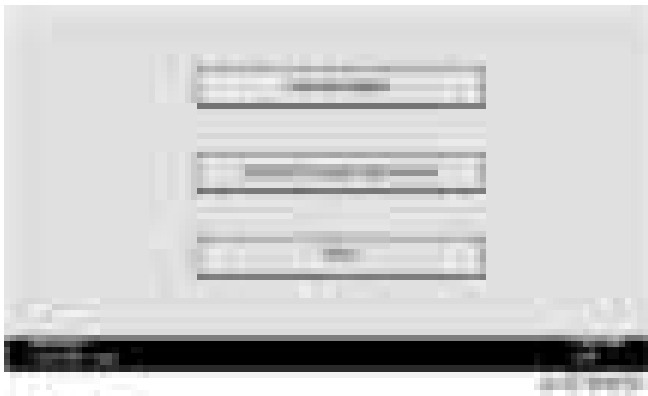

5. Check the version of the received package firmware, and then touch [YES].

- The update is started.



- If the version of the reserved package in the HDD is older than the latest version, the

6. System Maintenance

messages shown in the following picture are displayed.



- If you wish to download the latest version, touch [Execute] beside the message "Download and update the latest package." Then the update of the package firmware will be started.
- If you wish to update using the firmware in the HDD (old version), touch [Execute] beside the message "Update to the received package."

6. [Update done] is displayed.

- The machine will automatically reboot itself.

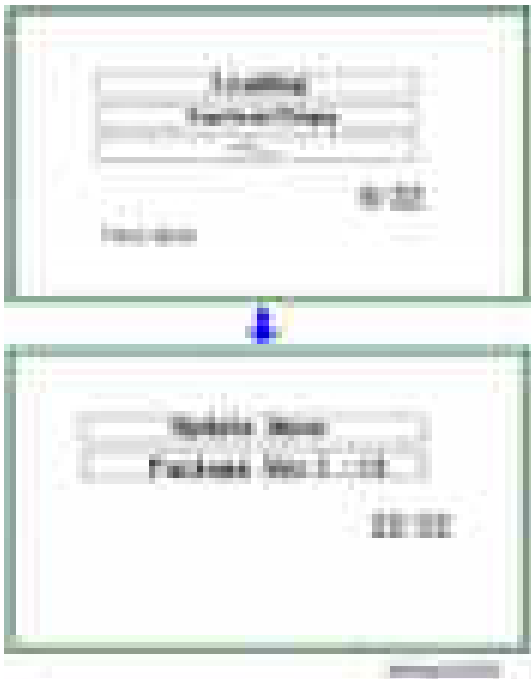

- The figures at the lower right of the display indicate "Number of updated items/ All items to be updated".

Firmware Update (Remote Firmware Update)

In this machine, the software can be updated by remote control using @Remote.



RFU Performable Condition

RFU is performable for a device which meets the following conditions.

1. The customer consents to the use of RFU.
2. The device is connected to a network via TCP/IP for @Remote.

Firmware Update (Auto Remote Firmware Update)



- Auto remote firmware update (ARFU) requires a connection to an external network. Be sure to get permission from the customer before setting.
- Internet connection is needed.

Overview

Using Auto Remote Firmware Update (ARFU), the machine checks package firmware files on the global server every 76 hours. If there is a version available newer than the one on the machine, the machine downloads the file to update the machine's package firmware.

Function Overview

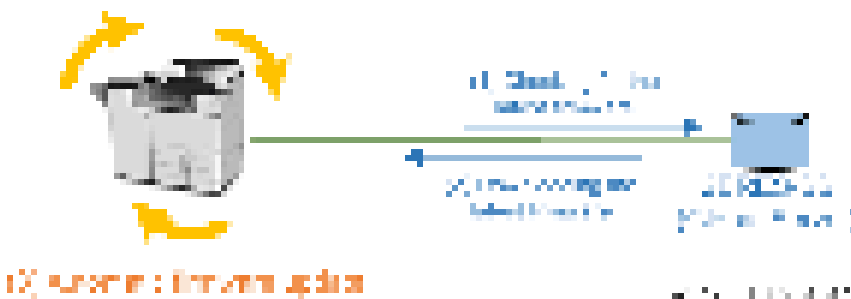

Downloading and Updating Process



Downloads the Latest Package

The machine accesses the server to check for latest package version.

If the version of the package on the global server is later than that of the package installed on the machine, or if the machine has not downloaded the firmware package, the machine downloads the latest package in the background even when the customer is using the machine.

If the download fails, the machine will retry downloading 76 hours later.

The downloaded package can also be used with SFU (Smart Firmware Update). A package downloaded with SFU (Smart Firmware Update) can be used with ARFU (Auto Remote Firmware Update) and vice versa.

When replacing the hard disk, information concerning the current firmware package becomes lost from the hard disk. So, even if the latest firmware is on the new hard disk, be sure to download the latest package data.

When the machine connects to the server where the package files are stored, the DNS settings and the name solution by DNS is needed. The machine will still try to download the package even if the name cannot be resolved, but will fail as the name is not resolved.

The time and date to send the next inquiry to the global server can be checked with SP5-886-116 (Farm Update Setting: Auto Update Next Date).

The auto remote firmware update is executed every 76 hours.

ARFU Update Determination

When the machine has successfully downloaded the latest package firmware file, or if the file has already been downloaded, the machine verifies whether a firmware update is necessary.

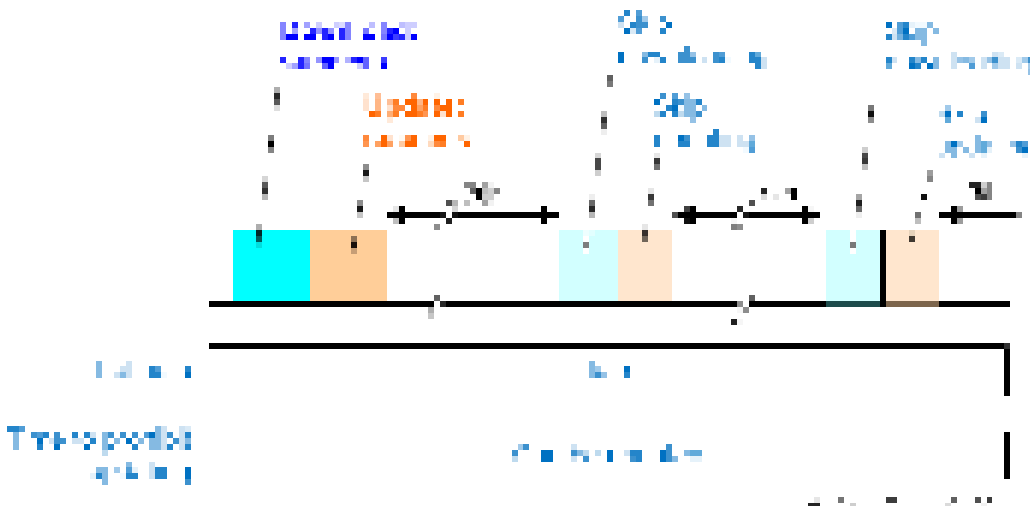

If the timing of determination is within the update prohibition period or day set in the SP configuration or Web Image Monitor, the machine will retry the firmware update determination 76 hours later.

6. System Maintenance

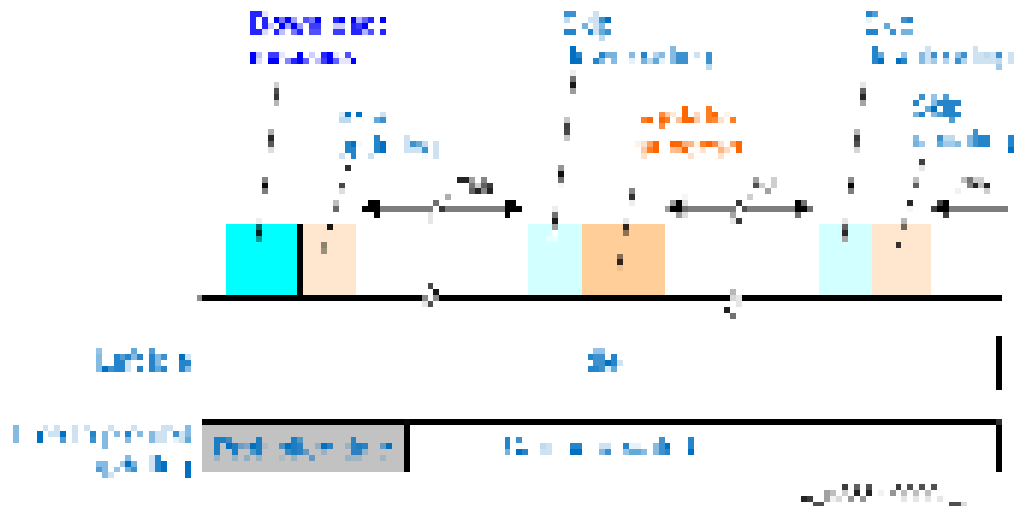

If the machine is in use at the time of firmware update, the machine will retry the update. The machine retries update up to three times at one-hour intervals (which can be changed in the SP configuration). If the machine is in use on all three retries, the machine will retry the update 76 hours later.

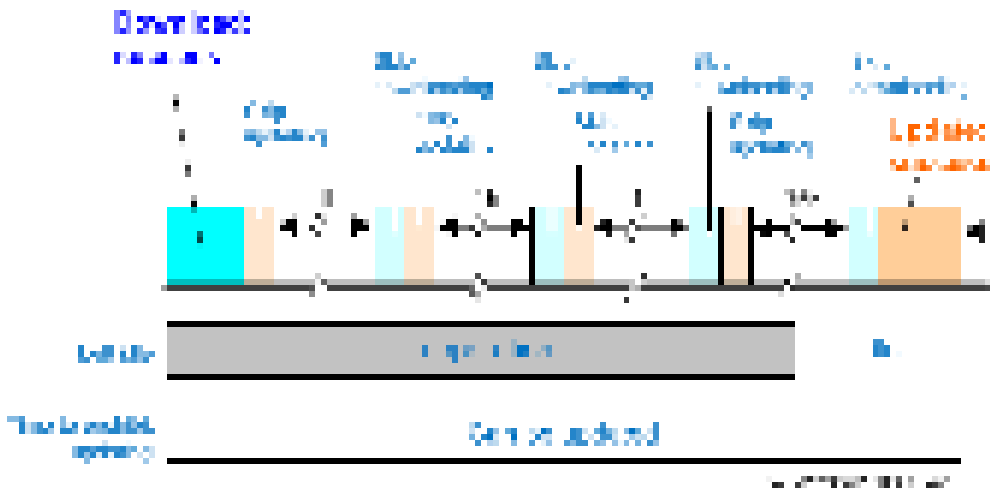

Situations in which the machine is determined to be in use

No.	Situations in which the machine is determined to be in use
1	When the operation panel is used within 30 seconds
2	During firmware update
3	While firmware update is disabled
4	While printing (copy, printer, fax, re-printing via network)
5	While scanning (copy, scanner, fax)
6	Retrieving image data via the network
7	While initial setting ([Settings] icon) or SP is being set
8	While fax is transferring data
9	During on-hook/on the handset
10	During the PC-FAX process (from PC to machine data transfer to the end of the job)
11	While switching to/from the energy saving mode

No.	Situations in which the machine is determined to be in use
12	When not being able to run the firmware update due to the modules that are running e.g.) Waiting for DCS transfer (refer to appendix), accessing devices such as HDD/SD card, etc.
13	While displaying a preview
14	While the document server function is in use
15	Connecting to TWAIN
16	During the interrupt copy process
17	While displaying the printer menu
18	While updating the display for the document server function via WIM or for stored fax documents
19	While writing log information
20	While accessing the address book
21	During SC
22	While shutting down
23	While importing/exporting SP settings
24	The interval between changing settings that require a reboot and actually rebooting (A reboot notification message pops up after changing the settings.)
25	While verifying the operation panel (smart panel)

Update Process

When the machine updates the firmware by Auto Remote Firmware Update (ARFU), a message dialog box opens to indicate the start of update.



“Cancel” and “OK” buttons appear in the dialog box. Update can be manually started by pressing “OK” or starts automatically if the button is not pressed for 30 seconds.

If “Cancel” is pressed, the machine will perform the same retry process as when the machine is in use at the time of update.

If the firmware update and three retries fail, the SC of the defective module during update will be displayed as the update error. If the following SC occurs, replacing the corresponding device restores the machine. The SC will not be reported to the call center.

6. System Maintenance

Device and corresponding SC number.

Device name	SC number
Engine board	SC845-01
Controller board	SC845-02
Operation panel (normal panel)*1	SC845-03
Operation panel (smart panel)	SC845-04
FCU	SC845-05

*1 Not available for this machine

Cancellation of update by user

Using the the operation panel, the user can cancel the update (including update through the retry process) being performed by Auto Remote Firmware Update (ARFU).



However, while the firmware of the operation panel is being updated, cancellation is not possible because the keys are disabled.

(Since the update of the operation panel firmware is performed at the end, you cannot cancel the update at this point.)

If the update is canceled, the machine will reboot when the firmware update of all modules included in the following parts is complete.

1. Engine Board
2. FCU
3. Controller Board

4. Operation Panel

For example, if the first firmware update for the Controller Board is canceled, the machine will reboot when the firmware update of all modules included in the Controller Board is complete.

The firmware configuration contained in the package is listed in the accompanying SERES release note.

If the update is canceled, it will be performed again 76 hours later. If there is a difference in version between the package obtained at that time and the one already stored (in other words, the one canceled), the old package will be discarded and the latest one will be received.

Related SP

SP Number	Selection Def.	Overview
SP5-886-111	0: OFF 1: ON	Sets auto update ON/OFF by ARFU.
SP5-886-112	0: OFF 1: ON	Will not run the update when update prohibited time setting is ON and the current time is in the range of the time set.
SP5-886-113	0 to 23 9	<ul style="list-style-type: none"> Start time < End time: Prohibited time is from the start time to the end time on the same day. Start time > End time: Prohibited time is from the start time to the end time on the next day. Start time == End time: Prohibited time setting is disabled. (Update will not be prohibited.)
SP5-886-114	0 to 23 17	
SP5-886-115	0: OFF 1: ON	Even when the auto update function is disabled, downloading the package is allowed. The downloaded package can be used with SFU.
SP5-886-116	Display only	Displays when the latest package check will run.
SP5-886-117	1 to 24 1	Set time for the next version check after retry.
SP5-886-120	0x00	The update will not run if the corresponding bit for each day below is set to 1. <ul style="list-style-type: none"> prohibited:bit7 Monday: bit 6 Tuesday: bit 5 Wednesday: bit 4 Thursday: bit 3 Friday: bit 2 Saturday: bit 1

6.System Maintenance

SP Number	Selection Def.	Overview
		<ul style="list-style-type: none"> Sunday: bit 0 <p>This setting is not affected by the prohibited time setting. e.g.) Prohibited on Mon., Fri., Sat., and Sun. : 0x47 (01000111)</p>
SP7-520-011 to 015	Display only	<p>History of date and time when the update has started.</p> <p>The five most recent are recorded, the lowest number being the most recent.</p> <p>If the last update failed, this is not recorded.</p>
SP7-520-021 to 025	Display only	<p>History of date and time when the update has finished.</p> <p>The five most recent are recorded, the lowest number being the most recent.</p> <p>The record is created when the update has successfully finished.</p> <p>When the update is canceled, no record is created.</p>
SP7-520-031 to 035	Display only	<p>History of the package number (including suffix) for which update has completed.</p> <p>The five most recent are recorded, the lowest number being the most recent.</p> <p>The record is created when the update has successfully finished.</p> <p>When the update is canceled, no record is created.</p>
SP7-520-041 to 045	Display only	<p>History of the package version for which update has completed.</p> <p>The five most recent are recorded, the lowest number being the most recent.</p> <p>The record is created when the update has successfully finished.</p> <p>When the update is canceled, no record is created.</p>
SP7-520-051 to 060	Display only	<p>History of the result of the download and the update.</p> <p>Refer below for the numbers set.</p>

Numbers set for the result history for SP7-520-051 to 060

No.	Result	Description
1	Downloading with SFU	Cannot download or update as the machine is now downloading the package for SFU.
2	HDD uninstalled	Cannot download or update as the machine has no HDD.
3	Updating with SFU	Cannot download or update as the machine is being updated with SFU.
4	HDD error	Cannot download or update as the HDD cannot be used.
5	Version information obtain error	Cannot download or update as the version information cannot be obtained.
6	Update download error	Cannot download or update as the update download

No.	Result	Description
		failed. In the non @Remote method, this shows that the download failed because there was no proxy set.
7	Name resolution error	Cannot download or update as the name cannot be resolved upon downloading the update.
8	Auto update setting disabled	The package has been downloaded but will not run the update as SP5-886-111 (auto update setting) is disabled and SP5-886-115 (auto download setting for SFU) is enabled.
9	Update prohibited time	Cannot start to update as the auto-update prohibited time setting (SP5-886-112) is enabled and the time update initiated was in the range of prohibited time (SP5-886-113 to 114). Or the day which update was initiated was a day for which update was prohibited (SP5-886-120).
10	Update postponed due to the machine in use	Cannot start update due to the following conditions when the update was initiated. <ul style="list-style-type: none"> • The machine is in use by a user (the panel was used within 30 seconds) • Machine offline for other reasons • Operation prohibited • Displaying SP/UP menu • The firmware update is running with another method • Configuration change prohibited • Verifying the operation panel (smart panel)
11	Update canceled by the user	The update was canceled because a user selected "Cancel" in the popup shown before starting the update.
12	Offline failed	Cannot start to update as the machine is offline for other reasons.
13	Update successful	The update was started and successfully completed.
14	Update failed	The update was started but failed.
15	Update canceled by the user after update initiated	The update was canceled after the process initiated because a user selected "Cancel" during the update.
16	Update deemed completed	The update was canceled after the process was initiated because a user selected "Cancel". There is no need to resume the update due to one of the following reasons: <ul style="list-style-type: none"> • A newer update has been released and received. • When retrying ARFU, the update has already been

6. System Maintenance

No.	Result	Description
		completed by another method.
17	Version information obtain error (proxy verification failure)	Cannot download or update as the proxy verification failed with proxy settings when obtaining version information.
18	Version information obtain error (other than proxy verification failure when the proxy is set)	Cannot download or update as an error other than proxy verification with proxy settings occurred when obtaining version information.
19	Update download error (proxy verification failure)	Cannot download or update as the proxy verification failed with proxy settings when downloading the package.
20	Update download error (other than proxy verification failure when the proxy is set)	Cannot download or update as an error other than proxy verification with proxy settings occurred when downloading the package.
22	Update by retry successful	<p>After a power failure, unsuccessful update, or rebooting, update by retry is executed successfully.</p> <p>However, this does not apply to the case where the update was canceled after the process was initiated because a user selected "Cancel".</p> <p>In this case, the update is "successful" if the retry is not executed between the start and completion of the next update (76 hours after the cancellation).</p>
23	Update data decompression has failed	<p>Receiving the update data successfully completed but failed to update because update data decompression failed.</p> <p>Data in the package file may be corrupted, or data may be garbled due to a defect in the DIMM or the HDD.</p>

Updating JavaVM

Overview

Updating Java VM is performed with a PC using the update tool.

Prepare the following items in advance.

- SD memory card reader/writer
- PC

The updating procedure is as follows.

1. Deactivate the SDK applications.
2. Remove the VM Card Type P13 from the main machine.
3. Update Java VM with the PC using the update tool.
4. Insert the VM Card Type P13 in the main machine.
5. Activate the SDK applications.

Deactivating SDK Applications and Removing the VM Card

Operation from Operation Panel

- 1.** Enable [Machine Management] of the administrator authentication, and log in as the machine administrator.
Select the [Settings] icon > [Machine Features Settings] > [System Settings] > [Administrator Tools] > [Administrator authentication] > [Machine Management]. Enable [Machine Management] and login as the machine administrator.
- 2.** Press the [Settings] icon on Home screen.
- 3.** Press [Machine Features Settings].
- 4.** Press [Extended Feature Settings] twice.
- 5.** Press the [Administrator Tools] tab and then [Heap / Stack Size Settings].
- 6.** Take a note of the current heap size settings in order to check them after version update.
- 7.** Return to the [Extended Feature Settings] screen, and press the [Startup Setting] tab.
- 8.** Disable all SDK applications except Java TM Platform.
- 9.** Press the SDK applications until the status changes from "Starting Up"/"Suspend"/"Ending" to "Stop".
- 10.** Press the [Extended Feature Info] tab.
- 11.** Press the stopped SDK applications to set "Auto Start" to "Off".

"Auto Start" settings can be enabled on this screen if Type-J SDK applications are enabled.
- 12.** Select [OK] > [Exit].
- 13.** Turn the main power OFF.
- 14.** Remove the SD card slot cover [A] (coin screw x 1).



6. System Maintenance



- 15.** Remove VM Card Type P13 from SD Card Slot 2 [A: Lower Slot].



Operation from Web Image Monitor

- 1.** Log in as the administrator from Web Image Monitor.
- 2.** Take a note of the current heap size setting in [Heap / Stack Size Settings].
[Device Management] -> [Configuration] -> [Extended Feature Settings] -> [Administrator Tools] -> [Heap / Stack Size Settings]
- 3.** Stop all SDK applications except for Java TM Platform.
 1. Display the [Startup Setting] menu.
[Device Management] -> [Configuration] -> [Extended Feature Settings] -> [Startup Setting]
 2. Check the radio button of the SDK application which status is "Starting Up".
 3. Click [Start Up/Stop] to stop the application.
 4. "Stop" is displayed in the status column.

- Do not change the status of Java TM Platform to "Stop".
- 4.** Make sure that "Auto Start" is set to "Off" for each SDK application.
 1. Click the [Details] icon () for each SDK application in [Startup Setting].
 2. Make sure that "Auto Start" is set to "Off". (Default: On)
- 5.** Turn the main power OFF.

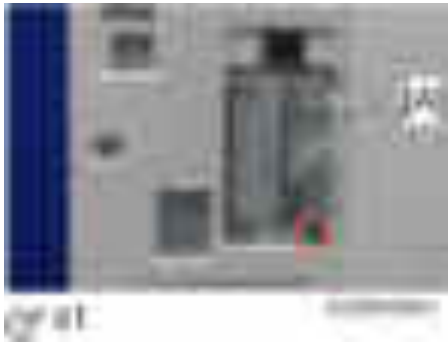
- 6.** Remove the SD card slot cover [A] (Coin screw x 1).



- 7.** Remove VM Card Type M37 from SD Card Slot 2 [A: Lower Slot].



Updating JavaVM and Inserting the VM Card

- 1.** Insert VM Card Type P13 into the SD memory card reader/writer of your PC.
- 2.** Check that the SD memory card reader/writer is detected on your PC, and then write down the drive letter. (If the SD memory card reader/writer is detected as (F:), the drive letter is "f")
- 3.** Download the update modules from the Firmware Download Center.
- 4.** Unzip the downloaded file, and then execute the .exe file.
- 5.** The folder is generated.
- 6.** Execute the .bat file in the folder.
- 7.** Input the drive letter following the message "Please input drive letter of SD card [a - x]: ". (If the SD memory card reader/writer is detected as (F:), input "f")



- 8.** Press the [Enter] key to start updating Java VM.
It takes 3 minutes to update Java VM.
- 9.** After completing the update, remove VM Card Type P13 from the SD memory card reader/writer of your PC.

6. System Maintenance

10. Insert VM Card Type P13 into SD Card Slot 2 (Lower slot) of the machine.

Activating SDK Applications

- 1.** Make sure that the VM card is fully inserted, and then turn the main power ON.
- 2.** Log in as the machine administrator from Operation panel / Web Image Monitor.
- 3.** Set "Auto Start" whose status is "OFF" to "On".
- 4.** Compare the current heap size settings and the values recorded before update.
If the settings are not the same as the recorded values, correct the settings to the recorded values.
- 5.** Enable the disabled SDK application.

NVRAM Data Upload/Download

Uploading Content of NVRAM to an SD card

Do the following procedure to upload SP code settings from NVRAM to an SD card.



- This data should always be uploaded to an SD card before the NVRAM is replaced.
- Make sure that the write protection of an SD card is unlocked.

- 1.** Do SP5-990-001 (SP Print Mode: All (Data List)) before you switch the machine off. You will need a record of the NVRAM settings if the upload fails.

Make sure to shut down and reboot the machine once before printing the SMC. Otherwise, the latest settings may not be collected when the SMC is printed.

- 2.** Turn OFF the main power.
- 3.** Remove the SD card slot cover [A].

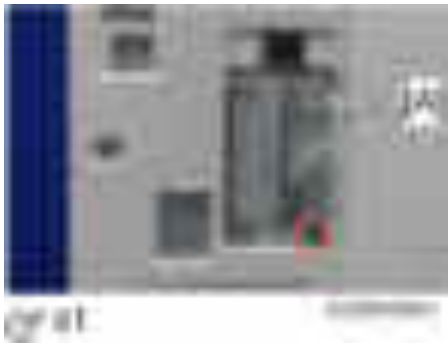

- 4.** Insert the SD card in Service Slot [A: Lower Slot].



- 5.** Turn ON the main power.
- 6.** Execute SP5-824-001 (NVRAM Data Upload) and then press the "Execute" key.
- 7.** The following files are copied to an NVRAM folder on the SD card when the upload procedure is finished. The file is saved to the path and the following filename:

NVRAM\<serial number>.NV

Here is an example with Serial Number "K5000017114":

NVRAM\K5000017114.NV

- 8.** In order to prevent an error during the download, be sure to mark the SD card that holds the

6. System Maintenance

uploaded data with the number of the machine from which the data was uploaded.



- You can upload NVRAM data from more than one machine to the same SD card.

Downloading an SD Card to NVRAM

Do the following procedure to download SP data from an SD card to the NVRAM in the machine.

- The NVRAM data download may fail if the SD card with the NVRAM data is damaged, or if the connection between the controller and BICU is defective.
- Do the download procedure again if the download fails.
- Do the following procedure if the second attempt fails:
- Enter the NVRAM data manually using the SMC print you created before uploading the NVRAM data.

- 1.** Turn OFF the main power.
- 2.** Remove the SD slot cover.
- 3.** Insert the SD card with the NVRAM data into SD Card Slot 2 (lower).
- 4.** Switch ON the main power.
- 5.** Do SP5-825-001 (NVRAM Data Download) and press the "Execute" key.



- The serial number of the file on the SD card must match the serial number of the machine for the NVRAM data to download successfully. The download fails if the serial numbers do not match.

This procedure does not download the following data to the NVRAM:

- Total Count
- C/O, P/O Count

Address Book Upload/Download

Information List

The following information is possible to be uploaded and downloaded.

Information	
<ul style="list-style-type: none"> • Registration No. • User Code • E-mail • Protection Code • Fax Destination • Fax Option • Group Name • Key Display 	<ul style="list-style-type: none"> • Select Title • Folder • Local Authentication • Folder Authentication • Account ACL • New Document Initial ACL • LDAP Authentication

Download

- 1.** Prepare a formatted SD card.
- 2.** Make sure that the write-protection on the SD card is off.
- 3.** Turn OFF the main power.
- 4.** Remove the SD card slot cover [A].

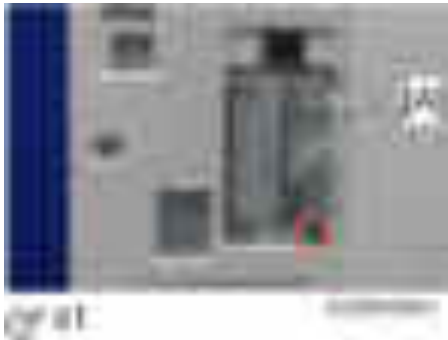

- 5.** Insert the SD card in service slot [A: Lower Slot].



- 6.** Enter the SP mode.
- 7.** Do SP5-846-051 (Backup All Addr Book).
- 8.** Exit the SP mode, and then turn OFF the main power switch.

6. System Maintenance

9. Remove the SD card from the SD card slot 2 (lower).

10. Install the SD slot cover.



- If the capacity of SD card is not enough to store the local user information, an error message is displayed.
- Carefully handle the SD card, which contains user information. Do not take it back to your location.

Upload

1. Turn OFF the main power.

2. Remove the SD slot cover at the left rear side of the machine.

3. Install the SD card, which has already been uploaded, into the SD card slot 2 (lower).

4. Turn ON the main power.

5. Enter the SP mode.

6. Do SP5-846-052 (Restore All Addr Book).

7. Exit the SP mode, and then turn OFF the main power switch.

8. Remove the SD card from the SD card slot 2 (lower).

9. Install the SD slot cover.



- The counter in the user code information is initialized after uploading.
- The information of an administrator and supervisor cannot be downloaded nor uploaded.
- If there is no data of address book information in the SD card, an error message is displayed.

Capturing the Device Logs

Overview

With this feature, you can save device logs that are stored in the machine (HDD or operation panel) on an SD card. It allows the Service Technician to save and retrieve error information for analysis.

The Capturing Log feature saves device logs for the following four.

- Controller device log including operation log
- Engine device log
- FCU device log
- Operation panel log



- In older models, a technician enabled the logging tool after a problem occurred. After that, when the problem had been reproduced, the technician was able to retrieve the device log.
- However, this new feature saves the device logs at the time that problems occur. Then you can copy the logs to an SD card.
- You can retrieve the device logs using an SD card without a network.
- Analysis of the device log is effective for problems caused by the software. Analysis of the device log is not valid for the selection of defective parts or problems caused by hardware.
- Make sure to shut down and reboot the machine once before retrieving the Debug Logs. Otherwise, the latest settings may not be collected when the debug logs are retrieved.

Types of device logs that can be saved

Type	Storage Timing	Destination (maximum storage capacity)
Controller device log including operation log	<ul style="list-style-type: none"> • Saved at all times 	HDD or SD card (4 GB) connected to the service slot. When the data gets over the capacity of the SD card, the older data is deleted.
Engine device log	<ul style="list-style-type: none"> • When an engine SC occurs • When paper feeding/output stop because of a jam • When the machine doors are opened during normal operation 	HDD or SD card connected to the service slot (Up to 300 times)
FCU device log	<ul style="list-style-type: none"> • When a specified amount of FCU device log is stored in the FCU. If fax application is unavailable (e.g. not installed), the machine 	HDD or SD card connected to the service slot

6. System Maintenance

Type	Storage Timing	Destination (maximum storage capacity)
	does not transfer the log.	
Operation panel log	<ul style="list-style-type: none">When an error related to the operation panel occurs.	Memory in the operation panel.

- **Device logs are not saved in the following conditions:**

- While erasing all memory
- While data encryption equipment is installed
- While changing the firmware configuration
- Forced power OFF (accidentally disconnecting the outlet)
- Engine device log while the machine is shutting down
- When the power supply to the HDD is off because of energy saving (engine OFF mode/STR mode)
- When one of the following SCs occurs: SC672, SC816, SC819, SC878, SC899, SC859, SC860, SC861, SC863, or SC864

- **The following logs are not saved:**

- Logs related to the energy saving mode (Engine-off, suspend-mode, or other cases)
- Network communication log
- Logs related to NRS
- IP-FAX log
- Access log for unauthorized users (guests)
- HTTP session timeout log
- Auto log-out log
- IC card related log
- Authorization for Fax

Security of the Operation Log

The following operation logs related to security are not saved.

- User ID
- Password
- IP address
- Telephone number
- Encryption key
- Transition to SP mode

Retrieving the Device Logs via Operation Panel



- Retrieve device logs to identify the date of occurrence of the problems and to find details of the problems
- e.g.: At around 8:00 am on March 10, an engine stall occurred. The operation panel does not respond. Turn the main power supply off / on.
- Analysis of the device log is effective for problems caused by the software. Analysis of the device log is not valid for the selection of defective parts or problems caused by hardware.

Procedure for Retrieving the Device Log with SD Card

- 1.** Insert the SD card into the slot on the side of the operation panel or the service slot.

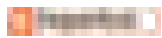

- It is recommended to use the SD card provided as a service part. Because the log data can be acquired much faster than when using commercially available SD cards.
- Insert the SD card into the machine's service slot instead of the SD slot on the side of the operation panel.

* The part number of the SD card with 2 GBs that is registered as a service part is "B6455030".

** The part number of the SD card with 8 GBs that is registered as a service part is "B6455040".

- 2.** Turn ON the main power.
- 3.** Enter SP mode.
- 4.** Specify the date that the problem occurred in SP5-858-101 (Start Date) by setting it to the year-month-day calendar format.
 - For example, if a problem occurred on February 1, 2015, the date should be set to "20150201", as shown above.
 - Be sure to confirm the date when the problem occurred before obtaining the logs.
- 5.** Specify the number of days to collect the logs in SP5-858-102 (Days of Tracing).
 - "2" is set by default, which is the minimum needed for investigating the problem.
 - A value of "1" to "180" can be set.
- 6.** Execute SP5-858-111 (Acquire All Info & Logs) to copy all of the log types to an SD card.

It is possible to obtain the logs separately by the following SPs.

SP	Collectable Information and/or Logs
SP5-858-111	All of the information and logs that are collected by executing the SPs from SP5-858-121 to SP5-858-145, and SMC.
SP5-858-121	Configuration page
SP5-858-122	Font page
SP5-858-	Print settings list

6. System Maintenance

SP	Collectable Information and/or Logs
123	
SP5-858-124	Error log
SP5-858-131	Fax information (whether the fax destinations are included or not depends on the setting of SP5-858-103.)
SP5-858-141	Controller log, engine log, operation panel log, FCU, and SMC.
SP5-858-142	Controller log
SP5-858-143	Engine log
SP5-858-144	Operation panel log
SP5-858-145	FCU log
SP5-992-001	SMC

- 7.** After executing the SP for copying the information and/or logs, a confirmation screen will appear. To proceed with obtaining the information and/or logs, tap "Execute".

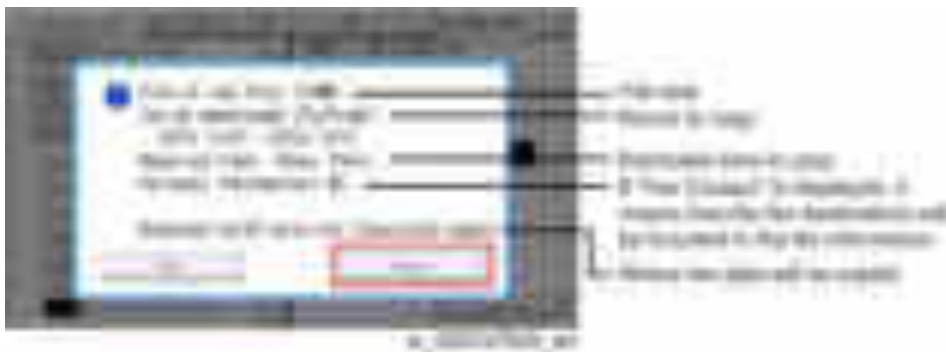

- The approximate time it takes to transfer the debug log is as follows. Transfer time may be affected by the type or format of the SD card.
 Controller device log (GW device log): 2 - 20 minutes
 Engine device log: 2 minutes
 Operation panel device log: 2 - 20 minutes

If the estimated time is not calculated due to an error, an error code will be displayed.

Error Code	Description
-1	Other.

Error Code	Description
-2	No SD card is inserted in the service slot or in the SD slot on the side of the operation panel. In this case, insert an SD card into either of the SD slots.
-3	The SD card is locked. In this case, unlock the SD card, as shown below.  [A]: Unlocked, [B]: Locked

- 8.** Wait for the information and/or logs to be copied to the SD card.



- 9.** After a message stating that the process has completed appears on the operation panel, confirm that the LED light next to the SD card slot is not flashing and then remove the SD card.
- 10.** Make sure that the SD card access LED is off, then remove the SD card.



- The process of obtaining logs fails in the following cases:
 - When the size of the logs to obtain exceeds the amount of space available on the SD card.
 - When the SD card is removed while the logs are being copied to it.
 - When the SD card is not formatted.
- If 'failed' appears on the touch panel display, turn the power off, and then recover from step 1 again.

Retrieving the Device Logs via Web Image Monitor

The device logs can be retrieved via the Web Image Monitor.

- 1.** Access the following URL and logon as an administrator:

[http://\[IP address or host name\]/web/entry/df/websys/direct/getSysInfo.cgi](http://[IP address or host name]/web/entry/df/websys/direct/getSysInfo.cgi)

6. System Maintenance

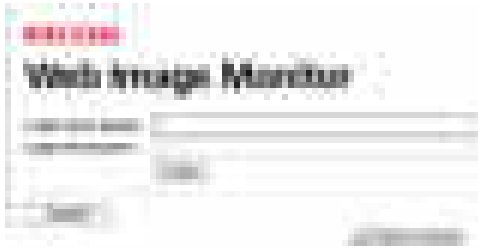

2. Specify the date that the problem occurred and the number of days to download the logs. If the fax destinations need to be included in the fax information, set "On" as "Obtain Fax Destination(s) Information". Then click "Calculate".



- "2" is set by default for "Number of days, including date fault occurred, to obtain".
- "Obtain Fax Destination(s) Information" is set to "Off" by default.

3. Click "Start".



4. The confirmation screen will appear and the information and/or logs will start downloading. To proceed to download the information and/or logs, wait for the open-or-save dialog to appear.





- To cancel downloading, click "Cancel".
- Operation panel when downloading the logs:

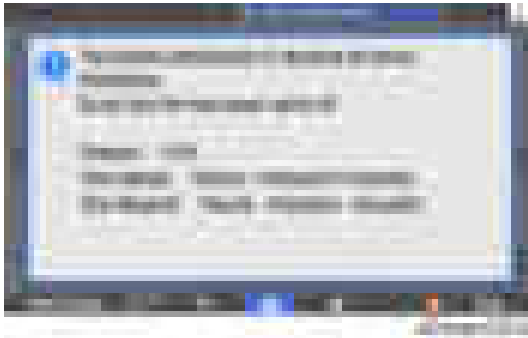

- 5.** After a while, the open-or-save dialog will appear. Specify where to download and save the file.



- The debug logs are saved with the following file names. These names are the same as the files downloaded with SD card.

Following device logs are saved.

- Engine1 debug log
- Condition data log
- Operation panel debug log
- FCU debug log
- Communication log (network packet)
- Configuration Page
- Printer Setting List
- Font List
- Error Log
- Fax information
- SMC
- SC819 log

SMC List Card Save Function

Overview

SMC List Card Save

The SMC List Card Save (SP Text Mode) function is used to save the SMC list as CSV files to the SD-card inserted into the operation panel SD-card slot.

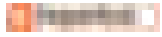

- Make sure to shut down and reboot the machine once before exporting the SMC sheet data. Otherwise, the latest settings may not be collected when the SMC is exported.

Procedure

- 1.** Turn OFF the main power.
- 2.** Insert the SD card into the operation panel SD-card slot, and then turn OFF the main power.
- 3.** Enter SP mode.
- 4.** Select "System SP".
- 5.** Select SP5-992-001 (SP Text Mode).
- 6.** Select a detail SP number shown below to save data on the SD card.

SP5-992-xxx (SP Text Mode)

Detail No.	SMC Categories to Save
001	All (Data List)
002	SP (Mode Data List)
003	User Program
004	Logging Data
005	Diagnostic Report
006	Non-Default
007	NIB Summary
008	Capture Log
021	Copier User Program
022	Scanner SP
023	Scanner User Program
024	SDK/J Summary
025	SDK/J Application Info
026	Printer SP
027	Smart Operation Panel SP
028	Smart Operation Panel UP

7. Press [EXECUTE].



8. Press [EXECUTE] again to start.



9. "It is executing it" is shown on the screen while executing.



- Press [CANCEL] to abort executing.

6. System Maintenance

10. Wait for 2 to 3 minutes until "Completed" is shown.



- The SMC list saving may take from 2 to 3 minutes to complete.

11. Press [Exit] to exit from SP mode.

File Names of the Saved SMC Lists

The SMC list data saved on the SD-card will be named automatically. The file naming rules are as follows.

Example:



A:

Machine serial number (fixed for each machine)

B:

SP number saved in this file.

First four digits (5992) in this part are fixed. The other one or two digits are the detail SP number(s). In this case, it is one digit. Therefore, this file is of SP5-992-001 (All data list). See the upper SP table for the correspondence between SP detail numbers and the contents.

C:

File creation date

Year/Month/Day ("Zero" will be omitted if each is one digit.)

D:

File creation time

Hour/Minute/Second ("Zero" will be omitted if each is one digit.)

E:

File Extension CSV (Comma Separated Value)

This part is fixed.



- A folder named by the machine serial number will be created on the SD card when this function is executed.
- This function can save the SMC list data only to an SD card inserted into the operation panel SD card slot.

Error Messages

SMC List Card Save error message:

- **Failed:**
FACTOR: Read-only file system, No space left on device.

If an error occurs, pressing the "Exit" will discard the existing the job and return to the ready state.

UP/SP Data Import/Export

UP Data Import/Export

Data that can be imported and exported

- Copier / Document Server Settings
- Printer Settings
- Scanner Settings
- Facsimile Settings
- Browser Features
- Program (Document Server)
- Program (Copier)
- Program (Scanner)
- Web Image Monitor Setting
- Web Service Settings
- System Settings
- Screen Features Settings
- Home screen customization settings*¹

*¹ Wallpaper cannot be exported if "Live Wallpaper" is selected.

Data that cannot be imported or exported

- Some System Settings *¹ *²

*¹ The setting for the date, settings that require the device certificate, and settings that need to be adjusted for each machine (for example, image adjustment settings) cannot be imported or exported.

*² Settings only for executing functions and settings only for viewing cannot be imported or exported.

- Extended Feature Settings
- Address book
- Programs (fax function)
- Programs (printer function)
- Settings that can be specified via telnet
- RICOH@Remote-related data
- Counters
- Settings that can only be specified via Web Image Monitor or Web Service (for example, Bonjour, SSDP setting)

Exporting Device Information

This can be exported / imported by an administrator with all privileges.

When exporting SP device information from the operation panel, the data is saved on an SD card.

- 1.** Insert an SD card into the media slot on the side of the operation panel.
- 2.** Log in from the operation panel as an administrator with all privileges.
- 3.** Press [Settings] on the Home screen > [Machine Features Settings] > [System Settings].
- 4.** Press [Administrator Tools].
- 5.** Press [Device Setting Information: Export (Memory Storage Device)].



- 6.** Set the export conditions.



- Specify whether to [Include] or [Exclude] the "Device Unique Information". "Device Unique Information" includes the IP address, host name, fax number, etc.
- Specify an encryption key.

- 7.** Press [Run Export].
- 8.** Press [OK].
- 9.** Press [Exit].
- 10.** Log out.



- If data export fails, the details of the error can be viewed in the log.
- When device Information is periodically imported, it is necessary to create the device setting information file with special software and store it on the web server.

Importing Device Information

This can be exported / imported by an administrator with all privileges.

6. System Maintenance

Import device information saved on an SD card.

- 1.** Insert an SD card into the media slot on the side of the operation panel.
- 2.** Log in from the operation panel as an administrator with all privileges.
- 3.** Press [Settings] on the Home screen > [Machine Features Settings] > [System Settings].
- 4.** Press [Administrator Tools].
- 5.** Press [Device Setting Information: Import (Memory Storage Device)].
- 6.** Configure the import conditions.

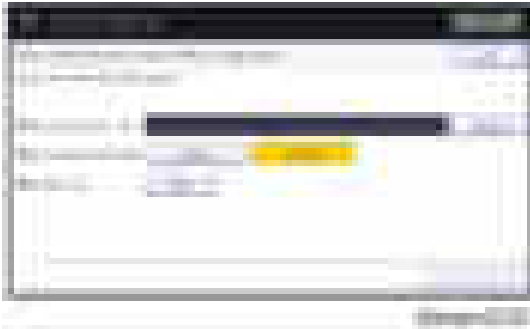

- Press [Select] of the "Device Setting Info. File" to select the file(s) to import.
 - Specify whether to [Include] or [Exclude] the "Device Unique Information". "Device Unique Information" includes the IP address, host name, fax number, etc.
 - Enter the encryption key that was specified when the file was exported.
- 7.** Press [Run Import].
 - 8.** Press [OK].
 - 9.** Press [Exit].
- The machine restarts.



- If data export fails, the details of the error can be viewed in the log.

SP Data Import/Export

Data that can be imported and exported

- System SP
- Printer SP
- Fax SP
- Scanner SP

Exporting Device Information

When exporting SP device information from the operation panel, the data is saved on an SD card.

- 1.** Insert an SD card into the media slot on the side of the operation panel.
- 2.** Enter SP mode.
- 3.** Press SP5-749-001 (Import/Export: Export)
- 4.** Select "Target" SP settings (System/Printer/Fax/Scanner/Smart Operation Panel) to be exported.

5. Select "Option" settings (Unique/Secret).

Item	Specification	Note
Unique	Unique information of the machine is included in the exported file if you select "Unique" setting.	<p>Unique information that can be updated</p> <p>#1. Items that are to be used to identify the machine. Example: Network Information/ Host name / Information related to fax number /Mail address assigned to the machine</p> <p>#2. Items for specifying the options equipped on the machine. Example: Lot number for developer</p> <p>Unique information that cannot be updated</p> <p>#1. Items that may cause a problem if imported Example: Serial number / Information related to @Remote</p> <p>#2. Items for managing the history of the machine Example: Time and date / Counter information / Installation date</p> <p>#3. Setting values for the Engine</p>
Secret	Secret information is exported if you select "Secret" setting.	<p>Secret information</p> <p>#1. Data that cannot be exported without being encrypted. (Exported data is encrypted.) Example: Password / Encryption key / PIN code</p> <p>#2. Confidential information for the customer Example: User name / User ID / Department code / Mail address / Phone number</p> <p>#3. Personal information Example: Document name / Image data</p> <p>#4. Sensitive information for the customer Example: MAC address / Network parameters</p>

* The IP address is exported when both 'Unique' and 'Secret' are selected.

6. Select "Crpt config" setting (Encryption).

Encryption	Select whether to encrypt or not	If the encryption function is used, setting of
------------	----------------------------------	--

6. System Maintenance

	when exporting. If you push the "Encryption" key, you can export secret information.	an encryption key is required by direct input. <ul style="list-style-type: none">• Type the arbitrary password using the soft keyboard• Can enter up to 32 characters
--	---	--

7. Press [Execute].

8. Press [OK].



- If data export fails, the details of the error can be viewed in the log.

Importing Device Information

Import device information saved on an SD card.

1. Insert an SD card into the media slot on the side of the operation panel.

2. Enter SP mode.

3. Press SP5-749-101 (Import/Export: Import)

4. Select a unique setting.

5. Press [Encryption Key], if the encryption key was created when the file was exported.

6. Select an encryption setting.

Unique	If you want to apply the unique information to the target machine, select the "Unique" key.	Refer to the above information.
Encryption	If an encrypted file is selected as the import file, this setting is required.	

7. Press [Execute].

8. Press [OK].



- If data export fails, the details of the error can be viewed in the log.

Possible solutions for import/export problems

The access log file is created when export/import is executed. The file is stored in the same location as the exported device setting information file.

If an error occurs, check the log's result code in the access log file first. Values other than 0 indicate that an error occurred.

The result code will appear in the circled area illustrated below.

- Example of a log file



If you cannot solve the problem or do not know how to solve it after checking the code, note down the error log entry, then contact your supervisor.

Result Code	Cause	Solutions
2 (INVALID REQUEST)	A file import was attempted between different models or machines with different device configurations.	Import files exported from the same model with the same device configurations.
4 (INVALID OUTPUT DIR)	Failed to write the device information to the destination device.	Check whether the destination device is operating normally.
7(MODULE ERROR)	An unexpected error occurred during import or export.	Switch the power off and then back on, and then try the operation again. If the error persists, contact your supervisor.
8 (DISK FULL)	The available storage space on the external medium is insufficient.	Execute the operation again after making sure there is enough storage space.
9 (DEVICE ERROR)	Failed to write or read the log file.	Check whether the path to the folder for storing the file or the folder in which the file is stored is missing.
10 (LOG ERROR)	The hard disk is faulty.	Contact your supervisor.
20 (PART FAILED)	Failed to import some settings.	The reason for the failure is logged in "NgCode". Check the code. Reason for the Error (Ng-Name) 2. INVALID VALUE The specified value exceeds the allowable range. 3. PERMISSION ERROR The permission to edit the setting is missing.

6. System Maintenance

Result Code	Cause	Solutions
		<p>4. NOT EXIST The setting does not exist in the system.</p> <p>5. INTERLOCK ERROR The setting cannot be changed because of the system status or interlocking with other specified settings.</p> <p>6. OTHER ERROR The setting cannot be changed for some other reason.</p>
21 (INVALID FILE)	Failed to import the file because it is in the wrong format in the external medium.	Check whether the file format is correct. The import file should be a CSV file.
22 (INVALID KEY)	The encryption key is not valid.	Use the correct encryption key.



- When exporting device information from the operation panel, the data can be saved only on an SD card.
- The file format for exports is CSV.

Card Save Function

Overview

Card Save:

- The Card Save function is used to save print jobs received by the printer on an SD card with no print output. Card Save mode is toggled using printer Bit Switch #1 bit number 4. Card Save will remain enabled until the SD card becomes full, or until all file names have been used.
- Captures are stored on the SD card in the folder /prt/cardsave. File names are assigned sequentially from PRT00000.prn to PRT99999.prn. An additional file PRT.CTL will be created. This file contains a list of all files created on the card by the card save function.
- Previously stored files on the SD card can be overwritten or left intact. Card Save SD has "Add" and "New" menu items.
 - **Card Save (Add):** Appends files to the SD Card. Does not overwrite existing files. If the card becomes full or if all file names are used, an error will be displayed on the operation panel. Subsequent jobs will not be stored.
 - **Card Save (New):** Overwrites files in the card's /prt/cardsave directory.

Limitation:

- Card Save cannot be used with PJL Status Readback commands. PJL Status Readbacks will not work. In addition they will cause the Card Save to fail.

Procedure

1. Turn OFF the main power.
2. Insert the SD card into slot 2 (lower), then turn ON the main power.
3. Enter SP mode.
4. Select the "Printer SP".
5. Select SP-1001 "Bit Switch".



6. Select "Bit Switch 1 Settings" and use the numeric keypad to turn bit 4 ON and then press the "#" to register the change. The result should look like: 00010000. By doing this, Card Save option will

6. System Maintenance

appear in the "List/Test Print" menu.

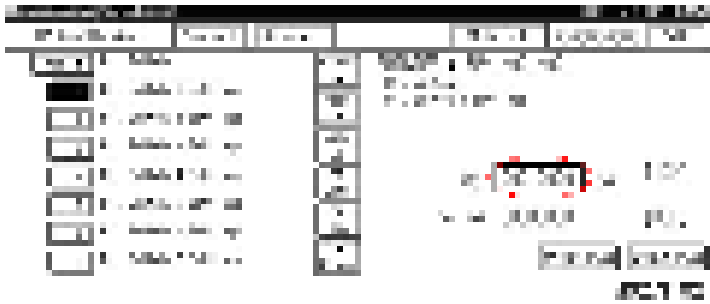

- 7.** Press "Exit" to exit SP Mode.
- 8.** Press the "Settings" icon > "Machine Features Settings".
- 9.** Select "Printer Settings".



- 10.** "Card Save (ADD)" and "Card Save (NEW)" should be displayed on the screen. Select "Card Save (ADD)" or "Card Save (NEW)".

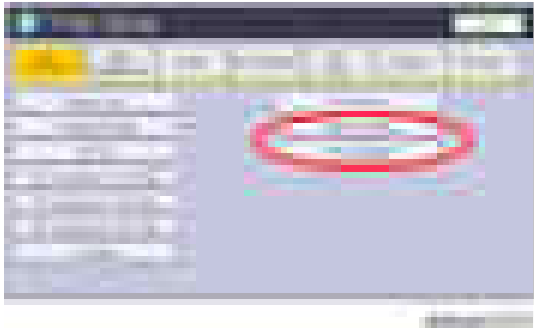

- 11.** Press "OK" and then return to Home screen.



- 12.** Press the "Printer (Classic)" icon.



- 13.** "Card Save" is displayed in the top left of the display panel.

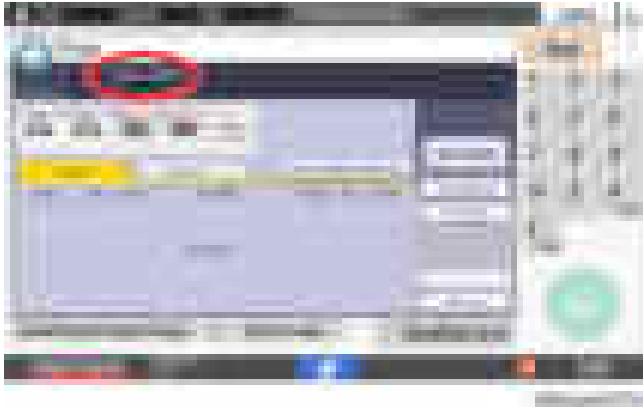

- 14.** Send a job to the printer. The Communicating light should start blinking.

- 15.** As soon as the printer receives the data, it will be stored on the SD card automatically with no print output.

Nothing is displayed on the screen, indicating that a Card Save operation was successful.

- 16.** Press "Reset" to exit Card Save mode.



- 17.** Change the Bit Switch Settings back to the default 00000000, then press the "#" in the numeric keypad to register the changes.

- 18.** Remove the SD card after the main power switch is turned OFF.

Error Messages

Card Save error messages:

- **Init error:** A card save process (e.g. card detection, change to kernel mode) failed to initialize.
- **Card not found:** Card cannot be detected in the slot.

6. System Maintenance

- **No memory:** Insufficient working memory to process the job.
- **Write error:** Failed to write to the card.
- **Other error:** An unknown error occurred.

If an error occurs, pressing "OK" will cause the device to discard the job and return to the ready state.

Test Pattern Printing



- Do not operate the machine until the test pattern is printed out completely. Otherwise, SC will occur.

- Enter the SP mode, and then select **SP2-109-003**.
- Select the test pattern to print from the list, and then press [OK].

No.	Pattern	No.	Pattern
0	Copy image	12	Independent Pattern (2dot)
1	Vertical Line (1dot)	13	Independent Pattern (4dot)
2	Vertical Line (2dot)	14	Trimming Area
3	Horizontal Line (1dot)	15	Hound's Tooth Check (Vertical)
4	Horizontal Line (2dot)	16	Hound's Tooth Check (Horizontal)
5	Grid Vertical Line	17	Band (Horizontal)
6	Grid Horizontal Line	18	Band (Vertical)
7	Grid Pattern Small	19	Checker Flag Pattern
8	Grid Pattern Large	20	Grayscale (Vertical Margin)
9	Argyle Pattern Small	21	Grayscale (Horizontal Margin)
10	Argyle Pattern Large	22	Wormy Pattern
11	Independent Pattern (1dot)	23	Full Dot Pattern

- Select **SP2-109-005** (1: Full Color, 2: Cyan, 3: Magenta, 4: Yellow, 5: Black) to select the printing color.
- To change the density of test pattern, select density with **SP2-109-006** to **009** for each color.



- If select "0" with **SP2-109-006** through 009, the color adjusted so will not show up in the test pattern.

- To print out the test pattern, press "Copy Window", then specify the settings on the copier application for test print (paper size etc...).
- Press "Start" to start the test print.
- After checking the test pattern, press "SP Mode" on the LCD to return to SP mode display.
- Restore all settings to their original values.
- Exit the SP mode.

7. Detailed Descriptions

Product Overview

Component Layout



- For details about electrical components layout, refer to [Detailed Descriptions](#).

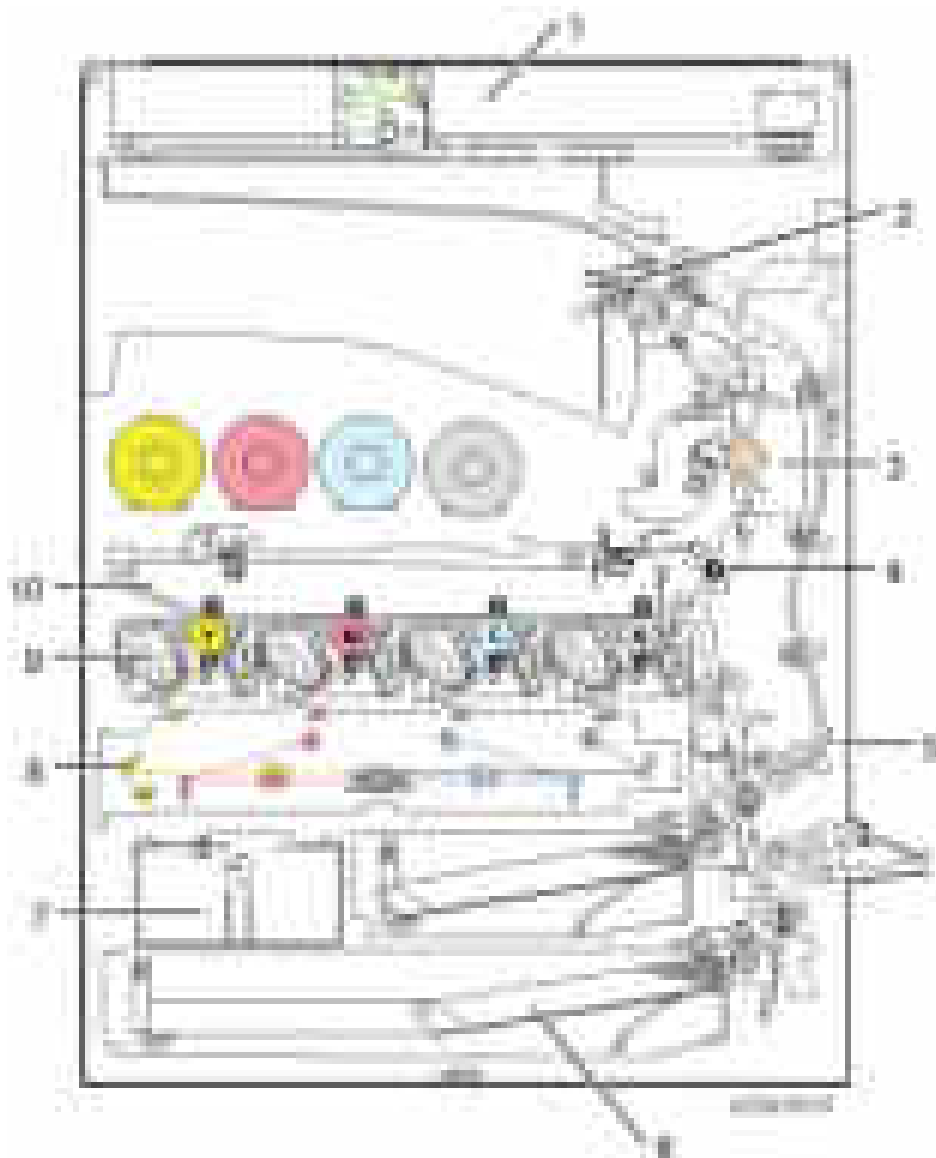

No.	Description	No.	Description
1	Scanner Unit	6	Paper Feed Unit
2	Paper Exit Unit	7	Waste Toner Unit
3	Fusing Unit	8	Laser Exposure Unit
4	Paper Transfer Unit	9	PCDU

No.	Description	No.	Description
5	Duplex Unit	10	Image Transfer Unit

Paper Path

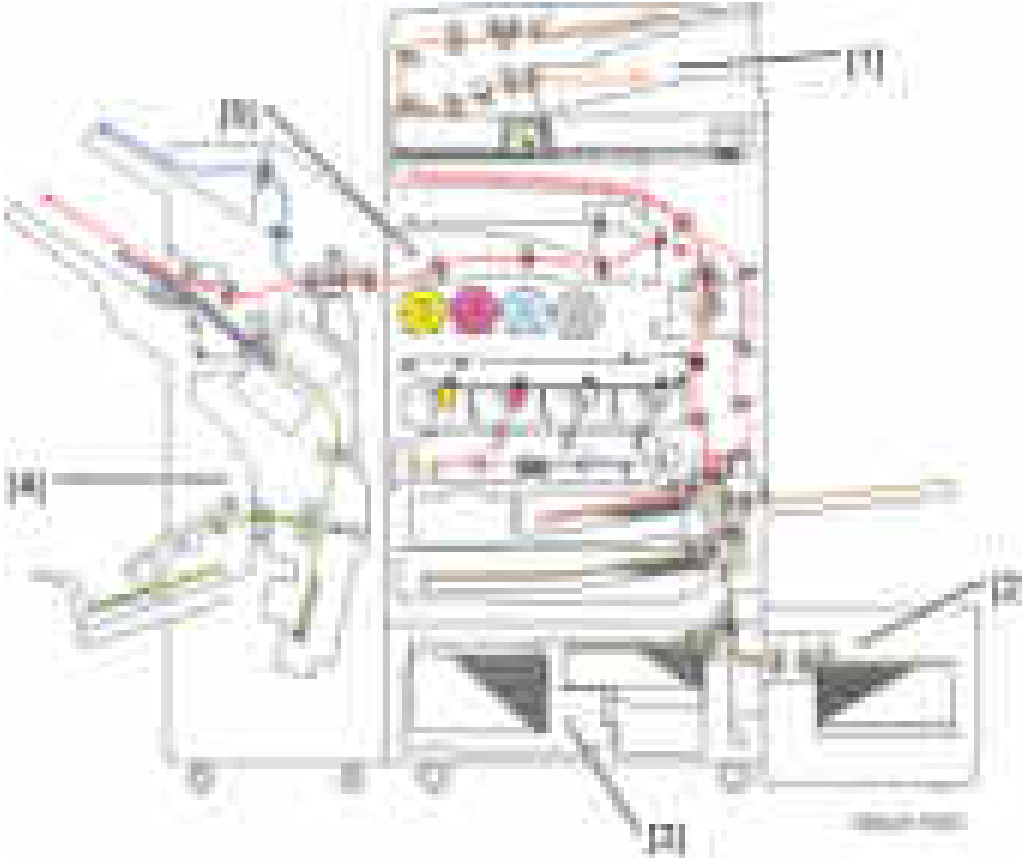

No.	Description	No.	Description
1	SPDF DF3120	4	Booklet Finisher SR3270
2	LCIT RT3040	5	Bridge Unit BU3090
3	LCIT PB3290	-	-

7.Detailed Descriptions

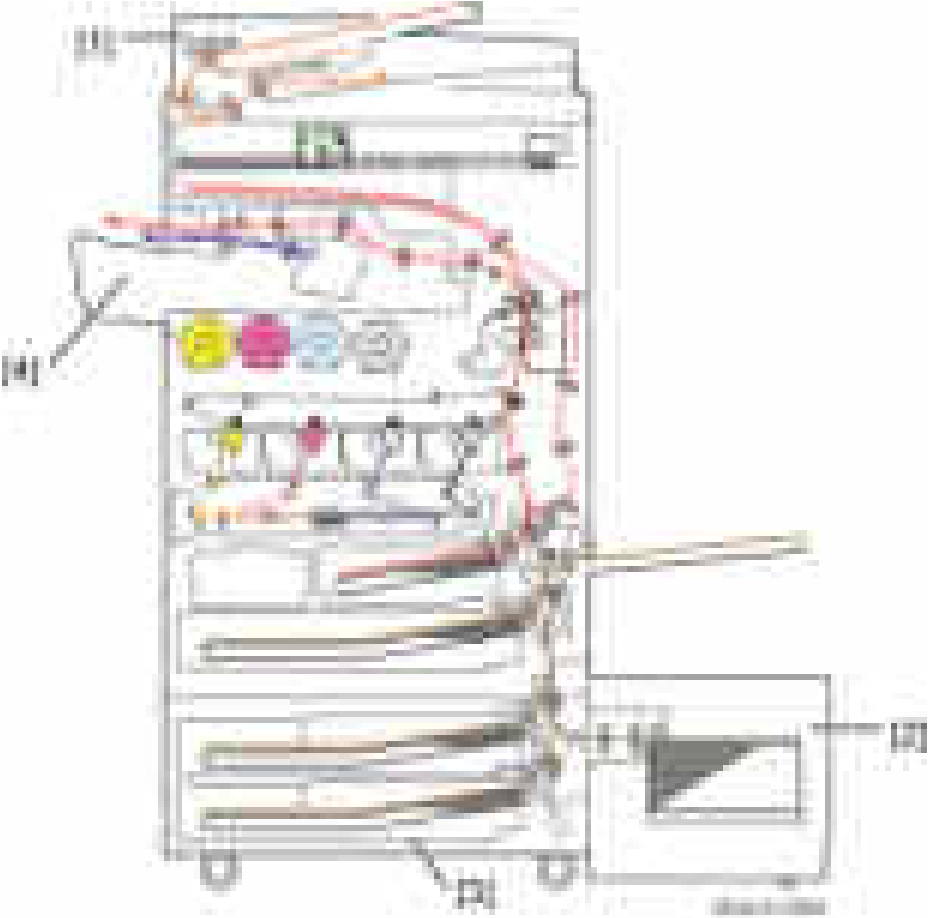

No.	Description	No.	Description
1	ARDF DF3110	3	Paper Feed Unit PB3280 / Paper Feed Unit PB3300
2	LCIT RT3040	4	Internal Finisher SR3250

7.Detailed Descriptions

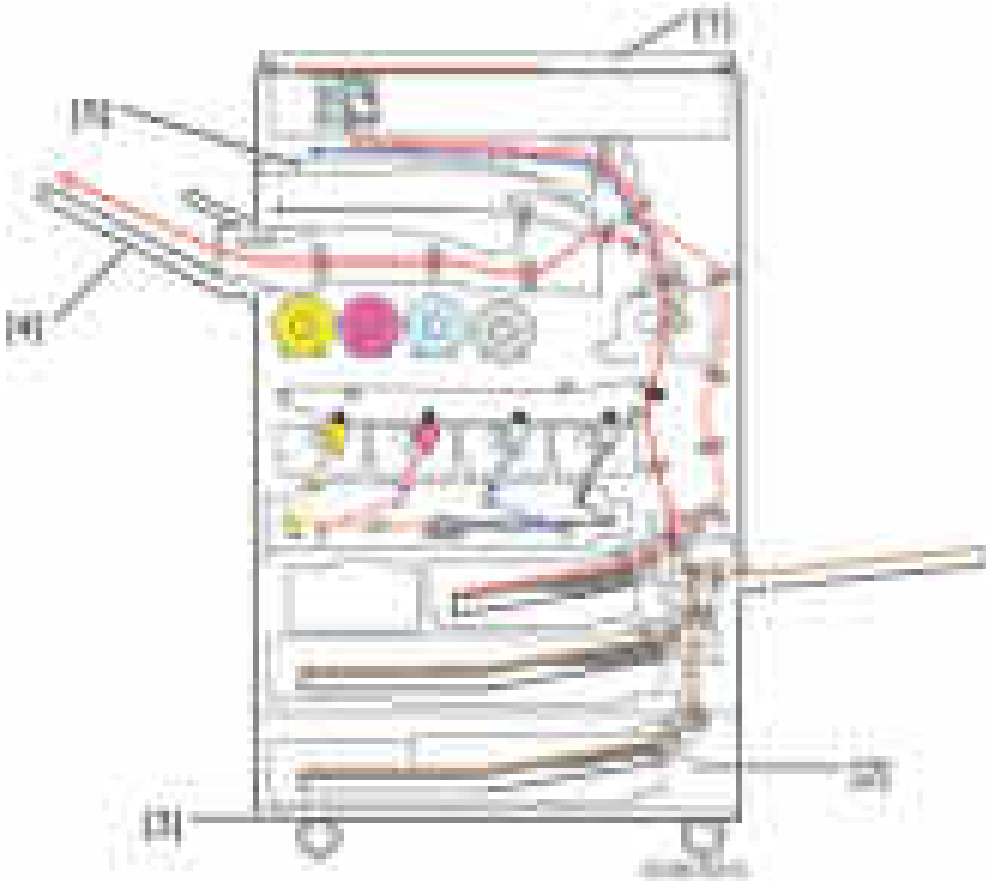

No.	Description	No.	Description
1	Platen Cover PN2000	4	Side Tray Type M37
2	Paper Feed Unit PB3270	5	1 Bin Tray BN3130
3	Caster Table Type M3	-	-

7.Detailed Descriptions

Drive Layout

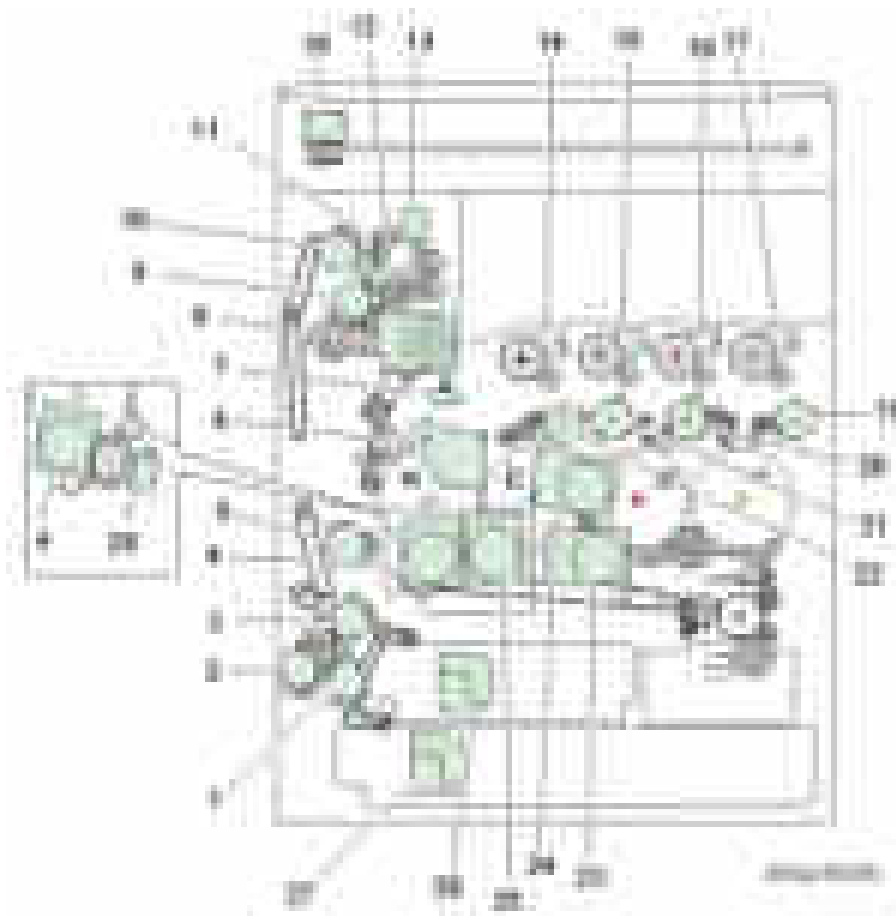

No.	Description	No.	Description
1	Paper feed motor (M6)	15	Toner bottle drive motor (C) (M12)
2	Bypass/duplex motor (M2)	16	Toner bottle drive motor (M) (M13) (ITB contact and release motor)
3	Transport motor (M5)	17	Toner bottle drive motor (Y) (M14)
4	PCU: Black / Image Transfer Motor (M17)	18	Scanner motor (M26)
5	Registration motor (M7)	19	Toner supply motor (Y) (M22)
6	Paper transfer contact and release motor (M18)	20	Toner supply motor (M) (M21)
7	Shield drive motor (M28) *1	21	Toner supply motor (C) (M20)
8	Fusing motor (M8)	22	Toner supply motor (Bk) (M19)
9	Paper exit/pressure release motor (M4)	23	Development motor: CMY (M16)
10	Duplex entrance motor (M1)	24	PCU Motor: CMY (M15)
11	Fusing exit drive solenoid (SOL3)	25	Development Motor: Black (M29) *1
12	Reverse motor (M3)	26	Lift motor (1st feed tray) (M9)
13	Paper Exit Solenoid (SOL2)	27	Lift motor (2nd feed tray) (M10)
14	Toner bottle drive motor (Bk) (M11)	28	Development solenoid (SOL4) *2

*1 IM C6000/C5500/C4500 only

*2 IM C3500/C3000/C2500/C2000 only

Component Layout

Scanner Unit

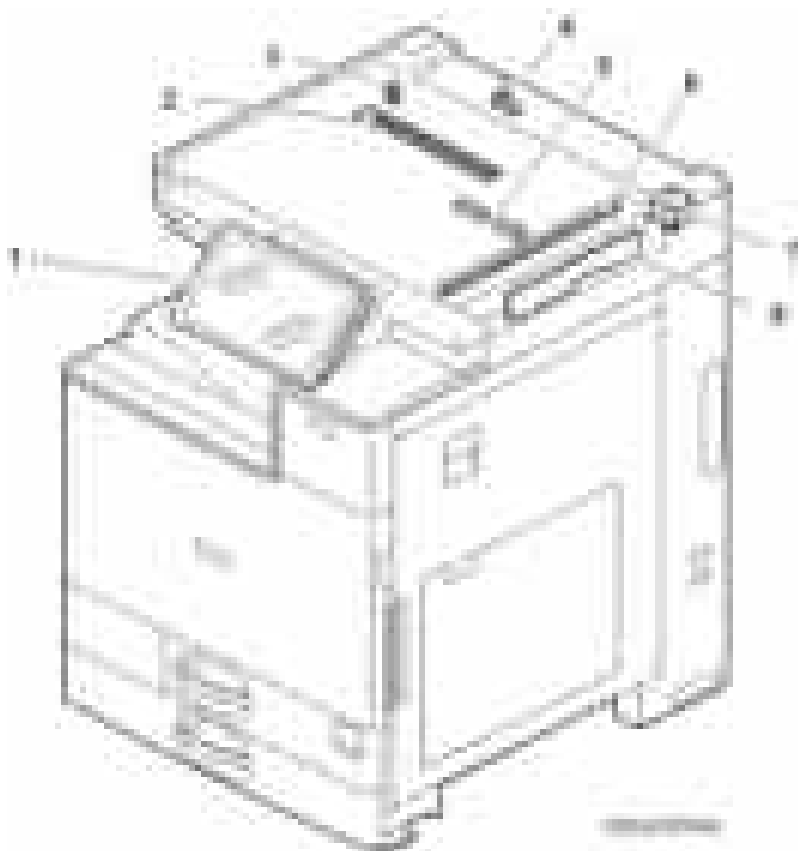

No.	Description	No.	Description
1	Operation panel (SOP-G2.5) (PCB13)	5	Auto paper size (APS) sensors (S44) (S45)
2	Anti-condensation heater (Scanner heater) *1	6	Scanner lamp unit (LED)
3	Scanner home position sensor (S42)	7	Scanner motor (M26)
4	ADF/Platen cover sensor (S43)	8	Sensor board unit (SBU) (PCB7)

*1 Service part

 Laser Exposure Unit

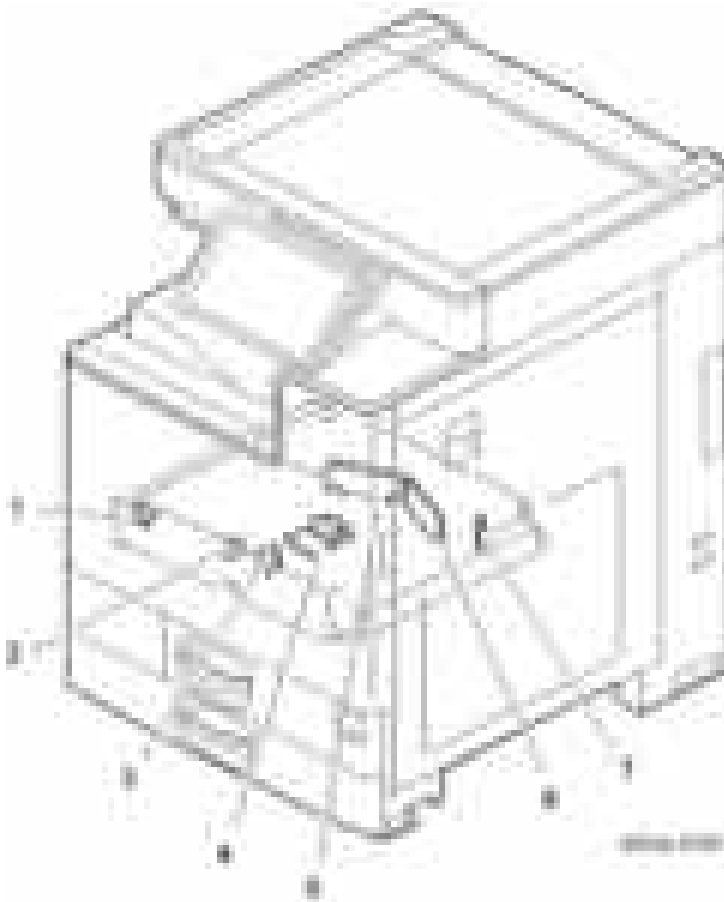

No.	Description	No.	Description
1	Laser optics positioning motor (Y) (M23)	5	LD drive board (M/Y) (PCB15)
2	Laser optics positioning motor (M) (M24)	6	LD drive board (Bk/C) (PCB14)
3	Laser optics positioning motor (C) (M25)	7	Synchronizing detector board (PCB17)
4	Polygon mirror motor (M27)	-	-

7.Detailed Descriptions

Image Transfer Unit

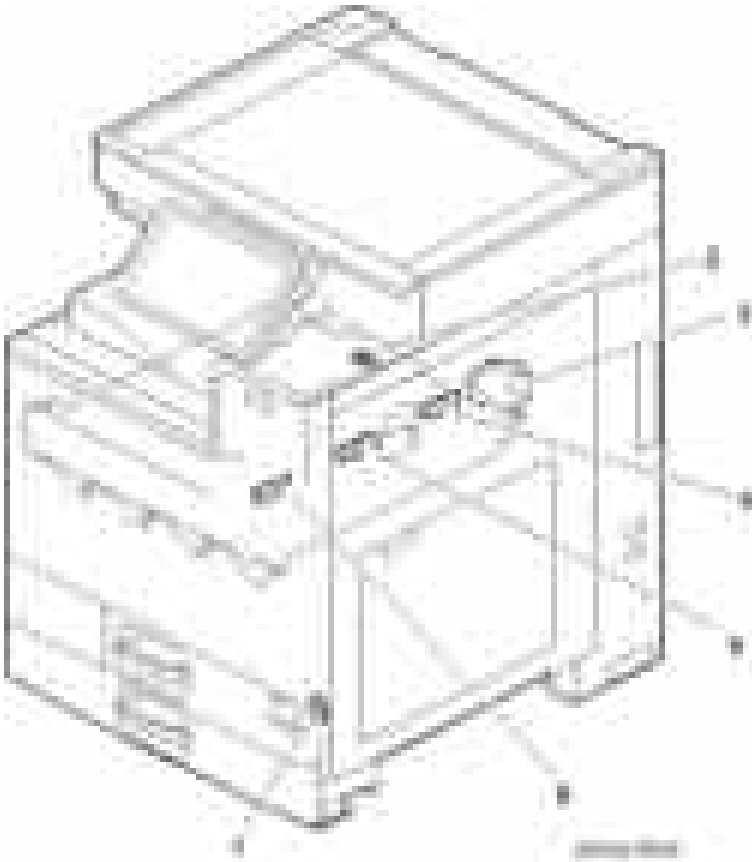

No.	Description
1	Temperature and humidity sensor (S41)
2	ITB contact and release sensor (S32)
3	Paper transfer contact and release motor (M18)
4	TM/ID sensor (rear) (S48)
5	TM/ID sensor (center) (S48)
6	TM/ID sensor (front) (S48)

PCDU

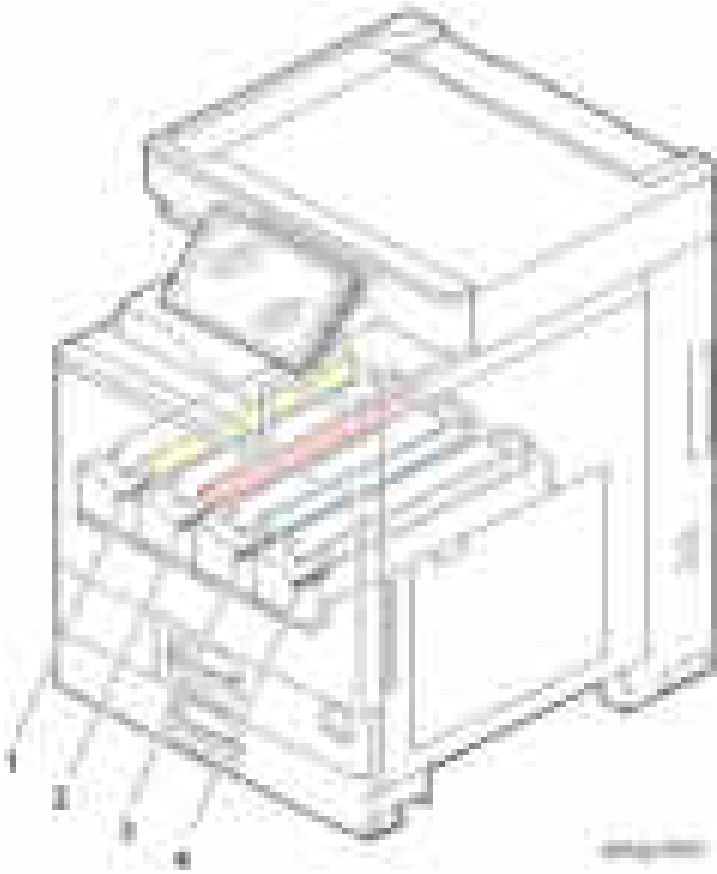

No.	Description	No.	Description
1	TD sensor (Y) (S40)	3	TD sensor (C) (S38)
2	TD sensor (M) (S39)	4	TD sensor (Bk) (S37)

Toner Supply / Waste Toner Bottle

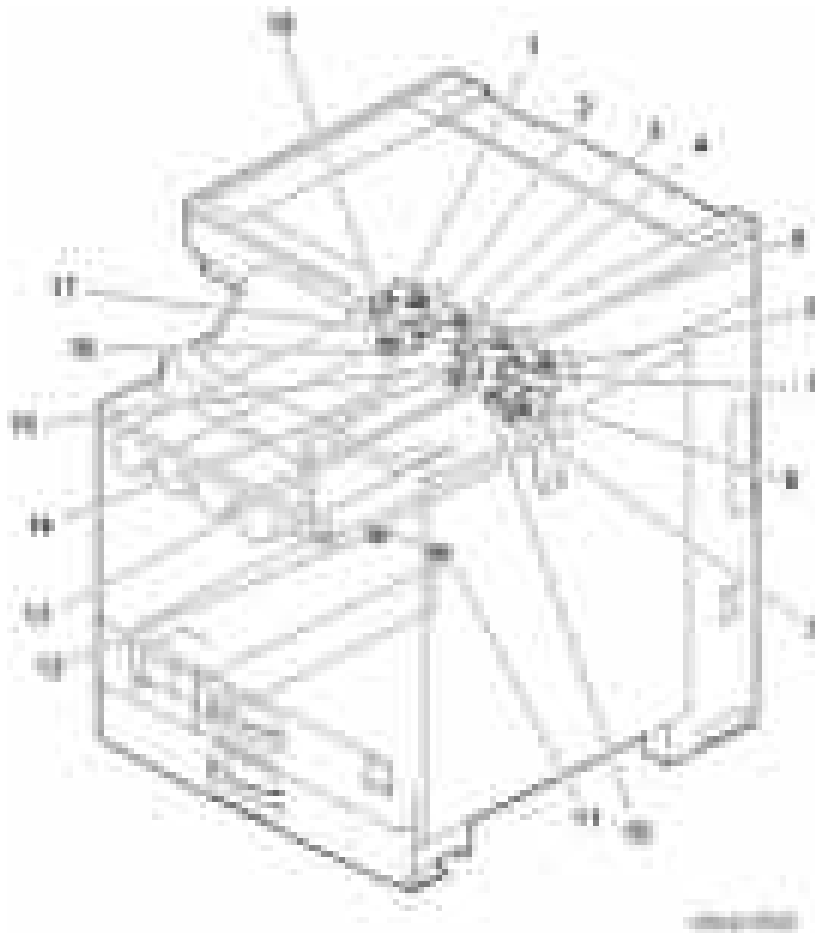

No.	Description	No.	Description
1	Toner bottle drive motor (Y) (M14)	10	Toner end sensor (C) (S29)
2	ID chip contact board (M) (PCB5)	11	Waste toner bottle set sensor (S35)
3	Toner bottle drive motor (M) (M13)	12	Waste toner bottle full sensor (S34)
4	ID chip contact board (C) (PCB4)	13	Toner supply motor (C) (M20)
5	Toner bottle drive motor (C) (M12)	14	Toner end sensor (M) (S30)
6	Toner bottle drive motor (Bk) (M11)	15	Toner supply motor (M) (M21)
7	ID chip contact board (Bk) (PCB3)	16	Toner end sensor (Y) (S31)
8	Toner supply motor (Bk) (M19)	17	Toner supply motor (Y) (M22)
9	Toner end sensor (Bk) (S28)	18	ID chip contact board (Y) (PCB6)

Paper Feed Unit

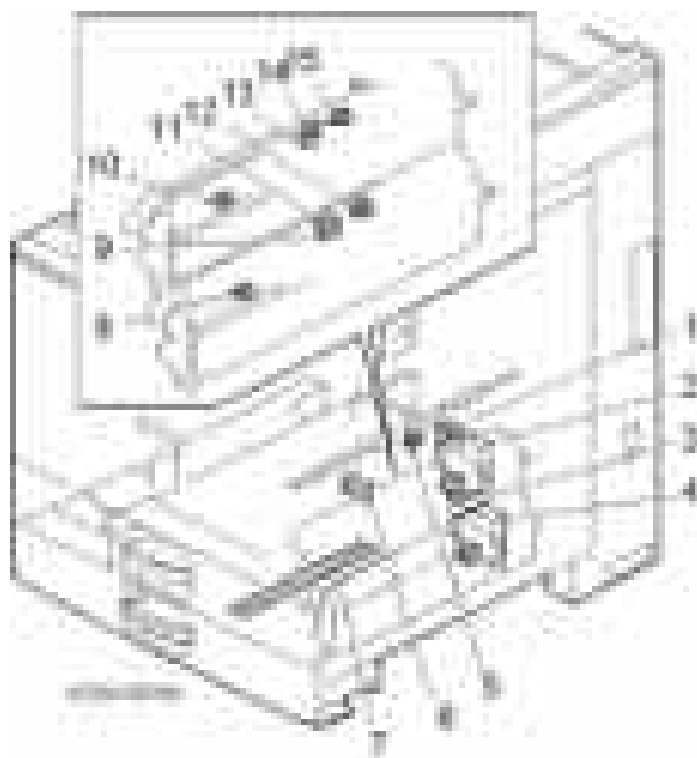

No.	Description	No.	Description
1	Tray set switch (1st feed tray) (S19)	10	Paper feed sensor (1st feed tray) (S12)*1
2	Lift motor (1st feed tray) (M9)	11	Paper end sensor (2nd feed tray) (S24)
3	Tray set switch (2nd feed tray) (S21)	12	Upper Limit sensor (2nd feed tray) (S25)
4	Lift motor (2nd feed tray) (M10)	13	Transport sensor (1st feed tray) (S13)
5	Registration sensor (S16)	14	Paper end sensor (1st feed tray) (S14)
6	Paper size switch (2nd Feed Tray) (SW1)	15	Upper limit sensor (1st feed tray) (S15)
7	Anti-condensation heater (H1)	-	-
8	Paper feed sensor (2nd Feed Tray) (S22)*1	-	-
9	Transport sensor (2nd Feed Tray) (S23)	-	-

*1 IM C6000/C5500/C4500/C3500/C3000 only

7.Detailed Descriptions

Duplex Unit

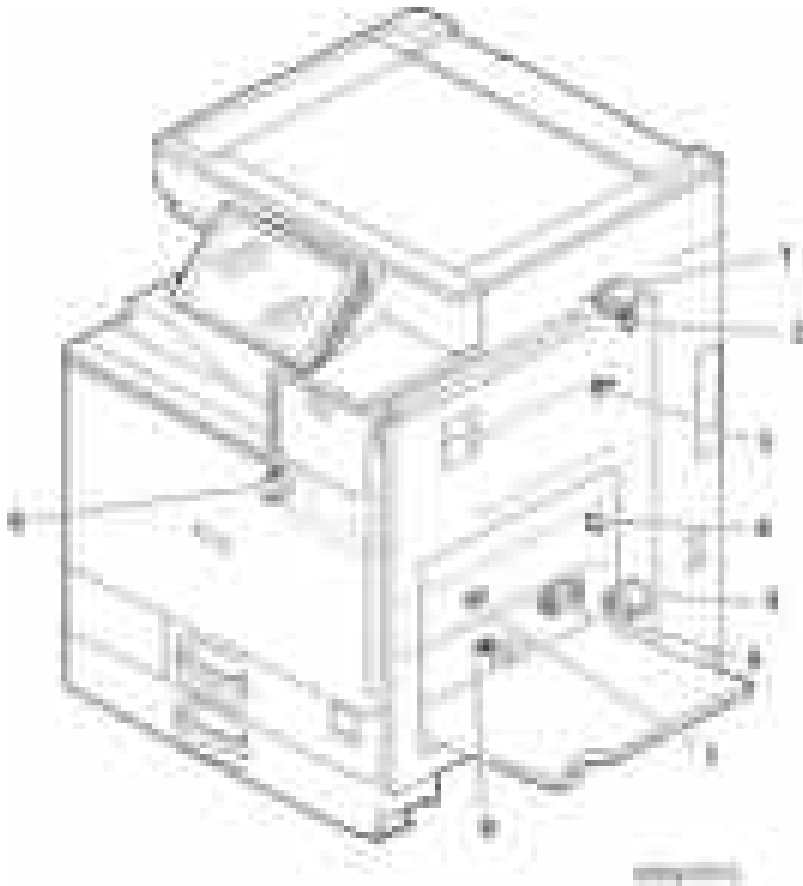

No.	Description	No.	Description
1	Duplex Entrance Motor (M1)	6	Bypass Pick-up Solenoid (SOL1)
2	Right Door Open/Close Sensor (S17)	7	Duplex Exit Sensor (S3)
3	Duplex Entrance Sensor (S5)	8	Bypass Paper End Sensor (S6)
4	Duplex Guide Plate Open/Close Sensor (S4)	9	Interlock Switch (Front Cover, Right Door) (SW2)
5	Bypass/Duplex Motor (M2)	-	-

Bypass Unit

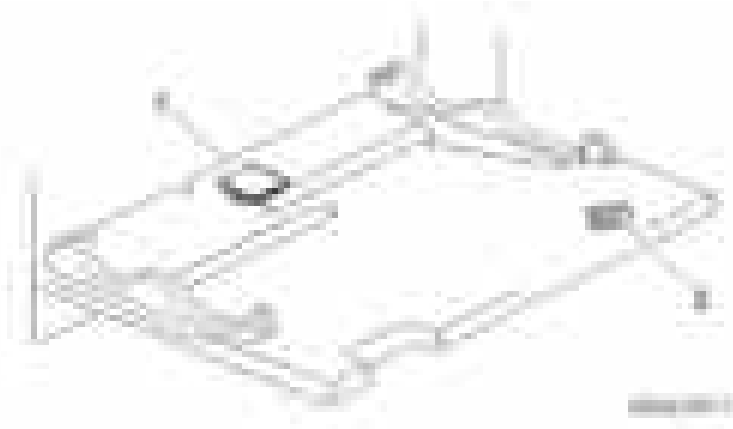

No.	Description
1	Bypass Width Sensor (S8)
2	Bypass length sensor (S7)

Fusing Unit

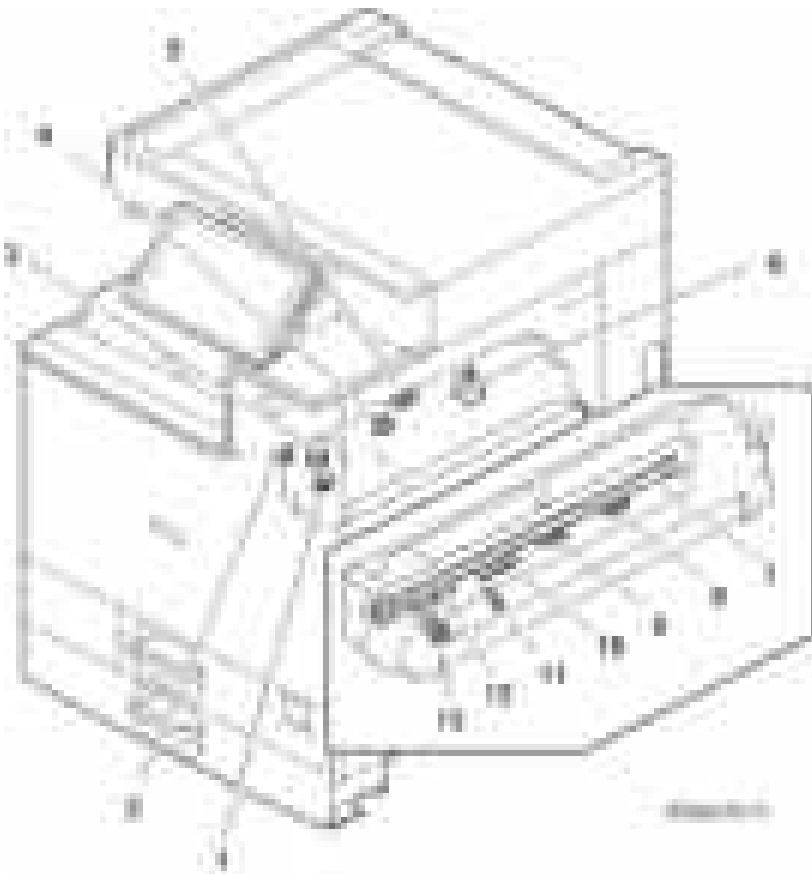

No.	Description	No.	Description
1	Pressure roller HP sensor (S26)	8	Fusing sleeve thermostat (edge)

7.Detailed Descriptions

No.	Description	No.	Description
2	Shield position sensor (S50)*1	9	Fusing sleeve thermostat (center)
3	Thermopile (edge) (TH2)	10	Non-contact thermistor (center) (S46)
4	Thermopile (center) (TH1)	11	Pressure roller thermistor (center) (TH3)
5	Fusing exit sensor (S27)	12	Non-contact thermistor (edge) (S47)
6	Shield drive motor (M28)*1	13	Pressure roller thermistors (edge, full-bleed edge) (TH4) (TH5)
7	Fusing lamp	-	-

*1 IM C6000/C5500/C4500 only

Paper Transfer / Paper Exit

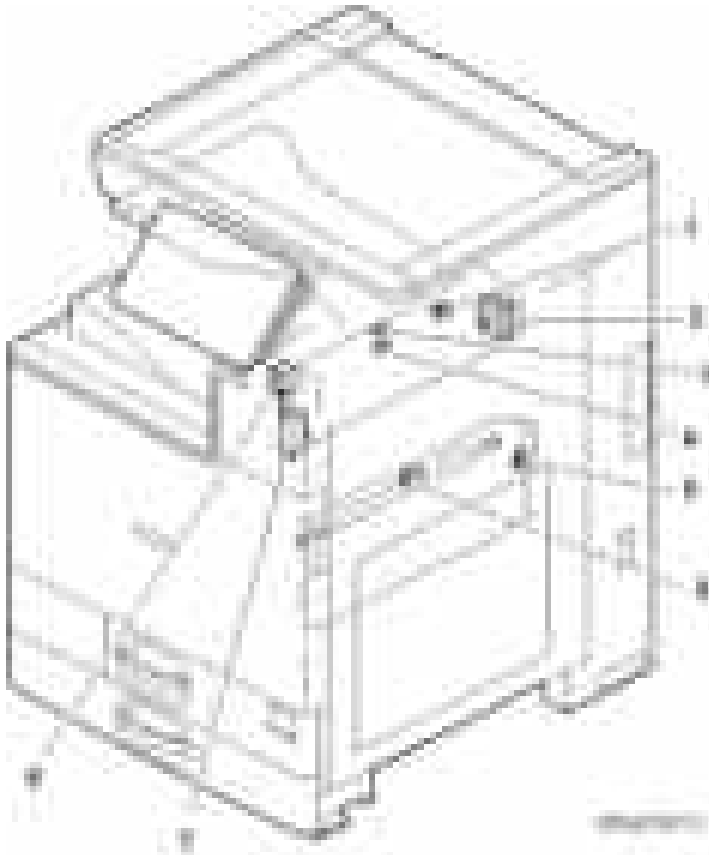

No.	Description	No.	Description
1	Paper exit full sensor (S11)*1	6	Fusing entrance sensor (S1)
2	Reverse motor (M3)	7	Fusing exit drive solenoid (SOL3) (installed on the main machine)
3	Reverse sensor (S9)	8	Paper exit solenoid (SOL2)
4	Paper exit sensor (S10)	-	-
5	PTR open/close sensor (S2)	-	-

*1 IM C6000/C5500/C4500/C3500/C3000 only

Air Flow

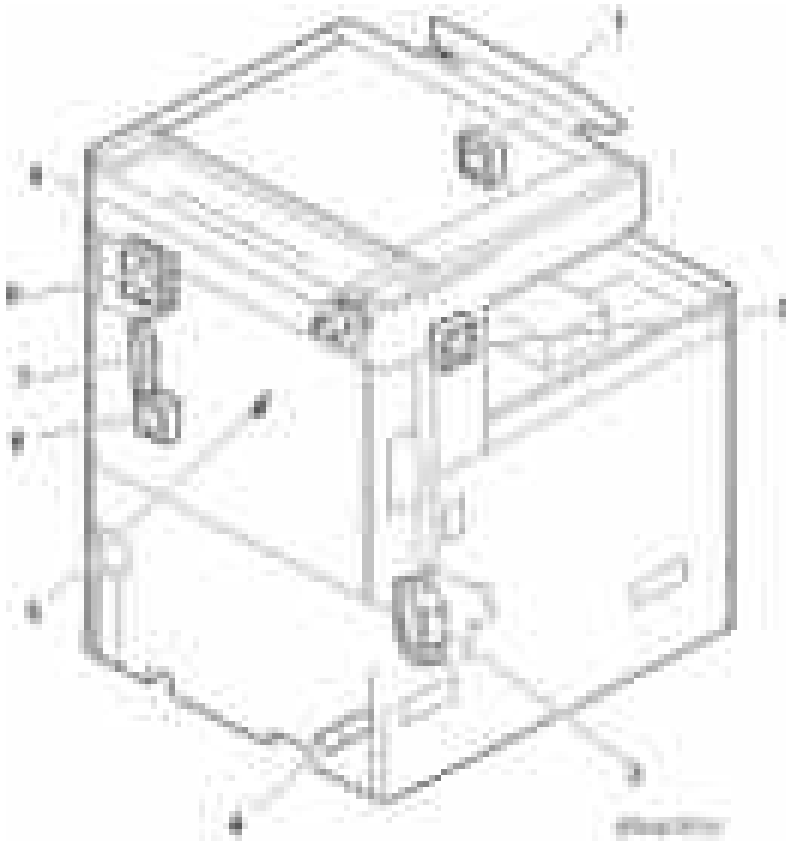

No.	Description	No.	Description
1	Paper exit cooling fan (FAN7)	6	Drive cooling fan (FAN9)*
2	Development intake fan (FAN6)	7	Toner supply cooling fan (FAN5)
3	Ozone exhaust fan (FAN3)	8	Fusing exhaust fan (FAN1)
4	PSU cooling fan (FAN2)	9	Main exhaust fan (FAN8)*
5	Imaging Temperature Sensor (Thermistor) (S33)	-	-

* IM C4500/C5500/C6000 only

7.Detailed Descriptions

Drive Unit

IM C6000/C5500/C4500

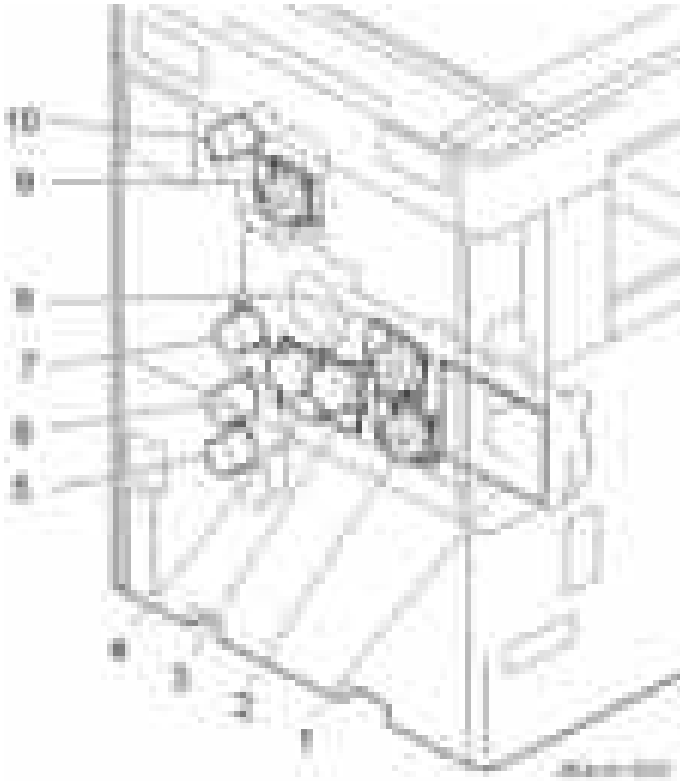

No.	Description	No.	Description
1	Imaging IOB (PCB2)	7	Registration motor (M7)
2	Development motor: CMY (M16)	8	PCU motor: CMY (M15)
3	Development motor: Black (M29)	9	Fusing motor (M8)
4	PCU: black motor (M17)	10	Paper exit/pressure release motor (M4)
5	Paper feed motor (M6)	-	-
6	Transport motor (M5)	-	-

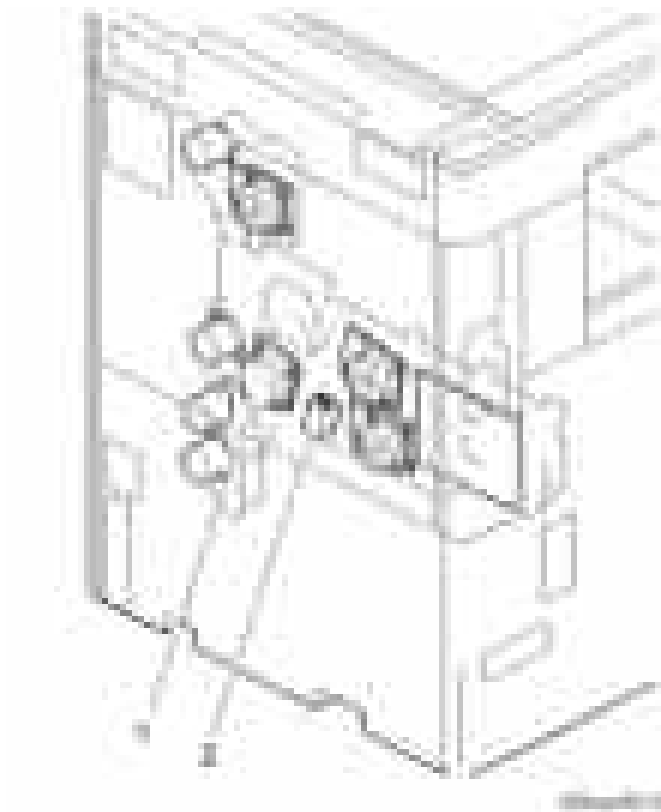
IM C2000/C2500/C3000/3500

No.	Description	No.	Description
1	PCU: Black / Image Transfer Motor (M17)	2	Development Solenoid (SOL4)

The PCU: Black / Image Transfer Motor (M17) is also used for image transfer unit and waste toner bottle. This is switched by the development solenoid (SOL4).

7.Detailed Descriptions

Board / Switch

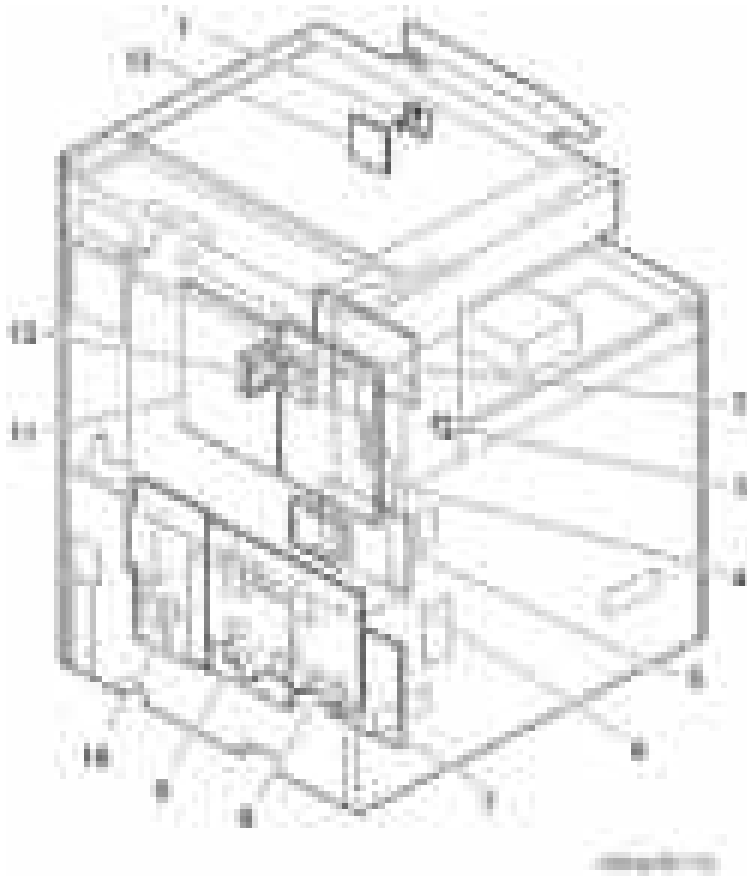

No.	Description	No.	Description
1	Proximity sensors (S49)	8	PSU (DC Power) (PCB8)
2	HVP-TTS (PCB16)	9	HVP-CB (PCB19)
3	Main power switch (SW4)	10	PSU (AC controller board) (PCB9)
4	Control board (PCB11)	11	BICU (PCB10)
5	Imaging IOB (PCB2)	12	Controller box cooling fan (FAN4)
6	HDD (PCB12)	13	Proximity sensor board (PCB18)
7	Paper transport IOB (PCB1)	-	-

Scanner

Changes from the Previous Models

Lookup Table

Item	MP C2004/C2504/C3004/C3504/C4504/C5504/C600 4(Previous Model)	IM C2000/C2500/C3000/C3500/C4500/C55 00/C6000
Image Sensor	CCD	CMOS

- **Changes to the Number of Size Detection Values**

In the previous model, there were nine values logged for size detection (SP4-310-001 to 009). In this model, the number of such values has been increased to 36 (SP4-313-001 to 036). (Scan Size Detect Value)

This helps improve the scanning accuracy of thick (dark) originals.

Note: In this model, SP4-310 has been removed.

- **Adding SP4-311-001 (Detection: Start Position)**

To prevent the delay in starting scanning, the scanner carriage start position of this model is 10 mm leftward (closer to scale) than that of the previous model. Since there may be rare occasions where it is necessary to move the scanner carriage start position to that of the previous model, this SP allows the start position to be changed.

0: 20 mm (default)

1: 30 mm (same as the previous model)

2: 130 mm

Overview

The short focus scanner is realized by implementing a lens block (SBU, CMOS, and Lens) on the carriage.

After the scanner lamp unit emits the light to the document, the light goes through the route shown below and reaches the CMOS.

Scanner lamp unit (LED) -> Original -> 1st mirror (13) -> 2nd mirror (3) -> 3rd mirror (6) -> 2nd mirror (3) -> 4th mirror (5) -> 5th mirror (14) -> lens -> pre-sensor lens -> CMOS

7.Detailed Descriptions

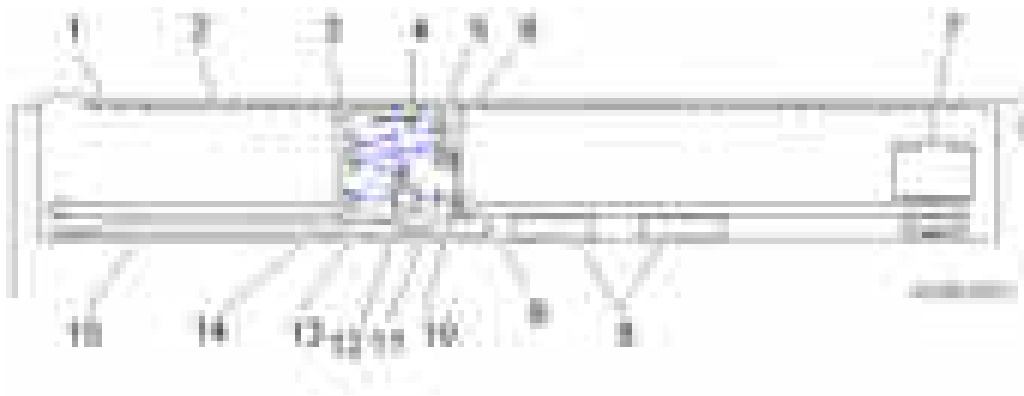

No.	Description	No.	Description
1	Sheet-through exposure glass	9	Sensor board unit (SBU) (PCB7)
2	Exposure glass	10	CMOS
3	2nd mirror	11	Pre-sensor lens
4	Scanner lamp unit (LED)	12	Lens
5	4th mirror	13	1st mirror
6	3rd mirror	14	5th mirror
7	Scanner motor (M26)	15	Anti-condensation heater* (Scanner heater)
8	Auto paper size (APS) sensors (S44) (S45)	-	-

*Service part

Reading System

Two scan modes are available: Book Mode (Platen Mode) and ADF Mode (Sheet-through Method).

In Book Mode (Platen Mode), the scanner scans the document from left to right.

When the ADF is used (ADF Mode), the scanner is fixed in the home position on the left side, and the document is transported and read (Sheet-through Method).

Scanner

Scanner lamp

The light source is an LED.

The LED emits little heat (low power consumption) and has excellent light output rise characteristics.

Sensor

The sensor collects the light that was reflected from the original and converts it to three color digital signals (R, G, B).

The resolution of this CMOS sensor is 600dpi.

Reflection plate (reflector)

The reflection plate reflects light from the scanner lamp and collects light to the reading point on a document. The light which illuminates the document is adjusted to be the same on the left and right so

as not to cast any shadow on the document.

White reference seal

A white reference seal for shading correction is affixed to the underside of the scale on the left of the scanner unit. This is read by the scanner and CMOS when the power is ON. The data read is temporarily stored in a RAM, and used for correction of document image data.

Mechanism

Scanner Drive

The scanner is driven by the scanner motor (M26) [D] via the timing belt [C]. For each mode, reading is completed in one pass.

Position control of the scanner carriage [B] is based on the scanner home position sensor (S42) [A].

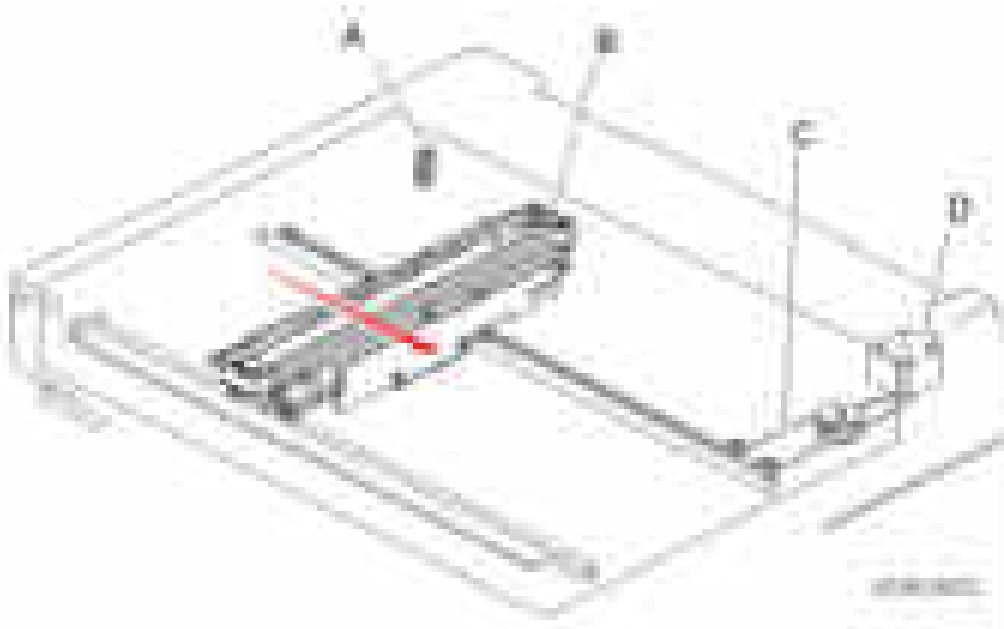

(S44) (S45) are used for the sub-scanning direction, and a CMOS is used for the main scanning direction.

Sub-scanning direction (by APS sensors)

The document size is detected by ON/OFF of the sensor. The ADF/Platen cover sensor (S43) is used for document size detection timing. When the ADF/Platen cover sensor (S43) has changed from "no cover" to "cover," the size is detected.

Main scanning direction (by CMOS)

RGB color densities at 3 locations (S1, S2, S3) are detected 3 times by the CMOS sensor. The presence of the document is determined from the number of locations where an RGB density of 7 digits or more is detected.

The ADF/Platen cover sensor (S43) is used for document size detection timing. When the ADF/Platen cover sensor (S43) detects "no cover," the scanner lamp is moved to the right; when it detects "cover," the scanner lamp is moved to home position while lit, and during this time, the size is read.

The influence of ambient light is reduced by scanning with the scanner lamp (LED) turned off.



Document size			Sensor response				
Size	Direction	Dimensions (main × sub)	S1	S2	S3	L1	L2
A3	SEF	297x420	-	-	■	■	■
B4	SEF	257x364	-	■	-	■	■
A4	SEF	210x297	■	-	-	■	-
A4	LEF	297x210	-	-	■	-	-

7.Detailed Descriptions

Document size			Sensor response				
B5	SEF	182x257	-	-	-	☒	-
B5	LEF	257x182		☒	-	-	-
A5	SEF	148x210	-	-	-	-	-
A5	LEF	210x148	☒	-	-	-	-
B6	SEF	128x182	-	-	-	-	-
B6	LEF	182x128	-	-	-	-	-
DLT	SEF	11"×17"	-	-	☒	-	☒
10×15	SEF	10"×15"	-	☒	-	-	☒
USB4	SEF	10"×14"	-	☒	-	-	☒
LG	SEF	8 1/2"×14"	☒	-	-	-	☒
Oficio	SEF	8 1/2"×13.4"	☒	-	-	-	☒
Foolscap	SEF	8 1/2"×13"	☒	-	-	-	☒
Folio	SEF	8 1/4"×13"	☒	-	-	-	☒
F	SEF	8"×13"	☒	-	-	-	☒
LT	SEF	8 1/2"×11"	☒	-	-	☒	-
LT	LEF	11"×8 1/2"	-	-	☒	-	-
8×10	SEF	8"×10"	☒	-	-	☒	-
10×8	LEF	10"×8"	-	☒	-	-	-
Executive	SEF	7 1/4"×10 1/2"	-	-	-	☒	-
HLT	SEF	5 1/2"×8 1/2"	-	-	-	-	-
HLT	LEF	8 1/2"×5 1/2"	☒	-	-	-	-
8kai	SEF	267×388	-	☒	-	-	☒
16kai	SEF	194×267	-	-	-	☒	-
16kai	LEF	267×194	-	☒	-	-	-

- The document width (main scanning direction) is detected by the sensor indicated with ☒.

How to check the sensor state

- **SP4-301 (Operation Check APS Sensor)**

How to read the screen

(7)00000000(0)

0: no document

1: document present

When the sensor responds, bit 0 is displayed as "1."

- **SP4-313 (Scan Size Detect Value)**

Viewed from the operation panel, labeling positions from rear to front S1-S3 in that order, the RGB density at each position is displayed in digit units (the value just before the scan is displayed).

Other

- **SP4-303 (Min Size for APS)**
Sets the display when non-standard (small size) size original is detected.
0: Display message "Original size unknown".
1: Operate assuming the original size is A5 LEF (HLT LEF for inches).
- **SP4-305-001(8K/16K Detection)**
By changing this SP, you can change between A4 size/letter size or Chinese paper size (8×16).
0: Normal setting. (Default)
1: When detecting A4/LT size -> Assume that it is A4 when SEF, LT when LEF.
2: When detecting A4/LT size -> Assume that it is LT when SEF, A4 when LEF.
3: Change to 8K/16K settings.
A3, B4 -> 8K LEF
A4 LEF, B4 LEF, A5 LEF -> 16K LEF
A4 SEF, B4 SEF, A5 SEF -> 16K SEF
- **SP5-126 (Set F-size Document)**
Selects the paper size for the F-size original.
0: When detecting Foolscap -> Assume that the size is 8 1/2"x13". (Default)
1: When detecting Folio -> Assume that the size is 8 1/4"x13".
2: When detecting F -> Assume that the size is 8"/13".
- **SP4-308 (Scan Size Detection)**
Sets CCD original size detection and APS original size detection.
0: Disable: Not detect original size
1: Enable: Detect original size by the CCD unit
2: APS: APS sensor (S44) (S45) is used for detecting original size.
- **SP4-312-006 (Scan Size Detect: Setting LED PWM Duty)**
If the user specifies that the pre-scan lamp is too bright, the brightness pre-scan can be reduced by decreasing the value of this SP. However, if the lamp brightness is reduced, size detection for a document with a large number of solid images will be less accurate.
- **SP5-135 (LG_Oficio Change)**
1: When detecting LG size -> Assume that the size is 8 1/2"x14".
2: When detecting Oficio size -> Assume that the size is 8 1/2"x13.4". (Default)
- **Adding SP4-311-001 (Detection: Start Position)**
To prevent the delay in starting scanning, the scanner carriage start position of this model is 10 mm leftward (closer to scale) than that of the previous model. Since there may be rare occasions where it is necessary to move the scanner carriage start position to that of the previous model, this SP allows the start position to be changed.
0: 20 mm (default)
1: 30 mm (same as the previous model)
2: 130 mm

7.Detailed Descriptions

Improved Tolerance to Black Lines when Paper Passes through ARDF/SPDF

The original document does not come in contact with the sheet-through exposure glass, which prevents adhesive dirt (ball pen ink) on the document from adhering to the sheet-through exposure glass.

ADF cross-section diagram, non-contact scanning

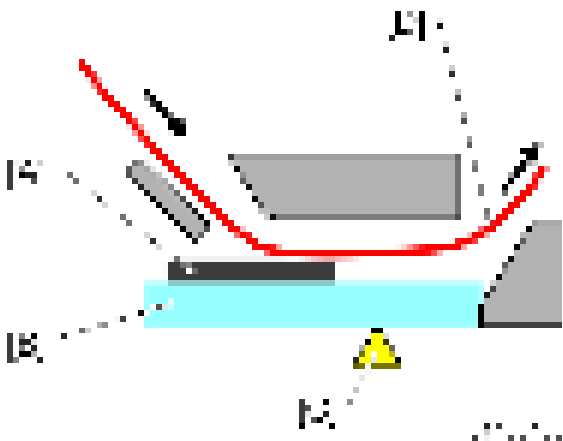

[A]: Sheet

[B]: Sheet-through exposure glass

[C]: Read position

[D]: Document

- Contact scanning

As the document comes in contact with the sheet-through exposure glass this is useful for dealing with adhesion of free dirt particles (paper scraps, etc.). (Self-cleaning mechanism using paper)

On the other hand, sticky dirt adhering to the document sticks to the sheet-through exposure glass and may give rise to the appearance of black lines.

ADF cross-section diagram, contact scanning

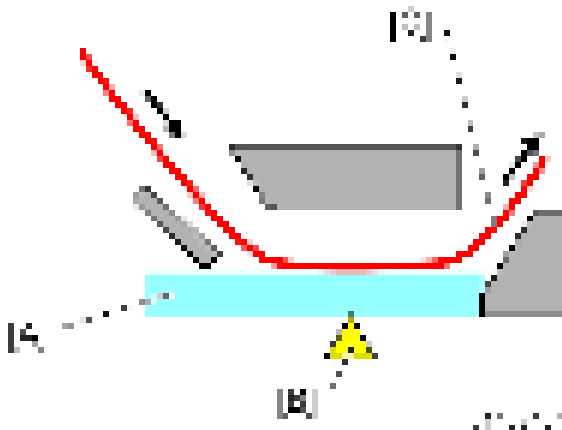

[A]: Sheet-through exposure glass

[B]: Read position

[C]: Document

If black lines due to free dirt particles appear within a short time, such as when users have documents with large amounts of paper scraps, you can change from the non-contact scanning system to the contact scanning system with the procedure in Troubleshooting - Vertical Streaks on

Copies due to Scanning Problems.

- Reference (reading position correction)

By changing SP4-020-001 (Dust Check Dust Detect:On/Off), when dirt is detected at the reading position, the reading position may be changed to avoid the dirt.

(If it cannot be avoided, an alert is displayed on the operation panel advising the user to perform target glass cleaning).

Image diagram

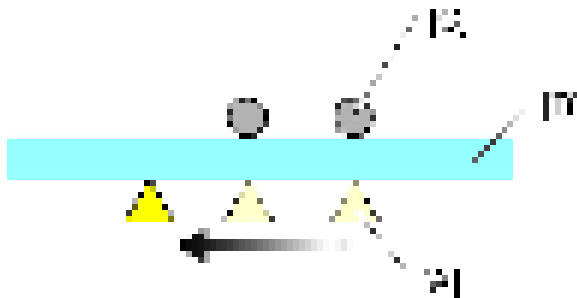

Figure 1

[A]: Read position



[B]: Sheet-through exposure glass

[C]: Dirt



- Dirt is detected when a document passes through, so the alert will not disappear until the reading of the next document begins, even after the sheet-through exposure glass cleaning is performed.
- If dirt is detected not on the sheet-through exposure glass but on the background guide plate, the alert will not disappear even if the glass is wiped.
- The time required for the first copy is slightly (almost imperceptibly) longer.
- The detection threshold value can be changed using SP4-020-002 (Dust Check Dust Detect:Lvl). (The larger the value is, the smaller the dirt particles that can be detected become.)
- It is prohibited to change the setting of SP4-020-003 (Dust Check Lvl Dust Reject:Lvl).

Difference between Non-contact Transport and Contact Transport in DF Scanning

Transport Method	Non-contact Transport	Contact Transport
Descriptions	 <p>Because of the film attached to the glass, the original doesn't contact the glass.</p>	 <p>While passing, the original contacts the glass.</p>

7.Detailed Descriptions

Transport Method	Non-contact Transport	Contact Transport
Merit	It almost never causes stripes on the image that arise from foreign substances transferring from the original to the glass.	It almost never causes stripes on the image that arise from dust on the glass, because the glass is cleaned by contact with the transported original.
Demerit	Compared with the contact method, stripes on the image caused by dust occur more often.	Compared with the non-contact method, stripes on the image caused by foreign substances transferred from the surface of an original to the glass occur more often.
Aim	To improve the prevention of stripes in the image caused by sticky foreign substances.	Considering the target users of this machine, it's important to improve prevention of stripes caused by dust in the path
Note	<ol style="list-style-type: none"> 1. Be sure to replace the sheet-through glass with the film attached on the glass. 2. When you attach the film on the glass, you need to keep the left scale attached on the glass in order to fix the location of the film.*1 3. You can change the method (contact method to non-contact, or vice versa) by replacing some parts.*1 	-

*1: For details, [Vertical Streaks on Copies due to Scanning Problems](#).

Anti-Condensation Heater

Under low-temperature conditions, condensation may appear on optical parts (such as mirrors). This will cause image deletion, blacked out images, and gray images. As a countermeasure, there is an anti-condensation heater [A] that is an optional service part. This heater turns on automatically when the power source turns off.

7.Detailed Descriptions



A	Anti-condensation heater
---	--------------------------

Image Processing

Changes from the Previous Machine

No difference mechanically.

Mechanism

SBU

Functions

Performs Black level correction and White level correction, Creating the SBU test pattern, and A/D conversion.

This machine is equipped with a short focus scanner and the SBU is located on the scanner carriage.

Operation overview

Samples 2 analog signals (ODD, EVEN) from RGB output from the 3-line CCD, and converts them to digital signals by an A/D converter. The digital signals are output to the BICU (IPU).

SP correction value storage

The SBU correction value is stored in an EEPROM on the BICU.

Execute the following SP settings when the scanner carriage is replaced. (Lens block is located on the scanner carriage.)

- **SP4-871-002 (Distortion Correction Distortion Initialization)**
- **SP4-880-001 (Dot shift amount between R Line and G Line).**
- **SP4-880-002 (Dot shift amount between G Line and B Line).**

SBU Test Mode

There is an SP code to create a test pattern which can be used as a diagnostic tool to troubleshoot problems in the SBU:

- **SP4-699-001 (SBU Test Pattern Change)**
 - Pattern 1: fixed value
 - Pattern 2: main scanning gradation pattern
 - Pattern 3: width scanning gradation pattern
 - Pattern 4: main scanning/width scanning lattice pattern
- SBU has a function to generate four test patterns.

BICU

Image processing function overview

The image signals from the SBU (PCB7) are subjected to various image processing, and output to the controller (memory). The image signals from the controller (memory) are received, and output to the

LDB (the LDB is provided in the laser unit).

Image processing overview (copy application)

Digital signal data output from the SBU (PCB7) is subjected to shading correction and line interval correction, as well as image processing. Finally, the data is sent to the machine as digital signals-4 bit/pixels.

Image processing items	Details
Shading correction	Corrects for uneven scanner lamp lighting, and scatter in CCD light receiving sensitivity.
Line interval correction	Line shift during sub-scanning magnification/reduction by the scanner. Corrects integer part.
Dot correction	Line shift during sub-scanning magnification/reduction by the scanner. Corrects below the decimal point.
Vertical line correction	Corrects a vertically striped image during sheet-through ADF.
Image area separation	Determines text parts and photo parts of the image.
Scanner gamma correction	Corrects scatter of image data relative to exposure amount. From reflectivity linear to density linear.
Filter	Performs image sharpness adjustment and removes moire effect.
ADS	Performs natural complexion removal in the full-color mode.
Color compensation preprocessing	Determines hue in masking mode, and improves chromaticity.
Color compensation	Converts RGB data to density value CMYK data of color materials.
Image magnification change	Arbitrarily changes main scanning magnification, sub-scanning fixed image reduction and magnification of scanner image.
Image shift function	Shifts image data in the main scanning or sub-scanning directions.
Image binarization function	In scanner mode, outputs a binary signal.
Image mask	Masks an area outside a frame of an arbitrary region in scanner or printer data.
Image compression/expansion	Compresses or expands an image.
Printer gamma correction	Adjusts exposure amount of photosensitive body relative to image density.
Gradation processing	Applies 600dpi, 4bit 16 value gradation processing.

Laser Unit

Changes from the Previous Models

Lookup Table

Item	MP C2004/C2504/C3004/C3504/C4504/C5504/C6004(Previous Model)	IM C2000/C2500/C3000/C3500/C4500/C5500/C6000
Unit configuration	-	Synchronizing detector board and cylinder lens on Y and M color side removed.

Changes to Parts

The previous model was equipped with 2 synchronizing detector boards, one beside the K-C color station and the other beside the M-Y color station.

This machine is equipped with 1 synchronizing detector board beside the K-C color station, and the 4 colors' timing is controlled by its sensor.

The synchronizing detector board (YM) [1] and cylinder lens [2] have been removed

The previous model's configuration is as shown below.

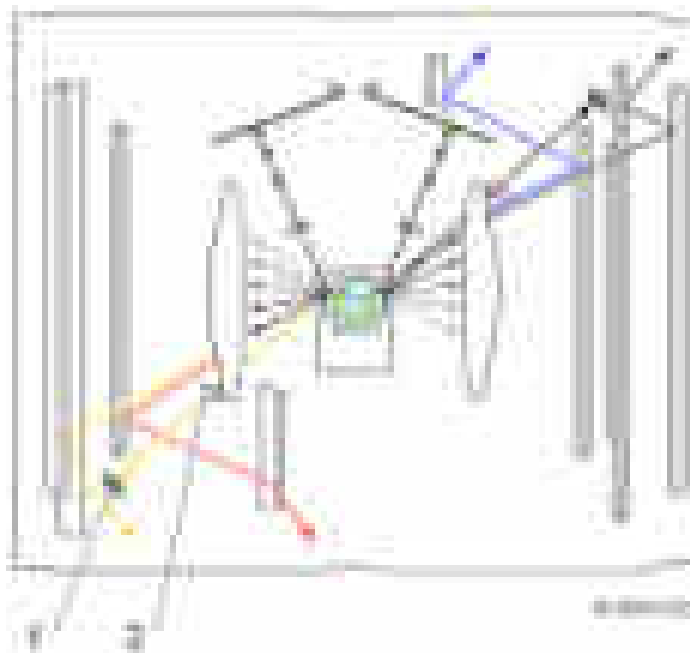

Overview

This machine has achieved an increase in operating speed by means of the 4-station (color) writing system that supports tandem imaging.

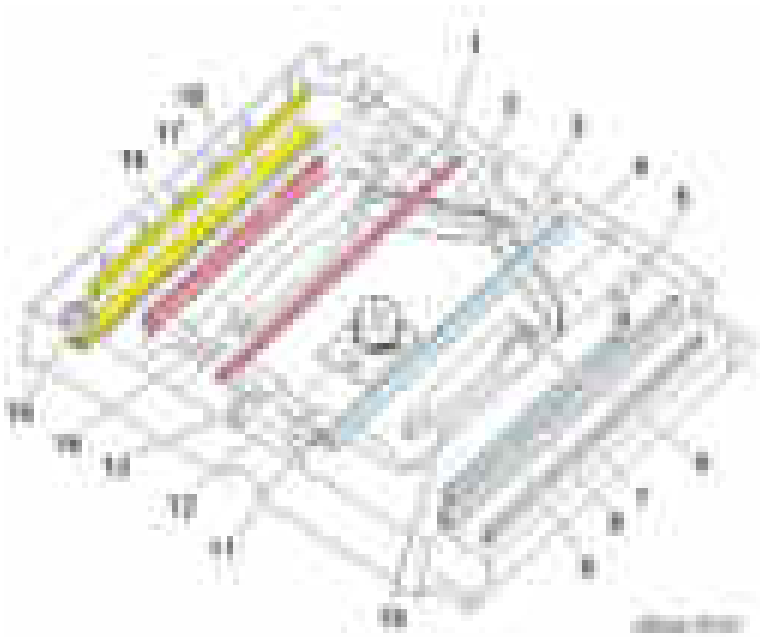

No.	Description	No.	Description
1	2nd mirror (M)	11	Laser optics positioning motor (C) (M25)
2	LD drive board (M/Y) (PCB15)	12	Polygon mirror motor (M27)
3	LD drive board (Bk/C) (PCB14)	13	Laser optics positioning motor (M) (M24)
4	2nd mirror (C)	14	F-theta lens-M/Y
5	Synchronizing detector board (PCB17)	15	Laser optics positioning motor (Y) (M23)
6	Cylinder lens	16	2nd mirror (Y)
7	1st mirror (Bk)	17	2nd mirror (Y)
8	2nd mirror (Bk)	18	1st mirror (M)
9	1st mirror (C)	-	-
10	F-theta lens-Bk/C	-	-

Parts Construction

The write unit comprises a housing and the following main parts:

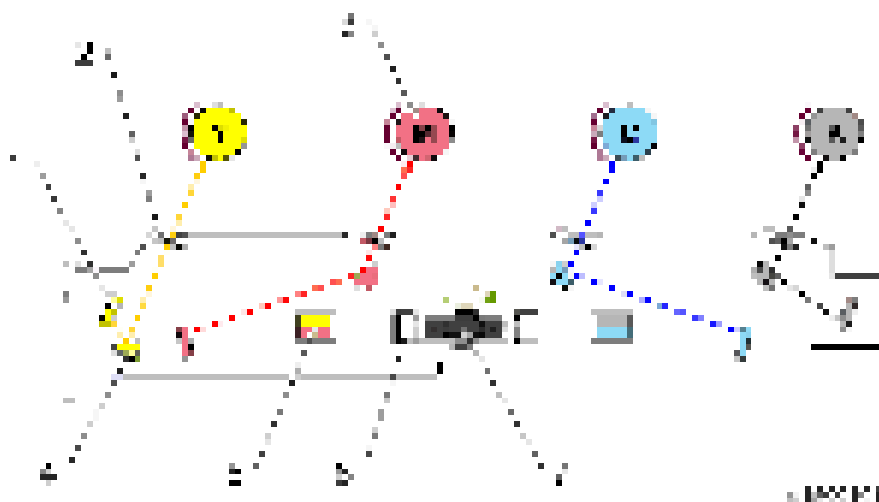

7.Detailed Descriptions

No.	Description	No.	Description
1	1st Mirror	5	F-theta Lens
2	Dust Shield Glass	6	Soundproof Glass
3	PCU (Y,M, C, K)	7	Polygon Mirror Motor (M27)
4	2nd Mirror	-	-

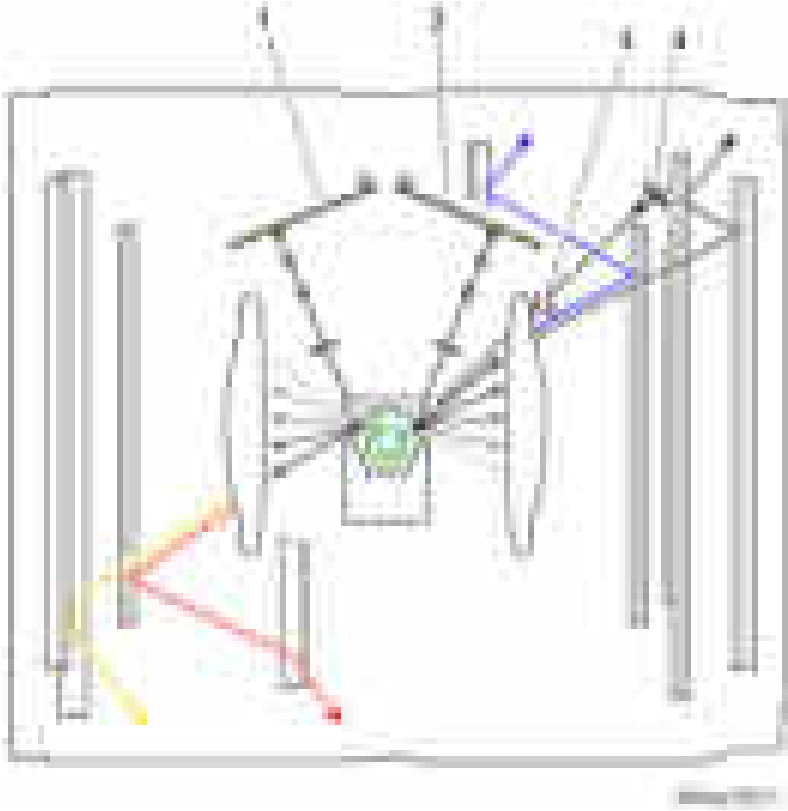

No.	Description	No.	Description
1	LD Drive Board (M/Y) (PCB15)	4	Synchronizing detector board (PCB17)
2	LD Drive Board (Bk/C) (PCB14)	-	-
3	Cylinder Lens (Bk/C)	-	-

Mechanism

LD Drive Board (PCB14) (PCB15)

The LD Unit is provided with two LD Drive Board. The beam system is a 1 beam type for IM C2000/C2500/C3000/C3500, and 4 beam type for IM C4500/C5500/C6000.

The LD Drive Board comprises an LD (laser diode), PD (photodiode) and LD control unit.

- The LD outputs the laser light to the PCU.
- The PD continuously detects laser light from LD and outputs it to the LD control unit.
- The LD control unit adjusts the light amount of the LD based on the output signal of the PD.

LD control board adjustment is not required in the field.

LD Safety Switch

To prevent the laser beam from turning on when the front cover or right door is open, the 5V supply to the LD drive board (PCB14) (PCB15) is interrupted when the interlock switch (SW2) is open.

Circuit Diagram

IM C4500/C5500/C6000

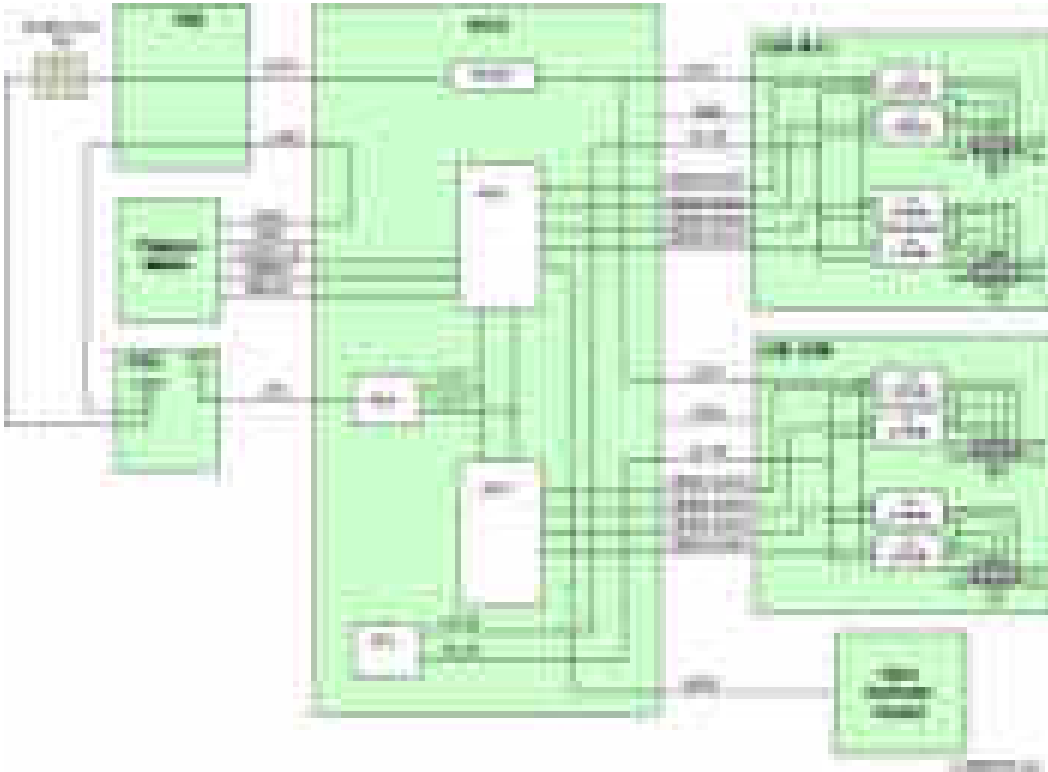

IM C2000/C2500/C3000/3500

7.Detailed Descriptions

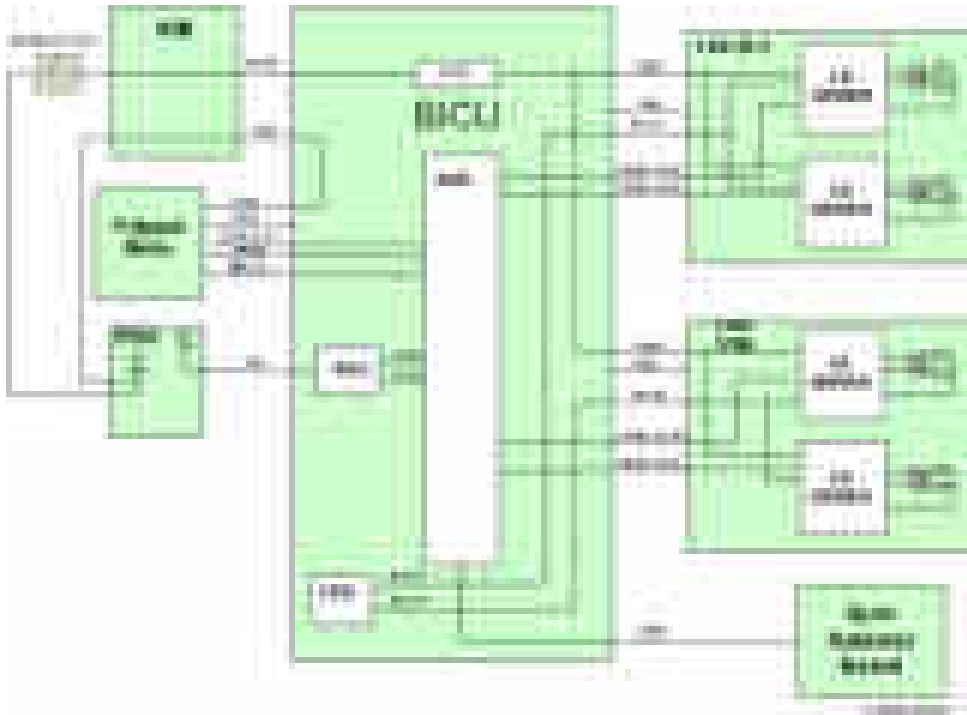

Line Scanning Mechanism

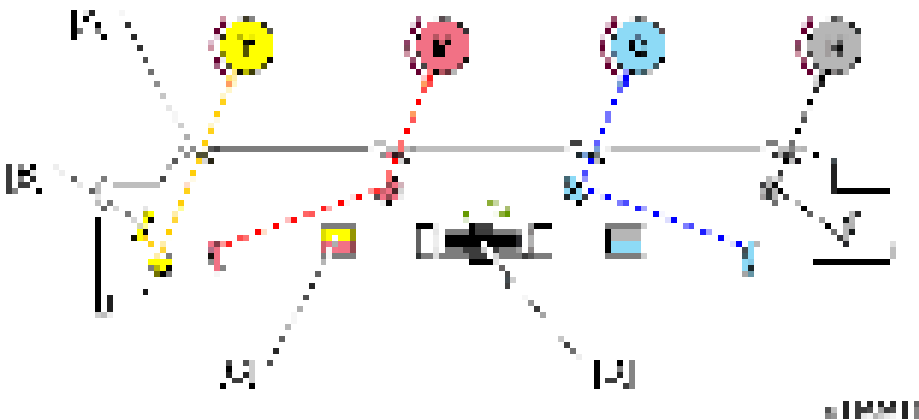

[A]: Dust Shield Glass

[B]: 1st Mirror

[C]: F-theta lens

[D]: Polygon Mirror Motor (M27)

1. **Mirror, lens**

Laser diodes of each color emit light to match the paper transport timing. After passing through the cylinder lens (laser beam width correction), Polygon mirror motor (M27) (main scanning line scan), F-theta lens (dot position correction and optical face tangle error correction), it reaches the drums of each color.

The F-theta lens has a two-stage integrated construction, and 2 color beam correction is performed with one lens.

2. **Polygon mirror motor (M27)**

The polygon mirror motor (M27) comprises two (upper and lower) 6-faced mirrors formed in an

integral construction (these are combined in one unit).

In this machine, 4 color simultaneous write is performed by the LD irradiating a polygon mirror.

* The rotation speed of the Polygon mirror motor (M27) is controlled by LD/ Polygon mirror motor (M27).

3. **Synchronizing detector board (PCB17)**

The single sensor of the synchronizing detector board located beside the K-C color station detects the LD light and controls the 4 colors' timing according to the timing of incoming beams.

This machine has adopted a single-point synchronization system. By positioning the synchronizing detection sensor at the leading edge of the main scan line, the application of colors at the leading edge is synchronized.

4. **Scanline inclination and automatic adjustment mechanism**

The laser optics positioning motor (M23) (M24) (M25) installed on the 2nd mirror adjusts the scan line inclination.

This is done during automatic image position correction.

Auto Image Adjustment (Image Density / Color Calibration)

Changes from the Previous Models

Auto Color Calibration (ACC) Quick Correction Mode

In response to the request from the service technician to reduce the time for adjustment during machine installation, this machine is equipped with Quick Correction Mode for Auto Color Calibration (ACC). In the previous model, it was necessary to execute correction in all resolutions (Test Patterns 1 to 5), but this model executes the correction in all resolutions by only executing Quick Test Pattern once.



- If the printed image is not adjusted properly after executing Quick Mode, perform ACC with normal mode (test pattern in applicable resolution) again.

Notes on Quick Correction Mode

- In Quick Correction Mode, the machine scans in the default scan resolution mode of 2400 dpi × 600 dpi and applies the adjustment value calculated from the scan result to all resolution modes.

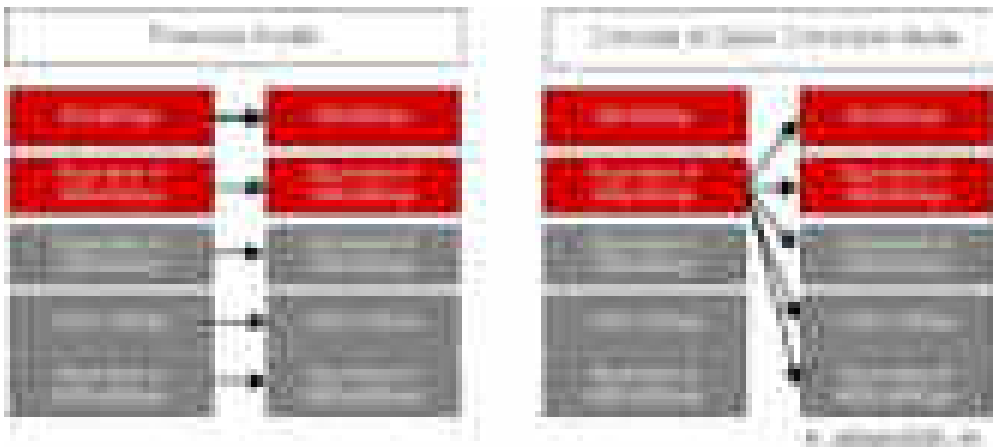

Disadvantage

- The correction is slightly less accurate compared to the correction executed separately in each scan resolution mode (for the colors).

Advantage

- Reducing the time taken for machine installation.

Execution History

- When executing Auto Color Calibration (ACC) in Quick Correction mode, the execution time is logged for Test Patterns 1 to 5 in addition to that for Quick Correction mode.



Test Pattern Layout (for Error Detection)

During Auto Color Calibration (ACC), the machine detects misalignment of the test pattern in the main-scan direction. In the previous model, the correction was applied according to the test pattern even if it was misaligned (although marked misalignment would be detected as a scanning error also in the previous model).

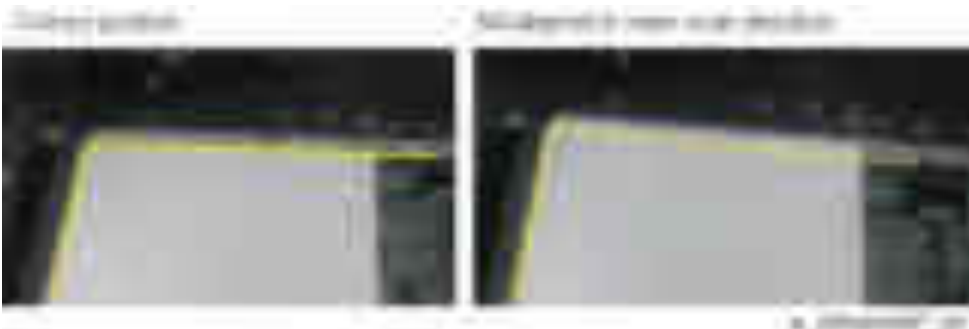

The machine's test pattern has a newly added patch [A] on it to detect misalignment.



Misalignment of the test pattern is detected by scanning this patch. If a misalignment is detected, it will be reported as SP4-950-001 (ACC Position Error Count).

Mechanism

Sensor Construction

The ID Sensors (also called the TM/ID sensors) are used to measure the amount of toner on the Transfer Belt and to correct any errors in color registration.

The TD sensor (also known as the μ sensor) is used to measure the toner density in the developer.

Outline of the ID Sensors

The ID sensors are fixed onto the mainframe, against the surface of the Transfer Belt. Color registration is checked by all three sensors; the Front [A], Center [B], and Rear [C].

The center sensor [B] acts as an ID sensor and a MUSIC sensor.

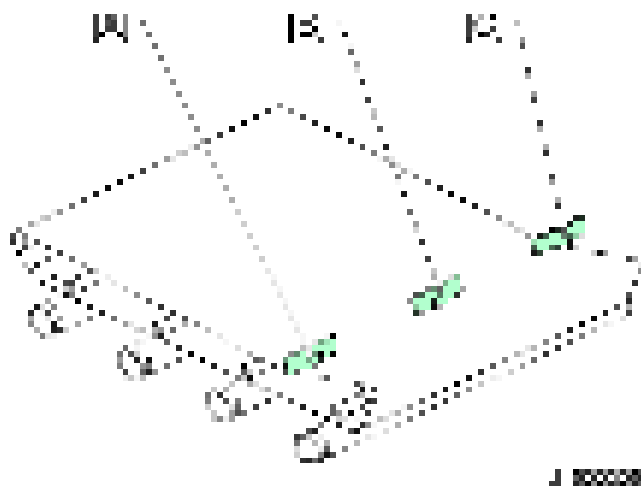

Outline of the TD sensor (S37)(S38)(S39)(S40)

In this machine, a non-contact toner density (TD) sensor, which we also call a mu (μ) sensor, is used for toner density control.

The TD sensor is attached on the lower side of the development unit. Unlike an HST sensor, the board of the TD sensor is exposed. So there is a cover around the sensor to protect it and to maintain a good contact between the sensor and development unit.

The TD sensor measures the permeability of the developer without contacting it, from the outside of the case, and converts the measured value to the toner density.

According to the toner density measured by this sensor, the proper amount of toner is supplied to the developer.

A counter corresponding to the frequency is used as the unit of TD sensor output. Thus, unlike an HST sensor which directly detects V_t , the TD sensor output is converted into V_t for toner supply control.

In the TD sensor, there is an ID chip storing the machine identification information, the running distance information of Development unit and PCU, and other information used by image density control.

Process Control (Image Density Control)

Outline

Process control adjusts the condition of the imaging hardware to maintain a constant image density.

Process control is executed at the following times.

	Process Control	Operative Condition	Related SPs
1	PowerON ProCon :Set	When a certain time has passed after the previous job end (Except when recovering from an SC or jam)	SP3-530-001 SP3-530-002 SP3-530-003 SP3-530-004 SP3-530-005 SP3-530-006 SP3-530-007 SP3-530-008
2	JobEnd ProCon:Set	When the value of the job end counter becomes more than the threshold (At job end)	SP3-534-001 to 004 SP3-534-011 to 014
3	Interrupt ProCon :Set	When the value of the job interrupt counter becomes more than the threshold	SP3-533-001 to 004 SP3-533-011 to 014
4	Non-useTime Procon :Set	When the value of the non-use time counter becomes more than the threshold	SP3-531-001 to 005
5	Manual ProCon:Exe	When SP 3-011 is used	SP3-011-001 to 006
6	Toner End Recovery	After the Toner End Status is cleared (Recovery is NOT done in the near end status)	-
7	Initial Developer Setting Process Control	When the machine detects a new PCU or development unit	-

Result Code for Executing Process Control

Check the following SPs.

- SP3-012-001 to 010 (Front)
- SP3-012-011 to 020 (Center)
- SP3-012-021 to 030 (Rear)

Category	Code	Result name	Description
00 and larger	00	Not executed	Factory default setting(SP default)
10and larger	11	Succeeded	-

7.Detailed Descriptions

Category	Code	Result name	Description
Result (Normal)			
20 and larger ID Sensor	21	ID Sensor Vsg adjust error	Out of range from Vsg=4.0±x.x[V/step]
	22	ID Sensor LED Adjust error	Ifsg>Max
	23	ID Sensor Output error (Positive reflect)	Vsg_reg<Min(Max)
	24	ID Sensor output error (Diffusion reflect)	Vsg_dif<Min(Max)
	25	ID Sensor offset Voltage error (Positive reflect)	Voffset_reg>Max
	26	ID Sensor offset Voltage error (Diffusion reflect)	Voffset_dif>Max
45 and larger ID Pattern detection	45	ID Pattern extract error	Cannot detect ID Pattern
	50	Vmin_Bk/K2 error(Max)	K:Vmin_Bk / CMY:K2>Max
	51	Vmin_Bk/K2 error(Min)	K:Vmin_Bk / CMY:K2<Min
	52	K5 error (Max)	K5>Max
	53	K5 error (Min)	K5<Min
	54	K5 calculated approximate point error	K5 calculated approximate point <Min
	55	Development gamma error (Max)	Development gamma >Max
	56	Development gamma error (Min)	Development gamma <Min
	57	Start developing voltage: Vk error(Max)	Start developing voltage: Vk>Max
	58	Start developing voltage: Vk error(Min)	Start developing voltage: Vk<Min
59	Not enough valid data	Adhesion amount data for development gamma calculation point is under 2	
60 and larger Potential adjustment	61	LD won't light	P patter is not written.
	62	Residual potential: Vr error	Vr>Max
	63	Electrified potential: Vd adjust error	Vd cannot be adjusted in target range.
	64	Exposure potential: Vpl adjust error	Vpl cannot be adjusted in target range
90 and larger Result(End)	90	Potential not adjusted	Potential control method is set as [0:FIX]
	99	Stopped	Stopped by door open, power off, error.

Category	Code	Result name	Description
			(Set when execute.)



- Execution result example (In order of YMCK from left)
- Factory default (SP default): [00,00,00,00]
- Starting adjust: [99,99,99,99]
- Fail Vsg adjust(Y): [21,99,99,99]
- Error of Development gamma Max(C): [99,99,55,99]
- Succeeded: [11,11,11,11]

The Process Control Flow

The potential of the unexposed drum is called the electrified potential (V_d), whereas the potential when toner starts to adhere to the drum is called the development bias (V_b).

Toner starts to adhere to the drum in proportion to the potential when the value of potential becomes more than V_b . The value (coefficient) which shows the relation between the potential and the amount of adhesion is called development gamma.

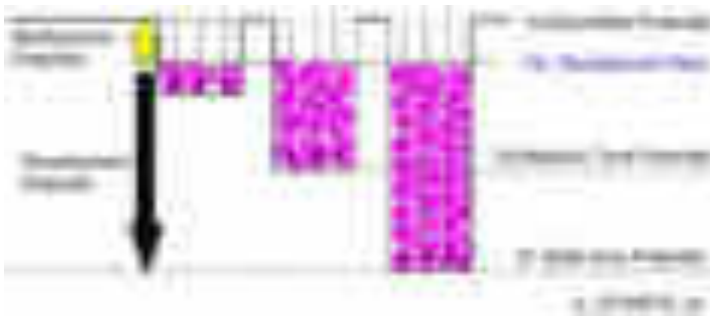

In addition to the development gamma and the potential, the toner density in the developer needs to be controlled. This is done to maintain the proper toner density (the amount of toner adhesion).

The target figure for the toner density in the developer is called V_{ref} .

Process Control is done as shown in the following chart, which includes development gamma determination, V_{ref} correction, and LD power control.

7.Detailed Descriptions

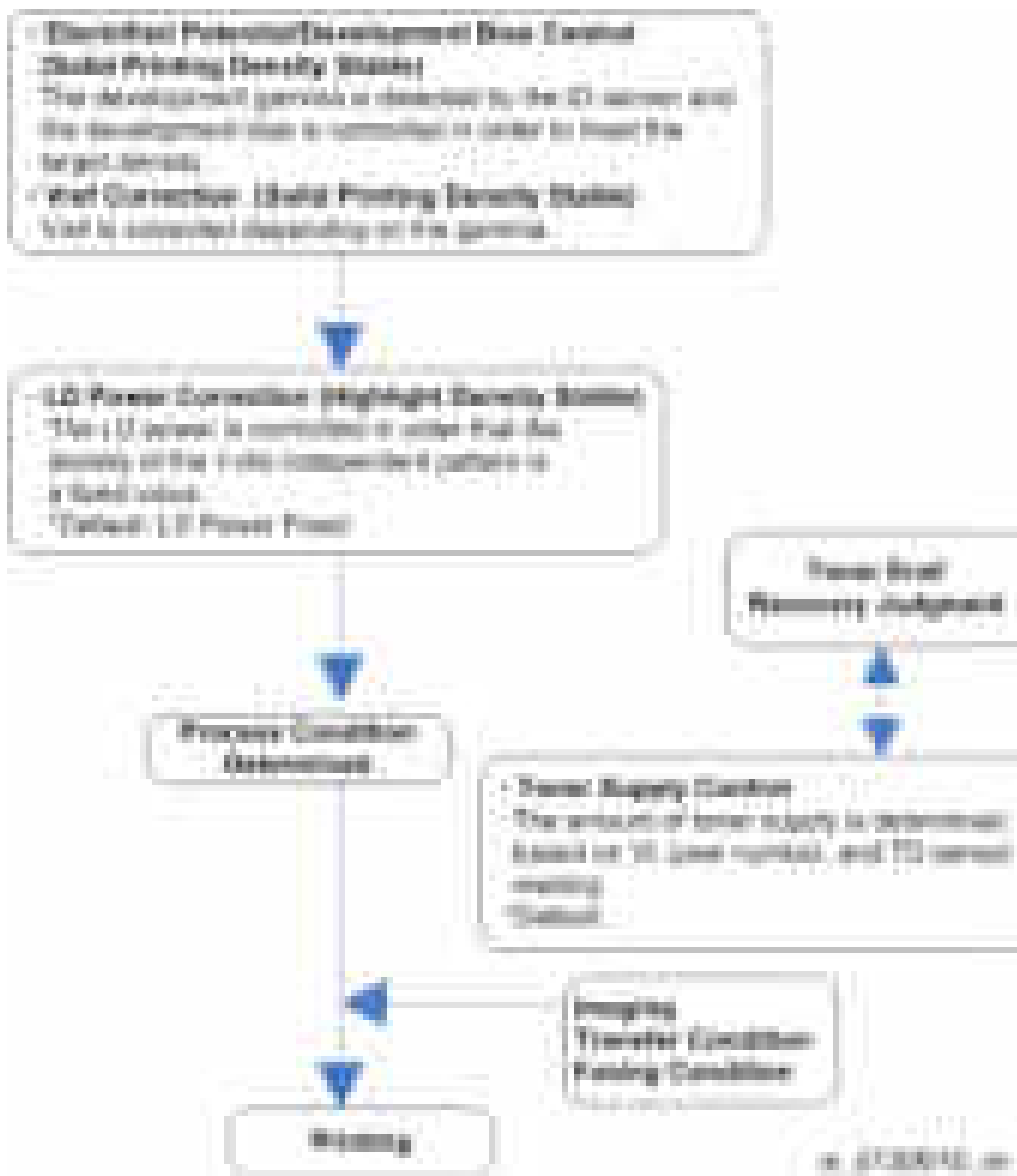

Electrified Potential / Development Bias, Vref Correction

Electrified Potential/ Development Bias and Vref Correction are done with the following procedure.

The operation time differs depending on the line speed.

1. Adjusting the ID sensor Vsg

The machine adjusts the LED strength of the ID sensor so that the value of Vsg (the charge which is detected from the background on the Transfer Belt) will be in the range of $4.0V \pm 0.5V$. When the center ID sensor detects that the Vsg value is not within the target range three times, SC370-02 (ID sensor error) will be issued.



- SP3-320-031/032/033 (Vsg Error Counter)
- SP3-320-013 (Vsg Upper Threshold)
- SP3-320-014 (Vsg Lower Threshold)
- If Vsg of the front or rear ID sensors fails to reach the target adjustment value, SC370-

01/03 (logging SC) is issued. In such a case, the intervals during the process control become shorter and this may result in a longer wait time.

Furthermore, if $V_{sg} < 0.3V$, SC371-01, SC371-02, or SC371-03 (ID sensor output error: output on the background [specular reflection]) is issued.

If $0.3V \leq V_{sg} \leq 2.2V$, SC375-01 or SC375-02 (ID sensor output error: damage to the belt detected) is issued.

2. Agitating the Developer (10 seconds)

The machine agitates the developer and reads the TD sensor output.



- SP3-539-001 (Dev Agitating Time :Set)

3. Creating patterns, detecting the density

10 patterns are created on the transfer belt and detected by each ID sensor, with the Charge/Development Bias adjusted for each pattern.

The ID sensor contains an LED [B] and two types of photodetectors. The sensor detects the reflection from the LED with the positive photodetector (REG) [A] and the diffusion photodetector (DIF) [C].

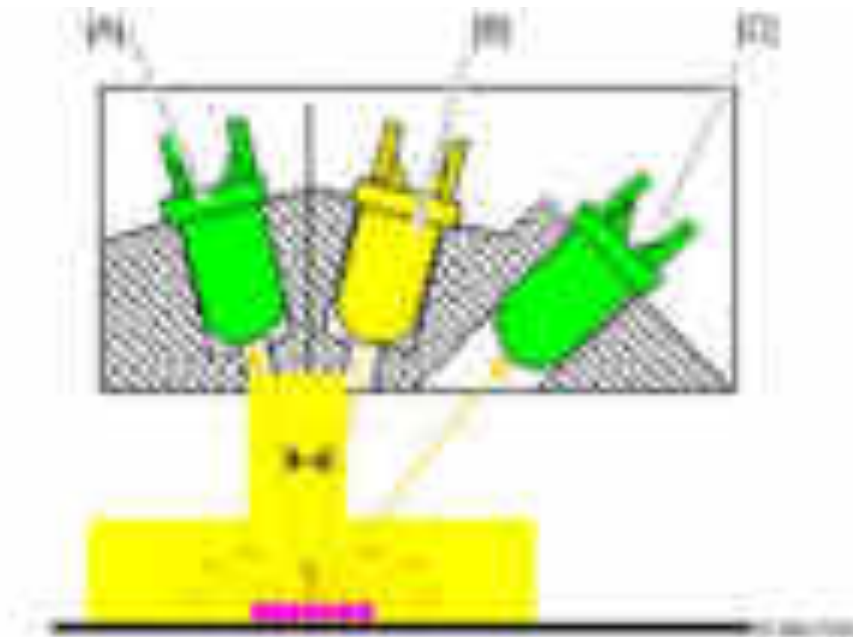

4. Determining V_{tref} from the Development Gamma

This decides the charge voltage and development bias

LD Power Control

LD Control is set with SP3-600-002 (Process Control/ Select ProCon: LD Control).

0: OFF (Fixed)

1: ON (Auto) **Default**

- **To use a fixed LD Power**

Change the SP setting to [0: OFF (Fixed)]. LD strength is fixed with SP2-221-001 to 004.

7.Detailed Descriptions

- **To control LD Power by Process Control (Default)**
 - The LD power is determined by process control.
 - The LD strength is adjusted based on a table which is determined by the Development Bias Control and Vref Correction.

Toner Supply Control

The Toner Supply Type can be selected with SP3-400-001 to 004 (Toner Supply Type: Select).

0:FIXED

2:PID

4:DANC

- **0: Fixed (Fixed supply method)**

The toner supply time is calculated based on the supply rate of SP3-440-001 to 004 (Fixed Supply Mode: Fixed Rate).
- **2: PID (Proportion Integral Differential)**

The amount of toner supply is calculated based on the pixel information and TD sensor information.
- **4: DANC (Divided Active Noise Control) (Default)**

Conventional PID method + active noise control. It controls the timing to supply the developer to minimize uneven developer density in the development unit.

Developer Initial Setting

When a new PCDU is set in the machine, the machine automatically detects it and enters the developer initial setting mode. The machine then detects the μ count which is an output from the TD sensor (S37)(S38)(S39)(S40). The developer initial setting is done as follows.

1. Starting the developer initial setting mode

The new unit detection mechanism triggers the developer initial setting mode.

If the developer initial setting for the PCDU is executed successfully, it will not, subsequently, be automatically executed. (However, it is still possible to execute it manually.)

2. Agitating the developer

The machine rotates the development roller and transport coil to agitate the developer for 30 seconds.

3. Detecting the μ count (Initial value)

While agitating the developer, the machine detects the output from the TD sensor (S37)(S38)(S39)(S40), and stores this output as the initial μ count.

4. Calculating V_t

The machine calculates V_t using the difference of the current μ count while referring to the initial count through SP.

5. Forced toner supply (only when newly installing the machine)

This step is required only when the machine is newly installed because there is no toner in the toner transport route.

When the developer initial setting is successfully completed, the machine stores the calculated V_t as V_{tref} . The V_{tref} is used as a reference the next time the machine performs an initial developer setting.

SC360-01 through -04 appears if the results of step 3 are as follows:

- The μ count is equal or exceeds the threshold (6480 [counts]).
- The μ count does not match the target threshold (5800 – 6380 [counts]) three times consecutively.

Process Control and MUSIC are forcibly done after developer initial setting when a PCDU is replaced.

MUSIC (Automatic Color Registration Correction)

Correction Timing

The machine creates correction patterns, measures the image position by reading the correction patterns, and corrects the writing position.

	Operative Condition	Notes
1	Power switch just turned on, or recovering from the energy save mode	Mode b or Mode a is done See notes *1 and *2 below.
2	When printing (when the temperature has changed by a certain amount since the previous job ended, or when the number of pages printed becomes more than a set number)	Mode b is done
3	End of printing (when the temperature has changed by a certain amount since the previous job ended, or when the number of pages printed becomes more than a set number)	Mode b is done
4	Front cover opening/ closing (when the temperature has changed by a certain amount since the previous job ended)	Mode b is done
5	Waiting (when the temperature has changed by a certain amount since the previous job ended, and when the number of pages printed becomes more than a set number))	Mode b is done
6	New detection of the PCDU/ image transfer belt	Mode a is done

*1 Mode a: adjusted two times

*2 Mode b: adjusted once

Executing MUSIC Manually

To operate modes a/b/c/d manually, use the following SPs.

SP No.	Notes
SP2-111-001	-

7.Detailed Descriptions

SP No.	Notes
(Mode a)	
SP2-111-002 (Mode b)	-
SP2-111-003 (Mode c)	Execute "Mode c" if the MUSIC pattern is shifted too large, or after the laser unit is replaced.
SP2-111-004 (Mode d)	<ul style="list-style-type: none"> • Mode d is the same as doing mode c then mode a. Normally in the field, we should only use Mode d. Color registration errors in the field can be corrected only by the Mode d when the error is large. • You can also execute it in the UP mode. <ol style="list-style-type: none"> 1. Press [Settings] on the HOME screen. 2. Press [Machine Features Settings] > [Maintenance] > [Color Registration].

[Color Registration] in Settings (SP2-111-004: mode d)

Correction with higher accuracy can be performed by contacting the image transfer roller and executing MUSIC in a condition that is almost the same as during actual printing. This process is called 'contact MUSIC'.

Contact MUSIC can be done manually by executing HOME screen -> Settings icon -> Machine Features Settings -> Maintenance -> Color Registration (SP2-111-004).

When the Imageable Area Extension Unit is installed, the MUSIC sensor is in the printing area.

Therefore, the image transfer roller cannot be contacted and execution of MUSIC becomes the same as the previous machine.

Items	What is executed
Normal Operation	Rough adjustment -> Fine adjustment -> Contact MUSIC
With Imageable Area Extension Unit	Rough adjustment -> Fine

The time taken to execute this function depends on the model, but it completes within approximately 30 seconds on any model.

MUSIC Error Judgment

When MUSIC is done, the results must be checked for each color. SP2-194-007 shows whether MUSIC was OK or NG, and SP2-194-010 to 012 show the details of the result.

- SP2-194-007 (Execution Result)

Detection Result	Meaning
0	Success

Detection Result	Meaning
1	Failure

- SP2-194-010 (Error Result: C)
- SP2-194-011 (Error Result: M)
- SP2-194-012 (Error Result: Y)

Detection Result	Meaning
0	MUSIC not executed
1	Correction Succeeded: Sampling is conducted correctly and the correction is completed
2	Sampling Failed (When the MUSIC pattern failed to be detected)
3	Detection Patterns Lack (When the number of lines detected is smaller than the fixed number)
4	The sampled data is beyond the correction range. (Calculated correction value is just out of range)
5	The ID sensor erroneously detected.

Correction Operation Outline

1. The machine corrects the ID sensor output by Vsg adjustment
2. The machine creates the MUSIC pattern on the transfer belt with toner of each color.
3. The machine reads the MUSIC pattern on the transfer belt and detects the positions of the line patterns.
4. The machine calculates the amount of color registration or skew from the detected positions.
5. The machine determines the correction for the color registration, by calculating the required main scan magnification shift, main scan magnification deviation, main scan registration shift, skew correction value, and sub scan registration shift from the detected positions.

Real Time Process Control

During printing, 5 mm patterns are created outside the normal imaging area on the transfer belt, and the image density is corrected in the real time, to improve printing of solid areas. However, note that if the optional Imageable Area Extension Unit is installed, this process is disabled.

7.Detailed Descriptions

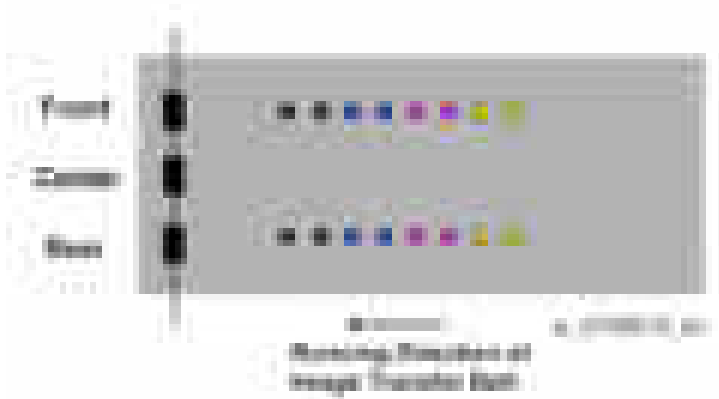

Normally, the real-time control is done once every 10 sheets, but it could be done once every 5 sheets depending on the density detection level.

The frequency depends on the following SPs.

- SP3-301-001: RTP Pattern:Set:Create Intrvl:BW
- SP3-301-002: RTP Pattern:Set:Create Intrvl:FC

To see the latest result, check the following SPs. If there is an error, the result will not be updated.

- SP3-300-001 to 004 RTP Pattern:Disp:M/A(Latest):Each Color
- SP3-300-001 to 004 RTP Pattern:Disp:M/A(Target):Each Color

When SC370-01/03 (logging SC) is issued, real-time process control is not executed. (However, when process control is executed, it is done so at longer intervals so that the density is maintained.)

IBACC

Outline

IBACC (Intermediate Belt type of inner ACC) maintains the quality of gradation in the images. To do this, the machine makes a gradation pattern on the transfer belt, and measures variations in density between the middle to the highlight tone, which solid printing control cannot correct perfectly. The machine feeds back variations in the density to the image-processing parameters (the digital gamma correction table).

Operation Timing

IBACC must be done in the shortest time possible, in cooperation with process control. This is because the process requires time to adjust. If the ON/OFF setting of IBACC operation (SP3-600-030) is ON, IBACC is done at the time of normal process control. If the setting is OFF, the IBACC is not done. Before the IBACC procedure, the machine determines whether IBACC can be done, based on the engine condition. If there is an error in the latest process control, the following IBACC is considered to be unnecessary.

Patch Pattern

16x16 patterns are created. The order of the tones depends on the image processing layout. There are

patterns for 600 dpi and 1200 dpi.

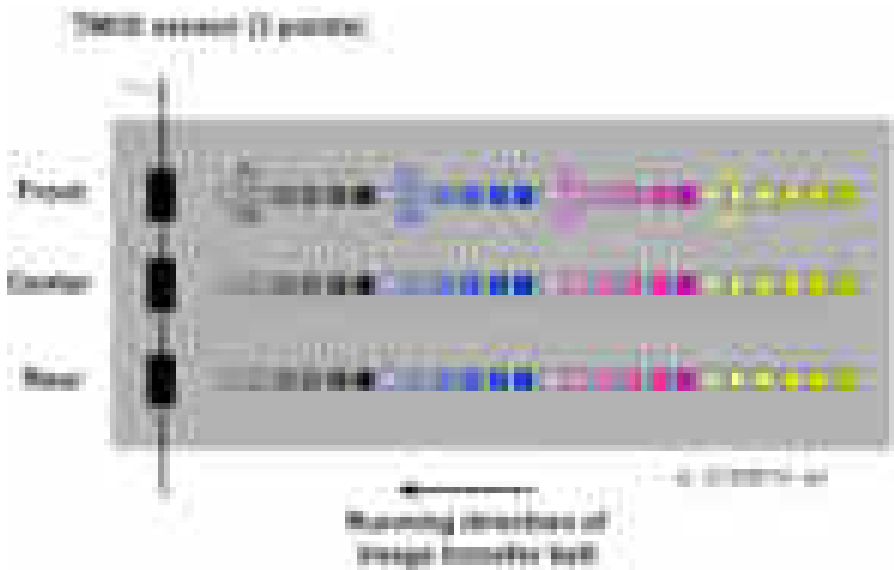

SP Descriptions

- **SP1-903-003, and 004 (Amplitude Setting)**
Displays amplitude value of BIT1 control.
- **SP2-111-001 (Forced Line Position Adj.: Mode a)**
Executes MUSIC mode a (fine-tune x 2)
- **SP2-111-002 (Forced Line Position Adj.: Mode b)**
Executes MUSIC mode b (fine-tune x 1)
- **SP2-111-003 (Forced Line Position Adj.: Mode c)**
Executes MUSIC mode c (rough-tune x 1)
- **SP2-111-004 (Forced Line Position Adj.: Mode d)**
Executes MUSIC mode d (rough-tune, fine-tune, then contact MUSIC)
- **SP2-194-007 (MUSIC Execution Result: Execution Result)**
Displays the execution results of MUSIC.
0: Completed successfully, 1: Failed
- **SP2-194-010,-011, and -012 (MUSIC Execution Result:Error Result: C, M, Y)**
Displays the details of MUSIC results for each color.
- **SP3-011-001 (Manual ProCon :Exe: Normal ProCon)**
Executes Pro-Con.
- **SP3-011-002 (Manual ProCon :Exe: Density Adjustment)**
Executes toner density adjusting Pro-Con.
- **SP3-011-003 (Manual ProCon :Exe: ACC RunTime ProCon)**
Executes pre-ACC Pro-Con.
- **SP3-011-004 (Manual ProCon :Exe: Full MUSIC)**
Executes Pro-Con / full MUSIC.
- **SP3-011-005 (Manual ProCon :Exe: Normal MUSIC)**

7.Detailed Descriptions

Executes Pro-Con / normal MUSIC.

- **SP3-012-001 to 010 (ProCon OK?: Front)**

Displays the history for past 10 times of ProCon results code detected by the front TM/ID sensor.

The code is 2 digits per color from left, in the order of YMCK.

- **SP3-012-011 to 020 (ProCon OK?: Center)**

Displays the history for past 10 times of ProCon results code detected by the center TM/ID sensor.

The code is 2 digits per color from left, in the order of YMCK.

- **SP3-012-021 to 030 (ProCon OK?: Rear)**

Displays the history for past 10 times of ProCon results code detected by the rear TM/ID sensor.

The code is 2 digits per color from left, in the order of YMCK.

- **SP3-400-001 to 004 (Toner Supply Type: Select; Bk, C, M, Y)**

Selects the toner supply mode.

0: FIXED, 2: PID, 4: DANK

- **SP3-530-001 to 008 (PowerON ProCon :Set)**

Specifies the non-use time setting, temperature, relative humidity, absolute humidity or page interval as the threshold of process control execution determination at power on.

- **SP3-531-001 to 004 (Non-useTime Procon :Set)**

Specifies the non-use time setting, temperature, relative humidity, absolute humidity or page interval as the threshold of process control execution determination for during the standby mode.

- **SP3-533-001 (Interrupt ProCon :Set: Interval:Set:BW)**

Specifies the number of sheets interval for Interrupt Pro-Con (BW).

- **SP3-533-002 (Interrupt ProCon :Set: Interval:Disp:BW)**

Displays the number of sheets interval for Interrupt Pro-Con (BW).

- **SP3-533-003 (Interrupt ProCon :Set: Corr(Short):BW)**

Specifies the correcting coefficient (Short) of number of sheets interval for Interrupt Pro-Con (BW).

- **SP3-533-004 (Interrupt ProCon :Set: Corr(Mid):BW)**

Specifies the correcting coefficient (Mid) of number of sheets interval for Interrupt Pro-Con (BW).

- **SP3-533-011 (Interrupt ProCon :Set: Interval:Set:FC)**

Specifies the number of sheets interval for Interrupt Pro-Con (FC).

- **SP3-533-012 (Interrupt ProCon :Set: Interval:Disp:FC)**

Displays the number of sheets interval for Interrupt Pro-Con (FC).

- **SP3-533-013 (Interrupt ProCon :Set: Corr(Short):FC)**

Specifies the correcting coefficient (Short) of number of sheets interval for Interrupt Pro-Con (FC).

- **SP3-533-014 (Interrupt ProCon :Set: Corr(Mid):FC)**

Specifies the correcting coefficient (Mid) of number of sheets interval for Interrupt Pro-Con (FC).

- **SP3-534-001 (JobEnd ProCon :Set: Interval:Set:BW)**

Specifies the number of sheets interval for Job end Pro-Con (BW).

- **SP3-534-002 (JobEnd ProCon :Set: Interval:Disp:BW)**

Displays the number of sheets interval for Job end Pro-Con (BW).

- **SP3-534-003 (JobEnd ProCon :Set: Corr(Short):BW)**
Specifies the correcting coefficient (Short) of number of sheets interval for Job end Pro-Con (BW).
- **SP3-534-004 (JobEnd ProCon :Set: Corr(Mid):BW)**
Specifies the correcting coefficient (Mid) of number of sheets interval for Job end Pro-Con (BW).
- **SP3-534-011 (JobEnd ProCon :Set: Interval:Set:FC)**
Specifies the number of sheets interval for Job end Pro-Con (FC).
- **SP3-534-012 (JobEnd ProCon :Set: Interval:Disp:FC)**
Displays the number of sheets interval for Job end Pro-Con (FC).
- **SP3-534-013 (JobEnd ProCon :Set: Corr(Short):FC)**
Specifies the correcting coefficient (Short) of number of sheets interval for Job end Pro-Con (FC).
- **SP3-534-014 (JobEnd ProCon :Set: Corr(Mid):FC)**
Specifies the correcting coefficient (Mid) of number of sheets interval for Job end Pro-Con (BW).
- **SP3-539-001 (Dev Agitating Time :Set: Time)**
Specifies the developer agitating time.
- **SP3-600-002 (Select ProCon: LD Control)**
Specifies the LD control mode.
0:OFF, 1:ON
- **SP3-600-030 (Select ProCon: IBACC:ON/OFF)**
Specifies ON/OFF of IBACC.
0: OFF, 1: ON

PCDU (Photo Conductor and Development Unit)

Changes from the Previous Models

Lookup Table

Item	MP C2004/C2504/C3004/C3504/C4504/C5504/C6004(Previous Model)	IM C2000/C2500/C3000/C3500/C4500/C5500/C6000
PCDU seals	Pulled out by hand	Wound automatically when turning on the power
Removing PCDU	Remove: <ul style="list-style-type: none"> • PCDU front cover (x1) • Fixing screw on PCDU (x1) • Connector (x1) 	Unlock PCDU by a lever

Changes

- **Removing the PCDU**

In the previous model [A], after removing the PCDU cover, the PCDU would be found to be secured by a screw (You have to disconnect a connector to remove PCDU from the machine). In this model [B], you can remove the unit simply by releasing the lever [C].



- **PCDU Drawer Connector**

The PCDU is incompatible with the previous model (Met-C2) and a similar model (Met-P2). Because of the differences in the protrusions on and depressions in the drawer [A] of the machine, the PCDU of the previous and other models cannot be installed.



 Overview

All colors for IM C4500/C5500/C6000 and Bk for IM C3000/C3500

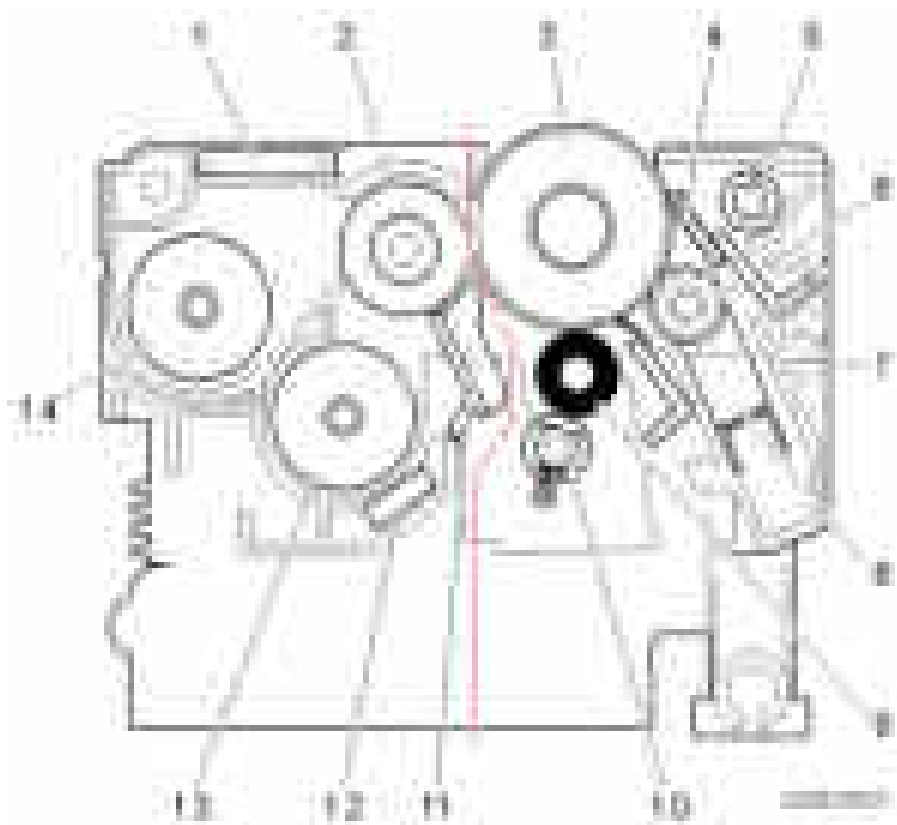

No.	Description	No.	Description
1	Inner pressure adjustment filter	8	Lubricant bar
2	Development roller	9	Charge roller (non-contact)
3	OPC drum	10	Cleaning roller (charge roller)
4	Cleaning blade	11	Doctor blade
5	Toner collection auger	12	TD sensor (S37)(S38)(S39)(S40)
6	Lubricant roller	13	Developer supply coil
7	Lubricant blade	14	Developer collection coil

7.Detailed Descriptions

CYM for IM C3000/C3500

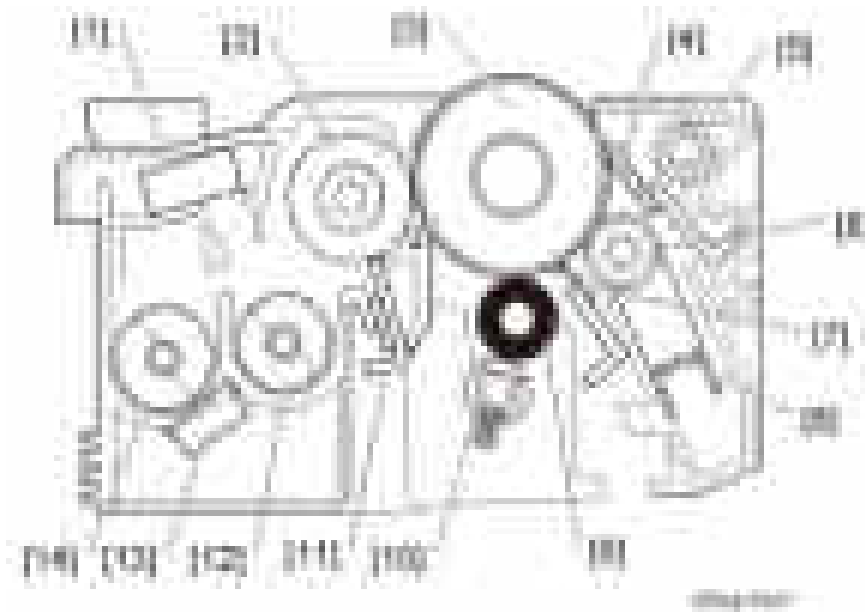

No.	Description	No.	Description
1	Inner pressure adjustment filter	8	Lubricant bar
2	Development roller	9	Charge roller (non-contact)
3	OPC drum	10	Cleaning roller (charge roller)
4	Cleaning blade	11	Doctor blade
5	Toner collection auger	12	Developer supply coil: right
6	Lubricant roller	13	TD sensor (S37)(S38)(S39)(S40)
7	Lubricant blade	14	Developer supply coil: left

All colors for IM C2000/C2500

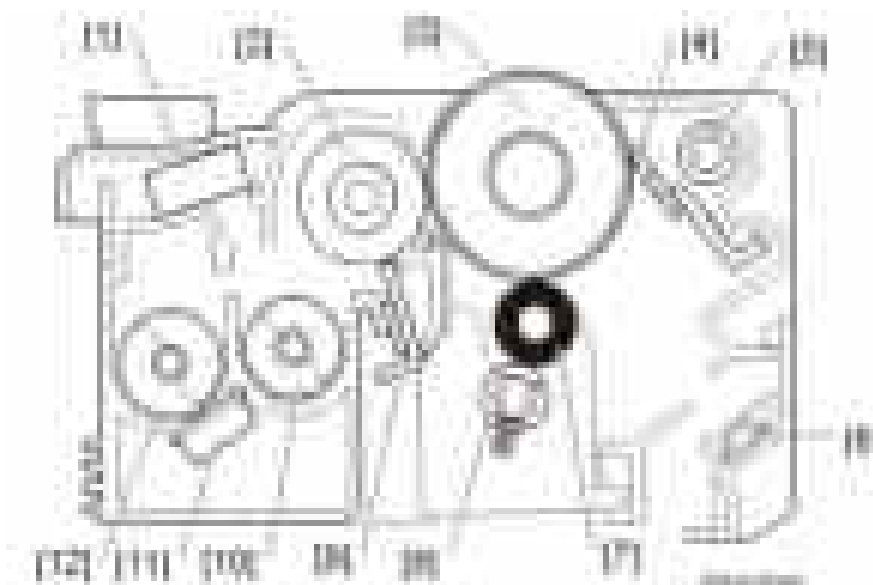

No.	Description	No.	Description
1	Inner pressure adjustment filter	7	Charge roller (non-contact)
2	Development roller	8	Cleaning roller (charge roller)
3	OPC drum	9	Doctor blade
4	Cleaning blade	10	Developer supply coil: right
5	Toner collection auger	11	TD sensor (S37)(S38)(S39)(S40)
6	Quenching lamp*1	12	Developer supply coil: left

*1 The quenching lamp is mounted on the main machine, not on the PCDU.

Mechanism (PCU)

Drum Drive

Bk and CMY are both driven by the motor.

PCU	Drive source
Bk	PCU: Black / Image Transfer Motor (M17)*
CMY	PCU Motor: CMY (M15)

* The PCU: Black / Image Transfer Motor (M17) is used to drive both the image transfer unit and the waste toner bottle.

Charge

In this machine, there are charge rollers for each color to reduce the ozone generation.

The charge roller, which is a rubber-covered roller that has a metal shaft, rotates in the forward direction contacting with the OPC drum and applies a charge to the OPC drum surface uniformly.

The life of the PCU is extended by separating the charge roller from the OPC drum by about 50 μ .

When the charge roller is dirty, an uneven charge is generated, so a cleaning roller (charge roller) always contacts the charge roller.

Drum Cleaning

Residual transfer toner on the OPC drums is recovered by a cleaning blade. The cleaning blade is installed in the counterclockwise direction to the drum rotation in contact with the drum and scrapes toner off.

The lubricant roller rotates in the opposite direction to the OPC drum and coats it with a solid lubricant to enhance cleaning. Also, by rotating the lubricant blade in the trailing direction instead of the conventional counterclockwise direction and replacing the lubricant coating brush with the lubricant roller, the lifetime of the device is extended.

In addition to cleaning, the solid lubricant bar suppresses wear of the OPC drum due to the blade.

7.Detailed Descriptions

Mechanism (Development)

Development System

A dry two-component magnetic brush development system is used.

The dry two-component magnetic brush development system gives a suitable electrostatic charge to the toner using magnetic particles called carriers which form a magnetic brush due to their magnetism and cause toner to adhere electrostatically to the drum surface.

Parts Construction

All colors for IM C4500/C5500/C6000 and Bk for IM C3000/C3500 (OD System)

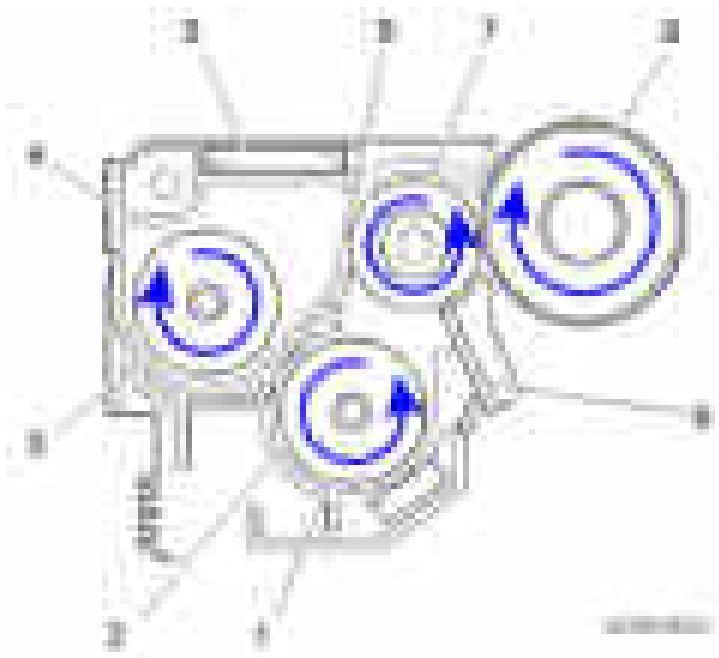

No.	Description	No.	Description
1	Developer supply coil	6	Separation plate
2	Lower case	7	Development roller
3	Developer collection coil	8	OPC drum
4	Upper case	9	Doctor blade
5	Inner pressure adjustment filter	-	-

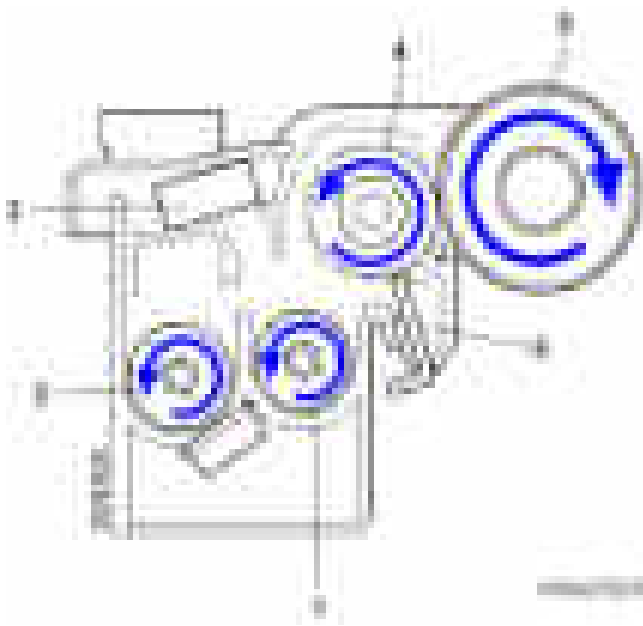
CYM for IM C3000/C3500 and All colors for C2000/C2500 (Double-coil Agitation System)

No.	Description
1	Developer supply coil: right
2	Developer supply coil: left
3	Inner pressure adjustment filter
4	Development roller
5	OPC drum
6	Doctor blade

Agitation System

Model	Bk	CMY
IM C6000	OD system	OD system
IM C5500	OD system	OD system
IM C4500	OD system	OD system
IM C3500	OD system	Double-coil agitation system
IM C3000	OD system	Double-coil agitation system
IM C2500	Double-coil agitation system	Double-coil agitation system
IM C2000	Double-coil agitation system	Double-coil agitation system

OD (One-way circulation of Developer) system [A]

The developer supply/recovery route is divided to make the toner density uniform in the longitudinal direction of the unit and stabilize the solid image.

7.Detailed Descriptions

The amount of developer adhering to the development roller is controlled by a doctor blade [B] and supplies toner to the surface of the OPC drum.

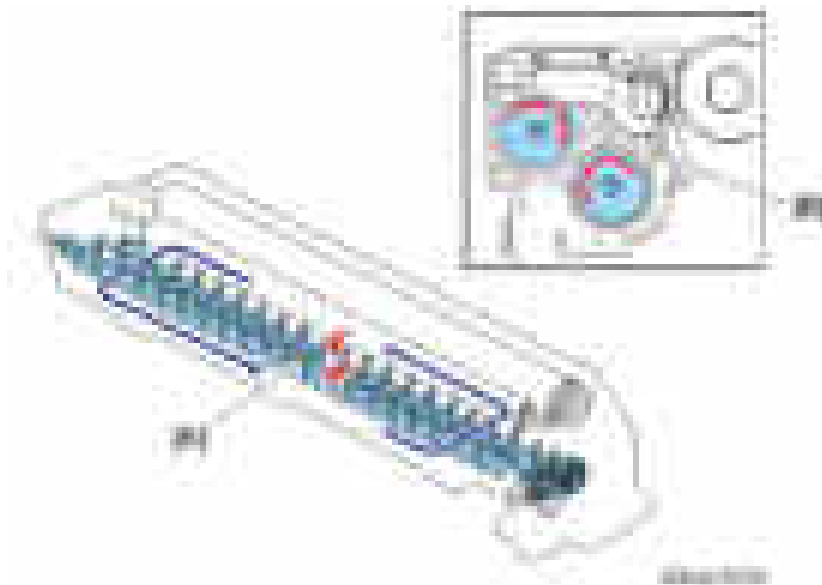

Double-coil Agitation System (Twin-shaft Environment Development System) [A]

Toner transported from the toner bottle to the development unit will be agitated with the developer by two toner supply coils [A] and will be delivered to the development roller.

The amount of developer adhering to the development roller is controlled by a doctor blade [B] and supplies toner to the surface of the OPC drum.

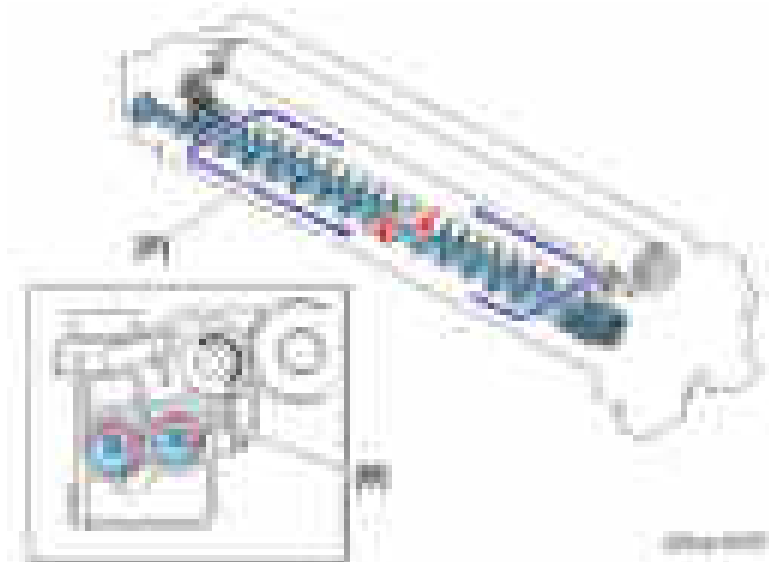

TD sensor (S37)(S38)(S39)(S40)

In the TD sensor (also called the μ sensor), there is an ID chip storing the machine identification information, the running distance information of Development unit and PCU, and other information used by image density control.

ID chip

PCDU replacement information and toner density information are stored.

In the ID chip, the following data is stored.

- Model series ID
- New PCDU information
- Color information
- Developer replacement information
- PCU replacement information
- TD sensor serial no., date of manufacture
- Date of unit installation
- Unit total counter at installation (no. of sheets, travel distance)
- Date of unit operation
- Unit total counter during operation (no. of sheets, travel distance)
- Unit parts information
- Total counter
- Total color counter

Inner Pressure Adjustment Filter

To prevent scattering of toner, the air pressure in the development unit is released via the inner pressure adjustment filter.

Development Drive

The following table shows the drive components for each model.

A gear for developer coil rotation is provided on the front side of the unit (downstream side).

IM C2000/2500/C3000/C3500:

Drive source for Bk	Drive source for C, M, Y
PCU: black/image transfer motor (M17)	Development motor: CMY (M16)

The PCU: Black / Image Transfer Motor (M17) is also used for the image transfer unit and waste toner bottle. Drive is switched by the development solenoid (SOL4).

IM C4500/C5500/C6000:

Drive source for Bk	Drive source for C, M, Y
Development motor: black (M29)	Development motor: CMY (M16)

Development Bias

Applied from the development power pack via a plate spring on the front cover of the PCDU.

Toner Supply

Changes from the Previous Machine

No difference mechanically.

Overview

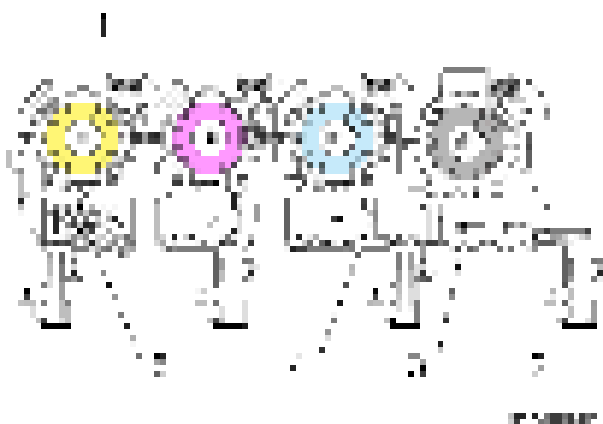

No.	Description	No.	Description
1	Toner bottle drive motor (M11)(M12)(M13)(M14)	4	Toner end sensor (S28)(S29)(S30)(S31)
2	Agitator	5	Toner supply motor (M19)(M20)(M21)(M22)
3	Sub-hopper	-	-

Toner is supplied by a Hi-Act (High Accuracy and Clean Toner) cartridge + sub-hopper.

Mechanism

Toner Supply (Toner Bottle - Sub-hopper)

When the toner bottle is set, the transport nozzle on the side of the unit is inserted into the bottle (Hi-Act system).

When the piezoelectric sensor in the sub-hopper detects there is no toner, the toner bottle drive motor (M11) (M12) (M13) (M14) rotates. The rotation of the toner bottle drive motor (M11) (M12) (M13) (M14) is transmitted to a transport coil via a drive gear, and toner in the bottle is transported horizontally. Due to the coil transport, stable toner supply/enhanced supply precision/reduction of residual toner are achieved.

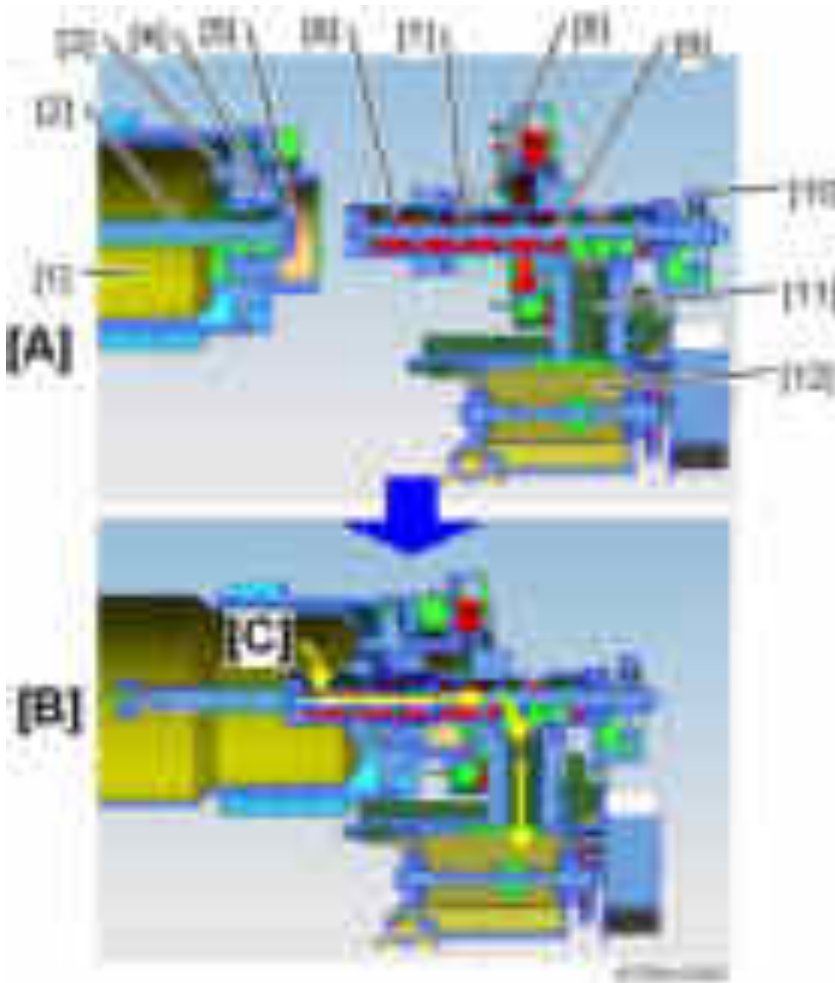

[A]: Before setting

[B]: After setting

[C]: Toner path

No.	Description	No.	Description
1	Toner bottle	7	Transport nozzle
2	Coil spring	8	Coil spring
3	Shutter holder	9	Toner transport coil
4	Seal	10	Drive Gear
5	Shutter	11	Rocking spring
6	Shutter	12	sub-hopper

Toner transported by the coil falls directly into the sub-hopper via the transport pipe.

To prevent toner from remaining, the rocking spring [A] in the transport pipe moves up and down together with the coil.

7.Detailed Descriptions

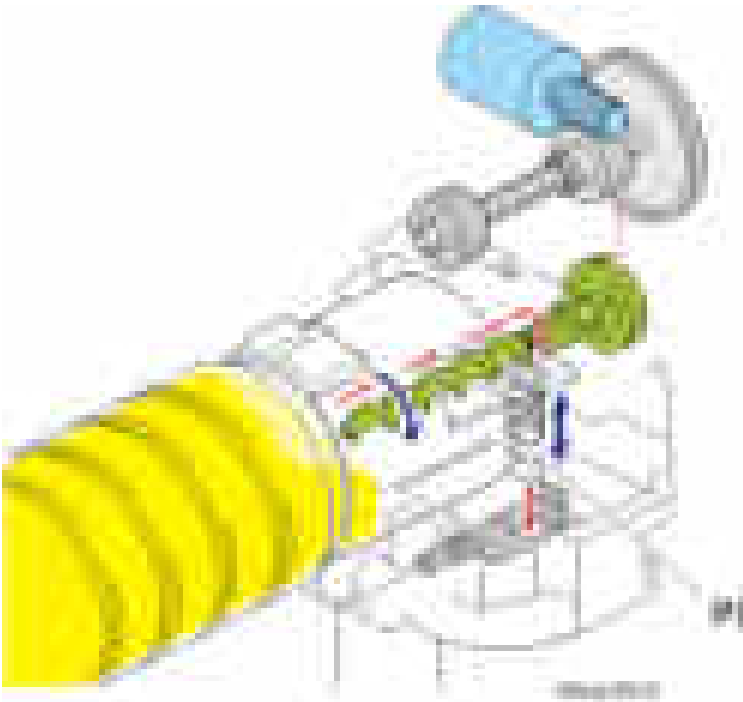

Toner Bottle ID Chip and ID Chip ContactBoard

A contact type ID chip is provided in each toner bottle which stores residual toner and various toner counters, toner end history, and model serial number.

Data read and write to the ID chip contact board is performed by contact with the ID chip contact board (PCB3) (PCB4) (PCB5) (PCB6).

Toner Supply (Sub-hopper - Development Unit)

The sub-hopper can hold Bk: 24.7 cc (equivalent to 230 sheets of 5% chart), or Color: 19.3 cc (equivalent to 150 sheets of 5% chart) of toner.

Toner which has fallen into the sub-hopper is homogenized by an agitator (Plastic sheet: 2 for BK, 1 for each color).

After being horizontally transported by the coil, toner in the sub-hopper falls directly into the development unit.

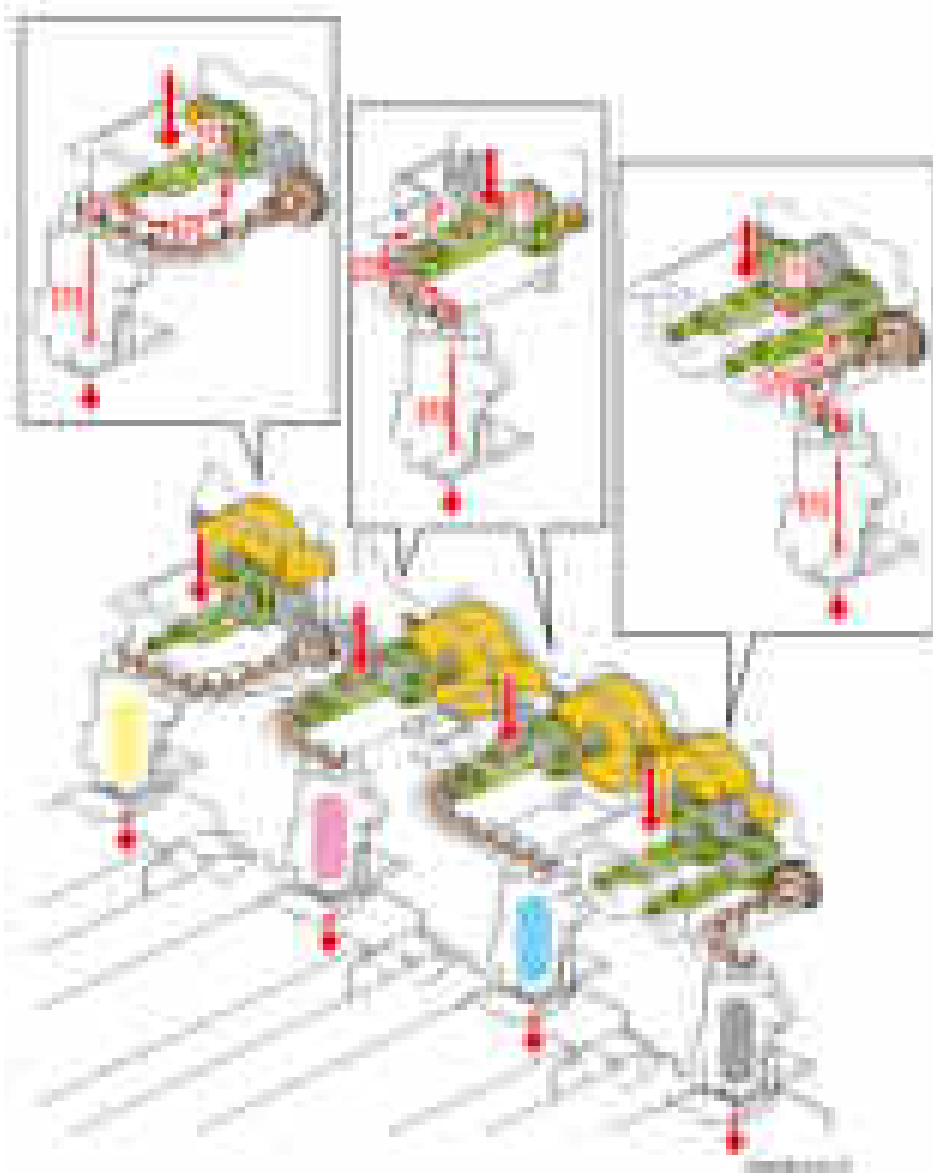

- 1.** Transport by the plastic sheet
- 2.** Transport horizontally by the coil
- 3.** Vertical drop to the development unit

Drive

To shorten the recovery time after bottle replacement, the toner bottle and sub-hopper are driven separately.

The sub-hopper is driven by a stepping motor to reduce supply variations.

Toner Near End/End Detection

In this machine, there are two types of toner near end status.

The detection conditions and detection operation for each status are shown in the following table.

Control overview

7.Detailed Descriptions

Status	Control panel message	Detection conditions
Estimated Toner Near End SP3-101-001 to 004="2"	Control panel banner display: Check you have a print cartridge replacement (s). Current print cartridge can be used until the replacement alert.	If the residual amount in the toner cartridge falls below SP3-110-001 to 004 (Near End Thresh). The lesser of the "toner residual amount computed from the toner supply motor drive time" and the "toner residual amount computed from the pixel count" is taken as the toner residual amount.
Definite Toner Near End SP3-101-001 to 004="1"	Control panel banner display: <Toner Cartridge is empty. Printing will be suspended soon. Replace the cartridge.>	If "the toner cartridge residual amount falls below specification" and "the toner end sensor (S18)(S19)(S20)(S21) in the sub-hopper has detected toner end" Remarks: When toner end is detected, to use up all the toner in the cartridge, the toner cartridge is rotated for 5 seconds (full use control). After full use control, when the device status has reached "Definite Near End," the toner cartridge does not rotate.
Toner End	Control panel pop-up display (alert screen): <Toner has been depleted. Replace Toner Cartridge.>	Toner end is defined by the following conditions (1) or (2): (1) Determination by number of sheets and pixel count (After definite toner near the end, the count is begun). (2) Determination by Vt output (not related to Definite Toner Near End)

Control details

Estimated Toner Near End

- The toner residual amount Z (SP3-102-021 to 024) is taken as the lesser of the toner residual amount Z1 computed from the toner supply motor drive time (SP3-102-001 to 004) and the toner residual amount Z2 computed from the pixel count (SP3-102-011 to 014).
- If the condition, toner residual amount Z (SP3-102-021 to 024) < near end residual amount threshold value (SP3-110-001 to 004) is satisfied, this is taken as the estimated toner near end.

Definite Toner Near End

Preconditions

- The toner residual amount Z (SP3-102-021 to 024) is taken as the lesser of the toner residual amount Z1 computed from the toner supply motor drive time (SP3-102-001 to 004) and the toner residual amount Z2 computed from the pixel count (SP3-102-011 to 014).
- If the condition, toner residual amount Z (SP3-102-021 to 024) < sensor near end residual amount

threshold value (SP3-120-001 to 004) is satisfied, toner end sensor (S18)(S19)(S20)(S21) detection is begun to determine the definite end. (When the toner residual amount is more than the threshold value, determined by the toner end sensor (S18)(S19)(S20)(S21) is not performed).

Sensor detection

- The toner end sensor (S18)(S19)(S20)(S21) detects the sensor output every 200 ms while the polygon mirror motor (M27) is ON, and determines whether toner is present or not from the latest 10 counts.
- The determination result is stored in the "no toner counter (SP3-121-001 to 004)". To prevent clearing due to erroneous detection, the counter is reset if the toner end sensor (S18)(S19)(S20)(S21) detects "toner remaining" 4 times in a row.
- If the condition "no toner counter (SP3-121-001 to 004) > sensor near end determination threshold value (SP3-122-001 to 004) is satisfied, full use control which rotates the toner bottle for a certain time (SP3-163-001) is performed, and toner presence/absence determination by the toner end sensor (S18)(S19)(S20)(S21) is performed again.
- If no toner is detected after full use control determination, it is taken as definite toner near end.

Operation after definite toner near end

- After changing the status to definite toner near end, sheet counter and pixel counter increment is begun to detect toner end.

SP3-133-011 to 014 (TE Detect :Set Page Cnt:K, C, M, Y)

SP3-133-031 to 034 (TE Detect :Set Pxl Cnt:K, C, M, Y)

Recovery when the toner has almost run out

- The toner bottle operation is triggered when the machine starts printing immediately after switching the power off and then back on, recovering from the energy saving mode, or opening and closing the cover. If the toner end sensor (S18)(S19)(S20)(S21) detects "toner remaining", the toner bottle operation stops, and according to the ID chip data on the toner bottle SP3-101-001 to 004 (Toner Status :Disp) display "10" or "2" (estimated toner end).

The toner bottle stops if the sensor does not detect "toner remaining" after operating for 2 seconds.

Toner End

Pattern (1): Determination by paper sheet counter/pixel counter

The total sheet counter and pixel counter values after definite toner near end are compared with the threshold values.

If the following "(evaluation method A=TRUE) and (evaluation method B=TRUE) or (evaluation method C=TRUE)" is satisfied, it is determined as toner end.

Determination method A: Sheet counter (SP3-133-011 to 014) > Sheet counter threshold value (min)

Determination method B: Sheet counter (SP3-133-011 to 014) > Sheet counter threshold value (max)

Determination method C: Pixel counter (SP3-133-031 to 034) > Pixel counter threshold value

Pattern (2): Determination by Vt output

When the deviation between the TD sensor output value and TD sensor target value has become large,

7.Detailed Descriptions

it is taken as toner end.

After definite toner end has been determined

The difference between the output of the TD sensor (Vt: SP3-210-001 to 004) and the target value of the TD sensor (Vtref: SP3-230-001 to 004) is computed as the delta Vt, and values of the delta Vt larger than the threshold value (SP3-131-001) are integrated as "sigma delta Vt" (SP3-132-001 to 004).

If the integration value of "sigma delta Vt" is larger than the threshold value (SP3-132-002), it is determined to be toner end.

Before definite toner near end is determined (bottle full or estimated toner near end)

The computation is done in the same way as for definite toner near end, but separate values for the delta Vt threshold value and "sigma-delta Vt" threshold value are used.

the delta Vt threshold value before NE: SP3-131-011

"sigma delta Vt" threshold value before NE: SP3-131-012

SP Descriptions

- **SP3-101-001 to 004 (Toner Status :Disp)**
Displays the amount of toner remaining for each color. Uses a descending 10-step scale: 10: Full, 2: Estimated toner near end, 1: Definite toner end, 0: Toner end
- **SP3-110-001 to 004 (Near End Thresh)**
Sets the threshold amount of judging near-toner end.
- **SP3-102-001 to 004 (Toner Remain:Disp: Bottle Motor Bk, C, M, Y)**
Displays the remaining toner calculated from the motor running time.
- **SP3-102-011 to 014 (Toner Remain:Disp: Pixel Bk, C, M, Y)**
Displays the remaining toner calculated from imaging size.
- **SP3-102-021 to 024 (Toner Remaining: Display: Fill Amount Bk, C, M, Y)**
Display the filler content of new bottle.
- **SP3-120-001 to 004 (TE Sn Detect Thresh: Bk, C, M, Y)**
Sets the starting threshold of the near-toner end detection by the toner end sensor (S18)(S19)(S20)(S21).
- **SP3-121-001 to 004 (TE Counter: Disp: Bk, C, M, Y)**
Displays the number of times the toner end sensor (S18)(S19)(S20)(S21) detected toner end.
- **SP3-122-001 to 004 (TE Sn NE Thresh: Bk, C, M, Y)**
Sets the number of toner end detection to start near-toner end detection.
- **SP3-163-001 (Bottle Drive: Set Rotation Time at Toner End)**
Sets the empty turn time[ms] at almost toner-end.
- **SP3-133-011 to 014 (TE Detect :Set Page Cnt:K, C, M, Y)**
Displays the amount of sheets printed after toner near end is fixed.
- **SP3-133-031 to 034 (TE Detect :Set Pxl Cnt:K, C, M, Y)**
Displays the amount of toner used in cm² after toner near-end is fixed.
- **SP3-210-001 to 004 (TD.Sens:Vt :Disp: Current: K, C, M, Y)**

Displays the latest TD sensor output.

- **SP3-131-001 (Vt TE Thresh: Delta Vt Thresh)**
Specifies the threshold to start adding the delta Vt after toner Near End.
- **SP3-132-001 to 004 (Delta Vt Sum: Bk, C, M, Y)**
Displays the integrated value of delta Vt.
- **SP3-131-011 (Delta Vt Thresh BF NE)**
Specifies the threshold to start integrating delta Vt before toner Near End.
- **SP3-131-012 (Delta Vt Sum Thresh BF NE)**
Specifies the threshold of delta Vt to check Toner End before toner Near End.

Waste Toner

Changes from the Previous Models

Lookup Table

Item	MP C2004/C2504/C3004/C3504/C4504/C5504/ C6004 (Previous Model)	IM C2000/C2500/C3000/C3500/C4500/C5500/ C6000
Waste Toner Bottle	Replaced by service technician	Replaced by user
Waste Toner Bottle Automatic Delivery Service	-	Started the service

Changes

- **Toner Bottle Incompatibility**

The shapes of the bracket on machine and bosses (framed in blue) on the back of the toner bottle prevent the waste toner bottle for the previous model (Met-C2) and similar model (Met-P2) from being installed.

[A]: This Machine, [B]: Previous Model (Met-C2)

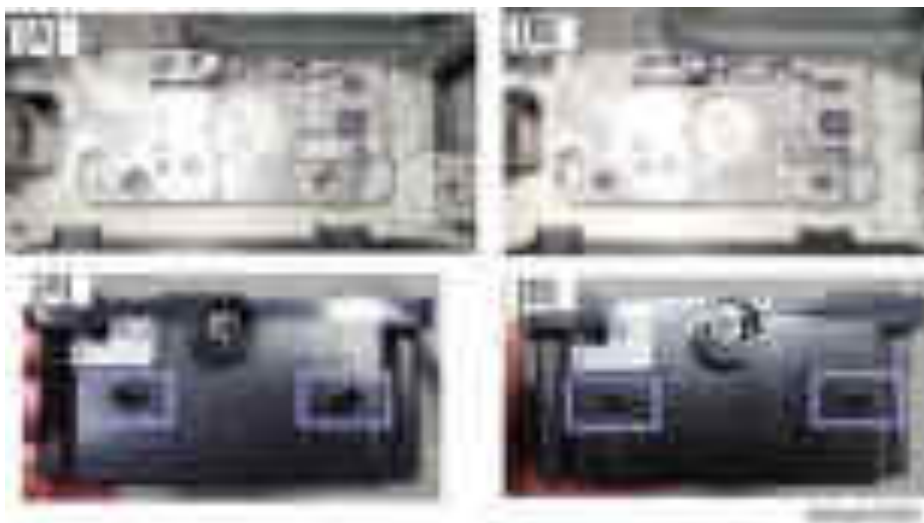

- **Waste Toner Bottle Automatic Delivery Service**

The automatic delivery service will also commence for the waste toner bottle. (The toner bottle delivery service is already in operation.)

The call center will configure the required settings, but the timing of waste toner bottle delivery

(spare kept or not) is configured by the service technician using the following SP.

SP5-507-070 (Supply/CC Alarm: WasteTonerBottle Call Timing)

0	On detecting a new product	Spare kept
1	PM counter 50% full You can check the PM counter in SP7-621 (PM Counter Display).	Spare not kept
2*Default	Value in SP7-956-142 (Estimated Remain Days: Waste Toner Bottle)	Spare not kept

Difference Between Spare Kept and not Kept

	Spare not kept	Spare kept
Overview	Spare waste toner bottle not kept on customer's premises.	Spare waste toner bottle kept on customer's premises at all times after product shipment.
First unit	1 bottle (installed to machine)	1 bottle (installed to machine) Note: It is necessary to order spare waste toner bottle.
Call timing	Set capacity You can change the threshold with SP3-802-001 (Waste Toner Bottle Call:Automatic Ordering Thresh).	On detecting a new unit
Collection	Kept by customer for collection at time of next delivery.	At the time of spare waste toner bottle delivery



To start Toner and Waste Toner Bottle Automatic Delivery Service, the following SPs must be enabled :

- Set SP5-507-006 (Supply/CC Alarm: WasteTonerBottle) to "1 (enable)"
- Set SP5-515-010 (SC/Alarm Setting: Supply Automatic Ordering Call) to "1 (enable)"

A customer support operator remotely connects the client's machine via @Remote and configure required settings. It is not necessary that a service technician changes the SPs on the customer site.

Overview

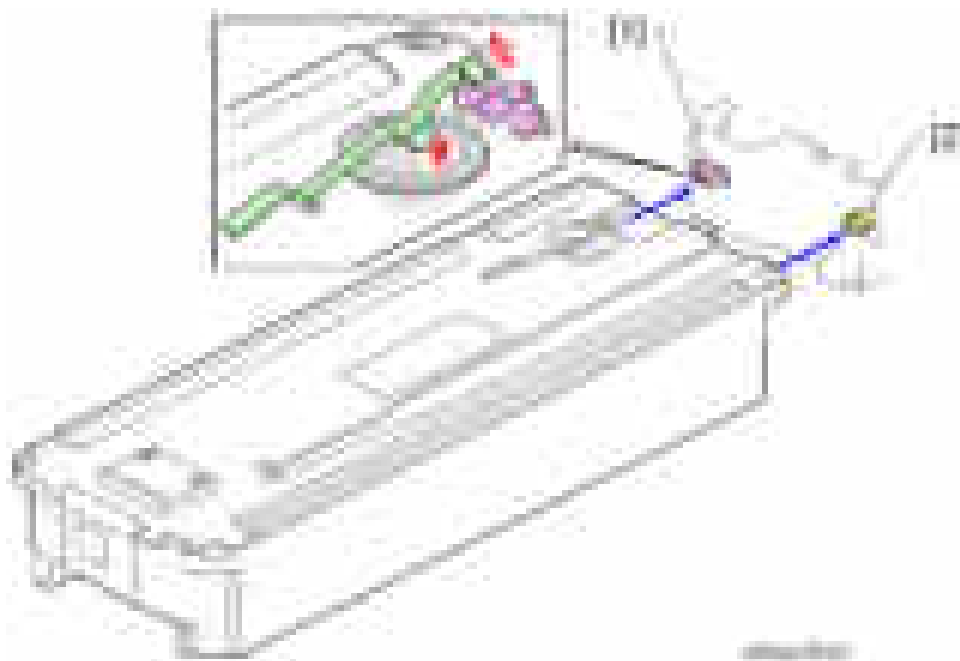

No.	Description	No.	Description
1	Waste toner bottle full sensor (S34)	2	Waste toner bottle set sensor (S35)

Mechanism

Waste Toner Bottle Set Detection

The waste toner bottle set sensor (S35) is at the rear of the waste toner bottle. If the waste toner bottle is not set, this switch is OFF, so imaging is prohibited, and "Waste toner bottle is not set. Please contact the service department." is displayed on the operation panel.

Waste Toner Drive

Driven by the PCU: Black / Image Transfer Motor (M17).

Waste Toner Recovery Path (PCU/Image Transfer Unit)

Waste toner from the PCU and Image transfer unit is collected in the transport path at the front of the machine and arrives at the entrance to the waste toner bottle.

PCU waste toner transport path

Waste toner recovered by the cleaning blade is transported from the rear of the PCU to the transport path at the front of the machine by the waste toner transport coil.

Image transfer unit waste toner transport path

Waste toner recovered by the Image transfer cleaning unit is transported from the rear of the Image transfer cleaning unit to the transport path at the front of the machine by the waste toner transport coil.

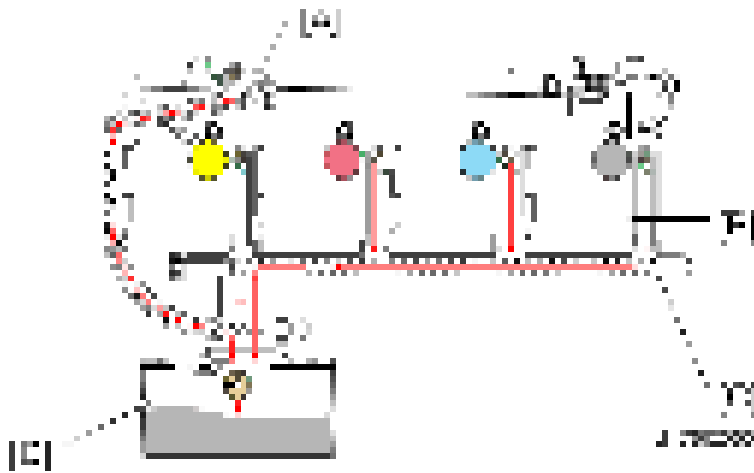

[A]: Image transfer unit waste toner transport path

[B]: PCDU

[C]: PCU waste toner transport path

[D]: Waste toner bottle

Waste Toner Bottle Full Detection

The waste toner bottle full sensor (S34) is at the top of the waste toner bottle. When the waste toner in the bottle has reached approximately 90%, the sensor lifts up a feeler, and an actuator blocks the waste toner bottle full sensor (S34). After sensor detection, the remaining number of days of use is decremented from 18 by the pixel counter.

Full detection flow

- 1.** When waste toner reaches approximately 90% of the bottle capacity, the full sensor switches ON.
- 2.** When the waste capacity sensor switches ON, the days remaining counter is decremented from 18.
- 3.** Days remaining counter: At 15 days to go, a @Remote warning is given (only in models with @Remote connection).
- 4.** Days remaining counter: At 5 days to go, a operation panel message (Replacement of Waste Toner Bottle will soon be necessary. Prepare Waste Toner Bottle replacement.) is displayed. (Nearly full)
- 5.** Days remaining counter: At 0 days to go, a operation panel warning is displayed, and the machine stops.



- After the full sensor switches ON, before nearly full, if the waste toner bottle full sensor (S34) has been switched OFF, it is determined that the waste toner bottle has not been replaced, and countdown of the days remaining counter continues.
- The days remaining counter starts computing when a new bottle is detected and displays the days remaining, whose upper limit is 255 and the lower limit is 18 until the waste toner bottle full sensor (S34) is first switched ON.
- After the full sensor was first switched ON, the days remaining which is computed from when the sensor switched ON is displayed (upper limit is 18).

7.Detailed Descriptions

- When the bottle is replaced before the machine detects a full waste toner bottle and stops printing, it is necessary to reset PM counters manually (SP3-701-142).
- When the bottle is replaced after the machine stopped due to detecting a full waste toner bottle, it is not necessary to reset PM counters. If the counters are reset, the replace counter will count up twice.

Image Transfer and Paper Transfer

Changes from the Previous Models

Lookup Table

Item	MP C2004/C2504/C3004/C3504/C4504/C5504/C6004(Previous Model)	IM C2000/C2500/C3000/C3500/C4500/C5500/C6000
Removing the image transfer belt unit	Removing the ITB front cover is required (x2)	No ITB front cover

Changes

- **Removing the image transfer belt unit**

In the previous machine [B], the front side of the image transfer belt unit was fixed with the front cover(x2).

In this machine [A], removing the image transfer belt unit is the same as those for the user maintenance model Met-P2 (using lock lever, no front cover).

You can directly access the ITB lock lever [A] and the ITB contact/separation lever [2].

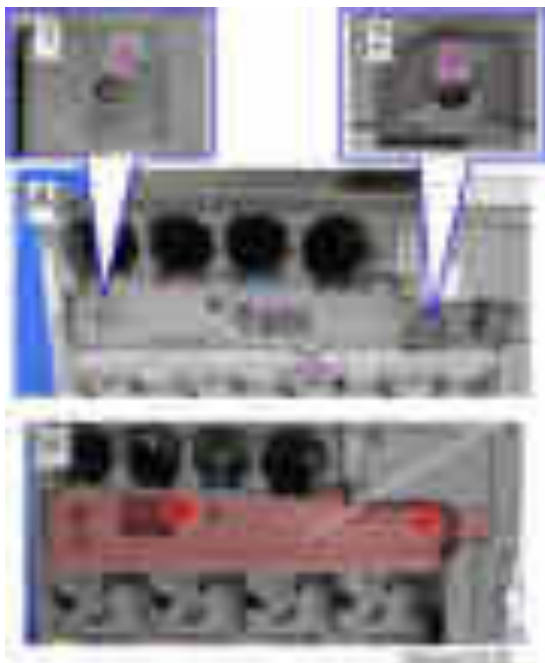

- **Image Transfer Unit (Image transfer belt unit + Image transfer cleaning unit)**

As service products, the image transfer belt unit and image transfer cleaning unit are now available as a set in the form of the image transfer unit.

This features the new unit detection mechanism, so it is unnecessary to set the SP (SP3-701) to enable new unit detection (set to 1).

7.Detailed Descriptions

When the image transfer unit is replaced, the counters of the image transfer belt unit and image transfer cleaning unit are reset.

Overview

Image Transfer Unit

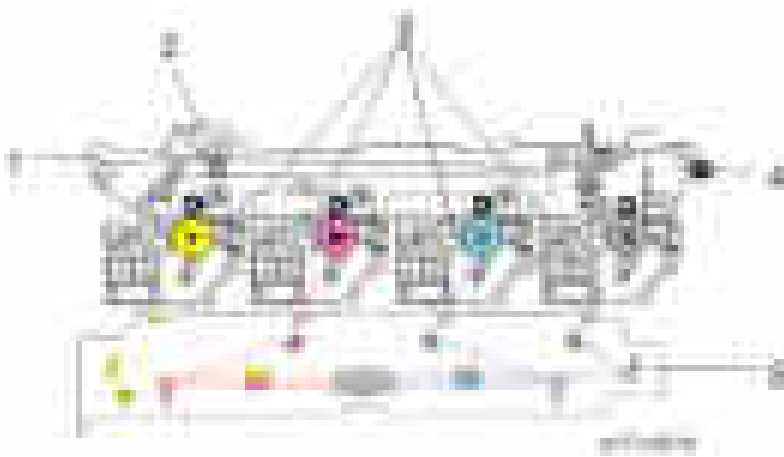

No.	Description	No.	Description
1	Image Transfer Belt Unit	4	Paper Transfer Roller
2	Image Transfer Cleaning Unit	5	Laser Unit
3	PCDU	-	-

Paper Transfer Unit

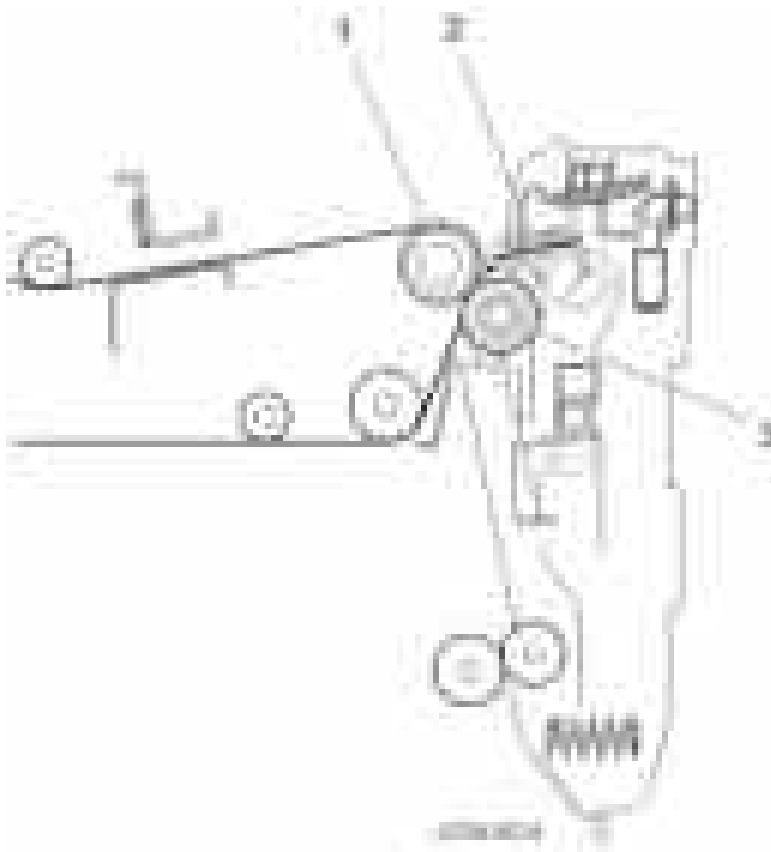

No.	Description	No.	Description
1	Image Transfer Drive Roller	3	Paper Transfer Roller
2	Discharge plate	-	-

Image Transfer Unit Mechanism

Drive Mechanism

The Image transfer belt [A] is driven by the "PCU: Black / Image Transfer Motor (M17) [C]" via the gear and the image transfer drive roller [B].

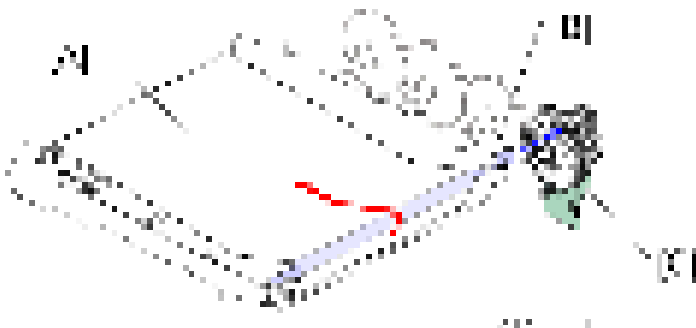

Transfer Bias

The bias to the Image transfer belt [A] is applied to the image transfer roller [B] of each color from the

7.Detailed Descriptions

transfer power pack.



The 5 springs, in order from the right (double-side unit), consist of "C (cyan), secondary transfer, BK (black), Y (yellow) and M (magenta)" transfer bias terminals.

ITB Contact and Release

To prevent early deterioration of the OPC drum, the image transfer belt unit is provided with a contact/separation mechanism and, during monochrome printing, separation of the image transfer belt from the OPC drum is controlled. Contact/separation of the image transfer belt unit is performed via a gear from an ITB contact and release motor (also used as a magenta toner supply motor). Separation or contact is detected by the ITB contact and release sensor (S32).

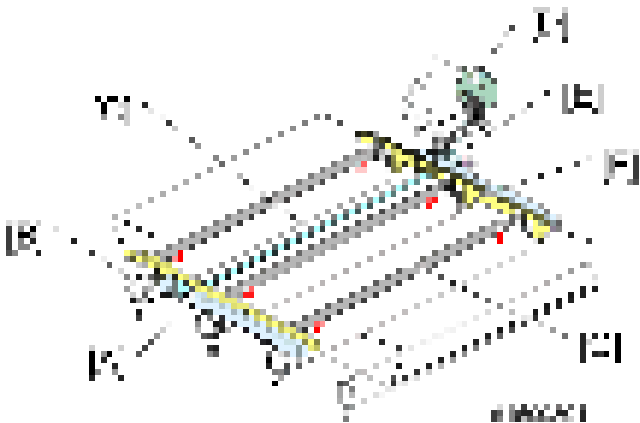

[A]: Slider

[B]: Drum

[C]: Contact and Release Cam

[D]: ITB contact and release motor (also used as a magenta toner supply motor)

[E]: ITB contact and release sensor (S32)

[F]: Guide

[G]: Image Transfer Roller

Image Transfer Belt Drive Control

FG Control is performed (Frequency Generator control: ensures precision of motor operation)

Image Transfer Order

By arranging the imaging sequence in the order Y > M > C > Bk, cyan is laid on top of magenta, which increases tolerance to image blurring and image reddening when dark blue is output and improves image quality.

Image Transfer Belt Cleaning Mechanism

Image transfer cleaning is performed by a cleaning blade (counter method).

Due to the downsizing of machine width, the image transfer cleaning unit is installed on top of the Image transfer belt unit. Therefore, to replace the image transfer cleaning unit, the replacement must be performed after taking out the image transfer belt unit and inverting it.

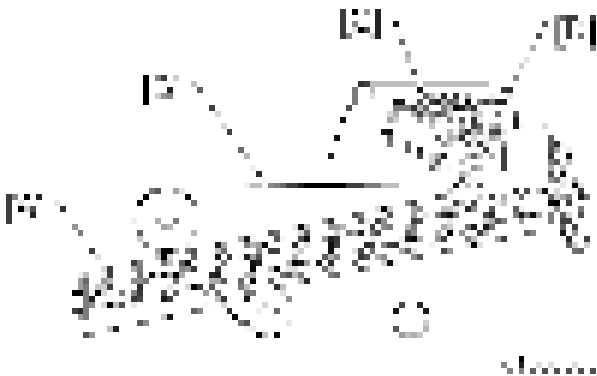

[A]: Waste toner transport coil

[B]: Image transfer belt

[C]: Image transfer cleaning blade

[D]: Waste toner transport coil

Paper Transfer Unit Mechanism

Paper Transfer Mechanism

A bias is applied to the image transfer drive roller to transfer the image on the Image transfer belt to the paper (repulsion transfer). As there is no paper between the Image transfer roller and toner image, this method is not easily affected by paper conditioning.

Also, toner adsorption on the paper is facilitated by the discharge plate of the Paper Transfer unit (no charge is applied).

PTR (Paper Transfer Roller) Drive

The rotation of the paper transfer roller follows that of the image transfer drive roller.

7.Detailed Descriptions

PTR (Paper Transfer Roller) Contact and Separation

If the paper transfer roller is permanently in contact with the image transfer belt, the toner on the image transfer belt moves to the roller and soils the underside of the paper surface, therefore the paper transfer roller is separated during Process Control or MUSIC control (it is not separated during real-time process control).

Separation of the paper transfer roller is achieved by transmitting the drive of the paper transfer contact and release motor (M18) via the ITB unit joint.

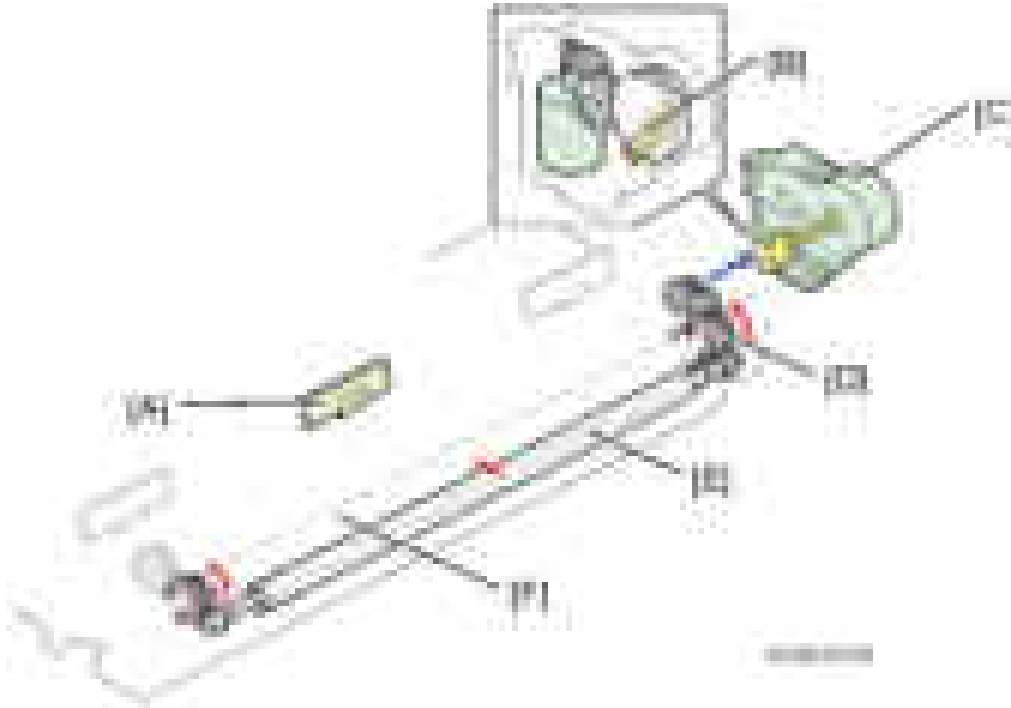

[A]: TM/ID sensor (center)

[B]: Paper transfer roller Home Position sensor

[C]: Paper transfer contact and release motor (M18)

[D]: Cam

[E]: Paper transfer roller

[F]: Image transfer drive roller

Separation

To achieve paper separation, a curvature separation method which separates the paper transfer roller and image transfer belt is employed.

TM/ID sensor

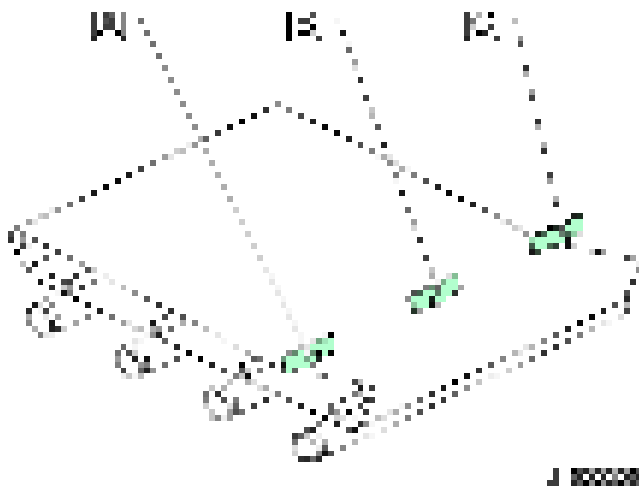

[A]: TM/ID sensor (front)

[B]: TM/ID sensor (center)

[C]: TM/ID sensor (rear)

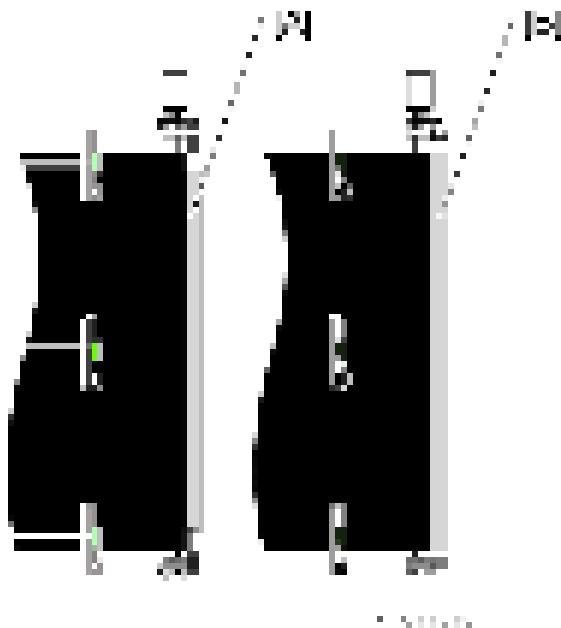

[A]: Paper transfer roller (standard roller)

[B]: Paper transfer roller (Imageable Area Extension Unit)

When Imageable Area Extension Unit (316mm) is equipped, 316mm width printing is done instead of Real Time Process Control at margin.

Paper Feed / Transport

Changes from the Previous Models

Bypass Tray Assist Function

Many cases of JAM 48 (paper not been fed from the bypass tray) occurred due to paper size missetting. Also, the call center received many inquiries about the bypass tray.

To simplify the bypass tray setting, the bypass tray assist function has been added (to reduce missetting).

Function Overview

1. Changes to the User Interface (UI)

Displaying the paper setting each time paper is loaded in the bypass tray.

The paper size and thickness are determined according to the automatic detection result and displayed.

It is possible to switch to the bypass tray setting by pressing the [Change the Setting] button.



2. The paper size (width) configured for the printer driver and the width of the paper guides on the bypass tray is checked and if the paper size does not match, paper size mismatch notification is displayed (and the print job stops).

3. Delivery If the Paper Size Setting is Mismatched (Copier and Print Job)

On this machine, if the paper size setting is mismatched, instead of the paper jam (job stop), the paper feed/transport control is switched to the detected paper size in the bypass tray and exit the paper to the output tray.

The message appears to confirm the bypass paper settings after the job finished.

An SP item to allow the user to switch on/off this setting and an SP to count the number of papers delivered with paper size mismatch have been added.

SP No.	Paper Delivery	Recovery Printing
SP1-007-002	By-Pass Size Detection: By-Pass Jam Detection Set	Switching on/off paper delivery control

SP No.	Paper Delivery	Recovery Printing
		<p>0: Normal Detection Paper not delivered in case of a paper size mismatch between the specified and fed paper.</p> <p>1: Simple Detection Paper not delivered if the paper fed is longer than the specified paper size.</p> <p>2: Size Miss Paper Ejection Paper can be delivered even if the paper fed is longer or shorter than the specified paper size.</p>
SP1-012-001	Size Miss Paper Ejection Count	Counts the number of papers delivered with the paper size mismatch.

If the paper delivery setting is set to 2 (Size Miss Paper Ejection) and the bypass tray paper size setting and the size of the delivered paper are mismatched, the paper size notification message appears on the operation panel after paper delivery.

Job Type	Paper Delivery	Recovery Printing
One sheet of single side printing	Delivered	No Displays the paper size notification message.
Other than one sheet of single side printing	Not delivered	Yes

Example:

Actual paper	A3 SEF	Paper is delivered. In the previous model, the paper was jammed and the delivery was stopped.
Specified paper setting	A4 LEF (auto detection)	

Bypass Tray Paper Size Detection System

The configuration and mechanism of the bypass tray have been modified to automatically detect the thickness and size of the paper loaded in the bypass tray with high accuracy.

Changes to Bypass Width Sensor (S8)

The sensor has been changed to one with higher accuracy to increase the size of paper that can be detected. It has become necessary to execute calibration when replacing the sensor to maintain the accuracy. For the calibration procedure, see Chapter 4, "Replacement and Adjustment".

7.Detailed Descriptions

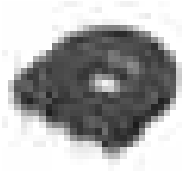
	Previous Model	This Model
Sensor Type	Rotary switch 	Rotary position sensor 
Detection method	Detection at 9 areas	Linear position detection
Accuracy	Lower than the present model	±7.1 - 11.0 mm

Bypass Tray Paper Size Detection

In the previous model, the paper size was detected in 9 areas, but in this machine, the paper size is detected by the rotary position sensor that accurately detects the position of the side fences.

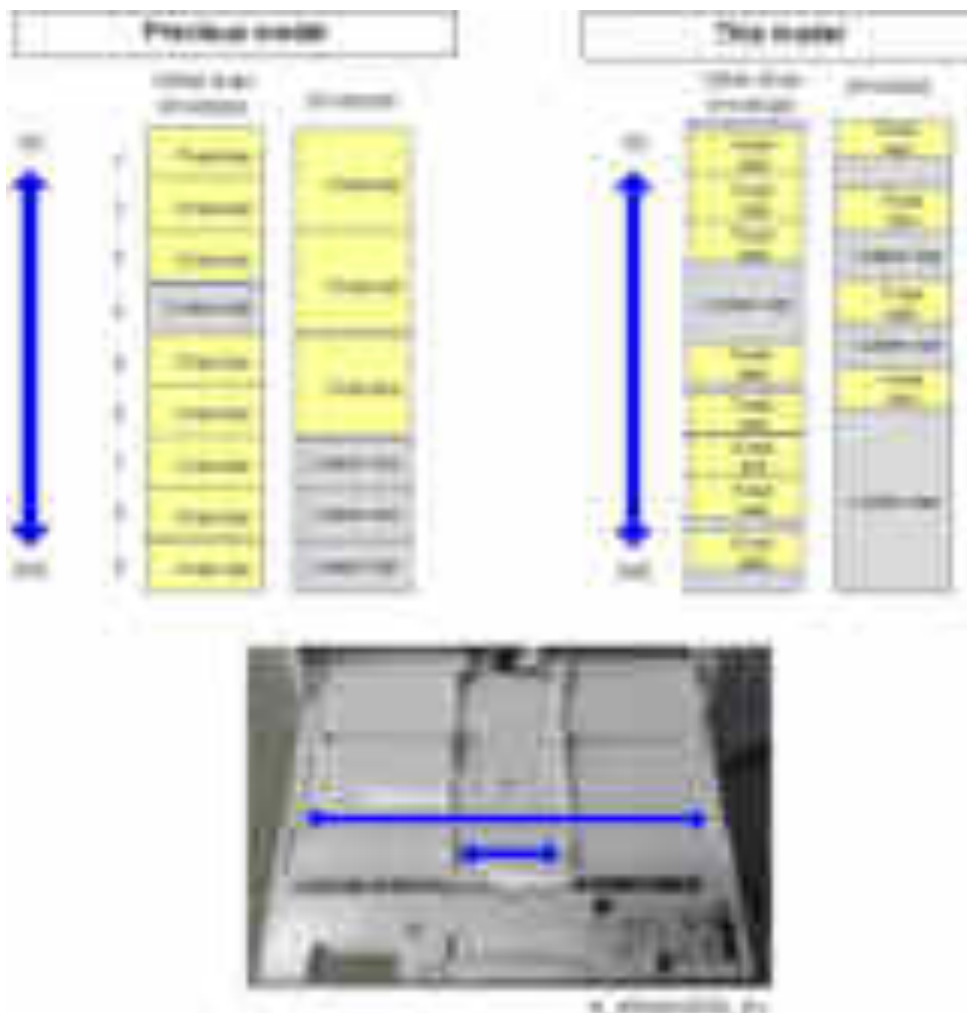

Switching On/Off the Bypass Pick-Up Solenoid

When using thin paper, JAM 8 may occur because of the bypass tray paper stopper [A] failing to return

to its original position, causing the leading edge of the paper to be damaged when loading paper.



This machine has a function to de-energize the bypass-pick-up solenoid (SOL1) [A] and then reenergize it to operate the bypass pick-up roller [B] at the end of each print job to help the paper return to its original position.



There is an additional SP to enable/disable this function.

SP1-014-001 (Job End By-Pass Pick Up SOL Op: SOL Operation ON-OFF Switch)

0: OFF The solenoid does not operate.

1: ON The solenoid operates.

Paper Feed Unit / Paper Feed Tray

Mechanism to Secure Side Fences

This machine has screws to secure the side fences on the interior of each paper feed tray (Trays 1 to 4).

7.Detailed Descriptions



Remove the securing screws from the interior and apply them to the securing spots on the side fences.



Mechanism to Secure End Fence

This machine has a fixing unit [A] to secure the end fence of each paper feed tray (Trays 2 to 4).



Paper jamming and related SCs due to not setting the end fence properly are prevented by securing the end fence.

The end fence can be moved to give approximately 2 mm gap so that the paper can be loaded easily even if the end fence is secured.



Note: The securing screw can also be turned with the fingers or a coin.

Upper Limit Decals on Side Fences (Tray 1 / Tray 2)

In the previous model [A] only the rear side fence had a decal on it to indicate the upper limit of stacked sheets of paper, but this machine [B] has an additional decal on the front side fence.

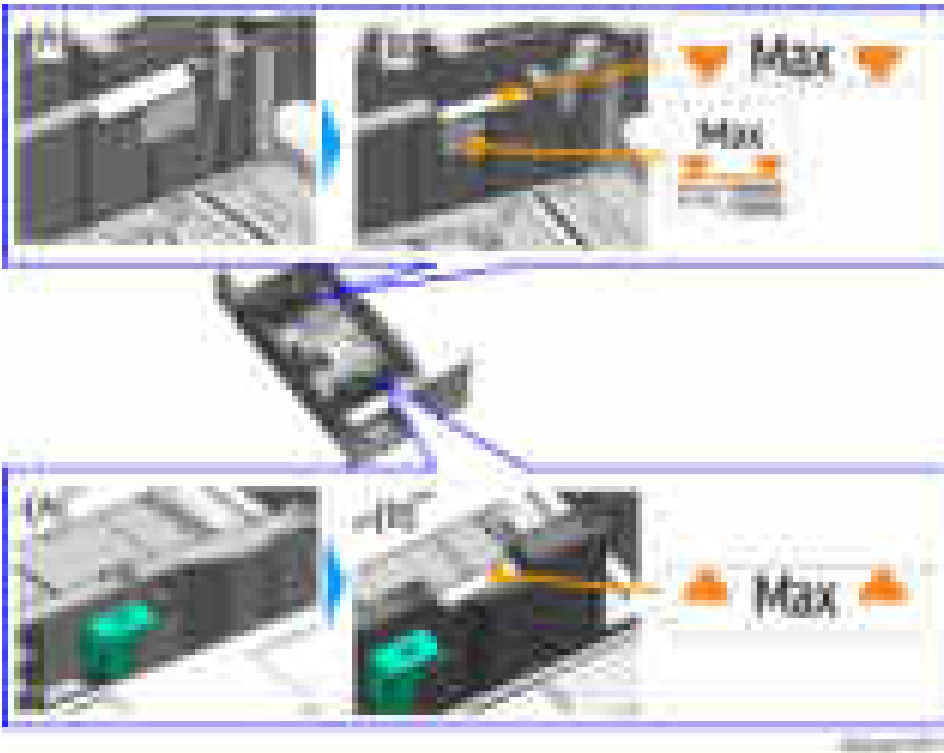

Paper Jam Detection

Displaying the Alert for Paper Mismatch

In this machine, if a paper jam occurs due to paper size setting mismatch, in addition to the paper jam notification, a separate message prompts the user to check the paper setting shown.

By notifying the user to specify the paper setting correctly, it helps to prevent the repeated paper jams.

Whether to display the message can be specified in the following SPs.

7.Detailed Descriptions

SP No.	Name	Description
SP1-010-001	Size Set Miss Detection Mode: Paper Length Detection	Specifies whether or not to display the message when a paper length mismatch is detected.
SP1-010-002	Size Set Miss Detection Mode: Small Size Miss Set Detection	Specifies whether or not to display the message when a small-size paper less than the specified length (less than 170 mm) is detected.
SP1-011-001	Size Set Miss Detection Count: Paper Length Detection	Counts the number of paper length mismatch detections.
SP1-011-002	Size Set Miss Detection Count: Small Size Miss Set Detection	Counts the number of small-size paper mismatch detections.

Overview

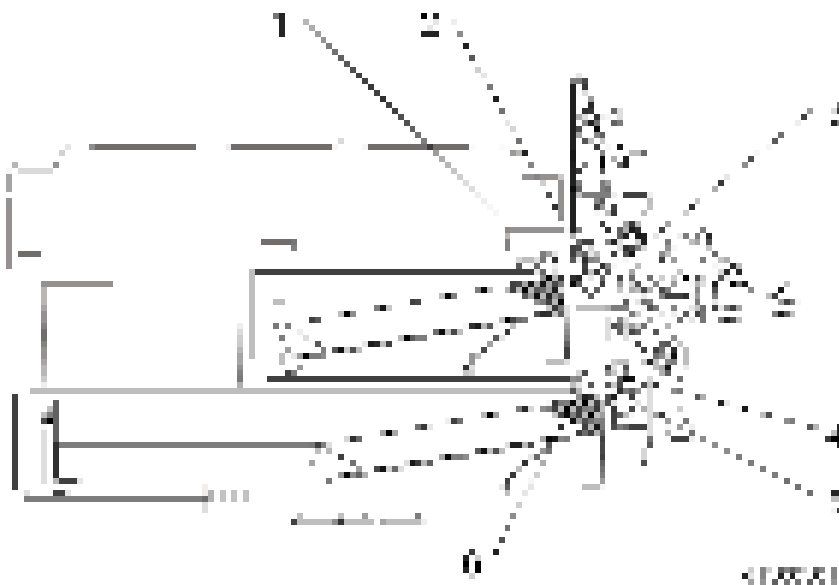

No.	Description	No.	Description
1	Pick-up roller (1st paper tray)	4	Paper feed roller (2nd paper tray)
2	Paper feed roller (1st paper tray)	5	Friction roller (2nd paper tray)
3	Friction roller (1st paper tray)	6	Pick-up roller (2nd paper tray)

In this machine, an RF paper feed system is employed, and the paper feed roller, friction roller, and pick-up roller are highly durable rollers.

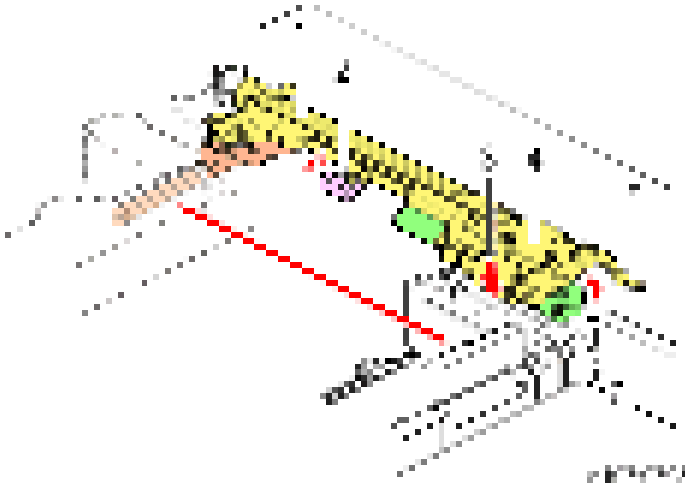

No.	Description	No.	Description
1	Pick-up arm	4	Paper feed roller
2	Upper limit sensor	5	Feed guide
3	Pick-up roller	6	Friction roller

Feed / Transport

The paper feed tray consists of 2 stages, i.e., a main double tray and a bypass feed tray. By using the 1st tray as a fixed tray, and the 2nd tray as a universal tray, a space-saving two-step feed is enabled.

Tray	Paper size	Loading number of sheets	Corresponding paper thickness
1st paper tray	A4 landscape - A5 landscape	550 sheets	60 to 300g/m ²
2nd paper tray	SRA3 - postcard	550 sheets	60 to 300g/m ²
By-pass feed tray	SRA3 - postcard	100 sheets	60 to 300g/m ²
Duplex unit	SRA3 - A6 portrait	Interleave	60 to 256g/m ²

Tray Base Plate Lift

When the paper feed tray is set in the machine, the set switch at the rear of the tray switches ON, and it is detected that the tray is set.

The coupling [2] between the shaft [3] at the rear of the tray and the lift motor (M9) (M10) [1] then engages, the motor rotates, and the tray base plate [4] is lifted.

7.Detailed Descriptions

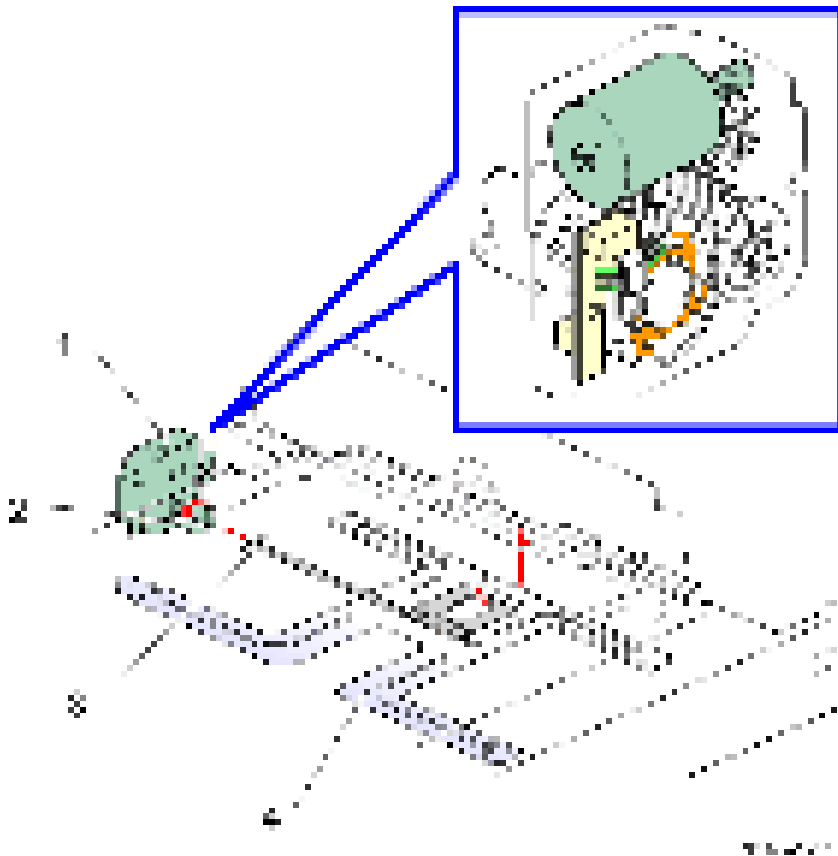

The tray base plate lifts until the paper surface pushes the pick-up roller up [5], the upper limit sensor (S15) (S25) [6] switches OFF (interrupt), and the machine enters paper feed standby mode.

When the tray is removed, the coupling is released, and the base plate moves down. The lift motor then rotates until the coupling returns to the home position.

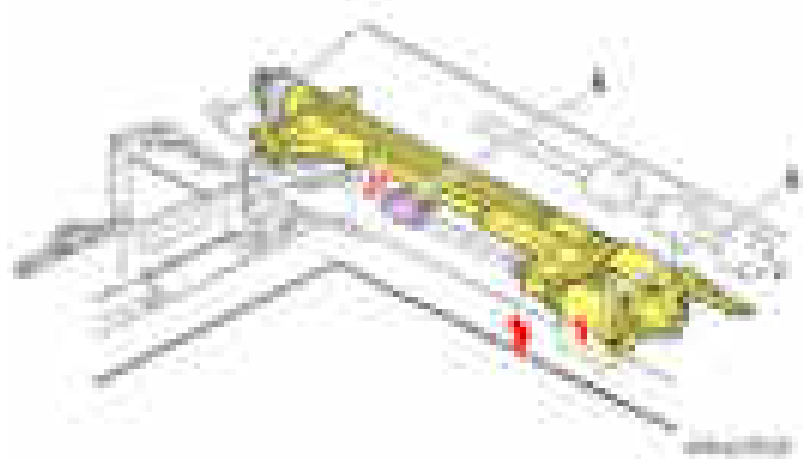

Paper Feed Mechanism

The paper feed unit employs an RF system.

In a conventional FRR system, transport of 2 sheets at a time is prevented by reverse rotation of the separation roller, but in the RF system, paper separation is assisted by the resistance of the separation

roller with a torque limiter (reverse drive is not performed).

When the paper feed tray is set in the machine, a pressure release lever [1] is pressed, the friction roller [2] comes in contact with the paper feed roller, and the pick-up roller [3] contacts the top of the paper (to prevent paper remaining, when the paper feed tray is withdrawn, the pressure release lever returns and contact with the rollers is released).

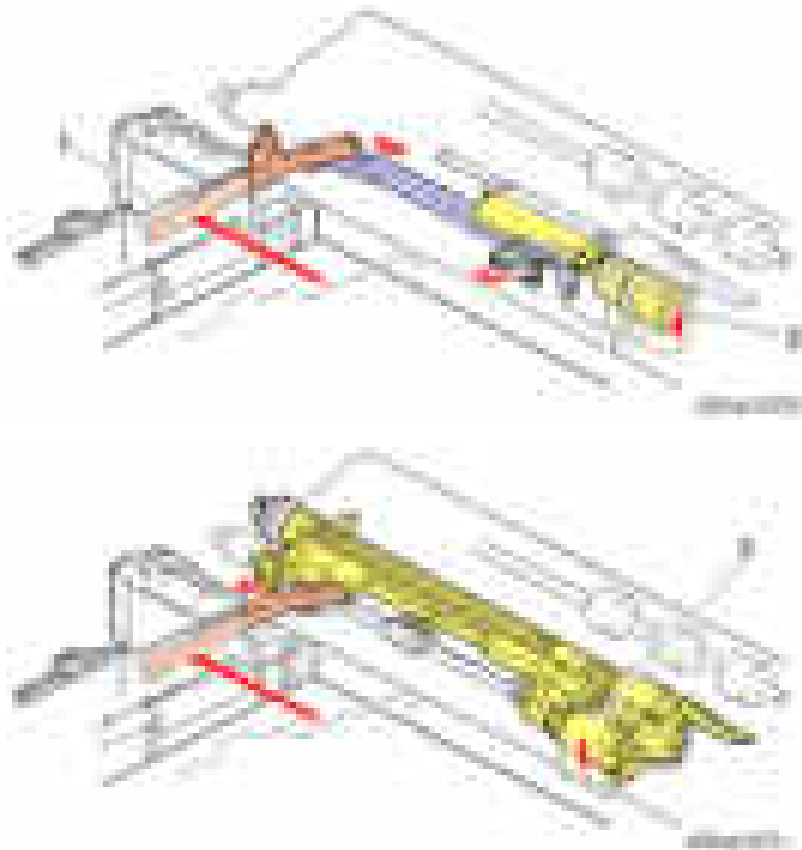

The machine is in standby mode for paper feeding when the tray bottom plate moves up. When the paper feed motor (M6) turns ON, the rollers start to rotate and paper is fed.

The feed guide functions as a paper guide and roller clip ring. The feed guide prevents the paper from winding up.

Paper Feed Transport Mechanism

In this machine, to maintain the paper gap constant, the paper feed sensor (S12) (S22) [A] near the paper feed roller adjusts the paper feed timing.

- 1.** The paper feed motor (M6) is switched ON, and the first sheet is supplied.
- 2.** Just before the rear edge of the first sheet leaves the paper feed roller [B], the paper feed motor (M6) switches OFF.

At this time, if the paper feed sensor (S12) (S22) [A] detects "Paper Out" (if a second sheet has not been transported to the paper feed sensor position), the paper feed motor (M6) does not switch OFF, and pre-feed is performed. Pre-feed is as follows:

1. The second sheet is transported to the paper feed sensor position.

7.Detailed Descriptions

2. When the rear edge of the second sheet passes the paper feed roller [B], the paper feed motor (M6) switches OFF.

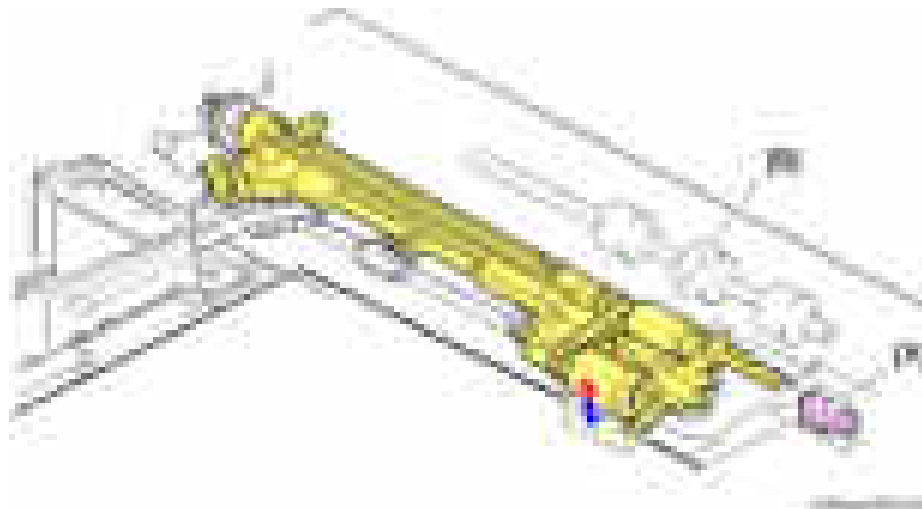

3. When the first sheet is transported a predetermined distance by the downstream transport roller, the paper feed motor (M6) switches ON to supply the second sheet of paper.

Paper Size Detection (1st Paper Tray)

Size cannot be detected only with set detection.

- 1st tray settings:
A4 LEF, LT LEF, B5 LEF, and A5 LEF (select with UP mode, default is A4 LEF)

Paper Size Detection (2nd Paper Tray)

The end fence interlocking rotation detection plate is an automatic detection system which recognizes patterns by a 4-position push switch.

Size is detected by the detection patterns of knobs 1, 2, 3, and 4. Tray set is detected by another switch.

If there has been a change in the pattern, "MFP tray automatic size detection" control is performed continuously.

If the paper size is selected manually by user setting, the automatic size detection is overridden.

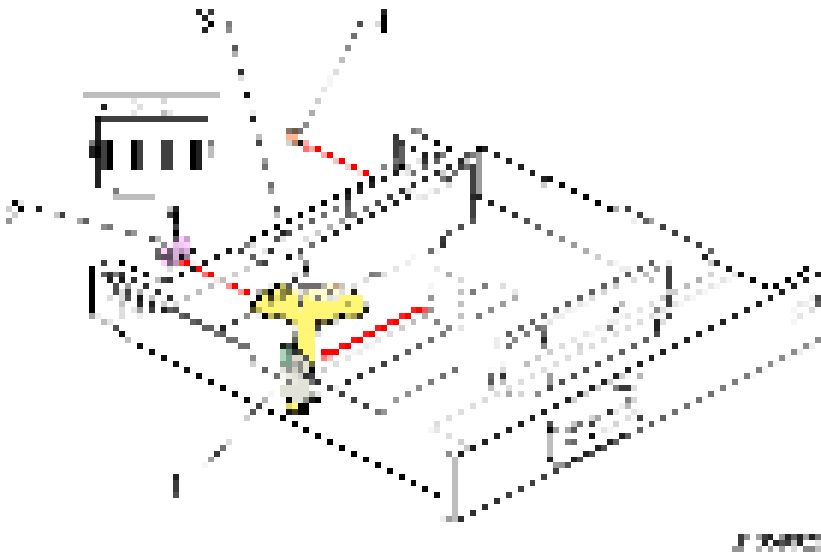

No.	Description	No.	Description
1	End fence	3	Size detection actuator
2	Size switch	4	Tray set switch

- 2nd tray detection sizes:
SRA3, A3, B4, A4 SEF, LT SEF, B5 SEF, A4 LEF, B5 LEF, and A5 LEF
- 2nd tray size detection patterns

Size	Knob			
	4	3	2	1
SRA3(12"×18")	1	0	1	0
A3(DLT)	0	1	0	0
B4(LG)	0	0	1	1
	0	1	1	1
A4 portrait	1	1	1	0
LT portrait	1	1	0	0
B5 portrait	1	0	0	0
A4 landscape(LT landscape)	0	0	0	1
B5 landscape(Exe landscape)	0	0	1	0
A5 landscape	0	1	0	1

* "0" is switch ON (PUSH), "1" is switch OFF.

* The figures in parentheses are automatic detection sizes which can be switched over in SP mode (for SP settings, see "SP mode (paper supply transport)": SP5-181-002 to 006).

* SRA3=320×450mm(12.6"×17.7")

* Exe LEF=10.5"×7.25"

* If a pattern other than the above is detected, a blank is displayed on the operation panel.

Remaining Paper Detection

When the lift motor (M9) (M10) rotates, the remaining paper sensors 1, 2 [A] built into the motor switch

7.Detailed Descriptions

ON (unblocked) or OFF (blocked). Paper remaining in the paper feed tray is detected by the combination of ON/OFF for the two sensors.

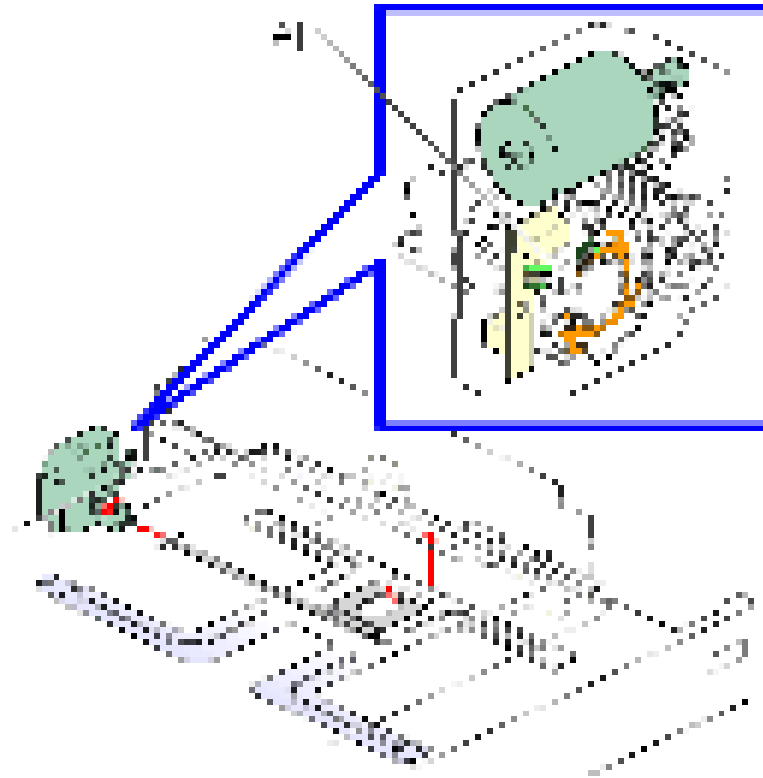

There are the following 4 remaining paper detection levels:

Remaining paper status	100%	70%	30%	10%
Remaining paper status sensor 1	ON	OFF	OFF	ON
Remaining paper status sensor 2	ON	ON	OFF	OFF
Control panel remaining paper display	Bar 4	Bar 3	Bar 2	Bar 1

Paper End Detection

When there is no more paper in the paper feed tray, the leading edge of the paper end feeler [2] falls into a notch [3] in the base plate, and the paper end sensor (S14) (S24) [1] at the rear edge of the end filler switches ON (pass).

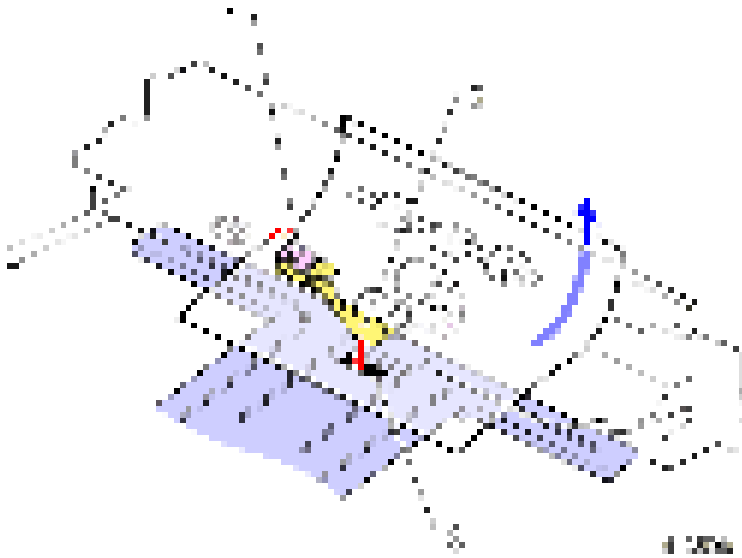

Paper Supply Drive

The 1st/2nd pick-up rollers and 1st/2nd paper feed rollers are driven by the paper feed motor (M6). The 1st/2nd transport rollers are driven by the transport motor (M5).

The bypass transport roller is driven by the Bypass/Duplex motor, and the registration roller is driven by the registration motor (M7).

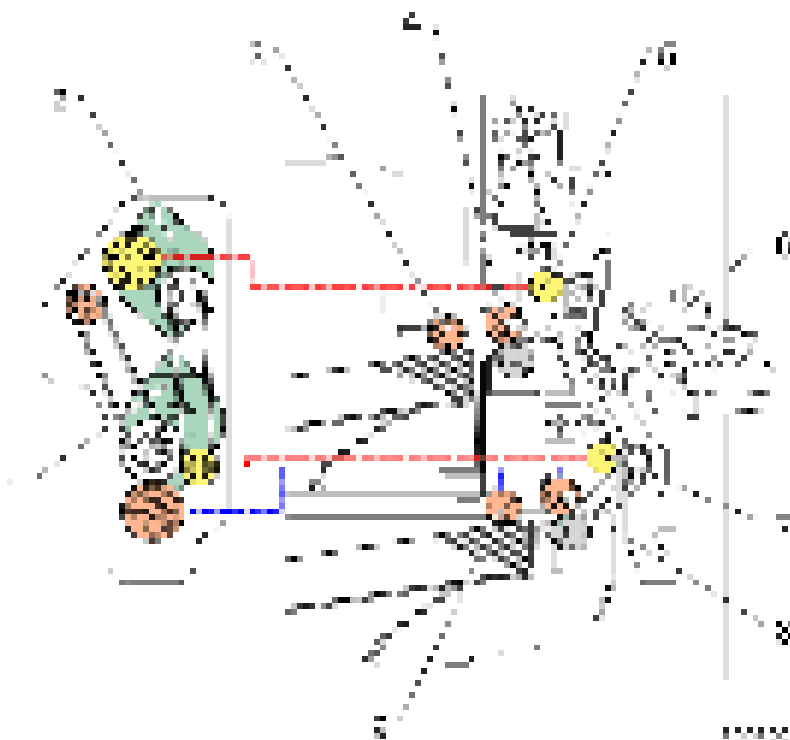

No.	Description	No.	Description
1	Paper feed motor (M6)	6	By-pass transport roller
2	Transport motor (M5)	7	Transport roller (2nd tray)
3	Pick-up roller (1st tray)	8	Paper feed roller (2nd tray)

7.Detailed Descriptions

No.	Description	No.	Description
4	Paper feed roller (1st tray)	9	Pick-up roller (2nd tray)
5	Transport roller (1st tray)	-	-

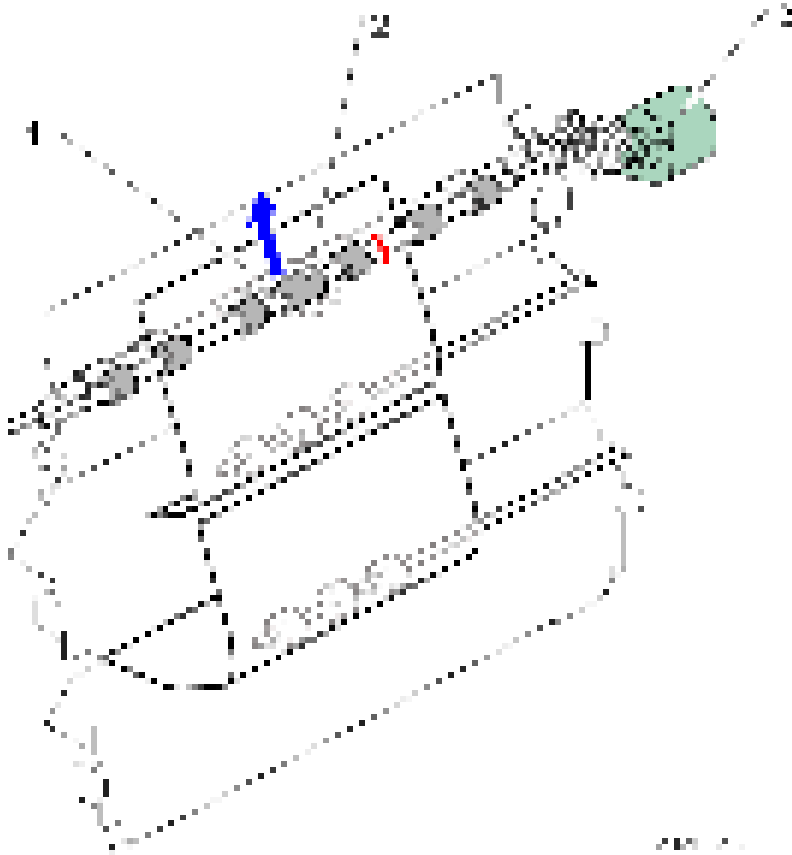

No.	Description	No.	Description
1	Registration roller(Driven)	3	Registration motor (M7)
2	Registration roller(Drive)	-	-

Paper Dust Removal Mechanism

The registration mechanism removes paper scraps using the paper removal Mylar in contact with the driven roller (resin). Paper scraps removed by the paper removal Mylar are collected in the paper dust container.

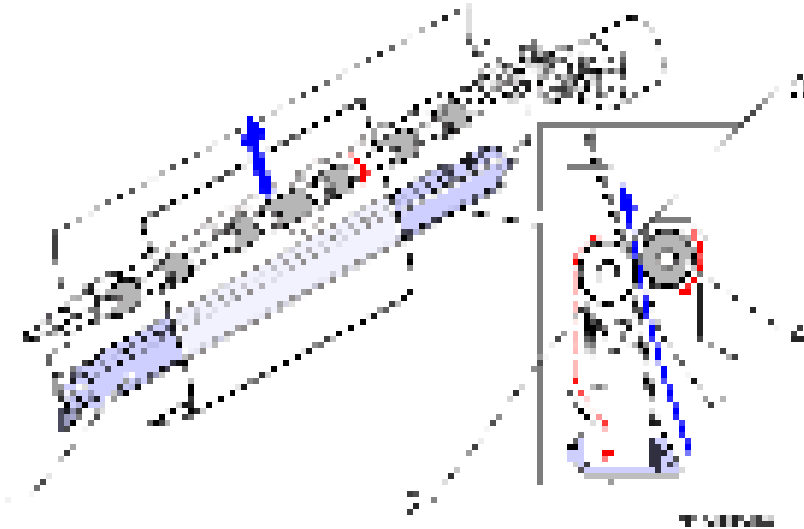

No.	Description	No.	Description
1	Paper dust container	3	Registration roller (Driven)
2	Paper dust removal Mylar	4	Registration roller (Drive)

Tray Draw-in Mechanism

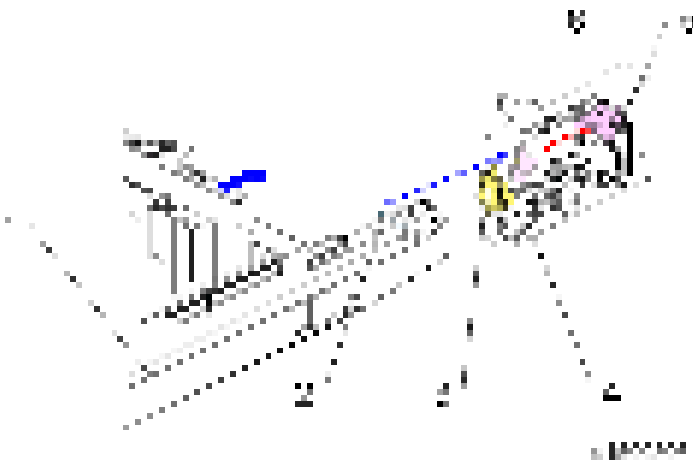

No.	Part name	No.	Part name
1	Paper Feed Tray	4	One-way Clutch
2	Draw-in pin	5	Draw-in lever
3	Oil Damper	6	Tray draw-in unit

To enhance operability, a tray draw-in mechanism is used.

The tray is drawn in by a one-way clutch in the draw-in unit. To draw the tray out, an oil damper is released.

7.Detailed Descriptions



The pin [A] of the paper supply tray is drawn in by the tray draw-in unit [B].

[A]: Paper supply tray pin

[B]: Tray draw-in unit

[C]: One-way clutch

[D]: Tray draw-in part

[E]: Oil damper

Bypass Feed

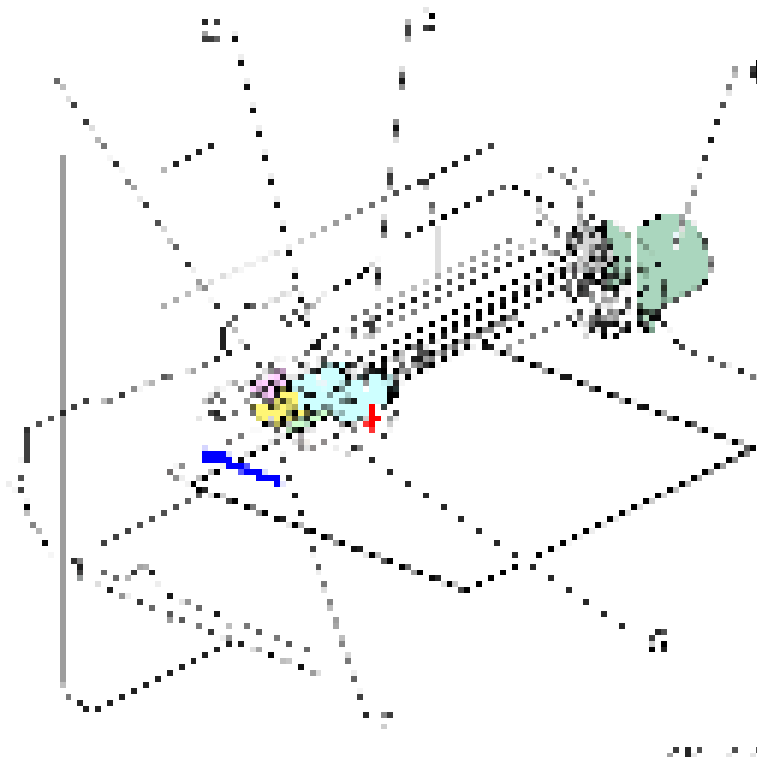

No.	Description	No.	Description
1	Bypass paper end sensor (S6)	4	Bypass/Duplex motor
2	Bypass paper feed roller	5	Bypass/ Reverse roller
3	Bypass pick-up roller	6	Paper detection filler

Bypass Feed Paper/Separation Mechanism

The bypass paper feed mechanism employs an FRR system. The bypass paper feed unit comprises a paper feed roller, reverse roller and pick-up roller.

When the paper feed tray is selected and the machine is started, the bypass pick-up solenoid (SOL1) is switched OFF, and paper is supplied by the bypass/duplex motor (M2) (CCW).

In standby mode, the bypass pick-up roller is not in contact with the paper surface. This is opposite to the paper feed tray.

Bypass Feed Paper Size Detection

Paper size width detection is performed by the bypass width sensor (S8) (rotary position sensor) [1].

The bypass width sensor (S8) has a rotation plate which rotates together with the side fence of the bypass feed table, and detects the paper size.

Paper portrait/landscape is determined by the length sensor [2].

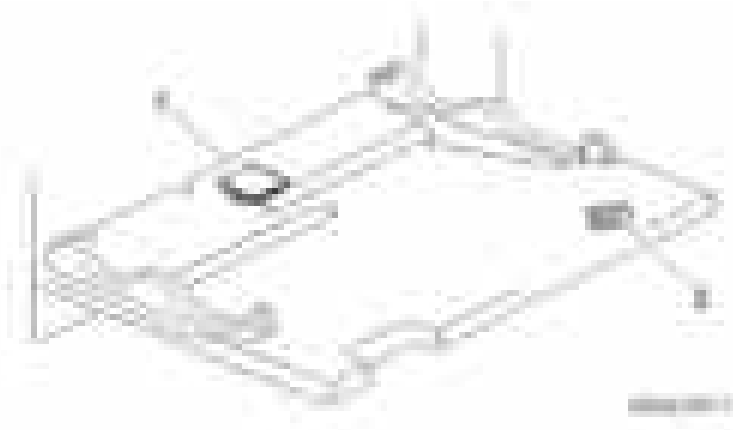

Two feelers [A] for the bypass paper length sensor [B] are added to the rear of the tray to prevent false detection of paper length caused by floating at the rear of paper when long paper is set without pulling out the bypass tray extension.

7.Detailed Descriptions

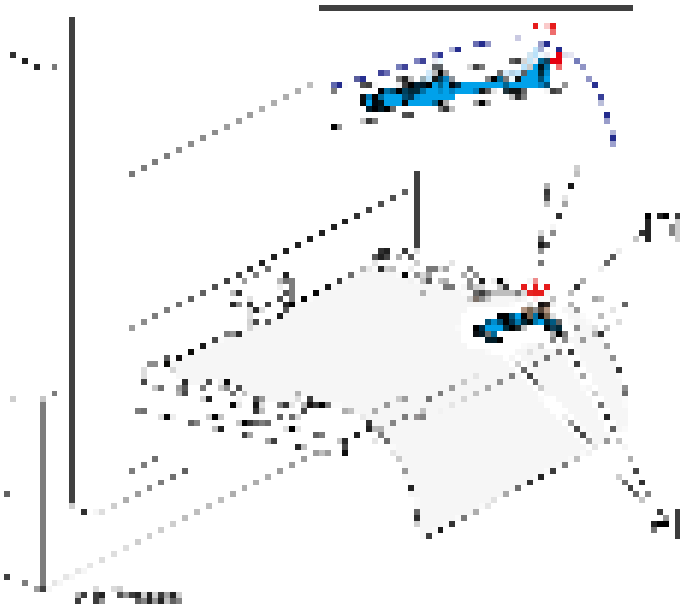

Bypass Feed Paper End Detection

To detect bypass feed paper end, a paper detection feeler and bypass paper end sensor (S6) are provided.

When the paper is set, the bypass paper end sensor (S6) switches ON (interrupt), and paper set is detected.

When there is no more paper, the detection feeler falls into a hole in the bypass feed table, the bypass paper end sensor (S6) switches OFF (pass), and paper end is detected.

Bypass Paper Feeder Drive

The bypass paper feed roller, bypass/ Reverse roller, and bypass pick-up roller are driven by the duplex/bypass feed motor.

 Duplex



No.	Description	No.	Description
1	Reverse sensor (S9)	7	Duplex exit roller
2	Duplex entrance roller 1	8	Duplex Exit Sensor (S3)
3	Duplex entrance sensor (S5)	9	Registration roller
4	Duplex entrance roller 2	10	Paper exit junction gate
5	Duplex transport roller 1	11	Reverse roller
6	Duplex transport roller 2	-	-

 Transport Inversion Mechanism

The paper passes through the paper exit junction gate [4], and is transported to the duplex unit past the reverse sensor (S9) [2] and reverse roller [3].

7.Detailed Descriptions

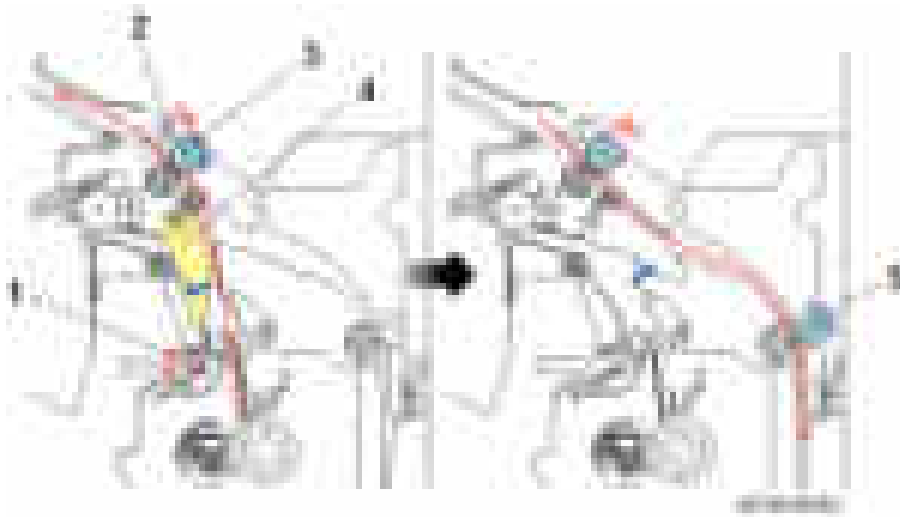

No.	Description	No.	Description
1	Fusing exit sensor (S27)	4	Paper exit junction gate
2	Reverse sensor (S9)	5	Duplex entrance roller 1
3	Reverse roller	-	-

Duplex Drive

The rollers are driven by the following motors:

No.	Rollers	Drive sources
1	Reverse roller	Reverse motor (M3)
2	Duplex entrance roller 1	Duplex entrance motor (M1)
3	Duplex entrance roller 2	
4	Duplex transport roller 1	Bypass/duplex motor (M2)
5	Duplex transport roller 2	
6	Duplex exit roller	



Interleave Mechanism

The duplex unit, in order to reduce the overall duplex copying time, performs interleaving.

Paper exit from the main machine

Length	No. of interleaves
Less than 216mm	3
216-432 mm	2
432-457.2 mm	1

1-bin tray exit from the main machine

Length	No. of interleaves
Less than 216mm	2
216-432 mm	1

- 3 sheet interleave
1 sheet undersurface -> 2 sheet undersurface -> 3 sheet undersurface -> 1 sheet top surface -> 4 sheet undersurface -> 2 sheet top surface
- 2 sheet interleave
1 sheet undersurface -> 2 sheet undersurface -> 1 sheet top surface -> 3 sheet undersurface -> 2 sheet top surface -> 4 sheet undersurface

7.Detailed Descriptions

3-sheet interleaving

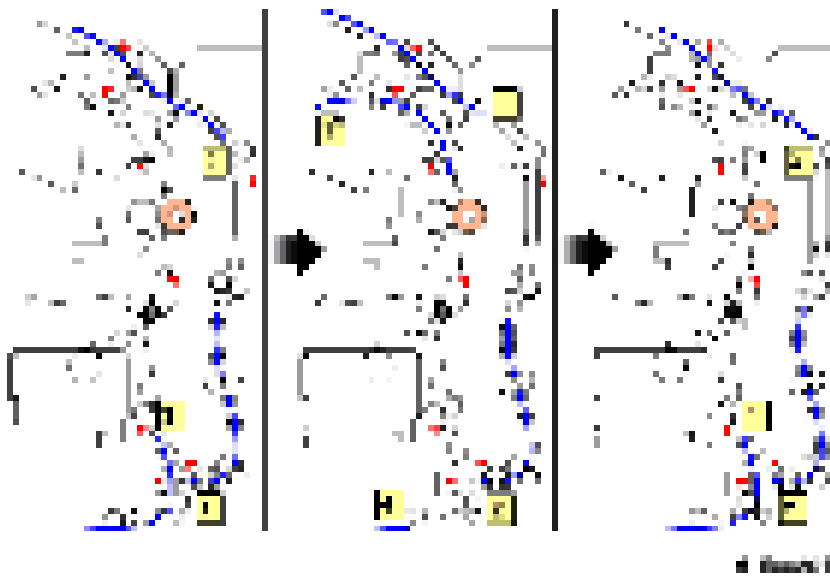

Paper Exit Unit

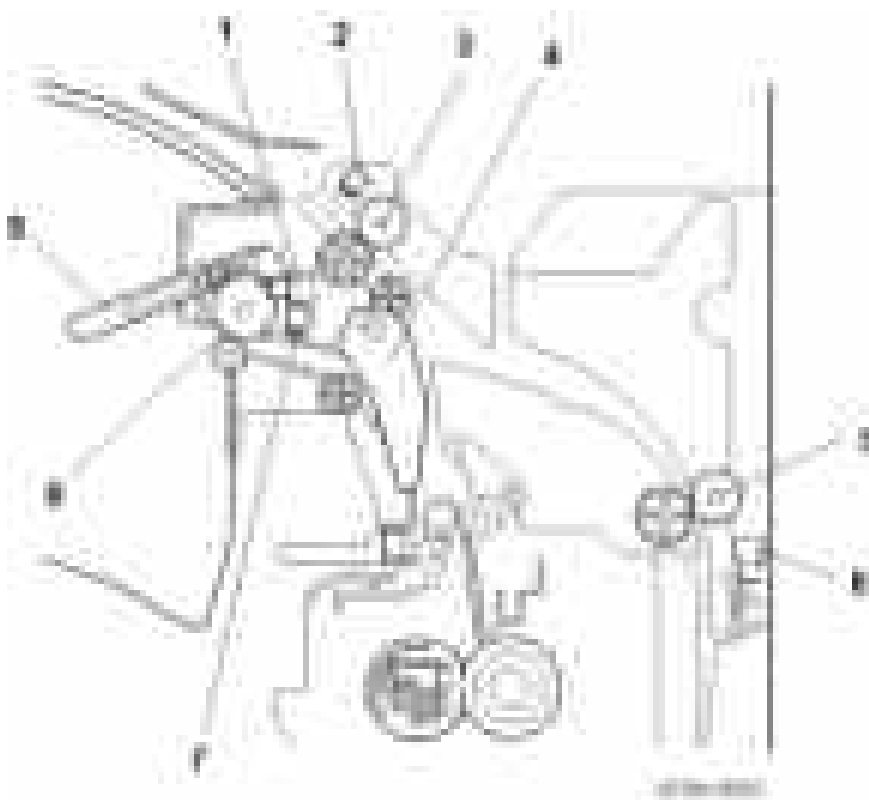

No.	Description	No.	Description
1	Paper exit full sensor (S11)	6	Duplex entrance sensor (S5)
2	Reverse sensor (S9)	7	Paper exit sensor (S10)
3	Reverse roller	8	Paper exit roller
4	Paper exit junction gate	9	Feeler
5	Duplex entrance roller 1	-	-

Delivery Location Change-over

The paper transported from the fusing unit is changed over by the junction gate in the "Machine paper exit/bridge unit" direction or the "duplex unit/1-bin tray" direction.

Machine paper exit/bridge unit direction

1. The registration sensor (S16) switches ON.
2. The paper exit/pressure release motor (M4) switches ON (CCW).
3. When the rear edge of the paper leaves the paper exit roller, the paper exit/pressure release motor (M4) switches OFF.

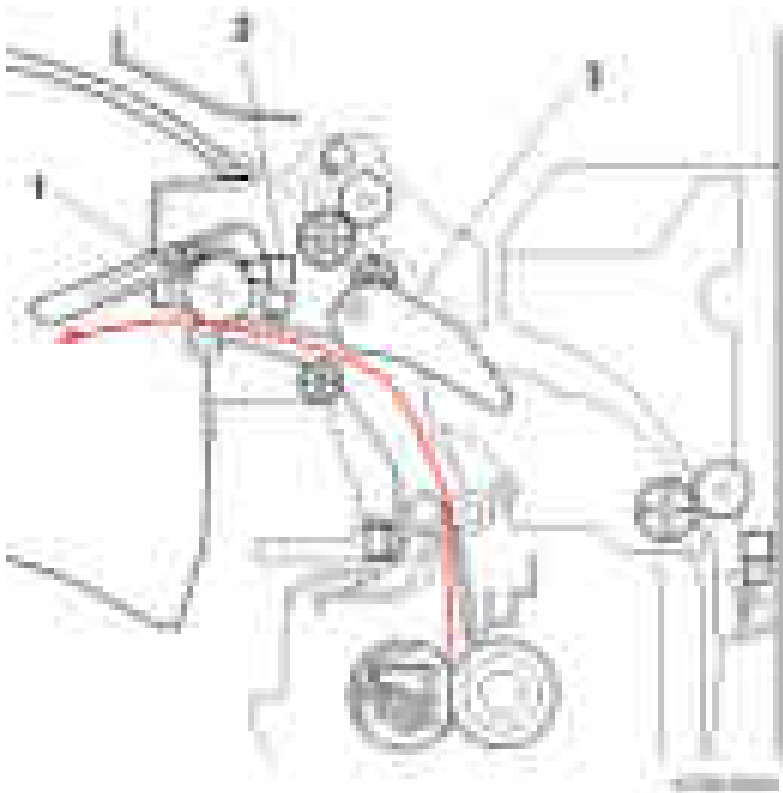

No.	Description
1	Paper exit roller
2	Paper exit sensor (S10)
3	Paper exit junction gate

Duplex unit/1-bin tray direction

1. Registration sensor switches ON.
2. The reverse motor (M3) switches ON (CCW).
3. Before the leading edge of the paper reaches the paper exit junction gate, the junction gate moves to the duplex unit/1-bin tray direction.
 - * If the gate is in the duplex unit/1-bin tray direction, the gate is not changed over.
4. Before reversing the paper, the junction gate solenoid switches OFF.
5. When the rear edge of the paper leaves the reverse roller, the reverse motor (M3) switches OFF.

7.Detailed Descriptions

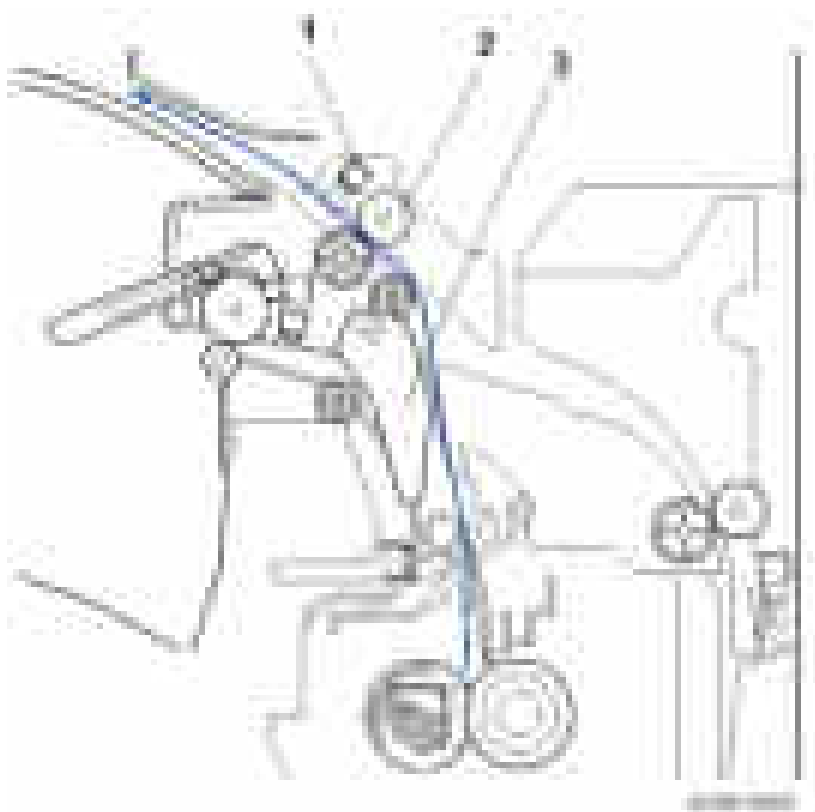

No.	Description
1	Reverse sensor (S9)
2	Reverse roller
3	Paper exit junction gate

Paper Exit Full Detection/Paper Exit Jam Detection

Paper exit full detection

This machine has a paper exit full sensor (S11).

When the paper exit is full, the sensor switches OFF (blocked) due to a feeler.

When the paper exit full sensor (S11) detects paper full and a job is stopped, the message "Please remove the paper from the MFP tray" is displayed on the operation panel.

Paper exit jam detection

Paper exit jam is detected by the paper exit sensor (S10).

Drive/Sensor Layout

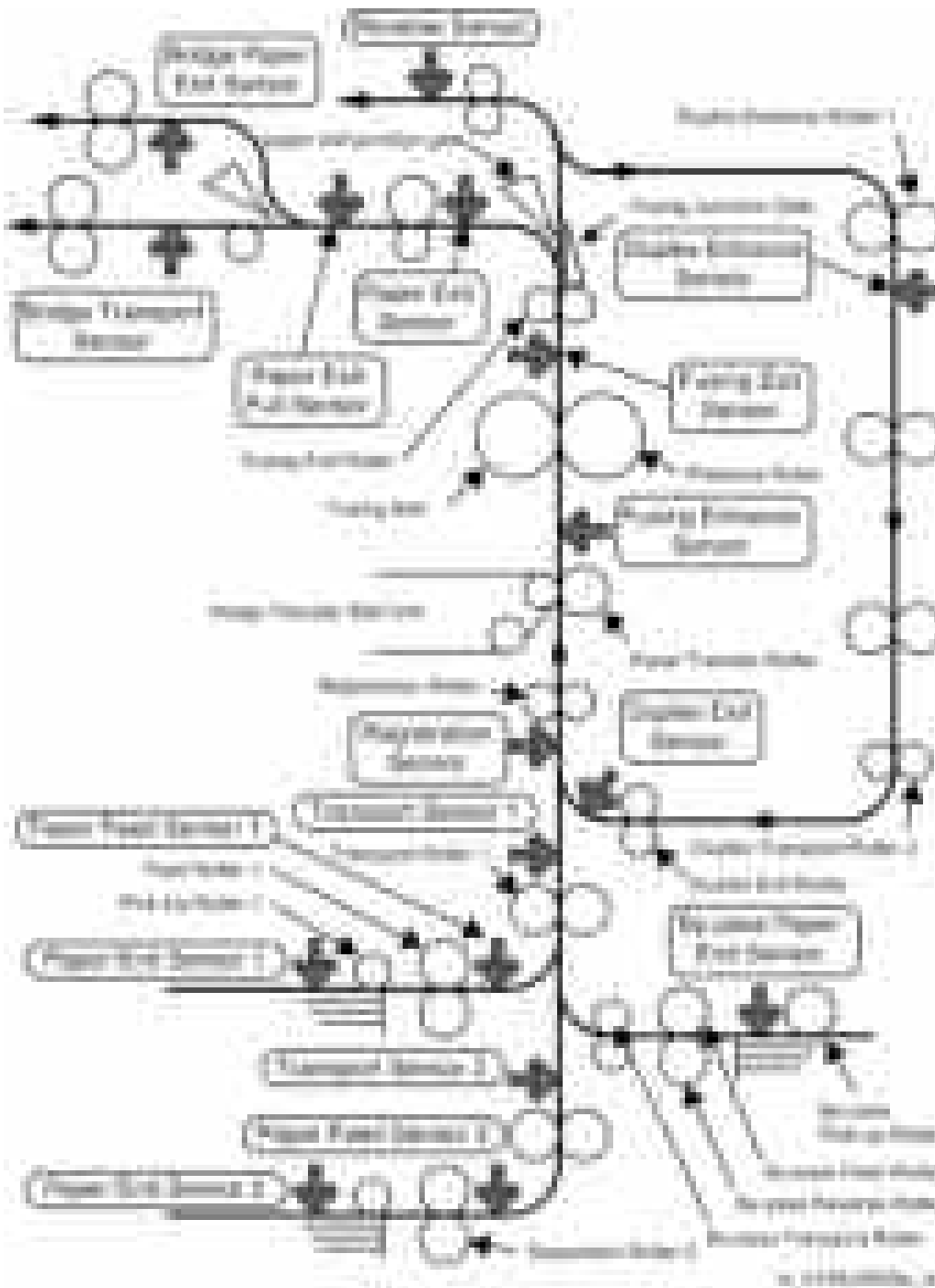

Transport Roller Drive Source

Output	Drive source
Pick-up roller 1	Paper feed motor (M6)
Paper feed roller 1	
Pick-up roller 2	
Paper feed roller 2	

7.Detailed Descriptions

Output	Drive source
First transport roller	Transport motor (M5)
Second transport roller	
Registration roller	Registration motor (M7)
Paper exit roller	Paper exit/pressure release motor (M4)
Reverse roller	Reverse motor (M3)
Duplex entrance roller 1	Duplex entrance motor (M1)
Duplex entrance roller 2	
Duplex transport roller 1	Bypass/duplex motor (M2)
Duplex transport roller 2	
Duplex exit roller	
By-pass feed transport roller	
By-pass pick-up roller	
By-pass feed roller	
By-pass Reverse roller	
Image transfer drive roller (belt)	
Paper transfer roller	Image transfer drive roller(Follows rotation of intermediate transfer belt)
Fusing drive roller	Fusing motor (M8)

Gate/Pick-up arm Drive Source

Output	Drive source	Default position	Application
Pick-up roller 1	Paper Feed Motor (M6)	Pressure contact when OFF	Loaded paper contact/separation change-over
Pick-up roller 2	paper Feed Motor (M6)	Pressure contact when OFF	Loaded paper contact/separation change-over
Paper exit junction gate	Paper Exit Solenoid (SOL2)	Paper exit path open when OFF	MFP paper exit/intermediate or 1-bin/two-face path change-over
By-pass pick-up roller	Bypass-pick-up Solenoid (SOL1)	Clearance when OFF	Loaded paper contact/separation change-over

Inter-roller Transport Path

Md	From	To	Distance (mm)
First paper feed	First pick-up roller	First paper feed roller	30.0
	First paper feed roller	First transport roller	43.0

7.Detailed Descriptions

Md	From	To	Distance (mm)
Second paper feed	Second pick-up roller	Second paper feed roller	30.0
	Second paper feed roller	Second transport roller	43.0
	Second transport roller	First transport roller	96.9
Registration	First transport roller	Registration roller	86.8
	Registration roller	Paper transfer roller (image transfer position)	95.5
Fusing	Paper transfer roller (nip)	Fusing roller (nip)	85.0
	Fusing roller (nip)	Fusing exit roller	55.7
Paper exit	Fusing roller (nip)	Paper exit roller	143.6
Two-way distribution	Fusing roller (nip)	Reverse roller	143.6
	Reverse roller	Duplex entrance roller 1	131.3
Duplex re-supply	Duplex entrance roller 1	Duplex entrance roller 2	120.4
	Duplex entrance roller 2	Duplex transport roller 1	90.9
	Duplex transport roller 1	Duplex transport roller 2	83.0
	Duplex transport roller 2	Duplex exit roller	27.2
	Duplex exit roller	Registration roller	94.7
By-pass feed	Bypass Pick-up roller	Bypass Paper feed roller	30.0
	Bypass Paper feed roller	Bypass transport roller	24.5
	Bypass transport roller	First transport roller	56.0

Sensor Position

Md	From	To	Distance (mm)
1st feed tray	Paper feed roller (1st feed tray)	Paper feed sensor (1st feed tray) (S12)	5.0
	Transport roller (1st feed tray)	Transport sensor (1st feed tray) (S13)	16.8

7.Detailed Descriptions

Md	From	To	Distance (mm)
2nd feed tray	Paper feed roller (2nd feed tray)	Paper feed sensor (2nd feed tray) (S22)	5.0
	Transport roller (2nd feed tray)	Transport sensor (2nd feed tray) (S23)	24.3
	Transport sensor (2nd feed tray) (S23)	Transport sensor (1st feed tray) (S13)	88.7
Registration	Registration sensor (S16)	Registration roller	17.2
Paper exit	Paper exit sensor (S10)	Paper exit roller	17.0
Two-way distribution	Reverse roller	Reverse sensor (S9)	14.0
Duplex	Duplex entrance roller 1	Duplex entrance sensor (S5)	25.0
	Duplex exit roller	Duplex Exit Sensor (S3)	15.0
1-bin	Reverse sensor (S9)	1-bin paper exit roller	-

Paper Exit Driven Roller and Paper Support Guide

Paper Exit Driven Roller

The standard paper exit driven roller [B] is drum-shaped and improves the stacking performance of the main machine exit tray by adding resilience to the paper. However, if the paper has too much resilience, it may jam as it enters the optional paper path when the internal peripheral is connected. Therefore, a flat type driven roller [A] is used to reduce the resilience when transporting the paper.

The following options use the flat type driven roller:

- Internal Finisher SR3250
- Bridge Unit BU3090
- Internal Finisher SR3300
- Side Tray Type M37
- Internal Multi-Fold Unit FD3010



Paper Support Guide

To prevent paper jam when the paper is delivered from the machine's paper exit to the internal exit peripherals, attach the paper support guide [C] (supplied with the peripherals).



Removing Wrinkling in the Tray

When paper larger than A3 is set, wrinkles may appear at the end of the paper.

In this machine, the support components [A] and a decal are attached, which are also available to the end-user.

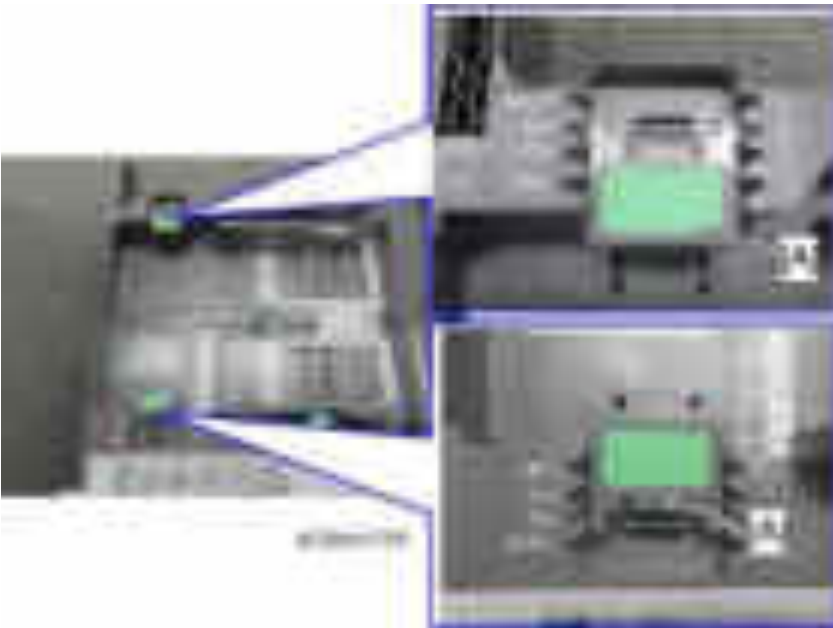

For small size paper, the side fences [B] are sufficient because the paper is light, but paper larger than A3 must be set at the position indicated by the decal.



Factory Default:

- Tray 2: A3 (11 inches for NA only)
- Optional Paper Tray: A3 for all regions

Fusing

Changes from the Previous Models

Lookup Table

Item	MP C2004/C2504/C3004/C3504/C4504/C5504/C6004(Previous Model)	IM C2000/C2500/C3000/C3500/C4500/C5500/C6000
Tools for Attachment	Screws	Lock lever (same as Met-P2)

Changes

- Tools for Attachment**

The tools for attaching and removing the fusing unit are the same as those for the user maintenance model Met-P2 (using lock lever, not screws).



- Parts on Main Unit**

A cover [A] to protect the shield drive motor (M28) has been added to the main unit. Models (abyz) without the shield drive motor (M28) are equipped with a cover to protect the harness.



- **Notes about Resetting the Counter**

On this model, the fusing unit (400 K) and dust filter (400 K) are intended to be replaced at the same time.

Thus, when the fusing unit is replaced, the dust filter's counter is reset.

Item with Counters that are Reset when the Fusing Unit is Replaced

- Previous model: fusing unit, fusing sleeve belt, pressure roller
- Present model: fusing unit, fusing sleeve belt, pressure roller, dust filter

Overview

This machine employs a QSU-DH fusing system wherein a heater emits light to heat a fusing belt.

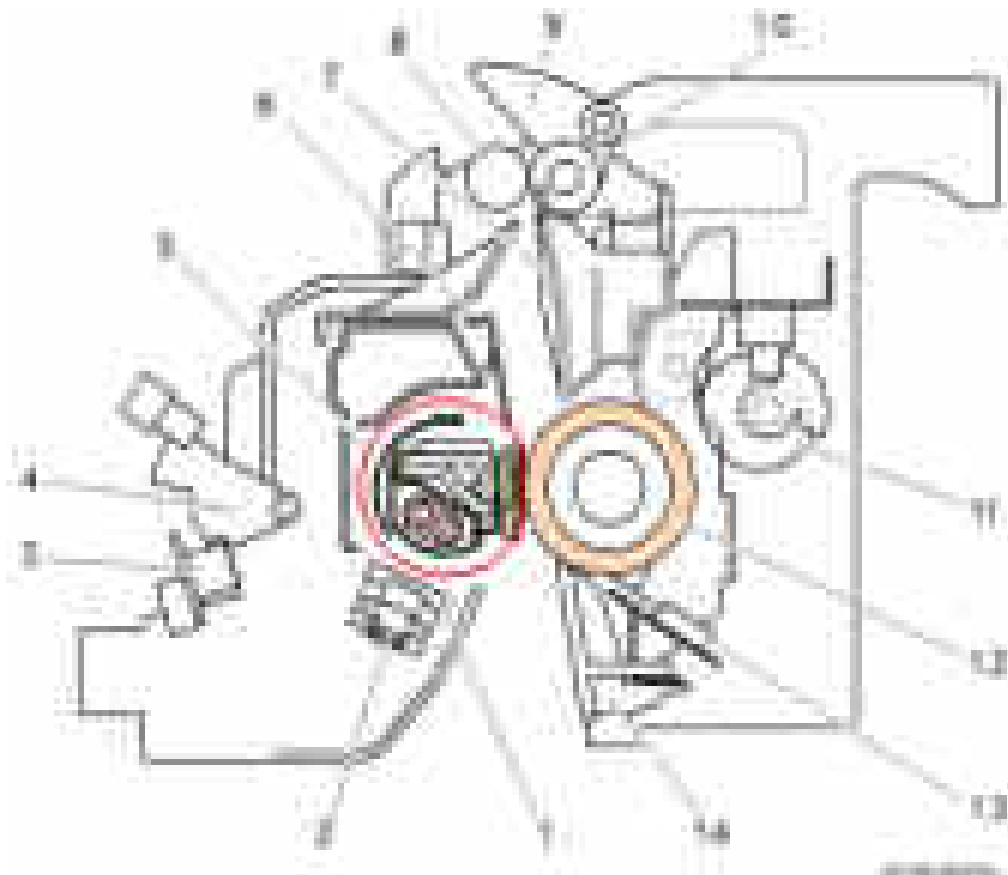

7.Detailed Descriptions

No.	Description	No.	Description
1	Fusing sleeve thermostats	8	Fusing exit roller (driven)
2	Non-contact thermistor (S46) (S47)	9	Fusing junction gate
3	Thermopile (TH1) (TH2)	10	Fusing exit roller (drive)
4	Shield feeler	11	Pressure roller drive cam
5	Fusing sleeve belt	12	Pressure roller
6	Stripper plate	13	Pressure roller thermistor (TH3) (TH4) (TH5)
7	Fusing exit guide plate	14	Fusing entrance guide plate

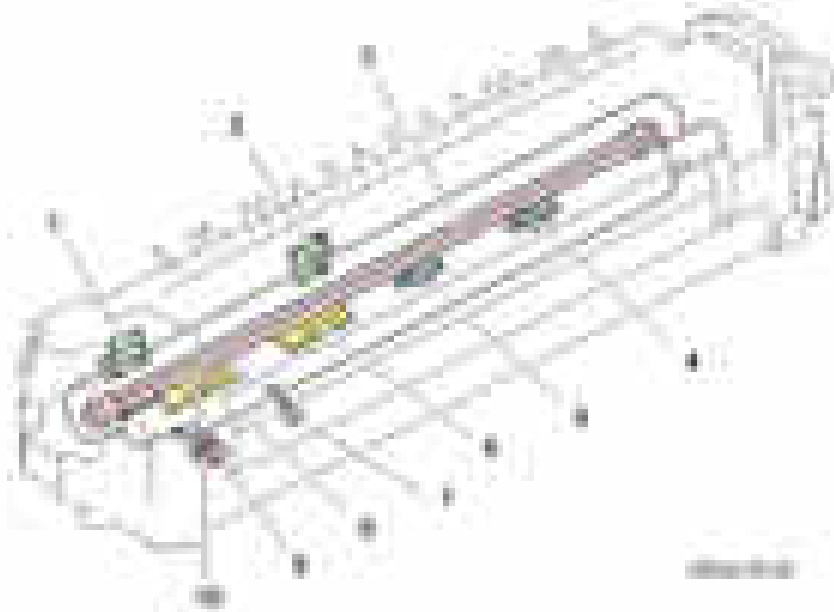

No.	Description	No.	Description
1	Thermopile (edge) (TH2)	6	Non-contact Thermistor (center) (S46)
2	Thermopile (center) (TH1)	7	Pressure Roller Thermistor (center) (TH3)
3	Fusing Heater	8	Non-contact Thermistor (edge) (S47)
4	Fusing Sleeve Thermostat (edge)	9	Pressure Roller Thermistor (edge) (TH4)
5	Fusing Sleeve Thermostat (center)	10	Pressure Roller Thermistor (Full-bleed edge) (TH5)

Mechanism

Fusing System

IM C6000/C5500/C4500

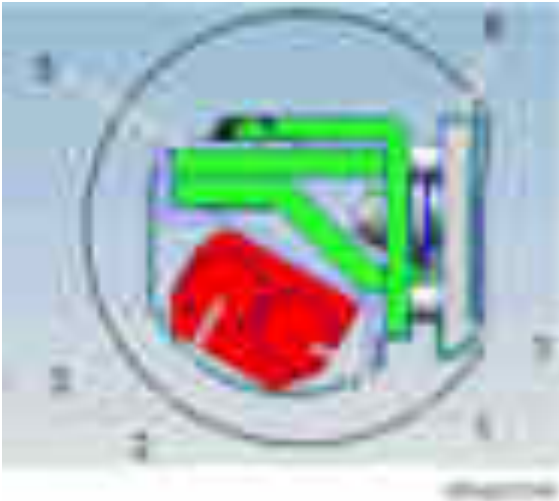

IM C3500/C3000/C2500/C2000

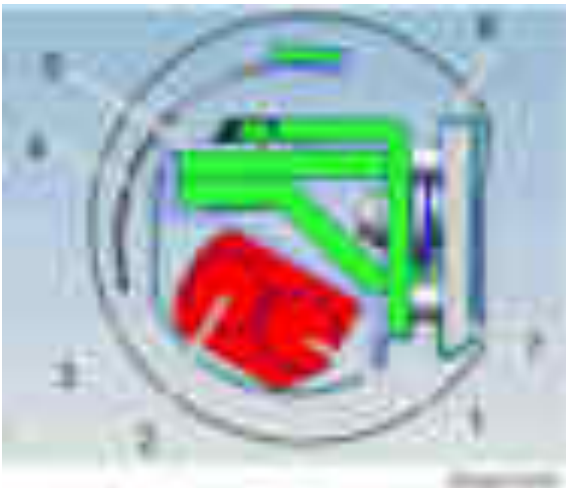

No.	Description	No.	Description
1	Fusing lamp (center)	5	Reflector
2	Fusing lamp (edge)	6	Soaking plate
3	Fusing sleeve belt	7	Nip pad
4	Shield*	-	-

* IM C6000/C5500/C4500 only.

IM C6000/C5500/C4500: New QSU-DH (Quick Start Up-Direct Heat) fusing

This is a fusing unit with a soaking plate added to the pressure pad on the fusing nip.

In addition to the mechanism to efficiently heat the paper according to its width by rotating the shield plate, a soaking plate to even out the temperature of the fusing sleeve belt in the longitudinal direction is adopted.

It controls the shading position on 9 levels by adjusting the rotating time according to the paper width after turning on the main power switch and after starting/finishing printing.

The soaking plate on the nip (on the surface of the pressure pad) disperses the temperature deviation between the front and rear parts of the fusing sleeve belt, so as to even out the temperature.

7.Detailed Descriptions

IM C3500/C3000/C2500/C2000: E-QSU (Enhanced-Quick Start Up) fusing

This fusing unit has the soaking plate added to the pressure pad on the fusing nip and removed the shield plate control.

The model of 35cpm or below requires a little amount of heat, so it controls the temperature by the soaking plate and heater control at the edges and center.

The soaking plate on the nip (on the surface of the pressure pad) disperses the temperature deviation between the front and rear parts of the fusing sleeve belt, so as to even out the temperature.

A Fusing belt is driven by drag rotation following a pressure roller and presses a nip pad against the pressure roller to fix toner on the paper.

The heater emits light and a point on the left of the fusing belt which is heated moves in an anticlockwise direction so that heat is transmitted up to the contact point with the pressure roller.

Heater

Comprises two parts

The number of watts of heater:

	IM C6000/C5500/C4500		IM C3500/C3000		IM C2500/C2000	
	NA/TWN	EU/AA/CHN	NA/TWN	EU/AA/CHN	NA/TWN	EU/AA/CHN
Center	809W	816W	809W	700W	647W	700W
Edge	430W	679W	430W	527W	344W	527W

Nip pad

Presses against the Pressure roller to form a fusing nip. The top surface is covered with a slippery sheet.

Reflector

Transmits heat efficiently to the left of the fusing belt.

Shield

Shield width changes by rotating the shield according to the paper width. Ensures that light from the heater is not transmitted to the fusing belt edge (prevents excessive edge temperature rise when printing small size paper).

Flanges

Situated on both ends of the fusing belt. They maintain the shape of the belt.

Soaking plate

Disperses a temperature deviation in a longitudinal direction of the fusing belt to uniformize.

Temperature Control (IM C6000/C5500/C4500)

To prevent excessive edge temperature rise when printing small size paper, the light-up pattern of the center/edge heaters and shield plate position are changed depending on the paper size.

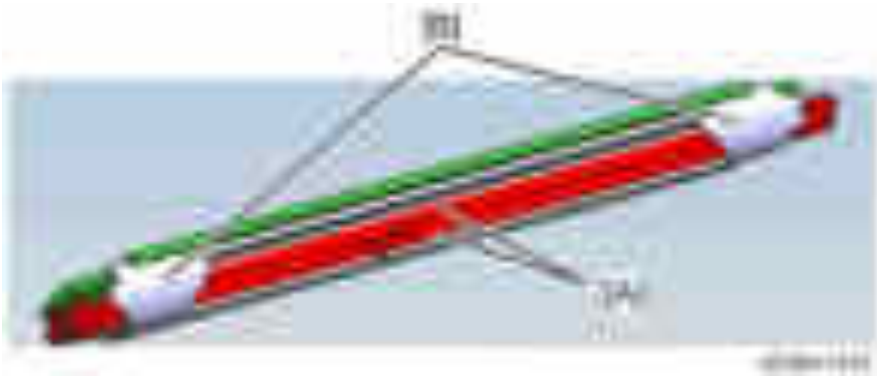

[A]: Fusing lamp (center/edge)

[B]: Shield

Basic operation

After paper feed begins, depending on the rise of edge temperature (Pressure roller thermistor (Full-bleed edge/Edge)), the shield is moved to a suitable position. The shield has 9 positions including the home position.

Depending on the unit temperature and continuous paper feed time, the edge heater is switched ON/OFF, and the shielding is adjusted.

Shield drive

The shield is driven by a shield drive motor (M28) on the machine.

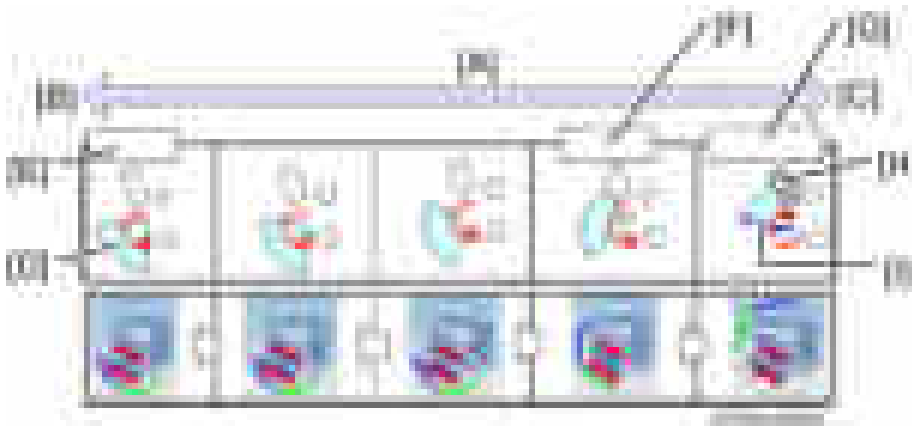

[A]: Shield operating range

[B]: Shield width (large), motor cw

[C]: No shield, motor ccw

[D]: Filler

[E]: Position 8

[F]: Position 1

[G]: Home position

[H]: Shield sensor (to detect HP)

[I]: Reference edge (Reference edge is detected when the main power supply is on, when print is started, and when print is finished.)

7.Detailed Descriptions

Temperature Control (IM C3500/C3000/C2500/C2000)

The shield is not equipped and the temperature is managed by the soaking plate and heater control of end part/center.

Fusing Drive

The pressure roller [B] is driven by the fusing motor (M8) [A].

The fusing belt [C] is driven by the pressure roller (drag rotation).

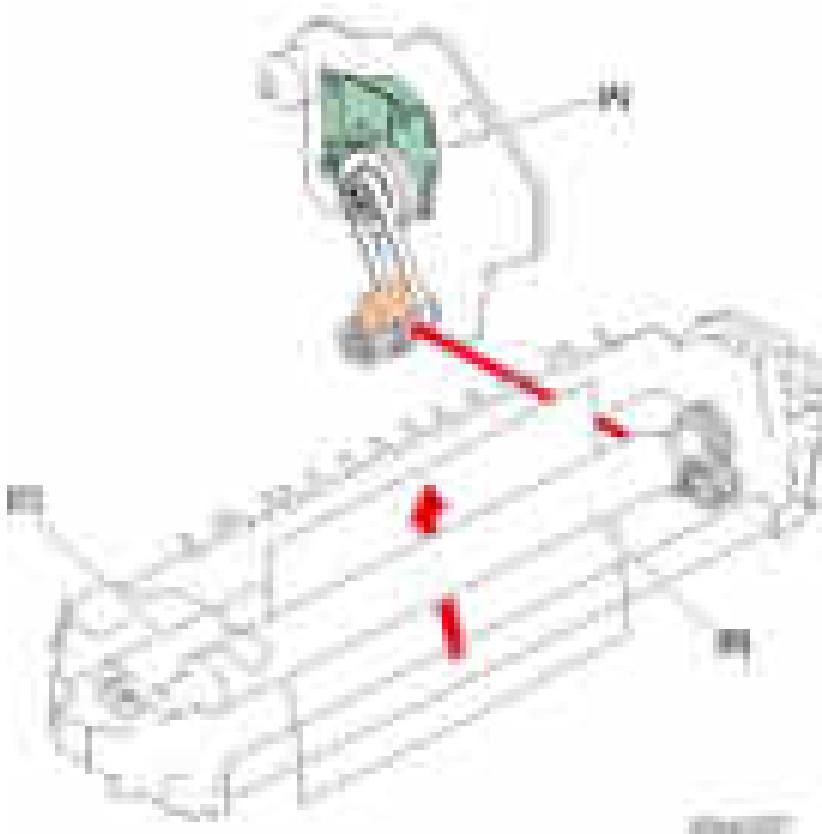

Pressure Release Mechanism

To easily remove the paper in the event of a jam in the fusing unit, a pressure release mechanism is provided.

A pressure lever [C] is released by the drive of the paper exit/pressure release motor (M4) [A], and the pressure roller [D] separates from the fusing belt.

The pressure roller HP sensor (S26) [E] detects the encoder [B] and determines the position of the pressure roller.

After replacing the pressure roller, if the sensor does not detect the encoder 3 times continuously after a job is completed, SC569-00 (Paper Exit/ Pressure Release Motor Error Detection) is generated.

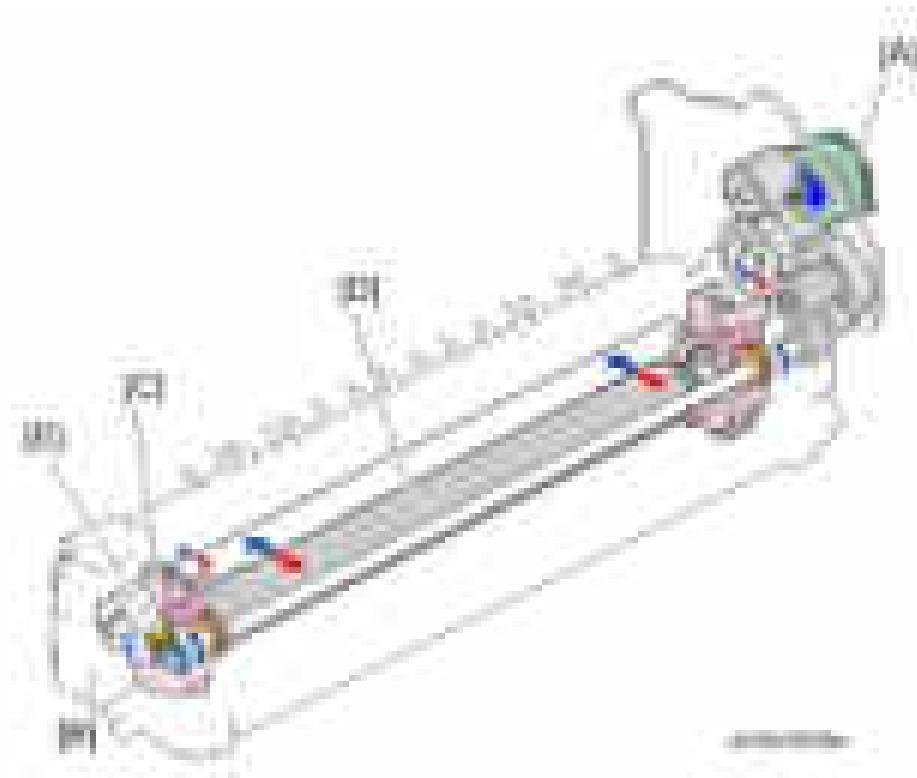

Fusing Temperature Control

Warm-up mode

After power ON, Fusing warm-up begins. The fusing motor (M8) is switched ON, the halogen heater is energized, and the fusing temperature is increased to the "reload target temperature."

When fusing warm-up is completed, the fusing motor (M8) is switched ON for a certain time, and the fusing temperature is maintained at the "reload target temperature".

Standby mode

After fusing reload, when a certain time has elapsed, power supply to the halogen heater is switched OFF, and the fusing motor (M8) is switched OFF. At the same time, the temperature is maintained at the "standby target temperature (SP1-107-001)" by the halogen heater.

In standby mode, the fusing motor (M8) rotates once every 60 minutes.

The operation interval of the fusing motor (M8) can be changed by SP1-122-001 (Standby Rotation Setting Rotation Interval) but the change may cause the uneven glossiness on the image.

Printing ready mode

After returning to standby mode, the halogen heater is re-energized, and the fusing temperature is raised to the "printing ready target temperature." If printing is not required, the machine again enters the standby mode after a certain time has elapsed.

If printing is required in standby mode during return, the halogen heater is energized, the fusing temperature is increased to "target temperature after reload/after paper feed," and the print job starts.

In printing ready mode, the shield is at the home position.

7.Detailed Descriptions

CPM down control

To maintain image quality and machine quality, this machine has a low-temperature CPM mode and high-temperature CPM mode and implements 3 levels of CPM down according to the usage situation and machine state.

Low-temperature CPM mode

In a low-temperature environment, the fusing lamp cannot keep up, and it may be difficult to maintain the fusing target temperature. To handle this, the detection temperature of the thermopile (center) (TH1) is checked every few seconds, and if the detection temperature during the check is below a threshold value, the CPM is decreased by 1 level.

This low-temperature CPM reduction is performed in the following 3 levels:

<CPM down level>

Normal CPM	Level
CPM down 1	100%
CPM down 2	80%
CPM down 3	65%
Normal CPM	50%

Hot CPM mode

To shorten the warm-up time and reduce the TEC value, this machine employs a fusing unit with a low heat capacity.

For this reason, the temperature of those parts of the fusing belt where paper does not pass easily increases, and the outside of the paper width may get extremely hot. In order to prevent the belt breakage due to this excessive temperature rise, CPM down is implemented depending on the usage conditions. CPM down can be implemented in the following 3 levels depending on the detection temperature of the temperature sensor, or the paper passage time.



- The down-level % is a value for the case where a typical paper (Normal paper: A3/A4) passes through the SEF. There may be some differences depending on paper size/paper thickness.

<CPM down level>

Mode	Level
Normal CPM	100%
CPM down 1	80%
CPM down 2	50%
CPM down 3	30%

CPM down determination using a temperature sensor

The temperature sensor is checked at given intervals, and if the detection temperature is above a threshold value, the CPM is decreased by 1 level.

Since the points at which temperature tends to increase depending on the paper size, the sensor used

is changed depending on the paper size.

Paper width (length)	Check sensor
A3/DLT/B4	Pressure roller thermistor (edge) (TH4)
LT/A4	Thermopile (edge) (TH2)
B5/A5/B6/A6	Pressure roller thermistor (center) (TH3)

CPM down determination using paper passage time

Depending on the paper size, it may not be possible to determine the points on the fusing belt which tend to rise in temperature by a sensor.

Therefore, time conditions are also used to determine CPM down, and if continuous paper passage time is above a threshold value, CPM is decreased by 1 level.

(When CPM down is performed by time conditions, CPM does not increase thereafter.)

Curl Correction Mechanism

This machine provides a curl reduction mechanism on the fusing exit.



Curling is reduced by bending in the reverse direction of the curl created at the fuser nip and forcibly adding resilience using the fusing exit roller [B], Fuser exit driven roller [C], and Fuser junction gate [A], located at the fuser nip exit.

The fusing junction gate is retracted for duplex printing/thick paper to prevent image smearing.

7.Detailed Descriptions

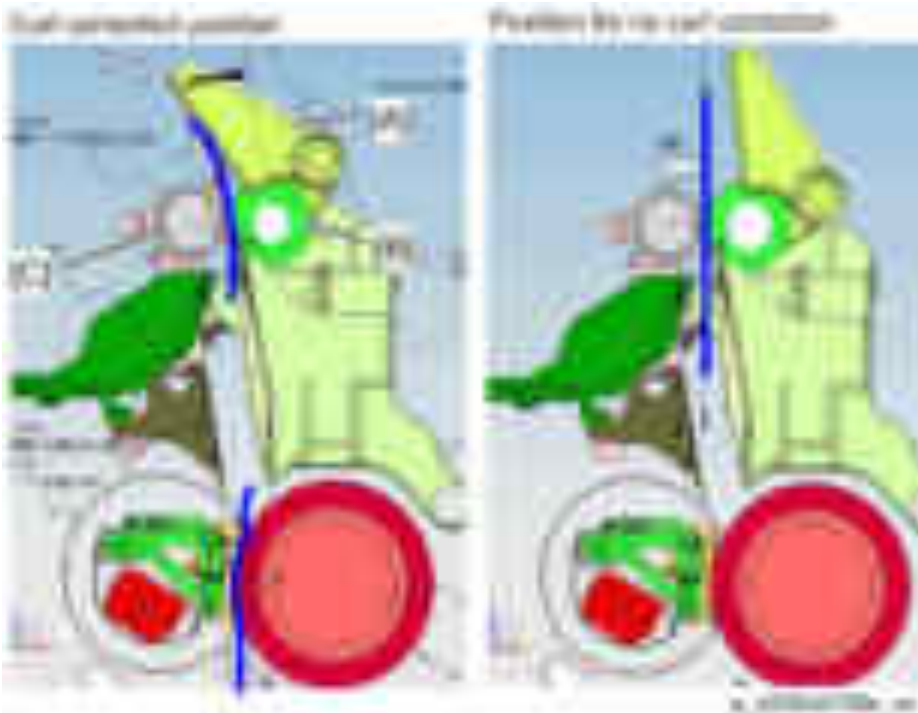

Drive

The Fusing junction gate [C] is rotated via the arm [B] by turning ON the fusing exit drive solenoid (SOL3) [A] located on the main machine side.

When the solenoid is ON, the fusing junction gate is at no curl correction position.



When the solenoid is OFF, it is put in the continuous curl correction position by spring [A].



Availability of curl correction by print mode

For duplex printing, or using thick paper, the fusing junction gate is retracted to prevent image smearing.

☒: Curl corrected (one-side printing only)

-: Curl not corrected

	Thin Paper	Plain Paper 1	Plain Paper 2	Middle Thick	Thick Paper 1	Thick Paper 2	Thick Paper 3	Thick Paper 4
Do not Display	☒	☒	☒	-	-	-	-	-
Recycled Paper	☒	☒	☒	-	-	-	-	-
Color Paper	☒	☒	☒	-	-	-	-	-
Special Paper 1	☒	☒	☒	-	-	-	-	-
Special Paper 2	☒	☒	☒	-	-	-	-	-
Special Paper 3	☒	☒	☒	-	-	-	-	-
Letterhead	☒	☒	☒	-	-	-	-	-
Preprinted Paper	☒	☒	☒	-	-	-	-	-
Bond Paper	☒	☒	☒	-	-	-	-	-
Cardstock	☒	☒	☒	-	-	-	-	-
OHP (Transparency)	-	-	-	-	-	-	-	-
Label Paper	☒	☒	☒	-	-	-	-	-
Coated: Matte	-	-	-	-	-	-	-	-
Envelope	-	-	-	-	-	-	-	-
Coated: Glossy	-	-	-	-	-	-	-	-

SP1-907-096 (Operation Setting: Fusing Exit SOL Setting)

By changing SP1-907-096, the curl correction mechanism can be enabled regardless of the paper setting.

If the Fusing Exit Drive Solenoid (SOL3) is ON, the curl correction function is OFF.

If the Fusing Exit Drive Solenoid (SOL3) is OFF, the curl correction function is ON.

- 0: Fusing Exit Drive Solenoid (SOL3) is ON (normal control)
- 1: Always **no** curl correction only when feeding from bypass tray
- 2: Always **no** curl correction except when feeding from bypass tray
- 3: Always **no** curl correction regardless of paper feed tray
- 4: Always curl correction only when feeding from bypass tray
- 5: Always curl correction except when feeding from bypass tray
- 6: Always curl correction regardless of paper feed tray

For duplex printing, or printing to 1-bin tray, always **no** curl correction regardless of the SP setting.

Electrical Parts

Changes from the Previous Models

Lookup Table

Item	MP C2004/C2504/C3004/C3504/C4504/C5504/C 6004(Previous Model)	IM C2000/C2500/C3000/C3500/C4500/C 5500/C6000
Board Compositi on	IPU, BCU	IPU and BCU combined into a BICU
NVRAM	2 (2M×2)	1 (4M×1)
Java VM	Standard onboard function	Supplied as an optional SD card
Anti- Condensa tion Heater	Not provided with the calendar function	Provided with the calendar function (in units of months)
Proximity Sensor (S49) SC869-01 Occurrenc e Condition	If continuously switched on for 24 hours	If continuously switched on for 480 hours
Proximity Sensor (S49) SC869-02 Occurrenc e Condition	On detecting user operation 20 times when switched off	On detecting user operation 300 times when switched off
Operation Panel Harness	Between operation panel and IPU	Between operation pane and CTL
Operation Panel Version	G2	G2.5

Changes

- **Interface Slot**

On the previous model, the USB port [A] was used for connecting the USB cable [B] supplied with USB Device Server Option Type M19. For the USB connection, the service technician removed the resin cover with nippers.

On this model, the machine is shipped with the USB port exposed so that the customer can use it immediately.

The board of the Device Server Option has been changed (from type M19 to type M37) and is not equipped with a USB port [A].

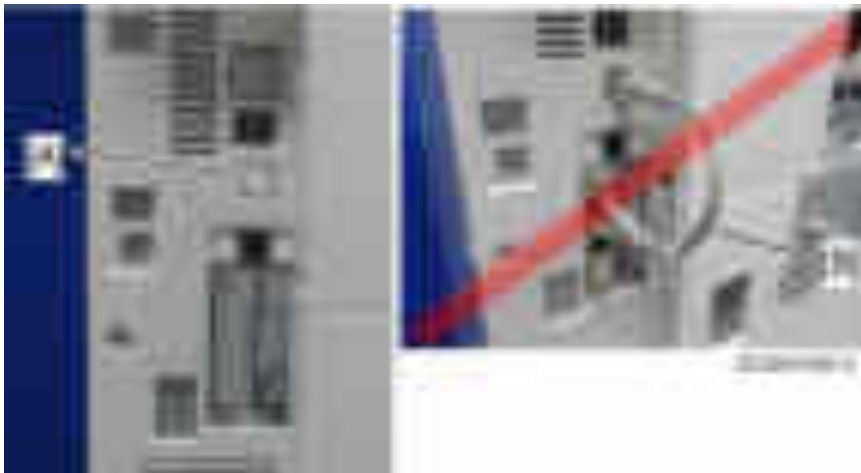

- **Optional PCB Slot (2 slots reduced to 1)**

The previous model (Met-C2cde) was equipped with two optional PCB slots, but the present model has only one.

It is not possible to attach two options (because it requires two Rios slots).



Block Diagram

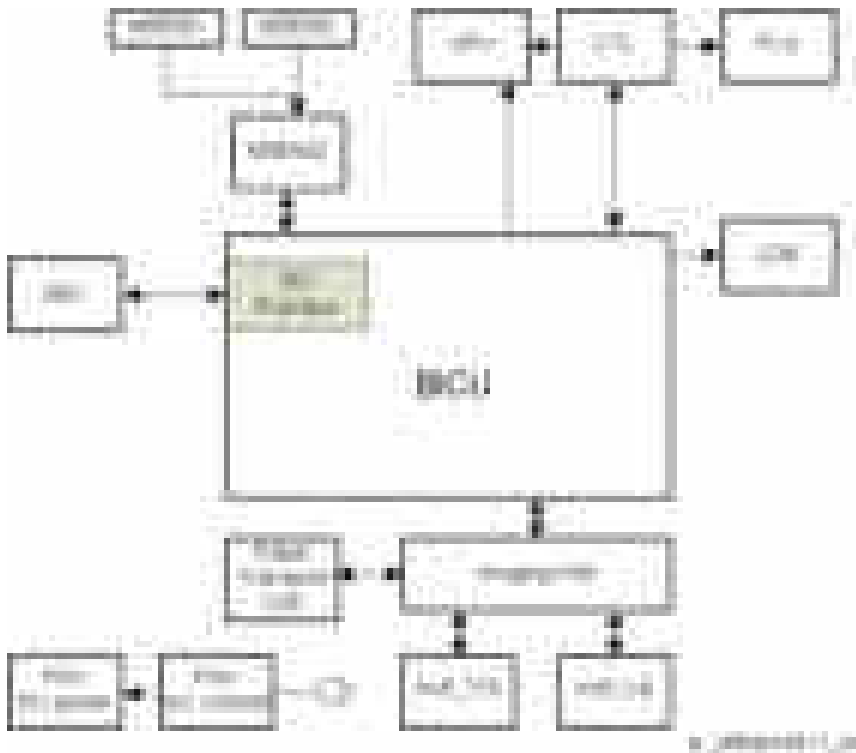

Board Outline

Controller

Controls the MFP system overall. Comprises an x86CPU, controller ASIC, IO control ASIC, and RAM.

SBU (PCB7)

Scanning control circuit which performs analog signal processing and AD image conversion of the CCD scanned image.

It also has an IPU I/F, and controls scanner input-output signals according to CPU commands.

LDB (PCB14) (PCB15)

LD control circuit which drives the laser diode with a universal driver.

BICU (PCB10)

Controls the engine and processes digital signals.

The IPU (SIO) functions are included in BICU.

SIO Function

The circuit which controls the generation of SBU power, scanner internal sensor I/F, carriage drive stepping motor and LED drive.

MSENS1 (Proximity Sensor), MSENS2 (Proximity Sensor Board)

Proximity Sensors (S49) and Proximity Sensor Board (PCB18) are equipped.

People are detected by IR sensors which sense the temperature difference between the human body and the temperature of the machine location.

IOB

Controls the MFP engine sensor, motor, and solenoid.

FCU

Controls the fax program.

OPU

Controls the operation panel.

HVP (composite high-voltage power supply TTS/CB) (PCB16) (PCB19)

Generates the high-voltage power required for process control. Divided into two units, i.e., transfer (TTS) and electrostatic/developing (CB).

PSU (PCB8) (PCB9)

Generates DC power from a commercial AC power supply, and supplies it to each control circuit. Comprises an A/C drive circuit for controlling the fixing heater.

Paper Tray Dehumidifier Heaters and Scanner/PCDU Anti-condensation Heaters

Circuit Configuration

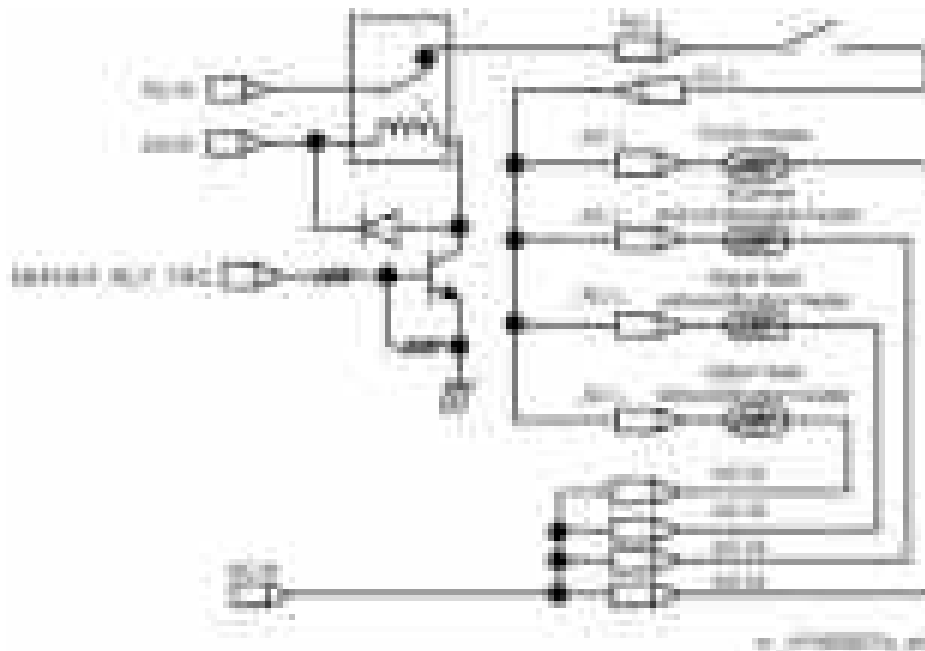

The power circuit of the scanner anti-condensation heater and drum dehumidifier heater is linked to the switch of the paper feed heater. Therefore, when the paper feed heater power is turned OFF, all heater is de-energized. In addition, the operation is controlled so as not to exceed the maximum power.

Dehumidification heater switch ON

7.Detailed Descriptions

Heater	SP5-805-001	Plug-in	Energy saving	Waiting	Action
Paper feed dehumidification heater	OFF(0)	Energized	Energized	De-energized	De-energized
	ON(1)	Energized	Energized	Energized	De-energized
Option feed dehumidification heater	OFF(0)	Energized	Energized	De-energized	De-energized
	ON(1)	Energized	Energized	Energized	De-energized
Scanner anti-condensation heater	OFF(0)	Energized	Energized	De-energized	De-energized
	ON(1)	Energized	Energized	Energized	De-energized
PCDU heater	OFF(0)	Energized	Energized	De-energized	De-energized
	ON(1)	Energized	Energized	Energized	De-energized

Exterior Cover/Air Flows (Fan Control)

Changes from the Previous Models

Lookup Table

Covers	-	Added proximity sensor left cover
Airflow control Dust filter - mainten ance interval	300K	400K
Airflow control Others	-	<ul style="list-style-type: none"> Removed Helmholtz system Removed PSU exhaust fan
Item	MP C2004/C2504/C3004/C3504/C4504/C5504/C6004(Previous Model)	IM C2000/C2500/C3000/C3500/C4500/C5500/C6000

Changes

- Proximity Sensor Left Cover**

A proximity sensor left cover [A] has been added to the proximity sensor cover.

On the previous model, it was necessary to remove the proximity sensor cover when installing the bridge unit and other internal finisher options; but on this model, it is possible to install such options by removing only the proximity sensor left cover.



- Exhaust Filter**

The filters' position and shape have been changed. On the previous model [A], it was not possible to remove and attach the exhaust filter when the finisher was attached; but on this model [B], it can be done.

7.Detailed Descriptions



- **PSU Exhaust Fan**

The PSU exhaust fan [A], located next to the exhaust filter on the previous model, has been removed. (Same as Met-P2)

Even without the fan, the PSU temperature stays within the required range, so the print quality is not affected.

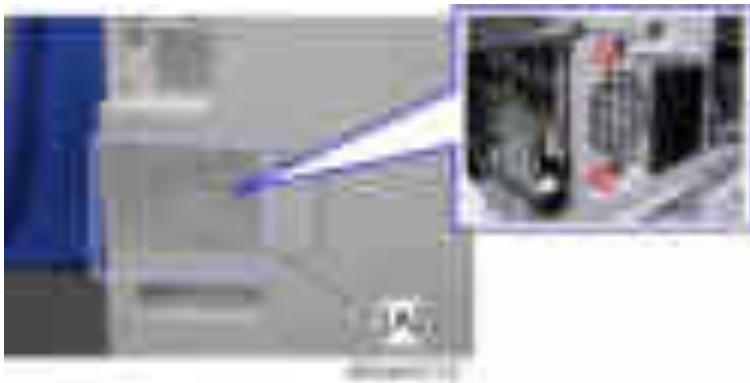

- **Helmholtz System**

The Helmholtz system [A] has been removed.



- **Scanner Support**

The location of the scanner support has been changed slightly.

[A]: On the left side, previous model; [B]: In the center, current model.



Overview

IM C6000/C5500/C4500

Imaging system (front) / Fusing system

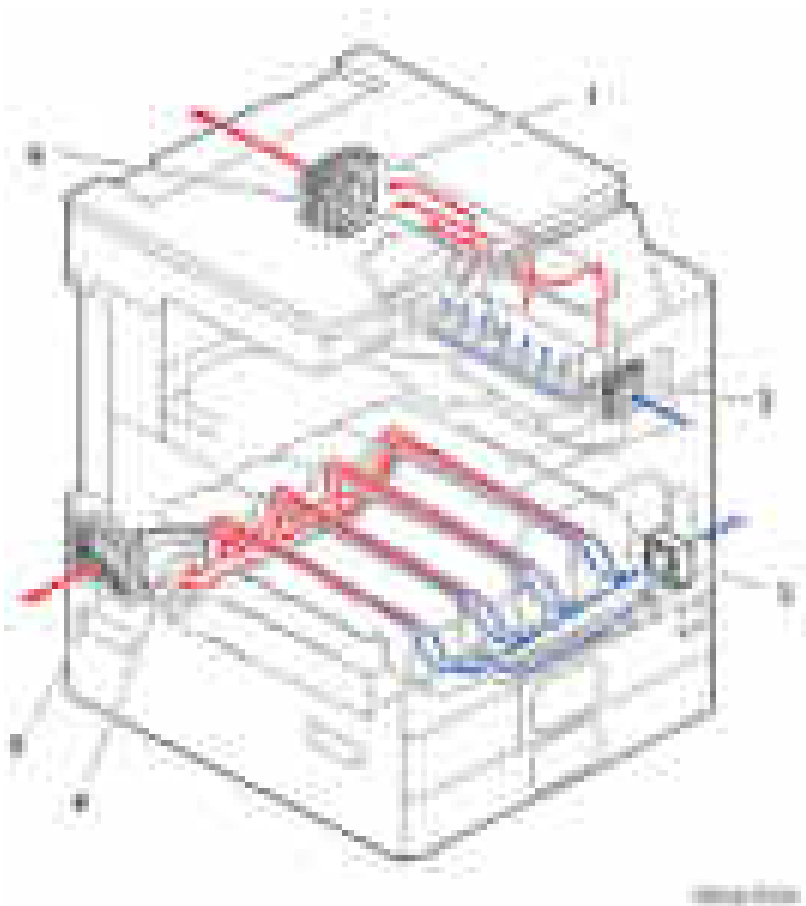

No.	Part name	No.	Part name
1	Fusing exhaust fan (FAN1) (Fusing Exhaust Fan (FAN1))	4	Ozone exhaust fan (FAN3) (Ozone Exhaust Fan (FAN3))

7.Detailed Descriptions

No.	Part name	No.	Part name
2	Paper exit cooling fan (FAN7) (Paper Exit Cooling Fan (FAN7))	5	Exhaust filter (Exhaust Filter)
3	Development intake fan (FAN6) (Development Intake Fan (FAN6))	6	Deodorization filter (Deodorization Filter)

Imaging system (rear)

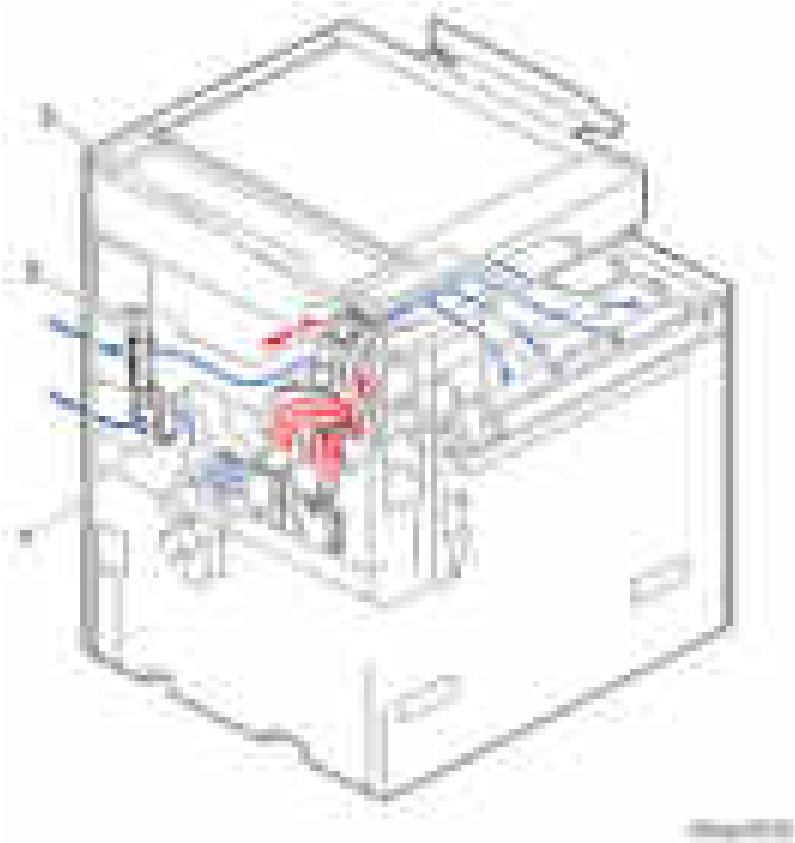

No.	Part name	No.	Part name
1	Drive cooling fan (FAN9) (Drive Cooling Fan (FAN9) (IM C6000/C5500/C4500 Only))	3	Main exhaust fan (FAN8) (Main Exhaust Fan (FAN8) (IM C6000/C5500/C4500 Only))
2	Toner supply cooling fan (FAN5) (Toner Supply Cooling Fan (FAN5))	-	-

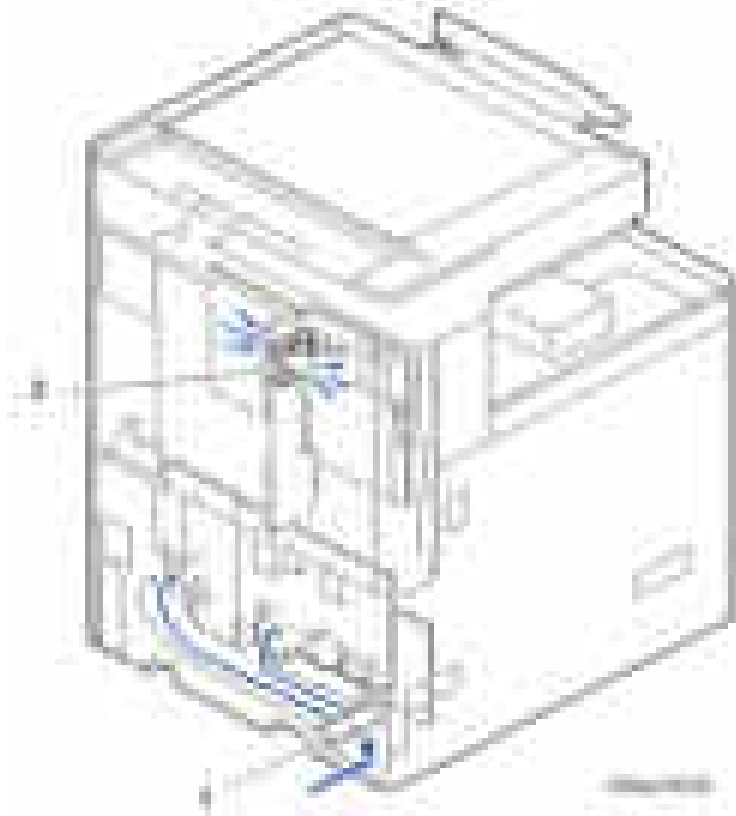
Electric system

No.	Part name	No.	Part name
1	PSU cooling fan (FAN2) (PSU Cooling Fan (FAN2))	2	Controller box cooling fan (FAN4) (Controller Box Cooling Fan (FAN4))

Imaging system (front) / Fusing system

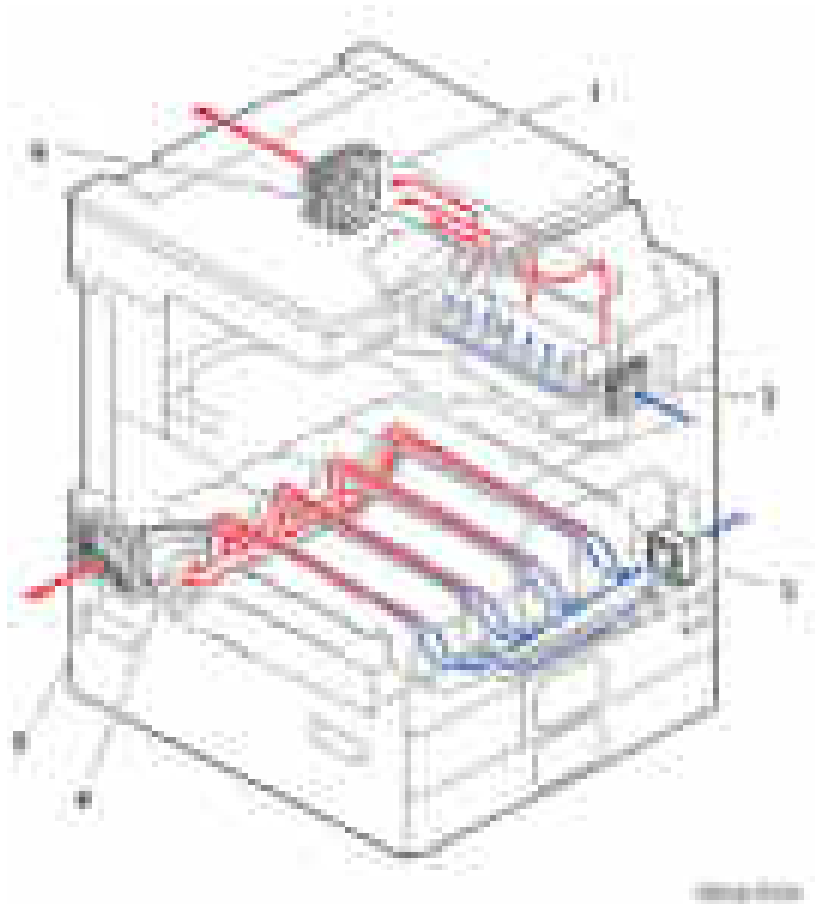

No.	Part name	No.	Part name
1	Fusing exhaust fan (FAN1) (Fusing Exhaust Fan (FAN1))	4	Ozone exhaust fan (FAN3) (Ozone Exhaust Fan (FAN3))
2	Paper exit cooling fan (FAN7) (Paper Exit Cooling Fan (FAN7))	5	Exhaust filter (Exhaust Filter)
3	Development intake fan (FAN6) (Development Intake Fan (FAN6))	6	Deodorization filter (Deodorization Filter)

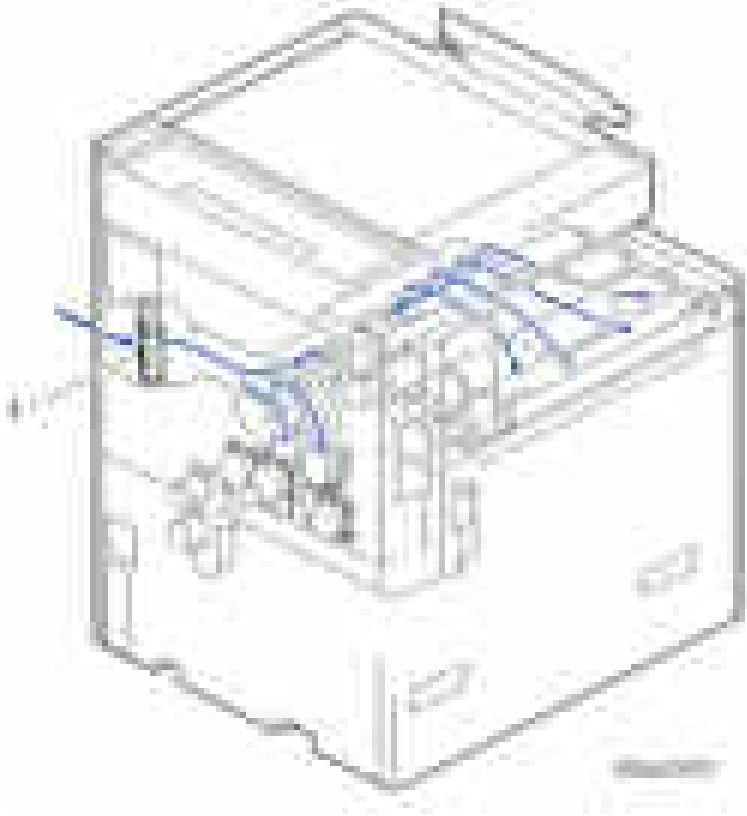
Imaging system (rear)

No.	Part name
1	Toner supply cooling fan (FAN5) (Toner Supply Cooling Fan (FAN5))

7.Detailed Descriptions

Electric system

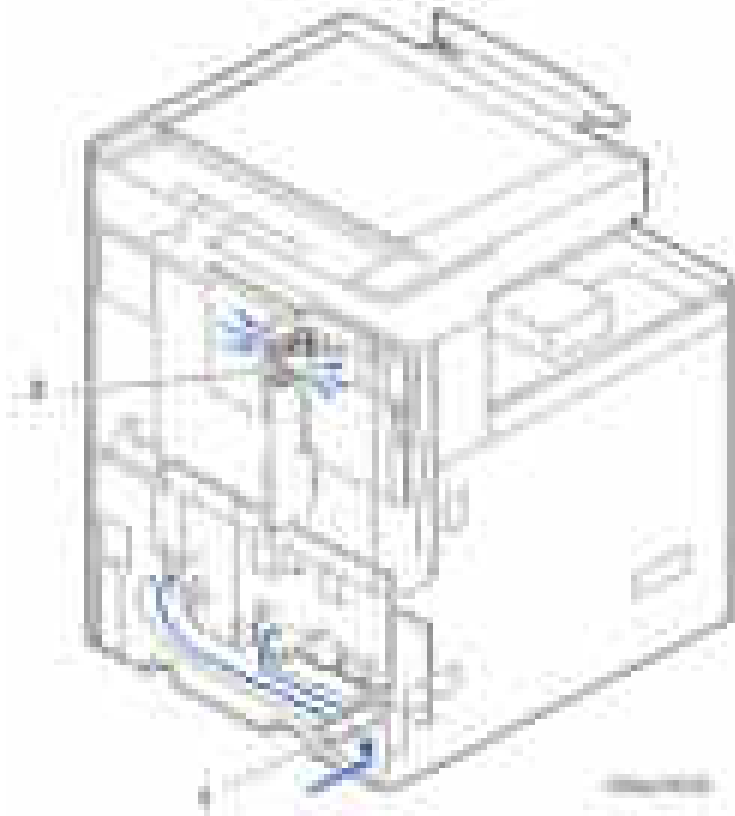

No.	Part name	No.	Part name
1	PSU cooling fan (FAN2) (PSU Cooling Fan (FAN2))	2	Controller box cooling fan (FAN4) (Controller Box Cooling Fan (FAN4))

Mechanism

By installing the duct corresponding to each fan, the air flow is efficiently controlled to a cooling target. Moreover, improvement in quietness and energy-saving efficiency is achieved by performing stepwise operation of the fan according to the imaging temperature.

Cooling of PSU

Air taken in by the PSU cooling fan (FAN2) is guided near the cooling target by the duct and is efficiently cooled.

Cooling of Toner Supply Parts

Air taken in with the toner supply cooling fan (FAN5) is guided to circulate around the toner bottle and is discharged from the side of the delivery tray to outside the machine. It is aimed to achieve heat insulation from the stack of paper to the toner bottle by reducing the melting point of the toner. Keep in mind that the shape of the duct differs in IM C4500/C5500/C6000 and IM C3500/C3000/C2500/C2000.

Cooling of PCDU Parts

By discharging air taken in from the development intake fan (FAN6) at the front, from the ozone exhaust fan (FAN3) at the rear, a uniform air flow is attained and efficient cooling is realized. Discharge of ozone and scattering of toner are prevented by installing the exhaust filter in front of the ozone exhaust fan (FAN3).

Cooling of Fusing Parts

Air taken in from the paper exit cooling fan (FAN7) at the front is discharged from the fusing exhaust fan (FAN1) at the rear to outside the machine. By cooling the paper immediately after fusing, not only cooling of the fusing exit sensor (S27) but also reduction of stored heat of the stacked paper and reduction of curl are realized. This also serves to prevent condensation on the paper discharge guide sheet. As a measure against odor, a deodorization filter is installed downstream from the fusing exhaust fan (FAN1).

Cooling of Actuator

Air taken in from the drive cooling fan (FAN9)* is discharged from the main exhaust fan (FAN8)* to outside the machine.

* IM C6000/C5500/C4500 only.

Cooling in Controller Box

Air is circulated by the controller box cooling fan (FAN4) installed in the controller box, preventing the temperature rise in the controller box.

Control when Temperature Rises in the Machine

In order to suppress excessive temperature rise in the machine and maintain equipment quality, an imaging temperature sensor (thermistor) (S33) [A] is installed in the machine. The imaging temperature sensor (thermistor) (S33) detects the inner temperature of the machine and controls cooling operation.



Overview of cooling operation in the machine

The temperature in the machine is detected during output and after output, and the interior of the machine is cooled by fan operation (stepwise operation of the fan, prolonged fan rotation after the

7.Detailed Descriptions

paper has passed through) according to the temperature inside the machine.

However, if the temperature inside the machine rises significantly due to passing a large volume of paper, in addition to the fan operation, the CPM is specified to control the temperature in the machine.

Cooling operation during output

Perform cooling operation under the following conditions.

Imaging temperature	- 34	34	35	36	37	38	40 ^{*1}
Fusing exhaust fan (FAN1)	☐	☐	☐	☐	☐	☐	☐
Ozone exhaust fan (FAN3)	20%	20%	30%	30%	40%	40%	40%
Toner supply cooling fan (FAN5)	-	-	-	☐	☐	☐	☐
Development intake fan (FAN6) ^{*3}	-	-	-	☐	☐	☐	☐
Drive cooling fan (FAN9)	-	-	-	☐	☐	☐	☐
Main exhaust fan (FAN8)	-	-	-	☐	☐	☐	☐
Paper exit cooling fan (FAN7) ^{*2}	☐	☐	☐	☐	☐	☐	☐
PSU cooling fan (FAN2) ^{*2}	☐	☐	☐	☐	☐	☐	☐
Controller box cooling fan (FAN4) ^{*2}	☐	☐	☐	☐	☐	☐	☐

* The operation start temperature can be modified by SP.

*1 If the imaging temperature reaches **39°C** (IM C6000/C5500/C4500), **41°C** (IM C3500/C3000/C2500/C2000) each fan will continue operating until it falls by 2°C.

*2 Operating condition:

- When the time interval from the previous job is less than 10 minutes. Or, when the time interval from the previous job is more than 10 minutes, and 5 minutes have elapsed from the start of the machine.

*3 Operating condition:

- For 36°C or above, full speed rotation at 24V
- For less than 36°C rotated at low speed with voltage reduced to 13V (rotating speed approximately 50%)
- Changes from the low-speed rotation to the full-speed rotation when printing continues for more than 5 minutes while the temperature inside the machine is 36°C or lower

Cooling operation after the output

Usually, after the output, the fan operation is suspended.

If the temperature in the machine after the output is high, fan rotation is continued after output to cool the interior of the machine.

Energy Save

Energy Saver Modes

Customers should use energy saving modes properly, to save energy and protect the environment.

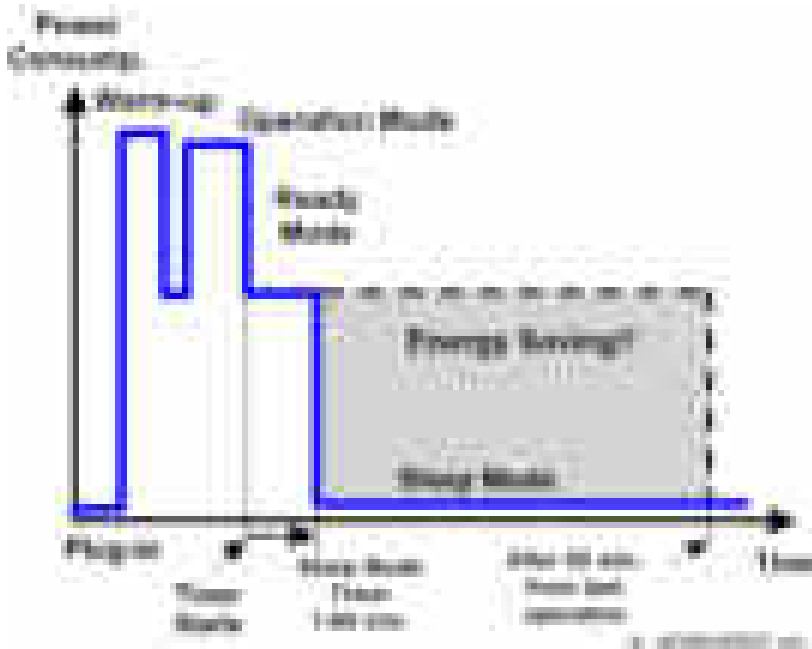

The area shaded grey in this diagram represents the amount of energy that is saved when the timers are at the default settings. For example, if the timers are all set to 60 min., the grey area will disappear, and no energy is saved before 60 min. expires.

Setting Items that are Related to Energy Saving

The user can set these timers with "Settings" menu (System settings > Timer setting)

Sleep Mode Timer

"Settings" menu (System settings > Timer setting)

After a specified period has passed, or [Energy Saver] is pressed, the machine enters Sleep mode in order to conserve energy. Specify the time to elapse before Sleep mode.

Default: [1 minute(s)]

Sleep Mode Timer may not work when error messages appear.

Depending on which Embedded Software Architecture application is installed on it, the machine might take longer than indicated to enter Sleep mode.

Fusing Unit Off Mode (Energy Saving) On/Off

"Settings" menu (System settings > Timer setting)

Specifies whether Fusing Unit Off mode is enabled or not.

When Fusing Unit Off mode is enabled, the display is on but the fusing unit is off to save energy.

The machine requires roughly the same time as the warm-up time to recover from Fusing Unit Off mode.

7.Detailed Descriptions

Default: [Off]

If [Fusing Unit Off Mode (Energy Saving) On/Off] is set to [On], you can specify when to exit Fusing Unit Off mode and the time to elapse before entering Fusing Unit Off mode.

If [Exit Fusing Unit Off Mode] is set to [On Printing], the machine exits Fusing Unit Off mode when printing is performed.

If [Exit Fusing Unit Off Mode] is set to [On Operating operation panel], the machine exits Fusing Unit Off mode when a key other than the copy function key is pressed on the operation panel of the machine.

If printing is performed with the copy function or a key in the copy function is pressed on the operation panel of the machine, the machine exits Fusing Unit Off mode regardless of this setting. If the timer is set to [On], you can set the time from 10 seconds to 240 minutes, using the number keys.

Energy Saving Recov. for Business Application

"Settings" menu (System settings > General Settings)

Specify whether or not to enable low-energy recovery from Sleep mode to use applications independent of the machine, such as Address Book Management or Browser.

Default: [Off]

If [On (Energy Saving)] is selected, it takes longer than usual to be ready to use the machine.

Recovery Time/Reduced Electrical Consumption

EU/AA

Model Name	Power Consumption	Time to Recover from Sleep Mode
IM C2000	0.55 W	6.1 seconds
IM C2500	0.55 W	6.1 seconds
IM C3000	0.55 W	6.0 seconds
IM C3500	0.55 W	6.0 seconds
IM C4500	0.62 W	7.0 seconds
IM C5500	0.62 W	8.1 seconds
IM C6000	0.62 W	8.1 seconds

NA

Model Name	Power Consumption	Time to Recover from Sleep Mode
IM C2000	0.54 W	6.6 seconds
IM C2500	0.54 W	6.6 seconds
IM C3000	0.53 W	6.3 seconds
IM C3500	0.53 W	6.3 seconds
IM C4500	0.59 W	6.3 seconds
IM C6000	0.59 W	7.9 seconds

Power States

- Depending on the operating environment and usage status, power consumption in Sleep mode might change. (Such cases as power change for fusing unit temperature control when in a low-temperature environment, or network environment obstructs switching to STR mode.)

Power States of this Machine

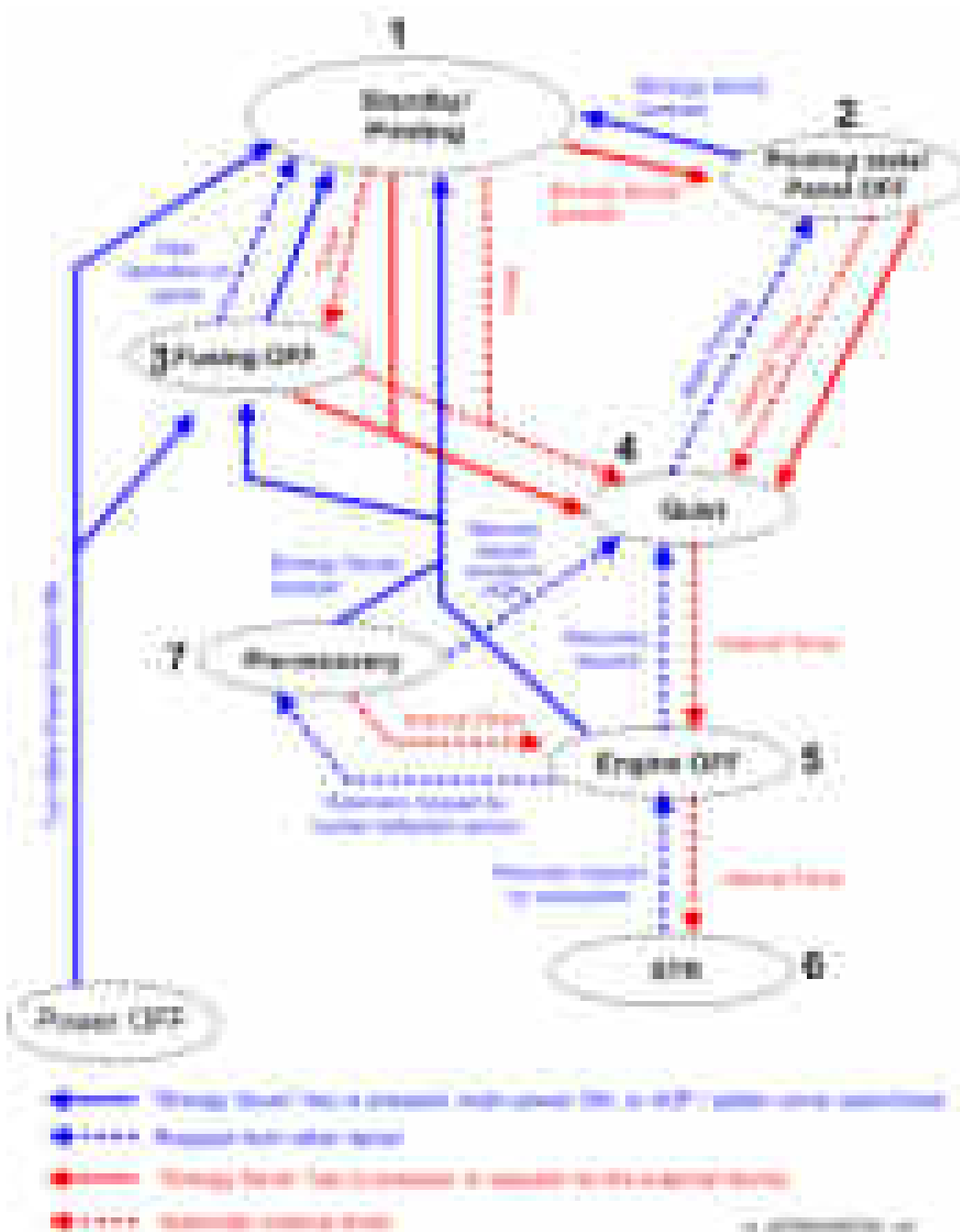

	State	Description
1	Standby/Printing	<ul style="list-style-type: none"> State where normal operation is possible after warm-up State during printing

7.Detailed Descriptions

	State	Description
2	Printing state/Panel OFF	State when printing with the backlight of the operation panel turned off
3	Fusing OFF	State where the Standby Fusing OFF state is entered when the time set with the " Fusing Unit Off Mode (Energy Saving) On/Off " setting of the Settings has elapsed. <ul style="list-style-type: none"> State where the operation panel is flashing and the fusing lamp is OFF. The bottom plate of the paper feed tray is raised.
4	Quiet state	Quiet state is entered when the Energy Saving key is pressed or the time set with the " Sleep Mode Timer " of the Settings has elapsed. This is a temporary energy saving state before entering sleep mode. <ul style="list-style-type: none"> Basically, no homing (initialization) of peripheral devices is performed. The bottom plate of the paper feed tray is raised. The fusing lamp is turned OFF.
5	Engine OFF (Sleep mode)	Entered from Quiet state with the internal timer. <ul style="list-style-type: none"> The relevant power systems (24V, 12V, 5V) are turned OFF at the same time as the fusing lamp. When receiving a fax or printing is performed in engine OFF state, the warm-up is started and printing is performed while the backlight of the operation panel is turned OFF.
6	STR state (Sleep mode)	Supplying of power and clock to the CPU and peripheral chips on the controller board is stopped.
7	Pre-recovery	The Pre-recovery state is entered from STR state when the Proximity Sensor (S49) detects the presence of a person. This is the Energy Saving state where the power of the operation panel and HDD is ON and the power of the engine is OFF, but the backlight of the operation panel LCD is off.

Device state for each Energy Saving state

State	Energy Saving LED	Operation panel LCD	Engine (Printer/Scanner)	HDD	CTL
Standby/Printing	ON	ON	ON	ON	ON
Printing state/Panel OFF	ON	OFF	ON (Only scanner is in Quiet state)	ON	ON
fusing OFF	ON	ON	ON (Both printer/scanner are in Quiet state)	ON	ON
Quiet state	ON	OFF	ON	ON	ON

State	Energy Saving LED	Operation panel LCD	Engine (Printer/Scanner)	HDD	CTL
		ON*1	(Both printer/scanner are in Quiet state)		
Engine OFF	Blinking gradually ON*1	Sleep OFF or ON*1	OFF	OFF ON*1	ON
STR state	Blinking gradually	Sleep	OFF	OFF	STR
Pre-recovery	ON	OFF ON*1	OFF	ON	ON

*1 When [Energy Saving Recvry. for Business Application.] is [On (Energy Saving)], ON/OFF is determined by the internal timer of the Smart Operation Panel.

The transition of the operation panel to Energy Saving when [Energy Saving Recov. for Business Application] is [On (Energy Saving)]

Normally, the Energy Saving state of the operation panel LCD changes in step with the energy saving state of the MFP/LP main machine, but to support the scenario where an application that does not use the engine (printer/scanner) is executed from the operation panel, the Energy Saving state of the operation panel is transitioned through the three states ON, OFF, and Sleep with its internal timer when [Energy Saving Recov. for Business Application.] is [On (Energy Saving)].

Verification of Up Time for each Energy Saving State

The up time for each power state of the machine can be checked with SP8-961 (Electricity Status). It is also output on the SMC sheet.

SP	Name	Description
SP8-961-001	Ctrl Standby Time	Cumulative time of Engine OFF mode, Quiet mode, and Standby mode
SP8-961-002	STR Time	Cumulative time of STR mode
SP8-961-003	Main Power Off Time	Cumulative time of state in which the power plug is connected to the outlet but the main power is off
SP8-961-004	Reading and Printing Time	Cumulative time of state in which both the plotter engine and scanner engine are running or warming up
SP8-961-005	Printing Time	Cumulative time of the state in which the plotter engine is running
SP8-961-	Reading Time	Cumulative time of the state in which the scanner engine is running

7.Detailed Descriptions

SP	Name	Description
006		
SP8-961-007	Eng Waiting Time	Cumulative time of state in which the power state of the engine is Standby state
SP8-961-008	Low Power State Time	Not used for this machine
SP8-961-009	Quiet State Time	Cumulative time of the state in which the power state of the engine is Quiet state
SP8-961-010	Heater Off State Time	Cumulative time of the state in which the power state of the engine is Fusing OFF state
SP8-961-011	LCD on Time	Cumulative time of the state in which the backlight of the LCD is on.

Checking the Up time by Device State

SP 8941 (Machine Status) keeps a record of the amount of time that the machine spends in each mode.

SP8-941-001	Operation Time	Cumulative time of the state in which the engine state notification is enabled. The state in which the engine is not running (such as when storing to HD only with the controller) is excluded from the running state.
SP8-941-002	Standby Time	Cumulative time of the state in which the engine state is not running.
SP8-941-003	Low Power Time	Not used for this machine
SP8-941-004	Sleep mode time	Cumulative time in Sleep Mode state.
SP8-941-005	Off Mode Time	Cumulative time in which the Energy Saving state of the device is Engine OFF state.
SP8-941-006 to 009	Down time	Cumulative time in which the device is disabled because itself or its component is in the following state. <ul style="list-style-type: none"> • SP8-941-006: SC (excluding mode SC) • SP8-941-007: Jam (plotter) • SP8-941-008: Jam (scanner) • SP8-941-009: Supply/PM unit end

With this data, and the power consumption values from the specifications, we can estimate the amount of energy that is used by the machine.

This should only be used as a reference value, because the power consumption specifications are

measured in a controlled environment with a constant power supply.

To get an exact measurement at the customer's site, a watt meter must be used to measure the actual energy consumed.

To use SP8941 to calculate the energy consumed:

- At the start of the measurement period, read the values of SP8-941-001 to 005.
- At the end of the measurement period, read the values of SP8-941-001 to 005 again.
- Find the amount of time spent in each mode (subtract the earlier measurement from the later measurement).
- Multiply this by the power consumption spec for each mode.
- Convert the result to kWh (kilowatt hours)

Recommendation

We recommend that the default settings related to energy saving should be kept.

- If the customer requests that these settings should be changed, please explain that their energy costs could increase, and that they should consider the effects on the environment of extra energy use.

New Functions

PS3/PDF Direct Emulation (Clone PS)

Overview

This machine is equipped with a clone program for emulating Adobe PostScript/PDF (hereafter “Clone PS”) as a standard feature. So, by default, it can perform printing using PostScript 3 and PDF Direct Print, in addition to RPCS.

- **What is Clone PS?**

Based on the specifications of PostScript/PDF languages developed by Adobe, clone programs for interpretation of PostScript and PDF documents have been created by various companies other than Adobe. While the original program sold by the developer of the language is named Adobe PS, compatible programs made by other manufacturers are called clones. Strictly speaking, these clones must be fully compatible with the original program; however, they are called clones even if they have some differences because they cannot completely imitate the original.

Clone PS is basically designed to perform similar functions to Adobe PS, except for several differences such as the inability to use Adobe fonts.

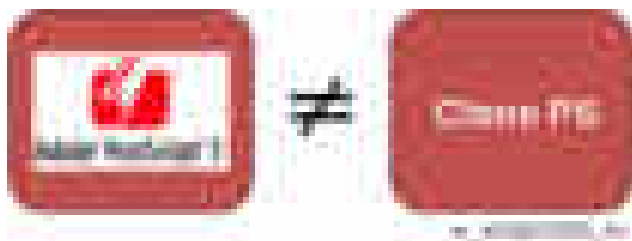

- Adobe PS, previously offered as an optional product for past models, is available again as an option. (SD card option.)
- Clone PS and Adobe PS cannot be run simultaneously.
- The same printer driver can be used for Clone PS and Adobe PS.
- Clone PS emulates Adobe PostScript 3 version 3017. (The version of Adobe PS used in the SD card option is v. 3018.)
- For the PDF Direct Print function, Clone PS emulates Adobe PDF version 1.7.

How to Distinguish Adobe PS from Clone PS

In the operation panel screen, it is difficult to tell whether Adobe PS or Clone PS is in use.

Both “PS3” and “PDF” are shown on the screen, regardless of whether Adobe PS or Clone PS is used.

Identification can be done as follows:

- **Configuration Page**

The description of the Firmware Version listed on the page varies as shown below:

PS type	Description of Firmware Version
Adobe PS	RPCS [x.xx.xx] Adobe PostScript 3 [x.xx], Adobe PDF [x.xx]
Clone PS	RPCS [x.xx.xx] PS3 [x.xx], PDF [x.xx]

The manufacturer's name "Adobe" is shown in the list if Adobe PS is used.

- **Configuration Page**

The description of the Firmware Version listed on the page varies as shown below:



- **Web Image Monitor**

Go to Status/Information > Device Info, and open the Printer Language menu.

If Adobe PS is used, the screen shows the program name "Adobe PostScript 3" and "Adobe PDF".



- **Operation Panel: Firmware Version**

Settings > Machine Features Settings > System Settings > Administrator Tools > Firmware Version

When PostScript3 Unit Type M33 (Adobe PS) is installed:

7.Detailed Descriptions

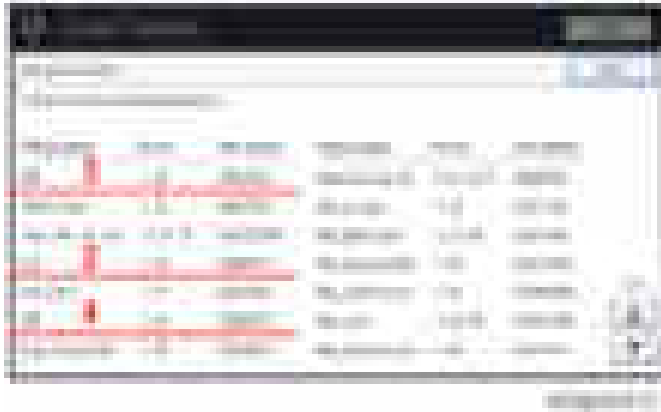
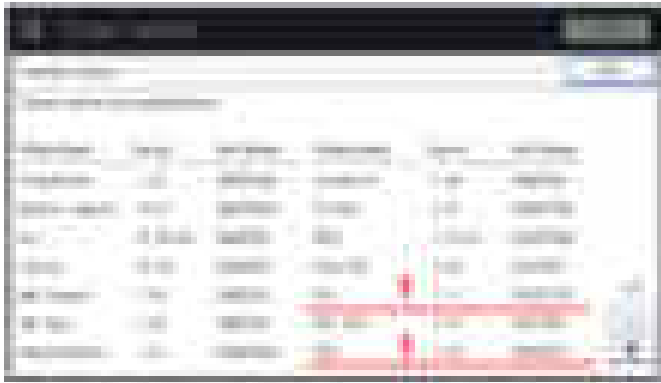

When Clone PS only:

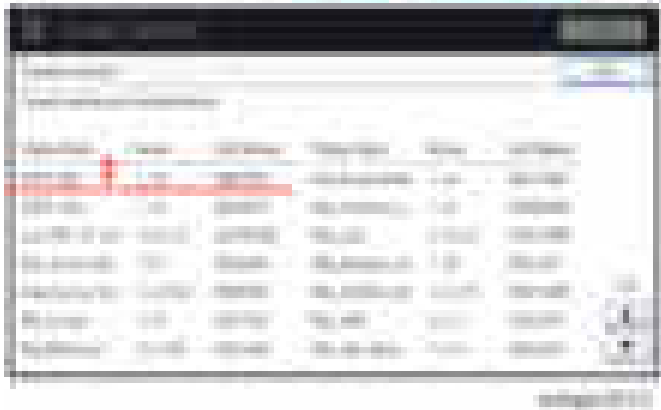
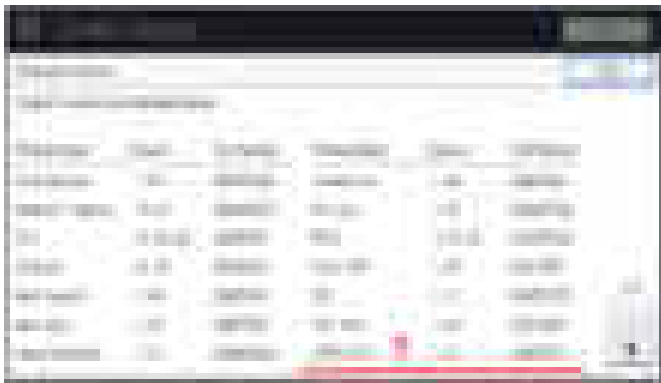

No.	Module Name	Description
1	PS3 / IRIPS PS3	The Clone PS firmware number appears. The clone PS firmware number starts with "D0AF". I

No.	Module Name	Description
2	PS3	The Adobe PS firmware number starts with "D3BD" appears. This module name appears in the firmware list only if PostScript3 Unit Type M37 is installed.
3	PDF / IRIPS PDF	The Clone PS firmware number appears. The clone PS firmware number starts with "D0AF".
4	PDF	The Adobe PS firmware number starts with "D3BD". This module name appears in the firmware list only if PostScript3 Unit Type M37 is installed.

- **Font Change Confirmation screen**

The "Font Change Confirmation" screen is accessible only when Clone PS is used.

On the Home screen, select the Settings icon > Machine Features Settings > Printer Settings > PS Menu > Font Change Confirmation.



Difference in Device Fonts

The variety and number of built-in fonts (device fonts) differ between Adobe PS and Clone PS.

PS type	Number of European fonts
Adobe PS	136 fonts
Clone PS	93 fonts

For license reasons, the device fonts for Adobe PS cannot be handled by Clone PS. Instead, Clone PS is equipped with fonts similar to Adobe device fonts under different names; when an Adobe PS font is specified in the data to be printed, Clone PS will replace it with a similar font.

Use of a substitute font sometimes leads to different printing results, as shown in the table below.



Example 1

PS type	Helvetica
Adobe PS	



7.Detailed Descriptions

PS type	Helvetica
Clone PS	
	When Helvetica is used in the original document, Clone PS applies a substitute font named NimbusSans-Regular, maintaining almost the same appearance as the original data.

Example 2

PS type	LetterGothic
Adobe PS	
Clone PS	
	When LetterGothic is originally used, Clone PS substitutes it with LetterGothic-Regular. In this case, the character spacing differs from that in the original data.

Example 3

PS type	Chicago
Adobe PS	
Clone PS	
	Clone PS does not support alternative fonts for Chicago; instead, the Courier font (*) is used. (The font shape differs significantly from Chicago.) * Since Courier itself is named among the Adobe PS device fonts, Clone PS substitutes it with an alternative font, NimbusMonoPS-Regular.

Font Change Confirmation Screen

Clone PS itself incorporates no Adobe fonts in it, and therefore replaces them with similar fonts when Adobe PS fonts are specified in the print data output to the printer.

However, there is a possibility that a substitute font not desired by the customer may be used; to cope with this issue, the operation panel shows a confirmation screen whenever an Adobe font is to be replaced by a similar font.

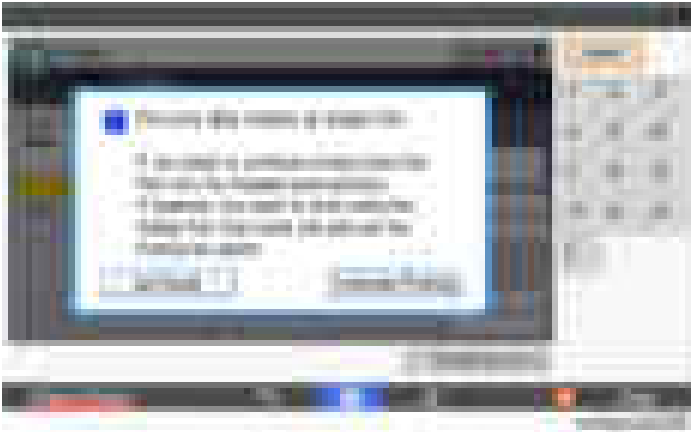

If the customer often prints data containing Adobe fonts that are almost the same in terms of spacing and shape as their substitutes, the confirmation screen appears every time printing is performed, making the printing operation cumbersome. In such a case, the font change confirmation screen can be hidden.

- "Settings" icon on Home screen > Machine Features Settings > Printer Settings > PS Menu > Font Change Confirmation

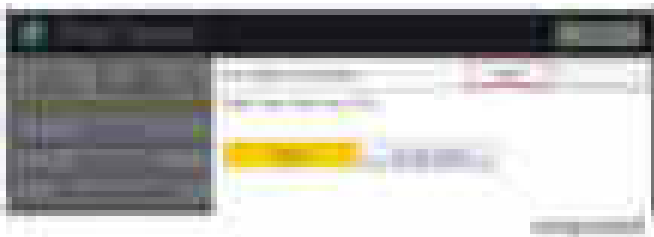

List of fonts and their replacements (Adobe PS -> Clone PS)

No.	Adobe PS	Clone PS
1	Courier	NimbusMonoPS-Regular
2	Courier-Bold	NimbusMonoPS-Bold
3	Courier-BoldOblique	NimbusMonoPS-BoldItalic
4	Courier-Oblique	NimbusMonoPS-Italic
5	Helvetica	NimbusSans-Regular
6	Helvetica-Bold	NimbusSans-Bold
7	Helvetica-BoldOblique	NimbusSans-BoldOblique
8	Helvetica-Oblique	NimbusSans-Oblique
9	Symbol	StandardSymL
10	Times-Bold	NimbusRoman-Bold
11	Times-BoldItalic	NimbusRoman-BoldItalic
12	Times-Italic	NimbusRoman-Italic
13	Times-Roman	NimbusRoman-Regular
14	AlbertusMT	NimbusMonoPS-Regular
15	AlbertusMT-Italic	NimbusMonoPS-Regular

7.Detailed Descriptions

16	AlbertusMT-Light	NimbusMonoPS-Regular
17	AntiqueOlive-Roman	NimbusMonoPS-Regular
18	AntiqueOlive-Italic	AntiqueOlive-Italic
19	AntiqueOlive-Bold	AntiqueOlive-Bold
20	AntiqueOlive-Compact	NimbusMonoPS-Regular
22	Apple-Chancery	NimbusMonoPS-Regular
22	ArialMT	NimbusSansNo2-Regular
23	Arial-ItalicMT	NimbusSansNo2-Italic
24	Arial-BoldMT	NimbusSansNo2-Bold
25	Arial-BoldItalicMT	NimbusSansNo2-BoldItalic
26	AvantGarde-Book	URWGothic-Book
27	AvantGarde-BookOblique	URWGothic-BookOblique
28	AvantGarde-Demi	URWGothic-Demi
29	AvantGarde-DemiOblique	URWGothic-DemiOblique
30	Bodoni	NimbusMonoPS-Regular
31	Bodoni-Italic	NimbusMonoPS-Regular
32	Bodoni-Bold	NimbusMonoPS-Regular
33	Bodoni-BoldItalic	NimbusMonoPS-Regular
34	Bodoni-Poster	NimbusMonoPS-Regular
35	Bodoni-PosterCompressed	NimbusMonoPS-Regular
36	Bookman-Light	URWBookman-Light
37	Bookman-LightItalic	URWBookman-LightItalic
38	Bookman-Demi	URWBookman-Demi
39	Bookman-DemiItalic	URWBookman-DemiItalic
40	Carta	NimbusMonoPS-Regular
41	Chicago	NimbusMonoPS-Regular
42	Clarendon	NimbusMonoPS-Regular
43	Clarendon-Light	NimbusMonoPS-Regular
44	Clarendon-Bold	NimbusMonoPS-Regular
45	CooperBlack	NimbusMonoPS-Regular
46	CooperBlack-Italic	NimbusMonoPS-Regular
47	Copperplate-ThirtyTwoBC	NimbusMonoPS-Regular
48	Copperplate-ThirtyThreeBC	NimbusMonoPS-Regular
49	Coronet-Regular	NimbusMonoPS-Regular
50	Eurostile	NimbusMonoPS-Regular
51	Eurostile-Bold	NimbusMonoPS-Regular
52	Eurostile-ExtendedTwo	NimbusMonoPS-Regular
53	Eurostile-BoldExtendedTwo	NimbusMonoPS-Regular

7.Detailed Descriptions

54	Geneva	NimbusMonoPS-Regular
55	GillSans	NimbusMonoPS-Regular
56	GillSans-Italic	NimbusMonoPS-Regular
57	GillSans-Bold	NimbusMonoPS-Regular
58	GillSans-BoldItalic	NimbusMonoPS-Regular
59	GillSans-Condensed	NimbusMonoPS-Regular
60	GillSans-BoldCondensed	NimbusMonoPS-Regular
61	GillSans-Light	NimbusMonoPS-Regular
62	GillSans-LightItalic	NimbusMonoPS-Regular
63	GillSans-ExtraBold	NimbusMonoPS-Regular
64	Goudy	NimbusMonoPS-Regular
65	Goudy-Italic	NimbusMonoPS-Regular
66	Goudy-Bold	NimbusMonoPS-Regular
67	Goudy-BoldItalic	NimbusMonoPS-Regular
68	Goudy-ExtraBold	NimbusMonoPS-Regular
69	Helvetica-Condensed	NimbusMonoPS-Regular
70	Helvetica-Condensed-Oblique	NimbusMonoPS-Regular
71	Helvetica-Condensed-Bold	NimbusMonoPS-Regular
72	Helvetica-Condensed-BoldObl	NimbusMonoPS-Regular
73	Helvetica-Narrow	NimbusSansNarrow-Regular
74	Helvetica-Narrow-Oblique	NimbusSansNarrow-Oblique
75	Helvetica-Narrow-Bold	NimbusSansNarrow-Bold
76	Helvetica-Narrow-BoldOblique	NimbusSansNarrow-BoldOblique
77	HoeflerText-Regular	NimbusMonoPS-Regular
78	HoeflerText-Italic	NimbusMonoPS-Regular
79	HoeflerText-Black	NimbusMonoPS-Regular
80	HoeflerText-BlackItalic	NimbusMonoPS-Regular
81	HoeflerText-Ornaments	NimbusMonoPS-Regular
82	JoannaMT	NimbusMonoPS-Regular
83	JoannaMT-Italic	NimbusMonoPS-Regular
84	JoannaMT-Bold	NimbusMonoPS-Regular
85	JoannaMT-BoldItalic	NimbusMonoPS-Regular
86	LetterGothic	LetterGothic-Regular
87	LetterGothic-Slanted	NimbusMonoPS-Regular
88	LetterGothic-Bold	LetterGothic-Bold
89	LetterGothic-BoldSlanted	NimbusMonoPS-Regular
90	LubalinGraph-Book	NimbusMonoPS-Regular
91	LubalinGraph-BookOblique	NimbusMonoPS-Regular

7.Detailed Descriptions

92	LubalinGraph-Demi	NimbusMonoPS-Regular
93	LubalinGraph-DemiOblique	NimbusMonoPS-Regular
94	Marigold	Mauritius-Regular
95	Monaco	NimbusMonoPS-Regular
96	MonaLisa-Recut	NimbusMonoPS-Regular
97	NewCenturySchlbk-Roman	URWCenturySchoolbook-Roman
98	NewCenturySchlbk-Italic	URWCenturySchoolbook-Italic
99	NewCenturySchlbk-Bold	URWCenturySchoolbook-Bold
100	NewCenturySchlbk-BoldItalic	URWCenturySchoolbook-BdIta
101	NewYork	NimbusMonoPS-Regular
102	Optima	NimbusMonoPS-Regular
103	Optima-Italic	NimbusMonoPS-Regular
104	Optima-Bold	NimbusMonoPS-Regular
105	Optima-BoldItalic	NimbusMonoPS-Regular
106	Oxford	NimbusMonoPS-Regular
107	Palatino-Roman	Palladio-Roman
108	Palatino-Italic	Palladio-Italic
109	Palatino-Bold	Palladio-Bold
110	Palatino-BoldItalic	Palladio-BoldItalic
111	StempelGaramond-Roman	NimbusMonoPS-Regular
112	StempelGaramond-Italic	NimbusMonoPS-Regular
113	StempelGaramond-Bold	NimbusMonoPS-Regular
114	StempelGaramond-BoldItalic	NimbusMonoPS-Regular
115	Tekton	NimbusMonoPS-Regular
116	TimesNewRomanPSMT	NimbusRomanNo9-Regular
117	TimesNewRomanPS-ItalicMT	NimbusRomanNo9-Italic
118	TimesNewRomanPS-BoldMT	NimbusRomanNo9-Bold
119	TimesNewRomanPS-BoldItalicMT	NimbusRomanNo9-BoldItalic
120	Univers	NimbusMonoPS-Regular
121	Univers-Oblique	NimbusMonoPS-Regular
122	Univers-Bold	URWClassicSans-Bold
123	Univers-BoldOblique	NimbusMonoPS-Regular
124	Univers-Light	NimbusMonoPS-Regular
125	Univers-LightOblique	NimbusMonoPS-Regular
126	Univers-Condensed	NimbusMonoPS-Regular
127	Univers-CondensedOblique	NimbusMonoPS-Regular
128	Univers-CondensedBold	NimbusMonoPS-Regular
129	Univers-CondensedBoldOblique	NimbusMonoPS-Regular

130	Univers-Extended	NimbusMonoPS-Regular
131	Univers-ExtendedObl	NimbusMonoPS-Regular
132	Univers-BoldExt	NimbusMonoPS-Regular
133	Univers-BoldExtObl	NimbusMonoPS-Regular
134	Wingdings-Regular	URWDingbats
135	ZapfChancery-MediumItalic	URWChancery-MediumItalic
136	ZapfDingbats	Dingbats

Differences in Driver Functions

As shown below, there are differences in available driver functions between Adobe PS and Clone PS.

1. **Font Substitution Table (Applicable only to the driver for Windows OS)**

Start > Device and Printer > Printer Properties > Device Settings

For Clone PS, the Font Substitution Table under the Device Settings menu will not be displayed.

Clone PS has font substitution table data similar to that of Adobe PS and performs font replacement as appropriate.

To disable font replacement, go to Printing Preferences > Detailed Settings > "Print Quality: Option" > "True Type Font:" option, and select "Download as SoftFont".



2. **Fonts used for unauthorized copy prevention (Common to drivers for Windows OS and Mac OS X)**

The watermark text used for unauthorized copy prevention consists of a device font. The range of available fonts varies between Adobe PS and Clone PS because of the difference in available device fonts.

Adobe PS provides a choice from 136 fonts while 3 fonts are selectable for Clone PS.

7.Detailed Descriptions



3. "User Setting" for dithering (Common to drivers for Windows OS and Mac OS X)

Clone PS ignores the "User Setting" option for dithering and performs dithering in the same manner as when the "Automatic" setting (*) is selected.

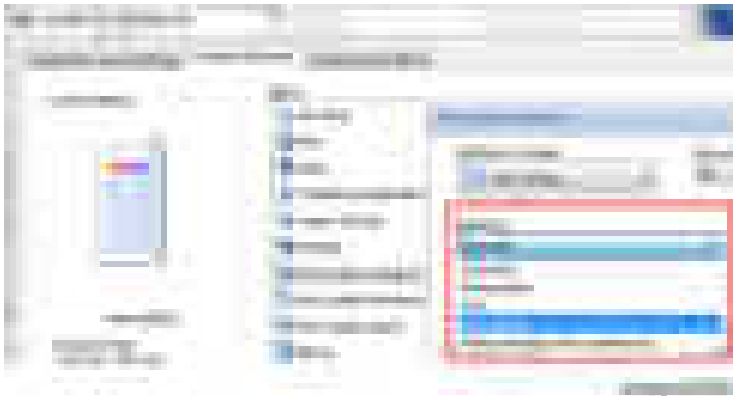

* "Text Priority" is selected for text, and "Photo" for graphics and images.

In the driver menu for Mac OS X, the "User Setting" option is shown at half brightness and cannot be selected.

Bypass Tray Assist Function

Refer to [Bypass Tray Assist Function](#).

Web Help Support

Refer to ["Web Help Support" Settings](#).

Displaying an Alert When the Ethernet Cable is Broken or Disconnected

Refer to [Settings on Displaying an Alert When the Ethernet Cable is Broken or Disconnected](#).

"RemoteConnect Support" and "Remote Panel Operation"

Refer to the following pages:

- ["RemoteConnect Support" Settings](#)
- ["Remote Panel Operation" Settings](#)

Copy: Shiny Materials Mode

The short-focus scanner of the previous model (Met-C2) has been adopted. The luminance of the original was maintained by reducing the depthwise illuminance distribution, but the quantity of irradiation light on the background when copying three-dimensional objects was lower than the model (Met-C1) before the previous model, resulting in a relatively dark image.

This model features the Shiny Materials mode to reduce the darkening of the background when copying metal or other three-dimensional materials.

Select Original Setting > Original Type > Shiny Materials.



Other Functions

Proximity Sensor

Overview

The proximity sensor is located on the right upper corner of the main machine.



When the machine has been idle for a long period and the proximity sensor detects the presence of anyone in front of the machine, it signals the machine to prepare itself for quick recovery to operation status by shortening the time required for the machine to recover full operation (pre-recovery mode) before the operator even touches the machine or operation panel. The proximity sensor employs infrared and can detect the presence of the operator within an arc of 150° out to 1.8 m (6 ft.) away from the front of the machine.

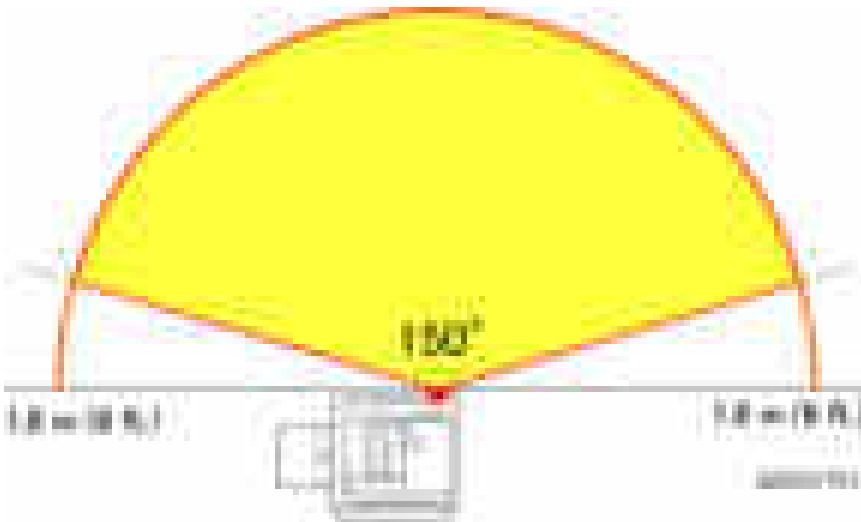

The following diagram shows the image of the area covered by the sensor on the floor.

Basically, the sensor detects the presence of an operator coming to the machine from a distance of approximately 1.8 m. However, it may also detect the presence of someone walking across the area. The infrared sensor's detection performance is influenced by the ambient temperature. The sensing

distance increases in a lower ambient temperature and decreases in a higher ambient temperature. As a guide, the sensing distance starts decreasing from 1.8 m when the ambient temperature starts rising to 28 °C and above.

The sensor covers the area in front of the machine obliquely downward, detecting people's legs (around their knees). Its sensing performance is influenced by the kind of clothes such people are wearing.

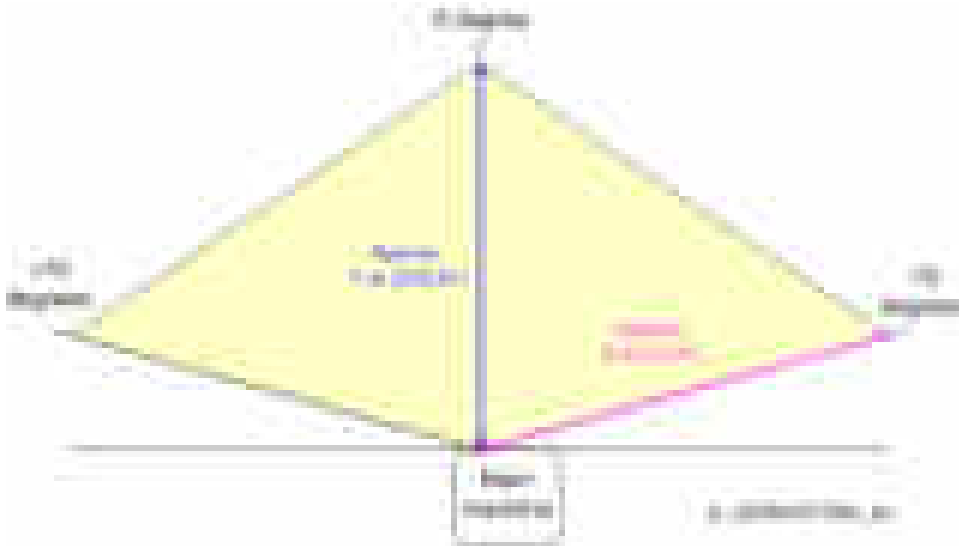

Sensor Operation

There are three phases in the operation of the proximity sensor:

1. First, the sensor detects the presence of the operator within the arc in front of the machine and then signals the machine to leave the STR mode (or Engine OFF mode) and enter the Pre-recovery mode.
2. Second, as soon as the machine enters the Pre-recovery mode it resets the Engine Off mode timer for 5 min. If the operator does not touch the machine for 5 minutes, the machine slips back into the Engine Off mode. If the operator touches the LCD, or opens and closes the ADF or front door, etc., the machine shifts to Standby mode.
3. Third, once the machine enters Standby mode, if the operator does nothing to start operation, the machine will gradually step down from Standby mode to Lower Energy mode, Quiet mode, Engine Off mode, and then finally to STR mode.

Operation Modes

Here are more details about these operation mode levels.

- **STR mode.** Suspend-to-RAM mode. The power supplied to the CPU, adjacent chips, and the clock on the controller board is shut down.
- **Engine Off mode.** The fusing lamps and other engine components remain off. The operation panel backlight is off, but there is power supplied to the operation panel and the controller boards.
- **Pre-recovery mode.** The operation panel and HDD are on but the engine components remain off (Energy Save mode). However, the operation backlight still remains off, so there is no change on

7.Detailed Descriptions

the operation panel to indicate that the machine has shifted from STR mode, through Engine Off mode, and into the Pre-recovery mode.

- **Quiet mode.** Fusing lamps still remain off, but the HDD and SD cards are accessible, so the machine can receive jobs (Data In) and incoming faxes.
- **Lower Power mode.** Finally, power is restored to the fusing lamps but maintained at a low temperature.
- **Standby mode.** The machine is ready to operate.

UP Setting

The operation of the proximity sensor can be switched off and on with User Tool settings.

1. Touch "Settings" icon on the operation panel.
2. Select System Settings > General Settings > Human Detection Sensor
3. You can switch the sensor off/on by selected Disabled/Enabled. The default setting is "Enabled".

Related SC Codes

One of two SC codes is issued if the proximity sensor fails.

SC869-01 Proximity sensor failure: Error 1.

The sensor remained on for over 480 hours.

- Power cycling the machine off/on does not fix this error.
- When this error occurs the machine enters sensor failure mode and ignores subsequent input from the proximity sensor.
- Even though the sensor is on, the machine does not enter Pre-recovery mode, and the Engine Off timer setting is not affected and continues to operate normally.
- To fix this error, switch off the proximity sensor with the "Settings" menu described in the previous section.
- The sensor and its components require replacement.

SC869-02 Proximity sensor failure: Error 2

The sensor remained off, even after the operator performed 300 actions with the machine operation panel, opening and closing the front door, ADF, etc. The machine will issue this error code after every 300 events in operation of the machine.

- Power cycling the machine off/on does not fix this error.
- To fix this error, switch off the proximity sensor with the "Settings" menu described in the previous section.
- The sensor and its components require replacement.

Related SP Code

There is one proximity sensor related SP code: SP5102-203 Auto Detect: human detection check. This is an on/off check.

- Enter "0" to switch the sensor off.
- Enter "1" to switch the sensor on.

This SP is used to check the operation of the sensor. It confirms that the sensor can be switched off and on normally. (Default: On). This check can be used regardless of the User Tool settings. Even if the sensor is switched off with the User Tool settings, it can be checked with this SP code.

10 Second Recovery from Sleep Mode

Some previous machines took more than 10 seconds to print the first sheet to the finisher tray from sleep mode. This machine can reduce the time to print the first sheet to the finisher tray by reducing the productivity at startup.

[Reference] Measurements on Previous Machine (Met-C1)

Destination	Machine Model	CPM	Full System (First Print time from Sleep Mode to Finisher Tray)
NA	MP C6003	60 cpm	1. sec.

By setting [Output Priority When Paper is Fed to Finisher] in "Settings" menu to [Print Start Time], the productivity at recovery time is adjusted as follows and the time to start printing is kept within 10 seconds.

IM C6000 specification

Start time from sleep mode	Continuous print speed priority	Print start time priority
Up to 4 seconds	60cpm	50cpm
5 to 8 seconds	60cpm	55cpm
9 seconds or more	60cpm	60cpm

- 1.** Press [Settings] icon > [Machine Features Settings] > [System Settings] > [General Settings] > [Output Priority When Paper is Fed to Finisher].
- 2.** Set to [Print Start Time].

Improving the Print Start Time under Low Temperature, Low Humidity, or at Low Voltage

In this machine, there are SP to reduce the initial productivity in order to speed up the print time even under low temperature, low humidity, or low voltage conditions in which the print start tends to be delayed. When these functions are enabled, the first sheet printing time is reduced with initial productivity equivalent to "Print Start Time" in "Output Priority When Paper is Fed to Finisher".

- SP1-120-001 (Recovery mode SW:Low Temp)ON [1] / OFF[0]
- SP1-120-002 (Recovery mode SW:Voltage:Low) ON [1] / OFF[0]

Improving the Throughput at the Start of Printing, under Low Temperature, or at Low Voltage

- SP1-124-210 (CPM Down Setting: Temp.:Threshold: Low Power)
- SP1-114-002 (Heat Storage Status: Temp.Threshold: Atmosphere)

This SP above sense the temperature of the fusing unit according to the temperature of the parts inside the unit. When the temperature of the parts reaches the value on this SP, the machine assesses that the fusing unit is warm enough and the function to improve the throughput is automatically turned off. Decreasing this threshold value causes risk of "Fusing Offset".

7.Detailed Descriptions

To increase the printing start timing / initial CPM, keep decreasing the corresponding SP value by 5°C while checking fusibility.

* You can also increase the speed to start printing by changing the SP1-102 (Feed Permit Setting) value. However, to change both the time to start printing and initial CPM, change the abovementioned SP value.

8. Smart Operation Panel G2.5

Replacement and Adjustment

LCD

- 1.** Remove the operation panel unit. (Refer to "Operation Panel (PCB13)", "Replacement and Adjustment" in Main Chapters.)
- 2.** Remove the main controller board ([Main Controller Board](#)).
- 3.** Remove the connector of the LCD I/F cable [A].



Lift the fastener of the LCD I/F cable [A].



8.Smart Operation Panel G2.5

4. Remove the LCD unit [A].



5. Remove the LCD [A].



6. Check

- After replacing the LCD, perform the following checks.
 - LCD Check ([LCD Check](#))
 - TouchPanel Check ([TouchPanel Check](#))
- Perform "TouchPanel Calibration" ([TouchPanel Calibration](#)) and "MultiTouch Calibration" ([MultiTouch Calibration](#)) of the Self Check function.

Microphone

1. Remove the operation panel unit. (Refer to "Operation Panel (PCB13)", "Replacement and Adjustment" in Main Chapters.)
2. Remove the main controller board ([Main Controller Board](#)).
3. Remove the LCD unit ([LCD](#)).

- 4.** Remove the microphone [A].

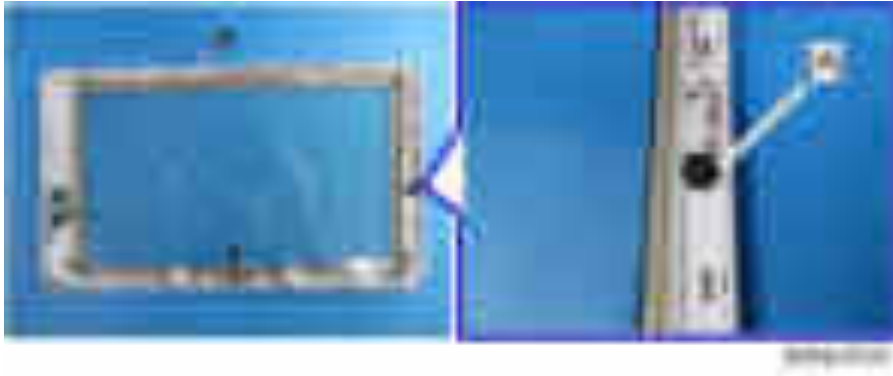

Wi-Fi Module

- 1.** Remove the operation panel unit. (Refer to "Operation Panel (PCB13)", "Replacement and Adjustment" in Main Chapters.)
- 2.** Remove the base bracket ([Main Controller Board](#)).
- 3.** Remove the Wi-Fi module [A].



- After replacing the Wi-Fi module, perform the following checks:
 - Wireless LAN Check ([Wireless LAN Check](#))
 - Bluetooth Check ([Bluetooth Check](#))

Speaker

- 1.** Remove the operation panel unit. (Refer to "Operation Panel (PCB13)", "Replacement and Adjustment" in Main Chapters.)
- 2.** Remove the bottom cover ([Main Controller Board](#)).

8.Smart Operation Panel G2.5

3. Remove the speaker [A] together with the speaker holder.



4. Remove the speaker [A] from the speaker holder [B].



• Note

- After replacing the speaker, perform the following check.
 - Speaker Check ([Speaker Check](#))

Main Controller Board

1. Remove the operation panel unit. (Refer to "Operation Panel (PCB13)", "Replacement and Adjustment" in Main Chapters.)
2. Remove the bottom cover [A] (■×4).

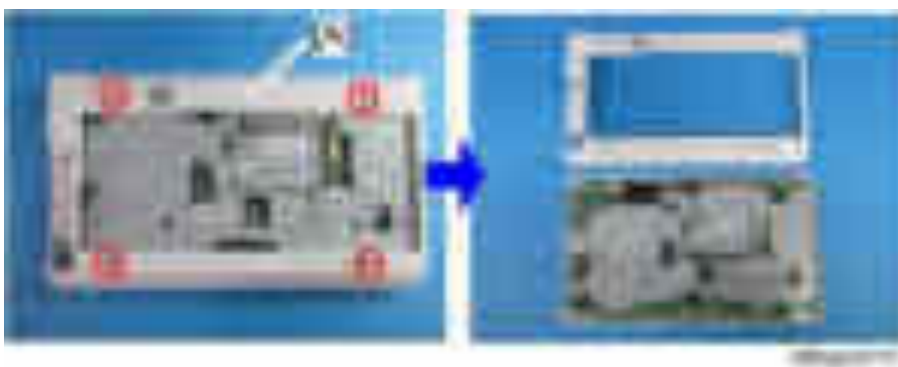

• Note

- There are ten hooks inside the operation panel unit. Before removing the operation panel

bottom cover, check the photos below.

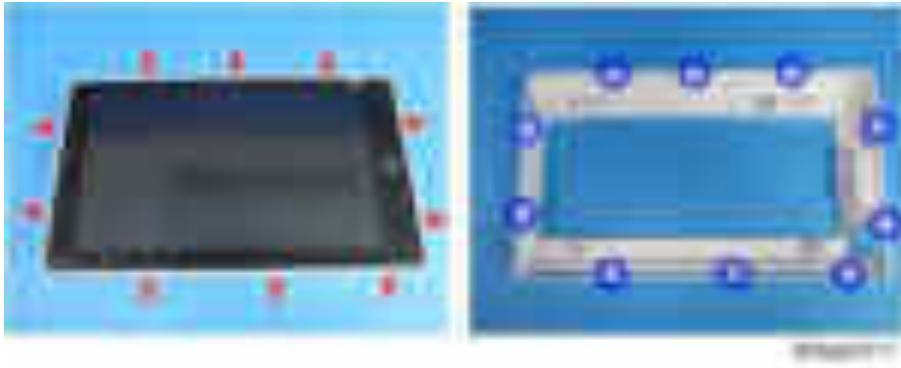

3. Remove the base bracket [A].



4. Remove the main controller board [A].



Lift the fastener of the LCD I/F cable [A] on the main controller board side.

8.Smart Operation Panel G2.5



- By factory default, the following switches of the DIP switch [A] on the main controller board are set to ON: No.1, No.3, and No.6. When installing the operation panel unit, make sure that the DIP switch setting is correct for the MFP on which you are installing the panel.

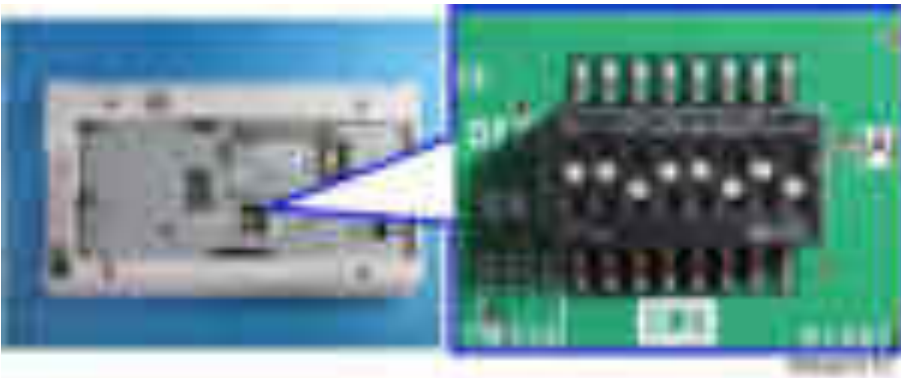

- The correct DIP switch setting depends on the MFP. Note the DIP switch settings of the old operation panel unit before replacing, and apply the same settings to the new Smart Operation Panel.

The following example is for DIP switch settings when the following switches are set to ON: No.1, No.3, and No.6 (this is the factory default setting of a service part).



- If the DIP switch setting is wrong, SC672 will be displayed.
- DIP switch No.1 turns ON/OFF the SC reduction function. Change the setting when needed.
 - 0 (OFF): The SC is displayed on the operation panel when SC672/SC673 occur.
 - 1 (ON): If the error is caused by a software defect when SC672/SC673

occur, automatically reboot is performed and the SC is reset. If the error is caused by a hardware defect when SC672/SC673 occur, the SC is displayed on the operation panel.

- After replacing the main controller board, perform the following checks:
 - LED Check ([LED Check](#))
 - Key Check ([Key Check](#))

NFC Board

1. Remove the operation panel unit. (Refer to "Operation Panel (PCB13)", "Replacement and Adjustment" in Main Chapters.)

2. Remove the hinge cover [A].



3. Remove the cover of the NFC board [A].



4. Remove the NFC board [A].

8.Smart Operation Panel G2.5



Mechanism

System Components

Hardware Specifications

Components

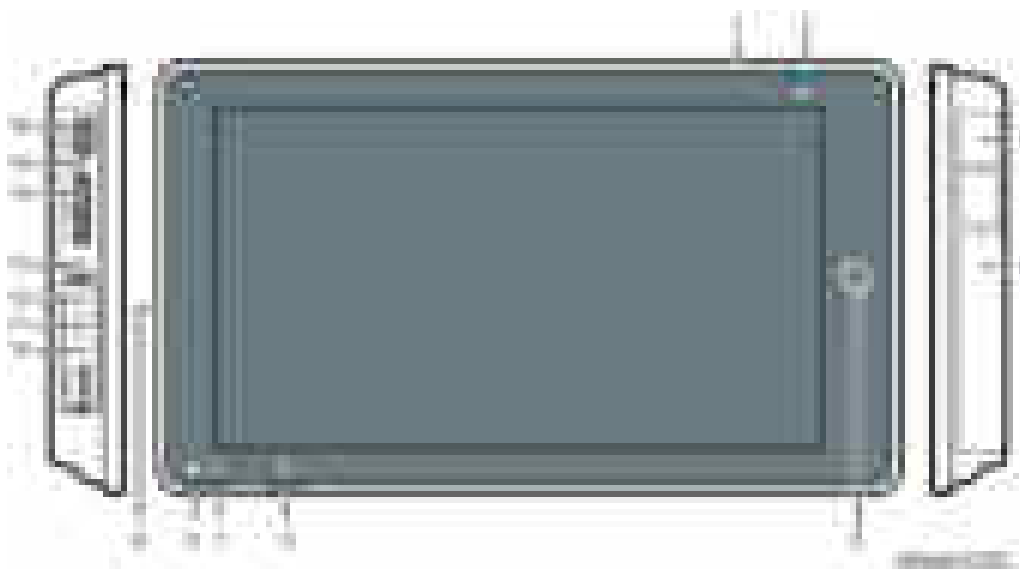

No.	Name	No.	Name
1	Speaker	9	Microphone
2	Main power indicator	10	Extended Feature key (EX3)
3	USB slot for digital cameras	11	Extended Feature key (EX2)
4	USB slot for NFC card readers	12	Extended Feature key (EX1)
5	NFC tag	13	Control panel reboot key
6	[Check Status] indicator	14	SD card slot
7	Data In indicator (facsimile and printer modes)	15	Media access lamp
8	Fax indicator	16	USB slot

Basic Specifications



Category	Specification
LCD panel	<ul style="list-style-type: none"> • Size 10.1 inch panel • Resolution WSVGA (1024x600) • Bit width RGB666 (18 bit color) • Brightness 250cd/m² (typ.) • Backlight

8.Smart Operation Panel G2.5

Category	Specification
	LED Backlight (life: 15,000 hours)
CPU	ARM Cortex-A9 Quad Core 1GHz (SoC : MCIMX6Q5EYM10AD)
Touch panel	Low load touch panel (recognizes touches to two points)
Memory	<ul style="list-style-type: none"> • Volatile Memory RAM (DDR3L-1066), 2GB • Non-Volatile Memory eMMC NAND, 8GB  • Uses a 16GB product in SLC Mode. • Program area and data area for the operating system and applications.
External interfaces	<ul style="list-style-type: none"> • USB Memory USB2.0 Host Type-A • SD Card SD card slot 1ch (SD*1/SDHC*2) *1 Up to 2GB *2 Up to 32GB • USB expansion USB2.0 Host Type-A (for camera, USB keyboard, USB card reader) • USB expansion USB2.0 Host Type-miniB (for NFC expansion)
Network	<ul style="list-style-type: none"> • Wireless LAN 802.11ac/a/b/g/n (for Taiwan/China/Asia) 802.11b/g/n (2.4GHz only) (for North America/EU/Korea) • Bluetooth Bluetooth4.2
Audio input/output	Monaural speaker 1ch (output: 1 to 2 W), Microphone
RTC accuracy	±52.56 seconds per month (using external crystal oscillator, 20 ppm)
Hard keys	<ul style="list-style-type: none"> • Extended Feature keys (EX1, EX2, and EX3) Use for startup in extended mode etc. • Control panel reboot key Use to reboot the control panel when it freezes.
LED types	<ul style="list-style-type: none"> • Main power indicator (blue) Lights when the power is on. Flashes slowly in Sleep mode. Flashes gradually in Energy Saver mode • [Check Status] indicator lamp (red/blue)

Category	Specification
	<p>Lights when an error occurs.</p> <ul style="list-style-type: none"> Data In indicator (blue) Flashes when the machine receives data from a printer driver or LAN-Fax driver. Fax indicator (blue) Flashes while sending or receiving a fax. Lights when there is a received fax document in the fax memory. Media access lamp (blue) Lights when there is an SD card inserted in the SD card slot.
Maximum power consumption	<p>4.5 W or less in standby mode (excluding external interfaces and internal feature expansions)</p> <p>6 W or less when using wireless LAN (during high-load operation)</p>
NFC	<p>Built-in NFC tag</p> <p>Made by Vanskee Enterprise</p> <p>RCH-NTI2CP1K-BSA-PCB-CE-1128</p>
Power consumption in Sleep mode	<p>0.18 W or less</p> <p>(When in Sleep mode, power is not supplied to USB devices connected to the USB slots except when the IC card R / W (NFC) is connected.)</p>
Tilt function	<p>Equipped with an angle-adjustable hinge. Clicks at the standard position.</p> <p>Depending on the model, there is also a hinge-less fixed type.</p>

Specification comparison with the previous model

Item	This model	Previous model
Appearance		
Control panel size (Width × Height)	274.5 × 160 mm	267 × 160 mm
Brightness of LCD panel	250cd/m ² (typ.)	200cd/m ² (typ.)
CPU	ARM Cortex-A9 Quad Core 1GHz (SoC: MCIMX6Q5EYM10AD)	ARM Cortex-A9 Dual Core 1GHz (SoC: MCIMX6D5EYM10AC)
Volatile Memory	RAM (DDR3L-1066), 2GB	RAM (DDR3-1066), 2GB
Wireless LAN	802.11ac/a/b/g/n (for Taiwan/China/Asia) 802.11b/g/n (2.4GHz only) (for North America/EU/Korea)	802.11b/g/n

8.Smart Operation Panel G2.5

Item	This model	Previous model
Bluetooth	Bluetooth4.2	Bluetooth4.0
NFC tag	Built in	Not equipped
Power consumption in Sleep mode	0.18 W or less	0.35 W or less

Available languages

Japanese, English, French, German, Italian, Spanish, Dutch, Norwegian, Danish, Swedish, Polish, Portuguese, Hungarian, Czech, Finnish, Simplified Chinese, Traditional Chinese, Thai, Russian, Arabic, Greek, Korean, Catalan, Turkish, Brazilian Portuguese

Note: Available languages may vary depending on the machine's specifications.

Software Specifications

A software package consisting of the Android Firmware and the manufacturer's own pre-installed applications is installed on the Smart Operation Panel.

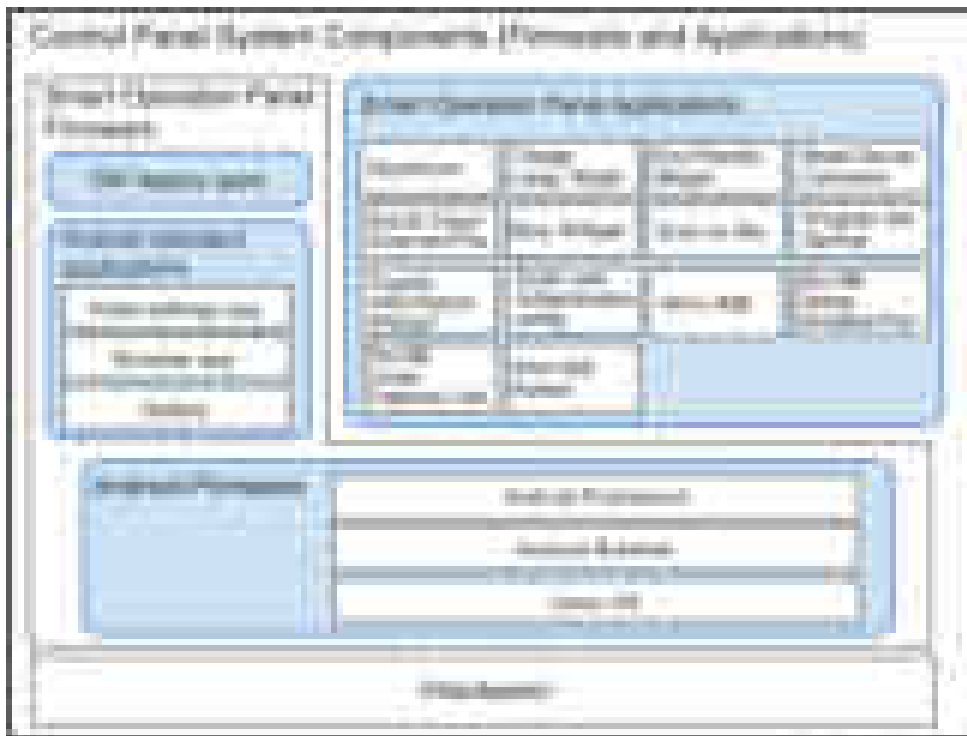

The following three types of software are installed on the Smart Operation Panel.

1. Android Firmware (Android OS)
2. Pre-installed applications
3. Applications that can be installed additionally

Android Firmware (Android OS)

The Android Firmware (Android OS) consists of the following modules that are called “stacks”.

- Linux kernel
- Android Runtime

- Library
- Application Framework

Pre-installed applications

On the Smart Operation Panel, applications such as the GW applications (Copy/Printer/Document Server/Scanner/Fax), Control Panel Browser, the standard keyboard, Installer, Gallery, Self Check are pre-installed. Unlike those installed on the controller board of the MFP, GW applications that are installed on the Smart Operation Panel are for controlling operation and display of the Smart Operation Panel.

Pre-installed applications are provided as part of the control panel firmware (Cheetah System) together with the Android firmware. When you update the control panel firmware using the recovery mode or another method, the pre-installed applications will also be updated.

Applications that can be installed

On the Smart Operation Panel, applications can be installed in addition to the pre-installed applications. Applications that can be installed include optional applications that customers can purchase, applications that are installed only on machines sold in specific regions, and custom-made applications. On an MFP, applications such as Simple UI applications (Quick Copy, Quick Fax, and Quick Scanner) and Scan to Me are installed.

Communication Specifications

The Smart Operation Panel and the GW controller are connected by a USB 2.0/3.0 cable. They communicate with each other via the Android OS on the Smart Operation Panel, using protocols called “OCS Library” and “Flair-API (System/Application)”.

System block diagram

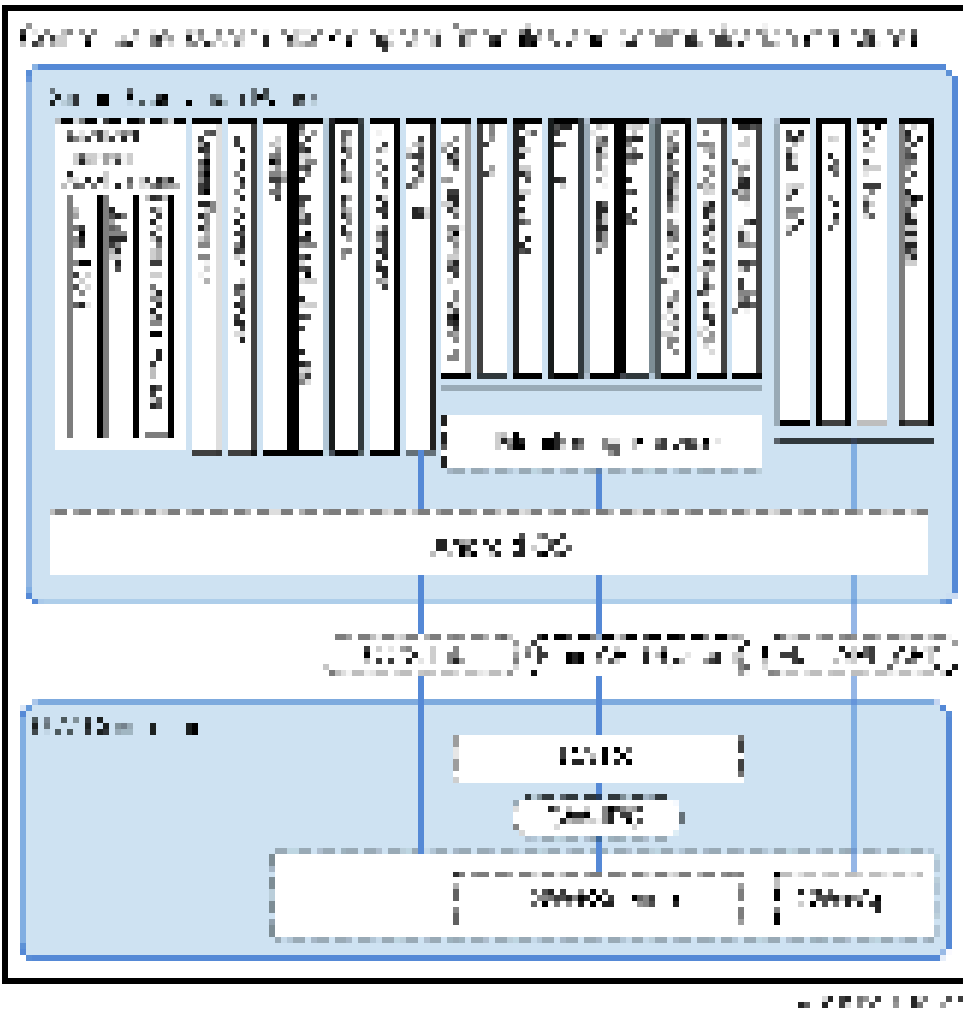

Overview of Components

Communication module/signal name	Details
OCS Library	<p>OSC stands for Operating Control Service. It is a module that controls the control panel. The set of signals used by this module to control the control panel are called the OCS Library.</p> <p>It is used during communication between the Legacy UI (system) module on the Smart Operation Panel and the GW module for the following processes.</p> <ul style="list-style-type: none"> Deciding on the display format suitable for a particular model of the control panel, so that the intended image data can be converted to actual image data. Converting touch panel operations to commands.
Flair-API (System/Application)	<p>Flair is the manufacturer's own communication interface between software modules. The interface uses a generic WebAPI.</p> <p>It is divided into two parts: a part that communicates directly with</p>

Communication module/signal name	Details
	<p>applications such as the application manager, Home, Authentication, Banner, Check Status, and Widgets, and a part that monitors applications. It communicates with the GW controller via the CATS module.</p>
CATS	<p>CATS stands for Cheetah Application Total System. It is a module in the GW controller.</p> <p>Because the Smart Operation Panel uses the Android OS, the contents and protocols of communication are not the same as those of the conventional control panel. CATS serves as an intermediary between the GW controller and the Smart Operation Panel.</p> <p>It also controls the power status of the control panel.</p> <p>CATS communicates with the Smart Operation Panel using the Flair-API, and communicates with the GW module using the GW-API.</p>
GW-IPC	<p>The name of the interface used among modules in the GW controller. The role is the same as that of the Flair-API.</p>

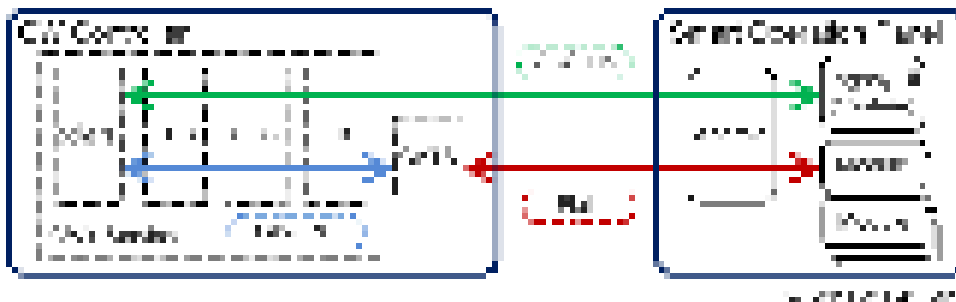

- API stands for Application Programming Interface. An API is an interface that software modules use in order to communicate with each other.

Panel Components/Screen Layout

Components of the Control Panel

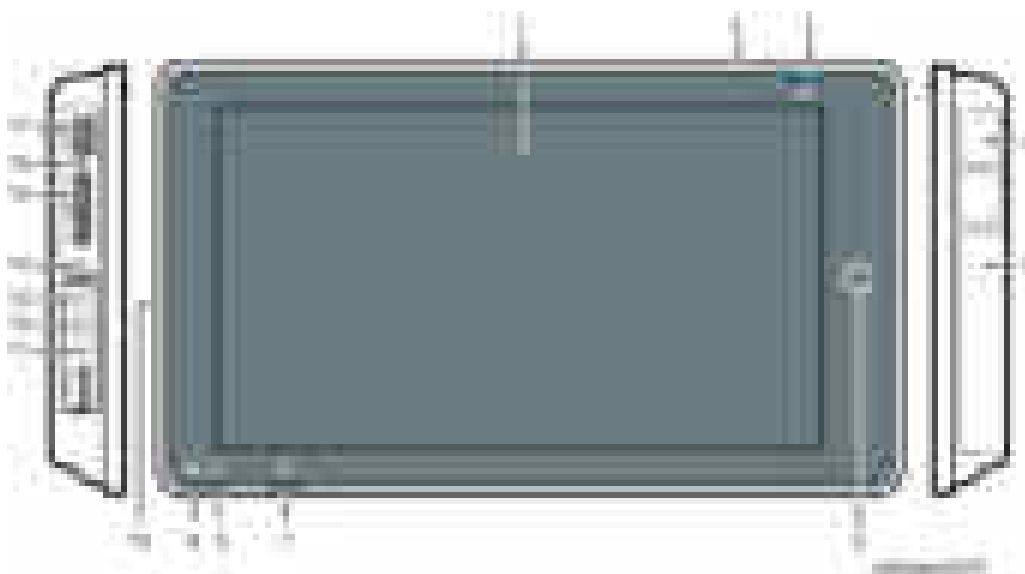

No.	Name	Description
1	Display panel	Displays icons for functions and applications. Displays the operation screens, operation keys and other information.
2	Speaker	Produces the operation and warning sounds.
3	Main power indicator	Indicates power OFF/ON, and energy saving status.
4	USB slot for digital cameras	You can connect the optional numeric keypad and digital cameras.
5	USB slot for NFC card readers	You can connect the authentication card reader/writer and devices supporting near-field communication (NFC).
6	NFC tag	Used to connect the machine and a smart device with the RICOH simple input and output.
7	[Check Status] indicator	Indicates system status.
8	Data In indicator	Flashes when the machine receives data from a printer driver or LAN-Fax driver.
9	Fax indicator	Indicates fax status. <ul style="list-style-type: none"> • During communication: Flashes • When fax documents have been received using Substitute Reception: Lights • When the machine has received a confidential fax document: Lights
10	Microphone	There is currently no function that uses this.
11	Extended Feature	Used for system maintenance, such as control panel self-check.

No.	Name	Description
	key (EX3)	
12	Extended Feature key (EX2)	Used for system maintenance, such as control panel self-check.
13	Extended Feature key (EX1)	Used for system maintenance, such as control panel self-check.
14	Control panel reboot key	Used when rebooting the control panel.
15	SD card slot	Insert an SD card here.
16	Media access lamp	Lights when an external media is inserted into the SD card slot or the USB slot.
17	USB slot	Insert a USB memory device here.









Panel Display

Soft keys displayed on the screen (when the Authentication Function is Disabled)



No.	Name	Description
1	[Function] keys	Users can assign shortcuts for each application. Up to three applications can be assigned as shortcuts. When an application is assigned as a function key, users can call the application from any screen. The function keys are disabled by default. Users must enable this function to be able to allocate applications to function keys.
2	[System messages] key	System messages are displayed in this area. If there are multiple messages to be displayed, they are displayed alternately. Tapping the message opens a dialog which shows all the messages.

8.Smart Operation Panel G2.5

No.	Name	Description						
3	[Help] key	This icon is displayed when Help is available for the displayed screen or errors occurring when the machine is connected to the Internet. Specify [Cookie] in the control panel browser to [ON] to display Help properly.						
4	[Energy Saver] key	Enters Sleep mode.						
5	[Switch Screens] key	Press to scroll the screens right and left. The Home screen has 5 screens.You can switch between the screens by flicking.						
6	[Application List] key	Displays the list of installed applications.						
7	[Current display position] key	Shows which of the five screens is currently displayed.						
8	[Stop] key	Stops the scanning of a document, fax transmission, or printing to paper.						
9	[Menu] key	Displays the menu screen of the application in use. May not be available depending on the application.						
10	[Home] key	Displays the Home screen.						
11	[Back] key	Use this to go back to the previous screen when the Screen Features Settings screen or the screen of an application is displayed.						
12	[Media] key	Displays icons when a USB flash drive or SD card is inserted. By pressing this key, you can choose the media to remove and use. Depending on the media, one of the following icons appear.						
		<table border="1"> <tr> <td></td> <td>USB icon (key)</td> </tr> <tr> <td></td> <td>SD card icon (key)</td> </tr> <tr> <td></td> <td>USB/SD icon (key)</td> </tr> </table>		USB icon (key)		SD card icon (key)		USB/SD icon (key)
	USB icon (key)							
	SD card icon (key)							
	USB/SD icon (key)							
13	[Check Status] key	You can check the status of the MFP, each function, and the current job. You can also check the job history and maintenance information of the MFP.						

Items that Appear when the Authentication Function is Enabled

Login user information and login/logout key also appear.

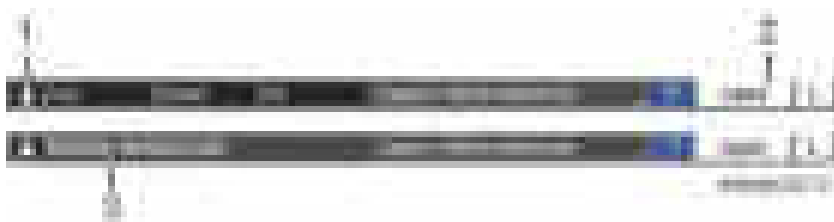

No.	Name	Description
1	[User icon] key	You can configure the authentication setting. This key appears when someone is logging in. If pressed after logging in, the login user name appears for a while in the login user information display area.
2	[Login/Logout] key	This key is displayed if the authentication function is enabled. By pressing [Login], the login menu appears. If you have already logged in, [Logout] appears. By pressing [Logout], you can log out.
3	Login user information display area	The name of the user logging in appears in this area. By pressing the [User icon] key, the name of the user logging in appears for approximately 5 seconds (and then automatically switches back to displaying the function keys.)

Items that Appear According to the Security Setting



No.	Name	Description
1	Extended Security icon	This icon is displayed if [System Settings] > [Administrator Tools] > [Extended Security] > [Enhance File Protection] is set to [On].
2	Overwrite icon	Displays the hard disk overwrite status when [System Settings] > [Administrator Tools] > [Auto Erase Memory Setting] is set to [On].

Electrical Components

Operation Panel Unit

8.Smart Operation Panel G2.5

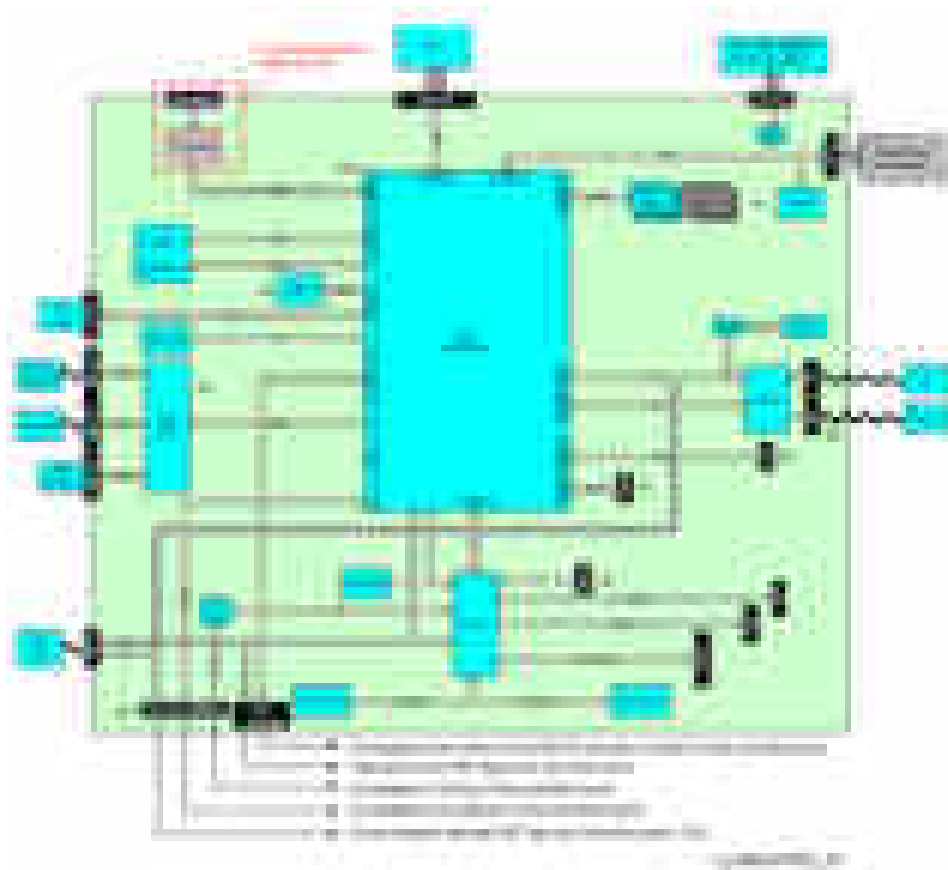

Touch Panel

The touch panel of this machine uses a 4-wire resistive film method (low load resistive film analog 4-wire method). It can detect two points for flick/drag/pinch-in/pinch-out operations. Resistive touch panel has been adopted in order to allow operation with a prosthetic hand.

Basic Structure

An analog 4-wire resistive film touch panel has 2 layers. Two materials (mainly film or glass) with transparent conductive film (ITO) are attached such that the transparent conductive film layers face each other.

When the film is pressed with a finger or a pen, the transparent conductive films contact each other and the touch panel operation is recognized.

Insulators (spacing dots) secure space between the two transparent conductive film layers to prevent short-circuiting.

Because the transparent conductive film has a uniform resistance characteristic, the resistance value reflects the distance of contact.

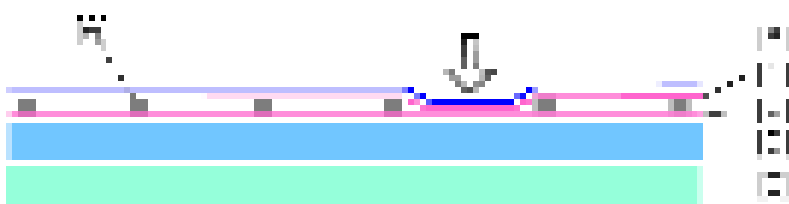

[A]: Spacing dot
1248

[B]: PET film

[C]: Transparent conductive film

[D]: Base glass

[E]: LCD panel

Self-Check (multi-touch calibration) mechanism

With the Multi-touch calibration in the self-check function, the touch panel is automatically calibrated using the results of touches to the top left and bottom right positions.

The values of “EVR_X”, “EVR_Y”, “X_MAX”, and “Y_MAX” are used for internal processing. They do not indicate the positions or distance of the touched points. There is no problem unless there is a huge difference between the values of the first calibration and the second calibration.

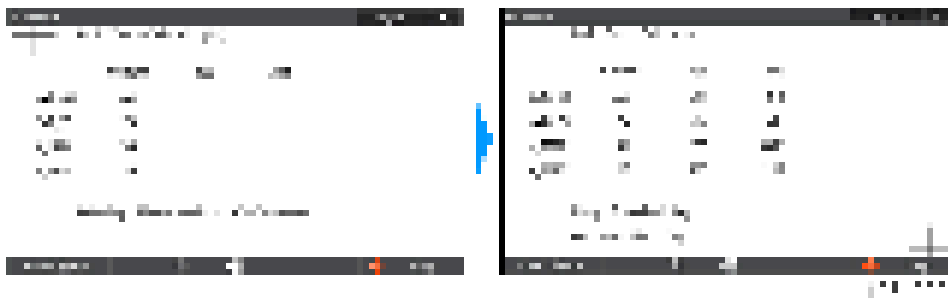

Controlling the Power Supply

Exiting Energy Saving Modes

Because this model of Smart Operation Panel has no hardware keys, the MFP exits from energy saving mode when the user does one of the following:

- Touches the display panel
- Lifts the ADF
- Sets an original in the ADF

Screen Startup Mode

Startup Modes

There are two screen startup modes. The factory default setting is Normal.

1. Normal

This is the standard startup mode. When the main power of the MFP is turned ON, the control panel starts up using less power compared to Quick mode.

2. Quick

By preparing for the next startup when the machine shuts down, the control panel starts up faster than in Normal mode.

Changing the Screen Startup Mode

Screen Startup Mode can be changed in Screen Features Settings.

8.Smart Operation Panel G2.5

Select [Screen Features Settings] > [SYSTEM] > [Screen Device Settings] > [Screen Startup Mode], and then select [Normal] or [Quick].

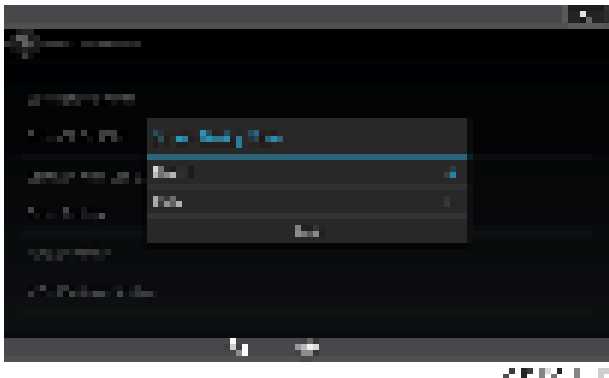

- In the following cases, the control panel starts up in Normal mode even if [Quick] is selected.
 - The power cord has been disconnected from the power outlet after the last shutdown.
 - The MFP is turned ON after being turned OFF due to reasons such as a power failure.
 - The MFP was not properly shut down the last time it was turned OFF.

How the Control Panel Starts Up

In Normal mode

The startup screen is displayed on the display panel, followed by the startup animation.

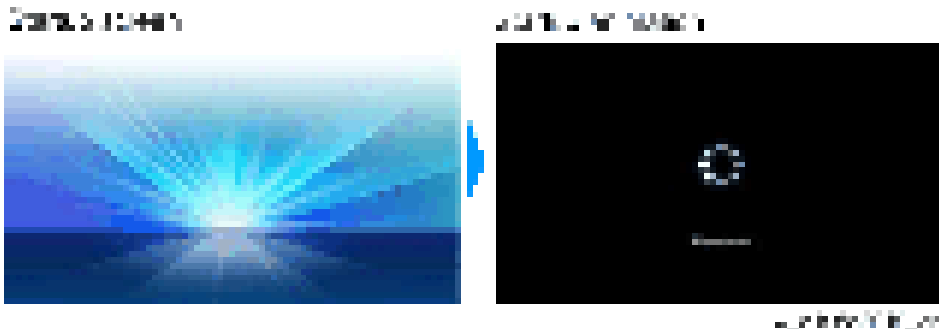

In Quick mode

The [Home] screen is displayed immediately after the main power of the MFP is turned ON. The startup screen displayed when starting in Normal mode is not displayed.

How the Screen Shuts Down When Quick mode Is Selected

When Quick mode is selected, the MFP prepares for the next startup when it shuts down. The main power indicator flashes during preparation for the next startup. The indicator turns off when preparation is completed.



If the MFP is turned ON during shutdown, the preparation for the next startup continues. When preparation for the next startup is completed, the control panel starts up in Quick mode.



- When Quick mode is selected, the control panel starts up faster than in Normal mode but shutdown takes longer than in Normal mode.

Shutdown Functions

The shutdown functions and their uses are as follows.

Shutdown mode	Use	Operation
Normal Shutdown	Same as shutdown by users.	Turn the main power switch off.
Forced shutdown	When normal shutdown does not complete even though you waited a long time.	Hold the main power switch 6 seconds or longer.
Shutdown for parts replacement	<ul style="list-style-type: none"> • When you have to disconnect the power cord from the power outlet, such as when replacing parts. • When you want to start the machine normally and then enter recovery mode, without changing the Startup mode in Screen Features Settings. (For updating control panel firmware) 	Turn the main power switch off while holding down [Stop]. Continue to hold down the [Stop] key until the shutdown screen is displayed.
Shutdown for software update	When you are going to turn on the MFP within 5 minutes for updating the MFP firmware or package. (Use shutdown for parts replacement if you are updating the control panel firmware.)	Turn the main power switch off while holding down the [EX1] key. Continue to hold down the [Stop] key until the shutdown screen is displayed.

Normal Shutdown

The MFP is equipped with a function to shut down safely in order to:

- Prevent damage to the file systems in the HDD and the NAND flash memory.
- Prevent paper from being left inside the body of the MFP (except when paper is jammed).

8.Smart Operation Panel G2.5

The shutdown process begins when the main power switch is pressed. To make a forced shutdown, press and hold the main power switch for 6 seconds. However, if you force a shutdown during the shutdown process, data being processed may be lost. Forced shutdown is to be used to shut down the MFP without disconnecting the power cord when the shutdown process cannot be completed.

Other Shutdown Functions

This MFP has two additional shutdown functions to facilitate maintenance.

Shutting down the MFP for parts replacement (Starting up in Normal mode when Quick mode is selected)

When Quick mode is selected, the MFP prepares for the next startup when it shuts down. This causes the shutdown process to take longer than when Normal mode is selected.

If you need to disconnect the power cord after shutdown in order to replace parts or for other reasons, you can use the following procedure to shut down the MFP just like you do in Normal mode. This shortens the time it takes to shut down the MFP.

- Procedure

Turn the main power switch OFF while holding down the [Stop] key on the control panel. Continue to hold down the [Stop] key until the shutdown screen is displayed.

Shutting down the MFP for software updates (Shutting down the MFP with the control panel in Sleep mode)

If you are going to turn ON the MFP within 5 minutes, you can use the following procedure to shut down the MFP with the control panel in Sleep mode.

- Procedure

Turn the main power switch OFF while holding down the [EX1] key. Continue to hold down the [EX1] key until the shutdown screen is displayed.



- You must turn ON the MFP within 5 minutes.
- If more than 5 minutes has elapsed after shutting down the MFP using the above procedure, the machine starts up in Normal mode even if Quick mode is selected.

System Maintenance

Maintenance Modes

Service program (SP) modes for the Smart Operation Panel are as follows:

Mode	Use	Notes
SP Mode (MFP)	SP modes for the MFP (controller, engine)	The numeric keys are required to enter this mode. Display the application where soft keys are displayed or the soft keys of the SP mode.
Service mode (operation panel)	SP modes for the Smart Operation Panel. <ul style="list-style-type: none"> • Changing SP mode settings in the Screen Features Settings menu. • Installing and updating applications that can be installed 	Same as above
Recovery mode	Maintenance modes for the Android OS <ul style="list-style-type: none"> • Updating firmware • Initializing all data 	-

Login to/Logout from Control Panel Service Mode

Login

In the same way as you log in to the SP Mode on the MFP, you use the soft keys to enter a combination of numbers in order to login to the service mode of the control panel.



- You cannot log in to the service mode of the control panel when one of the following screens is displayed.
 - Stop All Jobs
 - Settings
 - Address Book Management

Use the numeric keys on one of the following screens.

- Soft keys on the application screen where soft keys appear
- Soft keys for the control panel's service mode (displayed by pressing both the [EX3] key and [Check Status] at the same time)



- To exit the soft keys, press [EXIT] on the screen.

8.Smart Operation Panel G2.5

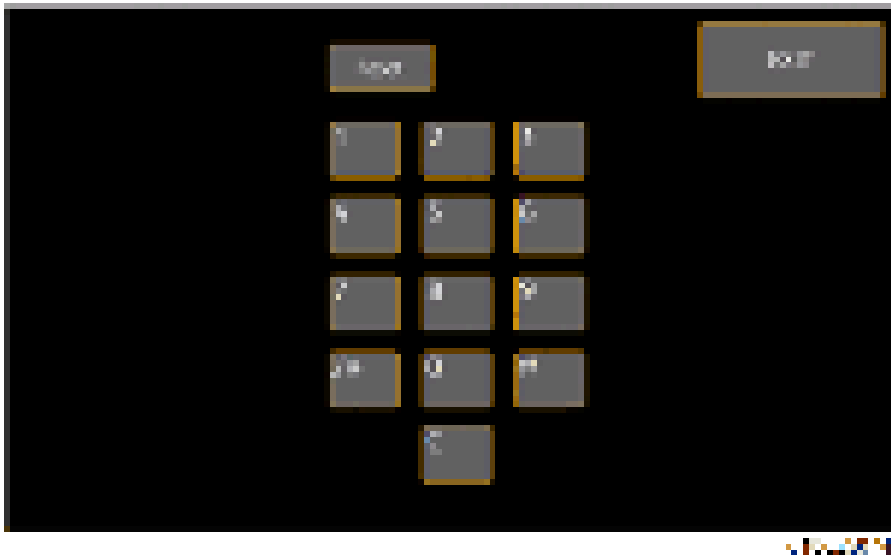

Login Status Indicator

When you log in to the control panel's service mode, the Screen Features Settings screen is displayed.

- "Service" is displayed in the login information area [A].
- [Logout] is displayed in the Login key area [B] to allow logout from the service mode.

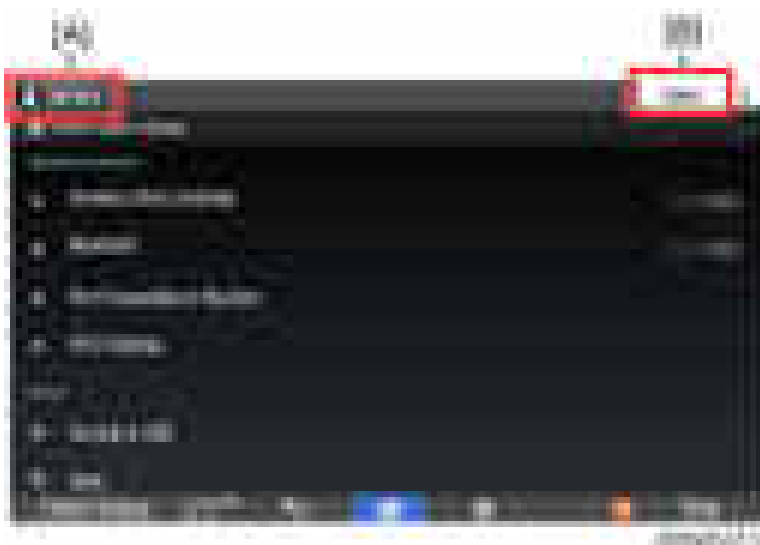

Logout

Press [Logout] to log out from the control panel's service mode.



- You need to logout manually because the Auto Logout function does not work.

Depending on the authentication settings of the MFP, the following screen is displayed after you log out.

Authentication settings		
Administrator authentication: OFF User authentication: OFF	Administrator authentication: ON User authentication: OFF	Administrator authentication: ON User authentication: ON
Screen of the function selected in [Function Priority]	Screen of the function selected in [Function Priority]	[Home] screen

When Entry to Service Mode Is Prohibited by the Administrator

The administrator of the MFP can prohibit entry into the control panel’s service mode by enabling [Service Mode Lock] in [System Settings].

When [Service Mode Lock] is enabled, the machine does not enter the service mode even if you enter the number combination for the control panel’s service mode. There will be beeping sounds to indicate login failure.



- The machine can enter the recovery mode even if [Service Mode Lock] is enabled.

Service Mode Menu

There are four menus of settings.

- Wireless & Networks
- Device
- Personal
- System





Wireless & Networks





Menu level			Description
1st level	2nd level	3rd level	
Wireless Direct Settings	Group Owner Mode		You can only view the setting.

8.Smart Operation Panel G2.5

Menu level			Description
1st level	2nd level	3rd level	
	Connection Password		You can only view the setting.
	DHCP Server IP Address		You can only view the setting.
	DHCP IP Address Range		You can only view the setting.
	Select Channel		You can only view the setting.
	Fix SSID		You can only view the setting.
	PEER DEVICES		View and configure devices that can be connected.
	REMEMBERED GROUPS		Displays groups that have been previously connected.
Bluetooth	ON/OFF		You can only view the setting.
	SEARCH FOR DEVICES		Scans for Bluetooth devices in the vicinity.
	(name of this device)		You can only view the setting.
	PAIRED DEVICES		View and configure paired devices.
	AVAILABLE DEVICES		View and configure available devices.
Port Forwarding to Machine	Port Forwarding Settings	Port Forwarding Config 1-20	Requests sent to the wireless LAN unit of the Smart Operation Panel can be forwarded to the controller of the MFP. You can enable or disable ports to forward these requests.
MTU Settings	PathMTU(Enable/Disable)		Enables/disables the PathMTU size set in [MTU Size]. When you change this setting, the control panel restarts.
	MTU Size		Sets the size of PathMTU. Default: 1500.

Device

Menu level			Description
1st level	2nd level	3rd level	
Storage & USB	Internal storage	Used and Total Storage Capacity	Displays the used size and total size of the internal storage.
	SD CARD* ¹	Used and Total SD Card Capacity Safely Remove Hardware icon ()	Displays the used size and total size of the SD card. *To remove the SD card, click the  or  icon instead of the Safely Remove Hardware icon

Menu level			Description
1st level	2nd level	3rd level	
			().
	USB STORAGE ^{*2}	Used and Total USB Storage Capacity Safely Remove Hardware icon ()	Displays the used size and total size of the USB storage device. *To remove the USB flash drive, click the  or  icon instead of the Safely Remove Hardware icon ().
Apps	Install	Install from SD Card	Install or update applications from an SD card.
		Install from Server	Enter a product key to install or update applications from the server.
		Application Site	Start up Application Site.
		Activate Applications	Activate applications that have been installed from the server.
		Update Applications	Update applications that have been installed.
		Uninstall	Uninstall applications.
		Install From Internal Storage	Install applications from internal storage.
		Check Server Connect	Check if you can connect to the Server.
		Firmware update	Update the firmware from the SD card set in the operation panel slot. If the SD card is not inserted, an error message is displayed.

*1 Displayed only when an SD card is inserted into the SD card slot of the operation panel.

*2 Displayed only when an USB storage device is inserted into the USB slot of the operation panel.

Personal

Menu level			Description
1st level	2nd level	3rd level	
Lauguage & input	Registration Keyboard	-	You can register the external keyboard, display the connected keyboard, or remove the external keyboard.

System

Menu level			Description
1st level	2nd level	3rd level	
Screen Device Settings	Status		Displays the following: <ul style="list-style-type: none"> • Wireless LAN MAC address • Bluetooth address

8.Smart Operation Panel G2.5

Menu level			Description
1st level	2nd level	3rd level	
Information			<ul style="list-style-type: none"> Interface Settings Wi-Fi settings (ON/OFF)
	Legal information	Open source licenses	Displays the open source license information.
		System WebView Licences	Displays the license of the system used in this machine.
		Wallpapers	Displays the copy light of the picture of the wallpaper.
	Software Version List	Version List Record Save to SD Card* ¹	Displays the versions of operation panel firmware and installed applications. When saving the software version list on an SD card, insert an SD card into the SD card slot of the operation panel, and then press [Save to SD Card].
	Operation Panel Kind		Displays the hardware information of the operation panel with a 4-digit code.
			1st digit: LCD size <ul style="list-style-type: none"> 1: 10.1" 2: 7"
			2nd digit: LCD vendor <ul style="list-style-type: none"> 0: AUO 1: INNOLUX 2: Dongbond 6: Giantplus
			3rd digit: eMMC version <ul style="list-style-type: none"> 7: Version 5.00 8: Version 5.10
			4th digit: PCB vendor <ul style="list-style-type: none"> N: NEC R: RICOH
Screen Device Settings	Prohibit Use of External Interface	Wi-Fi (Do not Prohibit / Prohibit)	If you select [Prohibit] for this setting, the Wi-Fi function is automatically set to [OFF] and the Wi-Fi function setting in [Screen Features Settings] is hidden. If you select [Do not prohibit] for this setting, the Wi-Fi function setting in [Screen Features Settings] is displayed.

Menu level			Description
1st level	2nd level	3rd level	
			The setting remains unchanged.
		Wireless Direct (Do not Prohibit / Prohibit)	If you select [Prohibit] for this setting, the Wireless Direct function is automatically set to [OFF] and the Wireless Direct function setting in [Screen Features Settings] is hidden. If you select [Do not prohibit] for this setting, the Wireless Direct function setting in [Screen Features Settings] is displayed. The setting remains unchanged.
		Bluetooth (Do not Prohibit / Prohibit)	If you select [Prohibit] for this setting, the Bluetooth function is automatically set to [OFF] and the Bluetooth function setting in [Screen Features Settings] is hidden. If you select [Do not prohibit] for this setting, the Bluetooth function setting in [Screen Features Settings] is displayed. The setting remains unchanged.
		Screen SD Card Slot (Do not Prohibit / Prohibit)	If you select [Prohibit] for this setting, the Screen SD Card Slot function is automatically set to [OFF] and the Screen SD Card Slot function setting in [Screen Features Settings] is hidden. If you select [Do not prohibit] for this setting, the Screen SD Card Slot function setting in [Screen Features Settings] is displayed. The setting remains unchanged.
		Screen USB Memory Slot (Do not Prohibit / Prohibit)	If you select [Prohibit] for this setting, the Screen USB Memory Slot function is automatically set to [OFF] and the Screen USB Memory Slot function setting in

8.Smart Operation Panel G2.5

Menu level			Description
1st level	2nd level	3rd level	
			<p>[Screen Features Settings] is hidden.</p> <p>If you select [Do not prohibit] for this setting, the Screen USB Memory Slot function setting in [Screen Features Settings] is displayed. The setting remains unchanged.</p>
	Server Settings	Port number	<p>Input a port number for communication with the import/export and RFU server. The input number is used for both HTTP and HTTPS connections.</p> <p>(Normally, input a number within 55101-55111.)</p>
	Home Key Settings	Home Key Settings	<p>You can change the transition destination except for the Home screen when pushing the [Home] icon.</p>
		Home Key Assignment Mode	<p>Normal mode: In addition to pressing the [Home] icon, in all statuses such as logout and restoring from lower power display mode, the screen transitions to the destination which the user set with [Home Key Application].</p> <p>UI change mode: The screen transitions to the destination which the user set with [Home Key Application] only when you press the [Home] icon.</p>
		Home Key Application	<p>You can set the application of the transition destination when pressing the [Home] icon.</p>
		Show default Home for unauthenticated user	<p>You can specify whether the guest user can access the application selected in [Home Key Application] when user authentication is set to ON.</p>
		System Home Key Icon Settings	<p>You can use this setting only when [Home Key Assignment Mode] is [ON] and [UI Change Mode] is selected in [Home Key</p>

Menu level			Description
1st level	2nd level	3rd level	
			Assignment Mode]. You cannot set other than the above because of high brightness.
	Application Settings		Displays a list of installed applications. If you press [Settings] for an application, the setting screen for the CE is displayed. The screen does not change if the application has no setting items.
	Recovery by Authentication Priority	Recovery by Authentication Priority	This setting gives priority to the recovery time from energy saving modes when an IC card authentication device is connected. When this setting is selected, the MFP does not enter Engine OFF mode, and always recovers from Silent mode.
		Start Time (hh:mm)	You can specify the start time of Authentication priority mode. Note: This can be changed only when [Recovery by Authentication Priority] is deselected.
		Period (Hours)	You can specify the period of validity of Authentication priority mode. Note: This can be changed only when [Recovery by Authentication Priority] is deselected.
	Screen device always-connection Setting		This setting prevents the operation panel from entering Sleep mode, so that Bluetooth and other communication devices remain connected. When this setting is selected, the operation panel does not enter Sleep mode. Only the LCD (display panel) turns OFF.
	Panel Self Check		Starts self-diagnosis of the operation panel. (Panel Self Check)

*1 This can be pressed only when an SD card is inserted to the SD card slot of the operation panel.

Panel Self Check

The following are available as self-diagnostics functions of the control panel:

- LED Check
- Key Check
- LCD Check
- TouchPanel Calibration
- Bluetooth Check
- Speaker Check
- TouchPanel Check
- Wireless LAN Check
- MultiTouch Calibration
- eMMC Erasure Count



*The [microSD Erasure Count] menu can not be used with this machine.



- The [Self Check] menu is displayed in either English or Japanese. The language can be changed using [Change Language] in the Home screen.
- If an unavailable language is selected, English will be displayed.
- With some diagnostic items, press [Back] [A] at the bottom of the screen to return to the top menu of [Self Check].



LED Check

Select the [All Light On] check box, and make sure the following LEDs light:

- Data In indicator (facsimile and printer modes)
- Fax indicator

- [Check Status] indicator (flashes in red and orange alternately)
- Operation call light (if attached) (lights in red/blue)



When the check is completed, press [Back] to return to the top menu of [Self Check].

Key Check

Check if the Extended Feature keys on the left side of the control panel (EX1, EX2, EX3 from top to bottom) are functioning normally. If they are functioning normally, the key will turn green when pressed. [FOOT SW] is not used.



When the check is completed, press [End] to return to the top menu of [Self Check].

LCD Check

Visually inspect the color of the LCD. The displayed colors are white/black/red/green/blue. The LCD changes to the next color when you press it.

8.Smart Operation Panel G2.5



The check is completed when all colors have been displayed. The screen returns to the top menu of [Self Check].

TouchPanel Calibration

Calibrate the touch panel by touching the center of each of the five “+” signs.

The five “+” signs are displayed in the order of top left, bottom right, bottom left, center, and top right. After you have touched the five “+” signs, the display switches to the [Retry/OK] screen.

- If you want to calibrate again, press [EX1].
- If you want to confirm that the calibration results are OK, press the [EX3] key to return to the top menu of [Self Check].



Bluetooth Check

Check and configure the Bluetooth device connection.



When the check is completed, press [Back] to return to the top menu of [Self Check].



- You cannot switch Bluetooth to [ON] or [OFF] from the [Self Check] menu. Before checking the Bluetooth device connection, specify [ON] for [Bluetooth] in [Screen Features Settings] > [WIRELESS & NETWORKS] > [Bluetooth].

8.Smart Operation Panel G2.5

Speaker Check

Tests the speaker by playing the reference sound.

- 1.** Select the frequency (220Hz, 440Hz, 880Hz, 1760Hz, or 2000Hz).
- 2.** Press [START/STOP] to play the sound.
- 3.** Touch the volume bar, and play the sound at minimum and maximum volumes.
- 4.** Press [START/STOP] to stop the sound.



When the check is completed, press [Back] to return to the top menu of [Self Check].

TouchPanel Check

For each of the nine reference points on the screen, the distance between the detected pressed position and the nearest reference point is displayed. The distance is displayed continually near each reference point.

If all the distances between each detected pressed position and the nearest of the five reference points on the screen (at the four corners and the center) are within $\pm 12\text{px}$, the [OK] button appears. (However, even when the [OK] button is being displayed, if you press the screen again and the distance exceeds $\pm 12\text{px}$, the [OK] button disappears.)



If you press the [OK] button, the inspection implementation status switches to “Adjusted” and the screen returns to the self-inspection menu.

If you press the [Back] key, the inspection implementation status does not switch and the screen returns to the self-inspection menu.

Wireless LAN Check

Checks the condition of the wireless LAN connection.

When you select the connected access point, the signal strength, IP address and other information are displayed.



8.Smart Operation Panel G2.5

When the check is completed, press [Back] to return to the top menu of [Self Check].

MultiTouch Calibration

Calibrate the touch panel for multi-tap input methods such as pinch-in/pinch-out.

Touch the center of both “+” signs. The two “+” signs are displayed in the order of top left and bottom right. Repeat the procedure. The touch panel will be calibrated.

- If you want to adjust it again, press the [EX1] key.
- If you want to confirm that the calibration results are OK, press the [EX3] key to return to the top menu of [Self Check].



The “Back Key” in the message is actually the [EX1] key and the “Menu Key” in the message is actually the [EX3] key.



- The values of “EVR_X”, “EVR_Y”, “X_MAX”, and “Y_MAX” are for internal processing and do not indicate the positions or distance of the points touched. There is no problem unless there is a huge difference between the values of the first calibration and the second calibration.

eMMC Erasure Count

Displays the status of the the eMMC Erasure Count and the current number of times of rewriting.



Recovery Mode

The recovery mode menu is as follows. Ask your manager for details on how to enter Recovery mode.

Menu	Description
reboot system now	Reboots the Android OS.
apply update from sdcard	Updates the Cheetah System firmware by specifying the folder path.
wipe data/factory reset	Deletes all installed applications and all settings on the Cheetah.
wipe cache partition	Deletes all data that is stored on the cache partition. Currently, Cheetah does not use the cache partition, so nothing happens when this menu item is accessed.
wipe free area partition	Deletes all data that is stored on the free partition. Cheetah stores the version history on the free partition. When this menu item is selected, it will then disappear.
wipe LegacyUI area	Deletes Legacy UI.
micon update from sdcard	Updates Keymicon by specifying the folder path.
view recovery logs	Displays the recovery log.



- If [System Settings] > [Administrator Tools] > [Extended Security] > [Update Firmware] is set to [Prohibit], the control panel cannot enter the recovery mode.
- Ask your manager for information on how to enter the recovery Mode.

Special Key Combinations

Function	Operation for Smart Operation Panel
Resetting Settings	In the Settings screen, press a Settings category while holding down the EX3 key. Available for: System Settings, Copier/Document Server Settings, and Scanner Settings.
System Reset	Hold down the EX3 key and [#] simultaneously for 10 seconds. Resets the controller software of the main machine.
Application Reset	Hold down the EX3 key and [9] simultaneously for 10 seconds. Resets a single application.
Resetting User Code Authentication	Hold down [Reset] for 2 seconds. Returns to the User Code entry screen.

Backup/Restore for Smart Operation Panel Application/Settings Function

Overview

Application settings and additional applications installed on the Smart Operation Panel can be backed up automatically and can be restored, e.g. after Smart Operation Panel replacement.

In Cheetah SP mode, select [Screen Device Settings]> [Backup / Restore Settings].

Data that can be backed up and restored

- System application settings*¹
- Standard application settings*¹
- Pre-install application settings*¹
- Add-on applications (including hybrids)*²

*1: The system application, standard installed application, and pre-installed application are installed in MultiLink-Panel, so the application itself is not backed up or restored after replacement.

*2: Add-on applications settings are not backed up or restored.

Backup



- After replacing the smart operation panel, if the version of the cheetah system firmware is older than a certain version, update it to a later version.
- Backup cannot be performed manually by the user or the technician.
- During the backup, the message being backed up is displayed and other operations cannot be performed.

- A backup is performed 24 hours after the last backup. If the machine doesn't have backup data, the first backup is performed at 2:00AM.
- A backup cannot be performed under any of the conditions below. Backup will retry 1 hour later.
 - During ARFU, firmware updating from download site, etc
 - LCD on the operation panel: ON.
 - HDD cannot be accessed for 60 sec.
- If the backup data has not changed, no backup will be performed. (Maximum - 7 days)
- During the backup, the LCD is off.
- Backup data is stored on the HDD.
- The amount of time for the backup is as follows:

Example:

	Data	Backup time
Additional applications	106MB	1m 6s
Application settings	0.2MB	36s
Total	106.2MB	1m 42s

Disabling the Backup setting

The default setting is "Enabled". To change it to "Disabled", uncheck "Enabled". Restarting the machine is not necessary.

In Cheetah SP mode, select [Screen Device Settings] > [Backup/Restore Settings] In Cheetah SP mode.

Restore



- After replacing the smart operation panel, if the version of the cheetah system firmware is older than a certain version, update it to a later version.
 - If the machine doesn't have any backup data, the restore function cannot be used.
- 1.** Execute [Cheetah SP mode] > [Screen Device Settings] > [Backup/Restore Settings] > [Start Restore].
 - 2.** After a message indicating that restoration takes several minutes is displayed, touch "execute". A message saying please wait for a while is displayed. Time is about 10 minutes.
 - 3.** After a message indicating that the next message is displayed, touch [Close]. A message that the restoration was successful is displayed.
 - 4.** Turn the main switch off/on.

Restore Error Codes

If restore fails, an error code appears on the operation panel.

8.Smart Operation Panel G2.5

Code	Cause	Solution
1	Failed to restore additionally installed application data	Retry the Restore procedure.
3	Failed to restore application setting data	Retry the Restore procedure.

Software Update

Updating the Smart Operation Panel



- In the case of models provided with package firmware only, updates for the Smart Operation Panel and applications are also provided via package firmware. For details, see "[Firmware Update \(Removable Media\)](#)".

There are three methods to update the Smart Operation Panel. The method is different depending on what you want to update.

- Installation/update from a media
- Installation/update from the eDC Server
- Installation/update from Application Site

Update method	Features	Control panel firmware	Applications
Installation/update from a media	<p>Installation or update is possible in the following two ways.</p> <ol style="list-style-type: none"> Applications <ul style="list-style-type: none"> Use the installation screen in the control panel's service mode to update applications. You can install or update multiple applications at once. You can also uninstall an application. Package firmware (SD card or USB flash drive) Refer to "Firmware Update (Removable Media)". 	Yes	Yes
Installation/update from the eDC Server	<p>Install or update applications directly from the eDC Server.</p> <p>This method is mainly for paid applications. A product key is required when an application is installed for the first time.</p> <p>*The update procedure is the same as when updating the Smart Operation Panel application</p>	No	Yes

Update method	Features	Control panel firmware	Applications
	already released.		
Installation/update from Application Site	Installation and Updating of applications and firmware update can be done from Application Site. When administrator authentication is enabled, an administrator privilege is required to start Application Site. If you log in to the operation panel service mode, however, you can use it with CE privilege.	Yes* ¹	Yes

*1 Update can only be done by using a package file.

The following two methods can be used for updating the firmware.

- Update from a media
- Installation/update from Application Site

The following three methods can be used for updating an application.

- Installation/update from a media
- Installation/update from the eDC Server
- Installation/update from Application Site

Installation/Update from a Media

Installing/Updating an Application

Creating a media card for update

- 1.** Download the update modules from the Firmware Download Center.
- 2.** Unzip the downloaded file.
- 3.** Create a folder named “romdata” in the root directory of the media.
- 4.** Put the unzipped file in the “romdata” folder.

Update procedure

- 1.** Log in to the control panel in service mode.
- 2.** Insert the SD card into the SD card slot of the control panel.
- 3.** Select [Apps] > [Install] > [Install from SD Card].
- 4.** Select the application you want to install or update, and then press [Install]
- 5.** The installation or update results are displayed.
- 6.** Check that the application is correctly installed or updated, and then press [reboot operation panel].

Package Update

This method uses the package update function to update the control panel firmware and/or applications. The package update function is provided by the controller.

8.Smart Operation Panel G2.5

Update is done in the following order:

1. Controller firmware
2. Applications
3. Control panel firmware

If the control panel firmware has to be updated, the control panel starts in the recovery mode and the firmware is automatically updated.

The control panel restarts when updating is completed. The result notification is processed after the control panel restarts.

Refer to "Firmware Update (Removable Media)" for details.

When Installation/Update Is Prohibited

If [System Settings] > [Administrator Tools] > [Extended Security] > [Update Firmware] is set to [Prohibit], the execution key is grayed out and installation/update cannot be executed.

When trying to update from a PC, updating fails and the result is recorded as "Failed".

Installation/Update from the eDC Server

Downloads applications from the eDC Server, and installs or updates them.



- Installation/activation/update of applications from the server can only be done in the service mode.

Check Server Connect

- 1.** Log in to the control panel's service mode.
- 2.** Select [Apps] > [Install].
- 3.** Press [Check Server Connect] and make sure that "Connect Server Succeeded!" is displayed.



- The server address is stored in the firmware of the Smart Operation Panel.
- To connect to the server, the network settings of the MFP must be configured correctly. For the required configuration, see the Field Service Manual of the MFP.
- If server connection fails, see [Troubleshooting](#) for error codes.

Installation

1. Log in to the control panel's service mode.
2. Select [Apps] > [Install].
3. Select [Install from Server].
4. Enter the product key and press [Execute].



5. Follow the instructions shown on the screen.



- An application cannot be installed unless it is digitally signed by Ricoh.

Activation

1. Log in to the control panel's service mode.
2. Select [Apps] > [Install].
3. Select [Activate Applications].
4. Select the application to be activated, and then enter the activation key and press [Execute].



5. Follow the instructions shown on the screen.



- Only charged applications have to be activated.

8.Smart Operation Panel G2.5

Update

- 1.** Log in to the control panel's service mode.
- 2.** Select [Apps] > [Install].
- 3.** Select [Update Applications].
- 4.** Select the application to be updated, and then press [Check Update Status].
- 5.** Follow the instructions shown on the screen.

Forced Uninstallation

If you try to uninstall an activated application without first deactivating it, the uninstallation will fail. However, the application can be uninstalled without deactivation (forced uninstallation) in the following circumstances:

- Uninstallation using the service login uninstallation menu
- Deactivation failure due to the license information stored in the control panel not matching the license information published by the server



- Forced uninstallation cannot be performed if deactivation fails because of other factors (such as failure to connect to the server because of temporary network disconnection or server maintenance).

During forced uninstallation, the message indicating that deactivation failed appears.

If [OK] of the message is selected, uninstallation is executed forcibly without deactivation.

If [Cancel] of the message is selected, uninstallation is not executed.



- If executing forced uninstallation, forced deactivation must also be executed on the eDC server. Accordingly, check whether the license has been published for the eDC server.

Application Site

"Application Site" has been added to Screen Service mode. Field engineers can start up Application Site to install or update applications or firmware without needing user administrator credentials.

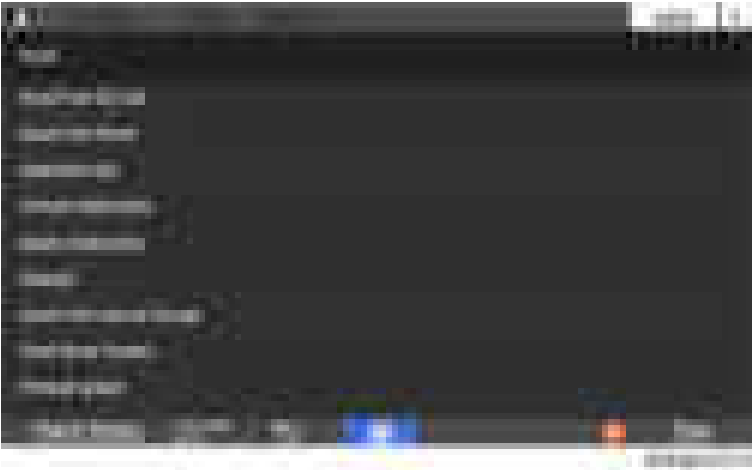

This menu item opens Application Site by using the Web Browser NX app.

Troubleshooting

Problems and Errors Related to Hardware

Symptom	Solution
<p>The touch panel is damaged (broken, dented, etc.) and cannot be operated.</p>	<ul style="list-style-type: none"> • Connecting a commercially available USB mouse enables the same operation as the touch panel. • Replace the LCD. • Replace the operation panel unit (you need to transfer user information, and reinstall the applications, etc.). Refer to "Factory Reset and Restoration".
<p>The touch panel does not respond.</p>	<ul style="list-style-type: none"> • Connecting a commercially available USB mouse enables the same operation as the touch panel. • Execute the Panel Self Check. • Check the operations other than that of the touch panel. • Replace the LCD. • Replace the operation panel unit (you need to transfer user information, and reinstall the applications, etc.). Refer to "Factory Reset and Restoration".
<p>The touch panel's coordinates have shifted substantially, resulting in not being able to execute its calibration.</p>	<ul style="list-style-type: none"> • Connecting a commercially available USB mouse enables the same operation as the touch panel. So you can execute the calibration • Execute the Panel Self Check, or the TouchPanel Calibration • Execute the MultiTouch Calibration. • If the shift occurs even after turning the power and then back on, check the battery voltage of the operation panel's main controller board. • Replace the main controller board. • Replace the operation panel unit (you need to transfer user information, and reinstall the applications, etc.). Refer to "Factory Reset and Restoration".
<p>Cannot enter the SSP mode.</p>	<p>If using the screen in a Classic Application, it does not support multitouch, so you cannot enter the SSP mode by the normal operation.</p>

Symptom	Solution
	Instead, use the EX3 key. Press and hold the EX3 key, and then press the "System/Copy" button in the SP mode menu.
SC672-11 appears.	<p>Cause Communication between the controller and the operation panel was not established after a normal startup. USB cable between the operation panel and the MFP is disconnected, damaged or defective.</p> <p>Solution Reconnect or replace the USB cable. For details about how to replace the USB cable, refer to the service manual for the MFP.</p> <p>Reference For details about SC672, refer to the service manual for the MFP.</p>
SC672-12 appears.	<p>Cause Communication between the controller and the operation panel was interrupted after a normal startup. USB cable between the operation panel and the MFP is disconnected, damaged or defective.</p> <p>Solution Reconnect or replace the USB cable. For details about how to replace the USB cable, refer to the service manual for the MFP.</p> <p>Reference For details about SC672, refer to the service manual for the MFP.</p>

Errors Related to Applications

Pre-installed Applications

Applicable applications

Copy (Classic) / Scanner (Classic) / Printer (Classic) / Document Server / Quick Copy / Quick Fax /

8.Smart Operation Panel G2.5

Quick Scanner / Web Browser

/ Quick ID Card Authentication Config*

*Depends on the model whether it is a pre-installed application

If an error related to the application occurs, the operation panel's operating system automatically restarts the application (with a confirmation dialog box).

Third-Party Application

If using a third-party application, the error message, code and solution may vary depending on the application. Follow the third-party vendor's instructions.

Factory Reset and Restoration

This section explains the Factory Reset and subsequent procedure. Factory Reset may be executed when an abnormal operation due to the system or an application occurs or when replacing the operation panel (at the request of the customer to delete settings, etc.)



- When you execute the Factory Reset:
All data that created by users will be initialized.
All applications (including the applications from eDC server or Application Site) will be deleted.

Items	Objective		
	Only delete data	Reset application configuration to factory settings.	Update system and reset application configuration to factory settings.
Exporting configuration file	-	As required	As required
Storing user information other than those exported	-	As required	As required
Factory reset	Required	Required	Required
System update	-	-	Required
Application installation	-	Required	Required
Importing configuration file	-	As required	As required
Registering user information other than those imported	-	As required	As required

Before executing Factory Reset, be sure to obtain the package firmware and copy it to the SD card.

Factory Reset

- 1.** Enter the recovery mode.
- 2.** Select and execute "wipe data/factory reset".
Press the EX1 and EX2 keys to move the cursor up and down.
Press the EX3 key to execute the selected function.

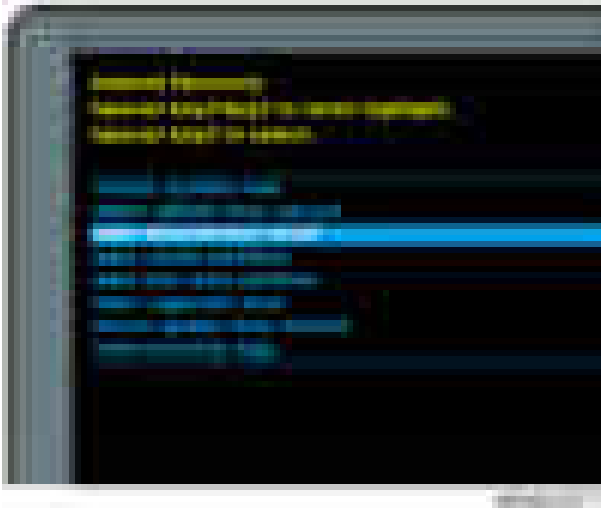

- 3.** A reconfirmation screen is displayed. Select [Yes].



The message "wiping data..." appears and the data and cache are cleared (within 1 minute).

On completion, the displayed screen returns to the recovery mode menu.

If you reboot the machine as is, the machine cannot display the messages in the local language because of the absence of the LegacyUI data.

The pre-installed applications have also been deleted, so the alert appears.

For restoration, follow the installation procedure of package firmware, and update it.

Errors that occur during application update from an SD card

8.Smart Operation Panel G2.5

Error Messages

Error message	Explanation	Solution
Insert a correct SD card.	-	<ul style="list-style-type: none"> Remove the SD card and insert it again. Make sure that the directory of the SD card is correct. You must create the "app" folder in the root directory of the SD card and put the zip file in the "app" folder.
You are trying to install the same application with a different part number. Is it OK to continue?	Displayed when you attempt to update an application that is the same but has a different part number.	Check the file, and select [OK] or [Cancel].
Some applications could not be installed.	Displayed in the following cases. <ul style="list-style-type: none"> You attempted to update a module (application) in use. The application is corrupted. 	Restart the control panel and repeat the update procedure.
- (The application you want to update is not displayed in the list of applications.)	-	<ul style="list-style-type: none"> Make sure that the directory of the SD card is correct. You must create the "app" folder in the root directory of the SD card and put the zip file in the "app" folder. Check the application file in the SD card.

Error Codes

Error codes may appear along with the message reporting the installation failure.

Error Code	Explanation
215-01	Installation of an application that cannot be used according to the system configuration was attempted. (Example: This occurs when installing an application with the copier, scanner and fax functions on a non-MFP printer. However, if any of these functions can be used, the application with such multiple functions can be installed.)
215-02	This occurs if the hard disk cannot be used.
215-03	An application that does not match the type (LP/MFP) or model has been installed. *

Error Code	Explanation
215-04	Installation of an application that cannot be installed for Basic model was attempted.
221	The system cannot stop the application for the update or uninstallation.
222	The signature is not authentic.
235	The signature is not authentic.

* If the model information (type or model) does not match, even if SC215-03 does light up at the time of installation, the error message may appear the next time the machine is started. The message shows the model information of the correct firmware and installed firmware. This can be restored by updating the firmware to the version with the correct model information.

Errors that occur during update from the eDC Server

Example of an error code display



XXX (3 digit error)

Error code	Explanation
101	Server connection error
102	Signature verification error
103	License error (for example, the product key was keyed in wrongly)
215	Dependency check error Displayed when the control panel firmware version does not meet the installation requirement of the application. Example: The firmware version of the control panel is 1.02 and you attempted to install an application that requires firmware version 1.03.
20X	Other errors



- An additional 3-digit code may be displayed to indicate the details.
Example: 101-805

8.Smart Operation Panel G2.5

XXX -XXX (3 digit-3 digit error)

Error code	Explanation	Solution
101-801	Connection Timeout	Check the network settings of the device. <ul style="list-style-type: none"> • Network selection (MFP / Operation Panel) • IP address • Default gateway • Check DNS etc.
101-802	SSL communication failed	Check the network settings of the device.
101-803	Proxy authentication failed	Check the proxy settings of the device.
101-804	Proxy Connection Timeout	Check the proxy settings of the device.
101-805	The server is under maintenance. Connection timeout. (An incorrect network was selected on the operation panel.)	Resume the operation after completing the server maintenance. Check the machine's network settings.
103-705	Executed activation for an already-activated machine with a different product key.	Execute the update, not activation.
201-700	Activation is being attempted from a device with an unauthorized serial number.	Check the machine's network settings.
203-706	License update has been executed using a deactivated product key. => User operation is required because the settings remain even after deactivation.	Execute activation, not license update.



Other Troubleshooting

Operation Panel Unit

HW: Hardware issue, SW: Software issue

No.	Symptom		Cause	Solution
1	Both the Smart Operation Panel and the blue LED on the operation panel do not turn on.	HW	The Smart Operation Panel cannot be supplied with electrical power.	1. Reconnect the USB cable between the BICU and the Smart Operation Panel.

8.Smart Operation Panel G2.5

No.	Symptom		Cause	Solution
				<ol style="list-style-type: none"> <u>2.</u> Replace the USB cable. <u>3.</u> Replace the main controller board. <u>4.</u> Replace the BICU.
2	<p>The Smart Operation Panel does not turn on, but the blue LED on the operation panel turns on.</p> 	HW	<p>The Smart Operation Panel can be supplied with electrical power (blue LED lamp), but nothing can be displayed on the LCD.</p>	<ol style="list-style-type: none"> <u>1.</u> Reconnect the LCD I/F cable. <u>2.</u> Replace the LCD. <u>3.</u> Replace the main controller board. <u>4.</u> Replace the LCD I/F cable.
3	<p>A splash (blue) screen or "Please wait" message stays on the display.</p> 	SW HW	<p>The Smart Operation Panel and LCD can be supplied with electrical power, but software issues occur during the boot-up sequence.</p> <p>Firmware or eMMC data on the Board is defective.</p>	<ol style="list-style-type: none"> <u>1.</u> Update the Cheetah System firmware in recovery mode. <u>2.</u> Do a factory reset. <u>3.</u> Replace the main controller board.

IM C4500/C5500/C6000
IM C2000/C2500/C3000/C3500
D0BN/D0BP/D0BQ
D0BJ/D0BK/D0BL/D0BM
Appendices
Ver. 1.0

Latest Release: December, 2018
Initial Release: December, 2018
(c) 2018 Ricoh Co.,Ltd.

Table of Contents

1. Specifications.....	3
Machine Specifications.....	3
General Specifications.....	3
Document Server Specifications.....	8
Printer Specifications.....	8
Scanner Specifications.....	9
Other Specifications.....	12
Software Accessories.....	21
Printer Drivers.....	21
Scanner and LAN Fax Drivers.....	23
Supported Paper Sizes.....	24
Original Size Detection.....	24
Paper Feed.....	25
Paper Exit.....	35
2. Preventive Maintenance.....	64
PM PartsTable for Main Machine.....	64
PM PartsTable for Peripherals.....	68
Periodic Inspection/Cleaning for Main Machine.....	70
Periodic Inspection/Cleaning for Peripherals.....	72
3. SP Mode Tables.....	75
Service Program Mode.....	75
Entering SP Mode.....	75
Exiting SP Mode.....	76
Types of SP Modes.....	76
Remarks.....	79
Engine SP Mode Tables for IM C3500 / C3000 / C2500 / C2000.....	81
Engine SP Tables-1.....	81
Engine SP Tables-2.....	206
Engine SP Tables-3.....	547
Engine SP Tables-4.....	658
Engine SP Tables-5.....	686
Engine SP Tables-6.....	718
Engine SP Tables-7.....	778
Engine SP Mode Tables for IM C6000 / C5500 / C4500.....	844
Engine SP Tables-1.....	844
Engine SP Tables-2.....	969
Engine SP Tables-3.....	1293

Engine SP Tables-4.....	1382
Engine SP Tables-5.....	1410
Engine SP Tables-6.....	1435
Engine SP Tables-7.....	1495
Controller SP Mode Tables	1558
Controller SP Tables-5	1558
Controller SP Tables-6	1625
Controller SP Tables-7	1626
Controller SP Tables-8	1664
Input and Output Check.....	1754
Input Check Table.....	1754
Output Check Table.....	1773
Printer Service Menu	1790
SP1-XXX (Service Mode)	1790
Scanner Service Menu	1805
SP1-XXX (System and Others)	1805
SP2-XXX (Scanning-image Quality).....	1807
SP3-XXX.....	1809
4. Software Configuration	1812
Printing Features	1812
Behavior of USB Printer Detection	1812
Auto PDL Detection Function	1812
Print Images Rotation	1816
PJM USTATUS.....	1817
Adjustment.....	1819
Scanner Settings	1822
Display settings of recently used scan destination.....	1822
The Setting of SMTP authentication in Scan to Email	1822
Determining the Account Used for Scan to Folder.....	1824
Security Features	1826
How to Restrict Access to the WIM Job Menu	1826
How to Restrict Web Image Monitor Access to the Document Server	1826
User Authentication for Specific MFP Applications	1827

1. Specifications

Machine Specifications

General Specifications

Item	Spec.
Configuration:	Desk Top
Memory:	2GB
Color support:	Full color
Warm-up-time: (23°C (73.4°F), rated voltage)	IM C2000/C2500/C3000/C3500: 26 seconds IM C4500/C5500/C6000: 24 seconds
First copy time: (A4 Portrait, Tray 1, exposure glass)	<ul style="list-style-type: none"> • IM C2000/C2500: FC: 5.5 seconds B&W: 7.7 seconds • IM C3000/C3500: FC: 4.6 seconds B&W: 7.3 seconds • IM C4500: FC: 4.0 seconds B&W: 5.7 seconds • IM C5500/C6000: FC: 3.1 seconds B&W: 4.6 seconds
Copy/print speed (A4/LT: LEF):	<ul style="list-style-type: none"> • IM C2000: 20 sheets/minute • IM C2500: 25 sheets/minute • IM C3000: 30 sheets/minute • IM C3500: 35 sheets/minute • IM C4500: 45 sheets/minute • IM C5500: 55 sheets/minute • IM C6000: 60 sheets/minute
Maximum original size:	A3 SEF (297 x 420mm), 11 x 17 SEF (279 x 432mm): A3/DLT full size
Original scanning area	<ul style="list-style-type: none"> • Exposure Glass

1.Specifications

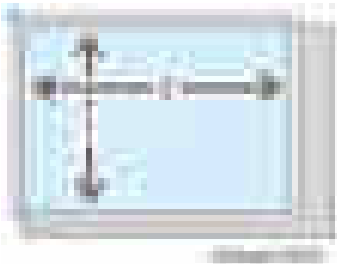
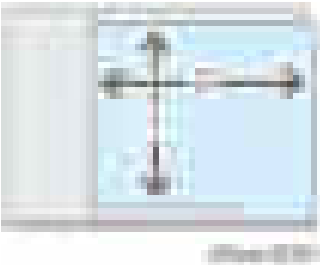
Item	Spec.
	 <p>1. Vertical: Up to 297 mm 2. Horizontal: Up to 432 mm</p> <ul style="list-style-type: none"> • ADF  <p>1. Vertical: 128 to 297 mm 2. Horizontal</p> <ul style="list-style-type: none"> • Copier function: 128 to 1,260 mm • Scanner function: 128 to 432 mm • Facsimile function: 128 to 1,200 mm
Originals	Sheet, book, three-dimensional object
Paper size: main machine	<ul style="list-style-type: none"> • Main unit upper tray (1st tray): A4 LEF, LT LEF • Main unit lower tray (2nd tray): Paper sizes that can be detected automatically EU: A3 SEF, A4 LEF/SEF, A5 LEF, B4 JIS SEF, B5 JIS LEF/SEF, 8¹/₂ × 11SEF, SRA3 SEF NA: A4 SEF, A5 LEF, B5 JIS SEF, 11 × 17 SEF, 8¹/₂ × 14 SEF, 8¹/₂ × 11 LEF/SEF , 7¹/₄ × 10¹/₂ LEF, 12 × 18 SEF, 8¹/₂ × 13²/₅ SEF Select the paper size using the Tray Paper Settings menu EU: A5 SEF, A6 SEF, B6 JIS SEF, 11 × 17 SEF, 8¹/₂ × 14 SEF, 8¹/₂ × 13 SEF, 8¹/₂ × 11LEF, 8¹/₄ × 14 SEF, 8¹/₄ × 13 SEF, 8 × 13 SEF, 8 × 10 SEF, 7¹/₄ × 10¹/₂ LEF/SEF, 5¹/₂ × 8¹/₂ SEF, 8K SEF, 16K LEF/SEF, 12 × 18 SEF, 11 × 15 SEF, 10 × 14 SEF, 8¹/₂ × 13²/₅ SEF NA: A3 SEF, A4 LEF, A5 SEF, A6 SEF, B4 JIS SEF, B5 JIS LEF, B6 JIS SEF, 8¹/₂ × 13 SEF, 8¹/₄ × 14 SEF, 8¹/₄ × 13 SEF, 8 × 13 SEF, 8 × 10 SEF, 7¹/₄ × 10¹/₂ SEF, 5¹/₂ × 8¹/₂ SEF, 8K SEF, 16K LEF/SEF, 11 × 15 SEF, 10 × 14 SEF, SRA3 SEF

Item	Spec.
	<p>Custom size Vertical: 90.0–320.0 mm Horizontal: 148.0–457.2 mm</p> <ul style="list-style-type: none"> • Duplex: A3 SEF, A4, A5, A6 SEF, B4 JIS SEF, B5 JIS, B6 JIS SEF, 11 × 17 SEF, 8¹/₂ × 14 SEF, 8¹/₂ × 13 SEF, 8¹/₂ × 11, 8¹/₄ × 14 SEF, 8¹/₄ × 13 SEF, 8 × 13 SEF, 8 × 10 SEF, 7¹/₄ × 10¹/₂, 5¹/₂ × 8¹/₂ SEF, 8K SEF, 16K, 12×18 SEF, 11 × 15 SEF, SRA3 SEF, SRA4, 8¹/₂ × 13²/₅ SEF • Duplex (Custom Size): Vertical: 90.0–320.0 mm (3.55-12.59 inches) Horizontal: 148.0–457.2 mm (5.83–18.00 inches) • Envelopes Select the paper size using the Tray Paper Settings menu: 4¹/₈ × 9¹/₂ LEF/SEF, 3⁷/₈ × 7¹/₂ SEF, C5 Env LEF/SEF, C6 Env LEF/SEF, DL Env LEF/SEF
Paper size: bypass tray	<ul style="list-style-type: none"> • Paper sizes that can be detected automatically EU: A3 SEF, A4 LEF/SEF, A5 LEF/SEF, A6 SEF, B4 JIS SEF, B5 JIS LEF/SEF, B6 JIS SEF, SRA3 SEF NA: A5 LEF, B5 JIS SEF, 11 x 17 SEF, 8¹/₂ × 11 LEF/SEF, 5¹/₂ × 8¹/₂ SEF, 12 x18 SEF, SRA3 SEF • Select the paper size in the application EU: 11 × 17 SEF, 8¹/₂ × 14 SEF, 8¹/₂ × 13 SEF, 8¹/₂ × 11 LEF/ SEF, 8¹/₄ × 14 SEF, 8¹/₄ × 13 SEF, 8 × 13 SEF, 8 × 10 SEF, 7¹/₄ × 10¹/₂ LEF/SEF, 5¹/₂ × 8¹/₂ SEF, 8K SEF, 16K LEF/SEF, 12 × 18 SEF, 11 × 15 SEF, 10 × 14 SEF, SRA4 LEF/SEF, 8¹/₂ × 13²/₅ SEF NA: A3 SEF, A4 LEF/SEF, A5 SEF, A6 SEF, B4 JIS SEF, B5 JIS LEF, B6 JIS SEF, 8¹/₂ × 14 SEF, 8¹/₂ × 13 SEF, 8¹/₄ × 14 SEF, 8¹/₄ × 13 SEF, 8 × 13 SEF, 8 × 10 SEF, 7¹/₄ × 10¹/₂ LEF/SEF, 8K SEF, 16K LEF/SEF, 11 × 15 SEF, 10 × 14 SEF, SRA4 LEF/SEF, 8¹/₂ × 13²/₅ SEF • Custom size Vertical: 90.0–320.0 mm Horizontal: 148.0–457.2 mm • Envelopes 4¹/₈ × 9¹/₂ LEF/SEF, 3⁷/₈ × 7¹/₂ SEF, C5 Env LEF/SEF, C6 Env LEF/SEF,

1. Specifications

Item	Spec.
	DL Env LEF/SEF
Paper size: 3rdr/4th trays	<ul style="list-style-type: none"> • Paper sizes that can be detected automatically EU: A3 SEF, A4 LEF/SEF, A5 LEF, B4 JIS SEF, B5 JIS LEF/SEF, 8¹/₂ × 11 SEF, SRA3 SEF NA: A4 LEF, A5 SEF, A6 SEF, B4 JIS SEF, B5 JIS LEF, B6 JIS SEF, 8¹/₂ × 13 SEF, 8¹/₄ × 14 SEF, 8¹/₄ × 13 SEF, 8 × 13 SEF, 8 × 10 SEF, 7¹/₄ × 10¹/₂ SEF, 5¹/₂ × 8¹/₂ SEF, 8K SEF, 16K LEF/SEF, 11 × 15 SEF, 10 × 14 SEF, SRA3 SEF • Select the paper size using the Tray Paper Settings menu EU: A5 SEF, A6 SEF, B6 JIS SEF, 11 × 17 SEF, 8¹/₂ × 14 SEF, 8¹/₂ × 13 SEF, 8¹/₂ × 11LEF, 8¹/₄ × 14 SEF, 8¹/₄ × 13 SEF, 8 × 13 SEF, 8 × 10 SEF, 7¹/₄ × 10¹/₂ LEF/SEF, 5¹/₂ × 8¹/₂ SEF, 8K SEF, 16K LEF/SEF, 12 × 18 SEF, 11 × 15 SEF, 10 × 14 SEF, 8¹/₂ × 13²/₅ SEF NA: A3 SEF, A4 LEF, A5 SEF, A6 SEF, B4 JIS SEF, B5 JIS LEF, B6 JIS SEF, 8¹/₂ × 13 SEF, 8¹/₄ × 14 SEF, 8¹/₄ × 13 SEF, 8 × 13 SEF, 8 × 10 SEF, 7¹/₄ × 10¹/₂ SEF, 5¹/₂ × 8¹/₂ SEF, 8K SEF, 16K LEF/SEF, 11 × 15 SEF, 10 × 14 SEF, SRA3 SEF • Custom size Vertical: 90.0–320.0 mm Horizontal: 148.0–457.2 mm • Envelopes Select the paper size using the Tray Paper Settings menu: 4¹/₈ × 9¹/₂ LEF/SEF, 3⁷/₈ × 7¹/₂ SEF, C5 Env LEF/SEF, C6 Env LEF/SEF, DL Env LEF/SEF
Paper size: tandem LCT	A4 LEF/LT LEF
Paper size: side LCT	A4 LEF, B5 JIS LEF, 8 ¹ / ₂ × 11 LEF
Paper weight:	<ul style="list-style-type: none"> • Tray 1: 60 to 300 g/m² • Tray 2: 60 to 300 g/m² • Tray 3/4 (Optional paper feed unit): 60 to 300 g/m² • Tandem LCT: 52 to 300 g/m² • Side LCT: 52 to 300 g/m² • Bypass tray: 52 to 300 g/m² • Duplex: IM C2000/C2500: 52 to 169 g/m² IM C3000/C3500/C4500/C5500/C6000: 52 to 256 g/m²
Mask image area:	<ul style="list-style-type: none"> • Leading edge: 4.2±1.5mm (0.17 ± 0.06") • Left/Right: 0.5 to 4.0mm (0.02 to 0.16")

1.Specifications

Item	Spec.
	<ul style="list-style-type: none"> Trailing edge: 0.5 to 6.0mm (0.02 to 0.24")
Preset reproduction ratio	EU <ul style="list-style-type: none"> Enlargement: 400, 200, 141, 122, 115 Full size: 100 Reduction: 93, 82, 75, 71, 65, 50, 25 NA <ul style="list-style-type: none"> Enlargement: 400, 200, 155, 129, 121 Full size: 100 Reduction: 93, 85, 78, 73, 65, 50, 25
Copy scale (Zoom):	25 to 400% (1% steps)
Resolution (Scanning):	600dpi x 600dpi
Resolution(Writing):	600dpi x 600dpi
Gradation:	256
Feeding System / Paper Capacity:	<ul style="list-style-type: none"> 550x2 + 550x2 + 100 Sheets (4 Drawers paper feed model) 550x2 + 550x2 + 1500 + 100 Sheets (4 Drawers paper feed + side set LCT model) 550x2 + 1000x2 + 100 Sheets (Tandem paper feed model) 550x2 + 1000x2 + 1500 + 100 Sheets (Tandem paper feed + side set LCT model)
Continuous Copy:	1 to 999 Sheets
Power Source:	NA: 120-127V, 60Hz EU, AA, CN: 220-240V, 50/60Hz TW: 110V, 60Hz
Max. Watts:	1.85kW or less
Dimensions (W x D x H):	<ul style="list-style-type: none"> 587 x 685 x 788mm (Main Unit) 587 x 685 x 913mm (Equipped with the ARDF) 587 x 685 x 963mm (Equipped with the SPDF)
Unit Occupation Dimensions (W x D):	Main Unit: 1149 x 1236mm (With Bypass table opened + Main unit paper exit drawer)
Weight:	EU <ul style="list-style-type: none"> IM C2000/C2500: Approx. 83 kg (183.0 lb.) IM C3000/C3500: Approx. 86 kg (189.6 lb.) IM C4500/C5500/C6000: Approx. 88 kg (194.1 lb.) AA <ul style="list-style-type: none"> IM C2000/C2500: Approx. 83 kg (183.0 lb.) IM C3000/C3500: Approx. 86 kg (189.6 lb.)

1. Specifications

Item	Spec.
	<ul style="list-style-type: none"> IM C4500/C6000: Approx. 88 kg (194.1 lb.) NA <ul style="list-style-type: none"> IM C2000/C2500: Approx. 83 kg (183.0 lb.) IM C3000/C3500: Approx. 86 kg (189.6 lb.) IM C4500/C6000: Approx. 88 kg (194.1 lb.)

Document Server Specifications

Item	Spec.
HDD (Document Server):	Approx. 73 GB Maximum: 9,000 pages (Total number of pages that can be stored with all functions combined.) Copier/B&W/A4 original: Approx. 9,000 pages Copier/Full Color/A4 original: Approx. 2,000 pages Printer/Full Color/A4/600 dpi, 2 bits: Approx. 9,000 pages Scanner/Full Color/A4/200 dpi, 8 bits/JPEG: Approx. 9,000 pages (Under the printer and scanner modes, the number of the pages that can be stored depends on the print image and original.)
Maximum number of stored documents:	Max. 3,000 Files
Number of pages supported by memory sorting:	Maximum: 2,000 pages Copier/B&W/A4 original: Approx. 2,000 pages Printer/B&W/A4/600 dpi, 4 bits: Approx. 2,000 pages (Under the printer mode, the number of pages that can be sorted depends on the print image.)

Printer Specifications

Item	Spec.
Print Speed (A4/LT: LEF):	<ul style="list-style-type: none"> IM C2000: 20 sheets/minute IM C2500: 25 sheets/minute IM C3000: 30 sheets/minute IM C3500: 35 sheets/minute IM C4500: 45 sheets/minute IM C5500: 55 sheets/minute IM C6000: 60 sheets/minute
Resolution:	1200 x 1200dpi, 600 x 600dpi, 400 x 400dpi, 300 x 300dpi, 200 x 200dpi
Printer language:	<ul style="list-style-type: none"> Standard: RPCS, PCL 5c/6, PDF, MediaPrint (JPEG, TIFF)

Item	Spec.
	<ul style="list-style-type: none"> Option: PostScript 3, PictBridge, IPDS, XPS
Interface:	<ul style="list-style-type: none"> Standard: Ethernet. (10BASE-T/100BASE-TX/1000BASE-T) USB2.0 (Type B) port USB2.0 (Type A) port (on the control panel) SD card slot (on the control panel) Option: IEEE 1284 parallel interface IEEE 802.11a/b/g/n wireless LAN interface Expanded file format converter Extended Print Server
Network protocol:	TCP/IP (IPv4, IPv6)
USB Interface (Standard):	<ul style="list-style-type: none"> Transmission spec: USB 2.0 Standard Connectable device: Devices corresponding to USB 2.0 Standard
OS:	<ul style="list-style-type: none"> Windows Vista/7/8.1/10 Windows Server 2008/2008 R2/2012/2012 R2/2016 OS X 10.10 or later
Built-in Fonts:	<ul style="list-style-type: none"> IRIPS, PCL 5c/6: 93 fonts PDF: 136 fonts PostScript 3: 136 fonts IPDS: 108 fonts

Scanner Specifications

Item	Spec.
Type:	Full-color scanner
Scan method:	Flatbed scanning
Image sensor type:	CMOS Image Sensor
Originals:	Sheet, book, three-dimensional object
Original sizes that can be scanned:	<ul style="list-style-type: none"> Length: 10–297 mm (0.4–11 inches) Width: 10–432 mm (0.4–17 inches)
Scan sizes automatically detectable from the exposure glass:	EU: A3 SEF, A4 SEF/LEF, A5 SEF/LEF, B4 JIS SEF, B5 JIS SEF/LEF NA: 11 × 17 SEF, 8½ × 14 SEF, 8½ × 13 ² / ₅ SEF, 8½ × 11SEF/LEF, 5½ × 8½ SEF/LEF

1. Specifications

Item	Spec.
Scan sizes automatically detectable from the ADF:	EU: A3 SEF, A4 SEF/LEF, A5 SEF/LEF, B4 JIS SEF, B5 JIS SEF/LEF, B6 JIS SEF/LEF, 11 × 17 SEF, 8 ¹ / ₂ × 11 SEF/LEF NA: A3 SEF, A4 SEF/LEF, 11 × 17 SEF, 8 ¹ / ₂ × 14 SEF, 8 ¹ / ₂ × 13 ² / ₅ SEF, 8 ¹ / ₂ × 11 SEF/LEF, 7 ¹ / ₄ × 10 ¹ / ₂ SEF, 5 ¹ / ₂ × 8 ¹ / ₂ SEF/LEF, 10 × 14 SEF
Scan speed (ARDF):	80 pages/minute (black and white, full color) Scanning speed differs depending on the operating environment of the machine and computer, scan settings, and the content of originals.
Scan speed (SPDF):	<ul style="list-style-type: none"> When scanning one-sided originals (black and white, full color) 110 pages/minute When scanning two-sided originals (black and white, full color) 180 pages/minute Scanning speed differs depending on the operating environment of the machine and computer, scan settings, and the content of originals.
Tone:	<ul style="list-style-type: none"> Black & White: 2 tones Full Color/Gray Scale: 256 tones
Basic scanning resolution:	200 dpi
Image compression type for black and white (two-value):	TIFF (MH, MR, MMR, JBIG2)
Image compression type for gray scale/full color:	JPEG
Interface:	<ul style="list-style-type: none"> Standard: Ethernet. (10BASE-T/100BASE-TX/1000BASE-T) USB 2.0 (Type A) port (on the control panel) SD card slot (on the control panel) Option: IEEE 802.11a/b/g/n wireless LAN interface
Network protocol:	TCP/IP
WSD:	Supported
DSM:	Supported*1

*1 The function can be used only in Scanner (Classic mode).

E-mail transmission

Item	Spec.
Scanning resolution	100 dpi, 200 dpi, 300 dpi, 400 dpi, 600 dpi

Item	Spec.
Protocol*1	POP, SMTP*2, IMAP4
Operating system	TIFF, JPEG, PDF, High Compression PDF, PDF/A, Searchable PDF*3

*1 Supporting Web mail transmission

*2 Supporting SMTP over SSL

*3 The number of characters that can be scanned optically is about 40,000 characters per page.

Scan to Folder

Item	Spec.
Scanning resolution	100 dpi, 200 dpi, 300 dpi, 400 dpi, 600 dpi
Protocol	SMB, FTP <ul style="list-style-type: none"> • You can use SMB protocol (139/TCP, 137/UDP) or CIFS protocol (445/TCP) for sending folders with SMB. • The Scan to Folder function with SMB protocol (139/TCP, 137/UDP) is enabled under NetBIOS over TCP/IP environment only. • You cannot use the Scan to Folder function with SMB under NetBEUI.
Operating system	TIFF, JPEG, PDF, High Compression PDF, PDF/A, Searchable PDF*1

*1 The number of characters that can be scanned optically is about 40,000 characters per page.

Network TWAIN Scanner

Item	Spec.
Scanning resolution	100–1,200 dpi*1
Protocol	TCP/IP
Operating system	<ul style="list-style-type: none"> • Windows Vista/7/8.1/10 • Windows Server 2008/2008 R2/2012/2012 R2/2016 (TWAIN scanner runs in 32-bit compatible mode on a 64-bit operating system, so TWAIN scanner is not compatible with 64-bit applications. Use 32-bit applications. IC card Authentication System is not compatible with 64-bit operating system.)

*1 The maximum resolution depends on the scan size.

WIA scanner

Item	Spec.
Scanning resolution	100–1,200 dpi*1

1. Specifications

Item	Spec.
(Main scanning × Subscanning)	
Protocol	TCP/IP
Operating system	<ul style="list-style-type: none"> Windows Vista (Service Pack 1 or later)/7/8.1/10 Windows Server 2008/2008 R2/2012/2012 R2/2016 (WIA scanner can function under both 32- and 64-bit operating systems.)

*1 The maximum resolution depends on the scan size.

Other Specifications

Banner Paper Guide Tray Type M19

Item	Specifications
Dimensions (W x D x H):	<p>Main Tray</p> <p>Tray is folded: 370 x 250 x 70 mm</p> <p>Tray is expanded: 370 x 250 x 250 mm</p> <p>Sub Tray</p> <p>Tray is folded: 150 x 110 x 15 mm</p> <p>Tray is expanded: 150 x 110 x 100 mm</p> <p>Lock Plate</p> <p>Locked: 135 x 150 x 25 mm</p> <p>Unlocked: 135 x 220 x 25 mm</p>
Weight:	<p>Main Tray: 942 g</p> <p>Sub Tray: 245 g</p> <p>Lock Plate: 280 g</p>

OFF / Sleep Mode Shift Time

Item	Spec.
Sleep Mode Shift Time:	Default value: 1 min., 1 to 60min., 1 min. per step
System All Reset Time:	Default value: 60 sec., 10 to 999 sec., 1 sec. per step "Do Not Clear" can be selected.

Sleep Mode Watts, Recovering Time

EU/AA

Model Name	Power Consumption	Time to Recover from Sleep Mode
IM C2000	0.55 W	6.1 seconds
IM C2500	0.55 W	6.1 seconds
IM C3000	0.55 W	6.0 seconds
IM C3500	0.55 W	6.0 seconds
IM C4500	0.62 W	7.0 seconds
IM C5500	0.62 W	8.1 seconds
IM C6000	0.62 W	8.1 seconds

NA

Model Name	Power Consumption	Time to Recover from Sleep Mode
IM C2000	0.54 W	6.6 seconds
IM C2500	0.54 W	6.6 seconds
IM C3000	0.53 W	6.3 seconds
IM C3500	0.53 W	6.3 seconds
IM C4500	0.59 W	6.3 seconds
IM C6000	0.59 W	7.9 seconds

- Depending on operating environment and usage status, power consumption in Sleep mode might change.
(Such cases as power change for fusing unit temperature control when in a low temperature environment, or network environment obstructs switching to STR mode.)

Noise Emission

EU**Noise emission (Sound power level: Main unit only)**

- IM C2000/C2000A**
Stand-by: 30.5 dB (A)
Copying: B&W: 57.1 dB (A) / Color: 57.9 dB (A)
- IM C2500/C2500A**
Stand-by: 30.5 dB (A)
Copying: B&W: 57.4 dB (A) / Color: 58.1 dB (A)
- IM C3000/C3000A**
Stand-by: 31.4 dB (A)

1. Specifications

Copying: B&W: 58.4 dB (A) / Color: 58.6 dB (A)

- **IM C3500/C3500A**

Stand-by: 31.4 dB (A)

Copying: B&W: 58.7 dB (A) / Color: 59.9 dB (A)

- **IM C4500/C4500A**

Stand-by: 31.4 dB (A)

Copying: B&W: 60.8 dB (A) / Color: 61.5 dB (A)

- **IM C5500/C5500A**

Stand-by: 31.4 dB (A)

Copying: B&W: 62.7 dB (A) / Color: 63.7 dB (A)

- **IM C6000**

Stand-by: 31.4 dB (A)

Copying: B&W: 62.9 dB (A) / Color: 64.0 dB (A)

Noise emission (Sound power level: Complete system)

- **IM C2000/C2000A**

Stand-by: 31.3 dB (A)

Copying: 65.0 dB (A)

- **IM C2500/C2500A**

Stand-by: 31.3 dB (A)

Copying: 66.0 dB (A)

- **IM C3000/C3000A**

Stand-by: 33.6 dB (A)

Copying: 67.1 dB (A)

- **IM C3500/C3500A**

Stand-by: 33.6 dB (A)

Copying: 67.6 dB (A)

- **IM C4500/C4500A**

Stand-by: 33.7 dB (A)

Copying: 69.1 dB (A)

- **IM C5500/C5500A**

Stand-by: 33.7 dB (A)

Copying: 70.1 dB (A)

- **IM C6000**

Stand-by: 33.7 dB (A)

Copying: 70.4 dB (A)

Noise emission (Sound pressure level: Main unit only)

- **IM C2000/C2000A**

Stand-by: 20.4 dB (A)

Copying: B&W: 43.4 dB (A) / Color: 44.1 dB (A)

- **IM C2500/C2500A**

Stand-by: 20.4 dB (A)

Copying: B&W: 44.2 dB (A) / Color: 44.7 dB (A)

- **IM C3000/C3000A**

Stand-by: 20.3 dB (A)

Copying: B&W: 45.4 dB (A) / Color: 45.7 dB (A)

- **IM C3500/C3500A**

Standby: 20.3 dB (A)

Copying: B&W: 45.8 dB (A) / Color: 46.4 dB (A)

- **IM C4500/C4500A**

Stand-by: 20.1 dB (A)

Copying: B&W: 47.2 dB (A) / Color: 47.9 dB (A)

- **IM C5500/C5500A**

Stand-by: 20.1 dB (A)

Copying: B&W: 49.5 dB (A) / Color: 50.7 dB (A)

- **IM C6000**

Stand-by: 20.1 dB (A)

Copying: B&W: 50.0 dB (A) / Color: 50.8 dB (A)

Noise emission (Sound pressure level: Complete system)

- **IM C2000/C2000A**

Stand-by: 20.9 dB (A)

Copying: 52.8 dB (A)

- **IM C2500/C2500A**

Stand-by: 20.9 dB (A)

Copying: 53.7 dB (A)

- **IM C3000/C3000A**

Stand-by: 20.1 dB (A)

Copying: 52.7 dB (A)

- **IM C3500/C3500A**

Stand-by: 20.1 dB (A)

Copying: 53.2 dB (A)

- **IM C4500/C4500A**

Stand-by: 19.5 dB (A)

Copying: 55.0 dB (A)

- **IM C5500/C5500A**

Stand-by: 19.5 dB (A)

Copying: 55.7 dB (A)

1. Specifications

- **IM C6000**

Stand-by: 19.5 dB (A)

Copying: 56.3 dB (A)

AA

Noise emission (Sound power level: Main unit only)

- **IM C2000**

Stand-by: 30.5 dB (A)

Copying: B&W: 57.1 dB (A) / Color: 57.9 dB (A)

- **IM C2500**

Stand-by: 30.5 dB (A)

Copying: B&W: 57.4 dB (A) / Color: 58.1 dB (A)

- **IM C3000**

Stand-by: 31.4 dB (A)

Copying: B&W: 58.4 dB (A) / Color: 58.6 dB (A)

- **IM C3500**

Stand-by: 31.4 dB (A)

Copying: B&W: 58.7 dB (A) / Color: 59.9 dB (A)

- **IM C4500**

Stand-by: 31.4 dB (A)

Copying: B&W: 60.8 dB (A) / Color: 61.5 dB (A)

- **IM C6000**

Stand-by: 31.4 dB (A)

Copying: B&W: 62.9 dB (A) / Color: 64.0 dB (A)

Noise emission (Sound power level: Complete system)

- **IM C2000**

Stand-by: 31.3 dB (A)

Copying: 65.0 dB (A)

- **IM C2500**

Stand-by: 31.3 dB (A)

Copying: 66.0 dB (A)

- **IM C3000**

Stand-by: 33.6 dB (A)

Copying: 67.1 dB (A)

- **IM C3500**

Stand-by: 33.6 dB (A)

Copying: 67.6 dB (A)

- **IM C4500**

Stand-by: 33.7 dB (A)

Copying: 69.1 dB (A)

- **IM C6000**

Stand-by: 33.7 dB (A)

Copying: 70.4 dB (A)

Noise emission (Sound pressure level: Main unit only)

- **IM C2000**

Stand-by: 20.4 dB (A)

Copying: B&W: 43.4 dB (A) / Color: 44.1 dB (A)

- **IM C2500**

Stand-by: 20.4 dB (A)

Copying: B&W: 44.2 dB (A) / Color: 44.7 dB (A)

- **IM C3000**

Stand-by: 20.3 dB (A)

Copying: B&W: 45.4 dB (A) / Color: 45.7 dB (A)

- **IM C3500**

Stand-by: 20.3 dB (A)

Copying: B&W: 45.8 dB (A) / Color: 46.4 dB (A)

- **IM C4500**

Stand-by: 20.1 dB (A)

Copying: B&W: 47.2 dB (A) / Color: 47.9 dB (A)

- **IM C6000**

Stand-by: 20.1 dB (A)

Copying: B&W: 50.0 dB (A) / Color: 50.8 dB (A)

Noise emission (Sound pressure level: Complete system)

- **IM C2000**

Stand-by: 20.9 dB (A)

Copying: 52.8 dB (A)

- **IM C2500**

Stand-by: 20.9 dB (A)

Copying: 53.7 dB (A)

- **IM C3000**

Stand-by: 20.1 dB (A)

Copying: 52.7 dB (A)

- **IM C3500**

Stand-by: 20.1 dB (A)

Copying: 53.2 dB (A)

1.Specifications

- **IM C4500**
Stand-by: 19.5 dB (A)
Copying: 55.0 dB (A)
- **IM C6000**
Stand-by: 19.5 dB (A)
Copying: 56.3 dB (A)

NA

Noise emission (Sound power level: Main unit only)

- **IM C2000/C2000G**
Stand-by: 30.5 dB (A)
Copying: B&W: 57.1 dB (A) / Color: 57.9 dB (A)
- **IM C2500/C2500G**
Stand-by: 30.5 dB (A)
Copying: B&W: 57.4 dB (A) / Color: 58.1 dB (A)
- **IM C3000/C3000G**
Stand-by: 31.4 dB (A)
Copying: B&W: 58.4 dB (A) / Color: 58.6 dB (A)
- **IM C3500/C3500G**
Stand-by: 31.4 dB (A)
Copying: B&W: 58.7 dB (A) / Color: 59.9 dB (A)
- **IM C4500/C4500G**
Stand-by: 31.4 dB (A)
Copying: B&W: 60.8 dB (A) / Color: 61.5 dB (A)
- **IM C6000/C6000G**
Stand-by: 31.4 dB (A)
Copying: B&W: 62.9 dB (A) / Color: 64.0 dB (A)

Noise emission (Sound power level: Complete system)

- **IM C2000/C2000G**
Stand-by: 31.3 dB (A)
Copying: 65.2 dB (A)
- **IM C2500/C2500G**
Stand-by: 31.3 dB (A)
Copying: 66.1 dB (A)
- **IM C3000/C3000G**
Stand-by: 33.6 dB (A)

Copying: 67.1 dB (A)

- **IM C3500/C3500G**

Stand-by: 33.6 dB (A)

Copying: 67.6 dB (A)

- **IM C4500/C4500G**

Stand-by: 33.7 dB (A)

Copying: 69.1 dB (A)

- **IM C6000/C6000G**

Stand-by: 33.7 dB (A)

Copying: 70.4 dB (A)

Noise emission (Sound pressure level: Main unit only)

- **IM C2000/C2000G**

Stand-by: 20.4 dB (A)

Copying: B&W: 43.4 dB (A) / Color: 44.1 dB (A)

- **IM C2500/C2500G**

Stand-by: 20.4 dB (A)

Copying: B&W: 44.2 dB (A) / Color: 44.7 dB (A)

- **IM C3000/C3000G**

Stand-by: 20.3 dB (A)

Copying: B&W: 45.4 dB (A) / Color: 45.7 dB (A)

- **IM C3500/C3500G**

Stand-by: 20.3 dB (A)

Copying: B&W: 45.8 dB (A) / Color: 46.4 dB (A)

- **IM C4500/C4500G**

Stand-by: 20.1 dB (A)

Copying: B&W: 47.2 dB (A) / Color: 47.9 dB (A)

- **IM C6000/C6000G**

Stand-by: 20.1 dB (A)

Copying: B&W: 50.0 dB (A) / Color: 50.8 dB (A)

Noise emission (Sound pressure level: Complete system)

- **IM C2000/C2000G**

Stand-by: 20.8 dB (A)

Copying: 53.1 dB (A)

- **IM C2500/C2500G**

Stand-by: 20.8 dB (A)

Copying: 53.9 dB (A)

- **IM C3000/C3000G**

1. Specifications

Stand-by: 20.1 dB (A)

Copying: 52.7 dB (A)

- **IM C3500/C3500G**

Stand-by: 20.1 dB (A)

Copying: 53.2 dB (A)

- **IM C4500/C4500G**

Stand-by: 19.5 dB (A)

Copying: 55.0 dB (A)

- **IM C6000/C6000G**

Stand-by: 19.5 dB (A)

Copying: 56.3 dB (A)

Software Accessories

The printer drivers and utility software are provided on one CD-ROM. An auto-run installer allows you to select which components to install.

Printer Drivers

OS	Type	PCL5 Generic	PCL6	PostScript3 (Adobe/Emulation)
Windows 2000	Professional	N	N	N
	Server	N	N	N
	Advanced Server	N	N	N
	Detacener Server	N	N	N
Windows XP	Professional	N	N	N
	Home Edition	N	N	N
	Media Center Edition	N	N	N
	Tablet PC Edition	N	N	N
	Professional x64 Edition	N	N	N
Windows Vista	Starter	N	N	N
	Home Basic	N	N	N
	Home Premium	N	N	N
	Business	N	N	N
	Ultimate	N	N	N
	Enterprise	N	N	N
Windows 7	Starter	N	N	N
	Home Basic	N	N	N
	Home Premium	Y	Y	Y
	Professional	Y	Y	Y
	Ultimate	Y	Y	Y
	Enterprise	Y	Y	Y
Windows 8	Windows 8	N	N	N
	Pro	N	N	N
	Enterprise	N	N	N
	RT	N	N	N
Windows Server 2003	Standard Edition	N	N	N
	Enterprise Edition	N	N	N
	Datacenter Edition	N	N	N
	Web Edition	N	N	N
Windows Server 2003 R2	Standard Edition	N	N	N

1.Specifications

OS	Type	PCL5 Generic	PCL6	PostScript3 (Adobe/Emulation)
	Enterprise Edition	N	N	N
	Datacenter Edition	N	N	N
Windows Server 2008	Standard Edition	Y	Y	Y
	Enterprise Edition	Y	Y	Y
	Standard without Hyper-V	Y	Y	Y
	Enterprise without Hyper-V	Y	Y	Y
	Datacenter Edition	N	N	N
	Web Edition	N	N	N
Windows Server 2008R2	Standard Edition	Y	Y	Y
	Enterprise Edition	Y	Y	Y
	Datacenter Edition	N	N	N
	Web Edition	N	N	N
Windows Server 2012	Foundation	Y	Y	Y
	Essentials	Y	Y	Y
	Standard	Y	Y	Y
	Datacenter	N	N	N
Windows 8.1	Windows 8.1	Y	Y	Y
	Pro	Y	Y	Y
	Enterprise	Y	Y	Y
	RT	N	N	N
Windows Server 2012 R2	Foundation	Y	Y	Y
	Essentials	Y	Y	Y
	Standard	Y	Y	Y
	Datacenter	N	N	N
Windows 10	Home	Y	Y	Y
	Pro	Y	Y	Y
	Enterprise	Y	Y	Y
	Education	Y	Y	Y
Windows Server 2016	Essentials	Y	Y	Y
	Standard	Y	Y	Y
	Datacenter	Y	Y	Y
	MultiPoint Premium Server	Y	Y	Y

*RPCS driver has been discontinued.

*XPS driver has been discontinued.

Scanner and LAN Fax Drivers

Operating System	TWAIN ^{*1}	PC-FAX
Windows Vista	Supported	Supported
Windows 7	Supported	Supported
Windows 8	Supported	Supported
Windows 8.1	Supported	Supported
Windows 10	Supported	Supported
Windows Server 2003/2003 R2	Supported	Supported
Windows Server 2008/2008 R2	Supported	Supported
Windows Server 2012/2012 R2	Supported	Supported
OS X	Not available	Not available

*1 TWAIN scanner runs on a 64-bit operating system, but is not compatible with 64-bit applications. Use it with 32-bit applications.

Supported Paper Sizes

Original Size Detection

Size (W x L) [mm]	NA		EU/AP	
	Book	ADF	Book	ADF
A3 SEF (297 x 420)	-	Y	Y ^{*4}	Y
B4 SEF (257 x 364)	-	-	Y ^{*4}	Y
A4 SEF (210 x 297)	Y ^{*5}	Y	Y ^{*4, 5}	Y
A4 LEF (297 x 210)	Y ^{*5}	Y	Y ^{*4, 5}	Y
B5 SEF (182 x 257)	-	-	Y ^{*4}	Y
B5 LEF (257 x 182)	-	-	Y ^{*4}	Y
A5 SEF (148 x 210)	-	-	Y ^{*2, 4}	Y
A5 LEF (210 x 148)	-	-	Y ^{*4}	Y
B6 SEF (128 x 182)	-	-	-	Y
B6 LEF (182 x 128)	-	-	-	Y
DLT SEF (11" x 17")	Y	Y ^{*Db}	-	Y ^{*Df}
LG SEF (8 ¹ / ₂ " x 14")	Y	Y ^{*Dc}	-	-
LT SEF (8 ¹ / ₂ " x 11")	Y ^{*5}	Y ^{*Dd}	Y ^{*5}	Y ^{*Di}
LT LEF (11" x 8 ¹ / ₂ ")	Y ^{*5}	Y ^{*De}	Y ^{*5}	Y ^{*Dg}
HLT SEF (5 ¹ / ₂ " x 8 ¹ / ₂ ")	Y ^{*2}	Y	-	-
HLT LEF (8 ¹ / ₂ " x 5 ¹ / ₂ ")	Y	Y	-	-
F SEF (8" x 13")	-	-	Y ^{*S3}	Y ^{*S3}
Foolscap SEF (8 ¹ / ₂ " x 13")	-	Y ^{*Sc}	Y ^{*D3}	Y ^{*D3}
Folio SEF (8 ¹ / ₄ " x 13")	-	-	Y ^{*S3}	Y ^{*S3}
Folio SEF (11" x 15")	-	Y ^{*Sb}	-	-
Folio SEF (10" x 14")	-	Y	-	-
Folio SEF (8" x 10")	-	Y ^{*Sd}	-	-
US EXE SEF (7 ¹ / ₄ " x 10 ¹ / ₂ ")	-	Y	-	-
US EXE LEF (10 ¹ / ₂ " x 7 ¹ / ₄ ")	-	Y ^{*Se}	-	-
8K SEF (267 x 390)	-	-	Y ^{*4}	Y ^{*Sf}
16K SEF (195 x 267)	-	-	Y ^{*4}	Y ^{*Si}
16K LEF (267 x 195)	-	-	Y ^{*4v}	Y ^{*Sg}

Sizes with letters (a, b, c) means only either size with the corresponding letter can be selected for size detection. "D" is for default set sizes, and when setting "S" sizes for size detection from SP mode, "D" sizes can no longer be detected.

(*2)For detected originals smaller than A5 size, with SP mode either "detect as A5" or "Detect as Unknown" can be selected. (Default is "Detect as unknown")

(*3)F Sizes (8.5" x 13" SEF, 8.25" x 13" SEF, 8" x 13" SEF) will be available by SP mode settings.

(*4)Switch Book scanner original detection between “K” series and ”A/B” series from SP mode.

(Can not set both to detect, but 8K/16K detect can de set from SO mode)

8K SEF -> Switch between A3, B4 SEF

16K SEF -> Switch between A4, A5, B5 SEF

16K LEF -> Switch between A4, A5, B5 LEF *Can not switch only either size.

(*5)Can be selected with switching A4/LT from SP mode:

- Standard detect (default)
- When placing A4/LT size LEF, detect as A4 LEF. When placing SEF, detect as LT SEF.
- When placing A4/LT size LEF, detect as LT LEF. When placing SEF, detect as A4 SEF.

Remarks:

Y	Yes; available
-	Not available

Paper Feed

Tray 1 and 2

Size code	Size (W x L) [mm]	Tray1			Tray2		
		NA	EU	AA	NA	EU	AA
132	A3 SEF (297 x 420)	-	-	-	G2	A2	A2
133	A4 SEF (210 x 297)	-	-	-	A	A	A
005	A4 LEF (297 x 210)	K	H	H	G1	A1	A1
134	A5 SEF (148 x 210)	-	-	-	B	B	B
006	A5 LEF (210 x 148)	K	K	K	A	A	A
135	A6 SEF (105 x 148)	-	-	-	B	B	B
141	B4 SEF (257 x 364)	-	-	-	G3	A3	A3
142	B5 SEF (182 x 257)	-	-	-	A	A	A
014	B5 LEF (257 x 182)	K	K	K	G4	A4	A4
143	B6 SEF (128 x 182)	-	-	-	B	B	B
160	DLT SEF (11" x 17")	-	-	-	A2	G2	G2
164	Legal SEF (8 ¹ / ₂ " x 14")	-	-	-	A3	G3	G3
165	Foolscap SEF (8 ¹ / ₂ " x 13")	-	-	-	B	B	B
166	LT SEF (8 ¹ / ₂ " x 11")	-	-	-	A	A	A
038	LT LEF (11" x 8 ¹ / ₂ ")	H	K	K	A1	G1	G1
167	Gov. LG SEF (8 ¹ / ₄ " x 14")	-	-	-	B	B	B
168	Folio SEF (8 ¹ / ₄ " x 13")	-	-	-	B	B	B
169	F/GL SEF (8" x 13")	-	-	-	B	B	B
171	Eng Quatro SEF (8" x 10")	-	-	-	B	B	B
173	Executive SEF (7 ¹ / ₄ " x 10 ¹ / ₂ ")	-	-	-	B	B	B

1. Specifications

Size code	Size (W x L) [mm]	Tray1			Tray2		
		NA	EU	AA	NA	EU	AA
045	Executive LEF (10 ¹ / ₂ " x 7 ¹ / ₄ ")	-	-	-	A4	G4	G4
172	HLT SEF (5 ¹ / ₂ " x 8 ¹ / ₂ ")	-	-	-	B	B	B
208	Com10 SEF (104.8 x 241.3)	-	-	-	B	B	B
080	Com10 LEF (241.3 x 104.8)	-	-	-	B	B	B
209	Monarch SEF (98.4 x 190.5)	-	-	-	B	B	B
081	Monarch LEF (190.5 x 98.4)	-	-	-	-	-	-
211	C5 SEF (162 x 229)	-	-	-	B	B	B
083	C5 LEF (229 x 162)	-	-	-	B	B	B
212	C6 SEF (114 x 162)	-	-	-	B	B	B
084	C6LEF (162 x 114)	-	-	-	B	B	B
213	DL Env SEF (110 x 220)	-	-	-	B	B	B
085	DL Env LEF (220 x 110)	-	-	-	B	B	B
194	8K SEF (267 x 390)	-	-	-	B	B	B
195	16K SEF (195 x 267)	-	-	-	B	B	B
067	16K LEF (267 x 195)	-	-	-	B	B	B
175	12" x 18" SEF	-	-	-	A5	G5	G5
177	11" x 15" SEF	-	-	-	B	B	B
163	10" x 14" SEF	-	-	-	B	B	B
154	SRA3 SEF (420 x 320)	-	-	-	G5	A5	A5
155	SRA4 SEF	-	-	-	-	-	-
027	SRA4 LEF	-	-	-	-	-	-
200	8.5" x 13.4" SEF	-	-	-	A3	B	B

Remarks:

A	Auto detectable. Also can be selected with size button of initial setting.
B	Can be selected with size button from initial setting.
C	Select this size by setting the dial.
D	Set dial to "*", then select with size button from initial setting.
E	<Bypass setting> Copy window/Bypass/Standard size/Size select or select with the print bypass paper size/size button from initial setting.
F	Select with SP from preset paper sizes. Cannot be selected from printer driver.
G	Switches which size to set as auto detect with SP. *Example: The combination of A1-G1. G (When not auto detectable) will be as same as B. Combinations are only made from same region same tray.

	<p>*Example: The combination of G1 and J1. G (When not auto detectable) will be as same as E. Combinations are only made from same region same tray.</p>
H	Size fixed when shipping.
I	<p><Bypass setting> With bypass tray, after 1st sheet trailing edge goes through, auto detects size, then fixed to size detected from the 2nd sheet.</p>
J	<p><Bypass setting> Auto detect of Copy window/Bypass/Standard size/Select with size button.</p>
K	<p>Select with SP from preset paper sizes. Can be selected from printer driver.</p>
-	Not available

Bypass Tray

Size code	Size (W x L) [mm]	Bypass Tray		Feed by bypass support dialog	
		NA	EU/AA	NA	EU/AA
132	A3 SEF (297 x 420)	E	J	J	J
133	A4 SEF (210 x 297)	E	J	J	J
005	A4 LEF (297 x 210)	E	J	J	J
134	A5 SEF (148 x 210)	E	J	J	J
006	A5 LEF (210 x 148)	J	J	J	J
135	A6 SEF (105 x 148)	E	J	J	J
141	B4 SEF (257 x 364)	E	J	J	J
142	B5 SEF (182 x 257)	J	J	J	J
014	B5 LEF (257 x 182)	E	J	J	J
143	B6 SEF (128 x 182)	E	J	J	J
160	DLT SEF (11" x 17")	J	E	J	J
164	Legal SEF (8 ¹ / ₂ " x 14")	G1	E	G1	E
165	Foolscap SEF (8 ¹ / ₂ " x 13")	E	E	E	E
166	LT SEF (8 ¹ / ₂ " x 11")	J1	E	J1	E
038	LT LEF (11" x 8 ¹ / ₂ ")	J	E	E	J
167	Gov. LG SEF (8 ¹ / ₄ " x 14")	E	E	E	E
168	Folio SEF (8 ¹ / ₄ " x 13")	E	E	E	E
169	F/GL SEF (8" x 13")	E	E	J1	E
171	Eng Quatro SEF (8" x 10")	E	E	J	E
173	Executive SEF (7 ¹ / ₄ " x 10 ¹ / ₂ ")	E	E	E	E
045	Executive LEF (10 ¹ / ₂ " x 7 ¹ / ₄ ")	E	E	E	E

1.Specifications

Size code	Size (W x L) [mm]	Bypass Tray		Feed by bypass support dialog	
		NA	EU/AA	NA	EU/AA
172	HLT SEF (5 ¹ / ₂ " x 8 ¹ / ₂ ")	J	E	E	E
208	Com10 SEF (104.8 x 241.3)	E*1	E*1	J	E
080	Com10 LEF (241.3 x 104.8)	E*1	E*1	J	E
209	Monarch SEF (98.4 x 190.5)	E*1	E*1	E	E
081	Monarch LEF (190.5 x 98.4)	E*1	E*1	J	E
211	C5 SEF (162 x 229)	E*1	E*1	E*1	E*1
083	C5 LEF (229 x 162)	E*1	E*1	J*1	J*1
212	C6 SEF (114 x 162)	E*1	E*1	J*1	J*1
084	C6LEF (162 x 114)	E*1	E*1	E*1	E*1
213	DL Env SEF (110 x 220)	E*1	E*1	E*1	E*1
085	DL Env LEF (220 x 110)	E*1	E*1	J*1	J*1
194	8K SEF (267 x 390)	E	E	E	E
195	16K SEF (195 x 267)	E	E	J	J
067	16K LEF (267 x 195)	E	E	E	E
175	12" x 18" SEF	E	E	J	E
177	11" x 15" SEF	E	E	E	E
163	10" x 14" SEF	E	E	J	J
154	SRA3 SEF (420 x 320)	J	J	J	J
155	SRA4 SEF	E	E	J	J
027	SRA4 LEF	E	E	J	J
200	8.5" x 13.4" SEF	E	E	E	E

Remarks:

A	Auto detectable. Also can be selected with size button of initial setting.
B	Can be selected with size button from initial setting.
C	Select this size by setting the dial.
D	Set dial to "*", then select with size button from initial setting.
E	<Bypass setting> Copy window/Bypass/Standard size/Size select or select with the print bypass paper size/size button from initial setting.
F	Select with SP from preset paper sizes. Cannot be selected from printer driver.
G	Switches which size to set as auto detect with SP. *Example: The combination of A1-G1. G (When not auto detectable) will be as same as B. Combinations are only made from same region same tray.

	<p>*Example: The combination of G1 and J1. G (When not auto detectable) will be as same as E. Combinations are only made from same region same tray.</p>
H	Size fixed when shipping.
I	<p><Bypass setting> With bypass tray, after 1st sheet trailing edge goes through, auto detects size, then fixed to size detected from the 2nd sheet.</p>
J	<p><Bypass setting> Auto detect of Copy window/Bypass/Standard size/Select with size button.</p>
K	<p>Select with SP from preset paper sizes. Can be selected from printer driver.</p>
-	Not available

*1	Even the paper size is in the range or available sizes for duplex, envelopes can not be done so.
----	--

Optional Paper Feed Unit (Tray 3, 4)

Size code	Size (W x L) [mm]	Optional Paper Feed Unit		
		NA	EU	AA
132	A3 SEF (297 x 420)	G2	A2	A2
133	A4 SEF (210 x 297)	A	A	A
005	A4 LEF (297 x 210)	G1	A1	A1
134	A5 SEF (148 x 210)	B	B	B
006	A5 LEF (210 x 148)	A	A	A
135	A6 SEF (105 x 148)	B	B	B
141	B4 SEF (257 x 364)	G3	A3	A3
142	B5 SEF (182 x 257)	A	A	A
014	B5 LEF (257 x 182)	G4	G4	G4
143	B6 SEF (128 x 182)	B	B	B
160	DLT SEF (11" x 17")	A2	G2	G2
164	Legal SEF (8 ¹ / ₂ " x 14")	A3	G3	G3
165	Foolscap SEF (8 ¹ / ₂ " x 13")	B	B	B
166	LT SEF (8 ¹ / ₂ " x 11")	A	A	A
038	LT LEF (11" x 8 ¹ / ₂ ")	A1	G1	G1
167	Gov. LG SEF (8 ¹ / ₄ " x 14")	B	B	B
168	Folio SEF (8 ¹ / ₄ " x 13")	B	B	B
169	F/GL SEF (8" x 13")	B	B	B
171	Eng Quatro SEF (8" x 10")	B	B	B
173	Executive SEF (7 ¹ / ₄ " x 10 ¹ / ₂ ")	B	B	B

1. Specifications

Size code	Size (W x L) [mm]	Optional Paper Feed Unit		
		NA	EU	AA
045	Executive LEF (10 ¹ / ₂ " x 7 ¹ / ₄ ")	A4	G4	G4
172	HLT SEF (5 ¹ / ₂ " x 8 ¹ / ₂ ")	B	B	B
208	Com10 SEF (104.8 x 241.3)	B	B	B
080	Com10 LEF (241.3 x 104.8)	B	B	B
209	Monarch SEF (98.4 x 190.5)	B	B	B
081	Monarch LEF (190.5 x 98.4)	-	-	-
211	C5 SEF (162 x 229)	B	B	B
083	C5 LEF (229 x 162)	B	B	B
212	C6 SEF (114 x 162)	B	B	B
084	C6LEF (162 x 114)	B	B	B
213	DL Env SEF (110 x 220)	B	B	B
085	DL Env LEF (220 x 110)	B	B	B
194	8K SEF (267 x 390)	B	B	B
195	16K SEF (195 x 267)	B	B	B
067	16K LEF (267 x 195)	B	B	B
175	12" x 18" SEF	A5	G5	G5
177	11" x 15" SEF	B	B	B
163	10" x 14" SEF	B	B	B
154	SRA3 SEF (420 x 320)	G5	A5	A5
155	SRA4 SEF	-	-	-
027	SRA4 LEF	-	-	-
200	8.5" x 13.4" SEF	A3	B	B

Remarks:

A	Auto detectable. Also can be selected with size button of initial setting.
B	Can be selected with size button from initial setting.
C	Select this size by setting the dial.
D	Set dial to "*", then select with size button from initial setting.
E	<Bypass setting> Copy window/Bypass/Standard size/Size select or select with the print bypass paper size/size button from initial setting.
F	Select with SP from preset paper sizes. Cannot be selected from printer driver.
G	Switches which size to set as auto detect with SP. *Example: The combination of A1-G1. G (When not auto detectable) will be as same as B. Combinations are only made from same region same tray.

	<p>*Example: The combination of G1 and J1. G (When not auto detectable) will be as same as E. Combinations are only made from same region same tray.</p>
H	Size fixed when shipping.
I	<p><Bypass setting> With bypass tray, after 1st sheet trailing edge goes through, auto detects size, then fixed to size detected from the 2nd sheet.</p>
J	<p><Bypass setting> Auto detect of Copy window/Bypass/Standard size/Select with size button.</p>
K	<p>Select with SP from preset paper sizes. Can be selected from printer driver.</p>
-	Not available

Side LCT

Size code	Size (W x L) [mm]	Side LCT		
		NA	EU	AA
132	A3 SEF (297 x 420)	-	-	-
133	A4 SEF (210 x 297)	-	-	-
005	A4 LEF (297 x 210)	K	H	H
134	A5 SEF (148 x 210)	-	-	-
006	A5 LEF (210 x 148)	-	-	-
135	A6 SEF (105 x 148)	-	-	-
141	B4 SEF (257 x 364)	-	-	-
142	B5 SEF (182 x 257)	-	-	-
014	B5 LEF (257 x 182)	K	K	K
143	B6 SEF (128 x 182)	-	-	-
160	DLT SEF (11" x 17")	-	-	-
164	Legal SEF (8 ¹ / ₂ " x 14")	-	-	-
165	Foolscap SEF (8 ¹ / ₂ " x 13")	-	-	-
166	LT SEF (8 ¹ / ₂ " x 11")	-	-	-
038	LT LEF (11" x 8 ¹ / ₂ ")	H	K	K
167	Gov. LG SEF (8 ¹ / ₄ " x 14")	-	-	-
168	Folio SEF (8 ¹ / ₄ " x 13")	-	-	-
169	F/GL SEF (8" x 13")	-	-	-
171	Eng Quatro SEF (8" x 10")	-	-	-
173	Executive SEF (7 ¹ / ₄ " x 10 ¹ / ₂ ")	-	-	-
045	Executive LEF (10 ¹ / ₂ " x 7 ¹ / ₄ ")	-	-	-
172	HLT SEF (5 ¹ / ₂ " x 8 ¹ / ₂ ")	-	-	-

1.Specifications

Size code	Size (W x L) [mm]	Side LCT		
		NA	EU	AA
208	Com10 SEF (104.8 x 241.3)	-	-	-
080	Com10 LEF (241.3 x 104.8)	-	-	-
209	Monarch SEF (98.4 x 190.5)	-	-	-
081	Monarch LEF (190.5 x 98.4)	-	-	-
211	C5 SEF (162 x 229)	-	-	-
083	C5 LEF (229 x 162)	-	-	-
212	C6 SEF (114 x 162)	-	-	-
084	C6LEF (162 x 114)	-	-	-
213	DL Env SEF (110 x 220)	-	-	-
085	DL Env LEF (220 x 110)	-	-	-
194	8K SEF (267 x 390)	-	-	-
195	16K SEF (195 x 267)	-	-	-
067	16K LEF (267 x 195)	-	-	-
175	12" x 18" SEF	-	-	-
177	11" x 15" SEF	-	-	-
154	SRA3 SEF (420 x 320)	-	-	-
155	SRA4 SEF	-	-	-
027	SRA4 LEF	-	-	-
163	10" x 14" SEF	-	-	-
200	8.5" x 13.4" SEF	-	-	-

Remarks:

A	Auto detectable. Also can be selected with size button of initial setting.
B	Can be selected with size button from initial setting.
C	Select this size by setting the dial.
D	Set dial to "*", then select with size button from initial setting.
E	<Bypass setting> Copy window/Bypass/Standard size/Size select or select with the print bypass paper size/size button from initial setting.
F	Select with SP from preset paper sizes. Cannot be selected from printer driver.
G	Switches which size to set as auto detect with SP. *Example: The combination of A1-G1. G (When not auto detectable) will be as same as B. Combinations are only made from same region same tray. *Example: The combination of G1 and J1. G (When not auto detectable) will be as same as E.

	Combinations are only made from same region same tray.
H	Size fixed when shipping.
I	<Bypass setting> With bypass tray, after 1 st sheet trailing edge goes through, auto detects size, then fixed to size detected from the 2 nd sheet.
J	<Bypass setting> Auto detect of Copy window/Bypass/Standard size/Select with size button.
K	Select with SP from preset paper sizes. Can be selected from printer driver.
-	Not available

Tandem LCT

Size code	Size (W x L) [mm]	Tandem LCT		
		NA	EU	AA
132	A3 SEF (297 x 420)	-	-	-
133	A4 SEF (210 x 297)	-	-	-
005	A4 LEF (297 x 210)	K	H	H
134	A5 SEF (148 x 210)	-	-	-
006	A5 LEF (210 x 148)	-	-	-
135	A6 SEF (105 x 148)	-	-	-
141	B4 SEF (257 x 364)	-	-	-
142	B5 SEF (182 x 257)	-	-	-
014	B5 LEF (257 x 182)	-	-	-
143	B6 SEF (128 x 182)	-	-	-
160	DLT SEF (11" x 17")	-	-	-
164	Legal SEF (8 ¹ / ₂ " x 14")	-	-	-
165	Foolscap SEF (8 ¹ / ₂ " x 13")	-	-	-
166	LT SEF (8 ¹ / ₂ " x 11")	-	-	-
038	LT LEF (11" x 8 ¹ / ₂ ")	H	K	K
167	Gov. LG SEF (8 ¹ / ₄ " x 14")	-	-	-
168	Folio SEF (8 ¹ / ₄ " x 13")	-	-	-
169	F/GL SEF (8" x 13")	-	-	-
171	Eng Quatro SEF (8" x 10")	-	-	-
173	Executive SEF (7 ¹ / ₄ " x 10 ¹ / ₂ ")	-	-	-
045	Executive LEF (10 ¹ / ₂ " x 7 ¹ / ₄ ")	-	-	-
172	HLT SEF (5 ¹ / ₂ " x 8 ¹ / ₂ ")	-	-	-
208	Com10 SEF (104.8 x 241.3)	-	-	-
080	Com10 LEF (241.3 x 104.8)	-	-	-

1.Specifications

Size code	Size (W x L) [mm]	Tandem LCT		
		NA	EU	AA
209	Monarch SEF (98.4 x 190.5)	-	-	-
081	Monarch LEF (190.5 x 98.4)	-	-	-
211	C5 SEF (162 x 229)	-	-	-
083	C5 LEF (229 x 162)	-	-	-
212	C6 SEF (114 x 162)	-	-	-
084	C6LEF (162 x 114)	-	-	-
213	DL Env SEF (110 x 220)	-	-	-
085	DL Env LEF (220 x 110)	-	-	-
194	8K SEF (267 x 390)	-	-	-
195	16K SEF (195 x 267)	-	-	-
067	16K LEF (267 x 195)	-	-	-
175	12" x 18" SEF	-	-	-
177	11" x 15" SEF	-	-	-
163	10" x 14" SEF	-	-	-
154	SRA3 SEF (420 x 320)	-	-	-
155	SRA4 SEF	-	-	-
027	SRA4 LEF	-	-	-
200	8.5" x 13.4" SEF	-	-	-

Remarks:

A	Auto detectable. Also can be selected with size button of initial setting.
B	Can be selected with size button from initial setting.
C	Select this size by setting the dial.
D	Set dial to "*", then select with size button from initial setting.
E	<Bypass setting> Copy window/Bypass/Standard size/Size select or select with the print bypass paper size/size button from initial setting.
F	Select with SP from preset paper sizes. Cannot be selected from printer driver.
G	Switches which size to set as auto detect with SP. *Example: The combination of A1-G1. G (When not auto detectable) will be as same as B. Combinations are only made from same region same tray. *Example: The combination of G1 and J1. G (When not auto detectable) will be as same as E. Combinations are only made from same region same tray.
H	Size fixed when shipping.

I	<Bypass setting> With bypass tray, after 1 st sheet trailing edge goes through, auto detects size, then fixed to size detected from the 2 nd sheet.
J	<Bypass setting> Auto detect of Copy window/Bypass/Standard size/Select with size button.
K	Select with SP from preset paper sizes. Can be selected from printer driver.
-	Not available

Paper Exit

Main Machine Tray, 1 Bin Tray, Inner Shift Tray, Side Tray

Size code	Size (W x L) [mm]	Main unit tray	1 Bin Tray BN3130	Internal Shift Tray SH3080		Side Tray Type M37	
		Output tray	1 bin tray	Shift	Shifting	Bridge upper tray	Side tray
132	A3 SEF (297 x 420)	A	A	A	A	A	A
133	A4 SEF (210 x 297)	A	A	A	A	A	A
005	A4 LEF (297 x 210)	A	A	A	A	A	A
134	A5 SEF (148 x 210)	A	A	A	A	A	A
006	A5 LEF (210 x 148)	A	A	A	A	A	A
135	A6 SEF (105 x 148)	A	A*1	A*1	B	A*1	A*1
141	B4 SEF (257 x 364)	A	A	A	A	A	A
142	B5 SEF (182 x 257)	A	A	A	A	A	A
014	B5 LEF (257 x 182)	A	A	A	A	A	A
143	B6 SEF (128 x 182)	A	A*1	A*1	B	A*1	A*1
160	DLT SEF (11" x 17")	A	A	A	A	A	A
164	Legal SEF (8 ¹ / ₂ " x 14")	A	A	A	A	A	A
165	Foolscap SEF (8 ¹ / ₂ " x 13")	A	A	A	A	A	A
166	LT SEF (8 ¹ / ₂ " x 11")	A	A	A	A	A	A
038	LT LEF (11" x 8 ¹ / ₂ ")	A	A	A	A	A	A

1.Specifications

Size code	Size (W x L) [mm]	Main unit tray	1 Bin Tray BN3130	Internal Shift Tray SH3080		Side Tray Type M37	
		Output tray	1 bin tray	Shift	Shifting	Bridge upper tray	Side tray
167	Gov. LG SEF (8 ¹ / ₄ " x 14")	A	A	A	A	A	A
168	Folio SEF (8 ¹ / ₄ " x 13")	A	A	A	A	A	A
169	F/GL SEF (8" x 13")	A	A	A	A	A	A
171	Eng Quatro SEF (8" x 10")	A	A	A	A	A	A
173	Executive SEF (7 ¹ / ₄ " x 10 ¹ / ₂ ")	A	A	A	A	A	A
045	Executive LEF (10 ¹ / ₂ " x 7 ¹ / ₄ ")	A	A	A	A	A	A
172	HLT SEF (5 ¹ / ₂ " x 8 ¹ / ₂ ")	A	A	A	A	A	A
208	Com10 SEF (104.8 x 241.3)	A	B	A*1	B	A*1	B
080	Com10 LEF (241.3 x 104.8)	A	B	A*1	B	A*1	-
209	Monarch SEF (98.4 x 190.5)	A	B	A*1	B	A*1	B
081	Monarch LEF (190.5 x 98.4)	A	B	A*1	B	A*1	-
211	C5 SEF (162 x 229)	A	B	A*1	B	A*1	B
083	C5 LEF (229 x 162)	A	B	A*1	B	A*1	B
212	C6 SEF (114 x 162)	A	B	A*1	B	A*1	B
084	C6LEF (162 x 114)	A	B	A*1	B	A*1	-
213	DL Env SEF (110 x 220)	A	B	A*1	B	A*1	B
085	DL Env LEF (220 x 110)	A	B	A*1	B	A*1	-
194	8K SEF (267 x 390)	A	A	A	A	A	A
195	16K SEF (195 x 267)	A	A	A	A	A	A

1.Specifications

Size code	Size (W x L) [mm]	Main unit tray	1 Bin Tray BN3130	Internal Shift Tray SH3080		Side Tray Type M37	
		Output tray	1 bin tray	Shift	Shifting	Bridge upper tray	Side tray
067	16K LEF (267 x 195)	A	A	A	A	A	A
175	12" x 18" SEF	A	A*1	A*1	B	A	A
177	11" x 15" SEF	A	A	A	A	A	A
163	10" x 14" SEF	A	A	A	A	A	A
154	SRA3 SEF (420 x 320)	A	A	A*1	B	A	A
155	SRA4 SEF	A	A	A	A	A	A
027	SRA4 LEF	A	A	A	B	A	A
200	8.5" x 13.4" SEF	A	A	A	A	A	A

Shift: The paper is fed out to the shift tray, but without shifting.

Shifting: The paper is fed out to the shift tray, and the shifting function is used.

Remarks:

A	Paper through, paper exit available.
B	Will not guarantee, but paper can go through or exit.
-	Not available.

*1	Out of the true up precision guarantee.
----	---

Internal Finisher SR3250

Size code	Size (W x L) [mm]	Paper exit		Staple		Punch		
		Shift	Shifting	Single/Double size	Stapling amount	EU 2 SC 4 Holes	NA 3 EU 4 Holes	NA 2 Holes
132	A3 SEF (297 x 420)	A	A	A	30	A	A	A
133	A4 SEF (210 x 297)	A	A	A	50	A	-	B
005	A4 LEF (297 x 210)	A	A	A	50	A	A	A
134	A5 SEF (148 x 210)	A*1	A*1	-	-	-	-	-
006	A5 LEF (210 x 148)	A*1	A*1	-	-	-	-	-

1.Specifications

Size code	Size (W x L) [mm]	Paper exit		Staple		Punch		
		Shift	Shifting	Single/Double size	Stapling amount	EU 2 SC 4 Holes	NA 3 EU 4 Holes	NA 2 Holes
	148)							
135	A6 SEF (105 x 148)	A*1	-	-	-	-	-	-
141	B4 SEF (257 x 364)	A	A	A	30	A	-	-
142	B5 SEF (182 x 257)	A	A	A	50	A	-	-
014	B5 LEF (257 x 182)	A	A	A	50	A	-	-
143	B6 SEF (128 x 182)	A*1	-	-	-	-	-	-
160	DLT SEF (11" x 17")	A	A	A	30	A	A	A
164	Legal SEF (8½" x 14")	A	A	A	30	A	-	A
165	Foolscap SEF (8½" x 13")	A	A	A	30	A	-	A
166	LT SEF (8½" x 11")	A	A	A	50	A	-	A
038	LT LEF (11" x 8½")	A	A	A	50	A	A	A
167	Gov. LG SEF (8¼" x 14")	A	A	A	30	-	-	-
168	Folio SEF (8¼" x 13")	A	A	A	30	-	-	-
169	F/GL SEF (8" x 13")	A	A*1	-	-	-	-	-
171	Eng Quatro SEF (8" x 10")	A	A*1	-	-	-	-	-
173	Executive SEF (7¼" x 10½")	A	A	A	50	A	-	A
045	Executive LEF (10½" x 7¼")	A	A	A	50	-	-	-
172	HLT SEF (5½" x	A*1	-	-	-	-	-	-

1.Specifications

Size code	Size (W x L) [mm]	Paper exit		Staple		Punch		
		Shift	Shifting	Single/Double size	Stapling amount	EU 2 SC 4 Holes	NA 3 EU 4 Holes	NA 2 Holes
	8 1/2")							
208	Com10 SEF (104.8 x 241.3)	A*1	-	-	-	-	-	-
080	Com10 LEF (241.3 x 104.8)	A*1,3,4	-	-	-	-	-	-
209	Monarch SEF (98.4 x 190.5)	A*1	-	-	-	-	-	-
081	Monarch LEF (190.5 x 98.4)	A*1,3,4	-	-	-	-	-	-
211	C5 SEF (162 x 229)	A*1	-	-	-	-	-	-
083	C5 LEF (229 x 162)	A*1	-	-	-	-	-	-
212	C6 SEF (114 x 162)	A*1	-	-	-	-	-	-
084	C6 LEF (162 x 114)	A*1,3,4	-	-	-	-	-	-
213	DL Env SEF (110 x 220)	A*1	-	-	-	-	-	-
085	DL Env LEF (220 x 110)	A*1,3,4	-	-	-	-	-	-
194	8K SEF (267 x 390)	A	A	A	30	A	-	-
195	16K SEF (195 x 267)	A	A	A	50	A	-	-
067	16K LEF (267 x 195)	A	A	A	50	A	-	-
175	12" x 18" SEF	A*1	-	-	-	-	-	-
177	11" x 15" SEF	A*1	A	-	-	-	-	-
163	10" x 14" SEF	A*1	A	-	-	-	-	-
154	SRA3 SEF (420 x 320)	A	-	-	-	-	-	-
155	SRA4 SEF	A	A	-	-	-	-	-
027	SRA4 LEF	A	-	-	-	-	-	-

1.Specifications

Size code	Size (W x L) [mm]	Paper exit		Staple		Punch		
		Shift	Shifting	Single/Double size	Stapling amount	EU 2 SC 4 Holes	NA 3 EU 4 Holes	NA 2 Holes
200	8.5" x 13.4" SEF	A	A	A	30	A	-	A

Shift: The paper is fed out to the shift tray, but without shifting.

Shifting: The paper is fed out to the shift tray, and the shifting function is used.

Remarks:

A	Paper through, paper exit available.
B	Will not guarantee, but paper can go through or exit.
-	Not available.

Booklet Finisher SR3290/Finisher SR3280

	Size (W x L) [mm]	Paper exit				Half fold	Staple				Punch		
		Proof/shift	shifting	Half fold	Middle fold		Single/Double stitch	Stapling amount	Saddle stitch	Saddle stitch amount	EU2 SC4 Holes	NA2 Holes	NA3 EU4 Holes
132	A3 SEF (297 x 420)	A	A	A	A*2	A	50	A	20	A	A	A	
133	A4 SEF (210 x 297)	A	A	A	A*2	A	50	A	20	A	B	-	
005	A4 LEF (297 x 210)	A	A	-	-	A	50	-	-	A	A	A	
134	A5 SEF (148 x 210)	A	A	-	-	-	-	-	-	A	A	-	
006	A5 LEF (210 x 148)	A	A	-	-	-	-	-	-	A	B	-	
135	A6 SEF (105 x 148)	A	A	-	-	-	-	-	-	-	-	-	
14	B4 SEF	A	A	A	A*2	A	50	A	20	A	A	A	

1.Specifications

	Size (W x L) [mm]	Paper exit			Half fold	Staple				Punch		
		Proof/s hift	shifting	Half fold	Middle fold	Single /Double stitch	Stapling amount	Saddle stitch	Saddle stitch amount	EU2 SC4 Holes	NA2 Holes	NA3 EU4 Holes
1	(257 x 364)											
142	B5 SEF (182 x 257)	A	A	A	A*2	A	50	A	20	A	A	-
014	B5 LEF (257 x 182)	A	A	-	-	A	50	-	-	A	A	A
143	B6 SEF (128 x 182)	A	A	-	-	-	-	-	-	-	-	-
160	DLT SEF (11" x 17")	A	A	A	A*2	A	50	A	20	A	A	A
164	Legal SEF (8½" x 14")	A	A	A	A*2	A	50	A	20	A	A	-
165	Foolscape SEF (8½" x 13")	A	A	-	-	A	50	-	-	A	A	-
166	LT SEF (8½" x 11")	A	A	A	A*2	A	50	A	20	A	A	
038	LT LEF (11" x 8½")	A	A	-	-	A	50	-	-	A	A	A
167	Gov. LG SEF (8¼" x	A	A	A	A*2	A	50	A	20	A	A	-

1.Specifications

	Size (W x L) [mm]	Paper exit			Half fold	Staple				Punch		
		Proof/shifft	shifting	Half fold	Middle fold	Single/Double stitch	Stapling amount	Saddle stitch	Saddle stitch amount	EU2 SC4 Holes	NA2 Holes	NA3 EU4 Holes
	14")											
168	Folio SEF (8 1/4" x 13")	A	A	A	A*2	A	50	A	20	A	A	-
169	F/GL SEF (8" x 13")	A	A	-	-	A	50	-	-	A	A	-
171	Eng Quatro SEF (8" x 10")	A	A	-	-	A	50	-	-	A	A	-
173	Executive SEF (7 1/4" x 10 1/2")	A	A	-	-	A	50	-	-	A	A	-
045	Executive LEF (10 1/2" x 7 1/4")	A	A	-	-	A	50	-	-	A	A	A
172	HLT SEF (5 1/2" x 8 1/2")	A	A	-	-	-	-	-	-	A	A	-
208	Com10 SEF (104.8 x 241.3)	-	-	-	-	-	-	-	-	-	-	-
080	Com10 LEF (241.3)	-	-	-	-	-	-	-	-	-	-	-

1.Specifications

	Size (W x L) [mm]	Paper exit			Half fold	Staple				Punch		
		Proof/s hift	shifting	Half fold	Middle fold	Single /Double stitch	Stapling amount	Saddle stitch	Saddle stitch amount	EU2 SC4 Holes	NA2 Holes	NA3 EU4 Holes
	x 104.8)											
209	Monarc h SEF (98.4 x 190.5)	-	-	-	-	-	-	-	-	-	-	-
081	Monarc h LEF (190.5 x 98.4)	-	-	-	-	-	-	-	-	-	-	-
211	C5 SEF (162 x 229)	-	-	-	-	-	-	-	-	-	-	-
083	C5 LEF (229 x 162)	-	-	-	-	-	-	-	-	-	-	-
212	C6 SEF (114 x 162)	-	-	-	-	-	-	-	-	-	-	-
084	C6LEF (162 x 114)	-	-	-	-	-	-	-	-	-	-	-
213	DL Env SEF (110 x 220)	-	-	-	-	-	-	-	-	-	-	-
085	DL Env LEF (220 x 110)	-	-	-	-	-	-	-	-	-	-	-
194	8K SEF (267 x	A	A	-	-	A	50	-	-	A	A	A

1.Specifications

	Size (W x L) [mm]	Paper exit			Half fold	Staple				Punch		
		Proof/s hift	shifting	Half fold	Middle fold	Single /Double stitch	Stapling amount	Saddle stitch	Saddle stitch amount	EU2 SC4 Holes	NA2 Holes	NA3 EU4 Holes
	390)											
195	16K SEF (195 x 267)	A	A	-	-	A	50	-	-	A	A	-
067	16K LEF (267 x 195)	A	A	-	-	A	50	-	-	A	A	A
175	12" x 18" SEF	A	A	A	A*2	-	-	A	20	-	-	-
177	11" x 15" SEF	A	A	A	A*2	A	50	A	20	A	A	A
163	10" x 14" SEF	A	A	A	A*2	A	50	A	20	A	A	A
154	SRA3 SEF (420 x 320)	A	A	-	-	-	-	-	-	-	-	-
155	SRA4 SEF	A	A	A	A*2	A	-	A	20	-	-	-
027	SRA4 LEF	A	A	-	-	-	-	-	-	-	-	-
200	8.5" x 13.4" SEF	A	A	A	A*2	A	50	A	20	A	A	-

Remarks:

A	Paper through, paper exit available.
---	--------------------------------------

1.Specifications

B	Will not guarantee, but paper can go through or exit.
-	Not available.

*2	Multi folding can be done up to 5 sheets.
----	---

Booklet Finisher SR3270

Size code	Size (W x L) [mm]	Paper exit					Half fold	Staple				Punch		
		Pro of tray	Shift tray	Shifting	Saddle stitching	Middle fold		Single/Double stitch	Staple amount	Saddle stitching	Saddle stitching amount	EU 2 SC 4 Holes	NA 2 Holes	NA 3 EU 4 Holes
132	A3 SEF (297 x 420)	A	A	A	A	A*5	A	30	A	15	A	A	A	
133	A4 SEF (210 x 297)	A	A	A	A	A*5	A	50	A	15	A	B	-	
005	A4 LEF (297 x 210)	A	A	A	-	-	A	50	-	-	A	A	A	
134	A5 SEF (148 x 210)	A	A	A*1	-	-	-	-	-	-	A	A	-	
006	A5 LEF (210 x 148)	A	A	A	-	-	-	-	-	-	A	B	-	
135	A6 SEF (105 x 148)	A	A	-	-	-	-	-	-	-	-	-	-	
14	B4	A	A	A	A	A*5	A	30	A	15	A	A	A	

1.Specifications

Size code	Size (W x L) [mm]	Paper exit				Half fold	Staple				Punch		
		Pro of tray	Shift tray	Shifting	Saddle stitch		Middle fold	Single/Double stitch	Staple amount	Saddle stitch	Saddle stitch amount	EU 2 SC 4 Holes	NA 2 Holes
1	SEF (257 x 364)												
142	B5 SEF (182 x 257)	A	A	A*1	A	A*5	A	50	A	15	A	A	-
014	B5 LEF (257 x 182)	A	A	A	-	-	A	50	-	-	A	A	A
143	B6 SEF (128 x 182)	A	A	-	-	-	-	-	-	-	-	-	-
160	DLT SEF (11" x 17")	A	A	A	A	A*5	A	30	A	15	A	A	A
164	Legal SEF (8½" x 14")	A	A	A	A	A*5	A	30	A	15	A	A	-
165	Foolscap SEF (8½" x 13")	A	A	A	-	-	A	30	-	-	A	A	-
166	LT SEF (8½" x	A	A	A	A	A*5	A	50	A	15	A	A	-

1.Specifications

Size code	Size (W x L) [mm]	Paper exit				Half fold	Staple				Punch		
		Pro of tray	Shift tray	Shifting	Saddle stitch		Mid dle fold	Single/Doble stitch	Staple amount	Saddle stitc h	Saddle stitch amount	EU 2 SC 4 Holes	NA 2 Holes
	11")												
038	LT LEF (11" x 8½")	A	A	A	-	-	A	50	-	-	A	A	A
167	Gov. LG SEF (8¼" x 14")	A	A	A	-	-	A	30	-	-	A	A	-
168	Folio SEF (8¼" x 13")	A	A	A	-	-	A	30	-	-	A	A	-
169	F/GL SEF (8" x 13")	A	A	A	-	-	A	30	-	-	A	A	-
171	Eng Quatro LEF (10" x 8")	A	A	A	-	-	A	50	-	-	-	-	-
173	Executive SEF (7¼" x 10½")	A	A	A	-	-	A	50	-	-	A	A	-
045	Executive LEF	A	A	A	-	-	A	50	-	-	A	A	A

1.Specifications

Size code	Size (W x L) [mm]	Paper exit				Half fold	Staple				Punch		
		Pro of tray	Shift tray	Shifting	Saddle stitch		Mid dle fold	Single/Double stitch	Staple amount	Saddle stitc h	Saddle stitch amount	EU 2 SC 4 Holes	NA 2 Holes
	(10 ¹ / ₂ " x 7 ¹ / ₄ "												
172	HLT SEF (5 ¹ / ₂ " x 8 ¹ / ₂ "	A	A	A*1	-	-	-	-	-	-	A	A	-
080	Com10 SEF (104.8 x 241.3)	-	-	-	-	-	-	-	-	-	-	-	-
081	Com10 LEF (241.3 x 104.8)	-	-	-	-	-	-	-	-	-	-	-	-
211	Monarch SEF (98.4 x 190.5)	-	-	-	-	-	-	-	-	-	-	-	-
081	Monarch LEF (190.5 x 98.4)	-	-	-	-	-	-	-	-	-	-	-	-
211	C5 SEF (162 x 229)	-	-	-	-	-	-	-	-	-	-	-	-
08	C5	-	-	-	-	-	-	-	-	-	-	-	-

1.Specifications

Size code	Size (W x L) [mm]	Paper exit				Half fold	Staple				Punch		
		Pro of tray	Shift tray	Shifting	Saddle stitch		Mid dle fold	Single/Do uble stitch	Staple amount	Saddle stitc h amount	Saddle stitch amount	EU 2 SC 4 Holes	NA 2 Holes
3	LEF (229 x 162)												
212	C6 SEF (114 x 162)	-	-	-	-	-	-	-	-	-	-	-	-
084	C6LE F (162 x 114)	-	-	-	-	-	-	-	-	-	-	-	-
213	DL Env SEF (110 x 220)	-	-	-	-	-	-	-	-	-	-	-	-
085	DL Env LEF (220 x 110)	-	-	-	-	-	-	-	-	-	-	-	-
194	8K SEF (267 x 390)	A	A	A	-	-	A	30	-	-	A	A	A
195	16K SEF (195 x 267)	A	A	A	-	-	A	50	-	-	A	A	-
067	16K LEF (267 x	A	A	A	-	-	A	50	-	-	A	A	A

1. Specifications

Size code	Size (W x L) [mm]	Paper exit				Half fold	Staple				Punch		
		Pro of tray	Shift tray	Shifting	Saddle stitch		Mid dle fold	Single/Do ouble stitch	Staple amount	Saddle stitc h	Saddle stitch amount	EU 2 SC 4 Holes	NA 2 Holes
	195)												
175	12" x 18" SEF	A	A	A	A	A ⁵	A	30	A	15	-	-	-
177	11" x 15" SEF	A	A	A	-	-	A	50	-	-	A	A	A
163	10" x 14" SEF	A	A	A	-	-	A	50	-	-	A	A	A
154	SRA3 SEF (420 x 320)	A	A	-	-	-	-	-	-	-	-	-	-
155	SRA4 SEF	A	A	A	-	-	A	30	-	-	-	-	-
027	SRA4 LEF	A	A	-	-	-	-	-	-	-	-	-	-
200	8.5" x 13.4" SEF	A	A	A	A	A ⁵	A	30	-	-	A	A	-

Remarks:

A	Paper through, paper exit available.
B	Will not guarantee, but paper can go through or exit.
-	Not available.

*1	Out of the true up precision guarantee.
*2	Multi folding can be done up to 5 sheets.
*3	Envelopes can only go through each at a time.
*4	Except envelopes with triangle flap.

*5	Only one sheet can be half folded with saddle stitch mode. Therefore, multi sheets/sets must be paginated and exit one at a time.
----	--

Bridge Unit

Size code	Size (W x L) [mm]	Bridge Unit	
		Bridge upper tray	Relay path to finisher
132	A3 SEF (297 x 420)	A	A
133	A4 SEF (210 x 297)	A	A
005	A4 LEF (297 x 210)	A	A
134	A5 SEF (148 x 210)	A	A
006	A5 LEF (210 x 148)	A	A
135	A6 SEF (105 x 148)	A	A
141	B4 SEF (257 x 364)	A	A
142	B5 SEF (182 x 257)	A	A
014	B5 LEF (257 x 182)	A	A
143	B6 SEF (128 x 182)	A	A
160	DLT SEF (11" x 17")	A	A
164	Legal SEF (8 ¹ / ₂ " x 14")	A	A
165	Foolscap SEF (8 ¹ / ₂ " x 13")	A	A
166	LT SEF (8 ¹ / ₂ " x 11")	A	A
038	LT LEF (11" x 8 ¹ / ₂ ")	A	A
167	Gov. LG SEF (8 ¹ / ₄ " x 14")	A	A
168	Folio SEF (8 ¹ / ₄ " x 13")	A	A
169	F/GL SEF (8" x 13")	A	A
171	Eng Quatro SEF (8" x 10")	A	A
173	Executive SEF (7 ¹ / ₄ " x 10 ¹ / ₂ ")	A	A
045	Executive LEF (10 ¹ / ₂ " x 7 ¹ / ₄ ")	A	A
172	HLT SEF (5 ¹ / ₂ " x 8 ¹ / ₂ ")	A	A
208	Com10 SEF (104.8 x 241.3)	A*1	-
080	Com10 LEF (241.3 x 104.8)	A*1	-
209	Monarch SEF (98.4 x 190.5)	A*1	-
081	Monarch LEF (190.5 x 98.4)	A*1	-
211	C5 SEF (162 x 229)	A*1	-
083	C5 LEF (229 x 162)	A*1	-
212	C6 SEF (114 x 162)	A*1	-
084	C6LEF (162 x 114)	A*1	-
213	DL Env SEF (110 x 220)	A*1	-
085	DL Env LEF (220 x 110)	A*1	-

1. Specifications

Size code	Size (W x L) [mm]	Bridge Unit	
		Bridge upper tray	Relay path to finisher
194	8K SEF (267 x 390)	A	A
195	16K SEF (195 x 267)	A	A
067	16K LEF (267 x 195)	A	A
175	12" x 18" SEF	A	A
177	11" x 15" SEF	A	A
163	10" x 14" SEF	A	A
154	SRA3 SEF (420 x 320)	A	A
155	SRA4 SEF	A	A
027	SRA4 LEF	A	A
200	8.5" x 13.4" SEF	A	A

Size (W x L) [mm]	Paper exit	Bridge
	Bridge upper paper exit	Finisher Bridge
A3 SEF (297 x 420)	A	A
A4 SEF (210 x 297)	A	A
A4 LEF (297 x 210)	A	A
A5 SEF (148 x 210)	A	A
A5 LEF (210 x 148)	A	A
A6 SEF (105 x 148)	A	A
B4 SEF (257 x 364)	A	A
B5 SEF (182 x 257)	A	A
B5 LEF (257 x 182)	A	A
B6 SEF (128 x 182)	A	A
DLT SEF (11" x 17")	A	A
Legal SEF (8 ¹ / ₂ " x 14")	A	A
Foolscap SEF (8 ¹ / ₂ " x 13")	A	A
LT SEF (8 ¹ / ₂ " x 11")	A	A
LT LEF (11" x 8 ¹ / ₂ ")	A	A
Gov. LG SEF (8 ¹ / ₄ " x 14")	A	A
Folio SEF (8 ¹ / ₄ " x 13")	A	A
F/GL SEF (8" x 13")	A	A
GLT SEF (8" x 10 ¹ / ₂ ")	-	-
GLT LEF (10 ¹ / ₂ " x 8")	-	-
Eng Quatro SEF (8" x 10")	A	A
Eng Quatro LEF (10" x 8")	-	-
Executive SEF (7 ¹ / ₄ " x 10 ¹ / ₂ ")	A	A

1.Specifications

Size (W x L) [mm]	Paper exit	Bridge
	Bridge upper paper exit	Finisher Bridge
Executive LEF (10 ¹ / ₂ " x 7 ¹ / ₄ ")	A	A
HLT SEF (5 ¹ / ₂ " x 8 ¹ / ₂ ")	A	A
HLT LEF (8 ¹ / ₂ " x 5 ¹ / ₂ ")	-	-
SRA3 SEF (420 x 320)	A	A
SRA4 SEF	A	A
SRA4 LEF	A	A
Line slider 1 SEF	-	-
Line slider 1 LEF	-	-
Line slider 2 SEF	-	-
Line slider 2 LEF	-	-
Com10 SEF (104.8 x 241.3)	A ^{*1}	-
Com10 LEF (241.3 x 104.8)	A ^{*1}	-
Monarch SEF (98.4 x 190.5)	A ^{*1}	-
Monarch LEF (190.5 x 98.4)	A ^{*1}	-
C5 SEF (162 x 229)	A ^{*1}	-
C5 LEF (229 x 162)	A ^{*1}	-
C6 SEF (114 x 162)	A ^{*1}	-
C6LEF (162 x 114)	A ^{*1}	-
DL Env SEF (110 x 220)	A ^{*1}	-
DL Env LEF (220 x 110)	A ^{*1}	-
8K SEF (267 x 390)	A	A
16K SEF (195 x 267)	A	A
16K LEF (267 x 195)	A	A
13" x 19.2" SEF	-	-
13" x 19" SEF	-	-
13" x 18" SEF	-	-
12.6" x 19.2 SEF	-	-
12.6" x 18.5" SEF	-	-
12" x 18" SEF	-	-
12" x 18" LEF	A	A
11" x 15" SEF	A	A
11" x 14" SEF	-	-
10" x 15" SEF	-	-
10" x 14" SEF	A	A
8.5" x 13.4" SEF	A	A

Remarks:

1.Specifications

A	Paper through, paper exit available.
B	Will not guarantee, but paper can go through or exit.
-	Not available.

*1	Out of the true up precision guarantee.
*2	Multi folding can be done up to 5 sheets.
*3	Envelopes can only go through each at a time.
*4	Except envelopes with triangle flap.
*5	Only one sheet can be half folded with saddle stitch mode. Therefore, multi sheets/sets must be paginated and exit one at a time.

Finisher SR3260

Size code	Size (W x L) [mm]	Paper exit			Staple		Stapleless staple		Punch		
		Proof tray	Shift tray	Shifting	Single/Double stitch	Amount	Single stitch	Amount	EU2 SC4 Holes	NA2 Holes	NA3 EU4 Holes
132	A3 SEF (297 x 420)	A	A	A	A	30	A	5	A	A	A
133	A4 SEF (210 x 297)	A	A	A	A	50	A	5	A	B	-
005	A4 LEF (297 x 210)	A	A	A	A	50	A	5	A	A	A
134	A5 SEF (148 x 210)	A	A	A*1	-	-	-	-	A	A	-
006	A5 LEF (210 x 148)	A	A	A	-	-	-	-	A	B	-
135	A6 SEF (105 x 148)	A	A	-	-	-	-	-	-	-	-
141	B4 SEF (257 x	A	A	A	A	30	A	5	A	A	A

1.Specifications

Size code	Size (W x L) [mm]	Paper exit			Staple		Stapleless staple		Punch		
		Proof tray	Shift tray	Shifting	Single/Double stitch	Amount	Single stitch	Amount	EU2 SC4 Holes	NA2 Holes	NA3 EU4 Holes
	364)										
142	B5 SEF (182 x 257)	A	A	A*1	A	50	A	5	A	A	-
014	B5 LEF (257 x 182)	A	A	A	A	50	A	5	A	A	A
143	B6 SEF (128 x 182)	A	A	-	-	-	-	-	-	-	-
160	DLT SEF (11" x 17")	A	A	A	A	30	A	5	A	A	A
164	Legal SEF (8 ¹ / ₂ " x 14")	A	A	A	A	30	A	5	A	A	-
165	Foolscape SEF (8 ¹ / ₂ " x 13")	A	A	A	A	30	A	5	A	A	-
166	LT SEF (8 ¹ / ₂ " x 11")	A	A	A	A	50	A	5	A	A	-
038	LT LEF (11" x 8 ¹ / ₂ ")	A	A	A	A	50	A	5	A	A	A
167	Gov. LG SEF (8 ¹ / ₄ " x 14")	A	A	A	A	30	A	5	A	A	-

1.Specifications

Size code	Size (W x L) [mm]	Paper exit			Staple		Stapleless staple		Punch		
		Proof tray	Shift tray	Shifting	Single/Double stitch	Amount	Single stitch	Amount	EU2 SC4 Holes	NA2 Holes	NA3 EU4 Holes
168	Folio SEF (8 ¹ / ₄ " x 13")	A	A	A	A	30	A	5	A	A	-
169	F/GL SEF (8" x 13")	A	A	A	A	30	-	-	A	A	-
171	Eng Quatro LEF (10" x 8")	A	A	A	A	50	-	-	-	-	-
173	Executive SEF (7 ¹ / ₄ " x 10 ¹ / ₂ ")	A	A	A	A	50	A	5	A	A	-
045	Executive LEF (10 ¹ / ₂ " x 7 ¹ / ₄ ")	A	A	A	A	50	A	5	A	A	A
172	HLT SEF (5 ¹ / ₂ " x 8 ¹ / ₂ ")	A	A	A*1	-	-	-	-	A	A	-
080	Com10 SEF (104.8 x 241.3)	-	-	-	-	-	-	-	-	-	-
081	Com10 LEF (241.3 x 104.8)	-	-	-	-	-	-	-	-	-	-

1.Specifications

Size code	Size (W x L) [mm]	Paper exit			Staple		Stapleless staple		Punch		
		Proof tray	Shift tray	Shifting	Single/Double stitch	Amount	Single stitch	Amount	EU2 SC4 Holes	NA2 Holes	NA3 EU4 Holes
211	Monarch SEF (98.4 x 190.5)	-	-	-	-	-	-	-	-	-	-
081	Monarch LEF (190.5 x 98.4)	-	-	-	-	-	-	-	-	-	-
211	C5 SEF (162 x 229)	-	-	-	-	-	-	-	-	-	-
083	C5 LEF (229 x 162)	-	-	-	-	-	-	-	-	-	-
212	C6 SEF (114 x 162)	-	-	-	-	-	-	-	-	-	-
084	C6LEF (162 x 114)	-	-	-	-	-	-	-	-	-	-
213	DL Env SEF (110 x 220)	-	-	-	-	-	-	-	-	-	-
085	DL Env LEF (220 x 110)	-	-	-	-	-	-	-	-	-	-
194	8K SEF (267 x 390)	A	A	A	A	30	A	5	A	A	A
195	16K	A	A	A	A	50	A	5	A	A	-

1.Specifications

Size code	Size (W x L) [mm]	Paper exit			Staple		Stapleless staple		Punch		
		Proof tray	Shift tray	Shifting	Single/Double stitch	Amount	Single stitch	Amount	EU2 SC4 Holes	NA2 Holes	NA3 EU4 Holes
	SEF (195 x 267)										
067	16K LEF (267 x 195)	A	A	A	A	50	A	5	A	A	A
175	12" x 18" SEF	A	A	A	A	30	-	-	-	-	-
177	11" x 15" SEF	A	A	A	A	50	-	-	A	A	A
163	10" x 14" SEF	A	A	A	A	50	-	-	A	A	A
154	SRA3 SEF (420 x 320)	A	A	-	-	-	-	-	-	-	-
155	SRA4 SEF	A	A	A	A	30	-	-	-	-	-
027	SRA4 LEF	A	A	-	-	-	-	-	-	-	-
200	8.5" x 13.4" SEF	A	A	A	A	30	A	5	A	A	-

Remarks:

A	Paper through, paper exit available.
B	Will not guarantee, but paper can go through or exit.
-	Not available.

*1	Out of the true up precision guarantee.
----	---

Internal Finisher SR3300

Size code	Size (W x L) [mm]	Paper exit		Staple	
		Shift tray	Shifting	Single stitch	Amount
132	A3 SEF (297 x 420)	A	A	A	5
133	A4 SEF (210 x 297)	A	A	A	5
005	A4 LEF (297 x 210)	A	A	A	5
134	A5 SEF (148 x 210)	B	B	-	-
006	A5 LEF (210 x 148)	B	B	-	-
135	A6 SEF (105 x 148)	B	-	-	-
141	B4 SEF (257 x 364)	A	A	A	5
142	B5 SEF (182 x 257)	A	A	A	5
014	B5 LEF (257 x 182)	A	A	A	5
143	B6 SEF (128 x 182)	B	B)	-	-
160	DLT SEF (11" x 17")	A	A	A	5
164	Legal SEF (8 ¹ / ₂ " x 14")	A	A	A	5
165	Foolscap SEF (8 ¹ / ₂ " x 13")	A	A	A	5
166	LT SEF (8 ¹ / ₂ " x 11")	A	A	A	5
038	LT LEF (11" x 8 ¹ / ₂ ")	A	A	A	5
167	Gov. LG SEF (8 ¹ / ₄ " x 14")	A	A	A	5
168	Folio SEF (8 ¹ / ₄ " x 13")	A	A	A	5
169	F/GL SEF (8" x 13")	B	B	-	-
171	Eng Quatro LEF (10" x 8")	B	B	-	-
173	Executive SEF (7 ¹ / ₄ " x 10 ¹ / ₂ ")	A	A	A	5
045	Executive LEF (10 ¹ / ₂ " x 7 ¹ / ₄ ")	A	A	A	5
172	HLT SEF (5 ¹ / ₂ " x 8 ¹ / ₂ ")	B	B	-	-
208	Com10 SEF (104.8 x 241.3)	B	-	-	-
080	Com10 LEF (241.3 x 104.8)	B*1, 11, 12	-	-	-
209	Monarch SEF (98.4 x 190.5)	B	-	-	-
081	Monarch LEF (190.5 x 98.4)	B*1, 11, 12	-	-	-
211	C5 SEF (162 x 229)	B	-	-	-
083	C5 LEF (229 x 162)	B	-	-	-
212	C6 SEF (114 x 162)	B	-	-	-
084	C6LEF (162 x 114)	B*1, 11, 12	-	-	-
213	DL Env SEF (110 x 220)	B	-	-	-
085	DL Env LEF (220 x 110)	B*1, 11, 12	-	-	-
194	8K SEF (267 x 390)	A	A	A	5
195	16K SEF (195 x 267)	A	A	A	5

1. Specifications

Size code	Size (W x L) [mm]	Paper exit	Staple		
		Shift tray	Shifting	Single stitch	Amount
067	16K LEF (267 x 195)	A	A	A	5
175	12" x 18" SEF	B	-	-	-
177	11" x 15" SEF	B	B	-	-
163	10" x 14" SEF	B	B	-	-
154	SRA3 SEF (420 x 320)	B	-	-	-
155	SRA4 SEF	B	B	-	-
027	SRA4 LEF	B	-	-	-
200	8.5" x 13.4" SEF	A	A	A	5

Remarks:

A	Paper through, paper exit available.
B	Will not guarantee, but paper can go through or exit.
-	Not available.

*1 Out of the true up precision guarantee.

*11 The envelopes can only be printed one by one.

*12 Excluding envelopes with triangular flaps

Internal Multi-Fold Unit FD3010

For the unit without a finisher

Size (W x L) [mm]	Paper exit	Fold-supporting paper size (for folding one sheet)		
		Z-fold	Half fold	Letter fold in/Letter fold out
A3 SEF (297 x 420)	A	A	A	A
A4 SEF (210 x 297)	A	A	A	A
A4 LEF (297 x 210)	A	-	-	-
A5 SEF (148 x 210)	A	-	-	-
A5 LEF (210 x 148)	A	-	-	-
A6 SEF (105 x 148)	A	-	-	-
B4 SEF (257 x 364)	A	A	A	-
B5 SEF (182 x 257)	A	-	-	-
B5 LEF (257 x 182)	A	-	-	-
B6 SEF (128 x 182)	A	-	-	-
DLT SEF (11" x 17")	A	A	A	A
Legal SEF (8½" x 14")	A	A	A	A
Foolscap SEF (8½" x 13")	A	-	-	-
LT SEF (8½" x 11")	A	A	A	A
LT LEF (11" x 8½")	A	-	-	-

1.Specifications

Size (W x L) [mm]	Paper exit	Fold-supporting paper size (for folding one sheet)		
		Z-fold	Half fold	Letter fold in/Letter fold out
Gov. LG SEF (8 ¹ / ₄ " x 14")	A	-	-	-
Folio SEF (8 ¹ / ₄ " x 13")	A	-	-	-
F/GL SEF (8" x 13")	A	-	-	-
Eng Quatro SEF (8" x 10")	A	-	-	-
Executive SEF (7 ¹ / ₄ " x 10 ¹ / ₂ ")	A	-	-	-
Executive LEF (10 ¹ / ₂ " x 7 ¹ / ₄ ")	A	-	-	-
HLT SEF (5 ¹ / ₂ " x 8 ¹ / ₂ ")	A	-	-	-
Com10 SEF (104.8 x 241.3)	B ^{*1,3,4}	-	-	-
Com10 LEF (241.3 x 104.8)	B ^{*1,3,4}	-	-	-
Monarch SEF (98.4 x 190.5)	B ^{*1,3,4}	-	-	-
Monarch LEF (190.5 x 98.4)	B ^{*1,3,4}	-	-	-
C5 SEF (162 x 229)	B ^{*1,3,4}	-	-	-
C5 LEF (229 x 162)	B ^{*1,3,4}	-	-	-
C6 SEF (114 x 162)	B ^{*1,3,4}	-	-	-
C6LEF (162 x 114)	B ^{*1,3,4}	-	-	-
DL Env SEF (110 x 220)	B ^{*1,3,4}	-	-	-
DL Env LEF (220 x 110)	B ^{*1,3,4}	-	-	-
8K SEF (267 x 390)	A	A	A	-
16K SEF (195 x 267)	A	-	-	-
16K LEF (267 x 195)	A	-	-	-
12" x 18" SEF	-	-	-	-
11" x 15" SEF	A	-	-	-
10" x 14" SEF	A	-	-	-
8.5" x 13.4" SEF	A	A	A	A

For the unit with a finisher

Size (W x L) [mm]	Paper exit		Fold-supporting paper size (for folding one sheet)		
	Fold tray	Finisher	Z-fold	Half fold	Letter fold in/Letter fold out
A3 SEF (297 x 420)	A ^{*6}	A	A	A	A
A4 SEF (210 x 297)	A ^{*6}	A	A	A	A
A4 LEF (297 x 210)	A ^{*7}	A	-	-	-
A5 SEF (148 x 210)	-	A	-	-	-
A5 LEF (210 x 148)	A ^{*7}	A	-	-	-
A6 SEF (105 x 148)	-	A	-	-	-
B4 SEF (257 x 364)	A ^{*6}	A	A	A	-

1.Specifications

Size (W x L) [mm]	Paper exit		Fold-supporting paper size (for folding one sheet)		
	Fold tray	Finisher	Z-fold	Half fold	Letter fold in/Letter fold out
B5 SEF (182 x 257)	-	A	-	-	-
B5 LEF (257 x 182)	A ^{*7}	A	-	-	-
B6 SEF (128 x 182)	-	A	-	-	-
DLT SEF (11" x 17")	A ^{*6}	A	A	A	A
Legal SEF (8½" x 14")	A ^{*6}	A	A	A	A
Foolscap SEF (8½" x 13")	-	A	-	-	-
LT SEF (8½" x 11")	A ^{*6}	A	A	A	A
LT LEF (11" x 8½")	A ^{*7}	A	-	-	-
Gov. LG SEF (8¼" x 14")	-	A	-	-	-
Folio SEF (8¼" x 13")	-	A	-	-	-
F/GL SEF (8" x 13")	-	A	-	-	-
Eng Quatro SEF (8" x 10")	-	A	-	-	-
Executive SEF (7¼" x 10½")	-	A	-	-	-
Executive LEF (10½" x 7¼")	-	A	-	-	-
HLT SEF (5½" x 8½")	-	A	-	-	-
Com10 SEF (104.8 x 241.3)	B ^{*1,3,4}	-	-	-	-
Com10 LEF (241.3 x 104.8)	B ^{*1,3,4}	-	-	-	-
Monarch SEF (98.4 x 190.5)	B ^{*1,3,4}	-	-	-	-
Monarch LEF (190.5 x 98.4)	B ^{*1,3,4}	-	-	-	-
C5 SEF (162 x 229)	B ^{*1,3,4}	-	-	-	-
C5 LEF (229 x 162)	B ^{*1,3,4}	-	-	-	-
C6 SEF (114 x 162)	B ^{*1,3,4}	-	-	-	-
C6LEF (162 x 114)	B ^{*1,3,4}	-	-	-	-
DL Env SEF (110 x 220)	B ^{*1,3,4}	-	-	-	-
DL Env LEF (220 x 110)	B ^{*1,3,4}	-	-	-	-
8K SEF (267 x 390)	A ^{*6}	A	A	A	-
16K SEF (195 x 267)	-	A	-	-	-
16K LEF (267 x 195)	A ^{*7}	A	-	-	-
12" x 18" SEF	A ^{*8}	A	-	A	-
11" x 15" SEF	-	A	-	-	-
10" x 14" SEF	-	A	-	-	-
8.5" x 13.4" SEF	A ^{*6}	A	A	A	A

Remarks:

A	Paper through, paper exit available.
B	Will not guarantee, but paper can go through or exit.
-	Not available.

*1	Out of the true up precision guarantee.
*2	Multi folding can be done up to 5 sheets.
*3	Envelopes can only go through each at a time.
*4	Except envelopes with triangle flap.
*5	Only one sheet can be half folded with saddle stitch mode. Therefore, multi sheets/sets must be paginated and exit one at a time.
*6	Paper exit is available when using a folding option. If not using a folding option, paper exit is not available.
*7	Plain paper can be delivered to the tray only when Z-fold or half fold is partially specified in the job.
*8	Paper exit is not available even when using a folding option.

2. Preventive Maintenance

PM PartsTable for Main Machine

The yield figures in the above table are based on the following conditions:

- A4 (LT) long-edge feed
- 5% image coverage ratio
- Color ratio: 30% (IM C6000/C5500/C4500/C3500/C3000), 20% (IM C2500/C2000)
- 3 prints/job (IM C3500/C3000), 4 prints/job (IM C6000/C5500/C4500), 2 prints/job (IM C2500/C2000)
- Environment: Normal temperature and humidity

Yield may change depending on circumstances and print conditions.

Symbol keys:

C: Clean, R: Replace, L: Lubricant, I: Inspect

Item	EM parts	Cycle	Remarks
PCDU			
PCU(K) C6000/C5500/C4500 C3500/C3000		R 400K	
PCU(K) C2500/C2000		R 60K	
PCU(C,M,Y) C6000/C5500/C4500		R 270K	
PCU(C,M,Y) C3500/C3000		R 175K	
PCU(C,M,Y) C2500/C2000	■	R 48K*	*P/J
Waste Toner Bottle		R 100K	Full detection is a mechanical detection by the feeler. Replace when waste toner bottle full is detected.
Development Unit (K) C6000/C5500/C4500 C3500/C3000		R 600K	
Development Unit (K) C2500/C2000		R 180K	

2.Preventive Maintenance

Item	EM parts	Cycle	Remarks
Development Unit (C,M,Y) C6000/C5500/C4500		R 270K	
Development Unit (C,M,Y) C3500/C3000		R 160K	
Development Unit (C,M,Y) C2500/C2000		R 120K	
PCDU (K) C6000/C5500/C4500 C3500/C3000		R 400K*	*P/J
PCDU (K) C2500/C2000		R 60K*	*P/J
PCDU (C, M, Y) C6000/C5500/C4500	■	R 270K*	*P/J
PCDU (C, M, Y) C3500/C3000	■	R 160K*	*P/J
PCDU (C, M, Y) C2500/C2000	■	R 48K*	*P/J
Transfer			
Image Transfer Cleaning Unit C6000/C5500/C4500 C3500/C3000		R 600K*	*P/J
Image Transfer Cleaning Unit C2500/C2000	■	R 240K*	*P/J
Image Transfer Belt Unit C6000/C5500/C4500 C3500/C3000		R 600K	
Image Transfer Belt Unit C2500/C2000		R 240K	
Paper Transfer Roller C6000/C5500/C4500 C3500/C3000		R 900K	

2.Preventive Maintenance

Item	EM parts	Cycle	Remarks
Paper Transfer Roller C2500/C2000		R 240K	
Fusing			
Heating Sleeve Belt Unit C6000/C5500/C4500 C3500/C3000		R 400K	
Heating Sleeve Belt Unit C2500/C2000		R 240K	
Pressure Roller C6000/C5500/C4500 C3500/C3000		R 400K	
Pressure Roller C2500/C2000		R 240K	
Bearing: Fusing Roller C6000/C5500/C4500 C3500/C3000		R 400K	Lubricating grease
Bearing: Fusing Roller C2500/C2000		R 240K	
Thermopile		C 400K	Dry cloth
Fusing unit C6000/C5500/C4500 C3500/C3000		R 400K*	*P/J
Fusing unit C2500/C2000		R 240K*	*P/J
Miscellaneous			
Ozone filter/Dust filter		R 400K	
Waste Toner Bottle		R 100K*	*Image Coverage ratio

Yield Parts

- Some of the parts mentioned in these tables have a target yield. However, the total copy/print volume made by the machine will not reach the target yield within the machine's targeted lifetime if the machine is used under the target usage conditions (ACV, color ratio, P/J, and C/O). So, these parts are categorized not as PM parts but as yield parts (EM parts).



- PCU and Development unit is replaced together as PCDU. Individual parts are registered for EM replacement.
- ITB cleaning unit is integrated into ITB Unit. Individual part is registered for EM replacement.
- Fusing section is replaced as Fusing Unit. Individual parts are registered for EM replacement.
- When the fusing unit is used past its target yield (400k/240k), the fusing belt may break, causing a service call. Therefore, it is designed that the machine starts displaying a stop warning on the operation panel at 415k/244k pages and stops at 430k/248k pages. Please make sure to replace the fusing belt unit before the unit's PM counter reaches 430k/248k pages.
- A customer replaces the Waste Toner Bottle. By changing SP5-073-001, service replace mode for Waste Toner Bottle is enabled. Never try to empty toner out of the waste toner bottle to use the same bottle again; always replace the bottle with a new one. This is because the transfer coil inside the bottle may break.

2.Preventive Maintenance

PM PartsTable for Peripherals

The yield figures in the above table are based on the following conditions:

- A4 (LT) long-edge feed
- 5% image coverage ratio
- Color ratio: 30% (IM C6000/C5500/C4500/C3500/C3000), 20% (IM C2500/C2000)
- 3 prints/job (IM C3500/C3000), 4 prints/job (IM C6000/C5500/C4500), 2 prints/job (IM C2500/C2000)
- Environment: Normal temperature and humidity

Yield may change depending on circumstances and print conditions.

Symbol keys:

C: Clean, R: Replace, L: Lubricant, I: Inspect

Booklet Finisher SR3270 / Finisher SR3260

Item	Cycle	EM parts	Note
Stapler	R 5000K	■	Replace when the staple counter in the logging data reached 5000k.

Punch Unit PU3080

Item	Cycle	EM parts	Note
Punch Unit	R 1000k	■	Replace when the punch unit in the logging data reached 1000k.

Booklet Finisher SR3290 / Finisher SR3280

Rollers (Drive/Driven)	C 500K	■	Wipe with a cloth dampened with ethyl alcohol.
Discharge Brush	C 500K	■	Wipe with a cloth dampened with ethyl alcohol.
Bearings	C 500K	■	Lubricate with silicone oils when noise occurred.
Sensors	C 500K	■	Clean with a blower brush.
Corner Stapler	R 3000K	■	Replace when the corner stapling counter in the logging data reached 3000k.
Booklet Stapler	R 1000K	■	Replace when the booklet stapling counter on logging data reached 1000K.
Item	Cycle	EM parts	Notes

Punch Unit PU3090

Item	Cycle	EM parts	Note
Punch Unit	R 3000k	■	

ARDF DF3110/SPDF3120

Item	Cycle	EM parts	Note
Pick-up Roller	C 120K	■	Wipe with a cloth dampened with ethyl alcohol.
Feed Belt	C 120K	■	Wipe with a cloth dampened with ethyl alcohol.
Separation Roller	C 120K	■	Wipe with a cloth dampened with ethyl alcohol.

Internal Finisher SR3250

Stapler	R 200K	■	Replace when staple counter on logging data reached 200K.
Item	Cycle	EM parts	Notes

Internal Finisher SR3300

Stapler	R 100K	■	Replace when staple counter on logging data reached 100 thousand times.
Item	Cycle	EM parts	Notes

Yield Parts

- Some of the parts mentioned in these tables have a target yield. However, the total copy/print volume made by the machine will not reach the target yield within the machine's targeted lifetime if the machine is used under the target usage conditions (ACV, color ratio, P/J, and C/O). So, these parts are categorized not as PM parts but as yield parts (EM parts).

Periodic Inspection/Cleaning for Main Machine

C: Clean, L: Lubricant, I: Inspect

Item	Action	Remarks
Scanner		
Exposure Glass	C	Clean with a dry or damp cloth. Do not clean with alcohol. Doing so may leave a whitish trace that affects image scanning.
Sheet-through exposure glass	C	Clean with a dry or damp cloth. Do not clean with alcohol. Doing so may leave a whitish trace that affects image scanning.
Fusing		
Fusing Entrance Guide Plate	C	Remove toner deposits
Fusing Exit Guide Plate	C	Remove toner deposits
Separation Plate	C	Remove toner deposits
Gears	I	Replace if worn out
Idler gear	I	Replace if worn out
Fusing exit roller	C	Damp cloth
Miscellaneous		
Deodorization Filter	C	Clean with a cleaning cloth.
TM/ID sensor	C	Damp cloth * Do not use a dry cloth that can cause static electricity.
Paper Feed (Mainframe)		
Registration Roller	C	Damp cloth
Registration Sensor	C	Remove toner and paper dust, Dry cloth
Paper dust collection unit	C	Remove toner and paper dust, Dry cloth
Transport roller	C	Damp cloth
Transport Sensor	C	Remove toner and paper dust, Dry cloth
Paper feed sensor	C	Remove toner and paper dust, Dry cloth
Feed roller	C	Remove toner and paper dust, Dry cloth
Separation Roller	C	Remove toner and paper dust, Dry cloth
Pick-up roller	C	Remove toner and paper dust, Dry cloth
Paper Feed (Paper Trays)		
Transport roller	C	Damp cloth

2.Preventive Maintenance

Item	Action	Remarks
Transport Sensor	C	Remove toner and paper dust, Dry cloth
Paper feed sensor	C	Remove toner and paper dust, Dry cloth
Feed roller	C	Remove toner and paper dust, Dry cloth
Separation Roller	C	Remove toner and paper dust, Dry cloth
Pick-up roller	C	Remove toner and paper dust, Dry cloth
Duplex		
Duplex transport roller 1, 2	C	Damp cloth
Duplex entrance sensor	C	Remove toner and paper dust, Dry cloth
Duplex exit sensor	C	Remove toner and paper dust, Dry cloth
Duplex exit roller 1, 2	C	Damp cloth
Duplex entrance roller	C	Damp cloth
By-pass paper feed roller	C	Damp cloth
By-pass Separation Roller	C	Damp cloth
By-pass pick-up roller	C	Damp cloth
By-pass transport roller	C	Damp cloth
Paper Exit		
Reverse Roller	C	Damp cloth
Reverse Sensor	C	Remove toner and paper dust, Dry cloth
Paper exit roller	C	Damp cloth
Paper exit sensor	C	Remove toner and paper dust, Dry cloth

Periodic Inspection/Cleaning for Peripherals

C: Clean, L: Lubricant, I: Inspect

ARDF DF3110/SPDF DF3120

Item	Action	Note
Pick-up Roller	C	Wipe with a cloth dampened with ethyl alcohol.
Feed Belt	C	Wipe with a cloth dampened with ethyl alcohol.
Separation Roller	C	Wipe with a cloth dampened with ethyl alcohol.
Sensors	C	Clean with a blower brush.
Gears	L	Lubricate, if necessary.
Platen Sheet	C	Wipe with a cloth dampened with ethyl alcohol.
Other Rollers	C	
Scanner Guide Plate	C	

Paper Feed Unit PB3270/PB3280/PB3300, LCIT PB3290

Item	Action	Note
Paper Feed Roller	C	Wipe with a cloth dampened with ethyl alcohol.
Pick-up Roller	C	
Separation Roller	C	
Relay Rollers	C	
Bottom Plate Pad	C	Remove dust with dry cloth.
Sensors	C	

LCIT RT3040

Item	Action	Note
Paper Feed Roller	C	Wipe with a cloth dampened with ethyl alcohol.
Pick-up Roller	C	
Separation Roller	C	
Relay Rollers	C	
Bottom Plate Pad	C	Remove dust with dry cloth.
Sensors	C	

1 Bin Tray BN3130

Item	Action	Note
Rollers	C	Wipe with a cloth dampened with ethyl alcohol.
Copy Tray	C	Clean with a damp cloth, and then wipe with a dry cloth.
Sensors	C	Clean with a blower brush.
Bearings	C	Lubricate with silicone oils when noise occurred.

Bridge Unit BU3090

Item	Action	Note
Rollers	C	Wipe with a cloth dampened with ethyl alcohol.

Internal Shift Tray SH3080

Item	Action	Note
Exit Tray	C	Clean with a damp cloth, and then wipe with a dry cloth.

Side Tray Type M37

Item	Action	Note
Rollers	C	Wipe with a cloth dampened with ethyl alcohol.
Sensors	C	Remove dusts with dry cloth.

Booklet Finisher SR3270 / Finisher SR3260

Item	Action	Note
Drive rollers	C	Wipe with a cloth dampened with ethyl alcohol.
Driven rollers	C	
Quenching brush	C	
Bearings	C	Lubricate with Silicone Grease G-501 when noise occurs.
Sensors	C	Clean with a blower brush.
Jogger fences	C	Lubricate with Silicone Grease G-501 when abnormal noise is generated or unexpected operation occurs.

Booklet Finisher SR3290 / Finisher SR3280

Item	Action	Note
Drive rollers	C	Wipe with a cloth dampened with ethyl alcohol.
Driven rollers	C	
Quenching brush	C	
Bearings	C	Lubricate with Silicone Grease G-501 when noise occurs.
Sensors	C	Clean with a blower brush.
Punch dust	I	Discard paper dust when the hopper is detected to be full.

Punch Unit PU3090

	Action	Note
Punch Waste Hopper	I	Discard paper dust when the hopper is detected to be full.

Internal Finisher SR3250

Item	Action	Notes
Rollers (Drive/Driven)	C	Wipe with a cloth dampened with ethyl alcohol.

2.Preventive Maintenance

Item	Action	Notes
Sensors	C	Clean with a blower brush.
Bearings	C	Lubricate with silicone oils when noise occurred.

Internal Finisher SR3300

Item	Action	Notes
Rollers (Drive/Driven)	C	Wipe with a cloth dampened with ethyl alcohol.
Sensors	C	Clean with a blower brush.
Discharge Brush	C	Wipe with a cloth dampened with ethyl alcohol.
Bearings	C	Lubricate with silicone oils when noise occurred.

Internal Multi-Fold Unit FD3010

Item	Action	Note
Bearings	C	Lubricate with Silicone Grease G-501 when noise occurs.
Driven rollers	C	Wipe with a damp cloth, then a dry cloth.
Fold rollers	C	
Paper exit rollers	C	
Paper sensor	C	Remove paper dust with a blower brush or the corner of a triangular-folded cloth.
Paper transport rollers	C	Wipe with a damp cloth, then a dry cloth.
Trays	C	

Small Paper Feeding Unit Type M37

Item	Action	Notes
Tray/friction pad	C	Remove dust with dry cloth.

3.SP Mode Tables

Service Program Mode



- Make sure that the data-in LED (■) is not on before you go into the SP mode. This LED indicates that some data is coming to the machine. When the LED is on, wait for the copier to process the data.



- The Service Program Mode is for use by service representatives only. If this mode is used by anyone other than service representatives for any reason, data might be deleted or settings might be changed. In such case, product quality cannot be guaranteed any more.

Entering SP Mode

If there are no Classic Application (copy/printer/scanner/fax) icons on the HOME screen, follow the procedure below to display the number keyboard.

- 1.** Press and hold the button [A] located at the left side of the operation panel and "Check Status [B]" at the same time, until the number keyboard is displayed.



3.SP Mode Tables

2. Enter the key code for SP mode.



For details of the key code to enter the SP mode, ask your supervisor.

Exiting SP Mode

Press "Exit" on the LCD twice to return to the copy window.

Types of SP Modes

- System SP: SP modes related to the engine functions
- Printer SP: SP modes related to the controller functions
- Scanner SP: SP modes related to the scanner functions
- Fax SP: SP modes related to the fax functions

Select one of the Service Program modes (System, Printer, Scanner, or Fax) from the touch panel as shown in the diagram below after you access the SP mode. This section explains the functions of the System/Printer/Scanner SP modes. Refer to the Fax service manual for the Fax SP modes.



SP Mode Button Summary

Here is a short summary of the touch-panel buttons.

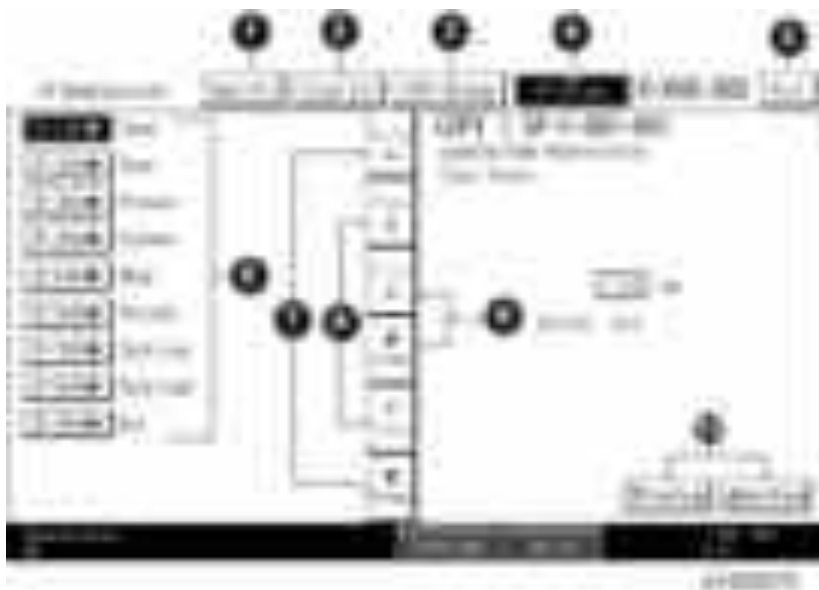

1	Opens all SP groups and sublevels.
2	Closes all open groups and sublevels and restores the initial SP mode display.
3	Opens the copy window (copy mode) so you can make test copies. Press SP Mode (highlighted) in the copy window to return to the SP mode screen,
4	Enter the SP code directly with the number keys if you know the SP number. Then press [#]. The required SP Mode number will be highlighted when pressing [#]. If not, just press the required SP Mode number.)
5	Press two times to leave the SP mode and return to the copy window to resume normal operation.
6	Press any Class 1 number to open a list of Class 2 SP modes.
7	Press to scroll the show to the previous or next group.
8	Press to scroll to the previous or next display in segments the size of the screen display (page).
9	Press to scroll the show the previous or next line (line by line).
10	Press to move the highlight on the left to the previous or next selection in the list.

Switching Between SP Mode and Copy Mode for Test Printing

- 1.** In the SP mode, select the test print. Then press "Copy Window".
- 2.** Use the copy window (copier mode), to select the appropriate settings (paper size, etc.) for the test print.
- 3.** Press [Start] key to start the test print.
- 4.** Press SP Mode (highlighted) to return to the SP mode screen and repeat from step 1.

Selecting the Program Number

Program numbers have two or three levels.

- 1.** Refer to the Service Tables to find the SP that you want to adjust before you begin.
- 2.** Press the Group number on the left side SP Mode window that contains the SP that you want to

3.SP Mode Tables

adjust.

- 3.** Use the scrolling buttons in the center of the SP mode window to show the SP number that you want to open. Then press that number to expand the list.
- 4.** Use the center touch-panel buttons to scroll to the number and title of the item that you want to set and press it. The small entry box on the right activates and shows the below default or the current settings.



- Refer to the Service Tables for the range of allowed settings.

- 5.** Do this procedure to enter a setting:
 - Press  to toggle between plus and minus and use the keypad to enter the appropriate number. The number you enter writes over the previous setting.
 - Press [#] to enter the setting. (The value is not registered if you enter a number that is out of range.)
 - Press "Yes" when you are prompted to complete the selection.
- 6.** If you need to perform a test print, press Copy Window to open the copy window and select the settings for the test print. Press [Start] key and then press SP Mode (highlighted) in the copy window to return to the SP mode display.
- 7.** Press Exit two times to return to the copy window when you are finished.

Service Mode Lock/Unlock

At locations where the machine contains sensitive data, the customer engineer cannot operate the machine until the Administrator turns the service mode lock off. This function makes sure that work on the machine is always done with the permission of the Administrator.

- 1.** If you cannot go into the SP mode, ask the Administrator to log in with the User Tool and then set "Service Mode Lock" to OFF after he or she logs in:

Settings > Machine Features Settings > System Settings > Administrator Tools > Service Mode Lock > OFF

- This unlocks the machine and lets you get access to all the SP codes.

- The CE can service the machine and turn OFF then ON the machine power. It is not necessary to ask the Administrator to log in again each time the main power is turned ON.
- 2.** Go into the SP mode and set SP5-169 to "1" if you must use the printer bit switches.
 - 3.** After machine servicing is completed:
 - Change SP5-169 from "1" to "0".
 - Turn OFF then ON the machine power. Tell the administrator that you have completed servicing the machine.
 - The Administrator will then set the "Service Mode Lock" to ON.

Remarks

The maximum number of characters which can show on the control panel screen is limited to 30 characters. For this reason, some of the SP modes shown on the screen need to be abbreviated. The following are abbreviations used for the SP modes for which the full description is over 20 characters.

Item	Description
Paper Weight	Thin paper: 52-59 g/m ² , 14-15lb. Bond Plain Paper1: 60-74 g/m ² , 16-20lb. Bond Plain Paper2: 75-81 g/m ² , 20lb. Bond Middle Thick: 82-105 g/m ² , 20-28lb. Bond Thick Paper1: 106-169 g/m ² , 28lb. Bond-90lb. Index Thick Paper2: 170-220 g/m ² , 65-80lb. Cover Thick Paper3: 221-256 g/m ² , 80lb. Cover-140lb. Index Thick Paper4: 257-300 g/m ² , 140lb. Index-110lb. Cover
Paper Type	N: Normal paper MTH: Middle thick paper TH: Thick paper
Paper Feed Station	P: Paper tray B: By-pass table
Print Mode	S: Simplex D: Duplex

Others

The settings of each SP mode are explained in the right-hand column of the SP table in the following way.

[Adjustable range / **Default setting** / Step] Alphanumeric



- If "Alphanumeric" is written to the right of the bracket as shown above, the setting of the SP mode shows on the screen using alphanumeric characters instead of only numbers. However, the settings in the bracket in the SP mode table are explained by using only the numbers.

3.SP Mode Tables

The following symbols are used in the SP mode tables.

Notation	What it means
ENG	Engine SP
CTL	Controller SP
FA	Factory setting: Data may be adjusted from the default setting at the factory. Refer to the factory setting sheets enclosed. You can find it in the front cover.
DFU	Design/Factory Use only: Do not touch these SP modes in the field.
*	An asterisk (*) to the left side of ENG/CTL column means that this mode is stored in the NVRAM. If you do a RAM clear, this SP mode will be reset to the default value. "ENG" and "CTL" show which NVRAM contains the data. <ul style="list-style-type: none">• *ENG: NVRAM on the BiCU board• *CTL: NVRAM on the controller board
SSP	This denotes a "Special Service Program" mode setting.

Engine SP Mode Tables for IM C3500 / C3000 / C2500 / C2000

Engine SP Tables-1

SP1-XXX (Feed)

SP No.	Large Category	Small Category	ENG or CTL	[Min to Max/Init./Step]
1-001-001	Leading Edge Registration	Tray1: Thin	ENG*	[-9.0 to 9.0 / 0.0 / 0.1mm/step]
1-001-002	Leading Edge Registration	Tray1: Plain	ENG*	[-9.0 to 9.0 / 0.0 / 0.1mm/step]
1-001-003	Leading Edge Registration	Tray1: Mid-thick	ENG*	[-9.0 to 9.0 / 0.0 / 0.1mm/step]
1-001-004	Leading Edge Registration	Tray1: Thick 1	ENG*	[-9.0 to 9.0 / 0.0 / 0.1mm/step]
1-001-005	Leading Edge Registration	Tray1: Thick 2	ENG*	[-9.0 to 9.0 / 0.0 / 0.1mm/step]
1-001-006	Leading Edge Registration	Tray1: Thick 3	ENG*	[-9.0 to 9.0 / 0.0 / 0.1mm/step]
1-001-007	Leading Edge Registration	Tray1: Thick 4	ENG*	[-9.0 to 9.0 / 0.0 / 0.1mm/step]
1-001-008	Leading Edge Registration	Tray2/3/4/5/LCT: Thin	ENG*	[-9.0 to 9.0 / 0.0 / 0.1mm/step]
1-001-009	Leading Edge Registration	Tray2/3/4/5/LCT: Plain	ENG*	[-9.0 to 9.0 / 0.0 / 0.1mm/step]
1-001-010	Leading Edge Registration	Tray2/3/4/5/LCT: Mid-thick	ENG*	[-9.0 to 9.0 / 0.0 / 0.1mm/step]
1-001-	Leading Edge Registration	Tray2/3/4/5/LCT: Thick 1	ENG*	[-9.0 to 9.0 / 0.0 / 0.1mm/step]

3.SP Mode Tables

SP No.	Large Category	Small Category	ENG or CTL	[Min to Max/Init./Step]
011				
1-001-012	Leading Edge Registration	Tray2/3/4/5/LCT: Thick 2	ENG*	[-9.0 to 9.0 / 0.0 / 0.1mm/step]
1-001-013	Leading Edge Registration	Tray2/3/4/5/LCT: Thick 3	ENG*	[-9.0 to 9.0 / 0.0 / 0.1mm/step]
1-001-014	Leading Edge Registration	Tray2/3/4/5/LCT: Thick 4	ENG*	[-9.0 to 9.0 / 0.0 / 0.1mm/step]
1-001-015	Leading Edge Registration	By-pass: Thin	ENG*	[-9.0 to 9.0 / 0.0 / 0.1mm/step]
1-001-016	Leading Edge Registration	By-pass: Plain	ENG*	[-9.0 to 9.0 / 0.0 / 0.1mm/step]
1-001-017	Leading Edge Registration	By-pass: Mid-thick	ENG*	[-9.0 to 9.0 / 0.0 / 0.1mm/step]
1-001-018	Leading Edge Registration	By-pass: Thick 1	ENG*	[-9.0 to 9.0 / 0.0 / 0.1mm/step]
1-001-019	Leading Edge Registration	By-pass: Thick 2	ENG*	[-9.0 to 9.0 / 0.0 / 0.1mm/step]
1-001-020	Leading Edge Registration	By-pass: Thick 3	ENG*	[-9.0 to 9.0 / 0.0 / 0.1mm/step]
1-001-021	Leading Edge Registration	By-pass: Thick 4	ENG*	[-9.0 to 9.0 / 0.0 / 0.1mm/step]
1-001-022	Leading Edge Registration	Duplex: Thin	ENG*	[-9.0 to 9.0 / 0.0 / 0.1mm/step]
1-001-	Leading Edge Registration	Duplex: Plain	ENG*	[-9.0 to 9.0 / 0.0 / 0.1mm/step]

3.SP Mode Tables

SP No.	Large Category	Small Category	ENG or CTL	[Min to Max/Init./Step]
023				
1-001-024	Leading Edge Registration	Duplex: Mid-thick	ENG*	[-9.0 to 9.0 / 0.0 / 0.1mm/step]
1-001-025	Leading Edge Registration	Duplex: Thick 1	ENG*	[-9.0 to 9.0 / 0.0 / 0.1mm/step]
1-001-026	Leading Edge Registration	Duplex: Thick 2	ENG*	[-9.0 to 9.0 / 0.0 / 0.1mm/step]
1-001-027	Leading Edge Registration	Duplex: Thick 3	ENG*	[-9.0 to 9.0 / 0.0 / 0.1mm/step]
1-001-028	Leading Edge Registration	Tray1: Thin:1200	ENG*	[-9.0 to 9.0 / 0.0 / 0.1mm/step]
1-001-029	Leading Edge Registration	Tray1: Plain:1200	ENG*	[-9.0 to 9.0 / 0.0 / 0.1mm/step]
1-001-030	Leading Edge Registration	Tray1: Mid-thick:1200	ENG*	[-9.0 to 9.0 / 0.0 / 0.1mm/step]
1-001-031	Leading Edge Registration	Tray1: Thick 1:1200	ENG*	[-9.0 to 9.0 / 0.0 / 0.1mm/step]
1-001-032	Leading Edge Registration	Tray1: Thick 2:1200	ENG*	[-9.0 to 9.0 / 0.0 / 0.1mm/step]
1-001-033	Leading Edge Registration	Tray1: Thick 3:1200	ENG*	[-9.0 to 9.0 / 0.0 / 0.1mm/step]
1-001-034	Leading Edge Registration	Tray1: Thick 4:1200	ENG*	[-9.0 to 9.0 / 0.0 / 0.1mm/step]
1-001-	Leading Edge Registration	Tray2/3/4/5/LCT: Thin:1200	ENG*	[-9.0 to 9.0 / 0.0 / 0.1mm/step]

3.SP Mode Tables

SP No.	Large Category	Small Category	ENG or CTL	[Min to Max/Init./Step]
035				
1-001-036	Leading Edge Registration	Tray2/3/4/5/LCT: Plain:1200	ENG*	[-9.0 to 9.0 / 0.0 / 0.1mm/step]
1-001-037	Leading Edge Registration	Tray2/3/4/5/LCT: Mid-thick:1200	ENG*	[-9.0 to 9.0 / 0.0 / 0.1mm/step]
1-001-038	Leading Edge Registration	Tray2/3/4/5/LCT: Thick 1:1200	ENG*	[-9.0 to 9.0 / 0.0 / 0.1mm/step]
1-001-039	Leading Edge Registration	Tray2/3/4/5/LCT: Thick 2:1200	ENG*	[-9.0 to 9.0 / 0.0 / 0.1mm/step]
1-001-040	Leading Edge Registration	Tray2/3/4/5/LCT: Thick 3:1200	ENG*	[-9.0 to 9.0 / 0.0 / 0.1mm/step]
1-001-041	Leading Edge Registration	Tray2/3/4/5/LCT: Thick 4:1200	ENG*	[-9.0 to 9.0 / 0.0 / 0.1mm/step]
1-001-042	Leading Edge Registration	By-pass: Thin:1200	ENG*	[-9.0 to 9.0 / 0.0 / 0.1mm/step]
1-001-043	Leading Edge Registration	By-pass: Plain:1200	ENG*	[-9.0 to 9.0 / 0.0 / 0.1mm/step]
1-001-044	Leading Edge Registration	By-pass: Mid-thick:1200	ENG*	[-9.0 to 9.0 / 0.0 / 0.1mm/step]
1-001-045	Leading Edge Registration	By-pass: Thick 1:1200	ENG*	[-9.0 to 9.0 / 0.0 / 0.1mm/step]
1-001-046	Leading Edge Registration	By-pass: Thick 2:1200	ENG*	[-9.0 to 9.0 / 0.0 / 0.1mm/step]
1-001-	Leading Edge Registration	By-pass: Thick 3:1200	ENG*	[-9.0 to 9.0 / 0.0 / 0.1mm/step]

3.SP Mode Tables

SP No.	Large Category	Small Category	ENG or CTL	[Min to Max/Init./Step]
047				
1-001-048	Leading Edge Registration	By-pass: Thick 4:1200	ENG*	[-9.0 to 9.0 / 0.0 / 0.1mm/step]
1-001-049	Leading Edge Registration	Duplex: Thin:1200	ENG*	[-9.0 to 9.0 / 0.0 / 0.1mm/step]
1-001-050	Leading Edge Registration	Duplex: Plain:1200	ENG*	[-9.0 to 9.0 / 0.0 / 0.1mm/step]
1-001-051	Leading Edge Registration	Duplex: Mid-thick:1200	ENG*	[-9.0 to 9.0 / 0.0 / 0.1mm/step]
1-001-052	Leading Edge Registration	Duplex: Thick 1:1200	ENG*	[-9.0 to 9.0 / 0.0 / 0.1mm/step]
1-001-053	Leading Edge Registration	Duplex: Thick 2:1200	ENG*	[-9.0 to 9.0 / 0.0 / 0.1mm/step]
1-001-054	Leading Edge Registration	Duplex: Thick 3:1200	ENG*	[-9.0 to 9.0 / 0.0 / 0.1mm/step]
1-002-001	Side-to-Side Registration	By-pass Tray	ENG*	[-4.0 to 4.0 / 0.0 / 0.1mm/step]
1-002-002	Side-to-Side Registration	Paper Tray 1	ENG*	[-4.0 to 4.0 / 0.0 / 0.1mm/step]
1-002-003	Side-to-Side Registration	Paper Tray 2	ENG*	[-4.0 to 4.0 / 0.0 / 0.1mm/step]
1-002-004	Side-to-Side Registration	Paper Tray 3	ENG*	[-4.0 to 4.0 / 0.0 / 0.1mm/step]
1-002-	Side-to-Side Registration	Paper Tray 4	ENG*	[-4.0 to 4.0 / 0.0 / 0.1mm/step]

3.SP Mode Tables

SP No.	Large Category	Small Category	ENG or CTL	[Min to Max/Init./Step]
005				
1-002-006	Side-to-Side Registration	Duplex	ENG*	[-4.0 to 4.0 / 0.0 / 0.1mm/step]
1-002-007	Side-to-Side Registration	Large Capacity Tray	ENG*	[-4.0 to 4.0 / 0.0 / 0.1mm/step]
1-003-001	Paper Buckle	Paper Tray1: Thin	ENG*	[-4.0 to 5.0 / 0.0 / 0.1mm/step]
1-003-002	Paper Buckle	Paper Tray1: Plain	ENG*	[-4.0 to 5.0 / 0.0 / 0.1mm/step]
1-003-003	Paper Buckle	Paper Tray 1: Mid-thick	ENG*	[-4.0 to 5.0 / 0.0 / 0.1mm/step]
1-003-004	Paper Buckle	Paper Tray1: Thick1	ENG*	[-4.0 to 5.0 / -3.5 / 0.1mm/step]
1-003-005	Paper Buckle	Tray2/3/4/5/LCT: Thin	ENG*	[-4.0 to 5.0 / 0.0 / 0.1mm/step]
1-003-006	Paper Buckle	Tray2/3/4/5/LCT: Plain	ENG*	[-4.0 to 5.0 / 0.0 / 0.1mm/step]
1-003-007	Paper Buckle	Tray 2/3/4/5/LCT: Mid-thick	ENG*	[-4.0 to 5.0 / 0.0 / 0.1mm/step]
1-003-008	Paper Buckle	Tray2/3/4/5/LCT: Thick 1	ENG*	[-4.0 to 5.0 / -3.5 / 0.1mm/step]
1-003-009	Paper Buckle	By-pass: Thin	ENG*	[-4.0 to 5.0 / 0.0 / 0.1mm/step]
1-003-	Paper Buckle	By-pass: Plain	ENG*	[-4.0 to 5.0 / 0.0 / 0.1mm/step]

3.SP Mode Tables

SP No.	Large Category	Small Category	ENG or CTL	[Min to Max/Init./Step]
010				
1-003-011	Paper Buckle	By-pass: Mid-thick	ENG*	[-4.0 to 5.0 / 0.0 / 0.1mm/step]
1-003-012	Paper Buckle	By-pass:Thick1	ENG*	[-4.0 to 5.0 / -3.0 / 0.1mm/step]
1-003-013	Paper Buckle	Duplex:Thin	ENG*	[-4.0 to 5.0 / -1.5 / 0.1mm/step]
1-003-014	Paper Buckle	Duplex:Plain	ENG*	[-4.0 to 5.0 / -1.5 / 0.1mm/step]
1-003-015	Paper Buckle	Duplex: Mid-thick	ENG*	[-4.0 to 5.0 / -1.5 / 0.1mm/step]
1-003-016	Paper Buckle	Duplex:Thick1	ENG*	[-4.0 to 5.0 / -3.5 / 0.1mm/step]
1-003-017	Paper Buckle	Paper Tray1: Thin:1200	ENG*	[-4.0 to 5.0 / 0.0 / 0.1mm/step]
1-003-018	Paper Buckle	Paper Tray1: Plain:1200	ENG*	[-4.0 to 5.0 / 0.0 / 0.1mm/step]
1-003-019	Paper Buckle	Paper Tray 1: Mid-thick:1200	ENG*	[-4.0 to 5.0 / 0.0 / 0.1mm/step]
1-003-020	Paper Buckle	Paper Tray1: Thick1:1200	ENG*	[-4.0 to 5.0 / -3.5 / 0.1mm/step]
1-003-021	Paper Buckle	Tray2/3/4/5/LCT: Thin:1200	ENG*	[-4.0 to 5.0 / 0.0 / 0.1mm/step]
1-003-	Paper Buckle	Tray2/3/4/5/LCT: Plain:1200	ENG*	[-4.0 to 5.0 / 0.0 / 0.1mm/step]

3.SP Mode Tables

SP No.	Large Category	Small Category	ENG or CTL	[Min to Max/Init./Step]
022				
1-003-023	Paper Buckle	Tray2/3/4/5/LCT: Mid:1200	ENG*	[-4.0 to 5.0 / 0.0 / 0.1mm/step]
1-003-024	Paper Buckle	Tray2/3/4/5/LCT: Thick 1:1200	ENG*	[-4.0 to 5.0 / -3.5 / 0.1mm/step]
1-003-025	Paper Buckle	By-pass: Thin:1200	ENG*	[-4.0 to 5.0 / 0.0 / 0.1mm/step]
1-003-026	Paper Buckle	By-pass: Plain:1200	ENG*	[-4.0 to 5.0 / 0.0 / 0.1mm/step]
1-003-027	Paper Buckle	By-pass: Mid-thick:1200	ENG*	[-4.0 to 5.0 / 0.0 / 0.1mm/step]
1-003-028	Paper Buckle	By-pass:Thick1:1200	ENG*	[-4.0 to 5.0 / -3.0 / 0.1mm/step]
1-003-029	Paper Buckle	Duplex:Thin:1200	ENG*	[-4.0 to 5.0 / -1.5 / 0.1mm/step]
1-003-030	Paper Buckle	Duplex:Plain:1200	ENG*	[-4.0 to 5.0 / -1.5 / 0.1mm/step]
1-003-031	Paper Buckle	Duplex: Mid-thick:1200	ENG*	[-4.0 to 5.0 / -1.5 / 0.1mm/step]
1-003-032	Paper Buckle	Duplex:Thick1:1200	ENG*	[-4.0 to 5.0 / -3.5 / 0.1mm/step]
1-007-001	By-Pass Size Detection	Switch LT SEF/LG SEF	ENG*	[0 to 1 / 0 / 1/step]
1-007-	By-Pass Size Detection	By-Pass Jam Detection Set	ENG*	[0 to 2 / 2 / 1/step]

3.SP Mode Tables

SP No.	Large Category	Small Category	ENG or CTL	[Min to Max/Init./Step]
002				
1-008-005	By-Pass Size Detection Adj	Standby Fence Moved Detecting Threshold	ENG*	[1.0 to 40.0 / 10.0 / 0.5mm/step]
1-008-006	By-Pass Size Detection Adj	Printing Fence Moved Detecting Threshold	ENG	[1.0 to 40.0 / 20.0 / 0.5mm/step]
1-008-032	By-Pass Size Detection Adj	Main Scan Size Adj	ENG	[0 to 1 / 0 / 1/step]
1-008-033	By-Pass Size Detection Adj	Main Scan Size Adj Result (0:Fail 1:Succeed)	ENG	[0 to 1 / 0 / 1/step]
1-008-039	By-Pass Size Detection Adj	Length Conversion:Intercept	ENG*	[0.00 to 100.00 / 86.00 / 0.01/step]
1-009-001	Initial Operation Setting	Registration Gear Backlash Cut	ENG*	[0 to 1 / 0 / 1/step]
1-009-002	Operation Setting	Paper Exit Speed	ENG*	[0 to 1 / 1 / 1/step]
1-009-003	Pickup SOL Separate Setting	Paper Tray1: Thin	ENG*	[0 to 1 / 0 / 1/step]
1-009-004	Pickup SOL Separate Setting	Paper Tray1: Plain	ENG*	[0 to 1 / 0 / 1/step]
1-009-005	Pickup SOL Separate Setting	Paper Tray1: Thick	ENG*	[0 to 1 / 0 / 1/step]
1-009-006	Pickup SOL Separate Setting	Paper Tray2: Thin	ENG*	[0 to 1 / 0 / 1/step]
1-009-	Pickup SOL Separate Setting	Paper Tray2: Plain	ENG*	[0 to 1 / 0 / 1/step]

3.SP Mode Tables

SP No.	Large Category	Small Category	ENG or CTL	[Min to Max/Init./Step]
007				
1-009-008	Pickup SOL Separate Setting	Paper Tray2: Thick	ENG*	[0 to 1 / 0 / 1/step]
1-009-009	Pickup SOL Separate Setting	Paper Tray3: Thin	ENG*	[0 to 1 / 0 / 1/step]
1-009-010	Pickup SOL Separate Setting	Paper Tray3: Plain	ENG*	[0 to 1 / 0 / 1/step]
1-009-011	Pickup SOL Separate Setting	Paper Tray3: Thick	ENG*	[0 to 1 / 0 / 1/step]
1-009-012	Pickup SOL Separate Setting	Paper Tray4: Thin	ENG*	[0 to 1 / 0 / 1/step]
1-009-013	Pickup SOL Separate Setting	Paper Tray4: Plain	ENG*	[0 to 1 / 0 / 1/step]
1-009-014	Pickup SOL Separate Setting	Paper Tray4: Thick	ENG*	[0 to 1 / 0 / 1/step]
1-009-015	Pickup SOL Separate Setting	Paper LCT: Thin	ENG*	[0 to 1 / 0 / 1/step]
1-009-016	Pickup SOL Separate Setting	Paper LCT: Plain	ENG*	[0 to 1 / 0 / 1/step]
1-009-017	Pickup SOL Separate Setting	Paper LCT: Thick	ENG*	[0 to 1 / 0 / 1/step]
1-009-018	Operation Setting	ExitLineSpdSetting: AfterSpdDown	ENG*	[0 to 3 / 1 / 1/step]
1-010-	Size Set Miss Detection Mode	Paper Length Err Detection	ENG	[0 to 1 / 1 / 1/step]

3.SP Mode Tables

SP No.	Large Category	Small Category	ENG or CTL	[Min to Max/Init./Step]
001				
1-010-002	Size Set Miss Detection Mode	Small Size Miss Set Detection	ENG	[0 to 1 / 1 / 1/step]
1-011-001	Size Set Miss Detection Count	Paper Length Detection	ENG	[0 to 65535 / 0 / 1/step]
1-011-002	Size Set Miss Detection Count	Small Size Miss Set Detection	ENG	[0 to 65535 / 0 / 1/step]
1-012-001	Size Miss Paper Ejection Count	Ejection Count	ENG	[0 to 65535 / 0 / 1/step]
1-013-001	Tray Down Erro Flag	Tray1	ENG*	[0 to 1 / 0 / 1/step]
1-013-002	Tray Down Erro Flag	Tray2	ENG*	[0 to 1 / 0 / 1/step]
1-013-003	Tray Down Erro Flag	Tray3	ENG*	[0 to 1 / 0 / 1/step]
1-013-004	Tray Down Erro Flag	Tray4	ENG*	[0 to 1 / 0 / 1/step]
1-014-001	Job End By-Pass Pick Up SOL Op	SOL Operation ON-OFF Switch	ENG	[0 to 1 / 1 / 1/step]
1-102-001	Feed Permit Setting	Temp.:Lower Delta:Center	ENG*	IM C3500: TWN: [0 to 200 / 31 / 1deg/step] NA: [0 to 200 / 31 / 1deg/step] KOR: [0 to 200 / 35 / 1deg/step] EU: [0 to 200 / 35 / 1deg/step]

3.SP Mode Tables

SP No.	Large Category	Small Category	ENG or CTL	[Min to Max/Init./Step]
				CHN: [0 to 200 / 35 / 1deg/step] AS: [0 to 200 / 35 / 1deg/step] IM C2500: TWN: [0 to 200 / 33 / 1deg/step] NA: [0 to 200 / 33 / 1deg/step] KOR: [0 to 200 / 38 / 1deg/step] EU: [0 to 200 / 38 / 1deg/step] CHN: [0 to 200 / 38 / 1deg/step] AS: [0 to 200 / 38 / 1deg/step] IM C2000: TWN: [0 to 200 / 33 / 1deg/step] NA: [0 to 200 / 33 / 1deg/step] KOR: [0 to 200 / 38 / 1deg/step] EU: [0 to 200 / 38 / 1deg/step] CHN: [0 to 200 / 38 / 1deg/step] AS: [0 to 200 / 38 / 1deg/step] IM C3000: TWN: [0 to 200 / 31 / 1deg/step] NA: [0 to 200 / 31 / 1deg/step] KOR: [0 to 200 / 35 / 1deg/step]

3.SP Mode Tables

SP No.	Large Category	Small Category	ENG or CTL	[Min to Max/Init./Step]
				EU: [0 to 200 / 35 / 1deg/step] CHN: [0 to 200 / 35 / 1deg/step] AS: [0 to 200 / 35 / 1deg/step]
1-102-002	Feed Permit Setting	Temp.:Lower Delta:End	ENG*	IM C3500: TWN: [0 to 200 / 31 / 1deg/step] NA: [0 to 200 / 31 / 1deg/step] KOR: [0 to 200 / 35 / 1deg/step] EU: [0 to 200 / 35 / 1deg/step] CHN: [0 to 200 / 35 / 1deg/step] AS: [0 to 200 / 35 / 1deg/step] IM C2500: TWN: [0 to 200 / 33 / 1deg/step] NA: [0 to 200 / 33 / 1deg/step] KOR: [0 to 200 / 38 / 1deg/step] EU: [0 to 200 / 38 / 1deg/step] CHN: [0 to 200 / 38 / 1deg/step] AS: [0 to 200 / 38 / 1deg/step] IM C2000: TWN: [0 to 200 / 33 / 1deg/step] NA: [0 to 200 / 33 / 1deg/step]

3.SP Mode Tables

SP No.	Large Category	Small Category	ENG or CTL	[Min to Max/Init./Step]
				KOR: [0 to 200 / 38 / 1deg/step] EU: [0 to 200 / 38 / 1deg/step] CHN: [0 to 200 / 38 / 1deg/step] AS: [0 to 200 / 38 / 1deg/step] IM C3000: TWN: [0 to 200 / 31 / 1deg/step] NA: [0 to 200 / 31 / 1deg/step] KOR: [0 to 200 / 35 / 1deg/step] EU: [0 to 200 / 35 / 1deg/step] CHN: [0 to 200 / 35 / 1deg/step] AS: [0 to 200 / 35 / 1deg/step]
1-102-003	Feed Permit Setting	Temp.:Upper Delta:Center	ENG*	IM C3500: [0 to 200 / 30 / 1deg/step] IM C2500: [0 to 200 / 40 / 1deg/step] IM C2000: [0 to 200 / 40 / 1deg/step] IM C3000: [0 to 200 / 30 / 1deg/step]
1-102-004	Feed Permit Setting	Temp.:Upper Delta:End	ENG*	IM C3500: [0 to 200 / 30 / 1deg/step] IM C2500:

3.SP Mode Tables

SP No.	Large Category	Small Category	ENG or CTL	[Min to Max/Init./Step]
				[0 to 200 / 40 / 1deg/step] IM C2000: [0 to 200 / 40 / 1deg/step] IM C3000: [0 to 200 / 30 / 1deg/step]
1-102-005	Feed Permit Setting	Temp.:Lower Delta:Press	ENG*	IM C3500: [0 to 200 / 90 / 1deg/step] IM C2500: [0 to 200 / 90 / 1deg/step] IM C2000: [0 to 200 / 90 / 1deg/step] IM C3000: [0 to 200 / 90 / 1deg/step]
1-102-006	Feed Permit Setting	Rotation Time	ENG*	IM C3500: [0.00 to 100.00 / 0.00 / 0.01sec/step] IM C2500: [0.00 to 100.00 / 0.65 / 0.01sec/step] IM C2000: [0.00 to 100.00 / 0.65 / 0.01sec/step] IM C3000: [0.00 to 100.00 / 0.00 / 0.01sec/step]
1-	Feed Permit Setting	Temp.:Lower Delta:Center:Sp.1	ENG*	IM C3500:

3.SP Mode Tables

SP No.	Large Category	Small Category	ENG or CTL	[Min to Max/Init./Step]
102-007				[0 to 200 / 5 / 1deg/step] IM C2500: [0 to 200 / 5 / 1deg/step] IM C2000: [0 to 200 / 5 / 1deg/step] IM C3000: [0 to 200 / 5 / 1deg/step]
1-102-008	Feed Permit Setting	Temp.:Lower Delta:End:Sp.1	ENG*	IM C3500: [0 to 200 / 5 / 1deg/step] IM C2500: [0 to 200 / 5 / 1deg/step] IM C2000: [0 to 200 / 5 / 1deg/step] IM C3000: [0 to 200 / 5 / 1deg/step]
1-102-009	Feed Permit Setting	Temp.:Upper Delta:Center:Sp.1	ENG*	IM C3500: [0 to 200 / 30 / 1deg/step] IM C2500: [0 to 200 / 30 / 1deg/step] IM C2000: [0 to 200 / 30 / 1deg/step] IM C3000: [0 to 200 / 30 / 1deg/step]
1-102-	Feed Permit Setting	Temp.:Upper Delta:End:Sp.1	ENG*	IM C3500: [0 to 200 / 30 /

3.SP Mode Tables

SP No.	Large Category	Small Category	ENG or CTL	[Min to Max/Init./Step]
010				1deg/step] IM C2500: [0 to 200 / 30 / 1deg/step] IM C2000: [0 to 200 / 30 / 1deg/step] IM C3000: [0 to 200 / 30 / 1deg/step]
1-102-011	Feed Permit Setting	Temp.:Lower Delta:Press:Sp.1	ENG*	IM C3500: [0 to 200 / 45 / 1deg/step] IM C2500: [0 to 200 / 45 / 1deg/step] IM C2000: [0 to 200 / 45 / 1deg/step] IM C3000: [0 to 200 / 45 / 1deg/step]
1-102-012	Feed Permit Setting	Rotation Time:Sp.1	ENG*	IM C3500: [0.00 to 200.00 / 0.00 / 0.01sec/step] IM C2500: [0.00 to 200.00 / 0.65 / 0.01sec/step] IM C2000: [0.00 to 200.00 / 0.65 / 0.01sec/step] IM C3000: [0.00 to 200.00 / 0.00 /

3.SP Mode Tables

SP No.	Large Category	Small Category	ENG or CTL	[Min to Max/Init./Step]
				0.01sec/step]
1-102-013	Feed Permit Setting	Temp.:Lower Delta:Center:Sp.2	ENG*	[0 to 200 / 5 / 1deg/step]
1-102-014	Feed Permit Setting	Temp.:Lower Delta:End:Sp.2	ENG*	IM C3500: [0 to 200 / 5 / 1deg/step] IM C2500: [0 to 200 / 5 / 1deg/step] IM C2000: [0 to 200 / 5 / 1deg/step] IM C3000: [0 to 200 / 5 / 1deg/step]
1-102-015	Feed Permit Setting	Temp.:Upper Delta:Center:Sp.2	ENG*	[0 to 200 / 15 / 1deg/step]
1-102-016	Feed Permit Setting	Temp.:Upper Delta:End:Sp.2	ENG*	IM C3500: [0 to 200 / 15 / 1deg/step] IM C2500: [0 to 200 / 15 / 1deg/step] IM C2000: [0 to 200 / 15 / 1deg/step] IM C3000: [0 to 200 / 15 / 1deg/step]
1-102-017	Feed Permit Setting	Temp.:Lower Delta:Press:Sp.2	ENG*	[0 to 200 / 100 / 1deg/step]
1-102-018	Feed Permit Setting	Rotation Time:Sp2	ENG*	IM C3500: [0.00 to 100.00 / 0.00 /

3.SP Mode Tables

SP No.	Large Category	Small Category	ENG or CTL	[Min to Max/Init./Step]
				0.01sec/step] IM C2500: [0.00 to 100.00 / 0.65 / 0.01sec/step] IM C2000: [0.00 to 100.00 / 0.65 / 0.01sec/step] IM C3000: [0.00 to 100.00 / 0.00 / 0.01sec/step]
1-102-019	Feed Permit Setting	Feed Permit Time	ENG*	IM C3500: [0 to 200 / 60 / 1sec/step] IM C2500: [0 to 200 / 60 / 1sec/step] IM C2000: [0 to 200 / 60 / 1sec/step] IM C3000: [0 to 200 / 60 / 1sec/step]
1-102-020	Feed Permit Setting	Temp.:Lower Delta:Center	ENG*	IM C3500: [0 to 200 / 40 / 1deg/step] IM C2500: [0 to 200 / 40 / 1deg/step] IM C2000: [0 to 200 / 40 / 1deg/step] IM C3000: [0 to 200 / 40 / 1deg/step]

3.SP Mode Tables

SP No.	Large Category	Small Category	ENG or CTL	[Min to Max/Init./Step]
1-102-021	Feed Permit Setting	Temp.:Lower Delta:End	ENG*	IM C3500: [0 to 200 / 40 / 1deg/step] IM C2500: [0 to 200 / 40 / 1deg/step] IM C2000: [0 to 200 / 40 / 1deg/step] IM C3000: [0 to 200 / 40 / 1deg/step]
1-102-022	Feed Permit Setting	Temp.:Upper Delta:Center	ENG*	[0 to 200 / 30 / 1deg/step]
1-102-023	Feed Permit Setting	Temp.:Upper Delta:End	ENG*	[0 to 200 / 30 / 1deg/step]
1-102-024	Feed Permit Setting	Temp.:Lower Delta:Press	ENG*	IM C3500: [0 to 200 / 38 / 1deg/step] IM C2500: [0 to 200 / 38 / 1deg/step] IM C2000: [0 to 200 / 38 / 1deg/step] IM C3000: [0 to 200 / 38 / 1deg/step]
1-102-025	Feed Permit Setting	Temp.:Lower Delta:Press	ENG*	IM C3500: [0 to 200 / 53 / 1deg/step] IM C2500: [0 to 200 / 53 / 1deg/step] IM C2000:

3.SP Mode Tables

SP No.	Large Category	Small Category	ENG or CTL	[Min to Max/Init./Step]
				[0 to 200 / 53 / 1deg/step] IM C3000: [0 to 200 / 53 / 1deg/step]
1-102-026	Feed Permit Setting	Rotation Time	ENG*	IM C3500: [0.00 to 100.00 / 0.00 / 0.01sec/step] IM C2500: [0.00 to 100.00 / 0.65 / 0.01sec/step] IM C2000: [0.00 to 100.00 / 0.65 / 0.01sec/step] IM C3000: [0.00 to 100.00 / 0.00 / 0.01sec/step]
1-102-027	Feed Permit Setting	Temp.:Lower Delta:Center	ENG*	[0 to 200 / 5 / 1deg/step]
1-102-028	Feed Permit Setting	Temp.:Lower Delta:End	ENG*	[0 to 200 / 5 / 1deg/step]
1-102-029	Feed Permit Setting	Temp.:Upper Delta:Center	ENG*	[0 to 200 / 30 / 1deg/step]
1-102-030	Feed Permit Setting	Temp.:Upper Delta:End	ENG*	[0 to 200 / 30 / 1deg/step]
1-102-031	Feed Permit Setting	Temp.:Lower Delta:Press	ENG*	IM C3500: [0 to 200 / 34 / 1deg/step] IM C2500:

3.SP Mode Tables

SP No.	Large Category	Small Category	ENG or CTL	[Min to Max/Init./Step]
				[0 to 200 / 34 / 1deg/step] IM C2000: [0 to 200 / 34 / 1deg/step] IM C3000: [0 to 200 / 34 / 1deg/step]
1-102-032	Feed Permit Setting	Temp.:Lower Delta:Press	ENG*	IM C3500: [0 to 200 / 49 / 1deg/step] IM C2500: [0 to 200 / 49 / 1deg/step] IM C2000: [0 to 200 / 49 / 1deg/step] IM C3000: [0 to 200 / 49 / 1deg/step]
1-102-033	Feed Permit Setting	Rotation Time	ENG*	IM C3500: [0.00 to 100.00 / 0.00 / 0.01sec/step] IM C2500: [0.00 to 100.00 / 0.65 / 0.01sec/step] IM C2000: [0.00 to 100.00 / 0.65 / 0.01sec/step] IM C3000: [0.00 to 100.00 / 0.00 / 0.01sec/step]
1-	Feed Permit Setting	Temp.:Lower Delta:Center	ENG*	[0 to 200 / 5 /

3.SP Mode Tables

SP No.	Large Category	Small Category	ENG or CTL	[Min to Max/Init./Step]
102-034				1deg/step]
1-102-035	Feed Permit Setting	Temp.:Lower Delta:End	ENG*	[0 to 200 / 5 / 1deg/step]
1-102-036	Feed Permit Setting	Temp.:Upper Delta:Center	ENG*	[0 to 200 / 15 / 1deg/step]
1-102-037	Feed Permit Setting	Temp.:Upper Delta:End	ENG*	[0 to 200 / 15 / 1deg/step]
1-102-038	Feed Permit Setting	Temp.:Lower Delta:Press	ENG*	[0 to 200 / 45 / 1deg/step]
1-102-039	Feed Permit Setting	Temp.:Lower Delta:Press	ENG*	[0 to 200 / 57 / 1deg/step]
1-102-040	Feed Permit Setting	Rotation Time	ENG*	IM C3500: [0.00 to 100.00 / 0.00 / 0.01sec/step] IM C2500: [0.00 to 100.00 / 0.65 / 0.01sec/step] IM C2000: [0.00 to 100.00 / 0.65 / 0.01sec/step] IM C3000: [0.00 to 100.00 / 0.00 / 0.01sec/step]
1-102-041	Feed Permit Setting	Judgment Power A	ENG*	IM C3500: TWN: [0 to 2000 / 1324 / 1W/step] NA: [0 to 2000 /

3.SP Mode Tables

SP No.	Large Category	Small Category	ENG or CTL	[Min to Max/Init./Step]
				1324 / 1W/step] KOR: [0 to 2000 / 1444 / 1W/step] EU: [0 to 2000 / 1444 / 1W/step] CHN: [0 to 2000 / 1444 / 1W/step] AS: [0 to 2000 / 1444 / 1W/step] IM C2500: TWN: [0 to 2000 / 1324 / 1W/step] NA: [0 to 2000 / 1324 / 1W/step] KOR: [0 to 2000 / 1444 / 1W/step] EU: [0 to 2000 / 1444 / 1W/step] CHN: [0 to 2000 / 1444 / 1W/step] AS: [0 to 2000 / 1444 / 1W/step] IM C2000: TWN: [0 to 2000 / 1324 / 1W/step] NA: [0 to 2000 / 1324 / 1W/step] KOR: [0 to 2000 / 1444 / 1W/step] EU: [0 to 2000 / 1444 / 1W/step] CHN: [0 to 2000 / 1444 / 1W/step] AS: [0 to 2000 / 1444 / 1W/step] IM C3000: TWN: [0 to 2000 /

3.SP Mode Tables

SP No.	Large Category	Small Category	ENG or CTL	[Min to Max/Init./Step]
				1324 / 1W/step] NA: [0 to 2000 / 1324 / 1W/step] KOR: [0 to 2000 / 1444 / 1W/step] EU: [0 to 2000 / 1444 / 1W/step] CHN: [0 to 2000 / 1444 / 1W/step] AS: [0 to 2000 / 1444 / 1W/step]
1-102-042	Feed Permit Setting	Temp.:Lower Delta:Center:Power A	ENG*	IM C3500: [0 to 200 / 41 / 1deg/step] IM C2500: [0 to 200 / 49 / 1deg/step] IM C2000: [0 to 200 / 49 / 1deg/step] IM C3000: [0 to 200 / 41 / 1deg/step]
1-102-043	Feed Permit Setting	Temp.:Lower Delta::Power A	ENG*	IM C3500: [0 to 200 / 41 / 1deg/step] IM C2500: [0 to 200 / 49 / 1deg/step] IM C2000: [0 to 200 / 49 / 1deg/step] IM C3000: [0 to 200 / 41 / 1deg/step]
1-102-	Feed Permit Setting	Temp.:Upper Delta:Center:Power A	ENG*	IM C3500: [0 to 200 / 30 /

3.SP Mode Tables

SP No.	Large Category	Small Category	ENG or CTL	[Min to Max/Init./Step]
044				1deg/step] IM C2500: [0 to 200 / 40 / 1deg/step] IM C2000: [0 to 200 / 40 / 1deg/step] IM C3000: [0 to 200 / 30 / 1deg/step]
1-102-045	Feed Permit Setting	Temp.:Upper Delta:End:Power A	ENG*	IM C3500: [0 to 200 / 30 / 1deg/step] IM C2500: [0 to 200 / 40 / 1deg/step] IM C2000: [0 to 200 / 40 / 1deg/step] IM C3000: [0 to 200 / 30 / 1deg/step]
1-102-046	Feed Permit Setting	Temp.:Lower Delta:Press:Power A	ENG*	IM C3500: [0 to 200 / 90 / 1deg/step] IM C2500: [0 to 200 / 90 / 1deg/step] IM C2000: [0 to 200 / 90 / 1deg/step] IM C3000: [0 to 200 / 90 / 1deg/step]
1-102-047	Feed Permit Setting	Rotation Time:Power A	ENG*	IM C3500: [0.00 to 100.00 / 0.00 /

3.SP Mode Tables

SP No.	Large Category	Small Category	ENG or CTL	[Min to Max/Init./Step]
				0.01sec/step] IM C2500: [0.00 to 100.00 / 0.65 / 0.01sec/step] IM C2000: [0.00 to 100.00 / 0.65 / 0.01sec/step] IM C3000: [0.00 to 100.00 / 0.00 / 0.01sec/step]
1-102-051	Feed Permit Setting	Judgment Power B	ENG*	IM C3500: TWN: [0 to 2000 / 1294 / 1W/step] NA: [0 to 2000 / 1294 / 1W/step] KOR: [0 to 2000 / 1414 / 1W/step] EU: [0 to 2000 / 1414 / 1W/step] CHN: [0 to 2000 / 1414 / 1W/step] AS: [0 to 2000 / 1414 / 1W/step] IM C2500: TWN: [0 to 2000 / 1294 / 1W/step] NA: [0 to 2000 / 1294 / 1W/step] KOR: [0 to 2000 / 1414 / 1W/step] EU: [0 to 2000 / 1414 / 1W/step] CHN: [0 to 2000 / 1414 / 1W/step]

3.SP Mode Tables

SP No.	Large Category	Small Category	ENG or CTL	[Min to Max/Init./Step]
				AS: [0 to 2000 / 1414 / 1W/step] IM C2000: TWN: [0 to 2000 / 1294 / 1W/step] NA: [0 to 2000 / 1294 / 1W/step] KOR: [0 to 2000 / 1414 / 1W/step] EU: [0 to 2000 / 1414 / 1W/step] CHN: [0 to 2000 / 1414 / 1W/step] AS: [0 to 2000 / 1414 / 1W/step] IM C3000: TWN: [0 to 2000 / 1294 / 1W/step] NA: [0 to 2000 / 1294 / 1W/step] KOR: [0 to 2000 / 1414 / 1W/step] EU: [0 to 2000 / 1414 / 1W/step] CHN: [0 to 2000 / 1414 / 1W/step] AS: [0 to 2000 / 1414 / 1W/step]
1-102-052	Feed Permit Setting	Temp.:Lower Delta:Center:Power B	ENG*	IM C3500: [0 to 200 / 41 / 1deg/step] IM C2500: [0 to 200 / 49 / 1deg/step] IM C2000: [0 to 200 / 49 / 1deg/step]

3.SP Mode Tables

SP No.	Large Category	Small Category	ENG or CTL	[Min to Max/Init./Step]
				IM C3000: [0 to 200 / 41 / 1deg/step]
1-102-053	Feed Permit Setting	Temp.:Lower Delta:End:Power B	ENG*	IM C3500: [0 to 200 / 41 / 1deg/step] IM C2500: [0 to 200 / 49 / 1deg/step] IM C2000: [0 to 200 / 49 / 1deg/step] IM C3000: [0 to 200 / 41 / 1deg/step]
1-102-054	Feed Permit Setting	Temp.:Upper Delta:Center:Power B	ENG*	IM C3500: [0 to 200 / 30 / 1deg/step] IM C2500: [0 to 200 / 40 / 1deg/step] IM C2000: [0 to 200 / 40 / 1deg/step] IM C3000: [0 to 200 / 30 / 1deg/step]
1-102-055	Feed Permit Setting	Temp.:Upper Delta:End:Power B	ENG*	IM C3500: [0 to 200 / 30 / 1deg/step] IM C2500: [0 to 200 / 40 / 1deg/step] IM C2000: [0 to 200 / 40 / 1deg/step] IM C3000:

3.SP Mode Tables

SP No.	Large Category	Small Category	ENG or CTL	[Min to Max/Init./Step]
				[0 to 200 / 30 / 1deg/step]
1-102-056	Feed Permit Setting	Temp.:Lower Delta:Press:Power B	ENG*	IM C3500: [0 to 200 / 77 / 1deg/step] IM C2500: [0 to 200 / 90 / 1deg/step] IM C2000: [0 to 200 / 90 / 1deg/step] IM C3000: [0 to 200 / 77 / 1deg/step]
1-102-057	Feed Permit Setting	Rotation Time:Power B	ENG*	IM C3500: [0.00 to 100.00 / 0.00 / 0.01sec/step] IM C2500: [0.00 to 100.00 / 0.65 / 0.01sec/step] IM C2000: [0.00 to 100.00 / 0.65 / 0.01sec/step] IM C3000: [0.00 to 100.00 / 0.00 / 0.01sec/step]
1-102-060	Feed Permit Setting	Waiting Time: Stabilize Temp.	ENG*	IM C3500: [0 to 10000 / 0 / 1msec/step] IM C2500: [0 to 10000 / 0 / 1msec/step] IM C2000:

3.SP Mode Tables

SP No.	Large Category	Small Category	ENG or CTL	[Min to Max/Init./Step]
				[0 to 10000 / 0 / 1msec/step] IM C3000: [0 to 10000 / 0 / 1msec/step]
1-102-061	Feed Permit Setting	Rotation Time:Temp:Low	ENG*	IM C3500: [0.00 to 100.00 / 0.00 / 0.01sec/step] IM C2500: [0.00 to 100.00 / 0.65 / 0.01sec/step] IM C2000: [0.00 to 100.00 / 0.65 / 0.01sec/step] IM C3000: [0.00 to 100.00 / 0.00 / 0.01sec/step]
1-102-062	Feed Permit Setting	Rotation Time:Voltage:Low	ENG*	IM C3500: [0.00 to 100.00 / 0.00 / 0.01sec/step] IM C2500: [0.00 to 100.00 / 0.65 / 0.01sec/step] IM C2000: [0.00 to 100.00 / 0.65 / 0.01sec/step] IM C3000: [0.00 to 100.00 / 0.00 / 0.01sec/step]

3.SP Mode Tables

SP No.	Large Category	Small Category	ENG or CTL	[Min to Max/Init./Step]
1-102-070	Feed Permit Setting	Timeout: Cold: Normal	ENG*	IM C3500: [0 to 20000 / 4000 / 1msec/step] IM C2500: [0 to 20000 / 4000 / 1msec/step] IM C2000: [0 to 20000 / 4000 / 1msec/step] IM C3000: [0 to 20000 / 4000 / 1msec/step]
1-102-071	Feed Permit Setting	Timeout: Hot: Normal	ENG*	IM C3500: [0 to 20000 / 4000 / 1msec/step] IM C2500: [0 to 20000 / 4000 / 1msec/step] IM C2000: [0 to 20000 / 4000 / 1msec/step] IM C3000: [0 to 20000 / 4000 / 1msec/step]
1-102-072	Feed Permit Setting	Timeout: Cold: Power 1	ENG*	IM C3500: [0 to 20000 / 4000 / 1msec/step] IM C2500: [0 to 20000 / 4000 / 1msec/step] IM C2000: [0 to 20000 / 4000 / 1msec/step] IM C3000: [0 to 20000 / 4000 / 1msec/step]
1-	Feed Permit Setting	Timeout: Hot: Power 1	ENG*	IM C3500:

3.SP Mode Tables

SP No.	Large Category	Small Category	ENG or CTL	[Min to Max/Init./Step]
102-073				[0 to 20000 / 4000 / 1msec/step] IM C2500: [0 to 20000 / 4000 / 1msec/step] IM C2000: [0 to 20000 / 4000 / 1msec/step] IM C3000: [0 to 20000 / 4000 / 1msec/step]
1-102-074	Feed Permit Setting	Timeout: Cold: Power 2	ENG*	IM C3500: [0 to 20000 / 4000 / 1msec/step] IM C2500: [0 to 20000 / 4000 / 1msec/step] IM C2000: [0 to 20000 / 4000 / 1msec/step] IM C3000: [0 to 20000 / 4000 / 1msec/step]
1-102-075	Feed Permit Setting	Timeout: Hot: Power 2	ENG*	IM C3500: [0 to 20000 / 4000 / 1msec/step] IM C2500: [0 to 20000 / 4000 / 1msec/step] IM C2000: [0 to 20000 / 4000 / 1msec/step] IM C3000: [0 to 20000 / 4000 / 1msec/step]
1-102-	Feed Permit Setting	Timeout: 10sec: 11	ENG*	IM C3500: [0 to 20000 / 4000

3.SP Mode Tables

SP No.	Large Category	Small Category	ENG or CTL	[Min to Max/Init./Step]
076				/ 1msec/step] IM C2500: [0 to 20000 / 4000 / 1msec/step] IM C2000: [0 to 20000 / 4000 / 1msec/step] IM C3000: [0 to 20000 / 4000 / 1msec/step]
1-102-077	Feed Permit Setting	Timeout: 10sec: 15	ENG*	IM C3500: [0 to 20000 / 4000 / 1msec/step] IM C2500: [0 to 20000 / 4000 / 1msec/step] IM C2000: [0 to 20000 / 4000 / 1msec/step] IM C3000: [0 to 20000 / 4000 / 1msec/step]
1-102-078	Feed Permit Setting	Timeout: 10sec: 16	ENG*	IM C3500: [0 to 20000 / 4000 / 1msec/step] IM C2500: [0 to 20000 / 4000 / 1msec/step] IM C2000: [0 to 20000 / 4000 / 1msec/step] IM C3000: [0 to 20000 / 4000 / 1msec/step]
1-102-101	Feed Permit Setting	Temp.:Lower Delta:Press0	ENG*	IM C3500: [0 to 200 / 0 / 1deg/step]

3.SP Mode Tables

SP No.	Large Category	Small Category	ENG or CTL	[Min to Max/Init./Step]
				IM C2500: [0 to 200 / 0 / 1deg/step] IM C2000: [0 to 200 / 0 / 1deg/step] IM C3000: [0 to 200 / 0 / 1deg/step]
1-102-102	Feed Permit Setting	Temp.:Lower Delta:Press10	ENG*	IM C3500: [0 to 200 / 0 / 1deg/step] IM C2500: [0 to 200 / 0 / 1deg/step] IM C2000: [0 to 200 / 0 / 1deg/step] IM C3000: [0 to 200 / 0 / 1deg/step]
1-102-103	Feed Permit Setting	Temp.:Lower Delta:Press1	ENG*	IM C3500: [0 to 200 / 0 / 1deg/step] IM C2500: [0 to 200 / 0 / 1deg/step] IM C2000: [0 to 200 / 0 / 1deg/step] IM C3000: [0 to 200 / 0 / 1deg/step]
1-102-104	Feed Permit Setting	Temp.:Lower Delta:Press2	ENG*	IM C3500: [0 to 200 / 0 / 1deg/step] IM C2500:

3.SP Mode Tables

SP No.	Large Category	Small Category	ENG or CTL	[Min to Max/Init./Step]
				[0 to 200 / 0 / 1deg/step] IM C2000: [0 to 200 / 0 / 1deg/step] IM C3000: [0 to 200 / 0 / 1deg/step]
1-102-105	Feed Permit Setting	Temp.:Lower Delta:Press3	ENG*	IM C3500: [0 to 200 / 0 / 1deg/step] IM C2500: [0 to 200 / 0 / 1deg/step] IM C2000: [0 to 200 / 0 / 1deg/step] IM C3000: [0 to 200 / 0 / 1deg/step]
1-102-106	Feed Permit Setting	Temp.:Lower Delta:Press13	ENG*	IM C3500: [0 to 200 / 0 / 1deg/step] IM C2500: [0 to 200 / 0 / 1deg/step] IM C2000: [0 to 200 / 0 / 1deg/step] IM C3000: [0 to 200 / 0 / 1deg/step]
1-102-107	Feed Permit Setting	Temp.:Lower Delta:Press4	ENG*	IM C3500: [0 to 200 / 0 / 1deg/step] IM C2500: [0 to 200 / 0 /

3.SP Mode Tables

SP No.	Large Category	Small Category	ENG or CTL	[Min to Max/Init./Step]
				1deg/step] IM C2000: [0 to 200 / 0 / 1deg/step] IM C3000: [0 to 200 / 0 / 1deg/step]
1- 102- 108	Feed Permit Setting	Temp.:Lower Delta:Press14	ENG*	IM C3500: [0 to 200 / 0 / 1deg/step] IM C2500: [0 to 200 / 0 / 1deg/step] IM C2000: [0 to 200 / 0 / 1deg/step] IM C3000: [0 to 200 / 0 / 1deg/step]
1- 102- 109	Feed Permit Setting	Temp.:Lower Delta:Press5	ENG*	IM C3500: [0 to 200 / 17 / 1deg/step] IM C2500: [0 to 200 / 17 / 1deg/step] IM C2000: [0 to 200 / 17 / 1deg/step] IM C3000: [0 to 200 / 17 / 1deg/step]
1- 102- 110	Feed Permit Setting	Temp.:Lower Delta:Press6	ENG*	IM C3500: [0 to 200 / 17 / 1deg/step] IM C2500: [0 to 200 / 17 / 1deg/step]

3.SP Mode Tables

SP No.	Large Category	Small Category	ENG or CTL	[Min to Max/Init./Step]
				IM C2000: [0 to 200 / 17 / 1deg/step] IM C3000: [0 to 200 / 17 / 1deg/step]
1-102-111	Feed Permit Setting	Temp.:Lower Delta:Press7	ENG*	IM C3500: [0 to 200 / 13 / 1deg/step] IM C2500: [0 to 200 / 13 / 1deg/step] IM C2000: [0 to 200 / 13 / 1deg/step] IM C3000: [0 to 200 / 13 / 1deg/step]
1-102-112	Feed Permit Setting	Temp.:Lower Delta:Press11	ENG*	IM C3500: [0 to 200 / 0 / 1deg/step] IM C2500: [0 to 200 / 0 / 1deg/step] IM C2000: [0 to 200 / 0 / 1deg/step] IM C3000: [0 to 200 / 0 / 1deg/step]
1-102-113	Feed Permit Setting	Temp.:Lower Delta:Press15	ENG*	IM C3500: [0 to 200 / 0 / 1deg/step] IM C2500: [0 to 200 / 0 / 1deg/step] IM C2000:

3.SP Mode Tables

SP No.	Large Category	Small Category	ENG or CTL	[Min to Max/Init./Step]
				[0 to 200 / 0 / 1deg/step] IM C3000: [0 to 200 / 0 / 1deg/step]
1-102-114	Feed Permit Setting	Temp.:Lower Delta:Press16	ENG*	IM C3500: [0 to 200 / 0 / 1deg/step] IM C2500: [0 to 200 / 0 / 1deg/step] IM C2000: [0 to 200 / 0 / 1deg/step] IM C3000: [0 to 200 / 0 / 1deg/step]
1-102-121	Feed Permit Setting	Timeout:Press0	ENG*	IM C3500: [0 to 60000 / 0 / 1msec/step] IM C2500: [0 to 60000 / 0 / 1msec/step] IM C2000: [0 to 60000 / 0 / 1msec/step] IM C3000: [0 to 60000 / 0 / 1msec/step]
1-102-122	Feed Permit Setting	Timeout:Press10	ENG*	IM C3500: [0 to 60000 / 0 / 1msec/step] IM C2500: [0 to 60000 / 0 / 1msec/step] IM C2000: [0 to 60000 / 0 /

3.SP Mode Tables

SP No.	Large Category	Small Category	ENG or CTL	[Min to Max/Init./Step]
				1msec/step] IM C3000: [0 to 60000 / 0 / 1msec/step]
1- 102- 123	Feed Permit Setting	Timeout:Press1	ENG*	IM C3500: [0 to 60000 / 0 / 1msec/step] IM C2500: [0 to 60000 / 0 / 1msec/step] IM C2000: [0 to 60000 / 0 / 1msec/step] IM C3000: [0 to 60000 / 0 / 1msec/step]
1- 102- 124	Feed Permit Setting	Timeout:Press2	ENG*	IM C3500: [0 to 60000 / 0 / 1msec/step] IM C2500: [0 to 60000 / 0 / 1msec/step] IM C2000: [0 to 60000 / 0 / 1msec/step] IM C3000: [0 to 60000 / 0 / 1msec/step]
1- 102- 125	Feed Permit Setting	Timeout:Press3	ENG*	IM C3500: [0 to 60000 / 0 / 1msec/step] IM C2500: [0 to 60000 / 0 / 1msec/step] IM C2000: [0 to 60000 / 0 / 1msec/step]

3.SP Mode Tables

SP No.	Large Category	Small Category	ENG or CTL	[Min to Max/Init./Step]
				IM C3000: [0 to 60000 / 0 / 1msec/step]
1-102-126	Feed Permit Setting	Timeout:Press13	ENG*	IM C3500: [0 to 60000 / 0 / 1msec/step] IM C2500: [0 to 60000 / 0 / 1msec/step] IM C2000: [0 to 60000 / 0 / 1msec/step] IM C3000: [0 to 60000 / 0 / 1msec/step]
1-102-127	Feed Permit Setting	Timeout:Press4	ENG*	IM C3500: [0 to 60000 / 0 / 1msec/step] IM C2500: [0 to 60000 / 0 / 1msec/step] IM C2000: [0 to 60000 / 0 / 1msec/step] IM C3000: [0 to 60000 / 0 / 1msec/step]
1-102-128	Feed Permit Setting	Timeout:Press14	ENG*	IM C3500: [0 to 60000 / 0 / 1msec/step] IM C2500: [0 to 60000 / 0 / 1msec/step] IM C2000: [0 to 60000 / 0 / 1msec/step] IM C3000:

3.SP Mode Tables

SP No.	Large Category	Small Category	ENG or CTL	[Min to Max/Init./Step]
				[0 to 60000 / 0 / 1msec/step]
1-102-129	Feed Permit Setting	Timeout:Press5	ENG*	IM C3500: [0 to 60000 / 5000 / 1msec/step] IM C2500: [0 to 60000 / 5000 / 1msec/step] IM C2000: [0 to 60000 / 5000 / 1msec/step] IM C3000: [0 to 60000 / 5000 / 1msec/step]
1-102-130	Feed Permit Setting	Timeout:Press6	ENG*	IM C3500: [0 to 60000 / 5000 / 1msec/step] IM C2500: [0 to 60000 / 5000 / 1msec/step] IM C2000: [0 to 60000 / 5000 / 1msec/step] IM C3000: [0 to 60000 / 5000 / 1msec/step]
1-102-131	Feed Permit Setting	Timeout:Press7	ENG*	IM C3500: [0 to 60000 / 3000 / 1msec/step] IM C2500: [0 to 60000 / 3000 / 1msec/step] IM C2000: [0 to 60000 / 3000 / 1msec/step] IM C3000: [0 to 60000 / 3000 / 1msec/step]

3.SP Mode Tables

SP No.	Large Category	Small Category	ENG or CTL	[Min to Max/Init./Step]
				/ 1msec/step]
1- 102- 132	Feed Permit Setting	Timeout: Press: 11	ENG*	IM C3500: [0 to 60000 / 0 / 1msec/step] IM C2500: [0 to 60000 / 0 / 1msec/step] IM C2000: [0 to 60000 / 0 / 1msec/step] IM C3000: [0 to 60000 / 0 / 1msec/step]
1- 102- 133	Feed Permit Setting	Timeout: Press: 15	ENG*	IM C3500: [0 to 60000 / 0 / 1msec/step] IM C2500: [0 to 60000 / 0 / 1msec/step] IM C2000: [0 to 60000 / 0 / 1msec/step] IM C3000: [0 to 60000 / 0 / 1msec/step]
1- 102- 134	Feed Permit Setting	Timeout: Press: 16	ENG*	IM C3500: [0 to 60000 / 0 / 1msec/step] IM C2500: [0 to 60000 / 0 / 1msec/step] IM C2000: [0 to 60000 / 0 / 1msec/step] IM C3000: [0 to 60000 / 0 / 1msec/step]

3.SP Mode Tables

SP No.	Large Category	Small Category	ENG or CTL	[Min to Max/Init./Step]
1-102-151	Feed Permit Setting	Temp:Judge:Middle:High Power	ENG*	[0 to 200 / 198 / 1deg/step]
1-102-152	Feed Permit Setting	Temp:Judge:low:Middle Power	ENG*	[0 to 200 / 199 / 1deg/step]
1-102-153	Feed Permit Setting	Temp:Judge:low:High Power	ENG*	[0 to 200 / 200 / 1deg/step]
1-105-001	Print Target Temp.	Plain1:FC:Center	ENG*	IM C3500: [100 to 180 / 123 / 1deg/step] IM C2500: [100 to 180 / 123 / 1deg/step] IM C2000: [100 to 180 / 126 / 1deg/step] IM C3000: [100 to 180 / 123 / 1deg/step]
1-105-002	Print Target Temp.	Plain1:FC:Press	ENG*	IM C3500: [0 to 200 / 122 / 1deg/step] IM C2500: [0 to 200 / 122 / 1deg/step] IM C2000: [0 to 200 / 122 / 1deg/step] IM C3000: [0 to 200 / 122 / 1deg/step]
1-105-003	Print Target Temp.	Plain1:BW:Center	ENG*	IM C3500: [100 to 180 / 120 / 1deg/step] IM C2500:

3.SP Mode Tables

SP No.	Large Category	Small Category	ENG or CTL	[Min to Max/Init./Step]
				[100 to 180 / 120 / 1deg/step] IM C2000: [100 to 180 / 123 / 1deg/step] IM C3000: [100 to 180 / 120 / 1deg/step]
1-105-004	Print Target Temp.	Plain1:BW:Press	ENG*	IM C3500: [0 to 200 / 122 / 1deg/step] IM C2500: [0 to 200 / 122 / 1deg/step] IM C2000: [0 to 200 / 122 / 1deg/step] IM C3000: [0 to 200 / 122 / 1deg/step]
1-105-005	Print Target Temp.	Plain2:FC:Center	ENG*	IM C3500: [100 to 180 / 128 / 1deg/step] IM C2500: [100 to 180 / 128 / 1deg/step] IM C2000: [100 to 180 / 131 / 1deg/step] IM C3000: [100 to 180 / 128 / 1deg/step]
1-105-006	Print Target Temp.	Plain2:FC:Press	ENG*	IM C3500: [0 to 200 / 122 / 1deg/step] IM C2500: [0 to 200 / 122 /

3.SP Mode Tables

SP No.	Large Category	Small Category	ENG or CTL	[Min to Max/Init./Step]
				1deg/step] IM C2000: [0 to 200 / 122 / 1deg/step] IM C3000: [0 to 200 / 122 / 1deg/step]
1-105-007	Print Target Temp.	Plain2:BW:Center	ENG*	IM C3500: [100 to 180 / 125 / 1deg/step] IM C2500: [100 to 180 / 125 / 1deg/step] IM C2000: [100 to 180 / 128 / 1deg/step] IM C3000: [100 to 180 / 125 / 1deg/step]
1-105-008	Print Target Temp.	Plain2:BW:Press	ENG*	IM C3500: [0 to 200 / 122 / 1deg/step] IM C2500: [0 to 200 / 122 / 1deg/step] IM C2000: [0 to 200 / 122 / 1deg/step] IM C3000: [0 to 200 / 122 / 1deg/step]
1-105-009	Print Target Temp.	Thin:FC:Center	ENG*	IM C3500: [100 to 180 / 118 / 1deg/step] IM C2500: [100 to 180 / 118 / 1deg/step]

3.SP Mode Tables

SP No.	Large Category	Small Category	ENG or CTL	[Min to Max/Init./Step]
				IM C2000: [100 to 180 / 121 / 1deg/step] IM C3000: [100 to 180 / 118 / 1deg/step]
1-105-010	Print Target Temp.	Thin:FC:Press	ENG*	[0 to 200 / 121 / 1deg/step]
1-105-011	Print Target Temp.	Thin:BW:Center	ENG*	IM C3500: [100 to 180 / 118 / 1deg/step] IM C2500: [100 to 180 / 118 / 1deg/step] IM C2000: [100 to 180 / 121 / 1deg/step] IM C3000: [100 to 180 / 118 / 1deg/step]
1-105-012	Print Target Temp.	Thin:BW:Press	ENG*	[0 to 200 / 121 / 1deg/step]
1-105-013	Print Target Temp.	M-thick:FC:Center	ENG*	IM C3500: [100 to 180 / 136 / 1deg/step] IM C2500: [100 to 180 / 136 / 1deg/step] IM C2000: [100 to 180 / 136 / 1deg/step] IM C3000: [100 to 180 / 136 / 1deg/step]
1-	Print Target Temp.	M-thick:FC:Press	ENG*	IM C3500:

3.SP Mode Tables

SP No.	Large Category	Small Category	ENG or CTL	[Min to Max/Init./Step]
105-014				[0 to 200 / 118 / 1deg/step] IM C2500: [0 to 200 / 118 / 1deg/step] IM C2000: [0 to 200 / 118 / 1deg/step] IM C3000: [0 to 200 / 118 / 1deg/step]
1-105-015	Print Target Temp.	M-thick:BW:Center	ENG*	IM C3500: [100 to 180 / 136 / 1deg/step] IM C2500: [100 to 180 / 136 / 1deg/step] IM C2000: [100 to 180 / 136 / 1deg/step] IM C3000: [100 to 180 / 136 / 1deg/step]
1-105-016	Print Target Temp.	M-thick:BW:Press	ENG*	IM C3500: [0 to 200 / 118 / 1deg/step] IM C2500: [0 to 200 / 118 / 1deg/step] IM C2000: [0 to 200 / 118 / 1deg/step] IM C3000: [0 to 200 / 118 / 1deg/step]
1-105-	Print Target Temp.	Thick1:FC:Center	ENG*	IM C3500: [100 to 180 / 127 /

3.SP Mode Tables

SP No.	Large Category	Small Category	ENG or CTL	[Min to Max/Init./Step]
017				1deg/step] IM C2500: [100 to 180 / 127 / 1deg/step] IM C2000: [100 to 180 / 127 / 1deg/step] IM C3000: [100 to 180 / 127 / 1deg/step]
1-105-018	Print Target Temp.	Thick1:FC:Press	ENG*	[0 to 200 / 120 / 1deg/step]
1-105-019	Print Target Temp.	Thick1:BW:Center	ENG*	IM C3500: [100 to 180 / 127 / 1deg/step] IM C2500: [100 to 180 / 127 / 1deg/step] IM C2000: [100 to 180 / 127 / 1deg/step] IM C3000: [100 to 180 / 127 / 1deg/step]
1-105-020	Print Target Temp.	Thick1:BW:Press	ENG*	[0 to 200 / 120 / 1deg/step]
1-105-021	Print Target Temp.	Thick2:FC:Center	ENG*	IM C3500: [100 to 180 / 132 / 1deg/step] IM C2500: [100 to 180 / 132 / 1deg/step] IM C2000: [100 to 180 / 132 / 1deg/step]

3.SP Mode Tables

SP No.	Large Category	Small Category	ENG or CTL	[Min to Max/Init./Step]
				IM C3000: [100 to 180 / 132 / 1deg/step]
1-105-022	Print Target Temp.	Thick2:FC:Press	ENG*	[0 to 200 / 120 / 1deg/step]
1-105-023	Print Target Temp.	Thick2:BW:Center	ENG*	IM C3500: [100 to 180 / 132 / 1deg/step] IM C2500: [100 to 180 / 132 / 1deg/step] IM C2000: [100 to 180 / 132 / 1deg/step] IM C3000: [100 to 180 / 132 / 1deg/step]
1-105-024	Print Target Temp.	Thick2:BW:Press	ENG*	[0 to 200 / 120 / 1deg/step]
1-105-025	Print Target Temp.	Thick3:FC:Center	ENG*	IM C3500: [100 to 180 / 137 / 1deg/step] IM C2500: [100 to 180 / 137 / 1deg/step] IM C2000: [100 to 180 / 137 / 1deg/step] IM C3000: [100 to 180 / 137 / 1deg/step]
1-105-026	Print Target Temp.	Thick3:FC:Press	ENG*	[0 to 200 / 120 / 1deg/step]
1-	Print Target Temp.	Thick3:BW:Center	ENG*	IM C3500:

3.SP Mode Tables

SP No.	Large Category	Small Category	ENG or CTL	[Min to Max/Init./Step]
105-027				[100 to 180 / 137 / 1deg/step] IM C2500: [100 to 180 / 137 / 1deg/step] IM C2000: [100 to 180 / 137 / 1deg/step] IM C3000: [100 to 180 / 137 / 1deg/step]
1-105-028	Print Target Temp.	Thick3:BW:Press	ENG*	[0 to 200 / 120 / 1deg/step]
1-105-029	Print Target Temp.	Special1:FC:Center	ENG*	IM C3500: [100 to 180 / 123 / 1deg/step] IM C2500: [100 to 180 / 123 / 1deg/step] IM C2000: [100 to 180 / 126 / 1deg/step] IM C3000: [100 to 180 / 123 / 1deg/step]
1-105-030	Print Target Temp.	Special1:FC:Press	ENG*	IM C3500: [0 to 200 / 117 / 1deg/step] IM C2500: [0 to 200 / 117 / 1deg/step] IM C2000: [0 to 200 / 117 / 1deg/step] IM C3000: [0 to 200 / 117 /

3.SP Mode Tables

SP No.	Large Category	Small Category	ENG or CTL	[Min to Max/Init./Step]
				1deg/step]
1-105-031	Print Target Temp.	Special1:BW:Center	ENG*	IM C3500: [100 to 180 / 120 / 1deg/step] IM C2500: [100 to 180 / 120 / 1deg/step] IM C2000: [100 to 180 / 123 / 1deg/step] IM C3000: [100 to 180 / 120 / 1deg/step]
1-105-032	Print Target Temp.	Special1:BW:Press	ENG*	IM C3500: [0 to 200 / 117 / 1deg/step] IM C2500: [0 to 200 / 117 / 1deg/step] IM C2000: [0 to 200 / 117 / 1deg/step] IM C3000: [0 to 200 / 117 / 1deg/step]
1-105-033	Print Target Temp.	Special2:FC:Center	ENG*	IM C3500: [100 to 180 / 128 / 1deg/step] IM C2500: [100 to 180 / 128 / 1deg/step] IM C2000: [100 to 180 / 131 / 1deg/step] IM C3000: [100 to 180 / 128 / 1deg/step]

3.SP Mode Tables

SP No.	Large Category	Small Category	ENG or CTL	[Min to Max/Init./Step]
1-105-034	Print Target Temp.	Special2:FC:Press	ENG*	IM C3500: [0 to 200 / 122 / 1deg/step] IM C2500: [0 to 200 / 122 / 1deg/step] IM C2000: [0 to 200 / 122 / 1deg/step] IM C3000: [0 to 200 / 122 / 1deg/step]
1-105-035	Print Target Temp.	Special2:BW:Center	ENG*	IM C3500: [100 to 180 / 125 / 1deg/step] IM C2500: [100 to 180 / 125 / 1deg/step] IM C2000: [100 to 180 / 128 / 1deg/step] IM C3000: [100 to 180 / 125 / 1deg/step]
1-105-036	Print Target Temp.	Special2:BW:Press	ENG*	IM C3500: [0 to 200 / 122 / 1deg/step] IM C2500: [0 to 200 / 122 / 1deg/step] IM C2000: [0 to 200 / 122 / 1deg/step] IM C3000: [0 to 200 / 122 / 1deg/step]
1-	Print Target Temp.	Special3:FC:Center	ENG*	IM C3500:

3.SP Mode Tables

SP No.	Large Category	Small Category	ENG or CTL	[Min to Max/Init./Step]
105-037				[100 to 180 / 136 / 1deg/step] IM C2500: [100 to 180 / 136 / 1deg/step] IM C2000: [100 to 180 / 136 / 1deg/step] IM C3000: [100 to 180 / 136 / 1deg/step]
1-105-038	Print Target Temp.	Special3:FC:Press	ENG*	IM C3500: [0 to 200 / 118 / 1deg/step] IM C2500: [0 to 200 / 118 / 1deg/step] IM C2000: [0 to 200 / 118 / 1deg/step] IM C3000: [0 to 200 / 118 / 1deg/step]
1-105-039	Print Target Temp.	Special3:BW:Center	ENG*	IM C3500: [100 to 180 / 136 / 1deg/step] IM C2500: [100 to 180 / 136 / 1deg/step] IM C2000: [100 to 180 / 136 / 1deg/step] IM C3000: [100 to 180 / 136 / 1deg/step]
1-105-	Print Target Temp.	Special3:BW:Press	ENG*	IM C3500: [0 to 200 / 118 /

3.SP Mode Tables

SP No.	Large Category	Small Category	ENG or CTL	[Min to Max/Init./Step]
040				1deg/step] IM C2500: [0 to 200 / 118 / 1deg/step] IM C2000: [0 to 200 / 118 / 1deg/step] IM C3000: [0 to 200 / 118 / 1deg/step]
1-105-041	Print Target Temp.	Envelop:Center	ENG*	[100 to 180 / 142 / 1deg/step]
1-105-042	Print Target Temp.	Envelop:Press	ENG*	[0 to 200 / 118 / 1deg/step]
1-105-051	Print Target Temp.	Special1:FC:Center:Middle Speed	ENG*	IM C3500: [100 to 180 / 122 / 1deg/step] IM C2500: [100 to 180 / 122 / 1deg/step] IM C2000: [100 to 180 / 122 / 1deg/step] IM C3000: [100 to 180 / 122 / 1deg/step]
1-105-052	Print Target Temp.	Special1:FC:Press:Middle Speed	ENG*	[0 to 200 / 120 / 1deg/step]
1-105-053	Print Target Temp.	Special1:BW:Center:Middle Speed	ENG*	IM C3500: [100 to 180 / 122 / 1deg/step] IM C2500: [100 to 180 / 122 / 1deg/step]

3.SP Mode Tables

SP No.	Large Category	Small Category	ENG or CTL	[Min to Max/Init./Step]
				IM C2000: [100 to 180 / 122 / 1deg/step] IM C3000: [100 to 180 / 122 / 1deg/step]
1-105-054	Print Target Temp.	Special1:BW:Press:Middle Speed	ENG*	[0 to 200 / 120 / 1deg/step]
1-105-055	Print Target Temp.	Special2:FC:Center:Middle Speed	ENG*	IM C3500: [100 to 180 / 127 / 1deg/step] IM C2500: [100 to 180 / 127 / 1deg/step] IM C2000: [100 to 180 / 127 / 1deg/step] IM C3000: [100 to 180 / 127 / 1deg/step]
1-105-056	Print Target Temp.	Special2:FC:Press:Middle Speed	ENG*	[0 to 200 / 120 / 1deg/step]
1-105-057	Print Target Temp.	Special2:BW:Center:Middle Speed	ENG*	IM C3500: [100 to 180 / 127 / 1deg/step] IM C2500: [100 to 180 / 127 / 1deg/step] IM C2000: [100 to 180 / 127 / 1deg/step] IM C3000: [100 to 180 / 127 / 1deg/step]
1-	Print Target Temp.	Special2:BW:Press:Middle Speed	ENG*	[0 to 200 / 120 /

3.SP Mode Tables

SP No.	Large Category	Small Category	ENG or CTL	[Min to Max/Init./Step]
105-058				1deg/step]
1-105-059	Print Target Temp.	Special3:FC:Center:Middle Speed	ENG*	IM C3500: [100 to 180 / 132 / 1deg/step] IM C2500: [100 to 180 / 132 / 1deg/step] IM C2000: [100 to 180 / 132 / 1deg/step] IM C3000: [100 to 180 / 132 / 1deg/step]
1-105-060	Print Target Temp.	Special3:FC:Press:Middle Speed	ENG*	[0 to 200 / 120 / 1deg/step]
1-105-061	Print Target Temp.	Special3:BW:Center:Middle Speed	ENG*	IM C3500: [100 to 180 / 132 / 1deg/step] IM C2500: [100 to 180 / 132 / 1deg/step] IM C2000: [100 to 180 / 132 / 1deg/step] IM C3000: [100 to 180 / 132 / 1deg/step]
1-105-062	Print Target Temp.	Special3:BW:Press:Middle Speed	ENG*	[0 to 200 / 120 / 1deg/step]
1-105-101	Print Target Temp.	Plain1:FC:Center:Low Speed	ENG*	IM C3500: [100 to 180 / 115 / 1deg/step] IM C2500: [100 to 180 / 115 /

3.SP Mode Tables

SP No.	Large Category	Small Category	ENG or CTL	[Min to Max/Init./Step]
				1deg/step] IM C2000: [100 to 180 / 115 / 1deg/step] IM C3000: [100 to 180 / 115 / 1deg/step]
1-105-102	Print Target Temp.	Plain1:FC:Press:Low Speed	ENG*	[0 to 200 / 118 / 1deg/step]
1-105-103	Print Target Temp.	Plain1:BW:Center:Low Speed	ENG*	IM C3500: [100 to 180 / 115 / 1deg/step] IM C2500: [100 to 180 / 115 / 1deg/step] IM C2000: [100 to 180 / 115 / 1deg/step] IM C3000: [100 to 180 / 115 / 1deg/step]
1-105-104	Print Target Temp.	Plain1:BW:Press:Low Speed	ENG*	[0 to 200 / 118 / 1deg/step]
1-105-105	Print Target Temp.	Plain2:FC:Center:Low Speed	ENG*	IM C3500: [100 to 180 / 120 / 1deg/step] IM C2500: [100 to 180 / 120 / 1deg/step] IM C2000: [100 to 180 / 120 / 1deg/step] IM C3000: [100 to 180 / 120 / 1deg/step]

3.SP Mode Tables

SP No.	Large Category	Small Category	ENG or CTL	[Min to Max/Init./Step]
1-105-106	Print Target Temp.	Plain2:FC:Press:Low Speed	ENG*	[0 to 200 / 118 / 1deg/step]
1-105-107	Print Target Temp.	Plain2:BW:Center:Low Speed	ENG*	IM C3500: [100 to 180 / 120 / 1deg/step] IM C2500: [100 to 180 / 120 / 1deg/step] IM C2000: [100 to 180 / 120 / 1deg/step] IM C3000: [100 to 180 / 120 / 1deg/step]
1-105-108	Print Target Temp.	Plain2:BW:Press:Low Speed	ENG*	[0 to 200 / 118 / 1deg/step]
1-105-109	Print Target Temp.	M-thick:FC:Center:Low Speed	ENG*	IM C3500: [100 to 180 / 122 / 1deg/step] IM C2500: [100 to 180 / 122 / 1deg/step] IM C2000: [100 to 180 / 122 / 1deg/step] IM C3000: [100 to 180 / 122 / 1deg/step]
1-105-110	Print Target Temp.	M-thick:FC:Press:Low Speed	ENG*	[0 to 200 / 118 / 1deg/step]
1-105-111	Print Target Temp.	M-thick:BW:Center:Low Speed	ENG*	IM C3500: [100 to 180 / 122 / 1deg/step] IM C2500:

3.SP Mode Tables

SP No.	Large Category	Small Category	ENG or CTL	[Min to Max/Init./Step]
				[100 to 180 / 122 / 1deg/step] IM C2000: [100 to 180 / 122 / 1deg/step] IM C3000: [100 to 180 / 122 / 1deg/step]
1-105-112	Print Target Temp.	M-thick:BW:Press:Low Speed	ENG*	[0 to 200 / 118 / 1deg/step]
1-105-113	Print Target Temp.	Thick1:FC:Center:Low Speed	ENG*	IM C3500: [100 to 180 / 127 / 1deg/step] IM C2500: [100 to 180 / 127 / 1deg/step] IM C2000: [100 to 180 / 127 / 1deg/step] IM C3000: [100 to 180 / 127 / 1deg/step]
1-105-114	Print Target Temp.	Thick1:FC:Press:Low Speed	ENG*	[0 to 200 / 118 / 1deg/step]
1-105-115	Print Target Temp.	Thick1:BW:Center:Low Speed	ENG*	IM C3500: [100 to 180 / 127 / 1deg/step] IM C2500: [100 to 180 / 127 / 1deg/step] IM C2000: [100 to 180 / 127 / 1deg/step] IM C3000: [100 to 180 / 127 /

3.SP Mode Tables

SP No.	Large Category	Small Category	ENG or CTL	[Min to Max/Init./Step]
				1deg/step]
1-105-116	Print Target Temp.	Thick1:BW:Press:Low Speed	ENG*	[0 to 200 / 118 / 1deg/step]
1-105-117	Print Target Temp.	Special1:FC:Center:Low Speed	ENG*	IM C3500: [100 to 180 / 122 / 1deg/step] IM C2500: [100 to 180 / 122 / 1deg/step] IM C2000: [100 to 180 / 122 / 1deg/step] IM C3000: [100 to 180 / 122 / 1deg/step]
1-105-118	Print Target Temp.	Special1:FC:Press:Low Speed	ENG*	[0 to 200 / 118 / 1deg/step]
1-105-119	Print Target Temp.	Special1:BW:Center:Low Speed	ENG*	IM C3500: [100 to 180 / 122 / 1deg/step] IM C2500: [100 to 180 / 122 / 1deg/step] IM C2000: [100 to 180 / 122 / 1deg/step] IM C3000: [100 to 180 / 122 / 1deg/step]
1-105-120	Print Target Temp.	Special1:BW:Press:Low Speed	ENG*	[0 to 200 / 118 / 1deg/step]
1-105-121	Print Target Temp.	Special2:FC:Center:Low Speed	ENG*	IM C3500: [100 to 180 / 132 / 1deg/step]

3.SP Mode Tables

SP No.	Large Category	Small Category	ENG or CTL	[Min to Max/Init./Step]
				IM C2500: [100 to 180 / 132 / 1deg/step] IM C2000: [100 to 180 / 132 / 1deg/step] IM C3000: [100 to 180 / 132 / 1deg/step]
1-105-122	Print Target Temp.	Special2:FC:Press:Low Speed	ENG*	[0 to 200 / 120 / 1deg/step]
1-105-123	Print Target Temp.	Special2:BW:Center:Low Speed	ENG*	IM C3500: [100 to 180 / 132 / 1deg/step] IM C2500: [100 to 180 / 132 / 1deg/step] IM C2000: [100 to 180 / 132 / 1deg/step] IM C3000: [100 to 180 / 132 / 1deg/step]
1-105-124	Print Target Temp.	Special2:BW:Press:Low Speed	ENG*	[0 to 200 / 120 / 1deg/step]
1-105-125	Print Target Temp.	Plain1:Glossy:Center	ENG*	[100 to 180 / 132 / 1deg/step]
1-105-126	Print Target Temp.	Plain1:Glossy:Press	ENG*	[0 to 200 / 118 / 1deg/step]
1-105-127	Print Target Temp.	Plain2:Glossy:Center	ENG*	[100 to 180 / 137 / 1deg/step]
1-	Print Target Temp.	Plain2:Glossy:Press	ENG*	[0 to 200 / 118 /

3.SP Mode Tables

SP No.	Large Category	Small Category	ENG or CTL	[Min to Max/Init./Step]
105-128				1deg/step]
1-105-129	Print Target Temp.	M-thick:Glossy:Center	ENG*	[100 to 180 / 142 / 1deg/step]
1-105-130	Print Target Temp.	M-thick:Glossy:Press	ENG*	[0 to 200 / 118 / 1deg/step]
1-105-131	Print Target Temp.	OHP:Center	ENG*	IM C3500: [100 to 180 / 160 / 1deg/step] IM C2500: [100 to 180 / 160 / 1deg/step] IM C2000: [100 to 180 / 160 / 1deg/step] IM C3000: [100 to 180 / 160 / 1deg/step]
1-105-132	Print Target Temp.	OHP:Press	ENG*	[0 to 200 / 118 / 1deg/step]
1-105-133	Print Target Temp.	Envelop:Center:Low Speed	ENG*	[100 to 180 / 135 / 1deg/step]
1-105-134	Print Target Temp.	Envelop:Press:Low Speed	ENG*	[0 to 200 / 118 / 1deg/step]
1-105-135	Print Target Temp.	Thin:FC:Center:Low Speed	ENG*	[100 to 180 / 110 / 1deg/step]
1-105-136	Print Target Temp.	Thin:FC:Press:Low Speed	ENG*	[0 to 200 / 118 / 1deg/step]
1-105-	Print Target Temp.	Thin:BW:Center:Low Speed	ENG*	[100 to 180 / 110 / 1deg/step]

3.SP Mode Tables

SP No.	Large Category	Small Category	ENG or CTL	[Min to Max/Init./Step]
137				
1-105-138	Print Target Temp.	Thin:BW:Press:Low Speed	ENG*	[0 to 200 / 118 / 1deg/step]
1-105-139	Print Target Temp.	Thick4:FC:Center	ENG*	[100 to 180 / 142 / 1deg/step]
1-105-140	Print Target Temp.	Thick4:FC:Press	ENG*	[0 to 200 / 118 / 1deg/step]
1-105-141	Print Target Temp.	Thick4:BW:Center	ENG*	[100 to 180 / 142 / 1deg/step]
1-105-142	Print Target Temp.	Thick4:BW:Press	ENG*	[0 to 200 / 118 / 1deg/step]
1-105-143	Print Target Temp.	Postcard:Center	ENG*	[100 to 180 / 124 / 1deg/step]
1-105-144	Print Target Temp.	Postcard:Press	ENG*	IM C3500: [0 to 200 / 118 / 1deg/step] IM C2500: [0 to 200 / 118 / 1deg/step] IM C2000: [0 to 200 / 118 / 1deg/step] IM C3000: [0 to 200 / 118 / 1deg/step]
1-105-145	Print Target Temp.	Special3:FC:Center:Middle Speed	ENG*	IM C3500: [100 to 180 / 142 / 1deg/step] IM C2500: [100 to 180 / 142 / 1deg/step]

3.SP Mode Tables

SP No.	Large Category	Small Category	ENG or CTL	[Min to Max/Init./Step]
				IM C2000: [100 to 180 / 142 / 1deg/step] IM C3000: [100 to 180 / 142 / 1deg/step]
1-105-146	Print Target Temp.	Special3:FC:Press:Middle Speed	ENG*	[0 to 200 / 118 / 1deg/step]
1-105-147	Print Target Temp.	Special3:BW:Center:Middle Speed	ENG*	IM C3500: [100 to 180 / 142 / 1deg/step] IM C2500: [100 to 180 / 142 / 1deg/step] IM C2000: [100 to 180 / 142 / 1deg/step] IM C3000: [100 to 180 / 142 / 1deg/step]
1-105-148	Print Target Temp.	Special3:BW:Press:Middle Speed	ENG*	[0 to 200 / 118 / 1deg/step]
1-105-149	Print Target Temp.	Mid Thick:Matte:Center	ENG*	IM C3500: [100 to 180 / 136 / 1deg/step] IM C2500: [100 to 180 / 136 / 1deg/step] IM C2000: [100 to 180 / 136 / 1deg/step] IM C3000: [100 to 180 / 136 / 1deg/step]
1-	Print Target Temp.	Mid Thick:Matte:Press	ENG*	IM C3500:

3.SP Mode Tables

SP No.	Large Category	Small Category	ENG or CTL	[Min to Max/Init./Step]
105-150				[0 to 200 / 118 / 1deg/step] IM C2500: [0 to 200 / 118 / 1deg/step] IM C2000: [0 to 200 / 118 / 1deg/step] IM C3000: [0 to 200 / 118 / 1deg/step]
1-105-151	Print Target Temp.	Thick1:Matte:Center	ENG*	IM C3500: [100 to 180 / 127 / 1deg/step] IM C2500: [100 to 180 / 127 / 1deg/step] IM C2000: [100 to 180 / 127 / 1deg/step] IM C3000: [100 to 180 / 127 / 1deg/step]
1-105-152	Print Target Temp.	Thick1:Matte:Press	ENG*	[0 to 200 / 120 / 1deg/step]
1-105-153	Print Target Temp.	Thick2:Matte:Center	ENG*	IM C3500: [100 to 180 / 132 / 1deg/step] IM C2500: [100 to 180 / 132 / 1deg/step] IM C2000: [100 to 180 / 132 / 1deg/step] IM C3000: [100 to 180 / 132 /

3.SP Mode Tables

SP No.	Large Category	Small Category	ENG or CTL	[Min to Max/Init./Step]
				1deg/step]
1-105-154	Print Target Temp.	Thick2:Matte:Press	ENG*	[0 to 200 / 120 / 1deg/step]
1-105-155	Print Target Temp.	Thick3:Matte:Center	ENG*	IM C3500: [100 to 180 / 137 / 1deg/step] IM C2500: [100 to 180 / 137 / 1deg/step] IM C2000: [100 to 180 / 137 / 1deg/step] IM C3000: [100 to 180 / 137 / 1deg/step]
1-105-156	Print Target Temp.	Thick3:Matte:Press	ENG*	[0 to 200 / 120 / 1deg/step]
1-105-157	Print Target Temp.	Thick4:Matte:Center	ENG*	[100 to 180 / 142 / 1deg/step]
1-105-158	Print Target Temp.	Thick4:Matte:Press	ENG*	[0 to 200 / 118 / 1deg/step]
1-105-159	Print Target Temp.	Mid Thick:Matte:Center:Low Speed	ENG*	IM C3500: [100 to 180 / 122 / 1deg/step] IM C2500: [100 to 180 / 122 / 1deg/step] IM C2000: [100 to 180 / 122 / 1deg/step] IM C3000: [100 to 180 / 122 / 1deg/step]

3.SP Mode Tables

SP No.	Large Category	Small Category	ENG or CTL	[Min to Max/Init./Step]
1-105-160	Print Target Temp.	Mid Thick:Matte:Press:Low Speed	ENG*	[0 to 200 / 118 / 1deg/step]
1-105-161	Print Target Temp.	Thick1:Matte:Center:Low Speed	ENG*	IM C3500: [100 to 180 / 127 / 1deg/step] IM C2500: [100 to 180 / 127 / 1deg/step] IM C2000: [100 to 180 / 127 / 1deg/step] IM C3000: [100 to 180 / 127 / 1deg/step]
1-105-162	Print Target Temp.	Thick1:Matte:Press:Low Speed	ENG*	[0 to 200 / 118 / 1deg/step]
1-105-163	Print Target Temp.	Mid Thick:Glossy:Center	ENG*	IM C3500: [100 to 180 / 136 / 1deg/step] IM C2500: [100 to 180 / 136 / 1deg/step] IM C2000: [100 to 180 / 136 / 1deg/step] IM C3000: [100 to 180 / 136 / 1deg/step]
1-105-164	Print Target Temp.	Mid Thick:Glossy:Press	ENG*	IM C3500: [0 to 200 / 118 / 1deg/step] IM C2500: [0 to 200 / 118 / 1deg/step] IM C2000:

3.SP Mode Tables

SP No.	Large Category	Small Category	ENG or CTL	[Min to Max/Init./Step]
				[0 to 200 / 118 / 1deg/step] IM C3000: [0 to 200 / 118 / 1deg/step]
1- 105- 165	Print Target Temp.	Thick1:Glossy:Center	ENG*	IM C3500: [100 to 180 / 127 / 1deg/step] IM C2500: [100 to 180 / 127 / 1deg/step] IM C2000: [100 to 180 / 127 / 1deg/step] IM C3000: [100 to 180 / 127 / 1deg/step]
1- 105- 166	Print Target Temp.	Thick1:Glossy:Press	ENG*	[0 to 200 / 120 / 1deg/step]
1- 105- 167	Print Target Temp.	Thick2:Glossy:Center	ENG*	IM C3500: [100 to 180 / 132 / 1deg/step] IM C2500: [100 to 180 / 132 / 1deg/step] IM C2000: [100 to 180 / 132 / 1deg/step] IM C3000: [100 to 180 / 132 / 1deg/step]
1- 105- 168	Print Target Temp.	Thick2:Glossy:Press	ENG*	[0 to 200 / 120 / 1deg/step]
1- 105-	Print Target Temp.	Thick3:Glossy:Center	ENG*	IM C3500: [100 to 180 / 137 /

3.SP Mode Tables

SP No.	Large Category	Small Category	ENG or CTL	[Min to Max/Init./Step]
169				1deg/step] IM C2500: [100 to 180 / 137 / 1deg/step] IM C2000: [100 to 180 / 137 / 1deg/step] IM C3000: [100 to 180 / 137 / 1deg/step]
1-105-170	Print Target Temp.	Thick3:Glossy:Press	ENG*	[0 to 200 / 120 / 1deg/step]
1-105-171	Print Target Temp.	Thick4:Glossy:Center	ENG*	[100 to 180 / 142 / 1deg/step]
1-105-172	Print Target Temp.	Thick4:Glossy:Press	ENG*	[0 to 200 / 118 / 1deg/step]
1-105-173	Print Target Temp.	Mid Thick:Glossy:Center:Low Speed	ENG*	IM C3500: [100 to 180 / 122 / 1deg/step] IM C2500: [100 to 180 / 122 / 1deg/step] IM C2000: [100 to 180 / 122 / 1deg/step] IM C3000: [100 to 180 / 122 / 1deg/step]
1-105-174	Print Target Temp.	Mid Thick:Glossy:Press:Low Speed	ENG*	[0 to 200 / 118 / 1deg/step]
1-105-175	Print Target Temp.	Thick1:Glossy:Center:Low Speed	ENG*	IM C3500: [100 to 180 / 127 / 1deg/step]

3.SP Mode Tables

SP No.	Large Category	Small Category	ENG or CTL	[Min to Max/Init./Step]
				IM C2500: [100 to 180 / 127 / 1deg/step] IM C2000: [100 to 180 / 127 / 1deg/step] IM C3000: [100 to 180 / 127 / 1deg/step]
1-105-176	Print Target Temp.	Thick1:Glossy:Press:Low Speed	ENG*	[0 to 200 / 118 / 1deg/step]
1-106-001	Fusing Temp. Display	Heat Center	ENG	[-10 to 250 / 0 / 1deg/step]
1-106-002	Fusing Temp. Display	Heat End	ENG	[-10 to 250 / 0 / 1deg/step]
1-106-003	Fusing Temp. Display	Press Center	ENG	[-10 to 250 / 0 / 1deg/step]
1-106-004	Fusing Temp. Display	Press End	ENG	[-10 to 250 / 0 / 1deg/step]
1-106-005	Fusing Temp. Display	Press End	ENG	[-10 to 250 / 0 / 1deg/step]
1-107-001	Standby Target Temp. Setting	Stanby/Preheat1:Center	ENG*	[0 to 125 / 90 / 1deg/step]
1-107-003	Standby Target Temp. Setting	Preheat2:Center	ENG*	[0 to 200 / 90 / 1deg/step]
1-107-005	Standby Target Temp. Setting	Low Power:Center	ENG*	[0 to 125 / 60 / 1deg/step]
1-	Standby Target	Print Ready:Center	ENG*	IM C3500:

3.SP Mode Tables

SP No.	Large Category	Small Category	ENG or CTL	[Min to Max/Init./Step]
107-007	Temp. Setting			[85 to 180 / 128 / 1deg/step] IM C2500: [85 to 180 / 128 / 1deg/step] IM C2000: [85 to 180 / 131 / 1deg/step] IM C3000: [85 to 180 / 128 / 1deg/step]
1-107-008	Standby Target Temp. Setting	Print Ready:Press	ENG*	[0 to 200 / 120 / 1deg/step]
1-107-011	Standby Target Temp. Setting	Standby Heater Off Time	ENG*	[0 to 100 / 0 / 1sec/step]
1-108-001	After Reload/Job Target Temp.	Center	ENG*	IM C3500: [85 to 200 / 128 / 1deg/step] IM C2500: [85 to 200 / 128 / 1deg/step] IM C2000: [85 to 200 / 131 / 1deg/step] IM C3000: [85 to 200 / 128 / 1deg/step]
1-108-002	After Reload/Job Target Temp.	Press	ENG*	[0 to 200 / 120 / 1deg/step]
1-108-011	After Reload/Job Target Temp.	Center:Energy Saving	ENG*	IM C3500: TWN: [85 to 200 / 118 / 1deg/step] NA: [85 to 200 / 118 / 1deg/step]

3.SP Mode Tables

SP No.	Large Category	Small Category	ENG or CTL	[Min to Max/Init./Step]
				KOR: [85 to 200 / 116 / 1deg/step] EU: [85 to 200 / 116 / 1deg/step] CHN: [85 to 200 / 116 / 1deg/step] AS: [85 to 200 / 116 / 1deg/step] IM C2500: TWN: [85 to 200 / 116 / 1deg/step] NA: [85 to 200 / 116 / 1deg/step] KOR: [85 to 200 / 114 / 1deg/step] EU: [85 to 200 / 114 / 1deg/step] CHN: [85 to 200 / 114 / 1deg/step] AS: [85 to 200 / 114 / 1deg/step] IM C2000: TWN: [85 to 200 / 116 / 1deg/step] NA: [85 to 200 / 116 / 1deg/step] KOR: [85 to 200 / 114 / 1deg/step] EU: [85 to 200 / 114 / 1deg/step] CHN: [85 to 200 / 114 / 1deg/step] AS: [85 to 200 / 114 / 1deg/step] IM C3000: TWN: [85 to 200 / 118 / 1deg/step]

3.SP Mode Tables

SP No.	Large Category	Small Category	ENG or CTL	[Min to Max/Init./Step]
				NA: [85 to 200 / 118 / 1deg/step] KOR: [85 to 200 / 116 / 1deg/step] EU: [85 to 200 / 116 / 1deg/step] CHN: [85 to 200 / 116 / 1deg/step] AS: [85 to 200 / 116 / 1deg/step]
1-108-012	After Reload/Job Target Temp.	Press:Energy Saving	ENG*	[0 to 200 / 120 / 1deg/step]
1-111-001	Environment Correction:Fusing	Temp.: Threshold: Low	ENG*	[0 to 100 / 15 / 1deg/step]
1-111-002	Environment Correction:Fusing	Temp.: Threshold: High	ENG*	[0 to 100 / 30 / 1deg/step]
1-111-003	Environment Correction:Fusing	Low Temp. Correction	ENG*	IM C3500: [0 to 15 / 3 / 1deg/step] IM C2500: [0 to 15 / 6 / 1deg/step] IM C2000: [0 to 15 / 6 / 1deg/step] IM C3000: [0 to 15 / 3 / 1deg/step]
1-111-004	Environment Correction:Fusing	High Temp. Correction	ENG*	[0 to 15 / 0 / 1deg/step]
1-111-005	Environment Correction:Fusing	Job Low Temp. Correction	ENG*	IM C3500: [0.0 to 100.0 / 3.0 / 0.1deg/step]

3.SP Mode Tables

SP No.	Large Category	Small Category	ENG or CTL	[Min to Max/Init./Step]
				IM C2500: [0.0 to 100.0 / 6.0 / 0.1deg/step] IM C2000: [0.0 to 100.0 / 6.0 / 0.1deg/step] IM C3000: [0.0 to 100.0 / 3.0 / 0.1deg/step]
1-111-006	Environment Correction:Fusing	Job High Temp. Correction	ENG*	[0.0 to 100.0 / 0.0 / 0.1deg/step]
1-111-007	Environment Correction:Fusing	Job Low Temp. Correction:Sp.	ENG*	IM C3500: [0.0 to 100.0 / 3.0 / 0.1deg/step] IM C2500: [0.0 to 100.0 / 7.0 / 0.1deg/step] IM C2000: [0.0 to 100.0 / 7.0 / 0.1deg/step] IM C3000: [0.0 to 100.0 / 3.0 / 0.1deg/step]
1-111-008	Environment Correction:Fusing	Job High Temp. Correction:Sp.	ENG*	[0.0 to 100.0 / 0.0 / 0.1deg/step]
1-111-011	Environment Correction:Fusing	Standard Environment Temp.	ENG*	[10 to 30 / 23 / 1deg/step]
1-112-001	Image Processing Temp. Correct	Temp.:Plain:Center:Level1/2	ENG*	IM C3500: [-20 to 20 / 0 / 1deg/step] IM C2500: [-20 to 20 / 0 / 1deg/step] IM C2000:

3.SP Mode Tables

SP No.	Large Category	Small Category	ENG or CTL	[Min to Max/Init./Step]
				[-20 to 20 / 0 / 1deg/step] IM C3000: [-20 to 20 / 0 / 1deg/step]
1-112-002	Image Processing Temp. Correct	Temp.:Plain:Center:Energy Saving	ENG*	IM C3500: TWN: [-30 to 20 / -7 / 1deg/step] NA: [-30 to 20 / -7 / 1deg/step] KOR: [-30 to 20 / -9 / 1deg/step] EU: [-30 to 20 / -9 / 1deg/step] CHN: [-30 to 20 / -9 / 1deg/step] AS: [-30 to 20 / -9 / 1deg/step] IM C2500: TWN: [-30 to 20 / -9 / 1deg/step] NA: [-30 to 20 / -9 / 1deg/step] KOR: [-30 to 20 / -11 / 1deg/step] EU: [-30 to 20 / -11 / 1deg/step] CHN: [-30 to 20 / -11 / 1deg/step] AS: [-30 to 20 / -11 / 1deg/step] IM C2000: TWN: [-30 to 20 / -12 / 1deg/step] NA: [-30 to 20 / -12 / 1deg/step] KOR: [-30 to 20 / -

3.SP Mode Tables

SP No.	Large Category	Small Category	ENG or CTL	[Min to Max/Init./Step]
				14 / 1deg/step] EU: [-30 to 20 / -14 / 1deg/step] CHN: [-30 to 20 / -14 / 1deg/step] AS: [-30 to 20 / -14 / 1deg/step] IM C3000: TWN: [-30 to 20 / -7 / 1deg/step] NA: [-30 to 20 / -7 / 1deg/step] KOR: [-30 to 20 / -9 / 1deg/step] EU: [-30 to 20 / -9 / 1deg/step] CHN: [-30 to 20 / -9 / 1deg/step] AS: [-30 to 20 / -9 / 1deg/step]
1-113-001	Curl Correction	Execute Pattern	ENG*	[0 to 2 / 0 / 1/step]
1-113-002	Curl Correction	Humidity:Threshold:M-humid	ENG*	[0 to 100 / 1 / 1%/step]
1-113-003	Curl Correction	Humidity:Threshold:H-humid	ENG*	[0 to 100 / 65 / 1%/step]
1-113-004	Curl Correction	Permit Temp.:Delta:Press:M-humid	ENG*	IM C3500: [0 to 200 / 60 / 1deg/step] IM C2500: [0 to 200 / 60 / 1deg/step] IM C2000: [0 to 200 / 60 /

3.SP Mode Tables

SP No.	Large Category	Small Category	ENG or CTL	[Min to Max/Init./Step]
				1deg/step] IM C3000: [0 to 200 / 60 / 1deg/step]
1-113-005	Curl Correction	Permit Temp.:Delta:Press:H-humid	ENG*	IM C3500: [0 to 200 / 50 / 1deg/step] IM C2500: [0 to 200 / 50 / 1deg/step] IM C2000: [0 to 200 / 50 / 1deg/step] IM C3000: [0 to 200 / 50 / 1deg/step]
1-113-006	Curl Correction	Permit Temp.:Delta:Press:M-humid:No Decurl	ENG*	IM C3500: [0 to 200 / 50 / 1deg/step] IM C2500: [0 to 200 / 50 / 1deg/step] IM C2000: [0 to 200 / 50 / 1deg/step] IM C3000: [0 to 200 / 50 / 1deg/step]
1-113-007	Curl Correction	Permit Temp.:Delta:Press:H-humid:No Decurl	ENG*	IM C3500: [0 to 200 / 40 / 1deg/step] IM C2500: [0 to 200 / 40 / 1deg/step] IM C2000: [0 to 200 / 40 / 1deg/step]

3.SP Mode Tables

SP No.	Large Category	Small Category	ENG or CTL	[Min to Max/Init./Step]
				IM C3000: [0 to 200 / 40 / 1deg/step]
1-113-008	Curl Correction	CPM:M-humid	ENG*	[0 to 100 / 80 / 1%/step]
1-113-009	Curl Correction	CPM:H-humid	ENG*	[0 to 100 / 65 / 1%/step]
1-113-010	Curl Correction	CPM:M-humid:No Decurl	ENG*	[0 to 100 / 80 / 1%/step]
1-113-011	Curl Correction	CPM:H-humid:No Decurl	ENG*	[0 to 100 / 65 / 1%/step]
1-115-001	Target Temp. Correction	Temp.:Delta:End	ENG*	[-100 to 100 / 0 / 1deg/step]
1-120-001			ENG*	[0 to 255 / 0 / 1/step]
1-120-002			ENG*	[0 to 255 / 0 / 1deg/step]
1-120-003			ENG*	[0 to 255 / 0 / 1deg/step]
1-120-004			ENG*	[0 to 255 / 0 / 1deg/step]
1-120-005			ENG*	[0 to 255 / 0 / 1deg/step]
1-120-006			ENG*	[0 to 255 / 0 / 1deg/step]

3.SP Mode Tables

SP No.	Large Category	Small Category	ENG or CTL	[Min to Max/Init./Step]
1-120-007			ENG*	[0 to 255 / 0 / 1deg/step]
1-120-008			ENG*	[0 to 255 / 0 / 1deg/step]
1-120-009			ENG*	[0 to 255 / 0 / 1deg/step]
1-120-010			ENG*	[0 to 255 / 0 / 1deg/step]
1-120-011			ENG*	[0 to 60000 / 0 / 1msec/step]
1-120-012			ENG*	[0 to 60000 / 0 / 1msec/step]
1-120-013			ENG*	[0 to 60000 / 0 / 1msec/step]
1-120-014			ENG*	[0 to 60000 / 0 / 1msec/step]
1-120-015			ENG*	[0 to 60000 / 0 / 1msec/step]
1-120-016			ENG*	[0 to 60000 / 0 / 1msec/step]
1-120-017			ENG*	[0 to 60000 / 0 / 1msec/step]
1-120-018			ENG*	[0 to 60000 / 0 / 1msec/step]

3.SP Mode Tables

SP No.	Large Category	Small Category	ENG or CTL	[Min to Max/Init./Step]
1-120-019			ENG*	[0 to 60000 / 0 / 1msec/step]
1-120-020			ENG*	[0 to 60000 / 0 / 1msec/step]
1-120-021			ENG*	[-120 to 120 / 0 / 1deg/step]
1-120-022			ENG*	[-120 to 120 / 0 / 1deg/step]
1-120-023			ENG*	[-120 to 120 / 0 / 1deg/step]
1-120-024			ENG*	[-120 to 120 / 0 / 1deg/step]
1-120-025			ENG*	[-120 to 120 / 0 / 1deg/step]
1-120-026			ENG*	[-120 to 120 / 0 / 1deg/step]
1-120-027			ENG*	[-120 to 120 / 0 / 1deg/step]
1-120-028			ENG*	[-120 to 120 / 0 / 1deg/step]
1-120-029			ENG*	[-120 to 120 / 0 / 1deg/step]
1-120-030			ENG*	[-120 to 120 / 0 / 1deg/step]

3.SP Mode Tables

SP No.	Large Category	Small Category	ENG or CTL	[Min to Max/Init./Step]
1-122-001	Standby Rotation Setting	Rotation Interval	ENG*	[0 to 240 / 60 / 1min/step]
1-122-002	Standby Rotation Setting	Rotation Time	ENG*	IM C3500: [0.0 to 60.0 / 0.8 / 0.1sec/step] IM C2500: [0.0 to 60.0 / 0.8 / 0.1sec/step] IM C2000: [0.0 to 60.0 / 0.8 / 0.1sec/step] IM C3000: [0.0 to 60.0 / 0.8 / 0.1sec/step]
1-131-001	Continuous Print Mode Switch	Feed Permit Condition	ENG*	[0 to 2 / 1 / 1/step]
1-133-001	Voltage Detection	Voltage Detection	ENG*	IM C3500: TWN: [0.0 to 350.0 / 107.0 / 0.1V/step] NA: [0.0 to 350.0 / 116.0 / 0.1V/step] KOR: [0.0 to 350.0 / 223.0 / 0.1V/step] EU: [0.0 to 350.0 / 223.0 / 0.1V/step] CHN: [0.0 to 350.0 / 223.0 / 0.1V/step] AS: [0.0 to 350.0 / 223.0 / 0.1V/step] IM C2500: TWN: [0.0 to 350.0 / 107.0 /

3.SP Mode Tables

SP No.	Large Category	Small Category	ENG or CTL	[Min to Max/Init./Step]
				0.1V/step] NA: [0.0 to 350.0 / 116.0 / 0.1V/step] KOR: [0.0 to 350.0 / 223.0 / 0.1V/step] EU: [0.0 to 350.0 / 223.0 / 0.1V/step] CHN: [0.0 to 350.0 / 223.0 / 0.1V/step] AS: [0.0 to 350.0 / 223.0 / 0.1V/step] IM C2000: TWN: [0.0 to 350.0 / 107.0 / 0.1V/step] NA: [0.0 to 350.0 / 116.0 / 0.1V/step] KOR: [0.0 to 350.0 / 223.0 / 0.1V/step] EU: [0.0 to 350.0 / 223.0 / 0.1V/step] CHN: [0.0 to 350.0 / 223.0 / 0.1V/step] AS: [0.0 to 350.0 / 223.0 / 0.1V/step] IM C3000: TWN: [0.0 to 350.0 / 107.0 / 0.1V/step] NA: [0.0 to 350.0 / 116.0 / 0.1V/step] KOR: [0.0 to 350.0 / 223.0 /

3.SP Mode Tables

SP No.	Large Category	Small Category	ENG or CTL	[Min to Max/Init./Step]
				0.1V/step] EU: [0.0 to 350.0 / 223.0 / 0.1V/step] CHN: [0.0 to 350.0 / 223.0 / 0.1V/step] AS: [0.0 to 350.0 / 223.0 / 0.1V/step]
1-133-002	Voltage Detection	Max	ENG*	[0.0 to 350.0 / 0.0 / 0.1V/step]
1-133-003	Voltage Detection	Min	ENG*	[0.0 to 350.0 / 350.0 / 0.1V/step]
1-133-004	Voltage Detection	Last	ENG*	[0.0 to 350.0 / 0.0 / 0.1V/step]
1-133-005	Voltage Detection	SC	ENG*	[0.0 to 350.0 / 0.0 / 0.1V/step]
1-133-006	Voltage Detection	Threshold Voltage	ENG*	IM C3500: TWN: [0 to 255 / 88 / 1V/step] NA: [0 to 255 / 96 / 1V/step] KOR: [0 to 255 / 178 / 1V/step] EU: [0 to 255 / 178 / 1V/step] CHN: [0 to 255 / 178 / 1V/step] AS: [0 to 255 / 178 / 1V/step] IM C2500: TWN: [0 to 255 / 88 / 1V/step] NA: [0 to 255 / 96 /

3.SP Mode Tables

SP No.	Large Category	Small Category	ENG or CTL	[Min to Max/Init./Step]
				1V/step] KOR: [0 to 255 / 178 / 1V/step] EU: [0 to 255 / 178 / 1V/step] CHN: [0 to 255 / 178 / 1V/step] AS: [0 to 255 / 178 / 1V/step] IM C2000: TWN: [0 to 255 / 88 / 1V/step] NA: [0 to 255 / 96 / 1V/step] KOR: [0 to 255 / 178 / 1V/step] EU: [0 to 255 / 178 / 1V/step] CHN: [0 to 255 / 178 / 1V/step] AS: [0 to 255 / 178 / 1V/step] IM C3000: TWN: [0 to 255 / 88 / 1V/step] NA: [0 to 255 / 96 / 1V/step] KOR: [0 to 255 / 178 / 1V/step] EU: [0 to 255 / 178 / 1V/step] CHN: [0 to 255 / 178 / 1V/step] AS: [0 to 255 / 178 / 1V/step]
1-135-	Inrush Control	Inrush Control	ENG*	[0 to 1 / 0 / 1/step]

3.SP Mode Tables

SP No.	Large Category	Small Category	ENG or CTL	[Min to Max/Init./Step]
001				
1-135-002	Flicker Control	Flicker Control	ENG*	[0 to 1 / 0 / 1/step]
1-136-001	Recovery mode	Recovery mode SW:Low Temp	ENG*	[0 to 1 / 0 / 1deg/step]
1-136-002	Recovery mode	Recovery mode SW:Voltage:Low	ENG*	[0 to 1 / 0 / 1deg/step]
1-141-001	Fusing SC Error Time Info	SC Number	ENG*	[0 to 99999 / 0 / 1/step]
1-141-101	Fusing SC Error Time Info	Htg Roller:Ctr Det1	ENG*	[-100 to 300 / 0 / 1deg/step]
1-141-102	Fusing SC Error Time Info	Htg Roller:End Det1	ENG*	[-100 to 300 / 0 / 1deg/step]
1-141-103	Fusing SC Error Time Info	Press Roller:Ctr Det1	ENG*	[-100 to 300 / 0 / 1deg/step]
1-141-104	Fusing SC Error Time Info	Press Roller:End Det1	ENG*	[-100 to 300 / 0 / 1deg/step]
1-141-105	Fusing SC Error Time Info	NC Sensor: Center Atmosphere Temp 1	ENG*	[-100 to 300 / 0 / 1deg/step]
1-141-106	Fusing SC Error Time Info	NC Sensor: End Atmosphere Temp 1	ENG*	[-100 to 300 / 0 / 1deg/step]
1-141-107	Fusing SC Error Time Info	Press Roller:End Det 1	ENG*	[-100 to 300 / 0 / 1deg/step]
1-141-	Fusing SC Error Time Info	Fuser State Det 1	ENG*	[0 to 100 / 0 / 1/step]

3.SP Mode Tables

SP No.	Large Category	Small Category	ENG or CTL	[Min to Max/Init./Step]
108				
1-141-109	Fusing SC Error Time Info	Heater1 Duty Det 1	ENG*	[0 to 100 / 0 / 1%/step]
1-141-110	Fusing SC Error Time Info	Heater2 Duty Det 1	ENG*	[0 to 100 / 0 / 1%/step]
1-141-111	Fusing SC Error Time Info	NC Sensor: Center Det Temp AD 1	ENG*	[0 to 2000 / 0 / 1/step]
1-141-112	Fusing SC Error Time Info	NC Sensor: Center Atmosphere Temp AD 1	ENG*	[0 to 2000 / 0 / 1/step]
1-141-113	Fusing SC Error Time Info	NC Sensor: End Det Temp AD 1	ENG*	[0 to 2000 / 0 / 1/step]
1-141-114	Fusing SC Error Time Info	NC Sensor: End Atmosphere Temp AD 1	ENG*	[0 to 2000 / 0 / 1/step]
1-141-151	Fusing SC Error Time Info	Htg Roller: Ctr Det2	ENG*	[-100 to 300 / 0 / 1deg/step]
1-141-152	Fusing SC Error Time Info	Htg Roller: End Det2	ENG*	[-100 to 300 / 0 / 1deg/step]
1-141-153	Fusing SC Error Time Info	Press Roller: Ctr Det2	ENG*	[-100 to 300 / 0 / 1deg/step]
1-141-154	Fusing SC Error Time Info	Press Roller: End Det2	ENG*	[-100 to 300 / 0 / 1deg/step]
1-141-155	Fusing SC Error Time Info	NC Sensor: Center Atmosphere Temp 2	ENG*	[-100 to 300 / 0 / 1deg/step]
1-141-	Fusing SC Error Time Info	NC Sensor: End Atmosphere Temp 2	ENG*	[-100 to 300 / 0 / 1deg/step]

3.SP Mode Tables

SP No.	Large Category	Small Category	ENG or CTL	[Min to Max/Init./Step]
156				
1-141-157	Fusing SC Error Time Info	Press Roller:End Det 2	ENG*	[-100 to 300 / 0 / 1deg/step]
1-141-158	Fusing SC Error Time Info	Fuser State Det 2	ENG*	[0 to 100 / 0 / 1/step]
1-141-159	Fusing SC Error Time Info	Heater1 Duty Det 2	ENG*	[0 to 100 / 0 / 1%/step]
1-141-160	Fusing SC Error Time Info	Heater2 Duty Det 2	ENG*	[0 to 100 / 0 / 1%/step]
1-141-161	Fusing SC Error Time Info	NC Sensor: Center Det Temp AD 2	ENG*	[0 to 2000 / 0 / 1/step]
1-141-162	Fusing SC Error Time Info	NC Sensor: Center Atmosphere Temp AD 2	ENG*	[0 to 2000 / 0 / 1/step]
1-141-163	Fusing SC Error Time Info	NC Sensor: End Det Temp AD 2	ENG*	[0 to 2000 / 0 / 1/step]
1-141-164	Fusing SC Error Time Info	NC Sensor: End Atmosphere Temp AD 2	ENG*	[0 to 2000 / 0 / 1/step]
1-141-201	Fusing SC Error Time Info	Htg Roller:Ctr Det3	ENG*	[-100 to 300 / 0 / 1deg/step]
1-141-202	Fusing SC Error Time Info	Htg Roller:End Det3	ENG*	[-100 to 300 / 0 / 1deg/step]
1-141-203	Fusing SC Error Time Info	Press Roller:Ctr Det3	ENG*	[-100 to 300 / 0 / 1deg/step]
1-141-	Fusing SC Error Time Info	Press Roller:End Det3	ENG*	[-100 to 300 / 0 / 1deg/step]

3.SP Mode Tables

SP No.	Large Category	Small Category	ENG or CTL	[Min to Max/Init./Step]
204				
1-141-205	Fusing SC Error Time Info	NC Sensor: Center Atmosphere Temp 3	ENG*	[-100 to 300 / 0 / 1deg/step]
1-141-206	Fusing SC Error Time Info	NC Sensor: End Atmosphere Temp 3	ENG*	[-100 to 300 / 0 / 1deg/step]
1-141-207	Fusing SC Error Time Info	Press Roller:End Det 3	ENG*	[-100 to 300 / 0 / 1deg/step]
1-141-208	Fusing SC Error Time Info	Fuser State Det 3	ENG*	[0 to 100 / 0 / 1/step]
1-141-209	Fusing SC Error Time Info	Heater1 Duty Det 3	ENG*	[0 to 100 / 0 / 1%/step]
1-141-210	Fusing SC Error Time Info	Heater2 Duty Det 3	ENG*	[0 to 100 / 0 / 1%/step]
1-141-211	Fusing SC Error Time Info	NC Sensor: Center Det Temp AD 3	ENG*	[0 to 2000 / 0 / 1/step]
1-141-212	Fusing SC Error Time Info	NC Sensor: Center Atmosphere Temp AD 3	ENG*	[0 to 2000 / 0 / 1/step]
1-141-213	Fusing SC Error Time Info	NC Sensor: End Det Temp AD 3	ENG*	[0 to 2000 / 0 / 1/step]
1-141-214	Fusing SC Error Time Info	NC Sensor: End Atmosphere Temp AD 3	ENG*	[0 to 2000 / 0 / 1/step]
1-142-001	Fusing Jam Detection	SC Display	ENG*	[0 to 1 / 0 / 1/step]
1-152-	Fusing Nip Band Check	Execute	ENG	[0 to 1 / 0 / 1/step]

3.SP Mode Tables

SP No.	Large Category	Small Category	ENG or CTL	[Min to Max/Init./Step]
001				
1-152-002	Fusing Nip Band Check	Pre-idling Time	ENG*	[0 to 999 / 300 / 1sec/step]
1-152-003	Fusing Nip Band Check	Stop Time	ENG*	[0 to 100 / 20 / 1sec/step]
1-152-004	Fusing Nip Band Check	Pressure Position	ENG*	[1 to 2 / 2 / 1/step]
1-153-001	Abnormal Noise Confirmation	Unit: Execute	ENG	[0 to 1 / 0 / 1/step]
1-153-002	Abnormal Noise Confirmation	No Unit: Execute	ENG	[0 to 1 / 0 / 1/step]
1-153-003	Abnormal Noise Confirmation	Operation Line Speed	ENG	[0 to 2 / 0 / 1/step]
1-153-004	Abnormal Noise Confirmation	Operation Time	ENG	[0 to 240 / 60 / 1sec/step]
1-153-005	Abnormal Noise Confirmation	Heat Center Target Temp	ENG	[100 to 180 / 130 / 1deg/step]
1-153-006	Abnormal Noise Confirmation	Heat End Target Temp	ENG	[100 to 180 / 130 / 1deg/step]
1-153-007	Abnormal Noise Confirmation	Press Target Temp	ENG	[0 to 200 / 0 / 1deg/step]
1-165-001	Shading Plate Control	Execution Judgement	ENG*	[0 to 1 / 1 / 1/step]
1-165-	Shading Plate Control	Continuous Error Times	ENG*	[0 to 10 / 0 / 1/step]

3.SP Mode Tables

SP No.	Large Category	Small Category	ENG or CTL	[Min to Max/Init./Step]
101				
1-165-151	Shading Plate Control	Fusing Shading Plate Operation:Result	ENG*	[0 to 10 / 0 / 1/step]
1-801-001	Moter Speed Adjust	Feed CCW:Plain:Low	ENG*	[-2.0 to 2.0 / 0.9 / 0.1%/step]
1-801-002	Moter Speed Adjust	Feed CCW:Plain:Std	ENG*	[-2.0 to 2.0 / 0.9 / 0.1%/step]
1-801-003	Moter Speed Adjust	Feed CCW:Mid-thick:Low	ENG*	[-2.0 to 2.0 / 1.1 / 0.1%/step]
1-801-004	Moter Speed Adjust	Feed CCW:Mid-thick:Std	ENG*	[-2.0 to 2.0 / 1.1 / 0.1%/step]
1-801-005	Moter Speed Adjust	Feed CCW:Thick 1:Low	ENG*	[-2.0 to 2.0 / 1.2 / 0.1%/step]
1-801-006	Moter Speed Adjust	Feed CCW:Thick 1:Mid	ENG*	[-2.0 to 2.0 / 1.2 / 0.1%/step]
1-801-007	Moter Speed Adjust	Feed CCW:Thick 2:Low	ENG*	[-2.0 to 2.0 / 1.2 / 0.1%/step]
1-801-008	Moter Speed Adjust	Feed CCW:Thick 3:Low	ENG*	[-2.0 to 2.0 / 0.9 / 0.1%/step]
1-801-009	Moter Speed Adjust	Feed CCW:Thick 4:Low	ENG*	[-2.0 to 2.0 / 0.9 / 0.1%/step]
1-801-010	Moter Speed Adjust	Feed CW:Plain:Low	ENG*	[-2.0 to 2.0 / 0.9 / 0.1%/step]
1-801-	Moter Speed Adjust	Feed CW:Plain:Std	ENG*	[-2.0 to 2.0 / 0.9 / 0.1%/step]

3.SP Mode Tables

SP No.	Large Category	Small Category	ENG or CTL	[Min to Max/Init./Step]
011				
1-801-012	Moter Speed Adjust	Feed CW:Mid-thick:Low	ENG*	[-2.0 to 2.0 / 1.1 / 0.1%/step]
1-801-013	Moter Speed Adjust	Feed CW:Mid-thick:Std	ENG*	[-2.0 to 2.0 / 1.1 / 0.1%/step]
1-801-014	Moter Speed Adjust	Feed CW:Thick 1:Low	ENG*	[-2.0 to 2.0 / 1.2 / 0.1%/step]
1-801-015	Moter Speed Adjust	Feed CW:Thick 1:Mid	ENG*	[-2.0 to 2.0 / 1.2 / 0.1%/step]
1-801-016	Moter Speed Adjust	Feed CW:Thick 2:Low	ENG*	[-2.0 to 2.0 / 1.2 / 0.1%/step]
1-801-017	Moter Speed Adjust	Feed CW:Thick 3:Low	ENG*	[-2.0 to 2.0 / 0.9 / 0.1%/step]
1-801-018	Moter Speed Adjust	Feed CW:Thick 4:Low	ENG*	[-2.0 to 2.0 / 0.9 / 0.1%/step]
1-801-019	Moter Speed Adjust	Vertical Feed:Plain:Low	ENG*	[-2.0 to 2.0 / 0.9 / 0.1%/step]
1-801-020	Moter Speed Adjust	Vertical Feed:Plain:Std	ENG*	[-2.0 to 2.0 / 0.9 / 0.1%/step]
1-801-021	Moter Speed Adjust	Vertical Feed:Mid-thick:Low	ENG*	[-2.0 to 2.0 / 1.1 / 0.1%/step]
1-801-022	Moter Speed Adjust	Vertical Feed:Mid-thick:Std	ENG*	[-2.0 to 2.0 / 1.1 / 0.1%/step]
1-801-	Moter Speed Adjust	Vertical Feed:Thick 1:Low	ENG*	[-2.0 to 2.0 / 1.2 / 0.1%/step]

3.SP Mode Tables

SP No.	Large Category	Small Category	ENG or CTL	[Min to Max/Init./Step]
023				
1-801-024	Moter Speed Adjust	Vertical Feed:Thick 1:Mid	ENG*	[-2.0 to 2.0 / 1.2 / 0.1%/step]
1-801-025	Moter Speed Adjust	Vertical Feed:Thick 2:Low	ENG*	[-2.0 to 2.0 / 1.2 / 0.1%/step]
1-801-026	Moter Speed Adjust	Vertical Feed:Thick 3:Low	ENG*	[-2.0 to 2.0 / 0.9 / 0.1%/step]
1-801-027	Moter Speed Adjust	Vertical Feed:Thick 4:Low	ENG*	[-2.0 to 2.0 / 0.9 / 0.1%/step]
1-801-028	Moter Speed Adjust	Registration:Plain:Low	ENG*	[-2.0 to 2.0 / 0.3 / 0.1%/step]
1-801-029	Moter Speed Adjust	Registration:Plain:Std	ENG*	[-2.0 to 2.0 / 0.3 / 0.1%/step]
1-801-030	Moter Speed Adjust	Registration:Mid-thick:Low	ENG*	[-2.0 to 2.0 / 0.3 / 0.1%/step]
1-801-031	Moter Speed Adjust	Registration:Mid-thick:Std	ENG*	[-2.0 to 2.0 / 0.3 / 0.1%/step]
1-801-032	Moter Speed Adjust	Registration:Thick 1:Low	ENG*	[-2.0 to 2.0 / 0.4 / 0.1%/step]
1-801-033	Moter Speed Adjust	Registration:Thick1:Mid	ENG*	[-2.0 to 2.0 / 0.4 / 0.1%/step]
1-801-034	Moter Speed Adjust	Registration:Thick 2:Low	ENG*	[-2.0 to 2.0 / 0.4 / 0.1%/step]
1-801-	Moter Speed Adjust	Registration:Thick 3:Low	ENG*	[-2.0 to 2.0 / 0.3 / 0.1%/step]

3.SP Mode Tables

SP No.	Large Category	Small Category	ENG or CTL	[Min to Max/Init./Step]
035				
1-801-036	Moter Speed Adjust	Registration:Thick 4:Low	ENG*	[-2.0 to 2.0 / 0.3 / 0.1%/step]
1-801-037	Moter Speed Adjust	Exit CCW:Plain:Low	ENG*	[-4.0 to 4.0 / -0.8 / 0.1%/step]
1-801-038	Moter Speed Adjust	Exit CCW:Plain:Std	ENG*	[-4.0 to 4.0 / -0.8 / 0.1%/step]
1-801-039	Moter Speed Adjust	Exit CCW:Mid-thick:Low	ENG*	[-4.0 to 4.0 / -0.8 / 0.1%/step]
1-801-040	Moter Speed Adjust	Exit CCW:Mid-thick:Std	ENG*	[-4.0 to 4.0 / -0.8 / 0.1%/step]
1-801-041	Moter Speed Adjust	Exit CCW:Thick1:Low	ENG*	[-4.0 to 4.0 / -0.8 / 0.1%/step]
1-801-042	Moter Speed Adjust	Exit CCW:Thick1:Mid	ENG*	[-4.0 to 4.0 / -0.6 / 0.1%/step]
1-801-043	Moter Speed Adjust	Exit CCW:Thick2:Low	ENG*	[-4.0 to 4.0 / -0.9 / 0.1%/step]
1-801-044	Moter Speed Adjust	Exit CCW:Thick3:Low	ENG*	[-4.0 to 4.0 / -0.9 / 0.1%/step]
1-801-045	Moter Speed Adjust	Exit CCW:Thick4:Low	ENG*	[-4.0 to 4.0 / -0.4 / 0.1%/step]
1-801-046	Moter Speed Adjust	Reverse CW:Plain:Low	ENG*	[-4.0 to 4.0 / 0.7 / 0.1%/step]
1-801-	Moter Speed Adjust	Reverse CW:Plain:Std	ENG*	[-4.0 to 4.0 / 0.7 / 0.1%/step]

3.SP Mode Tables

SP No.	Large Category	Small Category	ENG or CTL	[Min to Max/Init./Step]
047				
1-801-048	Moter Speed Adjust	Reverse CW:Mid-thick:Low	ENG*	[-4.0 to 4.0 / 0.5 / 0.1%/step]
1-801-049	Moter Speed Adjust	Reverse CW:Mid-thick:Std	ENG*	[-4.0 to 4.0 / 0.5 / 0.1%/step]
1-801-050	Moter Speed Adjust	Reverse CW:Thick1:Low	ENG*	[-4.0 to 4.0 / 0.7 / 0.1%/step]
1-801-051	Moter Speed Adjust	Reverse CW:Thick1:Mid	ENG*	[-4.0 to 4.0 / 0.7 / 0.1%/step]
1-801-052	Moter Speed Adjust	Reverse CW:Thick2:Low	ENG*	[-4.0 to 4.0 / 0.8 / 0.1%/step]
1-801-053	Moter Speed Adjust	Reverse CW:Thick3:Low	ENG*	[-4.0 to 4.0 / 0.7 / 0.1%/step]
1-801-054	Moter Speed Adjust	Reverse CW:Thick4:Low	ENG*	[-4.0 to 4.0 / 0.7 / 0.1%/step]
1-801-055	Moter Speed Adjust	Reverse CCW:Plain:Low	ENG*	[-4.0 to 4.0 / -0.8 / 0.1%/step]
1-801-056	Moter Speed Adjust	Reverse CCW:Plain:Std	ENG*	[-4.0 to 4.0 / -0.8 / 0.1%/step]
1-801-057	Moter Speed Adjust	Reverse CCW:Mid-thick:Low	ENG*	[-4.0 to 4.0 / -0.8 / 0.1%/step]
1-801-058	Moter Speed Adjust	Reverse CCW:Mid-thick:Std	ENG*	[-4.0 to 4.0 / -0.8 / 0.1%/step]
1-801-	Moter Speed Adjust	Reverse CCW:Thick1:Low	ENG*	[-4.0 to 4.0 / -0.8 / 0.1%/step]

3.SP Mode Tables

SP No.	Large Category	Small Category	ENG or CTL	[Min to Max/Init./Step]
059				
1-801-060	Moter Speed Adjust	Reverse CCW:Thick1:Mid	ENG*	[-4.0 to 4.0 / -0.6 / 0.1%/step]
1-801-061	Moter Speed Adjust	Reverse CCW:Thick2:Low	ENG*	[-4.0 to 4.0 / -0.9 / 0.1%/step]
1-801-062	Moter Speed Adjust	Reverse CCW:Thick3:Low	ENG*	[-4.0 to 4.0 / -0.9 / 0.1%/step]
1-801-063	Moter Speed Adjust	Reverse CCW:Thick4:Low	ENG*	[-4.0 to 4.0 / -0.4 / 0.1%/step]
1-801-064	Moter Speed Adjust	Duplex Enter CW:Plain:Low	ENG*	[-4.0 to 4.0 / 1.4 / 0.1%/step]
1-801-065	Moter Speed Adjust	Duplex Enter CW:Plain:Std	ENG*	[-4.0 to 4.0 / 1.4 / 0.1%/step]
1-801-066	Moter Speed Adjust	Duplex Enter CW:Mid-thick:Low	ENG*	[-4.0 to 4.0 / 1.2 / 0.1%/step]
1-801-067	Moter Speed Adjust	Duplex Enter CW:Mid-thick:Std	ENG*	[-4.0 to 4.0 / 1.2 / 0.1%/step]
1-801-068	Moter Speed Adjust	Duplex Enter CW:Thick1:Low	ENG*	[-4.0 to 4.0 / 1.5 / 0.1%/step]
1-801-069	Moter Speed Adjust	Duplex Enter CW:Thick1:Mid	ENG*	[-4.0 to 4.0 / 1.5 / 0.1%/step]
1-801-070	Moter Speed Adjust	Duplex Enter CW:Thick2:Low	ENG*	[-4.0 to 4.0 / 1.5 / 0.1%/step]
1-801-	Moter Speed Adjust	Duplex Enter CW:Thick3:Low	ENG*	[-4.0 to 4.0 / 1.4 / 0.1%/step]

3.SP Mode Tables

SP No.	Large Category	Small Category	ENG or CTL	[Min to Max/Init./Step]
071				
1-801-072	Moter Speed Adjust	Duplex CW:Plain:Low	ENG*	[-4.0 to 4.0 / 0.7 / 0.1%/step]
1-801-073	Moter Speed Adjust	Duplex CW:Plain:Std	ENG*	[-4.0 to 4.0 / 0.7 / 0.1%/step]
1-801-074	Moter Speed Adjust	Duplex CW:Mid-thick:Low	ENG*	[-4.0 to 4.0 / 0.5 / 0.1%/step]
1-801-075	Moter Speed Adjust	Duplex CW:Mid-thick:Std	ENG*	[-4.0 to 4.0 / 0.5 / 0.1%/step]
1-801-076	Moter Speed Adjust	Duplex CW:Thick1:Low	ENG*	[-4.0 to 4.0 / 0.8 / 0.1%/step]
1-801-077	Moter Speed Adjust	Duplex CW:Thick1:Mid	ENG*	[-4.0 to 4.0 / 0.8 / 0.1%/step]
1-801-078	Moter Speed Adjust	Duplex CW:Thick2:Low	ENG*	[-4.0 to 4.0 / 0.8 / 0.1%/step]
1-801-079	Moter Speed Adjust	Duplex CW:Thick3:Low	ENG*	[-4.0 to 4.0 / 0.7 / 0.1%/step]
1-801-080	Moter Speed Adjust	Duplex CCW:Plain:Low	ENG*	[-4.0 to 4.0 / 0.9 / 0.1%/step]
1-801-081	Moter Speed Adjust	Duplex CCW:Plain:Std	ENG*	[-4.0 to 4.0 / 0.9 / 0.1%/step]
1-801-082	Moter Speed Adjust	Duplex CCW:Mid-thick:Low	ENG*	[-4.0 to 4.0 / 1.1 / 0.1%/step]
1-801-	Moter Speed Adjust	Duplex CCW:Mid-thick:Std	ENG*	[-4.0 to 4.0 / 1.1 / 0.1%/step]

3.SP Mode Tables

SP No.	Large Category	Small Category	ENG or CTL	[Min to Max/Init./Step]
083				
1-801-084	Motor Speed Adjust	Duplex CCW:Thick1:Low	ENG*	[-4.0 to 4.0 / 1.2 / 0.1%/step]
1-801-085	Motor Speed Adjust	Duplex CCW:Thick1:Mid	ENG*	[-4.0 to 4.0 / 1.2 / 0.1%/step]
1-801-086	Motor Speed Adjust	Duplex CCW:Thick2:Low	ENG*	[-4.0 to 4.0 / 1.2 / 0.1%/step]
1-801-087	Motor Speed Adjust	Duplex CCW:Thick3:Low	ENG*	[-4.0 to 4.0 / 0.9 / 0.1%/step]
1-801-088	Motor Speed Adjust	Duplex CCW:Thick4:Low	ENG*	[-4.0 to 4.0 / 0.9 / 0.1%/step]
1-801-089	Motor Speed Adjust	Relay Motor Speed Adjust:Low	ENG*	[-4.0 to 4.0 / 0.0 / 0.1%/step]
1-801-090	Motor Speed Adjust	Relay Motor Speed Adjust:Mid	ENG*	[-4.0 to 4.0 / 0.0 / 0.1%/step]
1-801-091	Motor Speed Adjust	Relay Motor Speed Adjust:Standard	ENG*	[-4.0 to 4.0 / 0.0 / 0.1%/step]
1-801-100	Motor Speed Adj.	Drum Adjust	ENG*	[0 to 1 / 1 / 1/step]
1-801-101	Motor Speed Adj.	Offset:ColorOpcMot:Standard	ENG*	[-10.00 to 10.00 / 0.00 / 0.01Hz/step]
1-801-102	Motor Speed Adj.	Offset:ColorOpcMot:Mid	ENG*	[-10.00 to 10.00 / 0.00 / 0.01Hz/step]
1-801-	Motor Speed Adj.	Offset:ColorOpcMot:Low	ENG*	[-10.00 to 10.00 / 0.00 /

3.SP Mode Tables

SP No.	Large Category	Small Category	ENG or CTL	[Min to Max/Init./Step]
103				0.01Hz/step]
1-801-106	Motor Speed Adj.	ColorOpcMot:Standard	ENG*	[-10.00 to 10.00 / 0.00 / 0.01Hz/step]
1-801-107	Motor Speed Adj.	ColorOpcMot:Mid	ENG*	[-10.00 to 10.00 / 0.00 / 0.01Hz/step]
1-801-108	Motor Speed Adj.	ColorOpcMot:Low	ENG*	[-10.00 to 10.00 / 0.00 / 0.01Hz/step]
1-801-109	Motor Speed Adj.	BkDevMot:Standard	ENG*	[-20.0 to 20.0 / 0.0 / 0.1%/step]
1-801-110	Motor Speed Adj.	BkDevMot:Mid	ENG*	[-20.0 to 20.0 / 0.0 / 0.1%/step]
1-801-111	Motor Speed Adj.	BkDevMot:Low	ENG*	[-20.0 to 20.0 / 0.0 / 0.1%/step]
1-801-115	Motor Speed Adj.	ColorDevMot:Standard	ENG*	[-20.0 to 20.0 / 0.0 / 0.1%/step]
1-801-116	Motor Speed Adj.	ColorDevMot:Mid	ENG*	[-20.0 to 20.0 / 0.0 / 0.1%/step]
1-801-117	Motor Speed Adj.	ColorDevMot:Low	ENG*	[-20.0 to 20.0 / 0.0 / 0.1%/step]
1-801-118	Motor Speed Adj.	Fusing:Standard	ENG*	[-10.00 to 10.00 / -1.40 / 0.01%/step]
1-801-119	Motor Speed Adj.	Fusing:Mid	ENG*	[-10.00 to 10.00 / -1.00 / 0.01%/step]
1-801-	Motor Speed Adj.	Fusing:Low	ENG*	[-10.00 to 10.00 / -1.00 / 0.01%/step]

3.SP Mode Tables

SP No.	Large Category	Small Category	ENG or CTL	[Min to Max/Init./Step]
120				
1-801-121	Motor Speed Adj.	Fusing:Low:1200:Plain	ENG*	[-10.00 to 10.00 / -1.40 / 0.01%/step]
1-801-122	Motor Speed Adj.	OPCTransferMot:Standard	ENG*	[-10.00 to 10.00 / 0.20 / 0.01%/step]
1-801-123	Motor Speed Adj.	OPCTransferMot:Mid	ENG*	[-10.00 to 10.00 / 0.20 / 0.01%/step]
1-801-124	Motor Speed Adj.	OPCTransferMot:Low	ENG*	[-10.00 to 10.00 / 0.20 / 0.01%/step]
1-801-125	Motor Speed Adj.	Fusing:Low:Thick 4	ENG*	[-10.00 to 10.00 / -0.50 / 0.01%/step]
1-801-133	Motor Speed Adj.	ColorOpcMot:Standard:independence	ENG*	[-10.00 to 10.00 / -0.20 / 0.01%/step]
1-801-134	Motor Speed Adj.	ColorOpcMot:Mid:independence	ENG*	[-10.00 to 10.00 / -0.20 / 0.01%/step]
1-801-135	Motor Speed Adj.	ColorOpcMot:Low:independence	ENG*	[-10.00 to 10.00 / -0.20 / 0.01%/step]
1-801-140	Motor Speed Adjust	Long:Registration:Plain:Low	ENG*	[-2.0 to 2.0 / 0.3 / 0.1%/step]
1-801-141	Motor Speed Adjust	Long:Registration:Plain:High	ENG*	[-2.0 to 2.0 / 0.3 / 0.1%/step]
1-801-142	Motor Speed Adjust	Long:Registration:Middle Thick:Low	ENG*	[-2.0 to 2.0 / 0.3 / 0.1%/step]
1-801-	Motor Speed Adjust	Long:Registration:Middle Thick:High	ENG*	[-2.0 to 2.0 / 0.3 / 0.1%/step]

3.SP Mode Tables

SP No.	Large Category	Small Category	ENG or CTL	[Min to Max/Init./Step]
143				
1-801-144	Motor Speed Adjust	Long:Registration:Thick 1:Low	ENG*	[-2.0 to 2.0 / 0.4 / 0.1%/step]
1-801-145	Motor Speed Adjust	Long:Registration:Thick 1:Middle	ENG*	[-2.0 to 2.0 / 0.4 / 0.1%/step]
1-801-146	Motor Speed Adjust	Long:Registration:Thick 2:Low	ENG*	[-2.0 to 2.0 / 0.4 / 0.1%/step]
1-801-147	Motor Speed Adjust	Long:Registration:Thick 3:Low	ENG*	[-2.0 to 2.0 / 0.3 / 0.1%/step]
1-801-148	Motor Speed Adjust	Long:Registration:Thick 4:Low	ENG*	[-2.0 to 2.0 / 0.3 / 0.1%/step]
1-801-160	Motor Speed Adjust	Long:Fusing:Plain:Low	ENG*	[-10.00 to 10.00 / -1.20 / 0.01%/step]
1-801-161	Motor Speed Adjust	Long:Fusing:Plain:High	ENG*	[-10.00 to 10.00 / -1.40 / 0.01%/step]
1-801-162	Motor Speed Adjust	Long:Fusing:Middle Thick:Low	ENG*	[-10.00 to 10.00 / -0.80 / 0.01%/step]
1-801-163	Motor Speed Adjust	Long:Fusing:Middle Thick:High	ENG*	[-10.00 to 10.00 / -1.40 / 0.01%/step]
1-801-164	Motor Speed Adjust	Long:Fusing:Thick 1:Low	ENG*	[-10.00 to 10.00 / -0.80 / 0.01%/step]
1-801-165	Motor Speed Adjust	Long:Fusing:Thick 1:Middle	ENG*	[-10.00 to 10.00 / -0.80 / 0.01%/step]
1-801-	Motor Speed Adjust	Long:Fusing:Thick 2:Low	ENG*	[-10.00 to 10.00 / -0.80 / 0.01%/step]

3.SP Mode Tables

SP No.	Large Category	Small Category	ENG or CTL	[Min to Max/Init./Step]
166				
1-801-167	Motor Speed Adjust	Long:Fusing:Thick 3:Low	ENG*	[-10.00 to 10.00 / -0.80 / 0.01%/step]
1-801-168	Motor Speed Adjust	Long:Fusing:Thick 4:Low	ENG*	[-10.00 to 10.00 / -0.80 / 0.01%/step]
1-801-180	Motor Speed Adjust	Long:Exit CCW:Plain:Low	ENG*	[-4.0 to 4.0 / -0.8 / 0.1%/step]
1-801-181	Motor Speed Adjust	Long:Exit CCW:Plain:High	ENG*	[-4.0 to 4.0 / -0.8 / 0.1%/step]
1-801-182	Motor Speed Adjust	Long:Exit CCW:Middle Thick:Low	ENG*	[-4.0 to 4.0 / -0.8 / 0.1%/step]
1-801-183	Motor Speed Adjust	Long:Exit CCW:Middle Thick:High	ENG*	[-4.0 to 4.0 / -0.8 / 0.1%/step]
1-801-184	Motor Speed Adjust	Long:Exit CCW:Thick 1:Low	ENG*	[-4.0 to 4.0 / -0.8 / 0.1%/step]
1-801-185	Motor Speed Adjust	Long:Exit CCW:Thick 1:Middle	ENG*	[-4.0 to 4.0 / -0.6 / 0.1%/step]
1-801-186	Motor Speed Adjust	Long:Exit CCW:Thick 2:Low	ENG*	[-4.0 to 4.0 / -0.9 / 0.1%/step]
1-801-187	Motor Speed Adjust	Long:Exit CCW:Thick 3:Low	ENG*	[-4.0 to 4.0 / -0.9 / 0.1%/step]
1-801-188	Motor Speed Adjust	Long:Exit CCW:Thick 4:Low	ENG*	[-4.0 to 4.0 / -0.9 / 0.1%/step]
1-805-	Motor Gain Adj.	DuplexInM:Speed Detective Gain	ENG*	[0.00 to 200.00 / 100.00 /

3.SP Mode Tables

SP No.	Large Category	Small Category	ENG or CTL	[Min to Max/Init./Step]
050				0.01%/step]
1-805-051	Motor Gain Adj.	DuplexInM:Position Loop Gain	ENG*	[0.00 to 200.00 / 50.00 / 0.01%/step]
1-805-052	Motor Gain Adj.	DuplexInM:Proportional Gain:PID	ENG*	[0.00 to 200.00 / 50.00 / 0.01%/step]
1-805-053	Motor Gain Adj.	DuplexInM:Integral Gain:PID	ENG*	[0.00 to 200.00 / 50.00 / 0.01%/step]
1-805-054	Motor Gain Adj.	DuplexInM:Derivative Gain:PID	ENG*	[0.00 to 200.00 / 50.00 / 0.01%/step]
1-805-055	Motor Gain Adj.	DuplexInM:Derivative Gain:FF	ENG*	[0.00 to 200.00 / 100.00 / 0.01%/step]
1-805-056	Motor Gain Adj.	DuplexInM:Proportional Gain:FF	ENG*	[0.00 to 200.00 / 100.00 / 0.01%/step]
1-805-057	Motor Gain Adj.	DuplexInM:Offset:FF	ENG*	[0.00 to 200.00 / 100.00 / 0.01%/step]
1-805-058	Motor Gain Adj.	DuplexInM:Numerator Coefficient:LPF:B0	ENG*	[0.00 to 200.00 / 100.00 / 0.01%/step]
1-805-059	Motor Gain Adj.	DuplexInM:Denominator Coefficient:LPF:A1	ENG*	[0.00 to 200.00 / 100.00 / 0.01%/step]
1-805-060	Motor Gain Adj.	DuplexInM:Denominator Coefficient:LPF:A2	ENG*	[0.00 to 200.00 / 100.00 / 0.01%/step]
1-805-061	Motor Gain Adj.	DuplexM:Speed Detective Gain	ENG*	[0.00 to 200.00 / 100.00 / 0.01%/step]
1-805-	Motor Gain Adj.	DuplexM:Position Loop Gain	ENG*	[0.00 to 200.00 / 50.00 /

3.SP Mode Tables

SP No.	Large Category	Small Category	ENG or CTL	[Min to Max/Init./Step]
062				0.01%/step]
1-805-063	Motor Gain Adj.	DuplexM:Proportional Gain:PID	ENG*	[0.00 to 200.00 / 50.00 / 0.01%/step]
1-805-064	Motor Gain Adj.	DuplexM:Integral Gain:PID	ENG*	[0.00 to 200.00 / 50.00 / 0.01%/step]
1-805-065	Motor Gain Adj.	DuplexM:Derivative Gain:PID	ENG*	[0.00 to 200.00 / 50.00 / 0.01%/step]
1-805-066	Motor Gain Adj.	DuplexM:Derivative Gain:FF	ENG*	[0.00 to 200.00 / 100.00 / 0.01%/step]
1-805-067	Motor Gain Adj.	DuplexM:Proportional Gain:FF	ENG*	[0.00 to 200.00 / 100.00 / 0.01%/step]
1-805-068	Motor Gain Adj.	DuplexM:Offset:FF	ENG*	[0.00 to 200.00 / 100.00 / 0.01%/step]
1-805-069	Motor Gain Adj.	DuplexM:Numerator Coefficient:LPF:B0	ENG*	[0.00 to 200.00 / 100.00 / 0.01%/step]
1-805-070	Motor Gain Adj.	DuplexM:Denominator Coefficient:LPF:A1	ENG*	[0.00 to 200.00 / 100.00 / 0.01%/step]
1-805-071	Motor Gain Adj.	DuplexM:Denominator Coefficient:LPF:A2	ENG*	[0.00 to 200.00 / 100.00 / 0.01%/step]
1-805-072	Motor Gain Adj.	DuplexM:Speed Detective Gain	ENG*	[0.00 to 200.00 / 100.00 / 0.01%/step]
1-805-073	Motor Gain Adj.	DuplexM:Position Loop Gain	ENG*	[0.00 to 200.00 / 50.00 / 0.01%/step]
1-805-	Motor Gain Adj.	DuplexM:Proportional Gain:PID	ENG*	[0.00 to 200.00 / 50.00 /

3.SP Mode Tables

SP No.	Large Category	Small Category	ENG or CTL	[Min to Max/Init./Step]
074				0.01%/step]
1-805-075	Motor Gain Adj.	DuplexM:Integral Gain:PID	ENG*	[0.00 to 200.00 / 50.00 / 0.01%/step]
1-805-076	Motor Gain Adj.	DuplexM:Derivative Gain:PID	ENG*	[0.00 to 200.00 / 50.00 / 0.01%/step]
1-805-077	Motor Gain Adj.	DuplexM:Derivative Gain:FF	ENG*	[0.00 to 200.00 / 100.00 / 0.01%/step]
1-805-078	Motor Gain Adj.	DuplexM:Proportional Gain:FF	ENG*	[0.00 to 200.00 / 100.00 / 0.01%/step]
1-805-079	Motor Gain Adj.	DuplexM:Offset:FF	ENG*	[0.00 to 200.00 / 100.00 / 0.01%/step]
1-805-080	Motor Gain Adj.	DuplexM:Numerator Coefficient:LPF:B0	ENG*	[0.00 to 200.00 / 100.00 / 0.01%/step]
1-805-081	Motor Gain Adj.	DuplexM:Denominator Coefficient:LPF:A1	ENG*	[0.00 to 200.00 / 100.00 / 0.01%/step]
1-805-082	Motor Gain Adj.	DuplexM:Denominator Coefficient:LPF:A2	ENG*	[0.00 to 200.00 / 100.00 / 0.01%/step]
1-805-115	Motor Gain Adj.	DuplexInM:Proportional Gain:PID	ENG*	[0.00 to 200.00 / 100.00 / 0.01%/step]
1-805-116	Motor Gain Adj.	DuplexInM:Integral Gain:PID	ENG*	[0.00 to 200.00 / 100.00 / 0.01%/step]
1-805-117	Motor Gain Adj.	DuplexInM:Derivative Gain:PID	ENG*	[0.00 to 200.00 / 100.00 / 0.01%/step]
1-805-	Motor Gain Adj.	DuplexM:Proportional Gain:PID	ENG*	[0.00 to 200.00 / 100.00 /

3.SP Mode Tables

SP No.	Large Category	Small Category	ENG or CTL	[Min to Max/Init./Step]
118				0.01%/step]
1-805-119	Motor Gain Adj.	DuplexM:Integral Gain:PID	ENG*	[0.00 to 200.00 / 100.00 / 0.01%/step]
1-805-120	Motor Gain Adj.	DuplexM:Derivative Gain:PID	ENG*	[0.00 to 200.00 / 100.00 / 0.01%/step]
1-805-121	Motor Gain Adj.	DuplexM:Proportional Gain:PID	ENG*	[0.00 to 200.00 / 100.00 / 0.01%/step]
1-805-122	Motor Gain Adj.	DuplexM:Integral Gain:PID	ENG*	[0.00 to 200.00 / 100.00 / 0.01%/step]
1-805-123	Motor Gain Adj.	DuplexM:Derivative Gain:PID	ENG*	[0.00 to 200.00 / 100.00 / 0.01%/step]
1-805-136	Inner M Status	Paper Feed M	ENG*	[0 to 65535 / 0 / 1/step]
1-805-137	Inner M Status	Paper Grip M	ENG*	[0 to 65535 / 0 / 1/step]
1-805-138	Inner M Status	Registration M	ENG*	[0 to 65535 / 0 / 1/step]
1-805-139	Inner M Status	Paper Exit M	ENG*	[0 to 65535 / 0 / 1/step]
1-805-140	Inner M Status	Duplex Entrance M	ENG*	[0 to 65535 / 0 / 1/step]
1-805-141	Inner M Status	Duplex Bypass M	ENG*	[0 to 65535 / 0 / 1/step]
1-806-	Motor Speed Profile	DuplexInM:Acceleration1	ENG*	[0.00 to 200.00 / 100.00 /

3.SP Mode Tables

SP No.	Large Category	Small Category	ENG or CTL	[Min to Max/Init./Step]
020				0.01%/step]
1-806-021	Motor Speed Profile	DuplexInM:Deceleration1	ENG*	[0.00 to 200.00 / 100.00 / 0.01%/step]
1-806-022	Motor Speed Profile	DuplexInM:Acceleration2	ENG*	[0.00 to 200.00 / 100.00 / 0.01%/step]
1-806-023	Motor Speed Profile	DuplexInM:Deceleration2	ENG*	[0.00 to 200.00 / 100.00 / 0.01%/step]
1-806-024	Motor Speed Profile	DuplexM:Acceleration1	ENG*	[0.00 to 200.00 / 100.00 / 0.01%/step]
1-806-025	Motor Speed Profile	DuplexM:Deceleration1	ENG*	[0.00 to 200.00 / 100.00 / 0.01%/step]
1-806-026	Motor Speed Profile	DuplexM:Acceleration2	ENG*	[0.00 to 200.00 / 100.00 / 0.01%/step]
1-806-027	Motor Speed Profile	DuplexM:Deceleration2	ENG*	[0.00 to 200.00 / 100.00 / 0.01%/step]
1-806-028	Motor Speed Profile	DuplexM:Acceleration1	ENG*	[0.00 to 200.00 / 100.00 / 0.01%/step]
1-806-029	Motor Speed Profile	DuplexM:Deceleration1	ENG*	[0.00 to 200.00 / 100.00 / 0.01%/step]
1-806-030	Motor Speed Profile	DuplexM:Acceleration2	ENG*	[0.00 to 200.00 / 100.00 / 0.01%/step]
1-806-031	Motor Speed Profile	DuplexM:Deceleration2	ENG*	[0.00 to 200.00 / 100.00 / 0.01%/step]
1-902-	Drum Phase Adj.	Execute	ENG	[0 to 1 / 0 / 1/step]

3.SP Mode Tables

SP No.	Large Category	Small Category	ENG or CTL	[Min to Max/Init./Step]
001				
1-907-001	Paper Feed Timing Adj.	Feed Solenoid ON:Tray1:Plain	ENG*	[-20 to 20 / 0 / 1mm/step]
1-907-002	Paper Feed Timing Adj.	Feed Solenoid ON:Tray1:Thick	ENG*	[-20 to 20 / 0 / 1mm/step]
1-907-003	Paper Feed Timing Adj.	Feed Solenoid ON:Tray2:Plain	ENG*	[-20 to 20 / 0 / 1mm/step]
1-907-004	Paper Feed Timing Adj.	Feed Solenoid ON:Tray2:Thick	ENG*	[-20 to 20 / 0 / 1mm/step]
1-907-005	Paper Feed Timing Adj.	Feed DCM OFF:Tray1:Plain	ENG*	[-20 to 20 / 0 / 1mm/step]
1-907-006	Paper Feed Timing Adj.	Feed DCM OFF:Tray1:Thick	ENG*	[-20 to 20 / 0 / 1mm/step]
1-907-007	Paper Feed Timing Adj.	Feed DCM OFF:Tray2:Plain	ENG*	[-20 to 20 / 0 / 1mm/step]
1-907-008	Paper Feed Timing Adj.	Feed DCM OFF:Tray2:Thick	ENG*	[-20 to 20 / 0 / 1mm/step]
1-907-009	Paper Feed Timing Adj.	Feed Solenoid OFF:Tray1:Plain	ENG*	[-20 to 20 / 0 / 1mm/step]
1-907-010	Paper Feed Timing Adj.	Feed Solenoid OFF:Tray1:Thick	ENG*	[-20 to 20 / 0 / 1mm/step]
1-907-011	Paper Feed Timing Adj.	Feed Solenoid OFF:Tray2:Plain	ENG*	[-20 to 20 / 0 / 1mm/step]
1-907-	Paper Feed Timing Adj.	Feed Solenoid OFF:Tray2:Thick	ENG*	[-20 to 20 / 0 / 1mm/step]

3.SP Mode Tables

SP No.	Large Category	Small Category	ENG or CTL	[Min to Max/Init./Step]
012				
1-907-013	Paper Feed Timing Adj.	Feed Start:Tray1:Plain	ENG*	[-20 to 20 / 0 / 1mm/step]
1-907-014	Paper Feed Timing Adj.	Feed Start:Tray1:Thick	ENG*	[-20 to 20 / 0 / 1mm/step]
1-907-015	Paper Feed Timing Adj.	Feed Start:Tray2:Plain	ENG*	[-20 to 20 / 0 / 1mm/step]
1-907-016	Paper Feed Timing Adj.	Feed Start:Tray2:Thick	ENG*	[-20 to 20 / 0 / 1mm/step]
1-907-017	Paper Feed Timing Adj.	Feed Re-Start:Tray1:Plain	ENG*	[-20 to 20 / 0 / 1mm/step]
1-907-018	Paper Feed Timing Adj.	Feed Re-Start:Tray1:Thick	ENG*	[-20 to 20 / 0 / 1mm/step]
1-907-019	Paper Feed Timing Adj.	Feed Re-Start:Tray2:Plain	ENG*	[-20 to 20 / 0 / 1mm/step]
1-907-020	Paper Feed Timing Adj.	Feed Re-Start:Tray2:Thick	ENG*	[-20 to 20 / 0 / 1mm/step]
1-907-021	Paper Feed Timing Adj.	Feed Re2-Start:Tray2:Plain	ENG*	[-20 to 20 / 0 / 1mm/step]
1-907-022	Paper Feed Timing Adj.	Feed Re2-Start:Tray2:Thick	ENG*	[-20 to 20 / 0 / 1mm/step]
1-907-023	Paper Feed Timing Adj.	Registration DCM OFF:Plain	ENG*	[-5.0 to 5.0 / 0.0 / 0.1mm/step]
1-907-	Paper Feed Timing Adj.	Registration DCM OFF:Thick	ENG*	[-5.0 to 5.0 / 0.0 / 0.1mm/step]

3.SP Mode Tables

SP No.	Large Category	Small Category	ENG or CTL	[Min to Max/Init./Step]
024				
1-907-025	Paper Feed Timing Adj.	By-pass Solenoid ON:Low	ENG*	[0 to 40 / 0 / 1mm/step]
1-907-026	Paper Feed Timing Adj.	By-pass Solenoid ON:Mid	ENG*	[0 to 40 / 0 / 1mm/step]
1-907-027	Paper Feed Timing Adj.	By-pass Solenoid ON:Std	ENG	[0 to 40 / 0 / 1mm/step]
1-907-028	Paper Feed Timing Adj.	By-pass Solenoid OFF	ENG*	[0 to 40 / 0 / 1mm/step]
1-907-029	Paper Feed Timing Adj.	By-pass Size Decision Timing	ENG*	[1 to 3 / 3 / 1/step]
1-907-030	Paper Feed Timing Adj.	Duplex DCM OFF:Low	ENG*	[-10 to 10 / 0 / 1mm/step]
1-907-031	Paper Feed Timing Adj.	Duplex DCM OFF:Mid	ENG*	[-10 to 10 / 0 / 1mm/step]
1-907-032	Paper Feed Timing Adj.	Duplex DCM OFF:Std	ENG	[-10 to 10 / 0 / 1mm/step]
1-907-033	Paper Feed Timing Adj.	ExitPaperJunction SOL ON:Low	ENG*	[-10 to 10 / 0 / 1mm/step]
1-907-034	Paper Feed Timing Adj.	ExitPaperJunction SOL ON:Mid	ENG*	[-10 to 10 / 0 / 1mm/step]
1-907-035	Paper Feed Timing Adj.	ExitPaperJunction SOL ON:Std	ENG	[-10 to 10 / 0 / 1mm/step]
1-907-	Paper Feed Timing Adj.	ExitPaperJunction SOL OFF:Low	ENG*	[-10 to 10 / 0 / 1mm/step]

3.SP Mode Tables

SP No.	Large Category	Small Category	ENG or CTL	[Min to Max/Init./Step]
036				
1-907-037	Paper Feed Timing Adj.	ExitPaperJunction SOL OFF:Mid	ENG*	[-10 to 10 / 0 / 1mm/step]
1-907-038	Paper Feed Timing Adj.	ExitPaperJunction SOL OFF:Std	ENG	[-10 to 10 / 0 / 1mm/step]
1-907-039	Paper Feed Timing Adj.	Reverse Position:Plain	ENG*	[-10 to 10 / 0 / 1mm/step]
1-907-040	Paper Feed Timing Adj.	Reverse Position:Thick	ENG*	[-10 to 10 / 0 / 1mm/step]
1-907-041	Paper Feed Timing Adj.	Duplex Enter Position:Plain	ENG	[-10 to 10 / 0 / 1mm/step]
1-907-042	Paper Feed Timing Adj.	Duplex Enter Position:Thick	ENG	[-10 to 10 / 0 / 1mm/step]
1-907-043	Paper Feed Timing Adj.	Duplex Re-Feed Position:Plain	ENG*	[-10 to 10 / 0 / 1mm/step]
1-907-044	Paper Feed Timing Adj.	Duplex Re-Feed Position:Thick	ENG*	[-10 to 10 / 0 / 1mm/step]
1-907-045	Paper Feed Timing Adj.	ExitM:Accelerate Position:Normal Speed	ENG	[-5 to 15 / 0 / 1mm/step]
1-907-046	Paper Feed Timing Adj.	ExitM:Accelerate Position:Middle Speed	ENG	[-5 to 15 / 0 / 1mm/step]
1-907-047	Paper Feed Timing Adj.	ExitM:Accelerate Position:Low Speed	ENG	[-5 to 15 / 0 / 1mm/step]
1-907-	Paper Feed Timing Adj.	ExitM:Accelerate Position:Low:1200:Plain	ENG	[-5 to 15 / 0 / 1mm/step]

3.SP Mode Tables

SP No.	Large Category	Small Category	ENG or CTL	[Min to Max/Init./Step]
048				
1-907-061	Paper Feed Timing Adj.	Feed Solenoid ON:Tray3:Plain	ENG	[-20 to 20 / 0 / 1mm/step]
1-907-062	Paper Feed Timing Adj.	Feed Solenoid ON:Tray3:Thick	ENG	[-20 to 20 / 0 / 1mm/step]
1-907-063	Paper Feed Timing Adj.	Feed Solenoid ON:Tray4:Plain	ENG	[-20 to 20 / 0 / 1mm/step]
1-907-064	Paper Feed Timing Adj.	Feed Solenoid ON:Tray4:Thick	ENG	[-20 to 20 / 0 / 1mm/step]
1-907-065	Paper Feed Timing Adj.	Feed Solenoid ON:Tray5(LCT):Plain	ENG	[-20 to 20 / 0 / 1mm/step]
1-907-066	Paper Feed Timing Adj.	Feed Solenoid ON:Tray5(LCT):Thick	ENG	[-20 to 20 / 0 / 1mm/step]
1-907-067	Paper Feed Timing Adj.	Feed DCM OFF:Tray3:Plain	ENG	[-20 to 20 / 0 / 1mm/step]
1-907-068	Paper Feed Timing Adj.	Feed DCM OFF:Tray3:Thick	ENG	[-20 to 20 / 0 / 1mm/step]
1-907-069	Paper Feed Timing Adj.	Feed DCM OFF:Tray4:Plain	ENG	[-20 to 20 / 0 / 1mm/step]
1-907-070	Paper Feed Timing Adj.	Feed DCM OFF:Tray4:Thick	ENG	[-20 to 20 / 0 / 1mm/step]
1-907-071	Paper Feed Timing Adj.	Feed DCM OFF:Tray5(LCT):Plain	ENG	[-20 to 20 / 0 / 1mm/step]
1-907-	Paper Feed Timing Adj.	Feed DCM OFF:Tray5(LCT):Thick	ENG	[-20 to 20 / 0 / 1mm/step]

3.SP Mode Tables

SP No.	Large Category	Small Category	ENG or CTL	[Min to Max/Init./Step]
072				
1-907-073	Paper Feed Timing Adj.	Feed Solenoid OFF:Tray3:Plain	ENG	[-20 to 20 / 0 / 1mm/step]
1-907-074	Paper Feed Timing Adj.	Feed Solenoid OFF:Tray3:Thick	ENG	[-20 to 20 / 0 / 1mm/step]
1-907-075	Paper Feed Timing Adj.	Feed Solenoid OFF:Tray4:Plain	ENG	[-20 to 20 / 0 / 1mm/step]
1-907-076	Paper Feed Timing Adj.	Feed Solenoid OFF:Tray4:Thick	ENG	[-20 to 20 / 0 / 1mm/step]
1-907-077	Paper Feed Timing Adj.	Feed Solenoid OFF:Tray5(LCT):Plain	ENG	[-20 to 20 / 0 / 1mm/step]
1-907-078	Paper Feed Timing Adj.	Feed Solenoid OFF:Tray5(LCT):Thick	ENG	[-20 to 20 / 0 / 1mm/step]
1-907-079	Paper Feed Timing Adj.	Feed Start:Tray3:Plain	ENG	[-20 to 20 / 0 / 1mm/step]
1-907-080	Paper Feed Timing Adj.	Feed Start:Tray3:Thick	ENG	[-20 to 20 / 0 / 1mm/step]
1-907-081	Paper Feed Timing Adj.	Feed Start:Tray4:Plain	ENG	[-20 to 20 / 0 / 1mm/step]
1-907-082	Paper Feed Timing Adj.	Feed Start:Tray4:Thick	ENG	[-20 to 20 / 0 / 1mm/step]
1-907-083	Paper Feed Timing Adj.	Feed Start:Tray5(LCT):Plain	ENG	[-20 to 20 / 0 / 1mm/step]
1-907-	Paper Feed Timing Adj.	Feed Start:Tray5(LCT):Thick	ENG	[-20 to 20 / 0 / 1mm/step]

3.SP Mode Tables

SP No.	Large Category	Small Category	ENG or CTL	[Min to Max/Init./Step]
084				
1-907-085	Paper Feed Timing Adj.	ExitLineSpdUp EndPos:StdSpd	ENG*	[-30 to 15 / 0 / 1mm/step]
1-907-086	Paper Feed Timing Adj.	ExitLineSpdUp EndPos:MidSpd	ENG*	[-30 to 15 / 0 / 1mm/step]
1-907-087	Paper Feed Timing Adj.	ExitLineSpdUp EndPos:LowSpd	ENG*	[-30 to 15 / 0 / 1mm/step]
1-907-088	Paper Feed Timing Adj.	ExitLineSpdUp EndPos:LowSpd:1200:Plain	ENG*	[-30 to 15 / 0 / 1mm/step]
1-907-090	Paper Feed Timing Adj.	Fusing Exit SOL ON: LowSpd	ENG*	[-15 to 15 / 0 / 1mm/step]
1-907-091	Paper Feed Timing Adj.	Fusing Exit SOL ON: MidSpd	ENG*	[-15 to 15 / 0 / 1mm/step]
1-907-092	Paper Feed Timing Adj.	Fusing Exit SOL ON: StdSpd	ENG*	[-15 to 15 / 0 / 1mm/step]
1-907-093	Paper Feed Timing Adj.	Fusing Exit SOL OFF: LowSpd	ENG*	[-15 to 15 / 0 / 1mm/step]
1-907-094	Paper Feed Timing Adj.	Fusing Exit SOL OFF: MidSpd	ENG*	[-15 to 15 / 0 / 1mm/step]
1-907-095	Paper Feed Timing Adj.	Fusing Exit SOL OFF: StdSpd	ENG*	[-15 to 15 / 0 / 1mm/step]
1-907-096	Operation Setting	Fusing Exit SOL Setting	ENG*	[0 to 6 / 0 / 1/step]
1-907-	Paper Feed Timing Adj.	Feed Re-Start:Tray3:Plain	ENG*	[-20 to 20 / 0 / 1mm/step]

3.SP Mode Tables

SP No.	Large Category	Small Category	ENG or CTL	[Min to Max/Init./Step]
097				
1-907-098	Paper Feed Timing Adj.	Feed Re-Start:Tray3:Thick	ENG*	[-20 to 20 / 0 / 1mm/step]
1-907-099	Paper Feed Timing Adj.	Feed Re-Start:Tray4:Plain	ENG*	[-20 to 20 / 0 / 1mm/step]
1-907-100	Paper Feed Timing Adj.	Feed Re-Start:Tray4:Thick	ENG*	[-20 to 20 / 0 / 1mm/step]
1-907-101	Paper Feed Timing Adj.	Feed Re-Start:Tray5(LCT):Plain	ENG*	[-20 to 20 / 0 / 1mm/step]
1-907-102	Paper Feed Timing Adj.	Feed Re-Start:Tray5(LCT):Thick	ENG*	[-20 to 20 / 0 / 1mm/step]
1-907-103	Paper Feed Timing Adj.	Feed Re2-Start:Tray3:Plain	ENG*	[-20 to 20 / 0 / 1mm/step]
1-907-104	Paper Feed Timing Adj.	Feed Re2-Start:Tray3:Thick	ENG*	[-20 to 20 / 0 / 1mm/step]
1-907-105	Paper Feed Timing Adj.	Feed Re2-Start:Tray4:Plain	ENG*	[-20 to 20 / 0 / 1mm/step]
1-907-106	Paper Feed Timing Adj.	Feed Re2-Start:Tray4:Thick	ENG*	[-20 to 20 / 0 / 1mm/step]
1-907-107	Paper Feed Timing Adj.	Feed Re2-Start:Tray5(LCT):Plain	ENG*	[-20 to 20 / 0 / 1mm/step]
1-907-108	Paper Feed Timing Adj.	Feed Re2-Start:Tray5(LCT):Thick	ENG*	[-20 to 20 / 0 / 1mm/step]
1-907-	Paper Feed Timing Adj.	Manual Feed Regist. Stop Timing: Env	ENG	[0 to 40 / 0 / 1mm/step]

3.SP Mode Tables

SP No.	Large Category	Small Category	ENG or CTL	[Min to Max/Init./Step]
109				
1-908-001	Paper Feed Length	History:Last	ENG	[-99 to 99 / 0 / 1mm/step]
1-908-002	Paper Feed Length	History:Last 2	ENG	[-99 to 99 / 0 / 1mm/step]
1-908-003	Paper Feed Length	History:Last 3	ENG	[-99 to 99 / 0 / 1mm/step]
1-908-004	Paper Feed Length	History:Last 4	ENG	[-99 to 99 / 0 / 1mm/step]
1-908-005	Paper Feed Length	History:Last 5	ENG	[-99 to 99 / 0 / 1mm/step]
1-908-006	Paper Feed Length	History:Last 6	ENG	[-99 to 99 / 0 / 1mm/step]
1-908-007	Paper Feed Length	History:Last 7	ENG	[-99 to 99 / 0 / 1mm/step]
1-908-008	Paper Feed Length	History:Last 8	ENG	[-99 to 99 / 0 / 1mm/step]
1-908-009	Paper Feed Length	History:Last 9	ENG	[-99 to 99 / 0 / 1mm/step]
1-908-010	Paper Feed Length	History:Last 10	ENG	[-99 to 99 / 0 / 1mm/step]
1-909-001	Regist Jam Margin Adjust	Tray	ENG*	[-22 to 0 / 0 / 1mm/step]
1-909-	Regist Jam Margin Adjust	By-Pass	ENG*	[-43 to 0 / 0 / 1mm/step]

3.SP Mode Tables

SP No.	Large Category	Small Category	ENG or CTL	[Min to Max/Init./Step]
002				
1-909-003	Regist Jam Margin Adjust	Duplex	ENG*	[-24 to -6 / -6 / 1mm/step]
1-950-003	Fan Cooling Time Set	Dev Cooling Fan	ENG*	[0 to 120 / 0 / 1min/step]
1-950-005	Fan Cooling Time Set	Ozone Fan	ENG*	[0 to 120 / 0 / 1min/step]
1-950-006	Fan Cooling Time Set	Fusing Fan	ENG*	[0 to 120 / 0 / 1min/step]
1-950-007	Fan Cooling Time Set	Paper Exit Cooling Fan	ENG*	[0 to 120 / 0 / 1min/step]
1-950-011	Fan Cooling Time Set	PSU Cooling Fan	ENG*	[0 to 120 / 0 / 1min/step]
1-950-051	Fan Cooling Time Set	Dev Suction Fan: Right	ENG*	[0 to 120 / 0 / 1min/step]
1-950-061	Extra Fan Op Decision time	Fusing Fan	ENG*	[0 to 10000 / 480 / 1sec/step]
1-950-062	Extra Fan Op Decision time	Paper Exit Cooling Fan	ENG*	[0 to 10000 / 480 / 1sec/step]
1-950-071	Extra Fan Cooling Time Set	Fusing Fan	ENG*	[0 to 900 / 120 / 1sec/step]
1-950-072	Extra Fan Cooling Time Set	Paper Exit Cooling Fan	ENG*	[0 to 900 / 120 / 1sec/step]
1-951-	Fan Start Time Set	Dev Cooling Fan	ENG*	[0 to 900 / 120 / 1sec/step]

3.SP Mode Tables

SP No.	Large Category	Small Category	ENG or CTL	[Min to Max/Init./Step]
003				
1-951-005	Fan Start Time Set	Ozone Fan	ENG*	[0 to 900 / 0 / 1sec/step]
1-951-006	Fan Start Time Set	Fusing Fan	ENG*	[0 to 900 / 120 / 1sec/step]
1-951-007	Fan Start Time Set	Paper Exit Cooling Fan	ENG*	[0 to 900 / 120 / 1sec/step]
1-951-011	Fan Start Time Set	PSU Cooling Fan	ENG*	[0 to 900 / 120 / 1sec/step]
1-951-051	Fan Start Time Set	Dev Suction Fan: Right	ENG*	[0 to 900 / 0 / 1sec/step]
1-952-001	Fan Control Off Mode Time Set		ENG*	[0 to 60 / 10 / 1min/step]
1-953-001	Extra Fan Control	Extra Fan Cooling State	ENG	[0 to 1 / 0 / 1/step]
1-953-002	Extra Fan Control	Execution Temp. Threshold	ENG*	IM C3500: [0.0 to 100.0 / 41.0 / 0.1deg/step] IM C2500: [0.0 to 100.0 / 38.5 / 0.1deg/step] IM C2000: [0.0 to 100.0 / 38.5 / 0.1deg/step] IM C3000: [0.0 to 100.0 / 41.0 / 0.1deg/step]
1-953-003	Extra Fan Control	Cancellation Temp. Threshold	ENG*	[0.0 to 100.0 / 2.0 / 0.1deg/step]

3.SP Mode Tables

SP No.	Large Category	Small Category	ENG or CTL	[Min to Max/Init./Step]
1-953-004	Extra Fan Control	Extra Fan Operation ON/OFF Setting	ENG*	[0 to 1 / 1 / 1/step]
1-955-002	Fan Control	Fusing Fan Low Speed Op DUTY	ENG*	[40 to 75 / 64 / 1%/step]
1-955-003	Fan Control	Fusing Fan High Speed Op DUTY	ENG*	[40 to 100 / 100 / 1%/step]
1-955-004	Fan Control	Dev Cooling Fan Op Sw Temp	ENG*	[0.0 to 100.0 / 33.0 / 0.1deg/step]
1-955-006	Fan Control	Paper Exit Cooling Fan Op Sw Temp	ENG*	[0.0 to 100.0 / 12.0 / 0.1deg/step]
1-955-007	Fan Control	Fusing Fan Op Sw Temp	ENG*	[0.0 to 100.0 / 0.0 / 0.1deg/step]
1-955-009	Fan Control	Ozone Fan Low Speed Op Sw Temp	ENG*	[0.0 to 100.0 / 27.5 / 0.1deg/step]
1-955-010	Fan Control	Ozone Fan Middle Speed Op Sw Temp	ENG*	[0.0 to 100.0 / 33.0 / 0.1deg/step]
1-955-011	Fan Control	Ozone Fan High Speed Op Sw Temp	ENG*	[0.0 to 100.0 / 40.0 / 0.1deg/step]
1-955-012	Fan Control	Ozone Fan Low Noise Op DUTY	ENG*	[0 to 100 / 50 / 1%/step]
1-955-013	Fan Control	Ozone Fan Low Speed Op DUTY	ENG*	[0 to 100 / 75 / 1%/step]
1-955-014	Fan Control	Ozone Fan Middle Speed Op DUTY	ENG*	[0 to 100 / 100 / 1%/step]

3.SP Mode Tables

SP No.	Large Category	Small Category	ENG or CTL	[Min to Max/Init./Step]
1-955-015	Fan Control	Ozone Fan High Speed Op DUTY	ENG*	[0 to 100 / 100 / 1%/step]
1-955-016	Fan Control	Paper Exit Cooling Fan Op Start Time A	ENG*	[0 to 900 / 300 / 1sec/step]
1-955-017	Fan Control	PSU Cooling Fan Op Start Time A	ENG*	[0 to 900 / 300 / 1sec/step]
1-955-018	Fan Control	Fan Op Sw Temp Thers	ENG*	[0.0 to 100.0 / 2.0 / 0.1deg/step]
1-955-019	Fan Control	Paper Exit Cooling Fan Control Off Mode Time	ENG*	[0 to 3600 / 600 / 1sec/step]
1-955-020	Fan Control	PSU Cooling Fan Control Off Mode Time	ENG*	[0 to 3600 / 600 / 1sec/step]
1-955-051	Fan Control	Dev Suction Fan: Right Op Sw Temp	ENG*	[0.0 to 100.0 / 33.0 / 0.1deg/step]
1-955-052	Fan Control	Dev Suction Fan: Right Low Speed Op DUTY	ENG*	[40 to 75 / 55 / 1%/step]
1-955-053	Fan Control	Dev Suction Fan: Right High Speed Op DUTY	ENG*	[40 to 100 / 100 / 1%/step]
1-955-062	Fan Control	Dev Suction Fan: Right Op Start Time	ENG*	[0 to 900 / 300 / 1sec/step]
1-955-063	Fan Control	Paper Exit Cooling Fan Op Start Time B	ENG*	[0 to 900 / 300 / 1sec/step]
1-955-064	Fan Control	PSU Cooling Fan Op Start Time B	ENG*	[0 to 900 / 300 / 1sec/step]

3.SP Mode Tables

SP No.	Large Category	Small Category	ENG or CTL	[Min to Max/Init./Step]
1-955-065	Fan Control	PSU Cooling Fan Op Start Time C	ENG*	IM C3500: TWN: [0 to 900 / 300 / 1sec/step] NA: [0 to 900 / 300 / 1sec/step] KOR: [0 to 900 / 120 / 1sec/step] EU: [0 to 900 / 120 / 1sec/step] CHN: [0 to 900 / 120 / 1sec/step] AS: [0 to 900 / 120 / 1sec/step] IM C2500: TWN: [0 to 900 / 300 / 1sec/step] NA: [0 to 900 / 300 / 1sec/step] KOR: [0 to 900 / 120 / 1sec/step] EU: [0 to 900 / 120 / 1sec/step] CHN: [0 to 900 / 120 / 1sec/step] AS: [0 to 900 / 120 / 1sec/step] IM C2000: TWN: [0 to 900 / 300 / 1sec/step] NA: [0 to 900 / 300 / 1sec/step] KOR: [0 to 900 / 120 / 1sec/step] EU: [0 to 900 / 120 / 1sec/step] CHN: [0 to 900 / 120 / 1sec/step]

3.SP Mode Tables

SP No.	Large Category	Small Category	ENG or CTL	[Min to Max/Init./Step]
				AS: [0 to 900 / 120 / 1sec/step] IM C3000: TWN: [0 to 900 / 300 / 1sec/step] NA: [0 to 900 / 300 / 1sec/step] KOR: [0 to 900 / 120 / 1sec/step] EU: [0 to 900 / 120 / 1sec/step] CHN: [0 to 900 / 120 / 1sec/step] AS: [0 to 900 / 120 / 1sec/step]
1-955-066	Fan Control	PSU Cooling Fan Op Start Time D	ENG*	IM C3500: TWN: [0 to 900 / 300 / 1sec/step] NA: [0 to 900 / 300 / 1sec/step] KOR: [0 to 900 / 120 / 1sec/step] EU: [0 to 900 / 120 / 1sec/step] CHN: [0 to 900 / 120 / 1sec/step] AS: [0 to 900 / 120 / 1sec/step] IM C2500: TWN: [0 to 900 / 300 / 1sec/step] NA: [0 to 900 / 300 / 1sec/step] KOR: [0 to 900 / 120 / 1sec/step] EU: [0 to 900 / 120 / 1sec/step]

3.SP Mode Tables

SP No.	Large Category	Small Category	ENG or CTL	[Min to Max/Init./Step]
				CHN: [0 to 900 / 120 / 1sec/step] AS: [0 to 900 / 120 / 1sec/step] IM C2000: TWN: [0 to 900 / 300 / 1sec/step] NA: [0 to 900 / 300 / 1sec/step] KOR: [0 to 900 / 120 / 1sec/step] EU: [0 to 900 / 120 / 1sec/step] CHN: [0 to 900 / 120 / 1sec/step] AS: [0 to 900 / 120 / 1sec/step] IM C3000: TWN: [0 to 900 / 300 / 1sec/step] NA: [0 to 900 / 300 / 1sec/step] KOR: [0 to 900 / 120 / 1sec/step] EU: [0 to 900 / 120 / 1sec/step] CHN: [0 to 900 / 120 / 1sec/step] AS: [0 to 900 / 120 / 1sec/step]
1-955-071	Fan Control	Ozone Fan Extra Op DUTY	ENG*	[0 to 100 / 50 / 1%/step]
1-955-080	Fan Control	Paper Exit Cooling Fan Low Speed Op Time A	ENG*	[0 to 900 / 0 / 1sec/step]
1-	Fan Control	PSU Cooling Fan Low Speed Op Time	ENG*	IM C3500:

3.SP Mode Tables

SP No.	Large Category	Small Category	ENG or CTL	[Min to Max/Init./Step]
955-081		A		[0 to 900 / 300 / 1sec/step] IM C2500: [0 to 900 / 300 / 1sec/step] IM C2000: [0 to 900 / 300 / 1sec/step] IM C3000: [0 to 900 / 300 / 1sec/step]
1-955-082	Fan Control	Paper Exit Cooling Fan Low Speed Op Time B	ENG*	[0 to 900 / 0 / 1sec/step]
1-955-083	Fan Control	PSU Cooling Fan Low Speed Op Time B	ENG*	IM C3500: [0 to 900 / 300 / 1sec/step] IM C2500: [0 to 900 / 300 / 1sec/step] IM C2000: [0 to 900 / 300 / 1sec/step] IM C3000: [0 to 900 / 300 / 1sec/step]
1-955-084	Fan Control	PSU Cooling Fan Low Speed Op Time C	ENG*	IM C3500: [0 to 900 / 300 / 1sec/step] IM C2500: [0 to 900 / 300 / 1sec/step] IM C2000: [0 to 900 / 300 / 1sec/step] IM C3000: [0 to 900 / 300 / 1sec/step]

3.SP Mode Tables

SP No.	Large Category	Small Category	ENG or CTL	[Min to Max/Init./Step]
				1sec/step]
1-955-085	Fan Control	PSU Cooling Fan Low Speed Op Time D	ENG*	IM C3500: [0 to 900 / 300 / 1sec/step] IM C2500: [0 to 900 / 300 / 1sec/step] IM C2000: [0 to 900 / 300 / 1sec/step] IM C3000: [0 to 900 / 300 / 1sec/step]
1-955-086	Fan Control	Paper Exit Cooling Fan Low Speed Op Time E	ENG*	[0 to 900 / 0 / 1sec/step]
1-955-087	Fan Control	PSU Cooling Fan Low Speed Op Time E	ENG*	IM C3500: [0 to 900 / 900 / 1sec/step] IM C2500: [0 to 900 / 900 / 1sec/step] IM C2000: [0 to 900 / 900 / 1sec/step] IM C3000: [0 to 900 / 900 / 1sec/step]
1-955-090	Fan Control	Paper Exit Cooling Fan Low Speed Op DUTY	ENG*	[40 to 75 / 46 / 1%/step]
1-955-091	Fan Control	PSU Cooling Fan Low Speed Op DUTY	ENG*	[40 to 75 / 46 / 1%/step]
1-955-092	Fan Control	Paper Exit Cooling Fan High Speed Op DUTY	ENG*	[40 to 100 / 100 / 1%/step]

3.SP Mode Tables

SP No.	Large Category	Small Category	ENG or CTL	[Min to Max/Init./Step]
1-955-093	Fan Control	PSU Cooling Fan High Speed Op DUTY	ENG*	[40 to 100 / 100 / 1%/step]

Engine SP Tables-2

SP2-XXX (Drum) -1

SP No.	Large Category	Small Category	ENG or CTL	[Min to Max/Init./Step]
2-005-001	Charge DC Voltage: Fixed	Standard Speed: K	ENG*	IM C3500: [0 to 2000 / 690 / 10-V/step] IM C2500: [0 to 2000 / 1350 / 10-V/step] IM C2000: [0 to 2000 / 1350 / 10-V/step] IM C3000: [0 to 2000 / 690 / 10-V/step]
2-005-002	Charge DC Voltage: Fixed	Standard Speed: C	ENG*	IM C3500: [0 to 2000 / 690 / 10-V/step] IM C2500: [0 to 2000 / 1350 / 10-V/step] IM C2000: [0 to 2000 / 1350 / 10-V/step] IM C3000: [0 to 2000 / 690 / 10-V/step]
2-005-003	Charge DC Voltage: Fixed	Standard Speed: M	ENG*	IM C3500: [0 to 2000 / 690 / 10-V/step] IM C2500:

3.SP Mode Tables

SP No.	Large Category	Small Category	ENG or CTL	[Min to Max/Init./Step]
				[0 to 2000 / 1350 / 10-V/step] IM C2000: [0 to 2000 / 1350 / 10-V/step] IM C3000: [0 to 2000 / 690 / 10-V/step]
2-005-004	Charge DC Voltage: Fixed	Standard Speed: Y	ENG*	IM C3500: [0 to 2000 / 690 / 10-V/step] IM C2500: [0 to 2000 / 1350 / 10-V/step] IM C2000: [0 to 2000 / 1350 / 10-V/step] IM C3000: [0 to 2000 / 690 / 10-V/step]
2-005-005	Charge DC Voltage: Fixed	Middle Speed: K	ENG*	IM C3500: [0 to 2000 / 690 / 10-V/step] IM C2500: [0 to 2000 / 1350 / 10-V/step] IM C2000: [0 to 2000 / 1350 / 10-V/step] IM C3000: [0 to 2000 / 690 / 10-V/step]
2-005-006	Charge DC Voltage: Fixed	Middle Speed: C	ENG*	IM C3500: [0 to 2000 / 690 / 10-V/step] IM C2500: [0 to 2000 / 1350 / 10-

3.SP Mode Tables

SP No.	Large Category	Small Category	ENG or CTL	[Min to Max/Init./Step]
				V/step] IM C2000: [0 to 2000 / 1350 / 10- V/step] IM C3000: [0 to 2000 / 690 / 10- V/step]
2-005-007	Charge DC Voltage: Fixed	Middle Speed: M	ENG*	IM C3500: [0 to 2000 / 690 / 10- V/step] IM C2500: [0 to 2000 / 1350 / 10- V/step] IM C2000: [0 to 2000 / 1350 / 10- V/step] IM C3000: [0 to 2000 / 690 / 10- V/step]
2-005-008	Charge DC Voltage: Fixed	Middle Speed: Y	ENG*	IM C3500: [0 to 2000 / 690 / 10- V/step] IM C2500: [0 to 2000 / 1350 / 10- V/step] IM C2000: [0 to 2000 / 1350 / 10- V/step] IM C3000: [0 to 2000 / 690 / 10- V/step]
2-005-009	Charge DC Voltage: Fixed	Low Speed: K	ENG*	IM C3500: [0 to 2000 / 690 / 10- V/step] IM C2500: [0 to 2000 / 1350 / 10- V/step]

3.SP Mode Tables

SP No.	Large Category	Small Category	ENG or CTL	[Min to Max/Init./Step]
				IM C2000: [0 to 2000 / 1350 / 10-V/step] IM C3000: [0 to 2000 / 690 / 10-V/step]
2-005-010	Charge DC Voltage: Fixed	Low Speed: C	ENG*	IM C3500: [0 to 2000 / 690 / 10-V/step] IM C2500: [0 to 2000 / 1350 / 10-V/step] IM C2000: [0 to 2000 / 1350 / 10-V/step] IM C3000: [0 to 2000 / 690 / 10-V/step]
2-005-011	Charge DC Voltage: Fixed	Low Speed: M	ENG*	IM C3500: [0 to 2000 / 690 / 10-V/step] IM C2500: [0 to 2000 / 1350 / 10-V/step] IM C2000: [0 to 2000 / 1350 / 10-V/step] IM C3000: [0 to 2000 / 690 / 10-V/step]
2-005-012	Charge DC Voltage: Fixed	Low Speed: Y	ENG*	IM C3500: [0 to 2000 / 690 / 10-V/step] IM C2500: [0 to 2000 / 1350 / 10-V/step] IM C2000:

3.SP Mode Tables

SP No.	Large Category	Small Category	ENG or CTL	[Min to Max/Init./Step]
				[0 to 2000 / 1350 / 10-V/step] IM C3000: [0 to 2000 / 690 / 10-V/step]
2-005-013	Charge DC Voltage: Correction	PCU: Standard Speed	ENG*	[-100 to 100 / 0 / 1-V/step]
2-005-014	Charge DC Voltage: Correction	PCU: Middle Speed	ENG*	[-100 to 100 / 0 / 1-V/step]
2-005-015	Charge DC Voltage: Correction	PCU: Low Speed	ENG*	[-100 to 100 / 0 / 1-V/step]
2-005-018	Charge DC Voltage: Correction	Correction Coefficient a: K	ENG*	[0.000 to 2.000 / 1.000 / 0.001-/step]
2-005-019	Charge DC Voltage: Correction	Correction Coefficient a: C	ENG*	[0.000 to 2.000 / 1.000 / 0.001-/step]
2-005-020	Charge DC Voltage: Correction	Correction Coefficient a: M	ENG*	[0.000 to 2.000 / 1.000 / 0.001-/step]
2-005-021	Charge DC Voltage: Correction	Correction Coefficient a: Y	ENG*	[0.000 to 2.000 / 1.000 / 0.001-/step]
2-005-022	Charge DC Voltage: Correction	Correction Coefficient b: K	ENG*	IM C3500: [0 to 2000 / 20 / 1-V/step] IM C2500: [0 to 2000 / 700 / 1-V/step] IM C2000: [0 to 2000 / 700 / 1-V/step] IM C3000: [0 to 2000 / 20 / 1-

SP No.	Large Category	Small Category	ENG or CTL	[Min to Max/Init./Step]
				V/step]
2-005-023	Charge DC Voltage: Correction	Correction Coefficient b: C	ENG*	IM C3500: [0 to 2000 / 20 / 1-V/step] IM C2500: [0 to 2000 / 700 / 1-V/step] IM C2000: [0 to 2000 / 700 / 1-V/step] IM C3000: [0 to 2000 / 20 / 1-V/step]
2-005-024	Charge DC Voltage: Correction	Correction Coefficient b: M	ENG*	IM C3500: [0 to 2000 / 20 / 1-V/step] IM C2500: [0 to 2000 / 700 / 1-V/step] IM C2000: [0 to 2000 / 700 / 1-V/step] IM C3000: [0 to 2000 / 20 / 1-V/step]
2-005-025	Charge DC Voltage: Correction	Correction Coefficient b: Y	ENG*	IM C3500: [0 to 2000 / 20 / 1-V/step] IM C2500: [0 to 2000 / 700 / 1-V/step] IM C2000: [0 to 2000 / 700 / 1-V/step] IM C3000: [0 to 2000 / 20 / 1-V/step]

3.SP Mode Tables

SP No.	Large Category	Small Category	ENG or CTL	[Min to Max/Init./Step]
2-005-026	Charge DC Voltage: Correction	Correction Coefficient c: K	ENG*	[-120 to 120 / 0 / 1-V/step]
2-005-027	Charge DC Voltage: Correction	Correction Coefficient c: C	ENG*	[-120 to 120 / 0 / 1-V/step]
2-005-028	Charge DC Voltage: Correction	Correction Coefficient c: M	ENG*	[-120 to 120 / 0 / 1-V/step]
2-005-029	Charge DC Voltage: Correction	Correction Coefficient c: Y	ENG*	[-120 to 120 / 0 / 1-V/step]
2-005-030	Charge DC Voltage: Correction	Temperature Threshold L: K	ENG*	[0 to 99 / 15 / 1deg/step]
2-005-031	Charge DC Voltage: Correction	Temperature Threshold L: C	ENG*	[0 to 99 / 15 / 1deg/step]
2-005-032	Charge DC Voltage: Correction	Temperature Threshold L: M	ENG*	[0 to 99 / 16 / 1deg/step]
2-005-033	Charge DC Voltage: Correction	Temperature Threshold L: Y	ENG*	[0 to 99 / 16 / 1deg/step]
2-005-034	Charge DC Voltage: Correction	Temperature Threshold M: K	ENG*	[0 to 99 / 22 / 1deg/step]
2-005-035	Charge DC Voltage: Correction	Temperature Threshold M: C	ENG*	[0 to 99 / 22 / 1deg/step]
2-005-036	Charge DC Voltage: Correction	Temperature Threshold M: M	ENG*	[0 to 99 / 23 / 1deg/step]
2-005-037	Charge DC Voltage: Correction	Temperature Threshold M: Y	ENG*	[0 to 99 / 23 / 1deg/step]

3.SP Mode Tables

SP No.	Large Category	Small Category	ENG or CTL	[Min to Max/Init./Step]
2-005-038	Charge DC Voltage: Correction	Temperature Threshold H: K	ENG*	[0 to 99 / 28 / 1deg/step]
2-005-039	Charge DC Voltage: Correction	Temperature Threshold H: C	ENG*	[0 to 99 / 28 / 1deg/step]
2-005-040	Charge DC Voltage: Correction	Temperature Threshold H: M	ENG*	[0 to 99 / 29 / 1deg/step]
2-005-041	Charge DC Voltage: Correction	Temperature Threshold H: Y	ENG*	[0 to 99 / 29 / 1deg/step]
2-005-043	Charge DC Voltage: Correction	DC Bias Fixed Value Set	ENG*	[0 to 1 / 0 / 1-/step]
2-005-044	Charge DC Voltage: Correction	Correction Coefficient a: Fixed K	ENG*	[0.000 to 2.000 / 1.000 / 0.001-/step]
2-005-045	Charge DC Voltage: Correction	Correction Coefficient a: Fixed C	ENG*	[0.000 to 2.000 / 1.000 / 0.001-/step]
2-005-046	Charge DC Voltage: Correction	Correction Coefficient a: Fixed M	ENG*	[0.000 to 2.000 / 1.000 / 0.001-/step]
2-005-047	Charge DC Voltage: Correction	Correction Coefficient a: Fixed Y	ENG*	[0.000 to 2.000 / 1.000 / 0.001-/step]
2-005-048	Charge DC Voltage: Correction	Correction Coefficient b: Fixed K	ENG*	IM C3500: [0 to 2000 / 20 / 1-/step] IM C2500: [0 to 2000 / 700 / 1-/step] IM C2000: [0 to 2000 / 700 / 1-/step] IM C3000: [0 to 2000 / 20 / 1-/step]

3.SP Mode Tables

SP No.	Large Category	Small Category	ENG or CTL	[Min to Max/Init./Step]
2-005-049	Charge DC Voltage: Correction	Correction Coefficient b: Fixed C	ENG*	IM C3500: [0 to 2000 / 20 / 1-/step] IM C2500: [0 to 2000 / 700 / 1-/step] IM C2000: [0 to 2000 / 700 / 1-/step] IM C3000: [0 to 2000 / 20 / 1-/step]
2-005-050	Charge DC Voltage: Correction	Correction Coefficient b: Fixed M	ENG*	IM C3500: [0 to 2000 / 20 / 1-/step] IM C2500: [0 to 2000 / 700 / 1-/step] IM C2000: [0 to 2000 / 700 / 1-/step] IM C3000: [0 to 2000 / 20 / 1-/step]
2-005-051	Charge DC Voltage: Correction	Correction Coefficient b: Fixed Y	ENG*	IM C3500: [0 to 2000 / 20 / 1-/step] IM C2500: [0 to 2000 / 700 / 1-/step] IM C2000: [0 to 2000 / 700 / 1-/step] IM C3000: [0 to 2000 / 20 / 1-/step]
2-005-052	Charge DC Voltage: Correction	Correction Coefficient c: Fixed K	ENG*	[-120 to 120 / 0 / 1-V/step]
2-005-053	Charge DC Voltage: Correction	Correction Coefficient c: Fixed C	ENG*	[-120 to 120 / 0 / 1-V/step]
2-	Charge DC Voltage:	Correction Coefficient c:	ENG*	[-120 to 120 / 0 / 1-

3.SP Mode Tables

SP No.	Large Category	Small Category	ENG or CTL	[Min to Max/Init./Step]
005-054	Correction	Fixed M		V/step]
2-005-055	Charge DC Voltage: Correction	Correction Coefficient c: Fixed Y	ENG*	[-120 to 120 / 0 / 1-V/step]
2-005-056	Charge DC Voltage: Correction	Correction Rotation : Charge R: K	ENG*	[0 to 999999999 / 0 / 1mm/step]
2-005-057	Charge DC Voltage: Correction	Correction Rotation : Charge R: C	ENG*	[0 to 999999999 / 0 / 1mm/step]
2-005-058	Charge DC Voltage: Correction	Correction Rotation : Charge R: M	ENG*	[0 to 999999999 / 0 / 1mm/step]
2-005-059	Charge DC Voltage: Correction	Correction Rotation : Charge R: Y	ENG*	[0 to 999999999 / 0 / 1mm/step]
2-005-060	Charge DC Voltage: Correction	Correction Rotation : OPC R: K	ENG*	[0 to 999999999 / 0 / 1mm/step]
2-005-061	Charge DC Voltage: Correction	Correction Rotation : OPC R: C	ENG*	[0 to 999999999 / 0 / 1mm/step]
2-005-062	Charge DC Voltage: Correction	Correction Rotation : OPC R: M	ENG*	[0 to 999999999 / 0 / 1mm/step]
2-005-063	Charge DC Voltage: Correction	Correction Rotation : OPC R: Y	ENG*	[0 to 999999999 / 0 / 1mm/step]
2-005-064	Charge DC Voltage: Correction	Correction Coefficient Cd	ENG*	[-125 to 125 / 10 / 1-V/step]
2-005-065	Charge DC Voltage: Correction	Correction Coefficient Ce	ENG*	[-125 to 125 / 13 / 1-V/step]
2-	Charge DC Voltage:	Correction Coefficient Cf	ENG*	[-125 to 125 / 16 / 1-

3.SP Mode Tables

SP No.	Large Category	Small Category	ENG or CTL	[Min to Max/Init./Step]
005-066	Correction			V/step]
2-005-067	Charge DC Voltage: Correction	Correction Coefficient Cg	ENG*	[-125 to 125 / 0 / 1-V/step]
2-005-068	Charge DC Voltage: Correction	Correction Coefficient Ch	ENG*	[-125 to 125 / 0 / 1-V/step]
2-005-069	Charge DC Voltage: Correction	Correction Coefficient Ci	ENG*	[-125 to 125 / 10 / 1-V/step]
2-005-070	Charge DC Voltage: Correction	Correction Coefficient Cj	ENG*	[-125 to 125 / 13 / 1-V/step]
2-005-071	Charge DC Voltage: Correction	Correction Coefficient Ck	ENG*	[-125 to 125 / 16 / 1-V/step]
2-005-072	Charge DC Voltage: Correction	Correction Coefficient Cl	ENG*	[-125 to 125 / 0 / 1-V/step]
2-005-073	Charge DC Voltage: Correction	Correction Coefficient Cm	ENG*	[-125 to 125 / 0 / 1-V/step]
2-005-074	Charge DC Voltage: Correction	Correction Coefficient Cn	ENG*	[-125 to 125 / 10 / 1-V/step]
2-005-075	Charge DC Voltage: Correction	Correction Coefficient Co	ENG*	[-125 to 125 / 13 / 1-V/step]
2-005-076	Charge DC Voltage: Correction	Correction Coefficient Cp	ENG*	[-125 to 125 / 16 / 1-V/step]
2-005-077	Charge DC Voltage: Correction	Correction Coefficient Cq	ENG*	[-125 to 125 / 0 / 1-V/step]
2-	Charge DC Voltage:	Correction Coefficient Cr	ENG*	[-125 to 125 / 0 / 1-

3.SP Mode Tables

SP No.	Large Category	Small Category	ENG or CTL	[Min to Max/Init./Step]
005-078	Correction			V/step]
2-005-079	Charge DC Voltage: Correction	Correction Coefficient Cs	ENG*	[-125 to 125 / 10 / 1-V/step]
2-005-080	Charge DC Voltage: Correction	Correction Coefficient Ct	ENG*	[-125 to 125 / 13 / 1-V/step]
2-005-081	Charge DC Voltage: Correction	Correction Coefficient Cu	ENG*	[-125 to 125 / 16 / 1-V/step]
2-005-082	Charge DC Voltage: Correction	Correction Coefficient Cv	ENG*	[-125 to 125 / 0 / 1-V/step]
2-005-083	Charge DC Voltage: Correction	Correction Coefficient Cw	ENG*	[-125 to 125 / 0 / 1-V/step]
2-005-084	Charge DC Voltage: Correction	Correction Coefficient Cx	ENG*	[-125 to 125 / 10 / 1-V/step]
2-005-085	Charge DC Voltage: Correction	Correction Coefficient Cy	ENG*	[-125 to 125 / 13 / 1-V/step]
2-005-086	Charge DC Voltage: Correction	Correction Coefficient Cz	ENG*	[-125 to 125 / 16 / 1-V/step]
2-005-087	Charge DC Voltage: Correction	Correction Coefficient CAA	ENG*	[-125 to 125 / 0 / 1-V/step]
2-005-088	Charge DC Voltage: Correction	Correction Coefficient CAB	ENG*	[-125 to 125 / 0 / 1-V/step]
2-005-089	Charge DC Voltage: Correction	Correction Coefficient Cd	ENG*	[-125 to 125 / 10 / 1-V/step]
2-	Charge DC Voltage:	Correction Coefficient Ce	ENG*	[-125 to 125 / 13 / 1-

3.SP Mode Tables

SP No.	Large Category	Small Category	ENG or CTL	[Min to Max/Init./Step]
005-090	Correction			V/step]
2-005-091	Charge DC Voltage: Correction	Correction Coefficient Cf	ENG*	[-125 to 125 / 16 / 1-V/step]
2-005-092	Charge DC Voltage: Correction	Correction Coefficient Cg	ENG*	[-125 to 125 / 0 / 1-V/step]
2-005-093	Charge DC Voltage: Correction	Correction Coefficient Ch	ENG*	[-125 to 125 / 0 / 1-V/step]
2-005-094	Charge DC Voltage: Correction	Correction Coefficient Ci	ENG*	[-125 to 125 / 10 / 1-V/step]
2-005-095	Charge DC Voltage: Correction	Correction Coefficient Cj	ENG*	[-125 to 125 / 13 / 1-V/step]
2-005-096	Charge DC Voltage: Correction	Correction Coefficient Ck	ENG*	[-125 to 125 / 16 / 1-V/step]
2-005-097	Charge DC Voltage: Correction	Correction Coefficient Cl	ENG*	[-125 to 125 / 0 / 1-V/step]
2-005-098	Charge DC Voltage: Correction	Correction Coefficient Cm	ENG*	[-125 to 125 / 0 / 1-V/step]
2-005-099	Charge DC Voltage: Correction	Correction Coefficient Cn	ENG*	[-125 to 125 / 10 / 1-V/step]
2-005-100	Charge DC Voltage: Correction	Correction Coefficient Co	ENG*	[-125 to 125 / 13 / 1-V/step]
2-005-101	Charge DC Voltage: Correction	Correction Coefficient Cp	ENG*	[-125 to 125 / 16 / 1-V/step]
2-	Charge DC Voltage:	Correction Coefficient Cq	ENG*	[-125 to 125 / 0 / 1-

SP No.	Large Category	Small Category	ENG or CTL	[Min to Max/Init./Step]
005-102	Correction			V/step]
2-005-103	Charge DC Voltage: Correction	Correction Coefficient Cr	ENG*	[-125 to 125 / 0 / 1-V/step]
2-005-104	Charge DC Voltage: Correction	Correction Coefficient Cs	ENG*	[-125 to 125 / 10 / 1-V/step]
2-005-105	Charge DC Voltage: Correction	Correction Coefficient Ct	ENG*	[-125 to 125 / 13 / 1-V/step]
2-005-106	Charge DC Voltage: Correction	Correction Coefficient Cu	ENG*	[-125 to 125 / 16 / 1-V/step]
2-005-107	Charge DC Voltage: Correction	Correction Coefficient Cv	ENG*	[-125 to 125 / 0 / 1-V/step]
2-005-108	Charge DC Voltage: Correction	Correction Coefficient Cw	ENG*	[-125 to 125 / 0 / 1-V/step]
2-005-109	Charge DC Voltage: Correction	Correction Coefficient Cx	ENG*	[-125 to 125 / 10 / 1-V/step]
2-005-110	Charge DC Voltage: Correction	Correction Coefficient Cy	ENG*	[-125 to 125 / 13 / 1-V/step]
2-005-111	Charge DC Voltage: Correction	Correction Coefficient Cz	ENG*	[-125 to 125 / 16 / 1-V/step]
2-005-112	Charge DC Voltage: Correction	Correction Coefficient CAA	ENG*	[-125 to 125 / 0 / 1-V/step]
2-005-113	Charge DC Voltage: Correction	Correction Coefficient CAB	ENG*	[-125 to 125 / 0 / 1-V/step]
2-	Charge DC Voltage:	Correction Coefficient Md	ENG*	[-125 to 125 / 10 / 1-

3.SP Mode Tables

SP No.	Large Category	Small Category	ENG or CTL	[Min to Max/Init./Step]
005-114	Correction			V/step]
2-005-115	Charge DC Voltage: Correction	Correction Coefficient Me	ENG*	[-125 to 125 / 13 / 1-V/step]
2-005-116	Charge DC Voltage: Correction	Correction Coefficient Mf	ENG*	[-125 to 125 / 16 / 1-V/step]
2-005-117	Charge DC Voltage: Correction	Correction Coefficient Mg	ENG*	[-125 to 125 / 0 / 1-V/step]
2-005-118	Charge DC Voltage: Correction	Correction Coefficient Mh	ENG*	[-125 to 125 / 0 / 1-V/step]
2-005-119	Charge DC Voltage: Correction	Correction Coefficient Mi	ENG*	[-125 to 125 / 10 / 1-V/step]
2-005-120	Charge DC Voltage: Correction	Correction Coefficient Mj	ENG*	[-125 to 125 / 13 / 1-V/step]
2-005-121	Charge DC Voltage: Correction	Correction Coefficient Mk	ENG*	[-125 to 125 / 16 / 1-V/step]
2-005-122	Charge DC Voltage: Correction	Correction Coefficient Ml	ENG*	[-125 to 125 / 0 / 1-V/step]
2-005-123	Charge DC Voltage: Correction	Correction Coefficient Mm	ENG*	[-125 to 125 / 0 / 1-V/step]
2-005-124	Charge DC Voltage: Correction	Correction Coefficient Mn	ENG*	[-125 to 125 / 10 / 1-V/step]
2-005-125	Charge DC Voltage: Correction	Correction Coefficient Mo	ENG*	[-125 to 125 / 13 / 1-V/step]
2-	Charge DC Voltage:	Correction Coefficient Mp	ENG*	[-125 to 125 / 16 / 1-

3.SP Mode Tables

SP No.	Large Category	Small Category	ENG or CTL	[Min to Max/Init./Step]
005-126	Correction			V/step]
2-005-127	Charge DC Voltage: Correction	Correction Coefficient Mq	ENG*	[-125 to 125 / 0 / 1-V/step]
2-005-128	Charge DC Voltage: Correction	Correction Coefficient Mr	ENG*	[-125 to 125 / 0 / 1-V/step]
2-005-129	Charge DC Voltage: Correction	Correction Coefficient Ms	ENG*	[-125 to 125 / 10 / 1-V/step]
2-005-130	Charge DC Voltage: Correction	Correction Coefficient Mt	ENG*	[-125 to 125 / 13 / 1-V/step]
2-005-131	Charge DC Voltage: Correction	Correction Coefficient Mu	ENG*	[-125 to 125 / 16 / 1-V/step]
2-005-132	Charge DC Voltage: Correction	Correction Coefficient Mv	ENG*	[-125 to 125 / 0 / 1-V/step]
2-005-133	Charge DC Voltage: Correction	Correction Coefficient Mw	ENG*	[-125 to 125 / 0 / 1-V/step]
2-005-134	Charge DC Voltage: Correction	Correction Coefficient Mx	ENG*	[-125 to 125 / 10 / 1-V/step]
2-005-135	Charge DC Voltage: Correction	Correction Coefficient My	ENG*	[-125 to 125 / 13 / 1-V/step]
2-005-136	Charge DC Voltage: Correction	Correction Coefficient Mz	ENG*	[-125 to 125 / 16 / 1-V/step]
2-005-137	Charge DC Voltage: Correction	Correction Coefficient MAA	ENG*	[-125 to 125 / 0 / 1-V/step]
2-	Charge DC Voltage:	Correction Coefficient MAB	ENG*	[-125 to 125 / 0 / 1-

3.SP Mode Tables

SP No.	Large Category	Small Category	ENG or CTL	[Min to Max/Init./Step]
005-138	Correction			V/step]
2-005-139	Charge DC Voltage: Correction	Correction Coefficient Yd	ENG*	[-125 to 125 / 10 / 1-V/step]
2-005-140	Charge DC Voltage: Correction	Correction Coefficient Ye	ENG*	[-125 to 125 / 13 / 1-V/step]
2-005-141	Charge DC Voltage: Correction	Correction Coefficient Yf	ENG*	[-125 to 125 / 16 / 1-V/step]
2-005-142	Charge DC Voltage: Correction	Correction Coefficient Yg	ENG*	[-125 to 125 / 0 / 1-V/step]
2-005-143	Charge DC Voltage: Correction	Correction Coefficient Yh	ENG*	[-125 to 125 / 0 / 1-V/step]
2-005-144	Charge DC Voltage: Correction	Correction Coefficient Yi	ENG*	[-125 to 125 / 10 / 1-V/step]
2-005-145	Charge DC Voltage: Correction	Correction Coefficient Yj	ENG*	[-125 to 125 / 13 / 1-V/step]
2-005-146	Charge DC Voltage: Correction	Correction Coefficient Yk	ENG*	[-125 to 125 / 16 / 1-V/step]
2-005-147	Charge DC Voltage: Correction	Correction Coefficient Yl	ENG*	[-125 to 125 / 0 / 1-V/step]
2-005-148	Charge DC Voltage: Correction	Correction Coefficient Ym	ENG*	[-125 to 125 / 0 / 1-V/step]
2-005-149	Charge DC Voltage: Correction	Correction Coefficient Yn	ENG*	[-125 to 125 / 10 / 1-V/step]
2-	Charge DC Voltage:	Correction Coefficient Yo	ENG*	[-125 to 125 / 13 / 1-

SP No.	Large Category	Small Category	ENG or CTL	[Min to Max/Init./Step]
005-150	Correction			V/step]
2-005-151	Charge DC Voltage: Correction	Correction Coefficient Yp	ENG*	[-125 to 125 / 16 / 1-V/step]
2-005-152	Charge DC Voltage: Correction	Correction Coefficient Yq	ENG*	[-125 to 125 / 0 / 1-V/step]
2-005-153	Charge DC Voltage: Correction	Correction Coefficient Yr	ENG*	[-125 to 125 / 0 / 1-V/step]
2-005-154	Charge DC Voltage: Correction	Correction Coefficient Ys	ENG*	[-125 to 125 / 10 / 1-V/step]
2-005-155	Charge DC Voltage: Correction	Correction Coefficient Yt	ENG*	[-125 to 125 / 13 / 1-V/step]
2-005-156	Charge DC Voltage: Correction	Correction Coefficient Yu	ENG*	[-125 to 125 / 16 / 1-V/step]
2-005-157	Charge DC Voltage: Correction	Correction Coefficient Yv	ENG*	[-125 to 125 / 0 / 1-V/step]
2-005-158	Charge DC Voltage: Correction	Correction Coefficient Yw	ENG*	[-125 to 125 / 0 / 1-V/step]
2-005-159	Charge DC Voltage: Correction	Correction Coefficient Yx	ENG*	[-125 to 125 / 10 / 1-V/step]
2-005-160	Charge DC Voltage: Correction	Correction Coefficient Yy	ENG*	[-125 to 125 / 13 / 1-V/step]
2-005-161	Charge DC Voltage: Correction	Correction Coefficient Yz	ENG*	[-125 to 125 / 16 / 1-V/step]
2-	Charge DC Voltage:	Correction Coefficient YAA	ENG*	[-125 to 125 / 0 / 1-

3.SP Mode Tables

SP No.	Large Category	Small Category	ENG or CTL	[Min to Max/Init./Step]
005-162	Correction			V/step]
2-005-163	Charge DC Voltage: Correction	Correction Coefficient YAB	ENG*	[-125 to 125 / 0 / 1- V/step]
2-005-164	Charge DC Voltage: Correction	Correction Coefficient b1: K	ENG*	[-300 to 300 / 0 / 1-/step]
2-005-165	Charge DC Voltage: Correction	Correction Coefficient b1: C	ENG*	[-300 to 300 / 0 / 1-/step]
2-005-166	Charge DC Voltage: Correction	Correction Coefficient b1: M	ENG*	[-300 to 300 / 0 / 1-/step]
2-005-167	Charge DC Voltage: Correction	Correction Coefficient b1: Y	ENG*	[-300 to 300 / 0 / 1-/step]
2-005-168	Charge DC Voltage: Correction	Temperature Threshold	ENG*	[1 to 99 / 20 / 1-/step]
2-005-169	Charge DC Voltage: Correction	Environmental Target Temperature	ENG*	[-10.0 to 70.0 / 20.0 / 0.1-/step]
2-005-170	Charge DC Voltage: Correction	Temp PCU: K	ENG*	[-10.0 to 70.0 / 20.0 / 0.1-/step]
2-005-171	Charge DC Voltage: Correction	Temp PCU: C	ENG*	[-10.0 to 70.0 / 20.0 / 0.1-/step]
2-005-172	Charge DC Voltage: Correction	Temp PCU: M	ENG*	[-10.0 to 70.0 / 20.0 / 0.1-/step]
2-005-173	Charge DC Voltage: Correction	Temp PCU: Y	ENG*	[-10.0 to 70.0 / 20.0 / 0.1-/step]
2-	Charge DC Voltage:	Temp Charge R: K	ENG*	[0 to 9999 / 0 / 1-/step]

3.SP Mode Tables

SP No.	Large Category	Small Category	ENG or CTL	[Min to Max/Init./Step]
005-174	Correction			
2-005-175	Charge DC Voltage: Correction	Temp Charge R: C	ENG*	[0 to 9999 / 0 / 1-/step]
2-005-176	Charge DC Voltage: Correction	Temp Charge R: M	ENG*	[0 to 9999 / 0 / 1-/step]
2-005-177	Charge DC Voltage: Correction	Temp Charge R: Y	ENG*	[0 to 9999 / 0 / 1-/step]
2-005-178	Charge DC Voltage: Correction	Correction Temp Charge R: K	ENG*	[-99 to 99 / 0 / 1-V/step]
2-005-179	Charge DC Voltage: Correction	Correction Temp Charge R: C	ENG*	[-99 to 99 / 0 / 1-V/step]
2-005-180	Charge DC Voltage: Correction	Correction Temp Charge R: M	ENG*	[-99 to 99 / 0 / 1-V/step]
2-005-181	Charge DC Voltage: Correction	Correction Temp Charge R: Y	ENG*	[-99 to 99 / 0 / 1-V/step]
2-005-182	Charge DC Voltage: Correction	Correction Coefficient bb: K	ENG*	[0.000 to 1.000 / 0.100 / 0.001-/step]
2-005-183	Charge DC Voltage: Correction	Correction Coefficient bb: C	ENG*	[0.000 to 1.000 / 0.100 / 0.001-/step]
2-005-184	Charge DC Voltage: Correction	Correction Coefficient bb: M	ENG*	[0.000 to 1.000 / 0.100 / 0.001-/step]
2-005-185	Charge DC Voltage: Correction	Correction Coefficient bb: Y	ENG*	[0.000 to 1.000 / 0.100 / 0.001-/step]
2-	Charge DC Voltage:	Correction Coefficient dd1	ENG*	[0.00 to 2.00 / 1.00 /

3.SP Mode Tables

SP No.	Large Category	Small Category	ENG or CTL	[Min to Max/Init./Step]
005-186	Correction			0.01-/step]
2-005-187	Charge DC Voltage: Correction	Correction Coefficient dd1	ENG*	[0.00 to 2.00 / 1.00 / 0.01-/step]
2-005-188	Charge DC Voltage: Correction	Correction Coefficient dd3	ENG*	[0.00 to 2.00 / 1.00 / 0.01-/step]
2-005-189	Charge DC Voltage: Correction	Correction Coefficient dd4	ENG*	[0.00 to 2.00 / 1.00 / 0.01-/step]
2-005-190	Charge DC Voltage: Correction	JOB DotCoverage:K	ENG*	[0.00 to 100.00 / 0.00 / 0.01%/step]
2-005-191	Charge DC Voltage: Correction	JOB DotCoverage:C	ENG*	[0.00 to 100.00 / 0.00 / 0.01%/step]
2-005-192	Charge DC Voltage: Correction	JOB DotCoverage:M	ENG*	[0.00 to 100.00 / 0.00 / 0.01%/step]
2-005-193	Charge DC Voltage: Correction	JOB DotCoverage:Y	ENG*	[0.00 to 100.00 / 0.00 / 0.01%/step]
2-005-194	Charge DC Voltage: Correction	Correction Coefficient cc: K	ENG*	[0.00 to 9.00 / 0.80 / 0.01-/step]
2-005-195	Charge DC Voltage: Correction	Correction Coefficient cc: C	ENG*	[0.00 to 9.00 / 0.80 / 0.01-/step]
2-005-196	Charge DC Voltage: Correction	Correction Coefficient cc: M	ENG*	[0.00 to 9.00 / 0.80 / 0.01-/step]
2-005-197	Charge DC Voltage: Correction	Correction Coefficient cc: Y	ENG*	[0.00 to 9.00 / 0.80 / 0.01-/step]
2-	Charge DC Voltage:	Temp Difference	ENG*	[-80.0 to 80.0 / 0.0 / 0.1-

3.SP Mode Tables

SP No.	Large Category	Small Category	ENG or CTL	[Min to Max/Init./Step]
005-198	Correction			/step]
2-005-199	Charge DC Voltage: Correction	Correction Coefficient b2: K	ENG*	[-99 to 99 / 0 / 1-V/step]
2-005-200	Charge DC Voltage: Correction	Correction Coefficient b2: C	ENG*	[-99 to 99 / 0 / 1-V/step]
2-005-201	Charge DC Voltage: Correction	Correction Coefficient b2: M	ENG*	[-99 to 99 / 0 / 1-V/step]
2-005-202	Charge DC Voltage: Correction	Correction Coefficient b2: Y	ENG*	[-99 to 99 / 0 / 1-V/step]
2-005-203	Charge DC Voltage: Correction	Correction Coefficient ee: K	ENG*	[0.0 to 10.0 / 0.0 / 0.1- /step]
2-005-204	Charge DC Voltage: Correction	Correction Coefficient ee: C	ENG*	[0.0 to 10.0 / 0.0 / 0.1- /step]
2-005-205	Charge DC Voltage: Correction	Correction Coefficient ee: M	ENG*	[0.0 to 10.0 / 0.0 / 0.1- /step]
2-005-206	Charge DC Voltage: Correction	Correction Coefficient ee: Y	ENG*	[0.0 to 10.0 / 0.0 / 0.1- /step]
2-005-207	Charge DC Voltage: Correction	Correction Coefficient b3: K	ENG*	[-99 to 99 / 0 / 1-V/step]
2-005-208	Charge DC Voltage: Correction	Correction Coefficient b3: C	ENG*	[-99 to 99 / 0 / 1-V/step]
2-005-209	Charge DC Voltage: Correction	Correction Coefficient b3: M	ENG*	[-99 to 99 / 0 / 1-V/step]
2-	Charge DC Voltage:	Correction Coefficient b3: Y	ENG*	[-99 to 99 / 0 / 1-V/step]

3.SP Mode Tables

SP No.	Large Category	Small Category	ENG or CTL	[Min to Max/Init./Step]
005-210	Correction			
2-005-211	Charge DC Voltage: Correction	Correction Coefficient gg: K	ENG*	[0.00 to 9.00 / 0.68 / 0.01-/step]
2-005-212	Charge DC Voltage: Correction	Correction Coefficient gg: C	ENG*	[0.00 to 9.00 / 0.68 / 0.01-/step]
2-005-213	Charge DC Voltage: Correction	Correction Coefficient gg: M	ENG*	[0.00 to 9.00 / 0.68 / 0.01-/step]
2-005-214	Charge DC Voltage: Correction	Correction Coefficient gg: Y	ENG*	[0.00 to 9.00 / 0.68 / 0.01-/step]
2-005-215	Charge DC Voltage: Correction	Correction Coefficient hh1: K	ENG*	[0.00 to 9.00 / 1.00 / 0.01-/step]
2-005-216	Charge DC Voltage: Correction	Correction Coefficient hh1: C	ENG*	[0.00 to 9.00 / 1.00 / 0.01-/step]
2-005-217	Charge DC Voltage: Correction	Correction Coefficient hh1: M	ENG*	[0.00 to 9.00 / 1.00 / 0.01-/step]
2-005-218	Charge DC Voltage: Correction	Correction Coefficient hh1: Y	ENG*	[0.00 to 9.00 / 1.00 / 0.01-/step]
2-005-219	Charge DC Voltage: Correction	Correction Coefficient hh2: K	ENG*	[0.00 to 9.00 / 1.00 / 0.01-/step]
2-005-220	Charge DC Voltage: Correction	Correction Coefficient hh2: C	ENG*	[0.00 to 9.00 / 1.00 / 0.01-/step]
2-005-221	Charge DC Voltage: Correction	Correction Coefficient hh2: M	ENG*	[0.00 to 9.00 / 1.00 / 0.01-/step]
2-	Charge DC Voltage:	Correction Coefficient hh2:	ENG*	[0.00 to 9.00 / 1.00 /

3.SP Mode Tables

SP No.	Large Category	Small Category	ENG or CTL	[Min to Max/Init./Step]
005-222	Correction	Y		0.01-/step]
2-005-223	Charge DC Voltage: Correction	Correction Coefficient hh3: K	ENG*	[0.00 to 9.00 / 1.00 / 0.01-/step]
2-005-224	Charge DC Voltage: Correction	Correction Coefficient hh3: C	ENG*	[0.00 to 9.00 / 1.00 / 0.01-/step]
2-005-225	Charge DC Voltage: Correction	Correction Coefficient hh3: M	ENG*	[0.00 to 9.00 / 1.00 / 0.01-/step]
2-005-226	Charge DC Voltage: Correction	Correction Coefficient hh3: Y	ENG*	[0.00 to 9.00 / 1.00 / 0.01-/step]
2-005-227	Charge DC Voltage: Correction	Correction Coefficient hh4: K	ENG*	[0.00 to 9.00 / 1.00 / 0.01-/step]
2-005-228	Charge DC Voltage: Correction	Correction Coefficient hh4: C	ENG*	[0.00 to 9.00 / 1.00 / 0.01-/step]
2-005-229	Charge DC Voltage: Correction	Correction Coefficient hh4: M	ENG*	[0.00 to 9.00 / 1.00 / 0.01-/step]
2-005-230	Charge DC Voltage: Correction	Correction Coefficient hh4: Y	ENG*	[0.00 to 9.00 / 1.00 / 0.01-/step]
2-005-231	Charge DC Voltage: Correction	Correction Coefficient b0: K	ENG*	[0 to 2000 / 714 / 1-/step]
2-005-232	Charge DC Voltage: Correction	Correction Coefficient b0: C	ENG*	[0 to 2000 / 714 / 1-/step]
2-005-233	Charge DC Voltage: Correction	Correction Coefficient b0: M	ENG*	[0 to 2000 / 714 / 1-/step]
2-	Charge DC Voltage:	Correction Coefficient b0: Y	ENG*	[0 to 2000 / 714 / 1-

3.SP Mode Tables

SP No.	Large Category	Small Category	ENG or CTL	[Min to Max/Init./Step]
005-234	Correction			/step]
2-005-235	Charge DC Voltage: Correction	Correction Coefficient c1: K	ENG*	[-80 to 80 / 0 / 1-/step]
2-005-236	Charge DC Voltage: Correction	Correction Coefficient c1: C	ENG*	[-80 to 80 / 0 / 1-/step]
2-005-237	Charge DC Voltage: Correction	Correction Coefficient c1: M	ENG*	[-80 to 80 / 0 / 1-/step]
2-005-238	Charge DC Voltage: Correction	Correction Coefficient c1: Y	ENG*	[-80 to 80 / 0 / 1-/step]
2-005-239	Charge DC Voltage: Correction	Correction Coefficient c2: K	ENG*	[-20 to 20 / 0 / 1-/step]
2-005-240	Charge DC Voltage: Correction	Correction Coefficient c2: C	ENG*	[-20 to 20 / 0 / 1-/step]
2-005-241	Charge DC Voltage: Correction	Correction Coefficient c2: M	ENG*	[-20 to 20 / 0 / 1-/step]
2-005-242	Charge DC Voltage: Correction	Correction Coefficient c2: Y	ENG*	[-20 to 20 / 0 / 1-/step]
2-005-243	Charge DC Voltage: Correction	Rotation At Prev Correction: VdVc: Bk	ENG*	[0 to 999999999 / 0 / 1mm/step]
2-005-244	Charge DC Voltage: Correction	Rotation At Prev Correction: VdVc: C	ENG*	[0 to 999999999 / 0 / 1mm/step]
2-005-245	Charge DC Voltage: Correction	Rotation At Prev Correction: VdVc: M	ENG*	[0 to 999999999 / 0 / 1mm/step]
2-	Charge DC Voltage:	Rotation At Prev	ENG*	[0 to 999999999 / 0 /

3.SP Mode Tables

SP No.	Large Category	Small Category	ENG or CTL	[Min to Max/Init./Step]
005-246	Correction	Correction: VdVc: Y		1mm/step]
2-005-247	Charge DC Voltage: Correction	Correction Coefficient b2: Fixed K	ENG*	[-99 to 99 / 0 / 1-V/step]
2-005-248	Charge DC Voltage: Correction	Correction Coefficient b2: Fixed C	ENG*	[-99 to 99 / 0 / 1-V/step]
2-005-249	Charge DC Voltage: Correction	Correction Coefficient b2: Fixed M	ENG*	[-99 to 99 / 0 / 1-V/step]
2-005-250	Charge DC Voltage: Correction	Correction Coefficient b2: Fixed Y	ENG*	[-99 to 99 / 0 / 1-V/step]
2-006-001	Charge AC Voltage: Fixed	Standard Speed: K	ENG*	[0.00 to 3.00 / 2.20 / 0.01kV/step]
2-006-002	Charge AC Voltage: Fixed	Standard Speed: C	ENG*	[0.00 to 3.00 / 2.20 / 0.01kV/step]
2-006-003	Charge AC Voltage: Fixed	Standard Speed: M	ENG*	[0.00 to 3.00 / 2.20 / 0.01kV/step]
2-006-004	Charge AC Voltage: Fixed	Standard Speed: Y	ENG*	[0.00 to 3.00 / 2.20 / 0.01kV/step]
2-006-005	Charge AC Voltage: Fixed	Middle Speed: K	ENG*	[0.00 to 3.00 / 2.20 / 0.01kV/step]
2-006-006	Charge AC Voltage: Fixed	Middle Speed: C	ENG*	[0.00 to 3.00 / 2.20 / 0.01kV/step]
2-006-007	Charge AC Voltage: Fixed	Middle Speed: M	ENG*	[0.00 to 3.00 / 2.20 / 0.01kV/step]
2-	Charge AC Voltage:	Middle Speed: Y	ENG*	[0.00 to 3.00 / 2.20 /

3.SP Mode Tables

SP No.	Large Category	Small Category	ENG or CTL	[Min to Max/Init./Step]
006-008	Fixed			0.01kV/step]
2-006-009	Charge AC Voltage: Fixed	Low Speed: K	ENG*	[0.00 to 3.00 / 2.20 / 0.01kV/step]
2-006-010	Charge AC Voltage: Fixed	Low Speed: C	ENG*	[0.00 to 3.00 / 2.20 / 0.01kV/step]
2-006-011	Charge AC Voltage: Fixed	Low Speed: M	ENG*	[0.00 to 3.00 / 2.20 / 0.01kV/step]
2-006-012	Charge AC Voltage: Fixed	Low Speed: Y	ENG*	[0.00 to 3.00 / 2.20 / 0.01kV/step]
2-007-001	Charge AC Current: LL	Environmental Target: Bk	ENG*	[0.00 to 3.00 / 0.81 / 0.01mA/step]
2-007-002	Charge AC Current: LL	Environmental Target: C	ENG*	[0.00 to 3.00 / 0.81 / 0.01mA/step]
2-007-003	Charge AC Current: LL	Environmental Target: M	ENG*	[0.00 to 3.00 / 0.81 / 0.01mA/step]
2-007-004	Charge AC Current: LL	Environmental Target: Y	ENG*	[0.00 to 3.00 / 0.81 / 0.01mA/step]
2-008-001	Charge AC Current: ML	Environmental Target: Bk	ENG*	[0.00 to 3.00 / 0.81 / 0.01mA/step]
2-008-002	Charge AC Current: ML	Environmental Target: C	ENG*	[0.00 to 3.00 / 0.81 / 0.01mA/step]
2-008-003	Charge AC Current: ML	Environmental Target: M	ENG*	[0.00 to 3.00 / 0.81 / 0.01mA/step]
2-	Charge AC Current: ML	Environmental Target: Y	ENG*	[0.00 to 3.00 / 0.81 /

3.SP Mode Tables

SP No.	Large Category	Small Category	ENG or CTL	[Min to Max/Init./Step]
008-004				0.01mA/step]
2-009-001	Charge AC Current: MM	Environmental Target: Bk	ENG*	[0.00 to 3.00 / 0.81 / 0.01mA/step]
2-009-002	Charge AC Current: MM	Environmental Target: C	ENG*	[0.00 to 3.00 / 0.81 / 0.01mA/step]
2-009-003	Charge AC Current: MM	Environmental Target: M	ENG*	[0.00 to 3.00 / 0.81 / 0.01mA/step]
2-009-004	Charge AC Current: MM	Environmental Target: Y	ENG*	[0.00 to 3.00 / 0.81 / 0.01mA/step]
2-010-001	Charge AC Current: MH	Environmental Target: Bk	ENG*	[0.00 to 3.00 / 0.83 / 0.01mA/step]
2-010-002	Charge AC Current: MH	Environmental Target: C	ENG*	[0.00 to 3.00 / 0.83 / 0.01mA/step]
2-010-003	Charge AC Current: MH	Environmental Target: M	ENG*	[0.00 to 3.00 / 0.83 / 0.01mA/step]
2-010-004	Charge AC Current: MH	Environmental Target: Y	ENG*	[0.00 to 3.00 / 0.83 / 0.01mA/step]
2-011-001	Charge AC Current: HH	Environmental Target: Bk	ENG*	[0.00 to 3.00 / 0.86 / 0.01mA/step]
2-011-002	Charge AC Current: HH	Environmental Target: C	ENG*	[0.00 to 3.00 / 0.86 / 0.01mA/step]
2-011-003	Charge AC Current: HH	Environmental Target: M	ENG*	[0.00 to 3.00 / 0.86 / 0.01mA/step]
2-	Charge AC Current: HH	Environmental Target: Y	ENG*	[0.00 to 3.00 / 0.86 /

3.SP Mode Tables

SP No.	Large Category	Small Category	ENG or CTL	[Min to Max/Init./Step]
011-004				0.01mA/step]
2-012-001	Charge Output Control	AC Voltage	ENG*	[0 to 1 / 0 / 1-/step]
2-013-001	Environmental Correction: PCU	Current Environmental FC : Display	ENG*	[0 to 0 / 0 / 1/step]
2-013-002	Environmental Correction: PCU	Forced Setting	ENG*	[0 to 5 / 0 / 1-/step]
2-013-003	Environmental Correction: PCU	Absolute Humidity: Threshold 1	ENG*	[0.00 to 100.00 / 3.00 / 0.01g/m ³ /step]
2-013-004	Environmental Correction: PCU	Absolute Humidity: Threshold 2	ENG*	[0.00 to 100.00 / 8.00 / 0.01g/m ³ /step]
2-013-005	Environmental Correction: PCU	Absolute Humidity: Threshold 3	ENG*	[0.00 to 100.00 / 15.00 / 0.01g/m ³ /step]
2-013-006	Environmental Correction: PCU	Absolute Humidity: Threshold 4	ENG*	[0.00 to 100.00 / 22.00 / 0.01g/m ³ /step]
2-013-007	Environmental Correction: PCU	Temp FC: Display	ENG*	[0 to 100 / 0 / 1deg/step]
2-013-008	Environmental Correction: PCU	Relative Humidity FC : Display	ENG*	[0 to 100 / 0 / 1%RH/step]
2-013-009	Environmental Correction: PCU	Absolute Humidity FC : Display	ENG*	[0.00 to 100.00 / 0.00 / 0.01g/m ³ /step]
2-013-010	Environmental Correction: PCU	Environmental Bk: Display	ENG*	[0 to 0 / 0 / 1/step]
2-	Environmental	Temp Bk.: Display	ENG*	[0 to 100 / 0 / 1deg/step]

3.SP Mode Tables

SP No.	Large Category	Small Category	ENG or CTL	[Min to Max/Init./Step]
013-011	Correction: PCU			
2-013-012	Environmental Correction: PCU	Relative Humidity Bk : Display	ENG*	[0 to 100 / 0 / 1%RH/step]
2-013-013	Environmental Correction: PCU	Absolute Humidity Bk : Display	ENG*	[0.00 to 100.00 / 0.00 / 0.01g/m ³ /step]
2-014-001	Charge AC Control: Setting	Exec Interval: Power ON	ENG*	[0 to 2000 / 500 / 1page/step]
2-014-002	Charge AC Control: Setting	Exec Interval: Print	ENG*	[0 to 2000 / 0 / 1page/step]
2-014-003	Charge AC Control: Setting	Page Interval	ENG*	[0 to 500 / 10 / 1page/step]
2-014-004	Charge AC Control: Setting	Temperature	ENG*	[0 to 99 / 35 / 1deg/step]
2-014-005	Charge AC Control: Setting	Relative Humidity	ENG*	[0 to 99 / 50 / 1%RH/step]
2-014-006	Charge AC Control: Setting	Absolute Humidity	ENG*	[0 to 99 / 12 / 1g/m ³ /step]
2-014-007	Charge AC Control: Setting	Temp Threshold M	ENG*	[0 to 99 / 10 / 1deg/step]
2-014-008	Charge AC Control: Setting	RH Threshold M	ENG*	[0 to 99 / 50 / 1%RH/step]
2-014-009	Charge AC Control: Setting	AH Threshold M	ENG*	[0 to 99 / 6 / 1g/m ³ /step]
2-	Charge AC Control:	Temp Threshold S	ENG*	[0.0 to 20.0 / 1.0 /

3.SP Mode Tables

SP No.	Large Category	Small Category	ENG or CTL	[Min to Max/Init./Step]
014-010	Setting			0.1deg/step]
2-014-011	Charge AC Control: Setting	RH Threshold S	ENG*	[0 to 50 / 5 / 1%RH/step]
2-014-012	Charge AC Control: Setting	AH Threshold S	ENG*	[0.0 to 20.0 / 1.0 / 0.1g/m ³ /step]
2-014-013	Charge AC Control: Setting	Non-use Time	ENG*	[0 to 1440 / 360 / 10min./step]
2-014-014	Charge AC Control: Setting	AC Current Error Detection	ENG*	[0 to 1 / 0 / 1-/step]
2-015-001	Charge AC Adj: Result	Bk	ENG*	[0 to 9 / 0 / 1/step]
2-015-002	Charge AC Adj: Result	C	ENG*	[0 to 9 / 0 / 1/step]
2-015-003	Charge AC Adj: Result	M	ENG*	[0 to 9 / 0 / 1/step]
2-015-004	Charge AC Adj: Result	Y	ENG*	[0 to 9 / 0 / 1/step]
2-020-001	Background Pot Corr. Set	Temp. Condition	ENG*	[0 to 19 / 15 / 1deg/step]
2-020-002	Background Pot Corr. Set	Absolute Humidity	ENG*	[0 to 99 / 6 / 1g/m ³ /step]
2-020-003	Background Pot Corr. Set	Print Page Counter After Corr.	ENG*	[0 to 999 / 0 / 1page/step]
2-	Background Pot Corr.	Print Pages Threshold After	ENG*	[0 to 999 / 10 /

3.SP Mode Tables

SP No.	Large Category	Small Category	ENG or CTL	[Min to Max/Init./Step]
020-004	Set	Corr.		1page/step]
2-020-005	Background Pot Corr. Set	Temp. Thresh	ENG*	[20 to 99 / 20 / 1deg/step]
2-020-011	Background Pot Corr. Set	Coeff. a: K	ENG*	[0.00 to 1.00 / 0.06 / 0.01-/step]
2-020-012	Background Pot Corr. Set	Coeff. a: C	ENG*	[0.00 to 1.00 / 0.06 / 0.01-/step]
2-020-013	Background Pot Corr. Set	Coeff. a: M	ENG*	[0.00 to 1.00 / 0.06 / 0.01-/step]
2-020-014	Background Pot Corr. Set	Coeff. a: Y	ENG*	[0.00 to 1.00 / 0.06 / 0.01-/step]
2-020-015	Background Pot Corr. Set	Coeff. b: K	ENG*	[0.00 to 9.00 / 0.50 / 0.01-/step]
2-020-016	Background Pot Corr. Set	Coeff. b: C	ENG*	[0.00 to 9.00 / 0.50 / 0.01-/step]
2-020-017	Background Pot Corr. Set	Coeff. b: M	ENG*	[0.00 to 9.00 / 0.50 / 0.01-/step]
2-020-018	Background Pot Corr. Set	Coeff. b: Y	ENG*	[0.00 to 9.00 / 0.50 / 0.01-/step]
2-021-001	Background Pot Corr.	Display: K	ENG*	[0 to 90 / 0 / 1-V/step]
2-021-002	Background Pot Corr.	Display: C	ENG*	[0 to 90 / 0 / 1-V/step]
2-	Background Pot Corr.	Display: M	ENG*	[0 to 90 / 0 / 1-V/step]

3.SP Mode Tables

SP No.	Large Category	Small Category	ENG or CTL	[Min to Max/Init./Step]
021-003				
2-021-004	Background Pot Corr.	Display: Y	ENG*	[0 to 90 / 0 / 1-V/step]
2-021-005	Background Pot Corr.	Setting 1: K	ENG*	IM C3500: [0 to 90 / 10 / 10-V/step] IM C2500: [0 to 90 / 0 / 10-V/step] IM C2000: [0 to 90 / 0 / 10-V/step] IM C3000: [0 to 90 / 10 / 10-V/step]
2-021-006	Background Pot Corr.	Setting 1: C	ENG*	IM C3500: [0 to 90 / 10 / 10-V/step] IM C2500: [0 to 90 / 0 / 10-V/step] IM C2000: [0 to 90 / 0 / 10-V/step] IM C3000: [0 to 90 / 10 / 10-V/step]
2-021-007	Background Pot Corr.	Setting 1: M	ENG*	IM C3500: [0 to 90 / 10 / 10-V/step] IM C2500: [0 to 90 / 0 / 10-V/step] IM C2000: [0 to 90 / 0 / 10-V/step] IM C3000: [0 to 90 / 10 / 10-V/step]
2-021-008	Background Pot Corr.	Setting 1: Y	ENG*	IM C3500: [0 to 90 / 10 / 10-V/step] IM C2500: [0 to 90 / 0 / 10-V/step] IM C2000: [0 to 90 / 0 / 10-V/step] IM C3000: [0 to 90 / 10 / 10-V/step]

3.SP Mode Tables

SP No.	Large Category	Small Category	ENG or CTL	[Min to Max/Init./Step]
2-021-009	Background Pot Corr.	Setting 2: K	ENG*	IM C3500: [0 to 90 / 20 / 10-V/step] IM C2500: [0 to 90 / 0 / 10-V/step] IM C2000: [0 to 90 / 0 / 10-V/step] IM C3000: [0 to 90 / 20 / 10-V/step]
2-021-010	Background Pot Corr.	Setting 2: C	ENG*	IM C3500: [0 to 90 / 20 / 10-V/step] IM C2500: [0 to 90 / 0 / 10-V/step] IM C2000: [0 to 90 / 0 / 10-V/step] IM C3000: [0 to 90 / 20 / 10-V/step]
2-021-011	Background Pot Corr.	Setting 2: M	ENG*	IM C3500: [0 to 90 / 20 / 10-V/step] IM C2500: [0 to 90 / 0 / 10-V/step] IM C2000: [0 to 90 / 0 / 10-V/step] IM C3000: [0 to 90 / 20 / 10-V/step]
2-021-012	Background Pot Corr.	Setting 2: Y	ENG*	IM C3500: [0 to 90 / 20 / 10-V/step] IM C2500: [0 to 90 / 0 / 10-V/step] IM C2000: [0 to 90 / 0 / 10-V/step] IM C3000: [0 to 90 / 20 / 10-V/step]
2-021-013	Background Pot Corr.	Setting 3: K	ENG*	IM C3500: [0 to 90 / 30 / 5-V/step] IM C2500: [0 to 90 / 0 / 5-V/step] IM C2000:

3.SP Mode Tables

SP No.	Large Category	Small Category	ENG or CTL	[Min to Max/Init./Step]
				[0 to 90 / 0 / 5-V/step] IM C3000: [0 to 90 / 30 / 5-V/step]
2-021-014	Background Pot Corr.	Setting 3: C	ENG*	IM C3500: [0 to 90 / 30 / 5-V/step] IM C2500: [0 to 90 / 0 / 5-V/step] IM C2000: [0 to 90 / 0 / 5-V/step] IM C3000: [0 to 90 / 30 / 5-V/step]
2-021-015	Background Pot Corr.	Setting 3: M	ENG*	IM C3500: [0 to 90 / 30 / 5-V/step] IM C2500: [0 to 90 / 0 / 5-V/step] IM C2000: [0 to 90 / 0 / 5-V/step] IM C3000: [0 to 90 / 30 / 5-V/step]
2-021-016	Background Pot Corr.	Setting 3: Y	ENG*	IM C3500: [0 to 90 / 30 / 5-V/step] IM C2500: [0 to 90 / 0 / 5-V/step] IM C2000: [0 to 90 / 0 / 5-V/step] IM C3000: [0 to 90 / 30 / 5-V/step]
2-021-017	Background Pot Corr.	Setting 4: K	ENG*	IM C3500: [0 to 90 / 40 / 5-V/step] IM C2500: [0 to 90 / 0 / 5-V/step] IM C2000: [0 to 90 / 0 / 5-V/step] IM C3000: [0 to 90 / 40 / 5-V/step]
2-021-	Background Pot Corr.	Setting 4: C	ENG*	IM C3500: [0 to 90 / 40 / 5-V/step]

3.SP Mode Tables

SP No.	Large Category	Small Category	ENG or CTL	[Min to Max/Init./Step]
018				IM C2500: [0 to 90 / 0 / 5-V/step] IM C2000: [0 to 90 / 0 / 5-V/step] IM C3000: [0 to 90 / 40 / 5-V/step]
2- 021- 019	Background Pot Corr.	Setting 4: M	ENG*	IM C3500: [0 to 90 / 40 / 5-V/step] IM C2500: [0 to 90 / 0 / 5-V/step] IM C2000: [0 to 90 / 0 / 5-V/step] IM C3000: [0 to 90 / 40 / 5-V/step]
2- 021- 020	Background Pot Corr.	Setting 4: Y	ENG*	IM C3500: [0 to 90 / 40 / 5-V/step] IM C2500: [0 to 90 / 0 / 5-V/step] IM C2000: [0 to 90 / 0 / 5-V/step] IM C3000: [0 to 90 / 40 / 5-V/step]
2- 021- 021	Background Pot Corr.	Setting 5: K	ENG*	IM C3500: [0 to 90 / 10 / 1-V/step] IM C2500: [0 to 90 / 0 / 1-V/step] IM C2000: [0 to 90 / 0 / 1-V/step] IM C3000: [0 to 90 / 10 / 1-V/step]
2- 021- 022	Background Pot Corr.	Setting 5: C	ENG*	IM C3500: [0 to 90 / 10 / 1-V/step] IM C2500: [0 to 90 / 0 / 1-V/step] IM C2000: [0 to 90 / 0 / 1-V/step] IM C3000: [0 to 90 / 10 / 1-V/step]

3.SP Mode Tables

SP No.	Large Category	Small Category	ENG or CTL	[Min to Max/Init./Step]
				[0 to 90 / 10 / 1-V/step]
2-021-023	Background Pot Corr.	Setting 5: M	ENG*	IM C3500: [0 to 90 / 10 / 1-V/step] IM C2500: [0 to 90 / 0 / 1-V/step] IM C2000: [0 to 90 / 0 / 1-V/step] IM C3000: [0 to 90 / 10 / 1-V/step]
2-021-024	Background Pot Corr.	Setting 5: Y	ENG*	IM C3500: [0 to 90 / 10 / 1-V/step] IM C2500: [0 to 90 / 0 / 1-V/step] IM C2000: [0 to 90 / 0 / 1-V/step] IM C3000: [0 to 90 / 10 / 1-V/step]
2-021-025	Background Pot Corr.	Setting 6: K	ENG*	[-90 to 90 / 2 / 1-V/step]
2-021-026	Background Pot Corr.	Setting 6: C	ENG*	[-90 to 90 / 2 / 1-V/step]
2-021-027	Background Pot Corr.	Setting 6: M	ENG*	[-90 to 90 / 2 / 1-V/step]
2-021-028	Background Pot Corr.	Setting 6: Y	ENG*	[-90 to 90 / 2 / 1-V/step]
2-021-029	Background Pot Corr.	Display: Energized: K	ENG*	[0 to 90 / 0 / 1-V/step]
2-021-030	Background Pot Corr.	Display: Energized: C	ENG*	[0 to 90 / 0 / 1-V/step]
2-021-	Background Pot Corr.	Display: Energized: M	ENG*	[0 to 90 / 0 / 1-V/step]

3.SP Mode Tables

SP No.	Large Category	Small Category	ENG or CTL	[Min to Max/Init./Step]
031				
2-021-032	Background Pot Corr.	Display: Energized: Y	ENG*	[0 to 90 / 0 / 1-V/step]
2-021-033	Background Pot Corr.	Display: Total Rotation: K	ENG*	[0 to 30 / 0 / 1-V/step]
2-021-034	Background Pot Corr.	Display: Total Rotation: C	ENG*	[0 to 30 / 0 / 1-V/step]
2-021-035	Background Pot Corr.	Display: Total Rotation: M	ENG*	[0 to 30 / 0 / 1-V/step]
2-021-036	Background Pot Corr.	Display: Total Rotation: Y	ENG*	[0 to 30 / 0 / 1-V/step]
2-021-037	Background Pot Corr.	Split Number n: K	ENG*	IM C3500: [1 to 99 / 10 / 1-/step] IM C2500: [1 to 99 / 12 / 1-/step] IM C2000: [1 to 99 / 12 / 1-/step] IM C3000: [1 to 99 / 10 / 1-/step]
2-021-038	Background Pot Corr.	Split Number n: C	ENG*	IM C3500: [1 to 99 / 10 / 1-/step] IM C2500: [1 to 99 / 12 / 1-/step] IM C2000: [1 to 99 / 12 / 1-/step] IM C3000: [1 to 99 / 10 / 1-/step]
2-021-039	Background Pot Corr.	Split Number n: M	ENG*	IM C3500: [1 to 99 / 10 / 1-/step] IM C2500: [1 to 99 / 12 / 1-/step] IM C2000:

3.SP Mode Tables

SP No.	Large Category	Small Category	ENG or CTL	[Min to Max/Init./Step]
				[1 to 99 / 12 / 1-/step] IM C3000: [1 to 99 / 10 / 1-/step]
2-021-040	Background Pot Corr.	Split Number n: Y	ENG*	IM C3500: [1 to 99 / 10 / 1-/step] IM C2500: [1 to 99 / 12 / 1-/step] IM C2000: [1 to 99 / 12 / 1-/step] IM C3000: [1 to 99 / 10 / 1-/step]
2-021-041	Background Pot Corr.	Display:Energized for Target Value:K	ENG*	[0 to 90 / 0 / 1-V/step]
2-021-042	Background Pot Corr.	Display:Energized for Target Value:C	ENG*	[0 to 90 / 0 / 1-V/step]
2-021-043	Background Pot Corr.	Display:Energized for Target Value:M	ENG*	[0 to 90 / 0 / 1-V/step]
2-021-044	Background Pot Corr.	Display:Energized for Target Value:Y	ENG*	[0 to 90 / 0 / 1-V/step]
2-021-045	Background Pot Corr.	Setting 7: K	ENG*	[0 to 50 / 24 / 1-V/step]
2-021-046	Background Pot Corr.	Setting 7: C	ENG*	[0 to 50 / 24 / 1-V/step]
2-021-047	Background Pot Corr.	Setting 7: M	ENG*	[0 to 50 / 24 / 1-V/step]
2-021-048	Background Pot Corr.	Setting 7: Y	ENG*	[0 to 50 / 24 / 1-V/step]
2-022-	Charge R Running Par	Display:K	ENG*	[0 to 999999 / 0 / 1-/step]

3.SP Mode Tables

SP No.	Large Category	Small Category	ENG or CTL	[Min to Max/Init./Step]
001				
2-022-002	Charge R Running Par	Display:C	ENG*	[0 to 999999 / 0 / 1- /step]
2-022-003	Charge R Running Par	Display:M	ENG*	[0 to 999999 / 0 / 1- /step]
2-022-004	Charge R Running Par	Display:Y	ENG*	[0 to 999999 / 0 / 1- /step]
2-022-005	Charge R Running Par	PCU Rotation Time After Correction: K	ENG*	[0 to 9999999 / 0 / 1- /step]
2-022-006	Charge R Running Par	PCU Rotation Time After Correction: C	ENG*	[0 to 9999999 / 0 / 1- /step]
2-022-007	Charge R Running Par	PCU Rotation Time After Correction: M	ENG*	[0 to 9999999 / 0 / 1- /step]
2-022-008	Charge R Running Par	PCU Rotation Time After Correction: Y	ENG*	[0 to 9999999 / 0 / 1- /step]
2-022-009	Charge R Running Par	Threshold1:K	ENG*	[0 to 4000 / 30 / 1-/step]
2-022-010	Charge R Running Par	Threshold1:C	ENG*	[0 to 4000 / 30 / 1-/step]
2-022-011	Charge R Running Par	Threshold1:M	ENG*	[0 to 4000 / 30 / 1-/step]
2-022-012	Charge R Running Par	Threshold1:Y	ENG*	[0 to 4000 / 30 / 1-/step]
2-022-	Charge R Running Par	Threshold2:K	ENG*	[0 to 4000 / 70 / 1-/step]

3.SP Mode Tables

SP No.	Large Category	Small Category	ENG or CTL	[Min to Max/Init./Step]
013				
2-022-014	Charge R Running Par	Threshold2:C	ENG*	[0 to 4000 / 70 / 1-/step]
2-022-015	Charge R Running Par	Threshold2:M	ENG*	[0 to 4000 / 70 / 1-/step]
2-022-016	Charge R Running Par	Threshold2:Y	ENG*	[0 to 4000 / 70 / 1-/step]
2-022-017	Charge R Running Par	Threshold3:K	ENG*	[0 to 4000 / 150 / 1-/step]
2-022-018	Charge R Running Par	Threshold3:C	ENG*	[0 to 4000 / 150 / 1-/step]
2-022-019	Charge R Running Par	Threshold3:M	ENG*	[0 to 4000 / 150 / 1-/step]
2-022-020	Charge R Running Par	Threshold3:Y	ENG*	[0 to 4000 / 150 / 1-/step]
2-022-021	Charge R Running Par	Threshold4:K	ENG*	[0 to 4000 / 250 / 1-/step]
2-022-022	Charge R Running Par	Threshold4:C	ENG*	[0 to 4000 / 250 / 1-/step]
2-022-023	Charge R Running Par	Threshold4:M	ENG*	[0 to 4000 / 250 / 1-/step]
2-022-024	Charge R Running Par	Threshold4:Y	ENG*	[0 to 4000 / 250 / 1-/step]
2-022-	Charge R Running Par	Prev Correction Calculation Bk:Year	ENG*	[0 to 99 / 0 / 1year/step]

3.SP Mode Tables

SP No.	Large Category	Small Category	ENG or CTL	[Min to Max/Init./Step]
025				
2-022-026	Charge R Running Par	Prev Correction Calculation Bk:Month	ENG*	[1 to 12 / 1 / 1month/step]
2-022-027	Charge R Running Par	Prev Correction Calculation Bk:Day	ENG*	[1 to 31 / 1 / 1day/step]
2-022-028	Charge R Running Par	Prev Correction Calculation Bk:Hour	ENG*	[0 to 23 / 0 / 1hour/step]
2-022-029	Charge R Running Par	Prev Correction Calculation Bk:Minute	ENG*	[0 to 59 / 0 / 1minute/step]
2-022-030	Charge R Running Par	Rotation At Prev Correction: PCU: Bk	ENG*	[0 to 999999999 / 0 / 1mm/step]
2-022-031	Charge R Running Par	Rotation At Prev Correction: PCU: C	ENG*	[0 to 999999999 / 0 / 1mm/step]
2-022-032	Charge R Running Par	Rotation At Prev Correction: PCU: M	ENG*	[0 to 999999999 / 0 / 1mm/step]
2-022-033	Charge R Running Par	Rotation At Prev Correction: PCU: Y	ENG*	[0 to 999999999 / 0 / 1mm/step]
2-101-001	Registration Correction	Color Main Dot: Bk	ENG*	[-512 to 511 / 0 / 1dot/step]
2-101-002	Registration Correction	Color Main Dot: Ma	ENG*	[-512 to 511 / 0 / 1dot/step]
2-101-003	Registration Correction	Color Main Dot: Cy	ENG*	[-512 to 511 / 0 / 1dot/step]
2-101-	Registration Correction	Color Main Dot: Ye	ENG*	[-512 to 511 / 0 / 1dot/step]

3.SP Mode Tables

SP No.	Large Category	Small Category	ENG or CTL	[Min to Max/Init./Step]
004				
2-101-005	Registration Correction	Color Sub Line: Bk	ENG*	[-16384 to 16383 / 0 / 1line/step]
2-101-006	Registration Correction	Color Sub Line: Ma	ENG*	[-16384 to 16383 / 0 / 1line/step]
2-101-007	Registration Correction	Color Sub Line: Cy	ENG*	[-16384 to 16383 / 0 / 1line/step]
2-101-008	Registration Correction	Color Sub Line: Ye	ENG*	[-16384 to 16383 / 0 / 1line/step]
2-102-001	Magnification Adjustment	Main Mag.: Standard Speed: Bk	ENG*	[-2.000 to 2.000 / 0.000 / 0.001%/step]
2-102-002	Magnification Adjustment	Main Mag.: Middle Speed: Bk	ENG*	[-2.000 to 2.000 / 0.000 / 0.001%/step]
2-102-003	Magnification Adjustment	Main Mag.: Low Speed: Bk	ENG*	[-2.000 to 2.000 / 0.000 / 0.001%/step]
2-102-004	Magnification Adjustment	Main Mag.: Standard Speed: Ma	ENG*	[-2.000 to 2.000 / 0.000 / 0.001%/step]
2-102-005	Magnification Adjustment	Main Mag.: Middle Speed: Ma	ENG*	[-2.000 to 2.000 / 0.000 / 0.001%/step]
2-102-006	Magnification Adjustment	Main Mag.: Low Speed: Ma	ENG*	[-2.000 to 2.000 / 0.000 / 0.001%/step]
2-102-007	Magnification Adjustment	Main Mag.: Standard Speed: Cy	ENG*	[-2.000 to 2.000 / 0.000 / 0.001%/step]
2-102-	Magnification Adjustment	Main Mag.: Middle Speed: Cy	ENG*	[-2.000 to 2.000 / 0.000 / 0.001%/step]

3.SP Mode Tables

SP No.	Large Category	Small Category	ENG or CTL	[Min to Max/Init./Step]
008				
2-102-009	Magnification Adjustment	Main Mag.: Low Speed: Cy	ENG*	[-2.000 to 2.000 / 0.000 / 0.001%/step]
2-102-010	Magnification Adjustment	Main Mag.: Standard Speed: Ye	ENG*	[-2.000 to 2.000 / 0.000 / 0.001%/step]
2-102-011	Magnification Adjustment	Main Mag.: Middle Speed: Ye	ENG*	[-2.000 to 2.000 / 0.000 / 0.001%/step]
2-102-012	Magnification Adjustment	Main Mag.: Low Speed: Ye	ENG*	[-2.000 to 2.000 / 0.000 / 0.001%/step]
2-102-028	Magnification Adjustment	Color Main Mag.: High Speed: Ma	ENG*	[-2.000 to 2.000 / 0.000 / 0.001%/step]
2-102-031	Magnification Adjustment	Color Main Mag.: High Speed: Cy	ENG*	[-2.000 to 2.000 / 0.000 / 0.001%/step]
2-102-034	Magnification Adjustment	Color Main Mag.: High Speed: Ye	ENG*	[-2.000 to 2.000 / 0.000 / 0.001%/step]
2-102-037	Main Scan Beam Pitch Adj.	Bk: 1st-2nd	ENG*	[0.00 to 100.00 / 9.61 / 0.01dot/step]
2-102-038	Main Scan Beam Pitch Adj.	Bk: 1st-3rd	ENG*	[0.00 to 100.00 / 19.22 / 0.01dot/step]
2-102-039	Main Scan Beam Pitch Adj.	Bk: 1st-4th	ENG*	[0.00 to 100.00 / 28.83 / 0.01dot/step]
2-102-040	Main Scan Beam Pitch Adj.	Ma: 1st-2nd	ENG*	[0.00 to 100.00 / 9.61 / 0.01dot/step]
2-102-	Main Scan Beam Pitch Adj.	Ma: 1st-3rd	ENG*	[0.00 to 100.00 / 19.22 / 0.01dot/step]

3.SP Mode Tables

SP No.	Large Category	Small Category	ENG or CTL	[Min to Max/Init./Step]
041				
2-102-042	Main Scan Beam Pitch Adj.	Ma: 1st-4th	ENG*	[0.00 to 100.00 / 28.83 / 0.01dot/step]
2-102-043	Main Scan Beam Pitch Adj.	Cy: 1st-2nd	ENG*	[0.00 to 100.00 / 9.61 / 0.01dot/step]
2-102-044	Main Scan Beam Pitch Adj.	Cy: 1st-3rd	ENG*	[0.00 to 100.00 / 19.22 / 0.01dot/step]
2-102-045	Main Scan Beam Pitch Adj.	Cy: 1st-4th	ENG*	[0.00 to 100.00 / 28.83 / 0.01dot/step]
2-102-046	Main Scan Beam Pitch Adj.	Ye: 1st-2nd	ENG*	[0.00 to 100.00 / 9.61 / 0.01dot/step]
2-102-047	Main Scan Beam Pitch Adj.	Ye: 1st-3rd	ENG*	[0.00 to 100.00 / 19.22 / 0.01dot/step]
2-102-048	Main Scan Beam Pitch Adj.	Ye: 1st-4th	ENG*	[0.00 to 100.00 / 28.83 / 0.01dot/step]
2-103-001	Erase Margin Adjustment	Lead Edge Width	ENG	[0.0 to 9.9 / 4.2 / 0.1mm/step]
2-103-002	Erase Margin Adjustment	Trail. Edge Width	ENG	[0.0 to 9.9 / 4.2 / 0.1mm/step]
2-103-003	Erase Margin Adjustment	Left	ENG	[0.0 to 9.9 / 2.0 / 0.1mm/step]
2-103-004	Erase Margin Adjustment	Right	ENG	[0.0 to 9.9 / 2.0 / 0.1mm/step]
2-103-	Erase Margin Adjustment	Duplex Trail. L Size	ENG	[-4.0 to 4.0 / 0.8 / 0.1mm/step]

3.SP Mode Tables

SP No.	Large Category	Small Category	ENG or CTL	[Min to Max/Init./Step]
006				
2-103-007	Erase Margin Adjustment	Duplex Trail. M Size	ENG	[-4.0 to 4.0 / 0.8 / 0.1mm/step]
2-103-008	Erase Margin Adjustment	Duplex Trail. S Size	ENG	[-4.0 to 4.0 / 0.6 / 0.1mm/step]
2-103-009	Erase Margin Adjustment	Duplex Left Edge	ENG	[0.0 to 1.5 / 0.3 / 0.1mm/step]
2-103-010	Erase Margin Adjustment	Duplex Right Edge	ENG	[0.0 to 1.5 / 0.3 / 0.1mm/step]
2-103-011	Erase Margin Adjustment	Duplex Trail. L Size:Thick	ENG	[-4.0 to 4.0 / 0.8 / 0.1mm/step]
2-103-012	Erase Margin Adjustment	Duplex Trail. M Size:Thick	ENG	[-4.0 to 4.0 / 0.8 / 0.1mm/step]
2-103-013	Erase Margin Adjustment	Duplex Trail. S Size:Thick	ENG	[-4.0 to 4.0 / 0.6 / 0.1mm/step]
2-103-014	Erase Margin Adjustment	Duplex Left Edge:Thick	ENG	[0.0 to 1.5 / 0.3 / 0.1mm/step]
2-103-015	Erase Margin Adjustment	Duplex Right Edge:Thick	ENG	[0.0 to 1.5 / 0.3 / 0.1mm/step]
2-103-016	Erase Margin Adjustment	Duplex Trail. L Size:Thin	ENG	[-4.0 to 4.0 / 0.8 / 0.1mm/step]
2-103-017	Erase Margin Adjustment	Duplex Trail. M Size:Thin	ENG	[-4.0 to 4.0 / 0.8 / 0.1mm/step]
2-103-	Erase Margin Adjustment	Duplex Trail. S Size:Thin	ENG	[-4.0 to 4.0 / 0.6 / 0.1mm/step]

3.SP Mode Tables

SP No.	Large Category	Small Category	ENG or CTL	[Min to Max/Init./Step]
018				
2-103-019	Erase Margin Adjustment	Lead Edge Width:Thin	ENG	[0.0 to 9.9 / 4.2 / 0.1mm/step]
2-103-020	Erase Margin Adjustment	Trail. Edge Width:Thin	ENG	[0.0 to 9.9 / 4.2 / 0.1mm/step]
2-106-001	Polygon Rotation Time	Warming-Up	ENG*	[0 to 60 / 10 / 1sec/step]
2-106-002	Polygon Rotation Time	Job End	ENG*	[0.0 to 60.0 / 0.1 / 0.1sec/step]
2-107-001	Image Parameter	Image Gamma Flag	ENG	[0 to 1 / 1 / 1/step]
2-107-002	Image Parameter	Shading Correction Flag	ENG*	[0 to 1 / 0 / 1/step]
2-109-003	Test Pattern	Pattern Selection	ENG	[0 to 23 / 0 / 1/step]
2-109-005	Test Pattern	Color Selection	ENG	[1 to 4 / 1 / 1/step]
2-109-006	Test Pattern	Density: Bk	ENG	[0 to 15 / 15 / 1/step]
2-109-007	Test Pattern	Density: Ma	ENG	[0 to 15 / 15 / 1/step]
2-109-008	Test Pattern	Density: Cy	ENG	[0 to 15 / 15 / 1/step]
2-109-	Test Pattern	Density: Ye	ENG	[0 to 15 / 15 / 1/step]

3.SP Mode Tables

SP No.	Large Category	Small Category	ENG or CTL	[Min to Max/Init./Step]
009				
2-110-001	LD Driver	Error Bk	ENG	[0x0000 to 0xFFFF / 0x0000 / 1/step]
2-110-002	LD Driver	Error Ma	ENG	[0x0000 to 0xFFFF / 0x0000 / 1/step]
2-110-003	LD Driver	Error Cy	ENG	[0x0000 to 0xFFFF / 0x0000 / 1/step]
2-110-004	LD Driver	Error Ye	ENG	[0x0000 to 0xFFFF / 0x0000 / 1/step]
2-110-005	LD Driver	Writing Unit Adj. Transfer	ENG	[0 to 1 / 0 / 1/step]
2-110-010	LD Driver	Power Detection result	ENG	[0 to 255 / 0 / 1/step]
2-111-001	Forced Line Position Adj.	Mode a	ENG	[0 to 1 / 0 / 1/step]
2-111-002	Forced Line Position Adj.	Mode b	ENG	[0 to 1 / 0 / 1/step]
2-111-003	Forced Line Position Adj.	Mode c	ENG	[0 to 1 / 0 / 1/step]
2-111-004	Forced Line Position Adj.	Mode d	ENG	[0 to 1 / 0 / 1/step]
2-112-001	TM/ID Sensor Check	Execute	ENG	[0 to 1 / 0 / 1/step]
2-112-010	TM/ID Sensor Test	General:FCR	ENG*	[0 to 999 / 0 / 1/step]
2-112-011	Music Belt Test	Belt Error:FCR	ENG*	[0 to 999 / 0 / 1/step]

3.SP Mode Tables

SP No.	Large Category	Small Category	ENG or CTL	[Min to Max/Init./Step]
2-112-020	TM/ID Sensor Test	Threshold Setting	ENG*	[0.00 to 3.50 / 1.90 / 0.01V/step]
2-112-030	Music Belt Test	Music Belt Ptn NG Th	ENG*	[0.00 to 5.50 / 5.50 / 0.01V/step]
2-112-040	Music Belt Test	Music Belt Ifsg NG Th	ENG*	[0.0 to 50.0 / 50.0 / 0.1/step]
2-117-001	Skew Adjustment	Pulse: M	ENG*	[-75 to 75 / 0 / 1pulse/step]
2-117-002	Skew Adjustment	Pulse: C	ENG*	[-75 to 75 / 0 / 1pulse/step]
2-117-003	Skew Adjustment	Pulse: Y	ENG*	[-99 to 99 / 0 / 1pulse/step]
2-118-001	Skew Adjustment	Execute: M	ENG	[0 to 1 / 0 / 0/step]
2-118-002	Skew Adjustment	Execute: C	ENG	[0 to 1 / 0 / 0/step]
2-118-003	Skew Adjustment	Execute: Y	ENG	[0 to 1 / 0 / 0/step]
2-119-001	Skew Adjustment Display	M	ENG*	[-75 to 75 / 0 / 1pulse/step]
2-119-002	Skew Adjustment Display	C	ENG*	[-75 to 75 / 0 / 1pulse/step]
2-119-003	Skew Adjustment Display	Y	ENG*	[-99 to 99 / 0 / 1pulse/step]

3.SP Mode Tables

SP No.	Large Category	Small Category	ENG or CTL	[Min to Max/Init./Step]
2-120-001	Skew Adj Changing Line Speed	On/Off	ENG*	[0 to 1 / 1 / 1/step]
2-121-001	Skew Adjust Coefficient	Coefficient	ENG*	[0 to 2 / 0 / 1/step]
2-140-005	TM/ID Sensor Check Result	PWM: Front	ENG*	[0 to 1023 / 0 / 1/step]
2-140-006	TM/ID Sensor Check Result	PWM: Center	ENG*	[0 to 1023 / 0 / 1/step]
2-140-007	TM/ID Sensor Check Result	PWM: Rear	ENG*	[0 to 1023 / 0 / 1/step]
2-141-005	TM/ID Sensor Check Result	Average: Front	ENG*	[0.00 to 5.50 / 0.00 / 0.01V/step]
2-141-006	TM/ID Sensor Check Result	Average: Center	ENG*	[0.00 to 5.50 / 0.00 / 0.01V/step]
2-141-007	TM/ID Sensor Check Result	Average: Rear	ENG*	[0.00 to 5.50 / 0.00 / 0.01V/step]
2-142-005	TM/ID Sensor Check Result	Maximum: Front	ENG*	[0.00 to 5.50 / 0.00 / 0.01V/step]
2-142-006	TM/ID Sensor Check Result	Maximum: Center	ENG*	[0.00 to 5.50 / 0.00 / 0.01V/step]
2-142-007	TM/ID Sensor Check Result	Maximum: Rear	ENG*	[0.00 to 5.50 / 0.00 / 0.01V/step]
2-143-005	TM/ID Sensor Check Result	Minimum: Front	ENG*	[0.00 to 5.50 / 0.00 / 0.01V/step]

3.SP Mode Tables

SP No.	Large Category	Small Category	ENG or CTL	[Min to Max/Init./Step]
2-143-006	TM/ID Sensor Check Result	Minimum: Center	ENG*	[0.00 to 5.50 / 0.00 / 0.01V/step]
2-143-007	TM/ID Sensor Check Result	Minimum: Rear	ENG*	[0.00 to 5.50 / 0.00 / 0.01V/step]
2-144-005	TM/ID Sensor Check Result	Maximum 2: Front	ENG*	[0.00 to 5.50 / 0.00 / 0.01V/step]
2-144-006	TM/ID Sensor Check Result	Maximum 2: Center	ENG*	[0.00 to 5.50 / 0.00 / 0.01V/step]
2-144-007	TM/ID Sensor Check Result	Maximum 2: Rear	ENG*	[0.00 to 5.50 / 0.00 / 0.01V/step]
2-145-005	TM/ID Sensor Check Result	Minimum 2: Front	ENG*	[0.00 to 5.50 / 0.00 / 0.01V/step]
2-145-006	TM/ID Sensor Check Result	Minimum 2: Center	ENG*	[0.00 to 5.50 / 0.00 / 0.01V/step]
2-145-007	TM/ID Sensor Check Result	Minimum 2: Rear	ENG*	[0.00 to 5.50 / 0.00 / 0.01V/step]
2-146-005	TM-Sensor Test	Number of Edge Detection:Front	ENG*	[0 to 16 / 0 / 1/step]
2-146-006	TM-Sensor Test	Number of Edge Detection:Center	ENG*	[0 to 16 / 0 / 1/step]
2-146-007	TM-Sensor Test	Number of Edge Detection:Rear	ENG*	[0 to 16 / 0 / 1/step]
2-150-027	Area Mag. Correction	Area 0: Bk	ENG*	[-16.00 to 16.00 / 0.00 / 0.01dot/step]

3.SP Mode Tables

SP No.	Large Category	Small Category	ENG or CTL	[Min to Max/Init./Step]
2-150-028	Area Mag. Correction	Area 1: Bk	ENG*	[-16.00 to 16.00 / 0.00 / 0.01dot/step]
2-150-029	Area Mag. Correction	Area 2: Bk	ENG*	[-16.00 to 16.00 / 0.00 / 0.01dot/step]
2-150-030	Area Mag. Correction	Area 3: Bk	ENG*	[-16.00 to 16.00 / 0.00 / 0.01dot/step]
2-150-031	Area Mag. Correction	Area 4: Bk	ENG*	[-16.00 to 16.00 / 0.00 / 0.01dot/step]
2-150-032	Area Mag. Correction	Area 5: Bk	ENG*	[-16.00 to 16.00 / 0.00 / 0.01dot/step]
2-150-033	Area Mag. Correction	Area 6: Bk	ENG*	[-16.00 to 16.00 / 0.00 / 0.01dot/step]
2-150-034	Area Mag. Correction	Area 7: Bk	ENG*	[-16.00 to 16.00 / 0.00 / 0.01dot/step]
2-150-035	Area Mag. Correction	Area 8: Bk	ENG*	[-16.00 to 16.00 / 0.00 / 0.01dot/step]
2-150-036	Area Mag. Correction	Area 9: Bk	ENG*	[-16.00 to 16.00 / 0.00 / 0.01dot/step]
2-150-037	Area Mag. Correction	Area 10: Bk	ENG*	[-16.00 to 16.00 / 0.00 / 0.01dot/step]
2-150-038	Area Mag. Correction	Area 11: Bk	ENG*	[-16.00 to 16.00 / 0.00 / 0.01dot/step]
2-150-039	Area Mag. Correction	Area 12: Bk	ENG*	[-16.00 to 16.00 / 0.00 / 0.01dot/step]

3.SP Mode Tables

SP No.	Large Category	Small Category	ENG or CTL	[Min to Max/Init./Step]
2-150-079	Area Mag. Correction	Area 0: Ma	ENG*	[-16.00 to 16.00 / 0.00 / 0.01dot/step]
2-150-080	Area Mag. Correction	Area 1: Ma	ENG*	[-16.00 to 16.00 / 0.00 / 0.01dot/step]
2-150-081	Area Mag. Correction	Area 2: Ma	ENG*	[-16.00 to 16.00 / 0.00 / 0.01dot/step]
2-150-082	Area Mag. Correction	Area 3: Ma	ENG*	[-16.00 to 16.00 / 0.00 / 0.01dot/step]
2-150-083	Area Mag. Correction	Area 4: Ma	ENG*	[-16.00 to 16.00 / 0.00 / 0.01dot/step]
2-150-084	Area Mag. Correction	Area 5: Ma	ENG*	[-16.00 to 16.00 / 0.00 / 0.01dot/step]
2-150-085	Area Mag. Correction	Area 6: Ma	ENG*	[-16.00 to 16.00 / 0.00 / 0.01dot/step]
2-150-086	Area Mag. Correction	Area 7: Ma	ENG*	[-16.00 to 16.00 / 0.00 / 0.01dot/step]
2-150-087	Area Mag. Correction	Area 8: Ma	ENG*	[-16.00 to 16.00 / 0.00 / 0.01dot/step]
2-150-088	Area Mag. Correction	Area 9: Ma	ENG*	[-16.00 to 16.00 / 0.00 / 0.01dot/step]
2-150-089	Area Mag. Correction	Area 10: Ma	ENG*	[-16.00 to 16.00 / 0.00 / 0.01dot/step]
2-150-090	Area Mag. Correction	Area 11: Ma	ENG*	[-16.00 to 16.00 / 0.00 / 0.01dot/step]

3.SP Mode Tables

SP No.	Large Category	Small Category	ENG or CTL	[Min to Max/Init./Step]
2-150-091	Area Mag. Correction	Area 12: Ma	ENG*	[-16.00 to 16.00 / 0.00 / 0.01dot/step]
2-150-131	Area Mag. Correction	Area 0: Cy	ENG*	[-16.00 to 16.00 / 0.00 / 0.01dot/step]
2-150-132	Area Mag. Correction	Area 1: Cy	ENG*	[-16.00 to 16.00 / 0.00 / 0.01dot/step]
2-150-133	Area Mag. Correction	Area 2: Cy	ENG*	[-16.00 to 16.00 / 0.00 / 0.01dot/step]
2-150-134	Area Mag. Correction	Area 3: Cy	ENG*	[-16.00 to 16.00 / 0.00 / 0.01dot/step]
2-150-135	Area Mag. Correction	Area 4: Cy	ENG*	[-16.00 to 16.00 / 0.00 / 0.01dot/step]
2-150-136	Area Mag. Correction	Area 5: Cy	ENG*	[-16.00 to 16.00 / 0.00 / 0.01dot/step]
2-150-137	Area Mag. Correction	Area 6: Cy	ENG*	[-16.00 to 16.00 / 0.00 / 0.01dot/step]
2-150-138	Area Mag. Correction	Area 7: Cy	ENG*	[-16.00 to 16.00 / 0.00 / 0.01dot/step]
2-150-139	Area Mag. Correction	Area 8: Cy	ENG*	[-16.00 to 16.00 / 0.00 / 0.01dot/step]
2-150-140	Area Mag. Correction	Area 9: Cy	ENG*	[-16.00 to 16.00 / 0.00 / 0.01dot/step]
2-150-141	Area Mag. Correction	Area 10: Cy	ENG*	[-16.00 to 16.00 / 0.00 / 0.01dot/step]

3.SP Mode Tables

SP No.	Large Category	Small Category	ENG or CTL	[Min to Max/Init./Step]
2-150-142	Area Mag. Correction	Area 11: Cy	ENG*	[-16.00 to 16.00 / 0.00 / 0.01dot/step]
2-150-143	Area Mag. Correction	Area 12: Cy	ENG*	[-16.00 to 16.00 / 0.00 / 0.01dot/step]
2-150-183	Area Mag. Correction	Area 0: Ye	ENG*	[-16.00 to 16.00 / 0.00 / 0.01dot/step]
2-150-184	Area Mag. Correction	Area 1: Ye	ENG*	[-16.00 to 16.00 / 0.00 / 0.01dot/step]
2-150-185	Area Mag. Correction	Area 2: Ye	ENG*	[-16.00 to 16.00 / 0.00 / 0.01dot/step]
2-150-186	Area Mag. Correction	Area 3: Ye	ENG*	[-16.00 to 16.00 / 0.00 / 0.01dot/step]
2-150-187	Area Mag. Correction	Area 4: Ye	ENG*	[-16.00 to 16.00 / 0.00 / 0.01dot/step]
2-150-188	Area Mag. Correction	Area 5: Ye	ENG*	[-16.00 to 16.00 / 0.00 / 0.01dot/step]
2-150-189	Area Mag. Correction	Area 6: Ye	ENG*	[-16.00 to 16.00 / 0.00 / 0.01dot/step]
2-150-190	Area Mag. Correction	Area 7: Ye	ENG*	[-16.00 to 16.00 / 0.00 / 0.01dot/step]
2-150-191	Area Mag. Correction	Area 8: Ye	ENG*	[-16.00 to 16.00 / 0.00 / 0.01dot/step]
2-150-192	Area Mag. Correction	Area 9: Ye	ENG*	[-16.00 to 16.00 / 0.00 / 0.01dot/step]

3.SP Mode Tables

SP No.	Large Category	Small Category	ENG or CTL	[Min to Max/Init./Step]
2-150-193	Area Mag. Correction	Area 10: Ye	ENG*	[-16.00 to 16.00 / 0.00 / 0.01dot/step]
2-150-194	Area Mag. Correction	Area 11: Ye	ENG*	[-16.00 to 16.00 / 0.00 / 0.01dot/step]
2-150-195	Area Mag. Correction	Area 12: Ye	ENG*	[-16.00 to 16.00 / 0.00 / 0.01dot/step]
2-152-001	Shad. Correct Setting	Standard Speed: Bk	ENG*	[50.0 to 120.0 / 100.0 / 0.1%/step]
2-152-002	Shad. Correct Setting	Standard Speed: Ma	ENG*	[50.0 to 120.0 / 100.0 / 0.1%/step]
2-152-003	Shad. Correct Setting	Standard Speed: Cy	ENG*	[50.0 to 120.0 / 100.0 / 0.1%/step]
2-152-004	Shad. Correct Setting	Standard Speed: Ye	ENG*	[50.0 to 120.0 / 100.0 / 0.1%/step]
2-152-005	Shad. Correct Setting	Middle Speed: Bk	ENG*	[50.0 to 120.0 / 100.0 / 0.1%/step]
2-152-006	Shad. Correct Setting	Middle Speed: Ma	ENG*	[50.0 to 120.0 / 100.0 / 0.1%/step]
2-152-007	Shad. Correct Setting	Middle Speed: Cy	ENG*	[50.0 to 120.0 / 100.0 / 0.1%/step]
2-152-008	Shad. Correct Setting	Middle Speed: Ye	ENG*	[50.0 to 120.0 / 100.0 / 0.1%/step]
2-152-009	Shad. Correct Setting	Low Speed: Bk	ENG*	[50.0 to 120.0 / 100.0 / 0.1%/step]

3.SP Mode Tables

SP No.	Large Category	Small Category	ENG or CTL	[Min to Max/Init./Step]
2-152-010	Shad. Correct Setting	Low Speed: Ma	ENG*	[50.0 to 120.0 / 100.0 / 0.1%/step]
2-152-011	Shad. Correct Setting	Low Speed: Cy	ENG*	[50.0 to 120.0 / 100.0 / 0.1%/step]
2-152-012	Shad. Correct Setting	Low Speed: Ye	ENG*	[50.0 to 120.0 / 100.0 / 0.1%/step]
2-152-016	Shad. Correct Setting	High Limit	ENG*	[52.0 to 176.0 / 140.0 / 0.1%/step]
2-152-017	Shad. Correct Setting	Low Limit	ENG*	[52.0 to 176.0 / 60.0 / 0.1%/step]
2-154-002	Shad. Correct Setting	Front End Area: Bk: LD1	ENG*	[50.0 to 150.0 / 100.0 / 0.1%/step]
2-154-003	Shad. Correct Setting	Front End Area: Bk: LD2	ENG*	[50.0 to 150.0 / 100.0 / 0.1%/step]
2-154-004	Shad. Correct Setting	Front End Area: Bk: LD3	ENG*	[50.0 to 150.0 / 100.0 / 0.1%/step]
2-154-005	Shad. Correct Setting	Front End Area: Bk: LD4	ENG*	[50.0 to 150.0 / 100.0 / 0.1%/step]
2-154-007	Shad. Correct Setting	Front End Area: Ma: LD1	ENG*	[50.0 to 150.0 / 100.0 / 0.1%/step]
2-154-008	Shad. Correct Setting	Front End Area: Ma: LD2	ENG*	[50.0 to 150.0 / 100.0 / 0.1%/step]
2-154-009	Shad. Correct Setting	Front End Area: Ma: LD3	ENG*	[50.0 to 150.0 / 100.0 / 0.1%/step]

3.SP Mode Tables

SP No.	Large Category	Small Category	ENG or CTL	[Min to Max/Init./Step]
2-154-010	Shad. Correct Setting	Front End Area: Ma: LD4	ENG*	[50.0 to 150.0 / 100.0 / 0.1%/step]
2-154-012	Shad. Correct Setting	Front End Area: Cy: LD1	ENG*	[50.0 to 150.0 / 100.0 / 0.1%/step]
2-154-013	Shad. Correct Setting	Front End Area: Cy: LD2	ENG*	[50.0 to 150.0 / 100.0 / 0.1%/step]
2-154-014	Shad. Correct Setting	Front End Area: Cy: LD3	ENG*	[50.0 to 150.0 / 100.0 / 0.1%/step]
2-154-015	Shad. Correct Setting	Front End Area: Cy: LD4	ENG*	[50.0 to 150.0 / 100.0 / 0.1%/step]
2-154-017	Shad. Correct Setting	Front End Area: Ye: LD1	ENG*	[50.0 to 150.0 / 100.0 / 0.1%/step]
2-154-018	Shad. Correct Setting	Front End Area: Ye: LD2	ENG*	[50.0 to 150.0 / 100.0 / 0.1%/step]
2-154-019	Shad. Correct Setting	Front End Area: Ye: LD3	ENG*	[50.0 to 150.0 / 100.0 / 0.1%/step]
2-154-020	Shad. Correct Setting	Front End Area: Ye: LD4	ENG*	[50.0 to 150.0 / 100.0 / 0.1%/step]
2-160-001	Vertical Line Width	600dpi:Bk	ENG*	[10 to 15 / 15 / 1/step]
2-160-002	Vertical Line Width	600dpi:Ma	ENG*	[10 to 15 / 15 / 1/step]
2-160-003	Vertical Line Width	600dpi:Cy	ENG*	[10 to 15 / 15 / 1/step]

3.SP Mode Tables

SP No.	Large Category	Small Category	ENG or CTL	[Min to Max/Init./Step]
2-160-004	Vertical Line Width	600dpi:Ye	ENG*	[10 to 15 / 15 / 1/step]
2-160-005	Vertical Line Width	1200dpi:Bk	ENG*	[10 to 15 / 15 / 1/step]
2-160-006	Vertical Line Width	1200dpi:Ma	ENG*	[10 to 15 / 15 / 1/step]
2-160-007	Vertical Line Width	1200dpi:Cy	ENG*	[10 to 15 / 15 / 1/step]
2-160-008	Vertical Line Width	1200dpi:Ye	ENG*	[10 to 15 / 15 / 1/step]
2-160-009	Vertical Line Width	600dpi:Indet.:Bk	ENG*	[10 to 15 / 14 / 1/step]
2-160-010	Vertical Line Width	1200dpi:Indet.:Bk	ENG*	[10 to 15 / 15 / 1/step]
2-180-001	Line Pos. Adj. Clear	Color Regist.	ENG	[0 to 1 / 0 / 1/step]
2-180-002	Line Pos. Adj. Clear	Main Scan Length Detection	ENG	[0 to 1 / 0 / 1/step]
2-180-003	Line Pos. Adj. Clear	MUSIC Result	ENG	[0 to 1 / 0 / 1/step]
2-181-003	Line Position Adj. Result	Skew: M	ENG*	[-5000.000 to 5000.000 / 0.000 / 0.001um/step]
2-181-011	Line Position Adj. Result	M. Cor.: Dot: M	ENG*	[-512 to 511 / 0 / 1dot/step]

3.SP Mode Tables

SP No.	Large Category	Small Category	ENG or CTL	[Min to Max/Init./Step]
2-181-012	Line Position Adj. Result	M. Cor.: Subdot: M	ENG*	[-1.00 to 1.00 / 0.00 / 0.01dot/step]
2-181-013	Line Position Adj. Result	S. Cor.: 1200 Line: Middle: M	ENG*	[-16384 to 16383 / 0 / 1line/step]
2-181-014	Line Position Adj. Result	S. Cor.: 1200 Sub: Middle: M	ENG*	[-2.000 to 2.000 / 0.000 / 0.001line/step]
2-181-015	Line Position Adj. Result	M. Left Mag.: Subdot: M	ENG*	[-32.00 to 32.00 / 0.00 / 0.01dot/step]
2-181-016	Line Position Adj. Result	M. Right Mag.: Subdot: M	ENG*	[-32.00 to 32.00 / 0.00 / 0.01dot/step]
2-181-017	Line Position Adj. Result	S. Cor.: 1200 Line: Standard: M	ENG*	[-16384 to 16383 / 0 / 1line/step]
2-181-018	Line Position Adj. Result	S. Cor.: 1200 Sub: Standard: M	ENG*	[-2.000 to 2.000 / 0.000 / 0.001line/step]
2-181-019	Line Position Adj. Result	S. Cor.: 1200 Line: Low: M	ENG*	[-16384 to 16383 / 0 / 1line/step]
2-181-020	Line Position Adj. Result	S. Cor.: 1200 Sub: Low: M	ENG*	[-2.000 to 2.000 / 0.000 / 0.001line/step]
2-181-021	Line Position Adj. Result	Skew: C	ENG*	[-5000.000 to 5000.000 / 0.000 / 0.001um/step]
2-181-029	Line Position Adj. Result	M. Cor.: Dot: C	ENG*	[-512 to 511 / 0 / 1dot/step]
2-181-030	Line Position Adj. Result	M. Cor.: Subdot: C	ENG*	[-1.00 to 1.00 / 0.00 / 0.01dot/step]

3.SP Mode Tables

SP No.	Large Category	Small Category	ENG or CTL	[Min to Max/Init./Step]
2-181-031	Line Position Adj. Result	S. Cor.: 1200 Line: Middle: C	ENG*	[-16384 to 16383 / 0 / 1line/step]
2-181-032	Line Position Adj. Result	S. Cor.: 1200 Sub: Middle: C	ENG*	[-2.000 to 2.000 / 0.000 / 0.001line/step]
2-181-033	Line Position Adj. Result	C. Left Mag.: Subdot: M	ENG*	[-32.00 to 32.00 / 0.00 / 0.01dot/step]
2-181-034	Line Position Adj. Result	C. Right Mag.: Subdot: M	ENG*	[-32.00 to 32.00 / 0.00 / 0.01dot/step]
2-181-035	Line Position Adj. Result	S. Cor.: 1200 Line: Standard: C	ENG*	[-16384 to 16383 / 0 / 1line/step]
2-181-036	Line Position Adj. Result	S. Cor.: 1200 Sub: Standard: C	ENG*	[-2.000 to 2.000 / 0.000 / 0.001line/step]
2-181-037	Line Position Adj. Result	S. Cor.: 1200 Line: Low: C	ENG*	[-16384 to 16383 / 0 / 1line/step]
2-181-038	Line Position Adj. Result	S. Cor.: 1200 Sub: Low: C	ENG*	[-2.000 to 2.000 / 0.000 / 0.001line/step]
2-181-039	Line Position Adj. Result	Skew: Y	ENG*	[-5000.000 to 5000.000 / 0.000 / 0.001um/step]
2-181-047	Line Position Adj. Result	M. Cor.: Dot: Y	ENG*	[-512 to 511 / 0 / 1dot/step]
2-181-048	Line Position Adj. Result	M. Cor.: Subdot: Y	ENG*	[-1.00 to 1.00 / 0.00 / 0.01dot/step]
2-181-049	Line Position Adj. Result	S. Cor.: 1200 Line: Middle: Y	ENG*	[-16384 to 16383 / 0 / 1line/step]

3.SP Mode Tables

SP No.	Large Category	Small Category	ENG or CTL	[Min to Max/Init./Step]
2-181-050	Line Position Adj. Result	S. Cor.: 1200 Sub: Middle: Y	ENG*	[-2.000 to 2.000 / 0.000 / 0.001line/step]
2-181-051	Line Position Adj. Result	Y. Left Mag.: Subdot: M	ENG*	[-32.00 to 32.00 / 0.00 / 0.01dot/step]
2-181-052	Line Position Adj. Result	Y. Right Mag.: Subdot: M	ENG*	[-32.00 to 32.00 / 0.00 / 0.01dot/step]
2-181-053	Line Position Adj. Result	S. Cor.: 1200 Line: Standard: Y	ENG*	[-16384 to 16383 / 0 / 1line/step]
2-181-054	Line Position Adj. Result	S. Cor.: 1200 Sub: Standard: Y	ENG*	[-2.000 to 2.000 / 0.000 / 0.001line/step]
2-181-055	Line Position Adj. Result	S. Cor.: 1200 Line: Low: Y	ENG*	[-16384 to 16383 / 0 / 1line/step]
2-181-056	Line Position Adj. Result	S. Cor.: 1200 Sub: Low: Y	ENG*	[-2.000 to 2.000 / 0.000 / 0.001line/step]
2-181-057	Line Position Adj. Result	S. Cor.: 600 Sub	ENG*	[-1.000 to 1.000 / 0.000 / 0.001line/step]
2-181-059	Line Position Adj. Result	S. Cor.: 1200 Sub :High	ENG*	[-2.000 to 2.000 / 0.000 / 0.001line/step]
2-181-060	Line Position Adj. Result	S. Cor.: 1200 Sub :Low	ENG*	[-2.000 to 2.000 / 0.000 / 0.001line/step]
2-181-061	Line Position Adj. Result	S. Cor.: 1200 Sub :Middle	ENG*	[-2.000 to 2.000 / 0.000 / 0.001line/step]
2-181-064	Line Position Adj. Result	M. Cor.: Dot: K	ENG*	[-512 to 511 / 0 / 1dot/step]

3.SP Mode Tables

SP No.	Large Category	Small Category	ENG or CTL	[Min to Max/Init./Step]
2-181-072	Line Position Adj. Result	LineSift: StandardSpeed: M	ENG*	[0 to 3 / 0 / 1line/step]
2-181-073	Line Position Adj. Result	LineSift: MidSpeed: M	ENG*	[0 to 1 / 0 / 1line/step]
2-181-074	Line Position Adj. Result	LineSift: StandardSpeed: C	ENG*	[0 to 3 / 0 / 1line/step]
2-181-075	Line Position Adj. Result	LineSift: MidSpeed: C	ENG*	[0 to 1 / 0 / 1line/step]
2-181-076	Line Position Adj. Result	LineSift: StandardSpeed: Y	ENG*	[0 to 3 / 0 / 1line/step]
2-181-077	Line Position Adj. Result	LineSift: MidSpeed: Y	ENG*	[0 to 1 / 0 / 1line/step]
2-181-080	Line Position Adj. Result	Detect Diff.: M	ENG*	[-1000.0 to 1000.0 / 0.0 / 0.1/step]
2-181-081	Line Position Adj. Result	Detect Diff.: C	ENG*	[-1000.0 to 1000.0 / 0.0 / 0.1/step]
2-181-082	Line Position Adj. Result	Detect Diff.: Y	ENG*	[-1000.0 to 1000.0 / 0.0 / 0.1/step]
2-182-004	Line Position Adj. Offset	M. Scan: Standard: Dot: M	ENG*	[-512 to 511 / 0 / 1dot/step]
2-182-005	Line Position Adj. Offset	M. Scan: Standard: Subdot: M	ENG*	[-1.00 to 1.00 / 0.00 / 0.01dot/step]
2-182-006	Line Position Adj. Offset	M. Scan: Middle: Dot: M	ENG*	[-512 to 511 / 0 / 1dot/step]

3.SP Mode Tables

SP No.	Large Category	Small Category	ENG or CTL	[Min to Max/Init./Step]
2-182-007	Line Position Adj. Offset	M. Scan: Middle: Subdot: M	ENG*	[-1.00 to 1.00 / 0.00 / 0.01dot/step]
2-182-008	Line Position Adj. Offset	M. Scan: Low: Dot: M	ENG*	[-512 to 511 / 0 / 1dot/step]
2-182-009	Line Position Adj. Offset	M. Scan: Low: Subdot: M	ENG*	[-1.00 to 1.00 / 0.00 / 0.01dot/step]
2-182-010	Line Position Adj. Offset	M. Scan: Standard: Dot: C	ENG*	[-512 to 511 / 0 / 1dot/step]
2-182-011	Line Position Adj. Offset	M. Scan: Standard: Subdot: C	ENG*	[-1.00 to 1.00 / 0.00 / 0.01dot/step]
2-182-012	Line Position Adj. Offset	M. Scan: Middle: Dot: C	ENG*	[-512 to 511 / 0 / 1dot/step]
2-182-013	Line Position Adj. Offset	M. Scan: Middle: Subdot: C	ENG*	[-1.00 to 1.00 / 0.00 / 0.01dot/step]
2-182-014	Line Position Adj. Offset	M. Scan: Low: Dot: C	ENG*	[-512 to 511 / 0 / 1dot/step]
2-182-015	Line Position Adj. Offset	M. Scan: Low: Subdot: C	ENG*	[-1.00 to 1.00 / 0.00 / 0.01dot/step]
2-182-016	Line Position Adj. Offset	M. Scan: Standard: Dot: Y	ENG*	[-512 to 511 / 0 / 1dot/step]
2-182-017	Line Position Adj. Offset	M. Scan: Standard: Subdot: Y	ENG*	[-1.00 to 1.00 / 0.00 / 0.01dot/step]
2-182-018	Line Position Adj. Offset	M. Scan: Middle: Dot: Y	ENG*	[-512 to 511 / 0 / 1dot/step]

3.SP Mode Tables

SP No.	Large Category	Small Category	ENG or CTL	[Min to Max/Init./Step]
2-182-019	Line Position Adj. Offset	M. Scan: Middle: Subdot: Y	ENG*	[-1.00 to 1.00 / 0.00 / 0.01dot/step]
2-182-020	Line Position Adj. Offset	M. Scan: Low: Dot: Y	ENG*	[-512 to 511 / 0 / 1dot/step]
2-182-021	Line Position Adj. Offset	M. Scan: Low: Subdot: Y	ENG*	[-1.00 to 1.00 / 0.00 / 0.01dot/step]
2-182-022	Line Position Adj. Offset	S. Scan: Standard: Line: M	ENG*	[-16384 to 16383 / 0 / 1line/step]
2-182-023	Line Position Adj. Offset	S. Scan: Standard: Subline: M	ENG*	[-1.00 to 1.00 / 0.00 / 0.01line/step]
2-182-024	Line Position Adj. Offset	S. Scan: Middle: Line: M	ENG*	[-16384 to 16383 / 0 / 1line/step]
2-182-025	Line Position Adj. Offset	S. Scan: Middle: Subline: M	ENG*	[-1.00 to 1.00 / 0.00 / 0.01line/step]
2-182-026	Line Position Adj. Offset	S. Scan: Low: Line: M	ENG*	[-16384 to 16383 / 0 / 1line/step]
2-182-027	Line Position Adj. Offset	S. Scan: Low: Subline: M	ENG*	[-1.00 to 1.00 / 0.00 / 0.01line/step]
2-182-028	Line Position Adj. Offset	S. Scan: Standard: Line: C	ENG*	[-16384 to 16383 / 0 / 1line/step]
2-182-029	Line Position Adj. Offset	S. Scan: Standard: Subline: C	ENG*	[-1.00 to 1.00 / 0.00 / 0.01line/step]
2-182-030	Line Position Adj. Offset	S. Scan: Middle: Line: C	ENG*	[-16384 to 16383 / 0 / 1line/step]

3.SP Mode Tables

SP No.	Large Category	Small Category	ENG or CTL	[Min to Max/Init./Step]
2-182-031	Line Position Adj. Offset	S. Scan: Middle: Subline: C	ENG*	[-1.00 to 1.00 / 0.00 / 0.01line/step]
2-182-032	Line Position Adj. Offset	S. Scan: Low: Line: C	ENG*	[-16384 to 16383 / 0 / 1line/step]
2-182-033	Line Position Adj. Offset	S. Scan: Low: Subline: C	ENG*	[-1.00 to 1.00 / 0.00 / 0.01line/step]
2-182-034	Line Position Adj. Offset	S. Scan: Standard: Line: Y	ENG*	[-16384 to 16383 / 0 / 1line/step]
2-182-035	Line Position Adj. Offset	S. Scan: Standard: Subline: Y	ENG*	[-1.00 to 1.00 / 0.00 / 0.01line/step]
2-182-036	Line Position Adj. Offset	S. Scan: Middle: Line: Y	ENG*	[-16384 to 16383 / 0 / 1line/step]
2-182-037	Line Position Adj. Offset	S. Scan: Middle: Subline: Y	ENG*	[-1.00 to 1.00 / 0.00 / 0.01line/step]
2-182-038	Line Position Adj. Offset	S. Scan: Low: Line: Y	ENG*	[-16384 to 16383 / 0 / 1line/step]
2-182-039	Line Position Adj. Offset	S. Scan: Low: Subline: Y	ENG*	[-1.00 to 1.00 / 0.00 / 0.01line/step]
2-182-040	Line Position Adj. Offset	M. Scan: Dot: K	ENG*	[-512 to 511 / 0 / 1dot/step]
2-187-002	Method Select	MUSIC Pattern Length Adj.	ENG*	[-300 to 300 / 0 / 1dot/step]
2-187-003	Method Select	Pattern Width Adj.	ENG*	[-512 to 511 / 0 / 1dot/step]

3.SP Mode Tables

SP No.	Large Category	Small Category	ENG or CTL	[Min to Max/Init./Step]
2-187-004	Method Select	Pattern Interval Adj.	ENG*	[-512 to 511 / 0 / 1dot/step]
2-187-006	Method Select	Unit SHD Adjust	ENG*	[0 to 1 / 0 / 1/step]
2-190-012	Line Position Adj.	SnSErr Range	ENG*	[0 to 3500 / 200 / 1um/step]
2-193-002	MUSIC Condition Set	Page: Job End: BW+FC	ENG*	[0 to 999 / 500 / 1page/step]
2-193-003	MUSIC Condition Set	Page: Job End: FC	ENG*	[0 to 999 / 200 / 1page/step]
2-193-004	MUSIC Condition Set	Page: Interrupt: BW+FC	ENG*	[0 to 999 / 0 / 1page/step]
2-193-005	MUSIC Condition Set	Page: Interrupt: FC	ENG*	[0 to 999 / 0 / 1page/step]
2-193-006	MUSIC Condition Set	Page: Stand-By: BW	ENG*	[0 to 999 / 100 / 1page/step]
2-193-007	MUSIC Condition Set	Page: Stand-By: FC	ENG*	[0 to 999 / 100 / 1page/step]
2-193-008	MUSIC Condition Set	Temp.	ENG*	[0 to 100 / 5 / 1deg/step]
2-193-011	MUSIC Condition Set	Temp. 2	ENG*	[0 to 100 / 5 / 1deg/step]
2-193-013	MUSIC Condition Set	Temp. 3	ENG*	[0 to 100 / 10 / 1deg/step]

3.SP Mode Tables

SP No.	Large Category	Small Category	ENG or CTL	[Min to Max/Init./Step]
2-193-017	MUSIC Condition Set	Skew	ENG*	[0 to 999 / 50 / 1um/step]
2-193-018	MUSIC Condition Set	Page: Low Speed: BW+FC	ENG*	[0 to 999 / 0 / 1page/step]
2-193-019	MUSIC Condition Set	Page: Low Speed: FC	ENG*	[0 to 999 / 0 / 1page/step]
2-193-020	MUSIC Condition Set	Page: Distance: BW+FC	ENG*	[0 to 219 / 51 / 1page/step]
2-193-021	MUSIC Condition Set	Page: Distance: FC	ENG*	[0 to 219 / 51 / 1page/step]
2-193-022	MUSIC Condition Set	Page: Mode i	ENG*	[0 to 999 / 200 / 1page/step]
2-194-001	MUSIC Execution Result	Year	ENG*	[0 to 99 / 0 / 1year/step]
2-194-002	MUSIC Execution Result	Month	ENG*	[1 to 12 / 1 / 1month/step]
2-194-003	MUSIC Execution Result	Day	ENG*	[1 to 31 / 1 / 1day/step]
2-194-004	MUSIC Execution Result	Hour	ENG*	[0 to 23 / 0 / 1hour/step]
2-194-005	MUSIC Execution Result	Minute	ENG*	[0 to 59 / 0 / 1minute/step]
2-194-006	MUSIC Execution Result	Temperature	ENG*	[0 to 100 / 0 / 1deg/step]

3.SP Mode Tables

SP No.	Large Category	Small Category	ENG or CTL	[Min to Max/Init./Step]
2-194-007	MUSIC Execution Result	Execution Result	ENG*	[0 to 1 / 0 / 1/step]
2-194-008	MUSIC Execution Result	Number of Execution	ENG*	[0 to 999999 / 0 / 1times/step]
2-194-009	MUSIC Execution Result	Number of Failure	ENG*	[0 to 999999 / 0 / 1times/step]
2-194-010	MUSIC Execution Result	Error Result: C	ENG*	[0 to 9 / 0 / 1/step]
2-194-011	MUSIC Execution Result	Error Result: M	ENG*	[0 to 9 / 0 / 1/step]
2-194-012	MUSIC Execution Result	Error Result: Y	ENG*	[0 to 9 / 0 / 1/step]
2-194-013	MUSIC Execution Result	Error Result: K	ENG*	[0 to 9 / 0 / 1/step]
2-194-014	MUSIC Execution Result	Temperature 2	ENG*	[-10 to 100 / 0 / 1deg/step]
2-194-020	MUSIC Execution Result	Success:Year	ENG*	[0 to 99 / 0 / 1year/step]
2-194-021	MUSIC Execution Result	Success:Month	ENG*	[1 to 12 / 1 / 1month/step]
2-194-022	MUSIC Execution Result	Success:Day	ENG*	[1 to 31 / 1 / 1day/step]
2-194-023	MUSIC Execution Result	Success:Hour	ENG*	[0 to 23 / 0 / 1hour/step]

3.SP Mode Tables

SP No.	Large Category	Small Category	ENG or CTL	[Min to Max/Init./Step]
2-194-024	MUSIC Execution Result	Success:Minute	ENG*	[0 to 59 / 0 / 1minute/step]
2-194-025	MUSIC Execution Result	MUSIC Mode	ENG*	[0 to 1 / 0 / 1/step]
2-195-001	Realtime MUSIC Condition Set	ON/OFF	ENG*	[0 to 1 / 1 / 1/step]
2-195-002	Realtime MUSIC Condition Set	Page: Interrupt: BW+FC	ENG*	[0 to 999 / 50 / 1page/step]
2-195-004	Realtime MUSIC Condition Set	Temperature 4	ENG*	[0 to 100 / 1 / 1deg/step]
2-220-001	Skew Origin Set	M: Skew Motor	ENG	[0 to 1 / 0 / 0/step]
2-220-002	Skew Origin Set	C: Skew Motor	ENG	[0 to 1 / 0 / 0/step]
2-220-003	Skew Origin Set	Y: Skew Motor	ENG	[0 to 1 / 0 / 0/step]
2-221-001	LD Power: Fixed	K	ENG*	[0 to 217 / 100 / 1%/step]
2-221-002	LD Power: Fixed	C	ENG*	[0 to 217 / 100 / 1%/step]
2-221-003	LD Power: Fixed	M	ENG*	[0 to 217 / 100 / 1%/step]
2-221-004	LD Power: Fixed	Y	ENG*	[0 to 217 / 100 / 1%/step]

3.SP Mode Tables

SP No.	Large Category	Small Category	ENG or CTL	[Min to Max/Init./Step]
2-229-001	Develop DC Vias	Standard Speed: Bk	ENG*	[0 to 800 / 550 / 1-V/step]
2-229-002	Develop DC Vias	Standard Speed: C	ENG*	[0 to 800 / 550 / 1-V/step]
2-229-003	Develop DC Vias	Standard Speed: M	ENG*	[0 to 800 / 550 / 1-V/step]
2-229-004	Develop DC Vias	Standard Speed: Y	ENG*	[0 to 800 / 550 / 1-V/step]
2-229-005	Develop DC Bias	Middle Speed Bk	ENG*	[0 to 800 / 550 / 1-V/step]
2-229-006	Develop DC Bias	Middle Speed C	ENG*	[0 to 800 / 550 / 1-V/step]
2-229-007	Develop DC Bias	Middle Speed M	ENG*	[0 to 800 / 550 / 1-V/step]
2-229-008	Develop DC Bias	Middle Speed Y	ENG*	[0 to 800 / 550 / 1-V/step]
2-229-009	Develop DC Vias	Low Speed: Bk	ENG*	[0 to 800 / 550 / 1-V/step]
2-229-010	Develop DC Vias	Low Speed: C	ENG*	[0 to 800 / 550 / 1-V/step]
2-229-011	Develop DC Vias	Low Speed: M	ENG*	[0 to 800 / 550 / 1-V/step]
2-229-012	Develop DC Vias	Low Speed: Y	ENG*	[0 to 800 / 550 / 1-V/step]

3.SP Mode Tables

SP No.	Large Category	Small Category	ENG or CTL	[Min to Max/Init./Step]
2-230-001	QL Power Setting	Standard Speed	ENG*	[0 to 100 / 26 / 1%/step]
2-230-002	QL Power Setting	Middle Speed	ENG*	[0 to 100 / 13 / 1%/step]
2-230-003	QL Power Setting	Low Speed	ENG*	[0 to 100 / 13 / 1%/step]
2-241-003	Temperature/Humidity: Display	Exec Interval: Extra Fan Control	ENG*	[1 to 3600 / 10 / 1sec/step]
2-241-004	AIT Temperature	AIT Temperature	ENG	[0.0 to 70.0 / 0.0 / 0.1deg/step]
2-242-001	TS Operation Env. Log	TS<=A-3	ENG	[0 to 99999999 / 0 / 1mm/step]
2-242-002	TS Operation Env. Log	A-3<TS<=A	ENG	[0 to 99999999 / 0 / 1mm/step]
2-242-003	TS Operation Env. Log	A<TS<=A+3	ENG	[0 to 99999999 / 0 / 1mm/step]
2-242-004	TS Operation Env. Log	A+3<TS	ENG	[0 to 99999999 / 0 / 1mm/step]
2-242-100	TS Operation Env. Log	Log Clear	ENG	[0 to 1 / 0 / 1/step]
2-250-001	Interval Downmode	ON/OFF Setting	ENG	[0 to 1 / 1 / 1/step]
2-302-001	Environmental Correction:Trans	Current Environmental Display	ENG	[0 to 0 / 0 / 0/step]

3.SP Mode Tables

SP No.	Large Category	Small Category	ENG or CTL	[Min to Max/Init./Step]
2-302-002	Environmental Correction:Trans	Forced Setting	ENG*	[0 to 6 / 0 / 1/step]
2-302-003	Environmental Correction:Trans	Absolute Humidity:Threshold 1	ENG*	[0.00 to 100.00 / 4.00 / 0.01g/m3/step]
2-302-004	Environmental Correction:Trans	Absolute Humidity:Threshold 2	ENG*	[0.00 to 100.00 / 8.00 / 0.01g/m3/step]
2-302-005	Environmental Correction:Trans	Absolute Humidity:Threshold 3	ENG*	[0.00 to 100.00 / 16.00 / 0.01g/m3/step]
2-302-006	Environmental Correction:Trans	Absolute Humidity:Threshold 4	ENG*	[0.00 to 100.00 / 24.00 / 0.01g/m3/step]
2-302-007	Environmental Correction:Trans	Temperature:Threshold	ENG*	[-5 to 30 / 5 / 1deg/step]
2-303-001	Time-Lapse Correction	Current Div K	ENG*	[0 to 3 / 0 / 1/step]
2-303-002	Time-Lapse Correction	Current Div C	ENG*	[0 to 3 / 0 / 1/step]
2-303-003	Time-Lapse Correction	Current Div M	ENG*	[0 to 3 / 0 / 1/step]
2-303-004	Time-Lapse Correction	Current Div Y	ENG*	[0 to 3 / 0 / 1/step]
2-303-005	Time-Lapse Correction	Correction Threshold 1_Bk	ENG*	[0 to 600000 / 5000 / 10page/step]
2-303-006	Time-Lapse Correction	Correction Threshold 1_Color	ENG*	[0 to 600000 / 5000 / 10page/step]

3.SP Mode Tables

SP No.	Large Category	Small Category	ENG or CTL	[Min to Max/Init./Step]
2-303-007	Time-Lapse Correction	Correction Threshold 2_Bk	ENG*	[0 to 600000 / 20000 / 10page/step]
2-303-008	Time-Lapse Correction	Correction Threshold 2_Color	ENG*	[0 to 600000 / 20000 / 10page/step]
2-303-009	Time-Lapse Correction	Correction Threshold 3_Bk	ENG*	[0 to 600000 / 50000 / 10page/step]
2-303-010	Time-Lapse Correction	Correction Threshold 3_Color	ENG*	[0 to 600000 / 50000 / 10page/step]
2-308-001	Paper Size Correction	Threshold 1	ENG*	[0 to 350 / 297 / 1mm/step]
2-308-002	Paper Size Correction	Threshold 2	ENG*	[0 to 350 / 257 / 1mm/step]
2-308-003	Paper Size Correction	Threshold 3	ENG*	[0 to 350 / 210 / 1mm/step]
2-308-004	Paper Size Correction	Threshold 4	ENG*	[0 to 350 / 148 / 1mm/step]
2-308-005	Paper Size Correction	Threshold 1	ENG*	[0 to 350 / 297 / 1mm/step]
2-308-006	Paper Size Correction	Threshold 2	ENG*	[0 to 350 / 257 / 1mm/step]
2-308-007	Paper Size Correction	Threshold 3	ENG*	[0 to 350 / 210 / 1mm/step]
2-308-008	Paper Size Correction	Threshold 4	ENG*	[0 to 350 / 148 / 1mm/step]

3.SP Mode Tables

SP No.	Large Category	Small Category	ENG or CTL	[Min to Max/Init./Step]
2-311-001	Non Image Area:Bias	Image Transfer	ENG*	[10 to 250 / 100 / 5%/step]
2-311-002	Non Image Area:Bias	Paper Transfer	ENG*	[0 to 200 / 0 / 1-uA/step]
2-311-003	Non Image Area:Bias	Paper Transfer	ENG*	[0 to 2100 / 500 / 10V/step]
2-316-001	Power ON:Bias	Image Transfer	ENG*	[0 to 60 / 5 / 1uA/step]
2-326-001	Transfer Roller CL:Bias	Positive:befor and after JOB	ENG*	[0 to 2100 / 250 / 10V/step]
2-326-002	Transfer Roller CL:Bias	Negative:befor and after JOB	ENG*	[10 to 995 / 100 / 10%/step]
2-326-003	Transfer Roller CL:Bias	Positive:befor and afterProcon	ENG*	[0 to 2100 / 2000 / 10V/step]
2-326-004	Transfer Roller CL:Bias	Negative:befor and afterProcon	ENG*	[10 to 995 / 100 / 10%/step]
2-326-005	Transfer Roller CL:Bias	Positive:prevention	ENG*	[0 to 2100 / 500 / 10V/step]
2-326-011	Transfer Roller CL:Env	Positive:befor and after JOB	ENG*	[1 to 110 / 100 / 1/step]
2-326-013	Transfer Roller CL:Env	Positive:befor and afterProcon	ENG*	[1 to 110 / 100 / 1/step]
2-326-015	Transfer Roller CL:Env	Positive:prevention	ENG*	[1 to 110 / 100 / 1/step]

SP2-XXX (Drum) - 2

SP No.	Large Category	Small Category	ENG or CTL	[Min to Max/Init./Step]
2-351-001	Common:BW:Bias	Image Transfer:standard	ENG *	IM C3500: [0 to 60 / 33 / 1uA/step] IM C2500: [0 to 60 / 28 / 1uA/step] IM C2000: [0 to 60 / 28 / 1uA/step] IM C3000: [0 to 60 / 33 / 1uA/step]
2-351-002	Common:BW:Bias	Image Transfer:Middle	ENG	IM C3500: [0 to 60 / 24 / 1uA/step] IM C2500: [0 to 60 / 24 / 1uA/step] IM C2000: [0 to 60 / 24 / 1uA/step] IM C3000: [0 to 60 / 24 / 1uA/step]
2-351-003	Common:BW:Bias	Image Transfer:low	ENG	IM C3500: [0 to 60 / 16 / 1uA/step] IM C2500: [0 to 60 / 13 / 1uA/step] IM C2000: [0 to 60 / 13 / 1uA/step] IM C3000: [0 to 60 / 16 /

3.SP Mode Tables

SP No.	Large Category	Small Category	ENG or CTL	[Min to Max/Init./Step]
				1uA/step]
2-357-001	Common:FC:Bias	ImageTransfer:standard:Bk	ENG *	IM C3500: [0 to 60 / 33 / 1uA/step] IM C2500: [0 to 60 / 28 / 1uA/step] IM C2000: [0 to 60 / 28 / 1uA/step] IM C3000: [0 to 60 / 33 / 1uA/step]
2-357-002	Common:FC:Bias	ImageTransfer:standard:C	ENG *	IM C3500: [0 to 60 / 33 / 1uA/step] IM C2500: [0 to 60 / 27 / 1uA/step] IM C2000: [0 to 60 / 27 / 1uA/step] IM C3000: [0 to 60 / 33 / 1uA/step]
2-357-003	Common:FC:Bias	ImageTransfer:standard:M	ENG *	IM C3500: [0 to 60 / 35 / 1uA/step] IM C2500: [0 to 60 / 27 / 1uA/step] IM C2000: [0 to 60 / 27 / 1uA/step] IM C3000: [0 to 60 / 35 /

3.SP Mode Tables

SP No.	Large Category	Small Category	ENG or CTL	[Min to Max/Init./Step]
				1uA/step]
2-357-004	Common:FC:Bias	ImageTransfer:standard:Y	ENG *	IM C3500: [0 to 60 / 38 / 1uA/step] IM C2500: [0 to 60 / 28 / 1uA/step] IM C2000: [0 to 60 / 28 / 1uA/step] IM C3000: [0 to 60 / 38 / 1uA/step]
2-357-005	Common:FC:Bias	ImageTransfer:Middle:Bk	ENG	IM C3500: [0 to 60 / 24 / 1uA/step] IM C2500: [0 to 60 / 24 / 1uA/step] IM C2000: [0 to 60 / 24 / 1uA/step] IM C3000: [0 to 60 / 24 / 1uA/step]
2-357-006	Common:FC:Bias	ImageTransfer:Middle:C	ENG	IM C3500: [0 to 60 / 24 / 1uA/step] IM C2500: [0 to 60 / 24 / 1uA/step] IM C2000: [0 to 60 / 24 / 1uA/step] IM C3000: [0 to 60 / 24 /

3.SP Mode Tables

SP No.	Large Category	Small Category	ENG or CTL	[Min to Max/Init./Step]
				1uA/step]
2-357-007	Common:FC:Bias	ImageTransfer:Middle:M	ENG	IM C3500: [0 to 60 / 26 / 1uA/step] IM C2500: [0 to 60 / 26 / 1uA/step] IM C2000: [0 to 60 / 26 / 1uA/step] IM C3000: [0 to 60 / 26 / 1uA/step]
2-357-008	Common:FC:Bias	ImageTransfer:Middle:Y	ENG	IM C3500: [0 to 60 / 28 / 1uA/step] IM C2500: [0 to 60 / 28 / 1uA/step] IM C2000: [0 to 60 / 28 / 1uA/step] IM C3000: [0 to 60 / 28 / 1uA/step]
2-357-009	Common:FC:Bias	Image Transfer:low:Bk	ENG	IM C3500: [0 to 60 / 16 / 1uA/step] IM C2500: [0 to 60 / 12 / 1uA/step] IM C2000: [0 to 60 / 12 / 1uA/step] IM C3000: [0 to 60 / 16 /

3.SP Mode Tables

SP No.	Large Category	Small Category	ENG or CTL	[Min to Max/Init./Step]
				1uA/step]
2-357-010	Common:FC:Bias	Image Transfer:low:C	ENG	IM C3500: [0 to 60 / 16 / 1uA/step] IM C2500: [0 to 60 / 11 / 1uA/step] IM C2000: [0 to 60 / 11 / 1uA/step] IM C3000: [0 to 60 / 16 / 1uA/step]
2-357-011	Common:FC:Bias	Image Transfer:low:M	ENG	IM C3500: [0 to 60 / 18 / 1uA/step] IM C2500: [0 to 60 / 11 / 1uA/step] IM C2000: [0 to 60 / 11 / 1uA/step] IM C3000: [0 to 60 / 18 / 1uA/step]
2-357-012	Common:FC:Bias	Image Transfer:low:Y	ENG	IM C3500: [0 to 60 / 19 / 1uA/step] IM C2500: [0 to 60 / 12 / 1uA/step] IM C2000: [0 to 60 / 12 / 1uA/step] IM C3000: [0 to 60 / 19 /

3.SP Mode Tables

SP No.	Large Category	Small Category	ENG or CTL	[Min to Max/Init./Step]
				1uA/step]
2-358-001	TC adjust Process Control: Bias	ImageTransfer:standard:FC:Bk	ENG *	IM C3500: [0 to 60 / 33 / 1uA/step] IM C2500: [0 to 60 / 28 / 1uA/step] IM C2000: [0 to 60 / 28 / 1uA/step] IM C3000: [0 to 60 / 33 / 1uA/step]
2-358-002	TC adjust Process Control: Bias	ImageTransfer:standard:FC:C	ENG *	IM C3500: [0 to 60 / 33 / 1uA/step] IM C2500: [0 to 60 / 27 / 1uA/step] IM C2000: [0 to 60 / 27 / 1uA/step] IM C3000: [0 to 60 / 33 / 1uA/step]
2-358-003	TC adjust Process Control: Bias	ImageTransfer:standard:FC:M	ENG *	IM C3500: [0 to 60 / 35 / 1uA/step] IM C2500: [0 to 60 / 27 / 1uA/step] IM C2000: [0 to 60 / 27 / 1uA/step] IM C3000: [0 to 60 / 35 /

3.SP Mode Tables

SP No.	Large Category	Small Category	ENG or CTL	[Min to Max/Init./Step]
				1uA/step]
2-358-004	TC adjust Process Control: Bias	ImageTransfer:standard:FC:Y	ENG *	IM C3500: [0 to 60 / 38 / 1uA/step] IM C2500: [0 to 60 / 28 / 1uA/step] IM C2000: [0 to 60 / 28 / 1uA/step] IM C3000: [0 to 60 / 38 / 1uA/step]
2-358-005	TC adjust Process Control: Bias	ImageTransfer:standard:Bk:Bk	ENG *	IM C3500: [0 to 60 / 33 / 1uA/step] IM C2500: [0 to 60 / 28 / 1uA/step] IM C2000: [0 to 60 / 28 / 1uA/step] IM C3000: [0 to 60 / 33 / 1uA/step]
2-360-001	Common:BW:Env.CorrectionTable	Image Transfer:standard	ENG *	IM C3500: [1 to 110 / 2 / 1/step] IM C2500: [1 to 110 / 13 / 1/step] IM C2000: [1 to 110 / 13 / 1/step] IM C3000: [1 to 110 / 2 /

3.SP Mode Tables

SP No.	Large Category	Small Category	ENG or CTL	[Min to Max/Init./Step]
				1/step]
2-360-002	Common:BW:Env.CorrectionTable	Image Transfer:Middle	ENG	[1 to 110 / 2 / 1/step]
2-360-003	Common:BW:Env.CorrectionTable	Image Transfer:low	ENG	IM C3500: [1 to 110 / 2 / 1/step] IM C2500: [1 to 110 / 54 / 1/step] IM C2000: [1 to 110 / 54 / 1/step] IM C3000: [1 to 110 / 2 / 1/step]
2-360-004	Common:FC:Env.CorrectionTable	ImageTransfer:standard:Bk	ENG *	IM C3500: [1 to 110 / 1 / 1/step] IM C2500: [1 to 110 / 13 / 1/step] IM C2000: [1 to 110 / 13 / 1/step] IM C3000: [1 to 110 / 1 / 1/step]
2-360-005	Common:FC:Env.CorrectionTable	ImageTransfer:standard:C	ENG *	IM C3500: [1 to 110 / 2 / 1/step] IM C2500: [1 to 110 / 54 / 1/step] IM C2000:

3.SP Mode Tables

SP No.	Large Category	Small Category	ENG or CTL	[Min to Max/Init./Step]
				[1 to 110 / 54 / 1/step] IM C3000: [1 to 110 / 2 / 1/step]
2-360-006	Common:FC:Env.CorrectionTable	ImageTransfer:standard:M	ENG*	IM C3500: [1 to 110 / 3 / 1/step] IM C2500: [1 to 110 / 54 / 1/step] IM C2000: [1 to 110 / 54 / 1/step] IM C3000: [1 to 110 / 3 / 1/step]
2-360-007	Common:FC:Env.CorrectionTable	ImageTransfer:standard:Y	ENG*	IM C3500: [1 to 110 / 4 / 1/step] IM C2500: [1 to 110 / 55 / 1/step] IM C2000: [1 to 110 / 55 / 1/step] IM C3000: [1 to 110 / 4 / 1/step]
2-360-008	Common:FC:Env.CorrectionTable	ImageTransfer:Middle:Bk	ENG	[1 to 110 / 1 / 1/step]
2-360-	Common:FC:Env.CorrectionTable	ImageTransfer:Middle:C	ENG	[1 to 110 / 2 / 1/step]

3.SP Mode Tables

SP No.	Large Category	Small Category	ENG or CTL	[Min to Max/Init./Step]
009				
2-360-010	Common:FC:Env.CorrectionTable	ImageTransfer:Middle:M	ENG	[1 to 110 / 3 / 1/step]
2-360-011	Common:FC:Env.CorrectionTable	ImageTransfer:Middle:Y	ENG	[1 to 110 / 4 / 1/step]
2-360-012	Common:FC:Env.CorrectionTable	Image Transfer:low:Bk	ENG	IM C3500: [1 to 110 / 1 / 1/step] IM C2500: [1 to 110 / 15 / 1/step] IM C2000: [1 to 110 / 15 / 1/step] IM C3000: [1 to 110 / 1 / 1/step]
2-360-013	Common:FC:Env.CorrectionTable	Image Transfer:low:C	ENG	IM C3500: [1 to 110 / 2 / 1/step] IM C2500: [1 to 110 / 55 / 1/step] IM C2000: [1 to 110 / 55 / 1/step] IM C3000: [1 to 110 / 2 / 1/step]
2-360-	Common:FC:Env.CorrectionTable	Image Transfer:low:M	ENG	IM C3500: [1 to 110 / 3 / 1/step]

3.SP Mode Tables

SP No.	Large Category	Small Category	ENG or CTL	[Min to Max/Init./Step]
014				IM C2500: [1 to 110 / 56 / 1/step] IM C2000: [1 to 110 / 56 / 1/step] IM C3000: [1 to 110 / 3 / 1/step]
2-360-015	Common:FC:Env.CorrectionTable	Image Transfer:low:Y	ENG	IM C3500: [1 to 110 / 4 / 1/step] IM C2500: [1 to 110 / 56 / 1/step] IM C2000: [1 to 110 / 56 / 1/step] IM C3000: [1 to 110 / 4 / 1/step]
2-361-001	Time-Lapse Correction: Div 1	Standard Speed: Bk	ENG *	[1 to 60 / 2 / 1/step]
2-361-002	Time-Lapse Correction: Div 1	Mid Speed: Bk	ENG	[1 to 60 / 2 / 1/step]
2-361-003	Time-Lapse Correction: Div 1	Low Speed: Bk	ENG	[1 to 60 / 2 / 1/step]
2-361-	Time-Lapse Correction: Div 1	Standard Speed: FC: K	ENG *	[1 to 60 / 1 / 1/step]

3.SP Mode Tables

SP No.	Large Category	Small Category	ENG or CTL	[Min to Max/Init./Step]
004				
2-361-005	Time-Lapse Correction: Div 1	Standard Speed: FC: C	ENG *	[1 to 60 / 1 / 1/step]
2-361-006	Time-Lapse Correction: Div 1	Standard Speed: FC: M	ENG *	[1 to 60 / 1 / 1/step]
2-361-007	Time-Lapse Correction: Div 1	Standard Speed: FC: Y	ENG *	[1 to 60 / 1 / 1/step]
2-361-008	Time-Lapse Correction: Div 1	Mid Speed: FC: K	ENG	[1 to 60 / 1 / 1/step]
2-361-009	Time-Lapse Correction: Div 1	Mid Speed: FC: C	ENG	[1 to 60 / 1 / 1/step]
2-361-010	Time-Lapse Correction: Div 1	Mid Speed: FC: M	ENG	[1 to 60 / 1 / 1/step]
2-361-011	Time-Lapse Correction: Div 1	Mid Speed: FC: Y	ENG	[1 to 60 / 1 / 1/step]
2-361-012	Time-Lapse Correction: Div 1	Low Speed: FC: K	ENG	[1 to 60 / 1 / 1/step]
2-361-	Time-Lapse Correction: Div 1	Low Speed: FC: C	ENG	[1 to 60 / 1 / 1/step]

3.SP Mode Tables

SP No.	Large Category	Small Category	ENG or CTL	[Min to Max/Init./Step]
013				
2-361-014	Time-Lapse Correction: Div 1	Low Speed: FC: M	ENG	[1 to 60 / 1 / 1/step]
2-361-015	Time-Lapse Correction: Div 1	Low Speed: FC: Y	ENG	[1 to 60 / 1 / 1/step]
2-362-001	Time-Lapse Correction: Div 2	Standard Speed: Bk	ENG *	[1 to 60 / 3 / 1/step]
2-362-002	Time-Lapse Correction: Div 2	Mid Speed: Bk	ENG	[1 to 60 / 3 / 1/step]
2-362-003	Time-Lapse Correction: Div 2	Low Speed: Bk	ENG	[1 to 60 / 3 / 1/step]
2-362-004	Time-Lapse Correction: Div 2	Standard Speed: FC: K	ENG *	[1 to 60 / 1 / 1/step]
2-362-005	Time-Lapse Correction: Div 2	Standard Speed: FC: C	ENG *	[1 to 60 / 1 / 1/step]
2-362-006	Time-Lapse Correction: Div 2	Standard Speed: FC: M	ENG *	[1 to 60 / 1 / 1/step]
2-362-	Time-Lapse Correction: Div 2	Standard Speed: FC: Y	ENG *	[1 to 60 / 1 / 1/step]

3.SP Mode Tables

SP No.	Large Category	Small Category	ENG or CTL	[Min to Max/Init./Step]
007				
2-362-008	Time-Lapse Correction: Div 2	Mid Speed: FC: K	ENG	[1 to 60 / 1 / 1/step]
2-362-009	Time-Lapse Correction: Div 2	Mid Speed: FC: C	ENG	[1 to 60 / 1 / 1/step]
2-362-010	Time-Lapse Correction: Div 2	Mid Speed: FC: M	ENG	[1 to 60 / 1 / 1/step]
2-362-011	Time-Lapse Correction: Div 2	Mid Speed: FC: Y	ENG	[1 to 60 / 1 / 1/step]
2-362-012	Time-Lapse Correction: Div 2	Low Speed: FC: K	ENG	[1 to 60 / 1 / 1/step]
2-362-013	Time-Lapse Correction: Div 2	Low Speed: FC: C	ENG	[1 to 60 / 1 / 1/step]
2-362-014	Time-Lapse Correction: Div 2	Low Speed: FC: M	ENG	[1 to 60 / 1 / 1/step]
2-362-015	Time-Lapse Correction: Div 2	Low Speed: FC: Y	ENG	[1 to 60 / 1 / 1/step]
2-363-	Time-Lapse Correction: Div 3	Standard Speed: Bk	ENG *	[1 to 60 / 4 / 1/step]

3.SP Mode Tables

SP No.	Large Category	Small Category	ENG or CTL	[Min to Max/Init./Step]
001				
2-363-002	Time-Lapse Correction: Div 3	Mid Speed: Bk	ENG	[1 to 60 / 4 / 1/step]
2-363-003	Time-Lapse Correction: Div 3	Low Speed: Bk	ENG	[1 to 60 / 4 / 1/step]
2-363-004	Time-Lapse Correction: Div 3	Standard Speed: FC: K	ENG *	[1 to 60 / 1 / 1/step]
2-363-005	Time-Lapse Correction: Div 3	Standard Speed: FC: C	ENG *	[1 to 60 / 1 / 1/step]
2-363-006	Time-Lapse Correction: Div 3	Standard Speed: FC: M	ENG *	[1 to 60 / 1 / 1/step]
2-363-007	Time-Lapse Correction: Div 3	Standard Speed: FC: Y	ENG *	[1 to 60 / 1 / 1/step]
2-363-008	Time-Lapse Correction: Div 3	Mid Speed: FC: K	ENG	[1 to 60 / 1 / 1/step]
2-363-009	Time-Lapse Correction: Div 3	Mid Speed: FC: C	ENG	[1 to 60 / 1 / 1/step]
2-363-	Time-Lapse Correction: Div 3	Mid Speed: FC: M	ENG	[1 to 60 / 1 / 1/step]

3.SP Mode Tables

SP No.	Large Category	Small Category	ENG or CTL	[Min to Max/Init./Step]
010				
2-363-011	Time-Lapse Correction: Div 3	Mid Speed: FC: Y	ENG	[1 to 60 / 1 / 1/step]
2-363-012	Time-Lapse Correction: Div 3	Low Speed: FC: K	ENG	[1 to 60 / 1 / 1/step]
2-363-013	Time-Lapse Correction: Div 3	Low Speed: FC: C	ENG	[1 to 60 / 1 / 1/step]
2-363-014	Time-Lapse Correction: Div 3	Low Speed: FC: M	ENG	[1 to 60 / 1 / 1/step]
2-363-015	Time-Lapse Correction: Div 3	Low Speed: FC: Y	ENG	[1 to 60 / 1 / 1/step]
2-400-001	Paper Transfer Roller Settings	Width of Paper Transfer Roller	ENG *	[0 to 1 / 0 / 1/step]
2-400-002	Paper Transfer Roller Settings	Detatch timing in waiting	ENG *	[0 to 600 / 240 / 1min/step]
2-403-001	Plain1:Bias:BW	PaperTransfer:standard:1side	ENG	IM C3500: [0 to 200 / 22 / 1-uA/step] IM C2500: [0 to 200 / 22 / 1-uA/step] IM C2000:

3.SP Mode Tables

SP No.	Large Category	Small Category	ENG or CTL	[Min to Max/Init./Step]
				[0 to 200 / 22 / 1-uA/step] IM C3000: [0 to 200 / 22 / 1-uA/step]
2-403-002	Plain1:Bias:BW	PaperTransfer:standard:2side	ENG	IM C3500: [0 to 200 / 22 / 1-uA/step] IM C2500: [0 to 200 / 22 / 1-uA/step] IM C2000: [0 to 200 / 22 / 1-uA/step] IM C3000: [0 to 200 / 22 / 1-uA/step]
2-403-003	Plain1:Bias:BW	PaperTransfer:low:1side	ENG	IM C3500: [0 to 200 / 11 / 1-uA/step] IM C2500: [0 to 200 / 11 / 1-uA/step] IM C2000: [0 to 200 / 11 / 1-uA/step] IM C3000: [0 to 200 / 11 / 1-uA/step]
2-403-004	Plain1:Bias:BW	PaperTransfer:low:2side	ENG	IM C3500: [0 to 200 / 11 / 1-uA/step] IM C2500: [0 to 200 / 11 / 1-uA/step] IM C2000:

3.SP Mode Tables

SP No.	Large Category	Small Category	ENG or CTL	[Min to Max/Init./Step]
				[0 to 200 / 11 / 1-uA/step] IM C3000: [0 to 200 / 11 / 1-uA/step]
2-407-001	Plain1:Bias:FC	PaperTransfer:standard:1side	ENG *	IM C3500: [0 to 200 / 29 / 1-uA/step] IM C2500: [0 to 200 / 29 / 1-uA/step] IM C2000: [0 to 200 / 29 / 1-uA/step] IM C3000: [0 to 200 / 29 / 1-uA/step]
2-407-002	Plain1:Bias:FC	PaperTransfer:standard:2side	ENG	IM C3500: [0 to 200 / 29 / 1-uA/step] IM C2500: [0 to 200 / 29 / 1-uA/step] IM C2000: [0 to 200 / 29 / 1-uA/step] IM C3000: [0 to 200 / 29 / 1-uA/step]
2-407-003	Plain1:Bias:FC	PaperTransfer:low:1side	ENG	IM C3500: [0 to 200 / 14 / 1-uA/step] IM C2500: [0 to 200 / 14 / 1-uA/step] IM C2000:

3.SP Mode Tables

SP No.	Large Category	Small Category	ENG or CTL	[Min to Max/Init./Step]
				[0 to 200 / 14 / 1-uA/step] IM C3000: [0 to 200 / 14 / 1-uA/step]
2-407-004	Plain1:Bias:FC	PaperTransfer:low:2side	ENG	IM C3500: [0 to 200 / 14 / 1-uA/step] IM C2500: [0 to 200 / 14 / 1-uA/step] IM C2000: [0 to 200 / 14 / 1-uA/step] IM C3000: [0 to 200 / 14 / 1-uA/step]
2-411-001	Plain1:SizeCorrection:BW	PaperTransfer:Standard:1Sid:S1	ENG	[100 to 995 / 100 / 1%/step]
2-411-002	Plain1:SizeCorrection:BW	PaperTransfer:Standard:2Sid:S1	ENG	[100 to 995 / 100 / 1%/step]
2-411-003	Plain1:SizeCorrection:BW	PaperTransfer:Low:1Side:S1	ENG	[100 to 995 / 100 / 1%/step]
2-411-004	Plain1:SizeCorrection:BW	PaperTransfer:Low:2Side:S1	ENG	[100 to 995 / 100 / 1%/step]
2-411-	Plain1:SizeCorrection:BW	PaperTransfer:Standard:1Sid:S2	ENG	[100 to 995 / 100 / 1%/step]

3.SP Mode Tables

SP No.	Large Category	Small Category	ENG or CTL	[Min to Max/Init./Step]
005				
2-411-006	Plain1:SizeCorrection:BW	PaperTransfer:Standard:2Sid:S2	ENG	[100 to 995 / 105 / 1%/step]
2-411-007	Plain1:SizeCorrection:BW	PaperTransfer:Low:1Side:S2	ENG	[100 to 995 / 100 / 1%/step]
2-411-008	Plain1:SizeCorrection:BW	PaperTransfer:Low:2Side:S2	ENG	[100 to 995 / 105 / 1%/step]
2-411-009	Plain1:SizeCorrection:BW	PaperTransfer:Standard:1Sid:S3	ENG	[100 to 995 / 105 / 1%/step]
2-411-010	Plain1:SizeCorrection:BW	PaperTransfer:Standard:2Sid:S3	ENG	[100 to 995 / 118 / 1%/step]
2-411-011	Plain1:SizeCorrection:BW	PaperTransfer:Low:1Side:S3	ENG	[100 to 995 / 105 / 1%/step]
2-411-012	Plain1:SizeCorrection:BW	PaperTransfer:Low:2Side:S3	ENG	[100 to 995 / 118 / 1%/step]
2-411-013	Plain1:SizeCorrection:BW	PaperTransfer:Standard:1Sid:S4	ENG	[100 to 995 / 118 / 1%/step]
2-411-	Plain1:SizeCorrection:BW	PaperTransfer:Standard:2Sid:S4	ENG	[100 to 995 / 131 / 1%/step]

3.SP Mode Tables

SP No.	Large Category	Small Category	ENG or CTL	[Min to Max/Init./Step]
014				
2-411-015	Plain1:SizeCorrection:BW	PaperTransfer:Low:1Side:S4	ENG	[100 to 995 / 118 / 1%/step]
2-411-016	Plain1:SizeCorrection:BW	PaperTransfer:Low:2Side:S4	ENG	[100 to 995 / 131 / 1%/step]
2-411-017	Plain1:SizeCorrection:BW	PaperTransfer:Standard:1Sid:S5	ENG	[100 to 995 / 132 / 1%/step]
2-411-018	Plain1:SizeCorrection:BW	PaperTransfer:Standard:2Sid:S5	ENG	[100 to 995 / 184 / 1%/step]
2-411-019	Plain1:SizeCorrection:BW	PaperTransfer:Low:1Side:S5	ENG	[100 to 995 / 132 / 1%/step]
2-411-020	Plain1:SizeCorrection:BW	PaperTransfer:Low:2Side:S5	ENG	[100 to 995 / 184 / 1%/step]
2-411-021	Plain1:SizeCorrection:BW	Wide Roller:PaperTransfer:Standard:1Sid:S1	ENG	[100 to 995 / 100 / 1%/step]
2-411-022	Plain1:SizeCorrection:BW	Wide Roller:PaperTransfer:Standard:2Sid:S1	ENG	[100 to 995 / 100 / 1%/step]
2-411-	Plain1:SizeCorrection:BW	Wide Roller:PaperTransfer:Low:1Side:S1	ENG	[100 to 995 / 100 / 1%/step]

3.SP Mode Tables

SP No.	Large Category	Small Category	ENG or CTL	[Min to Max/Init./Step]
023				
2-411-024	Plain1:SizeCorrection:BW	Wide Roller:PaperTransfer:Low:2Side:S1	ENG	[100 to 995 / 100 / 1%/step]
2-411-025	Plain1:SizeCorrection:BW	Wide Roller:PaperTransfer:Standard:1Side:S2	ENG	[100 to 995 / 100 / 1%/step]
2-411-026	Plain1:SizeCorrection:BW	Wide Roller:PaperTransfer:Standard:2Side:S2	ENG	[100 to 995 / 105 / 1%/step]
2-411-027	Plain1:SizeCorrection:BW	Wide Roller:PaperTransfer:Low:1Side:S2	ENG	[100 to 995 / 100 / 1%/step]
2-411-028	Plain1:SizeCorrection:BW	Wide Roller:PaperTransfer:Low:2Side:S2	ENG	[100 to 995 / 105 / 1%/step]
2-411-029	Plain1:SizeCorrection:BW	Wide Roller:PaperTransfer:Standard:1Side:S3	ENG	[100 to 995 / 105 / 1%/step]
2-411-030	Plain1:SizeCorrection:BW	Wide Roller:PaperTransfer:Standard:2Side:S3	ENG	[100 to 995 / 118 / 1%/step]
2-411-031	Plain1:SizeCorrection:BW	Wide Roller:PaperTransfer:Low:1Side:S3	ENG	[100 to 995 / 105 / 1%/step]
2-411-	Plain1:SizeCorrection:BW	Wide Roller:PaperTransfer:Low:2Side:S3	ENG	[100 to 995 / 118 / 1%/step]

3.SP Mode Tables

SP No.	Large Category	Small Category	ENG or CTL	[Min to Max/Init./Step]
032				
2-411-033	Plain1:SizeCorrection:BW	Wide Roller:PaperTransfer:Standard:1Sid:S4	ENG	[100 to 995 / 118 / 1%/step]
2-411-034	Plain1:SizeCorrection:BW	Wide Roller:PaperTransfer:Standard:2Sid:S4	ENG	[100 to 995 / 131 / 1%/step]
2-411-035	Plain1:SizeCorrection:BW	Wide Roller:PaperTransfer:Low:1Side:S4	ENG	[100 to 995 / 118 / 1%/step]
2-411-036	Plain1:SizeCorrection:BW	Wide Roller:PaperTransfer:Low:2Side:S4	ENG	[100 to 995 / 131 / 1%/step]
2-411-037	Plain1:SizeCorrection:BW	Wide Roller:PaperTransfer:Standard:1Sid:S5	ENG	[100 to 995 / 132 / 1%/step]
2-411-038	Plain1:SizeCorrection:BW	Wide Roller:PaperTransfer:Standard:2Sid:S5	ENG	[100 to 995 / 184 / 1%/step]
2-411-039	Plain1:SizeCorrection:BW	Wide Roller:PaperTransfer:Low:1Side:S5	ENG	[100 to 995 / 132 / 1%/step]
2-411-040	Plain1:SizeCorrection:BW	Wide Roller:PaperTransfer:Low:2Side:S5	ENG	[100 to 995 / 184 / 1%/step]
2-412-	Plain1:SizeCorrection:FC	PaperTransfer:Standard:1Sid:S1	ENG	[100 to 995 / 100 / 1%/step]

3.SP Mode Tables

SP No.	Large Category	Small Category	ENG or CTL	[Min to Max/Init./Step]
001				
2-412-002	Plain1:SizeCorrection:FC	PaperTransfer:Standard:2Sid:S1	ENG	[100 to 995 / 100 / 1%/step]
2-412-003	Plain1:SizeCorrection:FC	PaperTransfer:Low:1Side:S1	ENG	[100 to 995 / 100 / 1%/step]
2-412-004	Plain1:SizeCorrection:FC	PaperTransfer:Low:2Side:S1	ENG	[100 to 995 / 100 / 1%/step]
2-412-005	Plain1:SizeCorrection:FC	PaperTransfer:Standard:1Sid:S2	ENG	[100 to 995 / 120 / 1%/step]
2-412-006	Plain1:SizeCorrection:FC	PaperTransfer:Standard:2Sid:S2	ENG	[100 to 995 / 140 / 1%/step]
2-412-007	Plain1:SizeCorrection:FC	PaperTransfer:Low:1Side:S2	ENG	[100 to 995 / 120 / 1%/step]
2-412-008	Plain1:SizeCorrection:FC	PaperTransfer:Low:2Side:S2	ENG	[100 to 995 / 140 / 1%/step]
2-412-009	Plain1:SizeCorrection:FC	PaperTransfer:Standard:1Sid:S3	ENG	[100 to 995 / 118 / 1%/step]
2-412-	Plain1:SizeCorrection:FC	PaperTransfer:Standard:2Sid:S3	ENG	[100 to 995 / 180 / 1%/step]

3.SP Mode Tables

SP No.	Large Category	Small Category	ENG or CTL	[Min to Max/Init./Step]
010				
2-412-011	Plain1:SizeCorrection:FC	PaperTransfer:Low:1Side:S3	ENG	[100 to 995 / 118 / 1%/step]
2-412-012	Plain1:SizeCorrection:FC	PaperTransfer:Low:2Side:S3	ENG	[100 to 995 / 180 / 1%/step]
2-412-013	Plain1:SizeCorrection:FC	PaperTransfer:Standard:1Sid:S4	ENG	[100 to 995 / 130 / 1%/step]
2-412-014	Plain1:SizeCorrection:FC	PaperTransfer:Standard:2Sid:S4	ENG	[100 to 995 / 200 / 1%/step]
2-412-015	Plain1:SizeCorrection:FC	PaperTransfer:Low:1Side:S4	ENG	[100 to 995 / 130 / 1%/step]
2-412-016	Plain1:SizeCorrection:FC	PaperTransfer:Low:2Side:S4	ENG	[100 to 995 / 200 / 1%/step]
2-412-017	Plain1:SizeCorrection:FC	PaperTransfer:Standard:1Sid:S5	ENG	[100 to 995 / 140 / 1%/step]
2-412-018	Plain1:SizeCorrection:FC	PaperTransfer:Standard:2Sid:S5	ENG	[100 to 995 / 240 / 1%/step]
2-412-	Plain1:SizeCorrection:FC	PaperTransfer:Low:1Side:S5	ENG	[100 to 995 / 140 / 1%/step]

3.SP Mode Tables

SP No.	Large Category	Small Category	ENG or CTL	[Min to Max/Init./Step]
019				
2-412-020	Plain1:SizeCorrection:FC	PaperTransfer:Low:2Side:S5	ENG	[100 to 995 / 240 / 1%/step]
2-412-021	Plain1:SizeCorrection:FC	Wide Roller:PaperTransfer:Standard:1Side:S1	ENG	[100 to 995 / 100 / 1%/step]
2-412-022	Plain1:SizeCorrection:FC	Wide Roller:PaperTransfer:Standard:2Side:S1	ENG	[100 to 995 / 100 / 1%/step]
2-412-023	Plain1:SizeCorrection:FC	Wide Roller:PaperTransfer:Low:1Side:S1	ENG	[100 to 995 / 100 / 1%/step]
2-412-024	Plain1:SizeCorrection:FC	Wide Roller:PaperTransfer:Low:2Side:S1	ENG	[100 to 995 / 100 / 1%/step]
2-412-025	Plain1:SizeCorrection:FC	Wide Roller:PaperTransfer:Standard:1Side:S2	ENG	[100 to 995 / 120 / 1%/step]
2-412-026	Plain1:SizeCorrection:FC	Wide Roller:PaperTransfer:Standard:2Side:S2	ENG	[100 to 995 / 140 / 1%/step]
2-412-027	Plain1:SizeCorrection:FC	Wide Roller:PaperTransfer:Low:1Side:S2	ENG	[100 to 995 / 120 / 1%/step]
2-412-	Plain1:SizeCorrection:FC	Wide Roller:PaperTransfer:Low:2Side:S2	ENG	[100 to 995 / 140 / 1%/step]

3.SP Mode Tables

SP No.	Large Category	Small Category	ENG or CTL	[Min to Max/Init./Step]
028				
2-412-029	Plain1:SizeCorrection:FC	Wide Roller:PaperTransfer:Standard:1Sid:S3	ENG	[100 to 995 / 118 / 1%/step]
2-412-030	Plain1:SizeCorrection:FC	Wide Roller:PaperTransfer:Standard:2Sid:S3	ENG	[100 to 995 / 180 / 1%/step]
2-412-031	Plain1:SizeCorrection:FC	Wide Roller:PaperTransfer:Low:1Side:S3	ENG	[100 to 995 / 118 / 1%/step]
2-412-032	Plain1:SizeCorrection:FC	Wide Roller:PaperTransfer:Low:2Side:S3	ENG	[100 to 995 / 180 / 1%/step]
2-412-033	Plain1:SizeCorrection:FC	Wide Roller:PaperTransfer:Standard:1Sid:S4	ENG	[100 to 995 / 130 / 1%/step]
2-412-034	Plain1:SizeCorrection:FC	Wide Roller:PaperTransfer:Standard:2Sid:S4	ENG	[100 to 995 / 200 / 1%/step]
2-412-035	Plain1:SizeCorrection:FC	Wide Roller:PaperTransfer:Low:1Side:S4	ENG	[100 to 995 / 130 / 1%/step]
2-412-036	Plain1:SizeCorrection:FC	Wide Roller:PaperTransfer:Low:2Side:S4	ENG	[100 to 995 / 200 / 1%/step]
2-412-	Plain1:SizeCorrection:FC	Wide Roller:PaperTransfer:Standard:1Sid:S5	ENG	[100 to 995 / 140 / 1%/step]

3.SP Mode Tables

SP No.	Large Category	Small Category	ENG or CTL	[Min to Max/Init./Step]
037				
2-412-038	Plain1:SizeCorrection:FC	Wide Roller:PaperTransfer:Standard:2Sid:S5	ENG	[100 to 995 / 240 / 1%/step]
2-412-039	Plain1:SizeCorrection:FC	Wide Roller:PaperTransfer:Low:1Side:S5	ENG	[100 to 995 / 140 / 1%/step]
2-412-040	Plain1:SizeCorrection:FC	Wide Roller:PaperTransfer:Low:2Side:S5	ENG	[100 to 995 / 240 / 1%/step]
2-413-001	Plain1:Size-Env.Correct:BW	PaperTransfer:Standard:1Sid:S1	ENG	[1 to 110 / 10 / 1/step]
2-413-002	Plain1:Size-Env.Correct:BW	PaperTransfer:Standard:2Sid:S1	ENG	[1 to 110 / 15 / 1/step]
2-413-003	Plain1:Size-Env.Correct:BW	PaperTransfer:Low:1Side:S1	ENG	[1 to 110 / 10 / 1/step]
2-413-004	Plain1:Size-Env.Correct:BW	PaperTransfer:Low:2Side:S1	ENG	[1 to 110 / 15 / 1/step]
2-413-005	Plain1:Size-Env.Correct:BW	PaperTransfer:Standard:1Sid:S2	ENG	[1 to 110 / 11 / 1/step]
2-413-	Plain1:Size-Env.Correct:BW	PaperTransfer:Standard:2Sid:S2	ENG	[1 to 110 / 16 / 1/step]

3.SP Mode Tables

SP No.	Large Category	Small Category	ENG or CTL	[Min to Max/Init./Step]
006				
2-413-007	Plain1:Size-Env.Correct:BW	PaperTransfer:Low:1Side:S2	ENG	[1 to 110 / 11 / 1/step]
2-413-008	Plain1:Size-Env.Correct:BW	PaperTransfer:Low:2Side:S2	ENG	[1 to 110 / 16 / 1/step]
2-413-009	Plain1:Size-Env.Correct:BW	PaperTransfer:Standard:1Sid:S3	ENG	[1 to 110 / 12 / 1/step]
2-413-010	Plain1:Size-Env.Correct:BW	PaperTransfer:Standard:2Sid:S3	ENG	[1 to 110 / 17 / 1/step]
2-413-011	Plain1:Size-Env.Correct:BW	PaperTransfer:Low:1Side:S3	ENG	[1 to 110 / 12 / 1/step]
2-413-012	Plain1:Size-Env.Correct:BW	PaperTransfer:Low:2Side:S3	ENG	[1 to 110 / 17 / 1/step]
2-413-013	Plain1:Size-Env.Correct:BW	PaperTransfer:Standard:1Sid:S4	ENG	[1 to 110 / 13 / 1/step]
2-413-014	Plain1:Size-Env.Correct:BW	PaperTransfer:Standard:2Sid:S4	ENG	[1 to 110 / 18 / 1/step]
2-413-	Plain1:Size-Env.Correct:BW	PaperTransfer:Low:1Side:S4	ENG	[1 to 110 / 13 / 1/step]

3.SP Mode Tables

SP No.	Large Category	Small Category	ENG or CTL	[Min to Max/Init./Step]
015				
2-413-016	Plain1:Size-Env.Correct:BW	PaperTransfer:Low:2Side:S4	ENG	[1 to 110 / 18 / 1/step]
2-413-017	Plain1:Size-Env.Correct:BW	PaperTransfer:Standard:1Sid:S5	ENG	[1 to 110 / 14 / 1/step]
2-413-018	Plain1:Size-Env.Correct:BW	PaperTransfer:Standard:2Sid:S5	ENG	[1 to 110 / 19 / 1/step]
2-413-019	Plain1:Size-Env.Correct:BW	PaperTransfer:Low:1Side:S5	ENG	[1 to 110 / 14 / 1/step]
2-413-020	Plain1:Size-Env.Correct:BW	PaperTransfer:Low:2Side:S5	ENG	[1 to 110 / 19 / 1/step]
2-413-021	Plain1:Size-Env.Correct:BW	Wide Roller:PaperTransfer:Standard:1Sid:S1	ENG	[1 to 110 / 10 / 1/step]
2-413-022	Plain1:Size-Env.Correct:BW	Wide Roller:PaperTransfer:Standard:2Sid:S1	ENG	[1 to 110 / 15 / 1/step]
2-413-023	Plain1:Size-Env.Correct:BW	Wide Roller:PaperTransfer:Low:1Side:S1	ENG	[1 to 110 / 10 / 1/step]
2-413-	Plain1:Size-Env.Correct:BW	Wide Roller:PaperTransfer:Low:2Side:S1	ENG	[1 to 110 / 15 / 1/step]

3.SP Mode Tables

SP No.	Large Category	Small Category	ENG or CTL	[Min to Max/Init./Step]
024				
2-413-025	Plain1:Size-Env.Correct:BW	Wide Roller:PaperTransfer:Standard:1Sid:S2	ENG	[1 to 110 / 11 / 1/step]
2-413-026	Plain1:Size-Env.Correct:BW	Wide Roller:PaperTransfer:Standard:2Sid:S2	ENG	[1 to 110 / 16 / 1/step]
2-413-027	Plain1:Size-Env.Correct:BW	Wide Roller:PaperTransfer:Low:1Side:S2	ENG	[1 to 110 / 11 / 1/step]
2-413-028	Plain1:Size-Env.Correct:BW	Wide Roller:PaperTransfer:Low:2Side:S2	ENG	[1 to 110 / 16 / 1/step]
2-413-029	Plain1:Size-Env.Correct:BW	Wide Roller:PaperTransfer:Standard:1Sid:S3	ENG	[1 to 110 / 12 / 1/step]
2-413-030	Plain1:Size-Env.Correct:BW	Wide Roller:PaperTransfer:Standard:2Sid:S3	ENG	[1 to 110 / 17 / 1/step]
2-413-031	Plain1:Size-Env.Correct:BW	Wide Roller:PaperTransfer:Low:1Side:S3	ENG	[1 to 110 / 12 / 1/step]
2-413-032	Plain1:Size-Env.Correct:BW	Wide Roller:PaperTransfer:Low:2Side:S3	ENG	[1 to 110 / 17 / 1/step]
2-413-	Plain1:Size-Env.Correct:BW	Wide Roller:PaperTransfer:Standard:1Sid:S4	ENG	[1 to 110 / 13 / 1/step]

3.SP Mode Tables

SP No.	Large Category	Small Category	ENG or CTL	[Min to Max/Init./Step]
033				
2-413-034	Plain1:Size-Env.Correct:BW	Wide Roller:PaperTransfer:Standard:2Sid:S4	ENG	[1 to 110 / 18 / 1/step]
2-413-035	Plain1:Size-Env.Correct:BW	Wide Roller:PaperTransfer:Low:1Side:S4	ENG	[1 to 110 / 13 / 1/step]
2-413-036	Plain1:Size-Env.Correct:BW	Wide Roller:PaperTransfer:Low:2Side:S4	ENG	[1 to 110 / 18 / 1/step]
2-413-037	Plain1:Size-Env.Correct:BW	Wide Roller:PaperTransfer:Standard:1Sid:S5	ENG	[1 to 110 / 14 / 1/step]
2-413-038	Plain1:Size-Env.Correct:BW	Wide Roller:PaperTransfer:Standard:2Sid:S5	ENG	[1 to 110 / 19 / 1/step]
2-413-039	Plain1:Size-Env.Correct:BW	Wide Roller:PaperTransfer:Low:1Side:S5	ENG	[1 to 110 / 14 / 1/step]
2-413-040	Plain1:Size-Env.Correct:BW	Wide Roller:PaperTransfer:Low:2Side:S5	ENG	[1 to 110 / 19 / 1/step]
2-414-001	Plain1:Size-Env.Correct:FC	PaperTransfer:Standard:1Sid:S1	ENG *	[1 to 110 / 20 / 1/step]
2-414-	Plain1:Size-Env.Correct:FC	PaperTransfer:Standard:2Sid:S1	ENG	[1 to 110 / 25 / 1/step]

3.SP Mode Tables

SP No.	Large Category	Small Category	ENG or CTL	[Min to Max/Init./Step]
002				
2-414-003	Plain1:Size-Env.Correct:FC	PaperTransfer:Low:1Side:S1	ENG	[1 to 110 / 20 / 1/step]
2-414-004	Plain1:Size-Env.Correct:FC	PaperTransfer:Low:2Side:S1	ENG	[1 to 110 / 25 / 1/step]
2-414-005	Plain1:Size-Env.Correct:FC	PaperTransfer:Standard:1Sid:S2	ENG	[1 to 110 / 21 / 1/step]
2-414-006	Plain1:Size-Env.Correct:FC	PaperTransfer:Standard:2Sid:S2	ENG	[1 to 110 / 26 / 1/step]
2-414-007	Plain1:Size-Env.Correct:FC	PaperTransfer:Low:1Side:S2	ENG	[1 to 110 / 21 / 1/step]
2-414-008	Plain1:Size-Env.Correct:FC	PaperTransfer:Low:2Side:S2	ENG	[1 to 110 / 26 / 1/step]
2-414-009	Plain1:Size-Env.Correct:FC	PaperTransfer:Standard:1Sid:S3	ENG	[1 to 110 / 22 / 1/step]
2-414-010	Plain1:Size-Env.Correct:FC	PaperTransfer:Standard:2Sid:S3	ENG	[1 to 110 / 27 / 1/step]
2-414-	Plain1:Size-Env.Correct:FC	PaperTransfer:Low:1Side:S3	ENG	[1 to 110 / 22 / 1/step]

3.SP Mode Tables

SP No.	Large Category	Small Category	ENG or CTL	[Min to Max/Init./Step]
011				
2-414-012	Plain1:Size-Env.Correct:FC	PaperTransfer:Low:2Side:S3	ENG	[1 to 110 / 27 / 1/step]
2-414-013	Plain1:Size-Env.Correct:FC	PaperTransfer:Standard:1Sid:S4	ENG	[1 to 110 / 23 / 1/step]
2-414-014	Plain1:Size-Env.Correct:FC	PaperTransfer:Standard:2Sid:S4	ENG	[1 to 110 / 28 / 1/step]
2-414-015	Plain1:Size-Env.Correct:FC	PaperTransfer:Low:1Side:S4	ENG	[1 to 110 / 23 / 1/step]
2-414-016	Plain1:Size-Env.Correct:FC	PaperTransfer:Low:2Side:S4	ENG	[1 to 110 / 28 / 1/step]
2-414-017	Plain1:Size-Env.Correct:FC	PaperTransfer:Standard:1Sid:S5	ENG	[1 to 110 / 24 / 1/step]
2-414-018	Plain1:Size-Env.Correct:FC	PaperTransfer:Standard:2Sid:S5	ENG	[1 to 110 / 29 / 1/step]
2-414-019	Plain1:Size-Env.Correct:FC	PaperTransfer:Low:1Side:S5	ENG	[1 to 110 / 24 / 1/step]
2-414-	Plain1:Size-Env.Correct:FC	PaperTransfer:Low:2Side:S5	ENG	[1 to 110 / 29 / 1/step]

3.SP Mode Tables

SP No.	Large Category	Small Category	ENG or CTL	[Min to Max/Init./Step]
020				
2-414-021	Plain1:Size-Env.Correct:FC	Wide Roller:PaperTransfer:Standard:1Sid:S1	ENG *	[1 to 110 / 20 / 1/step]
2-414-022	Plain1:Size-Env.Correct:FC	Wide Roller:PaperTransfer:Standard:2Sid:S1	ENG	[1 to 110 / 25 / 1/step]
2-414-023	Plain1:Size-Env.Correct:FC	Wide Roller:PaperTransfer:Low:1Side:S1	ENG	[1 to 110 / 20 / 1/step]
2-414-024	Plain1:Size-Env.Correct:FC	Wide Roller:PaperTransfer:Low:2Side:S1	ENG	[1 to 110 / 25 / 1/step]
2-414-025	Plain1:Size-Env.Correct:FC	Wide Roller:PaperTransfer:Standard:1Sid:S2	ENG	[1 to 110 / 21 / 1/step]
2-414-026	Plain1:Size-Env.Correct:FC	Wide Roller:PaperTransfer:Standard:2Sid:S2	ENG	[1 to 110 / 26 / 1/step]
2-414-027	Plain1:Size-Env.Correct:FC	Wide Roller:PaperTransfer:Low:1Side:S2	ENG	[1 to 110 / 21 / 1/step]
2-414-028	Plain1:Size-Env.Correct:FC	Wide Roller:PaperTransfer:Low:2Side:S2	ENG	[1 to 110 / 26 / 1/step]
2-414-	Plain1:Size-Env.Correct:FC	Wide Roller:PaperTransfer:Standard:1Sid:S3	ENG	[1 to 110 / 22 / 1/step]

3.SP Mode Tables

SP No.	Large Category	Small Category	ENG or CTL	[Min to Max/Init./Step]
029				
2-414-030	Plain1:Size-Env.Correct:FC	Wide Roller:PaperTransfer:Standard:2Sid:S3	ENG	[1 to 110 / 27 / 1/step]
2-414-031	Plain1:Size-Env.Correct:FC	Wide Roller:PaperTransfer:Low:1Side:S3	ENG	[1 to 110 / 22 / 1/step]
2-414-032	Plain1:Size-Env.Correct:FC	Wide Roller:PaperTransfer:Low:2Side:S3	ENG	[1 to 110 / 27 / 1/step]
2-414-033	Plain1:Size-Env.Correct:FC	Wide Roller:PaperTransfer:Standard:1Sid:S4	ENG	[1 to 110 / 23 / 1/step]
2-414-034	Plain1:Size-Env.Correct:FC	Wide Roller:PaperTransfer:Standard:2Sid:S4	ENG	[1 to 110 / 28 / 1/step]
2-414-035	Plain1:Size-Env.Correct:FC	Wide Roller:PaperTransfer:Low:1Side:S4	ENG	[1 to 110 / 23 / 1/step]
2-414-036	Plain1:Size-Env.Correct:FC	Wide Roller:PaperTransfer:Low:2Side:S4	ENG	[1 to 110 / 28 / 1/step]
2-414-037	Plain1:Size-Env.Correct:FC	Wide Roller:PaperTransfer:Standard:1Sid:S5	ENG	[1 to 110 / 24 / 1/step]
2-414-	Plain1:Size-Env.Correct:FC	Wide Roller:PaperTransfer:Standard:2Sid:S5	ENG	[1 to 110 / 29 / 1/step]

3.SP Mode Tables

SP No.	Large Category	Small Category	ENG or CTL	[Min to Max/Init./Step]
038				
2-414-039	Plain1:Size-Env.Correct:FC	Wide Roller:PaperTransfer:Low:1Side:S5	ENG	[1 to 110 / 24 / 1/step]
2-414-040	Plain1:Size-Env.Correct:FC	Wide Roller:PaperTransfer:Low:2Side:S5	ENG	[1 to 110 / 29 / 1/step]
2-415-001	Plain1:LeadingEdgeCorrection	PaperTransfer:Standard:1Side	ENG	[0 to 995 / 100 / 5%/step]
2-415-002	Plain1:LeadingEdgeCorrection	PaperTransfer:Standard:2Side	ENG	[0 to 995 / 100 / 5%/step]
2-415-003	Plain1:LeadingEdgeCorrection	Paper Transfer:Low:1side	ENG	[0 to 995 / 100 / 5%/step]
2-415-004	Plain1:LeadingEdgeCorrection	Paper Transfer:Low:2side	ENG	[0 to 995 / 100 / 5%/step]
2-416-001	Plain1:SwitchTimingLeadEdge	PaperTransfer:Standard:1side	ENG	[0 to 50 / 0 / 2mm/step]
2-416-002	Plain1:SwitchTimingLeadEdge	PaperTransfer:Standard:2side	ENG	[0 to 50 / 0 / 2mm/step]
2-416-	Plain1:SwitchTimingLeadEdge	Paper Transfer:Low:1side	ENG	[0 to 50 / 0 / 2mm/step]

3.SP Mode Tables

SP No.	Large Category	Small Category	ENG or CTL	[Min to Max/Init./Step]
003				
2-416-004	Plain1:SwitchTimingLeadEdge	Paper Transfer:Low:2side	ENG	[0 to 50 / 0 / 2mm/step]
2-417-001	Plain1:TrailEdgeCorrection	PaperTransfer:Standard:1Side	ENG	[0 to 995 / 100 / 5%/step]
2-417-002	Plain1:TrailEdgeCorrection	PaperTransfer:Standard:2Side	ENG	[0 to 995 / 100 / 5%/step]
2-417-003	Plain1:TrailEdgeCorrection	Paper Transfer:Low:1side	ENG	[0 to 995 / 100 / 5%/step]
2-417-004	Plain1:TrailEdgeCorrection	Paper Transfer:Low:2side	ENG	[0 to 995 / 100 / 5%/step]
2-418-001	Plain1:SwitchTimingTrailEdge	PaperTransfer:Standard:1side	ENG	[0 to 50 / 0 / 2mm/step]
2-418-002	Plain1:SwitchTimingTrailEdge	PaperTransfer:Standard:2side	ENG	[0 to 50 / 0 / 2mm/step]
2-418-003	Plain1:SwitchTimingTrailEdge	Paper Transfer:Low:1side	ENG	[0 to 50 / 0 / 2mm/step]
2-418-	Plain1:SwitchTimingTrailEdge	Paper Transfer:Low:2side	ENG	[0 to 50 / 0 / 2mm/step]

3.SP Mode Tables

SP No.	Large Category	Small Category	ENG or CTL	[Min to Max/Init./Step]
004				
2-423-001	Plain2:Bias:BW	PaperTransfer:standard:1side	ENG	IM C3500: [0 to 200 / 22 / 1-uA/step] IM C2500: [0 to 200 / 22 / 1-uA/step] IM C2000: [0 to 200 / 22 / 1-uA/step] IM C3000: [0 to 200 / 22 / 1-uA/step]
2-423-002	Plain2:Bias:BW	PaperTransfer:standard:2side	ENG	IM C3500: [0 to 200 / 22 / 1-uA/step] IM C2500: [0 to 200 / 22 / 1-uA/step] IM C2000: [0 to 200 / 22 / 1-uA/step] IM C3000: [0 to 200 / 22 / 1-uA/step]
2-423-003	Plain2:Bias:BW	PaperTransfer:low:1side	ENG	IM C3500: [0 to 200 / 11 / 1-uA/step] IM C2500: [0 to 200 / 11 / 1-uA/step] IM C2000: [0 to 200 / 11 / 1-uA/step] IM C3000: [0 to 200 / 11 / 1-uA/step]

3.SP Mode Tables

SP No.	Large Category	Small Category	ENG or CTL	[Min to Max/Init./Step]
				/ 1-uA/step]
2-423-004	Plain2:Bias:BW	PaperTransfer:low:2side	ENG	IM C3500: [0 to 200 / 11 / 1-uA/step] IM C2500: [0 to 200 / 11 / 1-uA/step] IM C2000: [0 to 200 / 11 / 1-uA/step] IM C3000: [0 to 200 / 11 / 1-uA/step]
2-425-001	HHsmall:LeadEdgeCorrection	PaperTransfer:1side	ENG	[0 to 995 / 100 / 5%/step]
2-425-002	HHsmall:LeadEdgeCorrection	PaperTransfer:2stSide	ENG	[0 to 995 / 100 / 5%/step]
2-427-001	Plain2:Bias:FC	PaperTransfer:standard:1side	ENG	IM C3500: [0 to 200 / 29 / 1-uA/step] IM C2500: [0 to 200 / 29 / 1-uA/step] IM C2000: [0 to 200 / 29 / 1-uA/step] IM C3000: [0 to 200 / 29 / 1-uA/step]
2-427-	Plain2:Bias:FC	PaperTransfer:standard:2side	ENG	IM C3500: [0 to 200 / 29 / 1-uA/step]

3.SP Mode Tables

SP No.	Large Category	Small Category	ENG or CTL	[Min to Max/Init./Step]
002				IM C2500: [0 to 200 / 29 / 1-uA/step] IM C2000: [0 to 200 / 29 / 1-uA/step] IM C3000: [0 to 200 / 29 / 1-uA/step]
2-427-003	Plain2:Bias:FC	PaperTransfer:low:1side	ENG	IM C3500: [0 to 200 / 14 / 1-uA/step] IM C2500: [0 to 200 / 14 / 1-uA/step] IM C2000: [0 to 200 / 14 / 1-uA/step] IM C3000: [0 to 200 / 14 / 1-uA/step]
2-427-004	Plain2:Bias:FC	PaperTransfer:low:2side	ENG	IM C3500: [0 to 200 / 14 / 1-uA/step] IM C2500: [0 to 200 / 14 / 1-uA/step] IM C2000: [0 to 200 / 14 / 1-uA/step] IM C3000: [0 to 200 / 14 / 1-uA/step]
2-431-	Plain2:SizeCorrection:BW	PaperTransfer:Standard:1Sid:S1	ENG	[100 to 995 / 100 / 1%/step]

3.SP Mode Tables

SP No.	Large Category	Small Category	ENG or CTL	[Min to Max/Init./Step]
001				
2-431-002	Plain2:SizeCorrection:BW	PaperTransfer:Standard:2Sid:S1	ENG	[100 to 995 / 100 / 1%/step]
2-431-003	Plain2:SizeCorrection:BW	PaperTransfer:Low:1Side:S1	ENG	[100 to 995 / 100 / 1%/step]
2-431-004	Plain2:SizeCorrection:BW	PaperTransfer:Low:2Side:S1	ENG	[100 to 995 / 100 / 1%/step]
2-431-005	Plain2:SizeCorrection:BW	PaperTransfer:Standard:1Sid:S2	ENG	[100 to 995 / 100 / 1%/step]
2-431-006	Plain2:SizeCorrection:BW	PaperTransfer:Standard:2Sid:S2	ENG	[100 to 995 / 105 / 1%/step]
2-431-007	Plain2:SizeCorrection:BW	PaperTransfer:Low:1Side:S2	ENG	[100 to 995 / 100 / 1%/step]
2-431-008	Plain2:SizeCorrection:BW	PaperTransfer:Low:2Side:S2	ENG	[100 to 995 / 105 / 1%/step]
2-431-009	Plain2:SizeCorrection:BW	PaperTransfer:Standard:1Sid:S3	ENG	[100 to 995 / 105 / 1%/step]
2-431-	Plain2:SizeCorrection:BW	PaperTransfer:Standard:2Sid:S3	ENG	[100 to 995 / 118 / 1%/step]

3.SP Mode Tables

SP No.	Large Category	Small Category	ENG or CTL	[Min to Max/Init./Step]
010				
2-431-011	Plain2:SizeCorrection:BW	PaperTransfer:Low:1Side:S3	ENG	[100 to 995 / 105 / 1%/step]
2-431-012	Plain2:SizeCorrection:BW	PaperTransfer:Low:2Side:S3	ENG	[100 to 995 / 118 / 1%/step]
2-431-013	Plain2:SizeCorrection:BW	PaperTransfer:Standard:1Sid:S4	ENG	[100 to 995 / 118 / 1%/step]
2-431-014	Plain2:SizeCorrection:BW	PaperTransfer:Standard:2Sid:S4	ENG	[100 to 995 / 131 / 1%/step]
2-431-015	Plain2:SizeCorrection:BW	PaperTransfer:Low:1Side:S4	ENG	[100 to 995 / 118 / 1%/step]
2-431-016	Plain2:SizeCorrection:BW	PaperTransfer:Low:2Side:S4	ENG	[100 to 995 / 131 / 1%/step]
2-431-017	Plain2:SizeCorrection:BW	PaperTransfer:Standard:1Sid:S5	ENG	[100 to 995 / 132 / 1%/step]
2-431-018	Plain2:SizeCorrection:BW	PaperTransfer:Standard:2Sid:S5	ENG	[100 to 995 / 184 / 1%/step]
2-431-	Plain2:SizeCorrection:BW	PaperTransfer:Low:1Side:S5	ENG	[100 to 995 / 132 / 1%/step]

3.SP Mode Tables

SP No.	Large Category	Small Category	ENG or CTL	[Min to Max/Init./Step]
019				
2-431-020	Plain2:SizeCorrection:BW	PaperTransfer:Low:2Side:S5	ENG	[100 to 995 / 184 / 1%/step]
2-431-021	Plain2:SizeCorrection:BW	Wide Roller:PaperTransfer:Standard:1Side:S1	ENG	[100 to 995 / 100 / 1%/step]
2-431-022	Plain2:SizeCorrection:BW	Wide Roller:PaperTransfer:Standard:2Side:S1	ENG	[100 to 995 / 100 / 1%/step]
2-431-023	Plain2:SizeCorrection:BW	Wide Roller:PaperTransfer:Low:1Side:S1	ENG	[100 to 995 / 100 / 1%/step]
2-431-024	Plain2:SizeCorrection:BW	Wide Roller:PaperTransfer:Low:2Side:S1	ENG	[100 to 995 / 100 / 1%/step]
2-431-025	Plain2:SizeCorrection:BW	Wide Roller:PaperTransfer:Standard:1Side:S2	ENG	[100 to 995 / 100 / 1%/step]
2-431-026	Plain2:SizeCorrection:BW	Wide Roller:PaperTransfer:Standard:2Side:S2	ENG	[100 to 995 / 105 / 1%/step]
2-431-027	Plain2:SizeCorrection:BW	Wide Roller:PaperTransfer:Low:1Side:S2	ENG	[100 to 995 / 100 / 1%/step]
2-431-	Plain2:SizeCorrection:BW	Wide Roller:PaperTransfer:Low:2Side:S2	ENG	[100 to 995 / 105 / 1%/step]

3.SP Mode Tables

SP No.	Large Category	Small Category	ENG or CTL	[Min to Max/Init./Step]
028				
2-431-029	Plain2:SizeCorrection:BW	Wide Roller:PaperTransfer:Standard:1Sid:S3	ENG	[100 to 995 / 105 / 1%/step]
2-431-030	Plain2:SizeCorrection:BW	Wide Roller:PaperTransfer:Standard:2Sid:S3	ENG	[100 to 995 / 118 / 1%/step]
2-431-031	Plain2:SizeCorrection:BW	Wide Roller:PaperTransfer:Low:1Side:S3	ENG	[100 to 995 / 105 / 1%/step]
2-431-032	Plain2:SizeCorrection:BW	Wide Roller:PaperTransfer:Low:2Side:S3	ENG	[100 to 995 / 118 / 1%/step]
2-431-033	Plain2:SizeCorrection:BW	Wide Roller:PaperTransfer:Standard:1Sid:S4	ENG	[100 to 995 / 118 / 1%/step]
2-431-034	Plain2:SizeCorrection:BW	Wide Roller:PaperTransfer:Standard:2Sid:S4	ENG	[100 to 995 / 131 / 1%/step]
2-431-035	Plain2:SizeCorrection:BW	Wide Roller:PaperTransfer:Low:1Side:S4	ENG	[100 to 995 / 118 / 1%/step]
2-431-036	Plain2:SizeCorrection:BW	Wide Roller:PaperTransfer:Low:2Side:S4	ENG	[100 to 995 / 131 / 1%/step]
2-431-	Plain2:SizeCorrection:BW	Wide Roller:PaperTransfer:Standard:1Sid:S5	ENG	[100 to 995 / 132 / 1%/step]

3.SP Mode Tables

SP No.	Large Category	Small Category	ENG or CTL	[Min to Max/Init./Step]
037				
2-431-038	Plain2:SizeCorrection:BW	Wide Roller:PaperTransfer:Standard:2Sid:S5	ENG	[100 to 995 / 184 / 1%/step]
2-431-039	Plain2:SizeCorrection:BW	Wide Roller:PaperTransfer:Low:1Side:S5	ENG	[100 to 995 / 132 / 1%/step]
2-431-040	Plain2:SizeCorrection:BW	Wide Roller:PaperTransfer:Low:2Side:S5	ENG	[100 to 995 / 184 / 1%/step]
2-432-001	Plain2:SizeCorrection:FC	PaperTransfer:Standard:1Sid:S1	ENG	[100 to 995 / 100 / 1%/step]
2-432-002	Plain2:SizeCorrection:FC	PaperTransfer:Standard:2Sid:S1	ENG	[100 to 995 / 100 / 1%/step]
2-432-003	Plain2:SizeCorrection:FC	PaperTransfer:Low:1Side:S1	ENG	[100 to 995 / 100 / 1%/step]
2-432-004	Plain2:SizeCorrection:FC	PaperTransfer:Low:2Side:S1	ENG	[100 to 995 / 100 / 1%/step]
2-432-005	Plain2:SizeCorrection:FC	PaperTransfer:Standard:1Sid:S2	ENG	[100 to 995 / 120 / 1%/step]
2-432-	Plain2:SizeCorrection:FC	PaperTransfer:Standard:2Sid:S2	ENG	[100 to 995 / 140 / 1%/step]

3.SP Mode Tables

SP No.	Large Category	Small Category	ENG or CTL	[Min to Max/Init./Step]
006				
2-432-007	Plain2:SizeCorrection:FC	PaperTransfer:Low:1Side:S2	ENG	[100 to 995 / 120 / 1%/step]
2-432-008	Plain2:SizeCorrection:FC	PaperTransfer:Low:2Side:S2	ENG	[100 to 995 / 140 / 1%/step]
2-432-009	Plain2:SizeCorrection:FC	PaperTransfer:Standard:1Sid:S3	ENG	[100 to 995 / 118 / 1%/step]
2-432-010	Plain2:SizeCorrection:FC	PaperTransfer:Standard:2Sid:S3	ENG	[100 to 995 / 180 / 1%/step]
2-432-011	Plain2:SizeCorrection:FC	PaperTransfer:Low:1Side:S3	ENG	[100 to 995 / 118 / 1%/step]
2-432-012	Plain2:SizeCorrection:FC	PaperTransfer:Low:2Side:S3	ENG	[100 to 995 / 180 / 1%/step]
2-432-013	Plain2:SizeCorrection:FC	PaperTransfer:Standard:1Sid:S4	ENG	[100 to 995 / 130 / 1%/step]
2-432-014	Plain2:SizeCorrection:FC	PaperTransfer:Standard:2Sid:S4	ENG	[100 to 995 / 200 / 1%/step]
2-432-	Plain2:SizeCorrection:FC	PaperTransfer:Low:1Side:S4	ENG	[100 to 995 / 130 / 1%/step]

3.SP Mode Tables

SP No.	Large Category	Small Category	ENG or CTL	[Min to Max/Init./Step]
015				
2-432-016	Plain2:SizeCorrection:FC	PaperTransfer:Low:2Side:S4	ENG	[100 to 995 / 200 / 1%/step]
2-432-017	Plain2:SizeCorrection:FC	PaperTransfer:Standard:1Sid:S5	ENG	[100 to 995 / 140 / 1%/step]
2-432-018	Plain2:SizeCorrection:FC	PaperTransfer:Standard:2Sid:S5	ENG	[100 to 995 / 240 / 1%/step]
2-432-019	Plain2:SizeCorrection:FC	PaperTransfer:Low:1Side:S5	ENG	[100 to 995 / 140 / 1%/step]
2-432-020	Plain2:SizeCorrection:FC	PaperTransfer:Low:2Side:S5	ENG	[100 to 995 / 240 / 1%/step]
2-432-021	Plain2:SizeCorrection:FC	Wide Roller:PaperTransfer:Standard:1Sid:S1	ENG	[100 to 995 / 100 / 1%/step]
2-432-022	Plain2:SizeCorrection:FC	Wide Roller:PaperTransfer:Standard:2Sid:S1	ENG	[100 to 995 / 100 / 1%/step]
2-432-023	Plain2:SizeCorrection:FC	Wide Roller:PaperTransfer:Low:1Side:S1	ENG	[100 to 995 / 100 / 1%/step]
2-432-	Plain2:SizeCorrection:FC	Wide Roller:PaperTransfer:Low:2Side:S1	ENG	[100 to 995 / 100 / 1%/step]

3.SP Mode Tables

SP No.	Large Category	Small Category	ENG or CTL	[Min to Max/Init./Step]
024				
2-432-025	Plain2:SizeCorrection:FC	Wide Roller:PaperTransfer:Standard:1Sid:S2	ENG	[100 to 995 / 120 / 1%/step]
2-432-026	Plain2:SizeCorrection:FC	Wide Roller:PaperTransfer:Standard:2Sid:S2	ENG	[100 to 995 / 140 / 1%/step]
2-432-027	Plain2:SizeCorrection:FC	Wide Roller:PaperTransfer:Low:1Side:S2	ENG	[100 to 995 / 120 / 1%/step]
2-432-028	Plain2:SizeCorrection:FC	Wide Roller:PaperTransfer:Low:2Side:S2	ENG	[100 to 995 / 140 / 1%/step]
2-432-029	Plain2:SizeCorrection:FC	Wide Roller:PaperTransfer:Standard:1Sid:S3	ENG	[100 to 995 / 118 / 1%/step]
2-432-030	Plain2:SizeCorrection:FC	Wide Roller:PaperTransfer:Standard:2Sid:S3	ENG	[100 to 995 / 180 / 1%/step]
2-432-031	Plain2:SizeCorrection:FC	Wide Roller:PaperTransfer:Low:1Side:S3	ENG	[100 to 995 / 118 / 1%/step]
2-432-032	Plain2:SizeCorrection:FC	Wide Roller:PaperTransfer:Low:2Side:S3	ENG	[100 to 995 / 180 / 1%/step]
2-432-	Plain2:SizeCorrection:FC	Wide Roller:PaperTransfer:Standard:1Sid:S4	ENG	[100 to 995 / 130 / 1%/step]

3.SP Mode Tables

SP No.	Large Category	Small Category	ENG or CTL	[Min to Max/Init./Step]
033				
2-432-034	Plain2:SizeCorrection:FC	Wide Roller:PaperTransfer:Standard:2Sid:S4	ENG	[100 to 995 / 200 / 1%/step]
2-432-035	Plain2:SizeCorrection:FC	Wide Roller:PaperTransfer:Low:1Side:S4	ENG	[100 to 995 / 130 / 1%/step]
2-432-036	Plain2:SizeCorrection:FC	Wide Roller:PaperTransfer:Low:2Side:S4	ENG	[100 to 995 / 200 / 1%/step]
2-432-037	Plain2:SizeCorrection:FC	Wide Roller:PaperTransfer:Standard:1Sid:S5	ENG	[100 to 995 / 140 / 1%/step]
2-432-038	Plain2:SizeCorrection:FC	Wide Roller:PaperTransfer:Standard:2Sid:S5	ENG	[100 to 995 / 240 / 1%/step]
2-432-039	Plain2:SizeCorrection:FC	Wide Roller:PaperTransfer:Low:1Side:S5	ENG	[100 to 995 / 140 / 1%/step]
2-432-040	Plain2:SizeCorrection:FC	Wide Roller:PaperTransfer:Low:2Side:S5	ENG	[100 to 995 / 240 / 1%/step]
2-433-001	Plain2:Size-Env.Correct:BW	PaperTransfer:Standard:1Sid:S1	ENG	[1 to 110 / 10 / 1/step]
2-433-	Plain2:Size-Env.Correct:BW	PaperTransfer:Standard:2Sid:S1	ENG	[1 to 110 / 15 / 1/step]

3.SP Mode Tables

SP No.	Large Category	Small Category	ENG or CTL	[Min to Max/Init./Step]
002				
2-433-003	Plain2:Size-Env.Correct:BW	PaperTransfer:Low:1Side:S1	ENG	[1 to 110 / 10 / 1/step]
2-433-004	Plain2:Size-Env.Correct:BW	PaperTransfer:Low:2Side:S1	ENG	[1 to 110 / 15 / 1/step]
2-433-005	Plain2:Size-Env.Correct:BW	PaperTransfer:Standard:1Sid:S2	ENG	[1 to 110 / 11 / 1/step]
2-433-006	Plain2:Size-Env.Correct:BW	PaperTransfer:Standard:2Sid:S2	ENG	[1 to 110 / 16 / 1/step]
2-433-007	Plain2:Size-Env.Correct:BW	PaperTransfer:Low:1Side:S2	ENG	[1 to 110 / 11 / 1/step]
2-433-008	Plain2:Size-Env.Correct:BW	PaperTransfer:Low:2Side:S2	ENG	[1 to 110 / 16 / 1/step]
2-433-009	Plain2:Size-Env.Correct:BW	PaperTransfer:Standard:1Sid:S3	ENG	[1 to 110 / 12 / 1/step]
2-433-010	Plain2:Size-Env.Correct:BW	PaperTransfer:Standard:2Sid:S3	ENG	[1 to 110 / 17 / 1/step]
2-433-	Plain2:Size-Env.Correct:BW	PaperTransfer:Low:1Side:S3	ENG	[1 to 110 / 12 / 1/step]

3.SP Mode Tables

SP No.	Large Category	Small Category	ENG or CTL	[Min to Max/Init./Step]
011				
2-433-012	Plain2:Size-Env.Correct:BW	PaperTransfer:Low:2Side:S3	ENG	[1 to 110 / 17 / 1/step]
2-433-013	Plain2:Size-Env.Correct:BW	PaperTransfer:Standard:1Sid:S4	ENG	[1 to 110 / 13 / 1/step]
2-433-014	Plain2:Size-Env.Correct:BW	PaperTransfer:Standard:2Sid:S4	ENG	[1 to 110 / 18 / 1/step]
2-433-015	Plain2:Size-Env.Correct:BW	PaperTransfer:Low:1Side:S4	ENG	[1 to 110 / 13 / 1/step]
2-433-016	Plain2:Size-Env.Correct:BW	PaperTransfer:Low:2Side:S4	ENG	[1 to 110 / 18 / 1/step]
2-433-017	Plain2:Size-Env.Correct:BW	PaperTransfer:Standard:1Sid:S5	ENG	[1 to 110 / 14 / 1/step]
2-433-018	Plain2:Size-Env.Correct:BW	PaperTransfer:Standard:2Sid:S5	ENG	[1 to 110 / 19 / 1/step]
2-433-019	Plain2:Size-Env.Correct:BW	PaperTransfer:Low:1Side:S5	ENG	[1 to 110 / 14 / 1/step]
2-433-	Plain2:Size-Env.Correct:BW	PaperTransfer:Low:2Side:S5	ENG	[1 to 110 / 19 / 1/step]

3.SP Mode Tables

SP No.	Large Category	Small Category	ENG or CTL	[Min to Max/Init./Step]
020				
2-433-021	Plain2:Size-Env.Correct:BW	Wide Roller:PaperTransfer:Standard:1Sid:S1	ENG	[1 to 110 / 10 / 1/step]
2-433-022	Plain2:Size-Env.Correct:BW	Wide Roller:PaperTransfer:Standard:2Sid:S1	ENG	[1 to 110 / 15 / 1/step]
2-433-023	Plain2:Size-Env.Correct:BW	Wide Roller:PaperTransfer:Low:1Side:S1	ENG	[1 to 110 / 10 / 1/step]
2-433-024	Plain2:Size-Env.Correct:BW	Wide Roller:PaperTransfer:Low:2Side:S1	ENG	[1 to 110 / 15 / 1/step]
2-433-025	Plain2:Size-Env.Correct:BW	Wide Roller:PaperTransfer:Standard:1Sid:S2	ENG	[1 to 110 / 11 / 1/step]
2-433-026	Plain2:Size-Env.Correct:BW	Wide Roller:PaperTransfer:Standard:2Sid:S2	ENG	[1 to 110 / 16 / 1/step]
2-433-027	Plain2:Size-Env.Correct:BW	Wide Roller:PaperTransfer:Low:1Side:S2	ENG	[1 to 110 / 11 / 1/step]
2-433-028	Plain2:Size-Env.Correct:BW	Wide Roller:PaperTransfer:Low:2Side:S2	ENG	[1 to 110 / 16 / 1/step]
2-433-	Plain2:Size-Env.Correct:BW	Wide Roller:PaperTransfer:Standard:1Sid:S3	ENG	[1 to 110 / 12 / 1/step]

3.SP Mode Tables

SP No.	Large Category	Small Category	ENG or CTL	[Min to Max/Init./Step]
029				
2-433-030	Plain2:Size-Env.Correct:BW	Wide Roller:PaperTransfer:Standard:2Sid:S3	ENG	[1 to 110 / 17 / 1/step]
2-433-031	Plain2:Size-Env.Correct:BW	Wide Roller:PaperTransfer:Low:1Side:S3	ENG	[1 to 110 / 12 / 1/step]
2-433-032	Plain2:Size-Env.Correct:BW	Wide Roller:PaperTransfer:Low:2Side:S3	ENG	[1 to 110 / 17 / 1/step]
2-433-033	Plain2:Size-Env.Correct:BW	Wide Roller:PaperTransfer:Standard:1Sid:S4	ENG	[1 to 110 / 13 / 1/step]
2-433-034	Plain2:Size-Env.Correct:BW	Wide Roller:PaperTransfer:Standard:2Sid:S4	ENG	[1 to 110 / 18 / 1/step]
2-433-035	Plain2:Size-Env.Correct:BW	Wide Roller:PaperTransfer:Low:1Side:S4	ENG	[1 to 110 / 13 / 1/step]
2-433-036	Plain2:Size-Env.Correct:BW	Wide Roller:PaperTransfer:Low:2Side:S4	ENG	[1 to 110 / 18 / 1/step]
2-433-037	Plain2:Size-Env.Correct:BW	Wide Roller:PaperTransfer:Standard:1Sid:S5	ENG	[1 to 110 / 14 / 1/step]
2-433-	Plain2:Size-Env.Correct:BW	Wide Roller:PaperTransfer:Standard:2Sid:S5	ENG	[1 to 110 / 19 / 1/step]

3.SP Mode Tables

SP No.	Large Category	Small Category	ENG or CTL	[Min to Max/Init./Step]
038				
2-433-039	Plain2:Size-Env.Correct:BW	Wide Roller:PaperTransfer:Low:1Side:S5	ENG	[1 to 110 / 14 / 1/step]
2-433-040	Plain2:Size-Env.Correct:BW	Wide Roller:PaperTransfer:Low:2Side:S5	ENG	[1 to 110 / 19 / 1/step]
2-434-001	Plain2:Size-Env.Correct:FC	PaperTransfer:Standard:1Sid:S1	ENG	[1 to 110 / 20 / 1/step]
2-434-002	Plain2:Size-Env.Correct:FC	PaperTransfer:Standard:2Sid:S1	ENG	[1 to 110 / 25 / 1/step]
2-434-003	Plain2:Size-Env.Correct:FC	PaperTransfer:Low:1Side:S1	ENG	[1 to 110 / 20 / 1/step]
2-434-004	Plain2:Size-Env.Correct:FC	PaperTransfer:Low:2Side:S1	ENG	[1 to 110 / 25 / 1/step]
2-434-005	Plain2:Size-Env.Correct:FC	PaperTransfer:Standard:1Sid:S2	ENG	[1 to 110 / 21 / 1/step]
2-434-006	Plain2:Size-Env.Correct:FC	PaperTransfer:Standard:2Sid:S2	ENG	[1 to 110 / 26 / 1/step]
2-434-	Plain2:Size-Env.Correct:FC	PaperTransfer:Low:1Side:S2	ENG	[1 to 110 / 21 / 1/step]

3.SP Mode Tables

SP No.	Large Category	Small Category	ENG or CTL	[Min to Max/Init./Step]
007				
2-434-008	Plain2:Size-Env.Correct:FC	PaperTransfer:Low:2Side:S2	ENG	[1 to 110 / 26 / 1/step]
2-434-009	Plain2:Size-Env.Correct:FC	PaperTransfer:Standard:1Sid:S3	ENG	[1 to 110 / 22 / 1/step]
2-434-010	Plain2:Size-Env.Correct:FC	PaperTransfer:Standard:2Sid:S3	ENG	[1 to 110 / 27 / 1/step]
2-434-011	Plain2:Size-Env.Correct:FC	PaperTransfer:Low:1Side:S3	ENG	[1 to 110 / 22 / 1/step]
2-434-012	Plain2:Size-Env.Correct:FC	PaperTransfer:Low:2Side:S3	ENG	[1 to 110 / 27 / 1/step]
2-434-013	Plain2:Size-Env.Correct:FC	PaperTransfer:Standard:1Sid:S4	ENG	[1 to 110 / 23 / 1/step]
2-434-014	Plain2:Size-Env.Correct:FC	PaperTransfer:Standard:2Sid:S4	ENG	[1 to 110 / 28 / 1/step]
2-434-015	Plain2:Size-Env.Correct:FC	PaperTransfer:Low:1Side:S4	ENG	[1 to 110 / 23 / 1/step]
2-434-	Plain2:Size-Env.Correct:FC	PaperTransfer:Low:2Side:S4	ENG	[1 to 110 / 28 / 1/step]

3.SP Mode Tables

SP No.	Large Category	Small Category	ENG or CTL	[Min to Max/Init./Step]
016				
2-434-017	Plain2:Size-Env.Correct:FC	PaperTransfer:Standard:1Sid:S5	ENG	[1 to 110 / 24 / 1/step]
2-434-018	Plain2:Size-Env.Correct:FC	PaperTransfer:Standard:2Sid:S5	ENG	[1 to 110 / 29 / 1/step]
2-434-019	Plain2:Size-Env.Correct:FC	PaperTransfer:Low:1Side:S5	ENG	[1 to 110 / 24 / 1/step]
2-434-020	Plain2:Size-Env.Correct:FC	PaperTransfer:Low:2Side:S5	ENG	[1 to 110 / 29 / 1/step]
2-434-021	Plain2:Size-Env.Correct:FC	Wide Roller:PaperTransfer:Standard:1Sid:S1	ENG	[1 to 110 / 20 / 1/step]
2-434-022	Plain2:Size-Env.Correct:FC	Wide Roller:PaperTransfer:Standard:2Sid:S1	ENG	[1 to 110 / 25 / 1/step]
2-434-023	Plain2:Size-Env.Correct:FC	Wide Roller:PaperTransfer:Low:1Side:S1	ENG	[1 to 110 / 20 / 1/step]
2-434-024	Plain2:Size-Env.Correct:FC	Wide Roller:PaperTransfer:Low:2Side:S1	ENG	[1 to 110 / 25 / 1/step]
2-434-	Plain2:Size-Env.Correct:FC	Wide Roller:PaperTransfer:Standard:1Sid:S2	ENG	[1 to 110 / 21 / 1/step]

3.SP Mode Tables

SP No.	Large Category	Small Category	ENG or CTL	[Min to Max/Init./Step]
025				
2-434-026	Plain2:Size-Env.Correct:FC	Wide Roller:PaperTransfer:Standard:2Sid:S2	ENG	[1 to 110 / 26 / 1/step]
2-434-027	Plain2:Size-Env.Correct:FC	Wide Roller:PaperTransfer:Low:1Side:S2	ENG	[1 to 110 / 21 / 1/step]
2-434-028	Plain2:Size-Env.Correct:FC	Wide Roller:PaperTransfer:Low:2Side:S2	ENG	[1 to 110 / 26 / 1/step]
2-434-029	Plain2:Size-Env.Correct:FC	Wide Roller:PaperTransfer:Standard:1Sid:S3	ENG	[1 to 110 / 22 / 1/step]
2-434-030	Plain2:Size-Env.Correct:FC	Wide Roller:PaperTransfer:Standard:2Sid:S3	ENG	[1 to 110 / 27 / 1/step]
2-434-031	Plain2:Size-Env.Correct:FC	Wide Roller:PaperTransfer:Low:1Side:S3	ENG	[1 to 110 / 22 / 1/step]
2-434-032	Plain2:Size-Env.Correct:FC	Wide Roller:PaperTransfer:Low:2Side:S3	ENG	[1 to 110 / 27 / 1/step]
2-434-033	Plain2:Size-Env.Correct:FC	Wide Roller:PaperTransfer:Standard:1Sid:S4	ENG	[1 to 110 / 23 / 1/step]
2-434-	Plain2:Size-Env.Correct:FC	Wide Roller:PaperTransfer:Standard:2Sid:S4	ENG	[1 to 110 / 28 / 1/step]

3.SP Mode Tables

SP No.	Large Category	Small Category	ENG or CTL	[Min to Max/Init./Step]
034				
2-434-035	Plain2:Size-Env.Correct:FC	Wide Roller:PaperTransfer:Low:1Side:S4	ENG	[1 to 110 / 23 / 1/step]
2-434-036	Plain2:Size-Env.Correct:FC	Wide Roller:PaperTransfer:Low:2Side:S4	ENG	[1 to 110 / 28 / 1/step]
2-434-037	Plain2:Size-Env.Correct:FC	Wide Roller:PaperTransfer:Standard:1Side:S5	ENG	[1 to 110 / 24 / 1/step]
2-434-038	Plain2:Size-Env.Correct:FC	Wide Roller:PaperTransfer:Standard:2Side:S5	ENG	[1 to 110 / 29 / 1/step]
2-434-039	Plain2:Size-Env.Correct:FC	Wide Roller:PaperTransfer:Low:1Side:S5	ENG	[1 to 110 / 24 / 1/step]
2-434-040	Plain2:Size-Env.Correct:FC	Wide Roller:PaperTransfer:Low:2Side:S5	ENG	[1 to 110 / 29 / 1/step]
2-435-001	Plain2:LeadingEdgeCorrection	PaperTransfer:Standard:1Side	ENG	[0 to 995 / 100 / 5%/step]
2-435-002	Plain2:LeadingEdgeCorrection	PaperTransfer:Standard:2Side	ENG	[0 to 995 / 100 / 5%/step]
2-435-	Plain2:LeadingEdgeCorrection	Paper Transfer:Low:1side	ENG	[0 to 995 / 100 / 5%/step]

3.SP Mode Tables

SP No.	Large Category	Small Category	ENG or CTL	[Min to Max/Init./Step]
003				
2-435-004	Plain2:LeadingEdgeCorrection	Paper Transfer:Low:2side	ENG	[0 to 995 / 100 / 5%/step]
2-436-001	Plain2:SwitchTimingLeadEdge	PaperTransfer:Standard:1side	ENG	[0 to 50 / 0 / 2mm/step]
2-436-002	Plain2:SwitchTimingLeadEdge	PaperTransfer:Standard:2side	ENG	[0 to 50 / 0 / 2mm/step]
2-436-003	Plain2:SwitchTimingLeadEdge	Paper Transfer:Low:1side	ENG	[0 to 50 / 0 / 2mm/step]
2-436-004	Plain2:SwitchTimingLeadEdge	Paper Transfer:Low:2side	ENG	[0 to 50 / 0 / 2mm/step]
2-437-001	Plain2:TrailEdgeCorrection	PaperTransfer:Standard:1Side	ENG	[0 to 995 / 100 / 5%/step]
2-437-002	Plain2:TrailEdgeCorrection	PaperTransfer:Standard:2Side	ENG	[0 to 995 / 100 / 5%/step]
2-437-003	Plain2:TrailEdgeCorrection	Paper Transfer:Low:1side	ENG	[0 to 995 / 100 / 5%/step]
2-437-	Plain2:TrailEdgeCorrection	Paper Transfer:Low:2side	ENG	[0 to 995 / 100 / 5%/step]

3.SP Mode Tables

SP No.	Large Category	Small Category	ENG or CTL	[Min to Max/Init./Step]
004				
2-438-001	Plain2:SwitchTimingTrailEdge	PaperTransfer:Standard:1side	ENG	[0 to 50 / 0 / 2mm/step]
2-438-002	Plain2:SwitchTimingTrailEdge	PaperTransfer:Standard:2side	ENG	[0 to 50 / 0 / 2mm/step]
2-438-003	Plain2:SwitchTimingTrailEdge	Paper Transfer:Low:1side	ENG	[0 to 50 / 0 / 2mm/step]
2-438-004	Plain2:SwitchTimingTrailEdge	Paper Transfer:Low:2side	ENG	[0 to 50 / 0 / 2mm/step]
2-443-001	Middle:Bias:BW	PaperTransfer:standard:1side	ENG	IM C3500: [0 to 200 / 22 / 1-uA/step] IM C2500: [0 to 200 / 22 / 1-uA/step] IM C2000: [0 to 200 / 22 / 1-uA/step] IM C3000: [0 to 200 / 22 / 1-uA/step]
2-443-002	Middle:Bias:BW	PaperTransfer:standard:2side	ENG	IM C3500: [0 to 200 / 22 / 1-uA/step] IM C2500: [0 to 200 / 22 / 1-uA/step] IM C2000:

3.SP Mode Tables

SP No.	Large Category	Small Category	ENG or CTL	[Min to Max/Init./Step]
				[0 to 200 / 22 / 1-uA/step] IM C3000: [0 to 200 / 22 / 1-uA/step]
2-443-003	Middle:Bias:BW	PaperTransfer:low:1side	ENG	IM C3500: [0 to 200 / 11 / 1-uA/step] IM C2500: [0 to 200 / 11 / 1-uA/step] IM C2000: [0 to 200 / 11 / 1-uA/step] IM C3000: [0 to 200 / 11 / 1-uA/step]
2-443-004	Middle:Bias:BW	PaperTransfer:low:2side	ENG	IM C3500: [0 to 200 / 11 / 1-uA/step] IM C2500: [0 to 200 / 11 / 1-uA/step] IM C2000: [0 to 200 / 11 / 1-uA/step] IM C3000: [0 to 200 / 11 / 1-uA/step]
2-447-001	Middle:Bias:FC	PaperTransfer:standard:1side	ENG	IM C3500: [0 to 200 / 29 / 1-uA/step] IM C2500: [0 to 200 / 29 / 1-uA/step] IM C2000:

3.SP Mode Tables

SP No.	Large Category	Small Category	ENG or CTL	[Min to Max/Init./Step]
				[0 to 200 / 29 / 1-uA/step] IM C3000: [0 to 200 / 29 / 1-uA/step]
2-447-002	Middle:Bias:FC	PaperTransfer:standard:2side	ENG	IM C3500: [0 to 200 / 30 / 1-uA/step] IM C2500: [0 to 200 / 30 / 1-uA/step] IM C2000: [0 to 200 / 30 / 1-uA/step] IM C3000: [0 to 200 / 30 / 1-uA/step]
2-447-003	Middle:Bias:FC	PaperTransfer:low:1side	ENG	IM C3500: [0 to 200 / 14 / 1-uA/step] IM C2500: [0 to 200 / 14 / 1-uA/step] IM C2000: [0 to 200 / 14 / 1-uA/step] IM C3000: [0 to 200 / 14 / 1-uA/step]
2-447-004	Middle:Bias:FC	PaperTransfer:low:2side	ENG	IM C3500: [0 to 200 / 15 / 1-uA/step] IM C2500: [0 to 200 / 15 / 1-uA/step] IM C2000:

3.SP Mode Tables

SP No.	Large Category	Small Category	ENG or CTL	[Min to Max/Init./Step]
				[0 to 200 / 15 / 1-uA/step] IM C3000: [0 to 200 / 15 / 1-uA/step]
2-451-001	Middle:SizeCorrection:BW	PaperTransfer:Standard:1Sid:S1	ENG	[100 to 995 / 100 / 1%/step]
2-451-002	Middle:SizeCorrection:BW	PaperTransfer:Standard:2Sid:S1	ENG	[100 to 995 / 100 / 1%/step]
2-451-003	Middle:SizeCorrection:BW	PaperTransfer:Low:1Side:S1	ENG	[100 to 995 / 100 / 1%/step]
2-451-004	Middle:SizeCorrection:BW	PaperTransfer:Low:2Side:S1	ENG	[100 to 995 / 100 / 1%/step]
2-451-005	Middle:SizeCorrection:BW	PaperTransfer:Standard:1Sid:S2	ENG	[100 to 995 / 100 / 1%/step]
2-451-006	Middle:SizeCorrection:BW	PaperTransfer:Standard:2Sid:S2	ENG	[100 to 995 / 106 / 1%/step]
2-451-007	Middle:SizeCorrection:BW	PaperTransfer:Low:1Side:S2	ENG	[100 to 995 / 100 / 1%/step]
2-451-	Middle:SizeCorrection:BW	PaperTransfer:Low:2Side:S2	ENG	[100 to 995 / 106 / 1%/step]

3.SP Mode Tables

SP No.	Large Category	Small Category	ENG or CTL	[Min to Max/Init./Step]
008				
2-451-009	Middle:SizeCorrection:BW	PaperTransfer:Standard:1Sid:S3	ENG	[100 to 995 / 105 / 1%/step]
2-451-010	Middle:SizeCorrection:BW	PaperTransfer:Standard:2Sid:S3	ENG	[100 to 995 / 110 / 1%/step]
2-451-011	Middle:SizeCorrection:BW	PaperTransfer:Low:1Side:S3	ENG	[100 to 995 / 105 / 1%/step]
2-451-012	Middle:SizeCorrection:BW	PaperTransfer:Low:2Side:S3	ENG	[100 to 995 / 110 / 1%/step]
2-451-013	Middle:SizeCorrection:BW	PaperTransfer:Standard:1Sid:S4	ENG	[100 to 995 / 113 / 1%/step]
2-451-014	Middle:SizeCorrection:BW	PaperTransfer:Standard:2Sid:S4	ENG	[100 to 995 / 120 / 1%/step]
2-451-015	Middle:SizeCorrection:BW	PaperTransfer:Low:1Side:S4	ENG	[100 to 995 / 113 / 1%/step]
2-451-016	Middle:SizeCorrection:BW	PaperTransfer:Low:2Side:S4	ENG	[100 to 995 / 120 / 1%/step]
2-451-	Middle:SizeCorrection:BW	PaperTransfer:Standard:1Sid:S5	ENG	[100 to 995 / 118 / 1%/step]

3.SP Mode Tables

SP No.	Large Category	Small Category	ENG or CTL	[Min to Max/Init./Step]
017				
2-451-018	Middle:SizeCorrection:BW	PaperTransfer:Standard:2Sid:S5	ENG	[100 to 995 / 140 / 1%/step]
2-451-019	Middle:SizeCorrection:BW	PaperTransfer:Low:1Side:S5	ENG	[100 to 995 / 118 / 1%/step]
2-451-020	Middle:SizeCorrection:BW	PaperTransfer:Low:2Side:S5	ENG	[100 to 995 / 140 / 1%/step]
2-451-021	Middle:SizeCorrection:BW	Wide Roller:PaperTransfer:Standard:1Sid:S1	ENG	[100 to 995 / 100 / 1%/step]
2-451-022	Middle:SizeCorrection:BW	Wide Roller:PaperTransfer:Standard:2Sid:S1	ENG	[100 to 995 / 100 / 1%/step]
2-451-023	Middle:SizeCorrection:BW	Wide Roller:PaperTransfer:Low:1Side:S1	ENG	[100 to 995 / 100 / 1%/step]
2-451-024	Middle:SizeCorrection:BW	Wide Roller:PaperTransfer:Low:2Side:S1	ENG	[100 to 995 / 100 / 1%/step]
2-451-025	Middle:SizeCorrection:BW	Wide Roller:PaperTransfer:Standard:1Sid:S2	ENG	[100 to 995 / 100 / 1%/step]
2-451-	Middle:SizeCorrection:BW	Wide Roller:PaperTransfer:Standard:2Sid:S2	ENG	[100 to 995 / 106 / 1%/step]

3.SP Mode Tables

SP No.	Large Category	Small Category	ENG or CTL	[Min to Max/Init./Step]
026				
2-451-027	Middle:SizeCorrection:BW	Wide Roller:PaperTransfer:Low:1Side:S2	ENG	[100 to 995 / 100 / 1%/step]
2-451-028	Middle:SizeCorrection:BW	Wide Roller:PaperTransfer:Low:2Side:S2	ENG	[100 to 995 / 106 / 1%/step]
2-451-029	Middle:SizeCorrection:BW	Wide Roller:PaperTransfer:Standard:1Side:S3	ENG	[100 to 995 / 105 / 1%/step]
2-451-030	Middle:SizeCorrection:BW	Wide Roller:PaperTransfer:Standard:2Side:S3	ENG	[100 to 995 / 110 / 1%/step]
2-451-031	Middle:SizeCorrection:BW	Wide Roller:PaperTransfer:Low:1Side:S3	ENG	[100 to 995 / 105 / 1%/step]
2-451-032	Middle:SizeCorrection:BW	Wide Roller:PaperTransfer:Low:2Side:S3	ENG	[100 to 995 / 110 / 1%/step]
2-451-033	Middle:SizeCorrection:BW	Wide Roller:PaperTransfer:Standard:1Side:S4	ENG	[100 to 995 / 113 / 1%/step]
2-451-034	Middle:SizeCorrection:BW	Wide Roller:PaperTransfer:Standard:2Side:S4	ENG	[100 to 995 / 120 / 1%/step]
2-451-	Middle:SizeCorrection:BW	Wide Roller:PaperTransfer:Low:1Side:S4	ENG	[100 to 995 / 113 / 1%/step]

3.SP Mode Tables

SP No.	Large Category	Small Category	ENG or CTL	[Min to Max/Init./Step]
035				
2-451-036	Middle:SizeCorrection:BW	Wide Roller:PaperTransfer:Low:2Side:S4	ENG	[100 to 995 / 120 / 1%/step]
2-451-037	Middle:SizeCorrection:BW	Wide Roller:PaperTransfer:Standard:1Side:S5	ENG	[100 to 995 / 118 / 1%/step]
2-451-038	Middle:SizeCorrection:BW	Wide Roller:PaperTransfer:Standard:2Side:S5	ENG	[100 to 995 / 140 / 1%/step]
2-451-039	Middle:SizeCorrection:BW	Wide Roller:PaperTransfer:Low:1Side:S5	ENG	[100 to 995 / 118 / 1%/step]
2-451-040	Middle:SizeCorrection:BW	Wide Roller:PaperTransfer:Low:2Side:S5	ENG	[100 to 995 / 140 / 1%/step]
2-452-001	Middle:SizeCorrection:FC	PaperTransfer:Standard:1Side:S1	ENG	[100 to 995 / 100 / 1%/step]
2-452-002	Middle:SizeCorrection:FC	PaperTransfer:Standard:2Side:S1	ENG	[100 to 995 / 100 / 1%/step]
2-452-003	Middle:SizeCorrection:FC	PaperTransfer:Low:1Side:S1	ENG	[100 to 995 / 100 / 1%/step]
2-452-	Middle:SizeCorrection:FC	PaperTransfer:Low:2Side:S1	ENG	[100 to 995 / 100 / 1%/step]

3.SP Mode Tables

SP No.	Large Category	Small Category	ENG or CTL	[Min to Max/Init./Step]
004				
2-452-005	Middle:SizeCorrection:FC	PaperTransfer:Standard:1Sid:S2	ENG	[100 to 995 / 106 / 1%/step]
2-452-006	Middle:SizeCorrection:FC	PaperTransfer:Standard:2Sid:S2	ENG	[100 to 995 / 132 / 1%/step]
2-452-007	Middle:SizeCorrection:FC	PaperTransfer:Low:1Side:S2	ENG	[100 to 995 / 106 / 1%/step]
2-452-008	Middle:SizeCorrection:FC	PaperTransfer:Low:2Side:S2	ENG	[100 to 995 / 132 / 1%/step]
2-452-009	Middle:SizeCorrection:FC	PaperTransfer:Standard:1Sid:S3	ENG	[100 to 995 / 110 / 1%/step]
2-452-010	Middle:SizeCorrection:FC	PaperTransfer:Standard:2Sid:S3	ENG	[100 to 995 / 170 / 1%/step]
2-452-011	Middle:SizeCorrection:FC	PaperTransfer:Low:1Side:S3	ENG	[100 to 995 / 110 / 1%/step]
2-452-012	Middle:SizeCorrection:FC	PaperTransfer:Low:2Side:S3	ENG	[100 to 995 / 170 / 1%/step]
2-452-	Middle:SizeCorrection:FC	PaperTransfer:Standard:1Sid:S4	ENG	[100 to 995 / 120 / 1%/step]

3.SP Mode Tables

SP No.	Large Category	Small Category	ENG or CTL	[Min to Max/Init./Step]
013				
2-452-014	Middle:SizeCorrection:FC	PaperTransfer:Standard:2Sid:S4	ENG	[100 to 995 / 189 / 1%/step]
2-452-015	Middle:SizeCorrection:FC	PaperTransfer:Low:1Side:S4	ENG	[100 to 995 / 120 / 1%/step]
2-452-016	Middle:SizeCorrection:FC	PaperTransfer:Low:2Side:S4	ENG	[100 to 995 / 189 / 1%/step]
2-452-017	Middle:SizeCorrection:FC	PaperTransfer:Standard:1Sid:S5	ENG	[100 to 995 / 140 / 1%/step]
2-452-018	Middle:SizeCorrection:FC	PaperTransfer:Standard:2Sid:S5	ENG	[100 to 995 / 245 / 1%/step]
2-452-019	Middle:SizeCorrection:FC	PaperTransfer:Low:1Side:S5	ENG	[100 to 995 / 140 / 1%/step]
2-452-020	Middle:SizeCorrection:FC	PaperTransfer:Low:2Side:S5	ENG	[100 to 995 / 245 / 1%/step]
2-452-021	Middle:SizeCorrection:FC	Wide Roller:PaperTransfer:Standard:1Sid:S1	ENG	[100 to 995 / 100 / 1%/step]
2-452-	Middle:SizeCorrection:FC	Wide Roller:PaperTransfer:Standard:2Sid:S1	ENG	[100 to 995 / 100 / 1%/step]

3.SP Mode Tables

SP No.	Large Category	Small Category	ENG or CTL	[Min to Max/Init./Step]
022				
2-452-023	Middle:SizeCorrection:FC	Wide Roller:PaperTransfer:Low:1Side:S1	ENG	[100 to 995 / 100 / 1%/step]
2-452-024	Middle:SizeCorrection:FC	Wide Roller:PaperTransfer:Low:2Side:S1	ENG	[100 to 995 / 100 / 1%/step]
2-452-025	Middle:SizeCorrection:FC	Wide Roller:PaperTransfer:Standard:1Side:S2	ENG	[100 to 995 / 106 / 1%/step]
2-452-026	Middle:SizeCorrection:FC	Wide Roller:PaperTransfer:Standard:2Side:S2	ENG	[100 to 995 / 132 / 1%/step]
2-452-027	Middle:SizeCorrection:FC	Wide Roller:PaperTransfer:Low:1Side:S2	ENG	[100 to 995 / 106 / 1%/step]
2-452-028	Middle:SizeCorrection:FC	Wide Roller:PaperTransfer:Low:2Side:S2	ENG	[100 to 995 / 132 / 1%/step]
2-452-029	Middle:SizeCorrection:FC	Wide Roller:PaperTransfer:Standard:1Side:S3	ENG	[100 to 995 / 110 / 1%/step]
2-452-030	Middle:SizeCorrection:FC	Wide Roller:PaperTransfer:Standard:2Side:S3	ENG	[100 to 995 / 170 / 1%/step]
2-452-	Middle:SizeCorrection:FC	Wide Roller:PaperTransfer:Low:1Side:S3	ENG	[100 to 995 / 110 / 1%/step]

3.SP Mode Tables

SP No.	Large Category	Small Category	ENG or CTL	[Min to Max/Init./Step]
031				
2-452-032	Middle:SizeCorrection:FC	Wide Roller:PaperTransfer:Low:2Side:S3	ENG	[100 to 995 / 170 / 1%/step]
2-452-033	Middle:SizeCorrection:FC	Wide Roller:PaperTransfer:Standard:1Side:S4	ENG	[100 to 995 / 120 / 1%/step]
2-452-034	Middle:SizeCorrection:FC	Wide Roller:PaperTransfer:Standard:2Side:S4	ENG	[100 to 995 / 189 / 1%/step]
2-452-035	Middle:SizeCorrection:FC	Wide Roller:PaperTransfer:Low:1Side:S4	ENG	[100 to 995 / 120 / 1%/step]
2-452-036	Middle:SizeCorrection:FC	Wide Roller:PaperTransfer:Low:2Side:S4	ENG	[100 to 995 / 189 / 1%/step]
2-452-037	Middle:SizeCorrection:FC	Wide Roller:PaperTransfer:Standard:1Side:S5	ENG	[100 to 995 / 140 / 1%/step]
2-452-038	Middle:SizeCorrection:FC	Wide Roller:PaperTransfer:Standard:2Side:S5	ENG	[100 to 995 / 245 / 1%/step]
2-452-039	Middle:SizeCorrection:FC	Wide Roller:PaperTransfer:Low:1Side:S5	ENG	[100 to 995 / 140 / 1%/step]
2-452-	Middle:SizeCorrection:FC	Wide Roller:PaperTransfer:Low:2Side:S5	ENG	[100 to 995 / 245 / 1%/step]

3.SP Mode Tables

SP No.	Large Category	Small Category	ENG or CTL	[Min to Max/Init./Step]
040				
2-453-001	Middle:Size-Env.Correct:BW	PaperTransfer:Standard:1Sid:S1	ENG	[1 to 110 / 10 / 1/step]
2-453-002	Middle:Size-Env.Correct:BW	PaperTransfer:Standard:2Sid:S1	ENG	[1 to 110 / 41 / 1/step]
2-453-003	Middle:Size-Env.Correct:BW	PaperTransfer:Low:1Side:S1	ENG	[1 to 110 / 10 / 1/step]
2-453-004	Middle:Size-Env.Correct:BW	PaperTransfer:Low:2Side:S1	ENG	[1 to 110 / 41 / 1/step]
2-453-005	Middle:Size-Env.Correct:BW	PaperTransfer:Standard:1Sid:S2	ENG	[1 to 110 / 39 / 1/step]
2-453-006	Middle:Size-Env.Correct:BW	PaperTransfer:Standard:2Sid:S2	ENG	[1 to 110 / 42 / 1/step]
2-453-007	Middle:Size-Env.Correct:BW	PaperTransfer:Low:1Side:S2	ENG	[1 to 110 / 39 / 1/step]
2-453-008	Middle:Size-Env.Correct:BW	PaperTransfer:Low:2Side:S2	ENG	[1 to 110 / 42 / 1/step]
2-453-	Middle:Size-Env.Correct:BW	PaperTransfer:Standard:1Sid:S3	ENG	[1 to 110 / 40 / 1/step]

3.SP Mode Tables

SP No.	Large Category	Small Category	ENG or CTL	[Min to Max/Init./Step]
009				
2-453-010	Middle:Size-Env.Correct:BW	PaperTransfer:Standard:2Sid:S3	ENG	[1 to 110 / 43 / 1/step]
2-453-011	Middle:Size-Env.Correct:BW	PaperTransfer:Low:1Side:S3	ENG	[1 to 110 / 40 / 1/step]
2-453-012	Middle:Size-Env.Correct:BW	PaperTransfer:Low:2Side:S3	ENG	[1 to 110 / 43 / 1/step]
2-453-013	Middle:Size-Env.Correct:BW	PaperTransfer:Standard:1Sid:S4	ENG	[1 to 110 / 40 / 1/step]
2-453-014	Middle:Size-Env.Correct:BW	PaperTransfer:Standard:2Sid:S4	ENG	[1 to 110 / 44 / 1/step]
2-453-015	Middle:Size-Env.Correct:BW	PaperTransfer:Low:1Side:S4	ENG	[1 to 110 / 40 / 1/step]
2-453-016	Middle:Size-Env.Correct:BW	PaperTransfer:Low:2Side:S4	ENG	[1 to 110 / 44 / 1/step]
2-453-017	Middle:Size-Env.Correct:BW	PaperTransfer:Standard:1Sid:S5	ENG	[1 to 110 / 40 / 1/step]
2-453-	Middle:Size-Env.Correct:BW	PaperTransfer:Standard:2Sid:S5	ENG	[1 to 110 / 45 / 1/step]

3.SP Mode Tables

SP No.	Large Category	Small Category	ENG or CTL	[Min to Max/Init./Step]
018				
2-453-019	Middle:Size-Env.Correct:BW	PaperTransfer:Low:1Side:S5	ENG	[1 to 110 / 40 / 1/step]
2-453-020	Middle:Size-Env.Correct:BW	PaperTransfer:Low:2Side:S5	ENG	[1 to 110 / 45 / 1/step]
2-453-021	Middle:Size-Env.Correct:BW	Wide Roller:PaperTransfer:Standard:1Side:S1	ENG	[1 to 110 / 10 / 1/step]
2-453-022	Middle:Size-Env.Correct:BW	Wide Roller:PaperTransfer:Standard:2Side:S1	ENG	[1 to 110 / 41 / 1/step]
2-453-023	Middle:Size-Env.Correct:BW	Wide Roller:PaperTransfer:Low:1Side:S1	ENG	[1 to 110 / 10 / 1/step]
2-453-024	Middle:Size-Env.Correct:BW	Wide Roller:PaperTransfer:Low:2Side:S1	ENG	[1 to 110 / 41 / 1/step]
2-453-025	Middle:Size-Env.Correct:BW	Wide Roller:PaperTransfer:Standard:1Side:S2	ENG	[1 to 110 / 39 / 1/step]
2-453-026	Middle:Size-Env.Correct:BW	Wide Roller:PaperTransfer:Standard:2Side:S2	ENG	[1 to 110 / 42 / 1/step]
2-453-	Middle:Size-Env.Correct:BW	Wide Roller:PaperTransfer:Low:1Side:S2	ENG	[1 to 110 / 39 / 1/step]

3.SP Mode Tables

SP No.	Large Category	Small Category	ENG or CTL	[Min to Max/Init./Step]
027				
2-453-028	Middle:Size-Env.Correct:BW	Wide Roller:PaperTransfer:Low:2Side:S2	ENG	[1 to 110 / 42 / 1/step]
2-453-029	Middle:Size-Env.Correct:BW	Wide Roller:PaperTransfer:Standard:1Side:S3	ENG	[1 to 110 / 40 / 1/step]
2-453-030	Middle:Size-Env.Correct:BW	Wide Roller:PaperTransfer:Standard:2Side:S3	ENG	[1 to 110 / 43 / 1/step]
2-453-031	Middle:Size-Env.Correct:BW	Wide Roller:PaperTransfer:Low:1Side:S3	ENG	[1 to 110 / 40 / 1/step]
2-453-032	Middle:Size-Env.Correct:BW	Wide Roller:PaperTransfer:Low:2Side:S3	ENG	[1 to 110 / 43 / 1/step]
2-453-033	Middle:Size-Env.Correct:BW	Wide Roller:PaperTransfer:Standard:1Side:S4	ENG	[1 to 110 / 40 / 1/step]
2-453-034	Middle:Size-Env.Correct:BW	Wide Roller:PaperTransfer:Standard:2Side:S4	ENG	[1 to 110 / 44 / 1/step]
2-453-035	Middle:Size-Env.Correct:BW	Wide Roller:PaperTransfer:Low:1Side:S4	ENG	[1 to 110 / 40 / 1/step]
2-453-	Middle:Size-Env.Correct:BW	Wide Roller:PaperTransfer:Low:2Side:S4	ENG	[1 to 110 / 44 / 1/step]

3.SP Mode Tables

SP No.	Large Category	Small Category	ENG or CTL	[Min to Max/Init./Step]
036				
2-453-037	Middle:Size-Env.Correct:BW	Wide Roller:PaperTransfer:Standard:1Sid:S5	ENG	[1 to 110 / 40 / 1/step]
2-453-038	Middle:Size-Env.Correct:BW	Wide Roller:PaperTransfer:Standard:2Sid:S5	ENG	[1 to 110 / 45 / 1/step]
2-453-039	Middle:Size-Env.Correct:BW	Wide Roller:PaperTransfer:Low:1Side:S5	ENG	[1 to 110 / 40 / 1/step]
2-453-040	Middle:Size-Env.Correct:BW	Wide Roller:PaperTransfer:Low:2Side:S5	ENG	[1 to 110 / 45 / 1/step]
2-454-001	Middle:Size-Env.Correct:FC	PaperTransfer:Standard:1Sid:S1	ENG	[1 to 110 / 20 / 1/step]
2-454-002	Middle:Size-Env.Correct:FC	PaperTransfer:Standard:2Sid:S1	ENG	[1 to 110 / 49 / 1/step]
2-454-003	Middle:Size-Env.Correct:FC	PaperTransfer:Low:1Side:S1	ENG	[1 to 110 / 20 / 1/step]
2-454-004	Middle:Size-Env.Correct:FC	PaperTransfer:Low:2Side:S1	ENG	[1 to 110 / 49 / 1/step]
2-454-	Middle:Size-Env.Correct:FC	PaperTransfer:Standard:1Sid:S2	ENG	[1 to 110 / 46 / 1/step]

3.SP Mode Tables

SP No.	Large Category	Small Category	ENG or CTL	[Min to Max/Init./Step]
005				
2-454-006	Middle:Size-Env.Correct:FC	PaperTransfer:Standard:2Sid:S2	ENG	[1 to 110 / 50 / 1/step]
2-454-007	Middle:Size-Env.Correct:FC	PaperTransfer:Low:1Side:S2	ENG	[1 to 110 / 46 / 1/step]
2-454-008	Middle:Size-Env.Correct:FC	PaperTransfer:Low:2Side:S2	ENG	[1 to 110 / 50 / 1/step]
2-454-009	Middle:Size-Env.Correct:FC	PaperTransfer:Standard:1Sid:S3	ENG	[1 to 110 / 47 / 1/step]
2-454-010	Middle:Size-Env.Correct:FC	PaperTransfer:Standard:2Sid:S3	ENG	[1 to 110 / 51 / 1/step]
2-454-011	Middle:Size-Env.Correct:FC	PaperTransfer:Low:1Side:S3	ENG	[1 to 110 / 47 / 1/step]
2-454-012	Middle:Size-Env.Correct:FC	PaperTransfer:Low:2Side:S3	ENG	[1 to 110 / 51 / 1/step]
2-454-013	Middle:Size-Env.Correct:FC	PaperTransfer:Standard:1Sid:S4	ENG	[1 to 110 / 48 / 1/step]
2-454-	Middle:Size-Env.Correct:FC	PaperTransfer:Standard:2Sid:S4	ENG	[1 to 110 / 52 / 1/step]

3.SP Mode Tables

SP No.	Large Category	Small Category	ENG or CTL	[Min to Max/Init./Step]
014				
2-454-015	Middle:Size-Env.Correct:FC	PaperTransfer:Low:1Side:S4	ENG	[1 to 110 / 48 / 1/step]
2-454-016	Middle:Size-Env.Correct:FC	PaperTransfer:Low:2Side:S4	ENG	[1 to 110 / 52 / 1/step]
2-454-017	Middle:Size-Env.Correct:FC	PaperTransfer:Standard:1Sid:S5	ENG	[1 to 110 / 48 / 1/step]
2-454-018	Middle:Size-Env.Correct:FC	PaperTransfer:Standard:2Sid:S5	ENG	[1 to 110 / 53 / 1/step]
2-454-019	Middle:Size-Env.Correct:FC	PaperTransfer:Low:1Side:S5	ENG	[1 to 110 / 48 / 1/step]
2-454-020	Middle:Size-Env.Correct:FC	PaperTransfer:Low:2Side:S5	ENG	[1 to 110 / 53 / 1/step]
2-454-021	Middle:Size-Env.Correct:FC	Wide Roller:PaperTransfer:Standard:1Sid:S1	ENG	[1 to 110 / 20 / 1/step]
2-454-022	Middle:Size-Env.Correct:FC	Wide Roller:PaperTransfer:Standard:2Sid:S1	ENG	[1 to 110 / 49 / 1/step]
2-454-	Middle:Size-Env.Correct:FC	Wide Roller:PaperTransfer:Low:1Side:S1	ENG	[1 to 110 / 20 / 1/step]

3.SP Mode Tables

SP No.	Large Category	Small Category	ENG or CTL	[Min to Max/Init./Step]
023				
2-454-024	Middle:Size-Env.Correct:FC	Wide Roller:PaperTransfer:Low:2Side:S1	ENG	[1 to 110 / 49 / 1/step]
2-454-025	Middle:Size-Env.Correct:FC	Wide Roller:PaperTransfer:Standard:1Side:S2	ENG	[1 to 110 / 46 / 1/step]
2-454-026	Middle:Size-Env.Correct:FC	Wide Roller:PaperTransfer:Standard:2Side:S2	ENG	[1 to 110 / 50 / 1/step]
2-454-027	Middle:Size-Env.Correct:FC	Wide Roller:PaperTransfer:Low:1Side:S2	ENG	[1 to 110 / 46 / 1/step]
2-454-028	Middle:Size-Env.Correct:FC	Wide Roller:PaperTransfer:Low:2Side:S2	ENG	[1 to 110 / 50 / 1/step]
2-454-029	Middle:Size-Env.Correct:FC	Wide Roller:PaperTransfer:Standard:1Side:S3	ENG	[1 to 110 / 47 / 1/step]
2-454-030	Middle:Size-Env.Correct:FC	Wide Roller:PaperTransfer:Standard:2Side:S3	ENG	[1 to 110 / 51 / 1/step]
2-454-031	Middle:Size-Env.Correct:FC	Wide Roller:PaperTransfer:Low:1Side:S3	ENG	[1 to 110 / 47 / 1/step]
2-454-	Middle:Size-Env.Correct:FC	Wide Roller:PaperTransfer:Low:2Side:S3	ENG	[1 to 110 / 51 / 1/step]

3.SP Mode Tables

SP No.	Large Category	Small Category	ENG or CTL	[Min to Max/Init./Step]
032				
2-454-033	Middle:Size-Env.Correct:FC	Wide Roller:PaperTransfer:Standard:1Sid: S4	ENG	[1 to 110 / 48 / 1/step]
2-454-034	Middle:Size-Env.Correct:FC	Wide Roller:PaperTransfer:Standard:2Sid: S4	ENG	[1 to 110 / 52 / 1/step]
2-454-035	Middle:Size-Env.Correct:FC	Wide Roller:PaperTransfer:Low:1Side:S4	ENG	[1 to 110 / 48 / 1/step]
2-454-036	Middle:Size-Env.Correct:FC	Wide Roller:PaperTransfer:Low:2Side:S4	ENG	[1 to 110 / 52 / 1/step]
2-454-037	Middle:Size-Env.Correct:FC	Wide Roller:PaperTransfer:Standard:1Sid: S5	ENG	[1 to 110 / 48 / 1/step]
2-454-038	Middle:Size-Env.Correct:FC	Wide Roller:PaperTransfer:Standard:2Sid: S5	ENG	[1 to 110 / 53 / 1/step]
2-454-039	Middle:Size-Env.Correct:FC	Wide Roller:PaperTransfer:Low:1Side:S5	ENG	[1 to 110 / 48 / 1/step]
2-454-040	Middle:Size-Env.Correct:FC	Wide Roller:PaperTransfer:Low:2Side:S5	ENG	[1 to 110 / 53 / 1/step]
2-455-	Middle:LeadingEdgeCorrection	PaperTransfer:Standard:1Side	ENG	[0 to 995 / 100 / 5%/step]

3.SP Mode Tables

SP No.	Large Category	Small Category	ENG or CTL	[Min to Max/Init./Step]
001				
2-455-002	Middle:LeadingEdgeCorrection	PaperTransfer:Standard:2Side	ENG	[0 to 995 / 100 / 5%/step]
2-455-003	Middle:LeadingEdgeCorrection	Paper Transfer:Low:1side	ENG	[0 to 995 / 100 / 5%/step]
2-455-004	Middle:LeadingEdgeCorrection	Paper Transfer:Low:2side	ENG	[0 to 995 / 100 / 5%/step]
2-456-001	Middle:SwitchTimingLeadEdge	PaperTransfer:Standard:1side	ENG	[0 to 50 / 0 / 2mm/step]
2-456-002	Middle:SwitchTimingLeadEdge	PaperTransfer:Standard:2side	ENG	[0 to 50 / 0 / 2mm/step]
2-456-003	Middle:SwitchTimingLeadEdge	Paper Transfer:Low:1side	ENG	[0 to 50 / 0 / 2mm/step]
2-456-004	Middle:SwitchTimingLeadEdge	Paper Transfer:Low:2side	ENG	[0 to 50 / 0 / 2mm/step]
2-457-001	Middle:TrailEdgeCorrection	PaperTransfer:Standard:1Side	ENG	[0 to 995 / 100 / 5%/step]
2-457-	Middle:TrailEdgeCorrection	PaperTransfer:Standard:2Side	ENG	[0 to 995 / 100 / 5%/step]

3.SP Mode Tables

SP No.	Large Category	Small Category	ENG or CTL	[Min to Max/Init./Step]
002				
2-457-003	Middle:TrailEdgeCorrection	Paper Transfer:Low:1side	ENG	[0 to 995 / 100 / 5%/step]
2-457-004	Middle:TrailEdgeCorrection	Paper Transfer:Low:2side	ENG	[0 to 995 / 100 / 5%/step]
2-458-001	Middle:SwitchTimingTrailEdge	PaperTransfer:Standard:1side	ENG	[0 to 50 / 0 / 2mm/step]
2-458-002	Middle:SwitchTimingTrailEdge	PaperTransfer:Standard:2side	ENG	[0 to 50 / 0 / 2mm/step]
2-458-003	Middle:SwitchTimingTrailEdge	Paper Transfer:Low:1side	ENG	[0 to 50 / 0 / 2mm/step]
2-458-004	Middle:SwitchTimingTrailEdge	Paper Transfer:Low:2side	ENG	[0 to 50 / 0 / 2mm/step]
2-463-001	Thin:Bias:BW	PaperTransfer:Standard:1Sid	ENG	IM C3500: [0 to 200 / 22 / 1-uA/step] IM C2500: [0 to 200 / 22 / 1-uA/step] IM C2000: [0 to 200 / 22 / 1-uA/step] IM C3000: [0 to 200 / 22

3.SP Mode Tables

SP No.	Large Category	Small Category	ENG or CTL	[Min to Max/Init./Step]
				/ 1-uA/step]
2-463-002	Thin: Bias: BW	Paper Transfer: Standard: 2Sid	ENG	IM C3500: [0 to 200 / 22 / 1-uA/step] IM C2500: [0 to 200 / 22 / 1-uA/step] IM C2000: [0 to 200 / 22 / 1-uA/step] IM C3000: [0 to 200 / 22 / 1-uA/step]
2-463-003	Thin: Bias: BW	Paper Transfer: Low: 1side	ENG	IM C3500: [0 to 200 / 11 / 1-uA/step] IM C2500: [0 to 200 / 11 / 1-uA/step] IM C2000: [0 to 200 / 11 / 1-uA/step] IM C3000: [0 to 200 / 11 / 1-uA/step]
2-463-004	Thin: Bias: BW	Paper Transfer: Low: 2side	ENG	IM C3500: [0 to 200 / 11 / 1-uA/step] IM C2500: [0 to 200 / 11 / 1-uA/step] IM C2000: [0 to 200 / 11 / 1-uA/step] IM C3000: [0 to 200 / 11 / 1-uA/step]

3.SP Mode Tables

SP No.	Large Category	Small Category	ENG or CTL	[Min to Max/Init./Step]
				/ 1-uA/step]
2-467-001	Thin:Bias:FC	PaperTransfer:Standard:1Sid	ENG	IM C3500: [0 to 200 / 29 / 1-uA/step] IM C2500: [0 to 200 / 29 / 1-uA/step] IM C2000: [0 to 200 / 29 / 1-uA/step] IM C3000: [0 to 200 / 29 / 1-uA/step]
2-467-002	Thin:Bias:FC	PaperTransfer:Standard:2Sid	ENG	IM C3500: [0 to 200 / 29 / 1-uA/step] IM C2500: [0 to 200 / 29 / 1-uA/step] IM C2000: [0 to 200 / 29 / 1-uA/step] IM C3000: [0 to 200 / 29 / 1-uA/step]
2-467-003	Thin:Bias:FC	Paper Transfer:Low:1side	ENG	IM C3500: [0 to 200 / 14 / 1-uA/step] IM C2500: [0 to 200 / 14 / 1-uA/step] IM C2000: [0 to 200 / 14 / 1-uA/step] IM C3000: [0 to 200 / 14

3.SP Mode Tables

SP No.	Large Category	Small Category	ENG or CTL	[Min to Max/Init./Step]
				/ 1-uA/step]
2-467-004	Thin:Bias:FC	Paper Transfer:Low:2side	ENG	IM C3500: [0 to 200 / 14 / 1-uA/step] IM C2500: [0 to 200 / 14 / 1-uA/step] IM C2000: [0 to 200 / 14 / 1-uA/step] IM C3000: [0 to 200 / 14 / 1-uA/step]
2-471-001	Thin:SizeCorrection:BW	PaperTransfer:Standard:1Sid:S1	ENG	[100 to 995 / 100 / 1%/step]
2-471-002	Thin:SizeCorrection:BW	PaperTransfer:Standard:2Sid:S1	ENG	[100 to 995 / 100 / 1%/step]
2-471-003	Thin:SizeCorrection:BW	PaperTransfer:Low:1Side:S1	ENG	[100 to 995 / 100 / 1%/step]
2-471-004	Thin:SizeCorrection:BW	PaperTransfer:Low:2Side:S1	ENG	[100 to 995 / 100 / 1%/step]
2-471-005	Thin:SizeCorrection:BW	PaperTransfer:Standard:1Sid:S2	ENG	[100 to 995 / 100 / 1%/step]
2-471-	Thin:SizeCorrection:BW	PaperTransfer:Standard:2Sid:S2	ENG	[100 to 995 / 105 / 1%/step]

3.SP Mode Tables

SP No.	Large Category	Small Category	ENG or CTL	[Min to Max/Init./Step]
006				
2-471-007	Thin:SizeCorrection:BW	PaperTransfer:Low:1Side:S2	ENG	[100 to 995 / 100 / 1%/step]
2-471-008	Thin:SizeCorrection:BW	PaperTransfer:Low:2Side:S2	ENG	[100 to 995 / 105 / 1%/step]
2-471-009	Thin:SizeCorrection:BW	PaperTransfer:Standard:1Sid:S3	ENG	[100 to 995 / 111 / 1%/step]
2-471-010	Thin:SizeCorrection:BW	PaperTransfer:Standard:2Sid:S3	ENG	[100 to 995 / 140 / 1%/step]
2-471-011	Thin:SizeCorrection:BW	PaperTransfer:Low:1Side:S3	ENG	[100 to 995 / 111 / 1%/step]
2-471-012	Thin:SizeCorrection:BW	PaperTransfer:Low:2Side:S3	ENG	[100 to 995 / 140 / 1%/step]
2-471-013	Thin:SizeCorrection:BW	PaperTransfer:Standard:1Sid:S4	ENG	[100 to 995 / 121 / 1%/step]
2-471-014	Thin:SizeCorrection:BW	PaperTransfer:Standard:2Sid:S4	ENG	[100 to 995 / 175 / 1%/step]
2-471-	Thin:SizeCorrection:BW	PaperTransfer:Low:1Side:S4	ENG	[100 to 995 / 121 / 1%/step]

3.SP Mode Tables

SP No.	Large Category	Small Category	ENG or CTL	[Min to Max/Init./Step]
015				
2-471-016	Thin:SizeCorrection:BW	PaperTransfer:Low:2Side:S4	ENG	[100 to 995 / 175 / 1%/step]
2-471-017	Thin:SizeCorrection:BW	PaperTransfer:Standard:1Sid:S5	ENG	[100 to 995 / 132 / 1%/step]
2-471-018	Thin:SizeCorrection:BW	PaperTransfer:Standard:2Sid:S5	ENG	[100 to 995 / 211 / 1%/step]
2-471-019	Thin:SizeCorrection:BW	PaperTransfer:Low:1Side:S5	ENG	[100 to 995 / 132 / 1%/step]
2-471-020	Thin:SizeCorrection:BW	PaperTransfer:Low:2Side:S5	ENG	[100 to 995 / 211 / 1%/step]
2-471-021	Thin:SizeCorrection:BW	Wide Roller:PaperTransfer:Standard:1Sid:S1	ENG	[100 to 995 / 100 / 1%/step]
2-471-022	Thin:SizeCorrection:BW	Wide Roller:PaperTransfer:Standard:2Sid:S1	ENG	[100 to 995 / 100 / 1%/step]
2-471-023	Thin:SizeCorrection:BW	Wide Roller:PaperTransfer:Low:1Side:S1	ENG	[100 to 995 / 100 / 1%/step]
2-471-	Thin:SizeCorrection:BW	Wide Roller:PaperTransfer:Low:2Side:S1	ENG	[100 to 995 / 100 / 1%/step]

3.SP Mode Tables

SP No.	Large Category	Small Category	ENG or CTL	[Min to Max/Init./Step]
024				
2-471-025	Thin:SizeCorrection:BW	Wide Roller:PaperTransfer:Standard:1Side:S2	ENG	[100 to 995 / 100 / 1%/step]
2-471-026	Thin:SizeCorrection:BW	Wide Roller:PaperTransfer:Standard:2Side:S2	ENG	[100 to 995 / 105 / 1%/step]
2-471-027	Thin:SizeCorrection:BW	Wide Roller:PaperTransfer:Low:1Side:S2	ENG	[100 to 995 / 100 / 1%/step]
2-471-028	Thin:SizeCorrection:BW	Wide Roller:PaperTransfer:Low:2Side:S2	ENG	[100 to 995 / 105 / 1%/step]
2-471-029	Thin:SizeCorrection:BW	Wide Roller:PaperTransfer:Standard:1Side:S3	ENG	[100 to 995 / 111 / 1%/step]
2-471-030	Thin:SizeCorrection:BW	Wide Roller:PaperTransfer:Standard:2Side:S3	ENG	[100 to 995 / 140 / 1%/step]
2-471-031	Thin:SizeCorrection:BW	Wide Roller:PaperTransfer:Low:1Side:S3	ENG	[100 to 995 / 111 / 1%/step]
2-471-032	Thin:SizeCorrection:BW	Wide Roller:PaperTransfer:Low:2Side:S3	ENG	[100 to 995 / 140 / 1%/step]
2-471-	Thin:SizeCorrection:BW	Wide Roller:PaperTransfer:Standard:1Side:S4	ENG	[100 to 995 / 121 / 1%/step]

3.SP Mode Tables

SP No.	Large Category	Small Category	ENG or CTL	[Min to Max/Init./Step]
033				
2-471-034	Thin:SizeCorrection:BW	Wide Roller:PaperTransfer:Standard:2Sid:S4	ENG	[100 to 995 / 175 / 1%/step]
2-471-035	Thin:SizeCorrection:BW	Wide Roller:PaperTransfer:Low:1Side:S4	ENG	[100 to 995 / 121 / 1%/step]
2-471-036	Thin:SizeCorrection:BW	Wide Roller:PaperTransfer:Low:2Side:S4	ENG	[100 to 995 / 175 / 1%/step]
2-471-037	Thin:SizeCorrection:BW	Wide Roller:PaperTransfer:Standard:1Sid:S5	ENG	[100 to 995 / 132 / 1%/step]
2-471-038	Thin:SizeCorrection:BW	Wide Roller:PaperTransfer:Standard:2Sid:S5	ENG	[100 to 995 / 211 / 1%/step]
2-471-039	Thin:SizeCorrection:BW	Wide Roller:PaperTransfer:Low:1Side:S5	ENG	[100 to 995 / 132 / 1%/step]
2-471-040	Thin:SizeCorrection:BW	Wide Roller:PaperTransfer:Low:2Side:S5	ENG	[100 to 995 / 211 / 1%/step]
2-472-001	Thin:SizeCorrection:FC	PaperTransfer:Standard:1Sid:S1	ENG	[100 to 995 / 100 / 1%/step]
2-472-	Thin:SizeCorrection:FC	PaperTransfer:Standard:1Sid:S1	ENG	[100 to 995 / 100 / 1%/step]

3.SP Mode Tables

SP No.	Large Category	Small Category	ENG or CTL	[Min to Max/Init./Step]
002				
2-472-003	Thin:SizeCorrection:FC	PaperTransfer:Low:1Side:S1	ENG	[100 to 995 / 100 / 1%/step]
2-472-004	Thin:SizeCorrection:FC	PaperTransfer:Low:1Side:S1	ENG	[100 to 995 / 100 / 1%/step]
2-472-005	Thin:SizeCorrection:FC	PaperTransfer:Standard:1Sid:S2	ENG	[100 to 995 / 106 / 1%/step]
2-472-006	Thin:SizeCorrection:FC	PaperTransfer:Standard:1Sid:S2	ENG	[100 to 995 / 130 / 1%/step]
2-472-007	Thin:SizeCorrection:FC	PaperTransfer:Low:1Side:S2	ENG	[100 to 995 / 106 / 1%/step]
2-472-008	Thin:SizeCorrection:FC	PaperTransfer:Low:1Side:S2	ENG	[100 to 995 / 130 / 1%/step]
2-472-009	Thin:SizeCorrection:FC	PaperTransfer:Standard:1Sid:S3	ENG	[100 to 995 / 117 / 1%/step]
2-472-010	Thin:SizeCorrection:FC	PaperTransfer:Standard:1Sid:S3	ENG	[100 to 995 / 153 / 1%/step]
2-472-	Thin:SizeCorrection:FC	PaperTransfer:Low:1Side:S3	ENG	[100 to 995 / 117 / 1%/step]

3.SP Mode Tables

SP No.	Large Category	Small Category	ENG or CTL	[Min to Max/Init./Step]
011				
2-472-012	Thin:SizeCorrection:FC	PaperTransfer:Low:1Side:S3	ENG	[100 to 995 / 153 / 1%/step]
2-472-013	Thin:SizeCorrection:FC	PaperTransfer:Standard:1Sid:S4	ENG	[100 to 995 / 128 / 1%/step]
2-472-014	Thin:SizeCorrection:FC	PaperTransfer:Standard:1Sid:S4	ENG	[100 to 995 / 177 / 1%/step]
2-472-015	Thin:SizeCorrection:FC	PaperTransfer:Low:1Side:S4	ENG	[100 to 995 / 128 / 1%/step]
2-472-016	Thin:SizeCorrection:FC	PaperTransfer:Low:1Side:S4	ENG	[100 to 995 / 177 / 1%/step]
2-472-017	Thin:SizeCorrection:FC	PaperTransfer:Standard:1Sid:S5	ENG	[100 to 995 / 140 / 1%/step]
2-472-018	Thin:SizeCorrection:FC	PaperTransfer:Standard:2Sid:S5	ENG	[100 to 995 / 200 / 1%/step]
2-472-019	Thin:SizeCorrection:FC	PaperTransfer:Low:1Side:S5	ENG	[100 to 995 / 140 / 1%/step]
2-472-	Thin:SizeCorrection:FC	PaperTransfer:Low:2Side:S5	ENG	[100 to 995 / 200 / 1%/step]

3.SP Mode Tables

SP No.	Large Category	Small Category	ENG or CTL	[Min to Max/Init./Step]
020				
2-472-021	Thin:SizeCorrection:FC	Wide Roller:PaperTransfer:Standard:1Side:S1	ENG	[100 to 995 / 100 / 1%/step]
2-472-022	Thin:SizeCorrection:FC	Wide Roller:PaperTransfer:Standard:2Side:S1	ENG	[100 to 995 / 100 / 1%/step]
2-472-023	Thin:SizeCorrection:FC	Wide Roller:PaperTransfer:Low:1Side:S1	ENG	[100 to 995 / 100 / 1%/step]
2-472-024	Thin:SizeCorrection:FC	Wide Roller:PaperTransfer:Low:2Side:S1	ENG	[100 to 995 / 100 / 1%/step]
2-472-025	Thin:SizeCorrection:FC	Wide Roller:PaperTransfer:Standard:1Side:S2	ENG	[100 to 995 / 106 / 1%/step]
2-472-026	Thin:SizeCorrection:FC	Wide Roller:PaperTransfer:Standard:2Side:S2	ENG	[100 to 995 / 130 / 1%/step]
2-472-027	Thin:SizeCorrection:FC	Wide Roller:PaperTransfer:Low:1Side:S2	ENG	[100 to 995 / 106 / 1%/step]
2-472-028	Thin:SizeCorrection:FC	Wide Roller:PaperTransfer:Low:2Side:S2	ENG	[100 to 995 / 130 / 1%/step]
2-472-	Thin:SizeCorrection:FC	Wide Roller:PaperTransfer:Standard:1Side:S3	ENG	[100 to 995 / 117 / 1%/step]

3.SP Mode Tables

SP No.	Large Category	Small Category	ENG or CTL	[Min to Max/Init./Step]
029				
2-472-030	Thin:SizeCorrection:FC	Wide Roller:PaperTransfer:Standard:2Sid:S3	ENG	[100 to 995 / 153 / 1%/step]
2-472-031	Thin:SizeCorrection:FC	Wide Roller:PaperTransfer:Low:1Side:S3	ENG	[100 to 995 / 117 / 1%/step]
2-472-032	Thin:SizeCorrection:FC	Wide Roller:PaperTransfer:Low:2Side:S3	ENG	[100 to 995 / 153 / 1%/step]
2-472-033	Thin:SizeCorrection:FC	Wide Roller:PaperTransfer:Standard:1Sid:S4	ENG	[100 to 995 / 128 / 1%/step]
2-472-034	Thin:SizeCorrection:FC	Wide Roller:PaperTransfer:Standard:2Sid:S4	ENG	[100 to 995 / 177 / 1%/step]
2-472-035	Thin:SizeCorrection:FC	Wide Roller:PaperTransfer:Low:1Side:S4	ENG	[100 to 995 / 128 / 1%/step]
2-472-036	Thin:SizeCorrection:FC	Wide Roller:PaperTransfer:Low:2Side:S4	ENG	[100 to 995 / 177 / 1%/step]
2-472-037	Thin:SizeCorrection:FC	Wide Roller:PaperTransfer:Standard:1Sid:S5	ENG	[100 to 995 / 140 / 1%/step]
2-472-	Thin:SizeCorrection:FC	Wide Roller:PaperTransfer:Standard:2Sid:S5	ENG	[100 to 995 / 200 / 1%/step]

3.SP Mode Tables

SP No.	Large Category	Small Category	ENG or CTL	[Min to Max/Init./Step]
038				
2-472-039	Thin:SizeCorrection:FC	Wide Roller:PaperTransfer:Low:1Side:S5	ENG	[100 to 995 / 140 / 1%/step]
2-472-040	Thin:SizeCorrection:FC	Wide Roller:PaperTransfer:Low:2Side:S5	ENG	[100 to 995 / 200 / 1%/step]
2-473-001	Thin:Size-Env.Correct:BW	PaperTransfer:Standard:1Sid:S1	ENG	[1 to 110 / 10 / 1/step]
2-473-002	Thin:Size-Env.Correct:BW	PaperTransfer:Standard:1Sid:S1	ENG	[1 to 110 / 15 / 1/step]
2-473-003	Thin:Size-Env.Correct:BW	PaperTransfer:Low:1Side:S1	ENG	[1 to 110 / 10 / 1/step]
2-473-004	Thin:Size-Env.Correct:BW	PaperTransfer:Low:1Side:S1	ENG	[1 to 110 / 15 / 1/step]
2-473-005	Thin:Size-Env.Correct:BW	PaperTransfer:Standard:1Sid:S2	ENG	[1 to 110 / 11 / 1/step]
2-473-006	Thin:Size-Env.Correct:BW	PaperTransfer:Standard:1Sid:S2	ENG	[1 to 110 / 16 / 1/step]
2-473-	Thin:Size-Env.Correct:BW	PaperTransfer:Low:1Side:S2	ENG	[1 to 110 / 11 / 1/step]

3.SP Mode Tables

SP No.	Large Category	Small Category	ENG or CTL	[Min to Max/Init./Step]
007				
2-473-008	Thin:Size-Env.Correct:BW	PaperTransfer:Low:1Side:S2	ENG	[1 to 110 / 16 / 1/step]
2-473-009	Thin:Size-Env.Correct:BW	PaperTransfer:Standard:1Sid:S3	ENG	[1 to 110 / 12 / 1/step]
2-473-010	Thin:Size-Env.Correct:BW	PaperTransfer:Standard:1Sid:S3	ENG	[1 to 110 / 30 / 1/step]
2-473-011	Thin:Size-Env.Correct:BW	PaperTransfer:Low:1Side:S3	ENG	[1 to 110 / 12 / 1/step]
2-473-012	Thin:Size-Env.Correct:BW	PaperTransfer:Low:1Side:S3	ENG	[1 to 110 / 30 / 1/step]
2-473-013	Thin:Size-Env.Correct:BW	PaperTransfer:Standard:1Sid:S4	ENG	[1 to 110 / 13 / 1/step]
2-473-014	Thin:Size-Env.Correct:BW	PaperTransfer:Standard:1Sid:S4	ENG	[1 to 110 / 31 / 1/step]
2-473-015	Thin:Size-Env.Correct:BW	PaperTransfer:Low:1Side:S4	ENG	[1 to 110 / 13 / 1/step]
2-473-	Thin:Size-Env.Correct:BW	PaperTransfer:Low:1Side:S4	ENG	[1 to 110 / 31 / 1/step]

3.SP Mode Tables

SP No.	Large Category	Small Category	ENG or CTL	[Min to Max/Init./Step]
016				
2-473-017	Thin:Size-Env.Correct:BW	PaperTransfer:Standard:1Sid:S5	ENG	[1 to 110 / 14 / 1/step]
2-473-018	Thin:Size-Env.Correct:BW	PaperTransfer:Standard:2Sid:S5	ENG	[1 to 110 / 32 / 1/step]
2-473-019	Thin:Size-Env.Correct:BW	PaperTransfer:Low:1Side:S5	ENG	[1 to 110 / 14 / 1/step]
2-473-020	Thin:Size-Env.Correct:BW	PaperTransfer:Low:2Side:S5	ENG	[1 to 110 / 32 / 1/step]
2-473-021	Thin:Size-Env.Correct:BW	Wide Roller:PaperTransfer:Standard:1Sid:S1	ENG	[1 to 110 / 10 / 1/step]
2-473-022	Thin:Size-Env.Correct:BW	Wide Roller:PaperTransfer:Standard:2Sid:S1	ENG	[1 to 110 / 15 / 1/step]
2-473-023	Thin:Size-Env.Correct:BW	Wide Roller:PaperTransfer:Low:1Side:S1	ENG	[1 to 110 / 10 / 1/step]
2-473-024	Thin:Size-Env.Correct:BW	Wide Roller:PaperTransfer:Low:2Side:S1	ENG	[1 to 110 / 15 / 1/step]
2-473-	Thin:Size-Env.Correct:BW	Wide Roller:PaperTransfer:Standard:1Sid:S2	ENG	[1 to 110 / 11 / 1/step]

3.SP Mode Tables

SP No.	Large Category	Small Category	ENG or CTL	[Min to Max/Init./Step]
025				
2-473-026	Thin:Size-Env.Correct:BW	Wide Roller:PaperTransfer:Standard:2Sid:S2	ENG	[1 to 110 / 16 / 1/step]
2-473-027	Thin:Size-Env.Correct:BW	Wide Roller:PaperTransfer:Low:1Side:S2	ENG	[1 to 110 / 11 / 1/step]
2-473-028	Thin:Size-Env.Correct:BW	Wide Roller:PaperTransfer:Low:2Side:S2	ENG	[1 to 110 / 16 / 1/step]
2-473-029	Thin:Size-Env.Correct:BW	Wide Roller:PaperTransfer:Standard:1Sid:S3	ENG	[1 to 110 / 12 / 1/step]
2-473-030	Thin:Size-Env.Correct:BW	Wide Roller:PaperTransfer:Standard:2Sid:S3	ENG	[1 to 110 / 30 / 1/step]
2-473-031	Thin:Size-Env.Correct:BW	Wide Roller:PaperTransfer:Low:1Side:S3	ENG	[1 to 110 / 12 / 1/step]
2-473-032	Thin:Size-Env.Correct:BW	Wide Roller:PaperTransfer:Low:2Side:S3	ENG	[1 to 110 / 30 / 1/step]
2-473-033	Thin:Size-Env.Correct:BW	Wide Roller:PaperTransfer:Standard:1Sid:S4	ENG	[1 to 110 / 13 / 1/step]
2-473-	Thin:Size-Env.Correct:BW	Wide Roller:PaperTransfer:Standard:2Sid:S4	ENG	[1 to 110 / 31 / 1/step]

3.SP Mode Tables

SP No.	Large Category	Small Category	ENG or CTL	[Min to Max/Init./Step]
034				
2-473-035	Thin:Size-Env.Correct:BW	Wide Roller:PaperTransfer:Low:1Side:S4	ENG	[1 to 110 / 13 / 1/step]
2-473-036	Thin:Size-Env.Correct:BW	Wide Roller:PaperTransfer:Low:2Side:S4	ENG	[1 to 110 / 31 / 1/step]
2-473-037	Thin:Size-Env.Correct:BW	Wide Roller:PaperTransfer:Standard:1Side:S5	ENG	[1 to 110 / 14 / 1/step]
2-473-038	Thin:Size-Env.Correct:BW	Wide Roller:PaperTransfer:Standard:2Side:S5	ENG	[1 to 110 / 32 / 1/step]
2-473-039	Thin:Size-Env.Correct:BW	Wide Roller:PaperTransfer:Low:1Side:S5	ENG	[1 to 110 / 14 / 1/step]
2-473-040	Thin:Size-Env.Correct:BW	Wide Roller:PaperTransfer:Low:2Side:S5	ENG	[1 to 110 / 32 / 1/step]
2-474-001	Thin:Size-Env.Correct:FC	PaperTransfer:Standard:1Side:S1	ENG	[1 to 110 / 20 / 1/step]
2-474-002	Thin:Size-Env.Correct:FC	PaperTransfer:Standard:1Side:S1	ENG	[1 to 110 / 25 / 1/step]
2-474-	Thin:Size-Env.Correct:FC	PaperTransfer:Low:1Side:S1	ENG	[1 to 110 / 20 / 1/step]

3.SP Mode Tables

SP No.	Large Category	Small Category	ENG or CTL	[Min to Max/Init./Step]
003				
2-474-004	Thin:Size-Env.Correct:FC	PaperTransfer:Low:1Side:S1	ENG	[1 to 110 / 25 / 1/step]
2-474-005	Thin:Size-Env.Correct:FC	PaperTransfer:Standard:1Sid:S2	ENG	[1 to 110 / 21 / 1/step]
2-474-006	Thin:Size-Env.Correct:FC	PaperTransfer:Standard:1Sid:S2	ENG	[1 to 110 / 35 / 1/step]
2-474-007	Thin:Size-Env.Correct:FC	PaperTransfer:Low:1Side:S2	ENG	[1 to 110 / 21 / 1/step]
2-474-008	Thin:Size-Env.Correct:FC	PaperTransfer:Low:1Side:S2	ENG	[1 to 110 / 35 / 1/step]
2-474-009	Thin:Size-Env.Correct:FC	PaperTransfer:Standard:1Sid:S3	ENG	[1 to 110 / 33 / 1/step]
2-474-010	Thin:Size-Env.Correct:FC	PaperTransfer:Standard:1Sid:S3	ENG	[1 to 110 / 36 / 1/step]
2-474-011	Thin:Size-Env.Correct:FC	PaperTransfer:Low:1Side:S3	ENG	[1 to 110 / 33 / 1/step]
2-474-	Thin:Size-Env.Correct:FC	PaperTransfer:Low:1Side:S3	ENG	[1 to 110 / 36 / 1/step]

3.SP Mode Tables

SP No.	Large Category	Small Category	ENG or CTL	[Min to Max/Init./Step]
012				
2-474-013	Thin:Size-Env.Correct:FC	PaperTransfer:Standard:1Sid:S4	ENG	[1 to 110 / 34 / 1/step]
2-474-014	Thin:Size-Env.Correct:FC	PaperTransfer:Standard:1Sid:S4	ENG	[1 to 110 / 37 / 1/step]
2-474-015	Thin:Size-Env.Correct:FC	PaperTransfer:Low:1Side:S4	ENG	[1 to 110 / 34 / 1/step]
2-474-016	Thin:Size-Env.Correct:FC	PaperTransfer:Low:1Side:S4	ENG	[1 to 110 / 37 / 1/step]
2-474-017	Thin:Size-Env.Correct:FC	PaperTransfer:Standard:1Sid:S5	ENG	[1 to 110 / 24 / 1/step]
2-474-018	Thin:Size-Env.Correct:FC	PaperTransfer:Standard:2Sid:S5	ENG	[1 to 110 / 38 / 1/step]
2-474-019	Thin:Size-Env.Correct:FC	PaperTransfer:Low:1Side:S5	ENG	[1 to 110 / 24 / 1/step]
2-474-020	Thin:Size-Env.Correct:FC	PaperTransfer:Low:2Side:S5	ENG	[1 to 110 / 38 / 1/step]
2-474-	Thin:Size-Env.Correct:FC	Wide Roller:PaperTransfer:Standard:1Sid:S1	ENG	[1 to 110 / 20 / 1/step]

3.SP Mode Tables

SP No.	Large Category	Small Category	ENG or CTL	[Min to Max/Init./Step]
021				
2-474-022	Thin:Size-Env.Correct:FC	Wide Roller:PaperTransfer:Standard:2Side:S1	ENG	[1 to 110 / 25 / 1/step]
2-474-023	Thin:Size-Env.Correct:FC	Wide Roller:PaperTransfer:Low:1Side:S1	ENG	[1 to 110 / 20 / 1/step]
2-474-024	Thin:Size-Env.Correct:FC	Wide Roller:PaperTransfer:Low:2Side:S1	ENG	[1 to 110 / 25 / 1/step]
2-474-025	Thin:Size-Env.Correct:FC	Wide Roller:PaperTransfer:Standard:1Side:S2	ENG	[1 to 110 / 21 / 1/step]
2-474-026	Thin:Size-Env.Correct:FC	Wide Roller:PaperTransfer:Standard:2Side:S2	ENG	[1 to 110 / 35 / 1/step]
2-474-027	Thin:Size-Env.Correct:FC	Wide Roller:PaperTransfer:Low:1Side:S2	ENG	[1 to 110 / 21 / 1/step]
2-474-028	Thin:Size-Env.Correct:FC	Wide Roller:PaperTransfer:Low:2Side:S2	ENG	[1 to 110 / 35 / 1/step]
2-474-029	Thin:Size-Env.Correct:FC	Wide Roller:PaperTransfer:Standard:1Side:S3	ENG	[1 to 110 / 33 / 1/step]
2-474-	Thin:Size-Env.Correct:FC	Wide Roller:PaperTransfer:Standard:2Side:S3	ENG	[1 to 110 / 36 / 1/step]

3.SP Mode Tables

SP No.	Large Category	Small Category	ENG or CTL	[Min to Max/Init./Step]
030				
2-474-031	Thin:Size-Env.Correct:FC	Wide Roller:PaperTransfer:Low:1Side:S3	ENG	[1 to 110 / 33 / 1/step]
2-474-032	Thin:Size-Env.Correct:FC	Wide Roller:PaperTransfer:Low:2Side:S3	ENG	[1 to 110 / 36 / 1/step]
2-474-033	Thin:Size-Env.Correct:FC	Wide Roller:PaperTransfer:Standard:1Side:S4	ENG	[1 to 110 / 34 / 1/step]
2-474-034	Thin:Size-Env.Correct:FC	Wide Roller:PaperTransfer:Standard:2Side:S4	ENG	[1 to 110 / 37 / 1/step]
2-474-035	Thin:Size-Env.Correct:FC	Wide Roller:PaperTransfer:Low:1Side:S4	ENG	[1 to 110 / 34 / 1/step]
2-474-036	Thin:Size-Env.Correct:FC	Wide Roller:PaperTransfer:Low:2Side:S4	ENG	[1 to 110 / 37 / 1/step]
2-474-037	Thin:Size-Env.Correct:FC	Wide Roller:PaperTransfer:Standard:1Side:S5	ENG	[1 to 110 / 24 / 1/step]
2-474-038	Thin:Size-Env.Correct:FC	Wide Roller:PaperTransfer:Standard:2Side:S5	ENG	[1 to 110 / 38 / 1/step]
2-474-	Thin:Size-Env.Correct:FC	Wide Roller:PaperTransfer:Low:1Side:S5	ENG	[1 to 110 / 24 / 1/step]

3.SP Mode Tables

SP No.	Large Category	Small Category	ENG or CTL	[Min to Max/Init./Step]
039				
2-474-040	Thin:Size-Env.Correct:FC	Wide Roller:PaperTransfer:Low:2Side:S5	ENG	[1 to 110 / 38 / 1/step]
2-475-001	Thin:LeadingEdgeCorrection	PaperTransfer:Standard:1Side	ENG	[0 to 995 / 100 / 5%/step]
2-475-002	Thin:LeadingEdgeCorrection	PaperTransfer:Standard:2Side	ENG	[0 to 995 / 100 / 5%/step]
2-475-003	Thin:LeadingEdgeCorrection	Paper Transfer:Low:1side	ENG	[0 to 995 / 100 / 5%/step]
2-475-004	Thin:LeadingEdgeCorrection	Paper Transfer:Low:2side	ENG	[0 to 995 / 100 / 5%/step]
2-476-001	Thin:SwitchTimingLeadEdge	PaperTransfer:Standard:1side	ENG	[0 to 50 / 0 / 2mm/step]
2-476-002	Thin:SwitchTimingLeadEdge	PaperTransfer:Standard:2side	ENG	[0 to 50 / 0 / 2mm/step]
2-476-003	Thin:SwitchTimingLeadEdge	Paper Transfer:Low:1side	ENG	[0 to 50 / 0 / 2mm/step]
2-476-	Thin:SwitchTimingLeadEdge	Paper Transfer:Low:2side	ENG	[0 to 50 / 0 / 2mm/step]

3.SP Mode Tables

SP No.	Large Category	Small Category	ENG or CTL	[Min to Max/Init./Step]
004				
2-477-001	Thin:TrailEdgeCorrection	PaperTransfer:Standard:1Side	ENG	[0 to 995 / 100 / 5%/step]
2-477-002	Thin:TrailEdgeCorrection	PaperTransfer:Standard:2Side	ENG	[0 to 995 / 100 / 5%/step]
2-477-003	Thin:TrailEdgeCorrection	Paper Transfer:Low:1side	ENG	[0 to 995 / 100 / 5%/step]
2-477-004	Thin:TrailEdgeCorrection	Paper Transfer:Low:2side	ENG	[0 to 995 / 100 / 5%/step]
2-478-001	Thin:SwitchTimingTrailEdge	PaperTransfer:Standard:1side	ENG	[0 to 50 / 0 / 2mm/step]
2-478-002	Thin:SwitchTimingTrailEdge	PaperTransfer:Standard:2side	ENG	[0 to 50 / 0 / 2mm/step]
2-478-003	Thin:SwitchTimingTrailEdge	Paper Transfer:Low:1side	ENG	[0 to 50 / 0 / 2mm/step]
2-478-004	Thin:SwitchTimingTrailEdge	Paper Transfer:Low:2side	ENG	[0 to 50 / 0 / 2mm/step]

3.SP Mode Tables

SP2-XXX (Drum) - 3

SP No.	Large Category	Small Category	EN G or CTL	[Min to Max/Init./Step]
2-483-001	Thick1:Bias:BW	PaperTransfer:middle:1side	EN G	IM C3500: [0 to 200 / 16 / 1-uA/step] IM C2500: [0 to 200 / 16 / 1-uA/step] IM C2000: [0 to 200 / 16 / 1-uA/step] IM C3000: [0 to 200 / 16 / 1-uA/step]
2-483-002	Thick1:Bias:BW	PaperTransfer:middle:2side	EN G	IM C3500: [0 to 200 / 13 / 1-uA/step] IM C2500: [0 to 200 / 13 / 1-uA/step] IM C2000: [0 to 200 / 13 / 1-uA/step] IM C3000: [0 to 200 / 13 / 1-uA/step]
2-483-003	Thick1:Bias:BW	PaperTransfer:low:1side	EN G	IM C3500: [0 to 200 / 11 / 1-uA/step] IM C2500: [0 to 200 / 11 / 1-uA/step] IM C2000: [0 to 200 / 11 / 1-uA/step] IM C3000: [0 to 200 / 11 / 1-uA/step]

3.SP Mode Tables

SP No.	Large Category	Small Category	EN G or CTL	[Min to Max/Init./Step]
				/ 1-uA/step]
2-483-004	Thick1:Bias:BW	PaperTransfer:low:2side	EN G	IM C3500: [0 to 200 / 9 / 1-uA/step] IM C2500: [0 to 200 / 9 / 1-uA/step] IM C2000: [0 to 200 / 9 / 1-uA/step] IM C3000: [0 to 200 / 9 / 1-uA/step]
2-487-001	Thick1:Bias:FC	PaperTransfer:middle:1side	EN G	IM C3500: [0 to 200 / 23 / 1-uA/step] IM C2500: [0 to 200 / 23 / 1-uA/step] IM C2000: [0 to 200 / 23 / 1-uA/step] IM C3000: [0 to 200 / 23 / 1-uA/step]
2-487-002	Thick1:Bias:FC	PaperTransfer:middle:2side	EN G	IM C3500: [0 to 200 / 26 / 1-uA/step] IM C2500: [0 to 200 / 26 / 1-uA/step] IM C2000: [0 to 200 / 26 / 1-uA/step] IM C3000: [0 to 200 / 26

3.SP Mode Tables

SP No.	Large Category	Small Category	EN G or CTL	[Min to Max/Init./Step]
				/ 1-uA/step]
2-487-003	Thick1:Bias:FC	PaperTransfer:low:1side	EN G	IM C3500: [0 to 200 / 16 / 1-uA/step] IM C2500: [0 to 200 / 16 / 1-uA/step] IM C2000: [0 to 200 / 16 / 1-uA/step] IM C3000: [0 to 200 / 16 / 1-uA/step]
2-487-004	Thick1:Bias:FC	PaperTransfer:low:2side	EN G	IM C3500: [0 to 200 / 18 / 1-uA/step] IM C2500: [0 to 200 / 18 / 1-uA/step] IM C2000: [0 to 200 / 18 / 1-uA/step] IM C3000: [0 to 200 / 18 / 1-uA/step]
2-491-001	Thick1:SizeCorrection:BW	PaperTransfer:middle:1Sid:S1	EN G	[100 to 995 / 100 / 1%/step]
2-491-002	Thick1:SizeCorrection:BW	PaperTransfer:middle:1Sid:S1	EN G	[100 to 995 / 100 / 1%/step]
2-491-	Thick1:SizeCorrection:BW	PaperTransfer:Low:1Side:S1	EN G	[100 to 995 / 100 / 1%/step]

3.SP Mode Tables

SP No.	Large Category	Small Category	EN G or CTL	[Min to Max/Init./Step]
003				
2-491-004	Thick1:SizeCorrection:BW	PaperTransfer:Low:1Side:S1	EN G	[100 to 995 / 100 / 1%/step]
2-491-005	Thick1:SizeCorrection:BW	PaperTransfer:middle:1Sid:S2	EN G	[100 to 995 / 100 / 1%/step]
2-491-006	Thick1:SizeCorrection:BW	PaperTransfer:middle:1Sid:S2	EN G	[100 to 995 / 177 / 1%/step]
2-491-007	Thick1:SizeCorrection:BW	PaperTransfer:Low:1Side:S2	EN G	[100 to 995 / 100 / 1%/step]
2-491-008	Thick1:SizeCorrection:BW	PaperTransfer:Low:1Side:S2	EN G	[100 to 995 / 177 / 1%/step]
2-491-009	Thick1:SizeCorrection:BW	PaperTransfer:middle:1Sid:S3	EN G	[100 to 995 / 100 / 1%/step]
2-491-010	Thick1:SizeCorrection:BW	PaperTransfer:middle:1Sid:S3	EN G	[100 to 995 / 231 / 1%/step]
2-491-011	Thick1:SizeCorrection:BW	PaperTransfer:Low:1Side:S3	EN G	[100 to 995 / 100 / 1%/step]
2-491-	Thick1:SizeCorrection:BW	PaperTransfer:Low:1Side:S3	EN G	[100 to 995 / 231 / 1%/step]

3.SP Mode Tables

SP No.	Large Category	Small Category	EN G or CTL	[Min to Max/Init./Step]
012				
2-491-013	Thick1:SizeCorrection:BW	PaperTransfer:middle:1Sid:S4	EN G	[100 to 995 / 100 / 1%/step]
2-491-014	Thick1:SizeCorrection:BW	PaperTransfer:middle:1Sid:S4	EN G	[100 to 995 / 270 / 1%/step]
2-491-015	Thick1:SizeCorrection:BW	PaperTransfer:Low:1Side:S4	EN G	[100 to 995 / 100 / 1%/step]
2-491-016	Thick1:SizeCorrection:BW	PaperTransfer:Low:1Side:S4	EN G	[100 to 995 / 270 / 1%/step]
2-491-017	Thick1:SizeCorrection:BW	PaperTransfer:middle:1Sid:S5	EN G	[100 to 995 / 100 / 1%/step]
2-491-018	Thick1:SizeCorrection:BW	PaperTransfer:middle:2Sid:S5	EN G	[100 to 995 / 308 / 1%/step]
2-491-019	Thick1:SizeCorrection:BW	PaperTransfer:Low:1Side:S5	EN G	[100 to 995 / 100 / 1%/step]
2-491-020	Thick1:SizeCorrection:BW	PaperTransfer:Low:2Side:S5	EN G	[100 to 995 / 308 / 1%/step]
2-491-	Thick1:SizeCorrection:BW	Wide Roller:PaperTransfer:middle:1Sid:S1	EN G	[100 to 995 / 100 / 1%/step]

3.SP Mode Tables

SP No.	Large Category	Small Category	EN G or CTL	[Min to Max/Init./Step]
021				
2-491-022	Thick1:SizeCorrection:BW	Wide Roller:PaperTransfer:middle:2Sid:S1	EN G	[100 to 995 / 100 / 1%/step]
2-491-023	Thick1:SizeCorrection:BW	Wide Roller:PaperTransfer:Low:1Side:S1	EN G	[100 to 995 / 100 / 1%/step]
2-491-024	Thick1:SizeCorrection:BW	Wide Roller:PaperTransfer:Low:2Side:S1	EN G	[100 to 995 / 100 / 1%/step]
2-491-025	Thick1:SizeCorrection:BW	Wide Roller:PaperTransfer:middle:1Sid:S2	EN G	[100 to 995 / 100 / 1%/step]
2-491-026	Thick1:SizeCorrection:BW	Wide Roller:PaperTransfer:middle:2Sid:S2	EN G	[100 to 995 / 177 / 1%/step]
2-491-027	Thick1:SizeCorrection:BW	Wide Roller:PaperTransfer:Low:1Side:S2	EN G	[100 to 995 / 100 / 1%/step]
2-491-028	Thick1:SizeCorrection:BW	Wide Roller:PaperTransfer:Low:2Side:S2	EN G	[100 to 995 / 177 / 1%/step]
2-491-029	Thick1:SizeCorrection:BW	Wide Roller:PaperTransfer:middle:1Sid:S3	EN G	[100 to 995 / 100 / 1%/step]
2-491-	Thick1:SizeCorrection:BW	Wide Roller:PaperTransfer:middle:2Sid:S3	EN G	[100 to 995 / 231 / 1%/step]

3.SP Mode Tables

SP No.	Large Category	Small Category	EN G or CTL	[Min to Max/Init./Step]
030				
2-491-031	Thick1:SizeCorrection:BW	Wide Roller:PaperTransfer:Low:1Side:S3	EN G	[100 to 995 / 100 / 1%/step]
2-491-032	Thick1:SizeCorrection:BW	Wide Roller:PaperTransfer:Low:2Side:S3	EN G	[100 to 995 / 231 / 1%/step]
2-491-033	Thick1:SizeCorrection:BW	Wide Roller:PaperTransfer:middle:1Sid:S4	EN G	[100 to 995 / 100 / 1%/step]
2-491-034	Thick1:SizeCorrection:BW	Wide Roller:PaperTransfer:middle:2Sid:S4	EN G	[100 to 995 / 270 / 1%/step]
2-491-035	Thick1:SizeCorrection:BW	Wide Roller:PaperTransfer:Low:1Side:S4	EN G	[100 to 995 / 100 / 1%/step]
2-491-036	Thick1:SizeCorrection:BW	Wide Roller:PaperTransfer:Low:2Side:S4	EN G	[100 to 995 / 270 / 1%/step]
2-491-037	Thick1:SizeCorrection:BW	Wide Roller:PaperTransfer:middle:1Sid:S5	EN G	[100 to 995 / 100 / 1%/step]
2-491-038	Thick1:SizeCorrection:BW	Wide Roller:PaperTransfer:middle:2Sid:S5	EN G	[100 to 995 / 308 / 1%/step]
2-491-	Thick1:SizeCorrection:BW	Wide Roller:PaperTransfer:Low:1Side:S5	EN G	[100 to 995 / 100 / 1%/step]

3.SP Mode Tables

SP No.	Large Category	Small Category	EN G or CTL	[Min to Max/Init./Step]
039				
2-491-040	Thick1:SizeCorrection:BW	Wide Roller:PaperTransfer:Low:2Side:S5	EN G	[100 to 995 / 308 / 1%/step]
2-492-001	Thick1:SizeCorrection:FC	PaperTransfer:middle:1Sid:S1	EN G	[100 to 995 / 100 / 1%/step]
2-492-002	Thick1:SizeCorrection:FC	PaperTransfer:middle:1Sid:S1	EN G	[100 to 995 / 100 / 1%/step]
2-492-003	Thick1:SizeCorrection:FC	PaperTransfer:Low:1Side:S1	EN G	[100 to 995 / 100 / 1%/step]
2-492-004	Thick1:SizeCorrection:FC	PaperTransfer:Low:1Side:S1	EN G	[100 to 995 / 100 / 1%/step]
2-492-005	Thick1:SizeCorrection:FC	PaperTransfer:middle:1Sid:S2	EN G	[100 to 995 / 100 / 1%/step]
2-492-006	Thick1:SizeCorrection:FC	PaperTransfer:middle:1Sid:S2	EN G	[100 to 995 / 173 / 1%/step]
2-492-007	Thick1:SizeCorrection:FC	PaperTransfer:Low:1Side:S2	EN G	[100 to 995 / 100 / 1%/step]
2-492-	Thick1:SizeCorrection:FC	PaperTransfer:Low:1Side:S2	EN G	[100 to 995 / 173 / 1%/step]

3.SP Mode Tables

SP No.	Large Category	Small Category	EN G or CTL	[Min to Max/Init./Step]
008				
2-492-009	Thick1:SizeCorrection:FC	PaperTransfer:middle:1Sid:S3	EN G	[100 to 995 / 100 / 1%/step]
2-492-010	Thick1:SizeCorrection:FC	PaperTransfer:middle:1Sid:S3	EN G	[100 to 995 / 250 / 1%/step]
2-492-011	Thick1:SizeCorrection:FC	PaperTransfer:Low:1Side:S3	EN G	[100 to 995 / 100 / 1%/step]
2-492-012	Thick1:SizeCorrection:FC	PaperTransfer:Low:1Side:S3	EN G	[100 to 995 / 250 / 1%/step]
2-492-013	Thick1:SizeCorrection:FC	PaperTransfer:middle:1Sid:S4	EN G	[100 to 995 / 100 / 1%/step]
2-492-014	Thick1:SizeCorrection:FC	PaperTransfer:middle:1Sid:S4	EN G	[100 to 995 / 308 / 1%/step]
2-492-015	Thick1:SizeCorrection:FC	PaperTransfer:Low:1Side:S4	EN G	[100 to 995 / 100 / 1%/step]
2-492-016	Thick1:SizeCorrection:FC	PaperTransfer:Low:1Side:S4	EN G	[100 to 995 / 308 / 1%/step]
2-492-	Thick1:SizeCorrection:FC	PaperTransfer:middle:1Sid:S5	EN G	[100 to 995 / 100 / 1%/step]

3.SP Mode Tables

SP No.	Large Category	Small Category	EN G or CTL	[Min to Max/Init./Step]
017				
2-492-018	Thick1:SizeCorrection:FC	PaperTransfer:middle:2Sid:S5	EN G	[100 to 995 / 385 / 1%/step]
2-492-019	Thick1:SizeCorrection:FC	PaperTransfer:Low:1Side:S5	EN G	[100 to 995 / 100 / 1%/step]
2-492-020	Thick1:SizeCorrection:FC	PaperTransfer:Low:2Side:S5	EN G	[100 to 995 / 385 / 1%/step]
2-492-021	Thick1:SizeCorrection:FC	Wide Roller:PaperTransfer:middle:1Sid:S1	EN G	[100 to 995 / 100 / 1%/step]
2-492-022	Thick1:SizeCorrection:FC	Wide Roller:PaperTransfer:middle:2Sid:S1	EN G	[100 to 995 / 100 / 1%/step]
2-492-023	Thick1:SizeCorrection:FC	Wide Roller:PaperTransfer:Low:1Side:S1	EN G	[100 to 995 / 100 / 1%/step]
2-492-024	Thick1:SizeCorrection:FC	Wide Roller:PaperTransfer:Low:2Side:S1	EN G	[100 to 995 / 100 / 1%/step]
2-492-025	Thick1:SizeCorrection:FC	Wide Roller:PaperTransfer:middle:1Sid:S2	EN G	[100 to 995 / 100 / 1%/step]
2-492-	Thick1:SizeCorrection:FC	Wide Roller:PaperTransfer:middle:2Sid:S2	EN G	[100 to 995 / 173 / 1%/step]

3.SP Mode Tables

SP No.	Large Category	Small Category	EN G or CTL	[Min to Max/Init./Step]
026				
2-492-027	Thick1:SizeCorrection:FC	Wide Roller:PaperTransfer:Low:1Side:S2	EN G	[100 to 995 / 100 / 1%/step]
2-492-028	Thick1:SizeCorrection:FC	Wide Roller:PaperTransfer:Low:2Side:S2	EN G	[100 to 995 / 173 / 1%/step]
2-492-029	Thick1:SizeCorrection:FC	Wide Roller:PaperTransfer:middle:1Sid:S3	EN G	[100 to 995 / 100 / 1%/step]
2-492-030	Thick1:SizeCorrection:FC	Wide Roller:PaperTransfer:middle:2Sid:S3	EN G	[100 to 995 / 250 / 1%/step]
2-492-031	Thick1:SizeCorrection:FC	Wide Roller:PaperTransfer:Low:1Side:S3	EN G	[100 to 995 / 100 / 1%/step]
2-492-032	Thick1:SizeCorrection:FC	Wide Roller:PaperTransfer:Low:2Side:S3	EN G	[100 to 995 / 250 / 1%/step]
2-492-033	Thick1:SizeCorrection:FC	Wide Roller:PaperTransfer:middle:1Sid:S4	EN G	[100 to 995 / 100 / 1%/step]
2-492-034	Thick1:SizeCorrection:FC	Wide Roller:PaperTransfer:middle:2Sid:S4	EN G	[100 to 995 / 308 / 1%/step]
2-492-	Thick1:SizeCorrection:FC	Wide Roller:PaperTransfer:Low:1Side:S4	EN G	[100 to 995 / 100 / 1%/step]

3.SP Mode Tables

SP No.	Large Category	Small Category	EN G or CTL	[Min to Max/Init./Step]
035				
2-492-036	Thick1:SizeCorrection:FC	Wide Roller:PaperTransfer:Low:2Side:S4	EN G	[100 to 995 / 308 / 1%/step]
2-492-037	Thick1:SizeCorrection:FC	Wide Roller:PaperTransfer:middle:1Sid:S5	EN G	[100 to 995 / 100 / 1%/step]
2-492-038	Thick1:SizeCorrection:FC	Wide Roller:PaperTransfer:middle:2Sid:S5	EN G	[100 to 995 / 385 / 1%/step]
2-492-039	Thick1:SizeCorrection:FC	Wide Roller:PaperTransfer:Low:1Side:S5	EN G	[100 to 995 / 100 / 1%/step]
2-492-040	Thick1:SizeCorrection:FC	Wide Roller:PaperTransfer:Low:2Side:S5	EN G	[100 to 995 / 385 / 1%/step]
2-493-001	Thick1:Size-Env.Correct:BW	PaperTransfer:middle:1Sid:S1	EN G	[1 to 110 / 54 / 1/step]
2-493-002	Thick1:Size-Env.Correct:BW	PaperTransfer:middle:1Sid:S1	EN G	[1 to 110 / 57 / 1/step]
2-493-003	Thick1:Size-Env.Correct:BW	PaperTransfer:Low:1Side:S1	EN G	[1 to 110 / 54 / 1/step]
2-493-	Thick1:Size-Env.Correct:BW	PaperTransfer:Low:1Side:S1	EN G	[1 to 110 / 57 / 1/step]

3.SP Mode Tables

SP No.	Large Category	Small Category	EN G or CTL	[Min to Max/Init./Step]
004				
2-493-005	Thick1:Size-Env.Correct:BW	PaperTransfer:middle:1Sid:S2	EN G	[1 to 110 / 55 / 1/step]
2-493-006	Thick1:Size-Env.Correct:BW	PaperTransfer:middle:1Sid:S2	EN G	[1 to 110 / 58 / 1/step]
2-493-007	Thick1:Size-Env.Correct:BW	PaperTransfer:Low:1Side:S2	EN G	[1 to 110 / 55 / 1/step]
2-493-008	Thick1:Size-Env.Correct:BW	PaperTransfer:Low:1Side:S2	EN G	[1 to 110 / 58 / 1/step]
2-493-009	Thick1:Size-Env.Correct:BW	PaperTransfer:middle:1Sid:S3	EN G	[1 to 110 / 56 / 1/step]
2-493-010	Thick1:Size-Env.Correct:BW	PaperTransfer:middle:1Sid:S3	EN G	[1 to 110 / 59 / 1/step]
2-493-011	Thick1:Size-Env.Correct:BW	PaperTransfer:Low:1Side:S3	EN G	[1 to 110 / 56 / 1/step]
2-493-012	Thick1:Size-Env.Correct:BW	PaperTransfer:Low:1Side:S3	EN G	[1 to 110 / 59 / 1/step]
2-493-	Thick1:Size-Env.Correct:BW	PaperTransfer:middle:1Sid:S4	EN G	[1 to 110 / 56 / 1/step]

3.SP Mode Tables

SP No.	Large Category	Small Category	EN G or CTL	[Min to Max/Init./Step]
013				
2-493-014	Thick1:Size-Env.Correct:BW	PaperTransfer:middle:1Sid:S4	EN G	[1 to 110 / 60 / 1/step]
2-493-015	Thick1:Size-Env.Correct:BW	PaperTransfer:Low:1Side:S4	EN G	[1 to 110 / 56 / 1/step]
2-493-016	Thick1:Size-Env.Correct:BW	PaperTransfer:Low:1Side:S4	EN G	[1 to 110 / 60 / 1/step]
2-493-017	Thick1:Size-Env.Correct:BW	PaperTransfer:middle:1Sid:S5	EN G	[1 to 110 / 56 / 1/step]
2-493-018	Thick1:Size-Env.Correct:BW	PaperTransfer:middle:2Sid:S5	EN G	[1 to 110 / 61 / 1/step]
2-493-019	Thick1:Size-Env.Correct:BW	PaperTransfer:Low:1Side:S5	EN G	[1 to 110 / 56 / 1/step]
2-493-020	Thick1:Size-Env.Correct:BW	PaperTransfer:Low:2Side:S5	EN G	[1 to 110 / 61 / 1/step]
2-493-021	Thick1:Size-Env.Correct:BW	Wide Roller:PaperTransfer:middle:1Sid:S1	EN G	[1 to 110 / 54 / 1/step]
2-493-	Thick1:Size-Env.Correct:BW	Wide Roller:PaperTransfer:middle:2Sid:S1	EN G	[1 to 110 / 57 / 1/step]

3.SP Mode Tables

SP No.	Large Category	Small Category	EN G or CTL	[Min to Max/Init./Step]
022				
2-493-023	Thick1:Size-Env.Correct:BW	Wide Roller:PaperTransfer:Low:1Side:S1	EN G	[1 to 110 / 54 / 1/step]
2-493-024	Thick1:Size-Env.Correct:BW	Wide Roller:PaperTransfer:Low:2Side:S1	EN G	[1 to 110 / 57 / 1/step]
2-493-025	Thick1:Size-Env.Correct:BW	Wide Roller:PaperTransfer:middle:1Sid:S2	EN G	[1 to 110 / 55 / 1/step]
2-493-026	Thick1:Size-Env.Correct:BW	Wide Roller:PaperTransfer:middle:2Sid:S2	EN G	[1 to 110 / 58 / 1/step]
2-493-027	Thick1:Size-Env.Correct:BW	Wide Roller:PaperTransfer:Low:1Side:S2	EN G	[1 to 110 / 55 / 1/step]
2-493-028	Thick1:Size-Env.Correct:BW	Wide Roller:PaperTransfer:Low:2Side:S2	EN G	[1 to 110 / 58 / 1/step]
2-493-029	Thick1:Size-Env.Correct:BW	Wide Roller:PaperTransfer:middle:1Sid:S3	EN G	[1 to 110 / 56 / 1/step]
2-493-030	Thick1:Size-Env.Correct:BW	Wide Roller:PaperTransfer:middle:2Sid:S3	EN G	[1 to 110 / 59 / 1/step]
2-493-	Thick1:Size-Env.Correct:BW	Wide Roller:PaperTransfer:Low:1Side:S3	EN G	[1 to 110 / 56 / 1/step]

3.SP Mode Tables

SP No.	Large Category	Small Category	EN G or CTL	[Min to Max/Init./Step]
031				
2-493-032	Thick1:Size-Env.Correct:BW	Wide Roller:PaperTransfer:Low:2Side:S3	EN G	[1 to 110 / 59 / 1/step]
2-493-033	Thick1:Size-Env.Correct:BW	Wide Roller:PaperTransfer:middle:1Sid:S4	EN G	[1 to 110 / 56 / 1/step]
2-493-034	Thick1:Size-Env.Correct:BW	Wide Roller:PaperTransfer:middle:2Sid:S4	EN G	[1 to 110 / 60 / 1/step]
2-493-035	Thick1:Size-Env.Correct:BW	Wide Roller:PaperTransfer:Low:1Side:S4	EN G	[1 to 110 / 56 / 1/step]
2-493-036	Thick1:Size-Env.Correct:BW	Wide Roller:PaperTransfer:Low:2Side:S4	EN G	[1 to 110 / 60 / 1/step]
2-493-037	Thick1:Size-Env.Correct:BW	Wide Roller:PaperTransfer:middle:1Sid:S5	EN G	[1 to 110 / 56 / 1/step]
2-493-038	Thick1:Size-Env.Correct:BW	Wide Roller:PaperTransfer:middle:2Sid:S5	EN G	[1 to 110 / 61 / 1/step]
2-493-039	Thick1:Size-Env.Correct:BW	Wide Roller:PaperTransfer:Low:1Side:S5	EN G	[1 to 110 / 56 / 1/step]
2-493-	Thick1:Size-Env.Correct:BW	Wide Roller:PaperTransfer:Low:2Side:S5	EN G	[1 to 110 / 61 / 1/step]

3.SP Mode Tables

SP No.	Large Category	Small Category	EN G or CTL	[Min to Max/Init./Step]
040				
2-494-001	Thick1:Size-Env.Correct:FC	PaperTransfer:middle:1Sid:S1	EN G	IM C3500: [1 to 110 / 13 / 1/step] IM C2500: [1 to 110 / 13 / 1/step] IM C2000: [1 to 110 / 13 / 1/step] IM C3000: [1 to 110 / 13 / 1/step]
2-494-002	Thick1:Size-Env.Correct:FC	PaperTransfer:middle:1Sid:S1	EN G	[1 to 110 / 65 / 1/step]
2-494-003	Thick1:Size-Env.Correct:FC	PaperTransfer:Low:1Side:S1	EN G	IM C3500: [1 to 110 / 13 / 1/step] IM C2500: [1 to 110 / 13 / 1/step] IM C2000: [1 to 110 / 13 / 1/step] IM C3000: [1 to 110 / 13 / 1/step]
2-494-004	Thick1:Size-Env.Correct:FC	PaperTransfer:Low:1Side:S1	EN G	[1 to 110 / 65 / 1/step]
2-494-	Thick1:Size-Env.Correct:FC	PaperTransfer:middle:1Sid:S2	EN G	[1 to 110 / 63 / 1/step]

3.SP Mode Tables

SP No.	Large Category	Small Category	EN G or CTL	[Min to Max/Init./Step]
005				
2-494-006	Thick1:Size-Env.Correct:FC	PaperTransfer:middle:1Sid:S2	EN G	[1 to 110 / 66 / 1/step]
2-494-007	Thick1:Size-Env.Correct:FC	PaperTransfer:Low:1Side:S2	EN G	[1 to 110 / 63 / 1/step]
2-494-008	Thick1:Size-Env.Correct:FC	PaperTransfer:Low:1Side:S2	EN G	[1 to 110 / 66 / 1/step]
2-494-009	Thick1:Size-Env.Correct:FC	PaperTransfer:middle:1Sid:S3	EN G	[1 to 110 / 63 / 1/step]
2-494-010	Thick1:Size-Env.Correct:FC	PaperTransfer:middle:1Sid:S3	EN G	[1 to 110 / 67 / 1/step]
2-494-011	Thick1:Size-Env.Correct:FC	PaperTransfer:Low:1Side:S3	EN G	[1 to 110 / 63 / 1/step]
2-494-012	Thick1:Size-Env.Correct:FC	PaperTransfer:Low:1Side:S3	EN G	[1 to 110 / 67 / 1/step]
2-494-013	Thick1:Size-Env.Correct:FC	PaperTransfer:middle:1Sid:S4	EN G	[1 to 110 / 64 / 1/step]
2-494-	Thick1:Size-Env.Correct:FC	PaperTransfer:middle:1Sid:S4	EN G	[1 to 110 / 68 / 1/step]

3.SP Mode Tables

SP No.	Large Category	Small Category	EN G or CTL	[Min to Max/Init./Step]
014				
2-494-015	Thick1:Size-Env.Correct:FC	PaperTransfer:Low:1Side:S4	EN G	[1 to 110 / 64 / 1/step]
2-494-016	Thick1:Size-Env.Correct:FC	PaperTransfer:Low:1Side:S4	EN G	[1 to 110 / 68 / 1/step]
2-494-017	Thick1:Size-Env.Correct:FC	PaperTransfer:middle:1Sid:S5	EN G	[1 to 110 / 64 / 1/step]
2-494-018	Thick1:Size-Env.Correct:FC	PaperTransfer:middle:2Sid:S5	EN G	[1 to 110 / 69 / 1/step]
2-494-019	Thick1:Size-Env.Correct:FC	PaperTransfer:Low:1Side:S5	EN G	[1 to 110 / 64 / 1/step]
2-494-020	Thick1:Size-Env.Correct:FC	PaperTransfer:Low:2Side:S5	EN G	[1 to 110 / 69 / 1/step]
2-494-021	Thick1:Size-Env.Correct:FC	Wide Roller:PaperTransfer:middle:1Sid:S1	EN G	IM C3500: [1 to 110 / 13 / 1/step] IM C2500: [1 to 110 / 13 / 1/step] IM C2000: [1 to 110 / 13 / 1/step] IM C3000: [1 to 110 / 13 / 1/step]

3.SP Mode Tables

SP No.	Large Category	Small Category	EN G or CTL	[Min to Max/Init./Step]
				/ 1/step]
2-494-022	Thick1:Size-Env.Correct:FC	Wide Roller:PaperTransfer:middle:2Sid:S1	EN G	[1 to 110 / 65 / 1/step]
2-494-023	Thick1:Size-Env.Correct:FC	Wide Roller:PaperTransfer:Low:1Side:S1	EN G	IM C3500: [1 to 110 / 13 / 1/step] IM C2500: [1 to 110 / 13 / 1/step] IM C2000: [1 to 110 / 13 / 1/step] IM C3000: [1 to 110 / 13 / 1/step]
2-494-024	Thick1:Size-Env.Correct:FC	Wide Roller:PaperTransfer:Low:2Side:S1	EN G	[1 to 110 / 65 / 1/step]
2-494-025	Thick1:Size-Env.Correct:FC	Wide Roller:PaperTransfer:middle:1Sid:S2	EN G	[1 to 110 / 63 / 1/step]
2-494-026	Thick1:Size-Env.Correct:FC	Wide Roller:PaperTransfer:middle:2Sid:S2	EN G	[1 to 110 / 66 / 1/step]
2-494-027	Thick1:Size-Env.Correct:FC	Wide Roller:PaperTransfer:Low:1Side:S2	EN G	[1 to 110 / 63 / 1/step]
2-494-	Thick1:Size-Env.Correct:FC	Wide Roller:PaperTransfer:Low:2Side:S2	EN G	[1 to 110 / 66 / 1/step]

3.SP Mode Tables

SP No.	Large Category	Small Category	EN G or CTL	[Min to Max/Init./Step]
028				
2-494-029	Thick1:Size-Env.Correct:FC	Wide Roller:PaperTransfer:middle:1Sid:S3	EN G	[1 to 110 / 63 / 1/step]
2-494-030	Thick1:Size-Env.Correct:FC	Wide Roller:PaperTransfer:middle:2Sid:S3	EN G	[1 to 110 / 67 / 1/step]
2-494-031	Thick1:Size-Env.Correct:FC	Wide Roller:PaperTransfer:Low:1Side:S3	EN G	[1 to 110 / 63 / 1/step]
2-494-032	Thick1:Size-Env.Correct:FC	Wide Roller:PaperTransfer:Low:2Side:S3	EN G	[1 to 110 / 67 / 1/step]
2-494-033	Thick1:Size-Env.Correct:FC	Wide Roller:PaperTransfer:middle:1Sid:S4	EN G	[1 to 110 / 64 / 1/step]
2-494-034	Thick1:Size-Env.Correct:FC	Wide Roller:PaperTransfer:middle:2Sid:S4	EN G	[1 to 110 / 68 / 1/step]
2-494-035	Thick1:Size-Env.Correct:FC	Wide Roller:PaperTransfer:Low:1Side:S4	EN G	[1 to 110 / 64 / 1/step]
2-494-036	Thick1:Size-Env.Correct:FC	Wide Roller:PaperTransfer:Low:2Side:S4	EN G	[1 to 110 / 68 / 1/step]
2-494-	Thick1:Size-Env.Correct:FC	Wide Roller:PaperTransfer:middle:1Sid:S5	EN G	[1 to 110 / 64 / 1/step]

3.SP Mode Tables

SP No.	Large Category	Small Category	EN G or CTL	[Min to Max/Init./Step]
037				
2-494-038	Thick1:Size-Env.Correct:FC	Wide Roller:PaperTransfer:middle:2Sid:S5	EN G	[1 to 110 / 69 / 1/step]
2-494-039	Thick1:Size-Env.Correct:FC	Wide Roller:PaperTransfer:Low:1Side:S5	EN G	[1 to 110 / 64 / 1/step]
2-494-040	Thick1:Size-Env.Correct:FC	Wide Roller:PaperTransfer:Low:2Side:S5	EN G	[1 to 110 / 69 / 1/step]
2-495-001	Thick1:LeadingEdgeCorrection	PaperTransfer:middle:1Side	EN G	[0 to 995 / 100 / 5%/step]
2-495-002	Thick1:LeadingEdgeCorrection	PaperTransfer:middle:2Side	EN G	[0 to 995 / 100 / 5%/step]
2-495-003	Thick1:LeadingEdgeCorrection	Paper Transfer:Low:1side	EN G	[0 to 995 / 100 / 5%/step]
2-495-004	Thick1:LeadingEdgeCorrection	Paper Transfer:Low:2side	EN G	[0 to 995 / 100 / 5%/step]
2-496-001	Thick1:SwitchTimingLeadEdge	PaperTransfer:middle:1side	EN G	[0 to 50 / 0 / 2mm/step]
2-496-	Thick1:SwitchTimingLeadEdge	PaperTransfer:middle:2side	EN G	[0 to 50 / 0 / 2mm/step]

3.SP Mode Tables

SP No.	Large Category	Small Category	EN G or CTL	[Min to Max/Init./Step]
002				
2-496-003	Thick1:SwitchTimingLeadEdge	Paper Transfer:Low:1side	EN G	[0 to 50 / 0 / 2mm/step]
2-496-004	Thick1:SwitchTimingLeadEdge	Paper Transfer:Low:2side	EN G	[0 to 50 / 0 / 2mm/step]
2-497-001	Thick1:TrailEdgeCorrection	PaperTransfer:middle:1Side	EN G	[0 to 995 / 100 / 5%/step]
2-497-002	Thick1:TrailEdgeCorrection	PaperTransfer:middle:2Side	EN G	[0 to 995 / 100 / 5%/step]
2-497-003	Thick1:TrailEdgeCorrection	Paper Transfer:Low:1side	EN G	[0 to 995 / 100 / 5%/step]
2-497-004	Thick1:TrailEdgeCorrection	Paper Transfer:Low:2side	EN G	[0 to 995 / 100 / 5%/step]
2-498-001	Thick1:SwitchTimingTrailEdge	PaperTransfer:middle:1Side	EN G	[0 to 50 / 0 / 2mm/step]
2-498-002	Thick1:SwitchTimingTrailEdge	PaperTransfer:middle:2Side	EN G	[0 to 50 / 0 / 2mm/step]
2-498-	Thick1:SwitchTimingTrailEdge	Paper Transfer:Low:1side	EN G	[0 to 50 / 0 / 2mm/step]

3.SP Mode Tables

SP No.	Large Category	Small Category	EN G or CTL	[Min to Max/Init./Step]
003				
2-498-004	Thick1:SwitchTimingTrailEdge	Paper Transfer:Low:2side	EN G	[0 to 50 / 0 / 2mm/step]
2-503-003	Thick2:Bias:BW	PaperTransfer:1side	EN G	IM C3500: [0 to 200 / 11 / 1-uA/step] IM C2500: [0 to 200 / 11 / 1-uA/step] IM C2000: [0 to 200 / 11 / 1-uA/step] IM C3000: [0 to 200 / 11 / 1-uA/step]
2-503-004	Thick2:Bias:BW	PaperTransfer:2side	EN G	IM C3500: [0 to 200 / 15 / 1-uA/step] IM C2500: [0 to 200 / 15 / 1-uA/step] IM C2000: [0 to 200 / 15 / 1-uA/step] IM C3000: [0 to 200 / 15 / 1-uA/step]
2-507-003	Thick2:Bias:FC	PaperTransfer:1side	EN G	IM C3500: [0 to 200 / 19 / 1-uA/step] IM C2500: [0 to 200 / 19 / 1-uA/step] IM C2000:

3.SP Mode Tables

SP No.	Large Category	Small Category	EN G or CTL	[Min to Max/Init./Step]
				[0 to 200 / 19 / 1-uA/step] IM C3000: [0 to 200 / 19 / 1-uA/step]
2-507-004	Thick2:Bias:FC	PaperTransfer:2side	EN G	IM C3500: [0 to 200 / 21 / 1-uA/step] IM C2500: [0 to 200 / 21 / 1-uA/step] IM C2000: [0 to 200 / 21 / 1-uA/step] IM C3000: [0 to 200 / 21 / 1-uA/step]
2-511-003	Thick2:SizeCorrection:BW	PaperTransfer:1Side:S1	EN G	[100 to 995 / 100 / 1%/step]
2-511-004	Thick2:SizeCorrection:BW	PaperTransfer:2Side:S1	EN G	[100 to 995 / 100 / 1%/step]
2-511-007	Thick2:SizeCorrection:BW	PaperTransfer:1Side:S2	EN G	[100 to 995 / 100 / 1%/step]
2-511-008	Thick2:SizeCorrection:BW	PaperTransfer:2Side:S2	EN G	[100 to 995 / 133 / 1%/step]
2-511-	Thick2:SizeCorrection:BW	PaperTransfer:1Side:S3	EN G	[100 to 995 / 100 / 1%/step]

3.SP Mode Tables

SP No.	Large Category	Small Category	EN G or CTL	[Min to Max/Init./Step]
011				
2-511-012	Thick2:SizeCorrection:BW	PaperTransfer:2Side:S3	EN G	[100 to 995 / 167 / 1%/step]
2-511-015	Thick2:SizeCorrection:BW	PaperTransfer:1Side:S4	EN G	[100 to 995 / 100 / 1%/step]
2-511-016	Thick2:SizeCorrection:BW	PaperTransfer:2Side:S4	EN G	[100 to 995 / 233 / 1%/step]
2-511-019	Thick2:SizeCorrection:BW	PaperTransfer:1Side:S5	EN G	[100 to 995 / 100 / 1%/step]
2-511-020	Thick2:SizeCorrection:BW	PaperTransfer:2Side:S5	EN G	[100 to 995 / 267 / 1%/step]
2-511-023	Thick2:SizeCorrection:BW	Wide Roller:PaperTransfer:1Side:S1	EN G	[100 to 995 / 100 / 1%/step]
2-511-024	Thick2:SizeCorrection:BW	Wide Roller:PaperTransfer:2Side:S1	EN G	[100 to 995 / 100 / 1%/step]
2-511-027	Thick2:SizeCorrection:BW	Wide Roller:PaperTransfer:1Side:S2	EN G	[100 to 995 / 100 / 1%/step]
2-511-	Thick2:SizeCorrection:BW	Wide Roller:PaperTransfer:2Side:S2	EN G	[100 to 995 / 133 / 1%/step]

3.SP Mode Tables

SP No.	Large Category	Small Category	EN G or CTL	[Min to Max/Init./Step]
028				
2-511-031	Thick2:SizeCorrection:BW	Wide Roller:PaperTransfer:1Side:S3	EN G	[100 to 995 / 100 / 1%/step]
2-511-032	Thick2:SizeCorrection:BW	Wide Roller:PaperTransfer:2Side:S3	EN G	[100 to 995 / 167 / 1%/step]
2-511-035	Thick2:SizeCorrection:BW	Wide Roller:PaperTransfer:1Side:S4	EN G	[100 to 995 / 100 / 1%/step]
2-511-036	Thick2:SizeCorrection:BW	Wide Roller:PaperTransfer:2Side:S4	EN G	[100 to 995 / 233 / 1%/step]
2-511-039	Thick2:SizeCorrection:BW	Wide Roller:PaperTransfer:1Side:S5	EN G	[100 to 995 / 100 / 1%/step]
2-511-040	Thick2:SizeCorrection:BW	Wide Roller:PaperTransfer:2Side:S5	EN G	[100 to 995 / 267 / 1%/step]
2-512-003	Thick2:SizeCorrection:FC	PaperTransfer:1Side:S1	EN G	[100 to 995 / 100 / 1%/step]
2-512-004	Thick2:SizeCorrection:FC	PaperTransfer:2Side:S1	EN G	[100 to 995 / 100 / 1%/step]
2-512-	Thick2:SizeCorrection:FC	PaperTransfer:1Side:S2	EN G	[100 to 995 / 100 / 1%/step]

3.SP Mode Tables

SP No.	Large Category	Small Category	EN G or CTL	[Min to Max/Init./Step]
007				
2-512-008	Thick2:SizeCorrection:FC	PaperTransfer:2Side:S2	EN G	[100 to 995 / 181 / 1%/step]
2-512-011	Thick2:SizeCorrection:FC	PaperTransfer:1Side:S3	EN G	[100 to 995 / 100 / 1%/step]
2-512-012	Thick2:SizeCorrection:FC	PaperTransfer:2Side:S3	EN G	[100 to 995 / 229 / 1%/step]
2-512-015	Thick2:SizeCorrection:FC	PaperTransfer:1Side:S4	EN G	[100 to 995 / 100 / 1%/step]
2-512-016	Thick2:SizeCorrection:FC	PaperTransfer:2Side:S4	EN G	[100 to 995 / 286 / 1%/step]
2-512-019	Thick2:SizeCorrection:FC	PaperTransfer:1Side:S5	EN G	[100 to 995 / 100 / 1%/step]
2-512-020	Thick2:SizeCorrection:FC	PaperTransfer:2Side:S5	EN G	[100 to 995 / 381 / 1%/step]
2-512-023	Thick2:SizeCorrection:FC	Wide Roller:PaperTransfer:1Side:S1	EN G	[100 to 995 / 100 / 1%/step]
2-512-	Thick2:SizeCorrection:FC	Wide Roller:PaperTransfer:2Side:S1	EN G	[100 to 995 / 100 / 1%/step]

3.SP Mode Tables

SP No.	Large Category	Small Category	EN G or CTL	[Min to Max/Init./Step]
024				
2-512-027	Thick2:SizeCorrection:FC	Wide Roller:PaperTransfer:1Side:S2	EN G	[100 to 995 / 100 / 1%/step]
2-512-028	Thick2:SizeCorrection:FC	Wide Roller:PaperTransfer:2Side:S2	EN G	[100 to 995 / 181 / 1%/step]
2-512-031	Thick2:SizeCorrection:FC	Wide Roller:PaperTransfer:1Side:S3	EN G	[100 to 995 / 100 / 1%/step]
2-512-032	Thick2:SizeCorrection:FC	Wide Roller:PaperTransfer:2Side:S3	EN G	[100 to 995 / 229 / 1%/step]
2-512-035	Thick2:SizeCorrection:FC	Wide Roller:PaperTransfer:1Side:S4	EN G	[100 to 995 / 100 / 1%/step]
2-512-036	Thick2:SizeCorrection:FC	Wide Roller:PaperTransfer:2Side:S4	EN G	[100 to 995 / 286 / 1%/step]
2-512-039	Thick2:SizeCorrection:FC	Wide Roller:PaperTransfer:1Side:S5	EN G	[100 to 995 / 100 / 1%/step]
2-512-040	Thick2:SizeCorrection:FC	Wide Roller:PaperTransfer:2Side:S5	EN G	[100 to 995 / 381 / 1%/step]
2-513-	Thick2:Size-Env.Correct:BW	PaperTransfer:1Side:S1	EN G	[1 to 110 / 70 / 1/step]

3.SP Mode Tables

SP No.	Large Category	Small Category	EN G or CTL	[Min to Max/Init./Step]
003				
2-513-004	Thick2:Size-Env.Correct:BW	PaperTransfer:2Side:S1	EN G	[1 to 110 / 72 / 1/step]
2-513-007	Thick2:Size-Env.Correct:BW	PaperTransfer:1Side:S2	EN G	[1 to 110 / 71 / 1/step]
2-513-008	Thick2:Size-Env.Correct:BW	PaperTransfer:2Side:S2	EN G	[1 to 110 / 73 / 1/step]
2-513-011	Thick2:Size-Env.Correct:BW	PaperTransfer:1Side:S3	EN G	[1 to 110 / 71 / 1/step]
2-513-012	Thick2:Size-Env.Correct:BW	PaperTransfer:2Side:S3	EN G	[1 to 110 / 74 / 1/step]
2-513-015	Thick2:Size-Env.Correct:BW	PaperTransfer:1Side:S4	EN G	[1 to 110 / 71 / 1/step]
2-513-016	Thick2:Size-Env.Correct:BW	PaperTransfer:2Side:S4	EN G	[1 to 110 / 75 / 1/step]
2-513-019	Thick2:Size-Env.Correct:BW	PaperTransfer:1Side:S5	EN G	[1 to 110 / 71 / 1/step]
2-513-	Thick2:Size-Env.Correct:BW	PaperTransfer:2Side:S5	EN G	[1 to 110 / 76 / 1/step]

3.SP Mode Tables

SP No.	Large Category	Small Category	EN G or CTL	[Min to Max/Init./Step]
020				
2-513-023	Thick2:Size-Env.Correct:BW	Wide Roller:PaperTransfer:1Side:S1	EN G	[1 to 110 / 70 / 1/step]
2-513-024	Thick2:Size-Env.Correct:BW	Wide Roller:PaperTransfer:2Side:S1	EN G	[1 to 110 / 72 / 1/step]
2-513-027	Thick2:Size-Env.Correct:BW	Wide Roller:PaperTransfer:1Side:S2	EN G	[1 to 110 / 71 / 1/step]
2-513-028	Thick2:Size-Env.Correct:BW	Wide Roller:PaperTransfer:2Side:S2	EN G	[1 to 110 / 73 / 1/step]
2-513-031	Thick2:Size-Env.Correct:BW	Wide Roller:PaperTransfer:1Side:S3	EN G	[1 to 110 / 71 / 1/step]
2-513-032	Thick2:Size-Env.Correct:BW	Wide Roller:PaperTransfer:2Side:S3	EN G	[1 to 110 / 74 / 1/step]
2-513-035	Thick2:Size-Env.Correct:BW	Wide Roller:PaperTransfer:1Side:S4	EN G	[1 to 110 / 71 / 1/step]
2-513-036	Thick2:Size-Env.Correct:BW	Wide Roller:PaperTransfer:2Side:S4	EN G	[1 to 110 / 75 / 1/step]
2-513-	Thick2:Size-Env.Correct:BW	Wide Roller:PaperTransfer:1Side:S5	EN G	[1 to 110 / 71 / 1/step]

3.SP Mode Tables

SP No.	Large Category	Small Category	EN G or CTL	[Min to Max/Init./Step]
039				
2-513-040	Thick2:Size-Env.Correct:BW	Wide Roller:PaperTransfer:2Side:S5	EN G	[1 to 110 / 76 / 1/step]
2-514-003	Thick2:Size-Env.Correct:FC	PaperTransfer:1Side:S1	EN G	[1 to 110 / 77 / 1/step]
2-514-004	Thick2:Size-Env.Correct:FC	PaperTransfer:2Side:S1	EN G	[1 to 110 / 80 / 1/step]
2-514-007	Thick2:Size-Env.Correct:FC	PaperTransfer:1Side:S2	EN G	[1 to 110 / 78 / 1/step]
2-514-008	Thick2:Size-Env.Correct:FC	PaperTransfer:2Side:S2	EN G	[1 to 110 / 81 / 1/step]
2-514-011	Thick2:Size-Env.Correct:FC	PaperTransfer:1Side:S3	EN G	[1 to 110 / 79 / 1/step]
2-514-012	Thick2:Size-Env.Correct:FC	PaperTransfer:2Side:S3	EN G	[1 to 110 / 82 / 1/step]
2-514-015	Thick2:Size-Env.Correct:FC	PaperTransfer:1Side:S4	EN G	[1 to 110 / 79 / 1/step]
2-514-	Thick2:Size-Env.Correct:FC	PaperTransfer:2Side:S4	EN G	[1 to 110 / 83 / 1/step]

3.SP Mode Tables

SP No.	Large Category	Small Category	EN G or CTL	[Min to Max/Init./Step]
016				
2-514-019	Thick2:Size-Env.Correct:FC	PaperTransfer:1Side:S5	EN G	[1 to 110 / 79 / 1/step]
2-514-020	Thick2:Size-Env.Correct:FC	PaperTransfer:2Side:S5	EN G	[1 to 110 / 84 / 1/step]
2-514-023	Thick2:Size-Env.Correct:FC	Wide Roller:PaperTransfer:1Side:S1	EN G	[1 to 110 / 77 / 1/step]
2-514-024	Thick2:Size-Env.Correct:FC	Wide Roller:PaperTransfer:2Side:S1	EN G	[1 to 110 / 80 / 1/step]
2-514-027	Thick2:Size-Env.Correct:FC	Wide Roller:PaperTransfer:1Side:S2	EN G	[1 to 110 / 78 / 1/step]
2-514-028	Thick2:Size-Env.Correct:FC	Wide Roller:PaperTransfer:2Side:S2	EN G	[1 to 110 / 81 / 1/step]
2-514-031	Thick2:Size-Env.Correct:FC	Wide Roller:PaperTransfer:1Side:S3	EN G	[1 to 110 / 79 / 1/step]
2-514-032	Thick2:Size-Env.Correct:FC	Wide Roller:PaperTransfer:2Side:S3	EN G	[1 to 110 / 82 / 1/step]
2-514-	Thick2:Size-Env.Correct:FC	Wide Roller:PaperTransfer:1Side:S4	EN G	[1 to 110 / 79 / 1/step]

3.SP Mode Tables

SP No.	Large Category	Small Category	EN G or CTL	[Min to Max/Init./Step]
035				
2-514-036	Thick2:Size-Env.Correct:FC	Wide Roller:PaperTransfer:2Side:S4	EN G	[1 to 110 / 83 / 1/step]
2-514-039	Thick2:Size-Env.Correct:FC	Wide Roller:PaperTransfer:1Side:S5	EN G	[1 to 110 / 79 / 1/step]
2-514-040	Thick2:Size-Env.Correct:FC	Wide Roller:PaperTransfer:2Side:S5	EN G	[1 to 110 / 84 / 1/step]
2-515-003	Thick2:LeadingEdgeCorrection	Paper Transfer:1side	EN G	[0 to 995 / 100 / 5%/step]
2-515-004	Thick2:LeadingEdgeCorrection	Paper Transfer:2side	EN G	[0 to 995 / 100 / 5%/step]
2-516-003	Thick2:SwitchTimingLeadEdge	Paper Transfer:1side	EN G	[0 to 50 / 0 / 2mm/step]
2-516-004	Thick2:SwitchTimingLeadEdge	Paper Transfer:2side	EN G	[0 to 50 / 0 / 2mm/step]
2-517-003	Thick2:TrailEdgeCorrection	Paper Transfer:1side	EN G	[0 to 995 / 100 / 5%/step]
2-517-	Thick2:TrailEdgeCorrection	Paper Transfer:2side	EN G	[0 to 995 / 100 / 5%/step]

3.SP Mode Tables

SP No.	Large Category	Small Category	EN G or CTL	[Min to Max/Init./Step]
004				
2-518-003	Thick2:SwitchTimingTrailEdge	Paper Transfer:1side	EN G	[0 to 50 / 0 / 2mm/step]
2-518-004	Thick2:SwitchTimingTrailEdge	Paper Transfer:2side	EN G	[0 to 50 / 0 / 2mm/step]
2-523-003	Thick3:Bias:BW	PaperTransfer:1side	EN G	IM C3500: [0 to 200 / 11 / 1-uA/step] IM C2500: [0 to 200 / 11 / 1-uA/step] IM C2000: [0 to 200 / 11 / 1-uA/step] IM C3000: [0 to 200 / 11 / 1-uA/step]
2-523-004	Thick3:Bias:BW	PaperTransfer:2side	EN G	IM C3500: [0 to 200 / 15 / 1-uA/step] IM C2500: [0 to 200 / 15 / 1-uA/step] IM C2000: [0 to 200 / 15 / 1-uA/step] IM C3000: [0 to 200 / 15 / 1-uA/step]
2-527-	Thick3:Bias:FC	PaperTransfer:1side	EN G	IM C3500: [0 to 200 / 19 / 1-uA/step]

3.SP Mode Tables

SP No.	Large Category	Small Category	EN G or CTL	[Min to Max/Init./Step]
003				IM C2500: [0 to 200 / 19 / 1-uA/step] IM C2000: [0 to 200 / 19 / 1-uA/step] IM C3000: [0 to 200 / 19 / 1-uA/step]
2-527-004	Thick3:Bias:FC	PaperTransfer:2side	EN G	IM C3500: [0 to 200 / 21 / 1-uA/step] IM C2500: [0 to 200 / 21 / 1-uA/step] IM C2000: [0 to 200 / 21 / 1-uA/step] IM C3000: [0 to 200 / 21 / 1-uA/step]
2-531-003	Thick3:SizeCorrection:BW	PaperTransfer:1Side:S1	EN G	[100 to 995 / 100 / 1%/step]
2-531-004	Thick3:SizeCorrection:BW	PaperTransfer:2Side:S1	EN G	[100 to 995 / 100 / 1%/step]
2-531-007	Thick3:SizeCorrection:BW	PaperTransfer:1Side:S2	EN G	[100 to 995 / 100 / 1%/step]
2-531-	Thick3:SizeCorrection:BW	PaperTransfer:2Side:S2	EN G	[100 to 995 / 133 / 1%/step]

3.SP Mode Tables

SP No.	Large Category	Small Category	EN G or CTL	[Min to Max/Init./Step]
008				
2-531-011	Thick3:SizeCorrection:BW	PaperTransfer:1Side:S3	EN G	[100 to 995 / 100 / 1%/step]
2-531-012	Thick3:SizeCorrection:BW	PaperTransfer:2Side:S3	EN G	[100 to 995 / 167 / 1%/step]
2-531-015	Thick3:SizeCorrection:BW	PaperTransfer:1Side:S4	EN G	[100 to 995 / 100 / 1%/step]
2-531-016	Thick3:SizeCorrection:BW	PaperTransfer:2Side:S4	EN G	[100 to 995 / 233 / 1%/step]
2-531-019	Thick3:SizeCorrection:BW	PaperTransfer:1Side:S5	EN G	[100 to 995 / 100 / 1%/step]
2-531-020	Thick3:SizeCorrection:BW	PaperTransfer:2Side:S5	EN G	[100 to 995 / 267 / 1%/step]
2-531-023	Thick3:SizeCorrection:BW	Wide Roller:PaperTransfer:1Side:S1	EN G	[100 to 995 / 100 / 1%/step]
2-531-024	Thick3:SizeCorrection:BW	Wide Roller:PaperTransfer:2Side:S1	EN G	[100 to 995 / 100 / 1%/step]
2-531-	Thick3:SizeCorrection:BW	Wide Roller:PaperTransfer:1Side:S2	EN G	[100 to 995 / 100 / 1%/step]

3.SP Mode Tables

SP No.	Large Category	Small Category	EN G or CTL	[Min to Max/Init./Step]
027				
2-531-028	Thick3:SizeCorrection:BW	Wide Roller:PaperTransfer:2Side:S2	EN G	[100 to 995 / 133 / 1%/step]
2-531-031	Thick3:SizeCorrection:BW	Wide Roller:PaperTransfer:1Side:S3	EN G	[100 to 995 / 100 / 1%/step]
2-531-032	Thick3:SizeCorrection:BW	Wide Roller:PaperTransfer:2Side:S3	EN G	[100 to 995 / 167 / 1%/step]
2-531-035	Thick3:SizeCorrection:BW	Wide Roller:PaperTransfer:1Side:S4	EN G	[100 to 995 / 100 / 1%/step]
2-531-036	Thick3:SizeCorrection:BW	Wide Roller:PaperTransfer:2Side:S4	EN G	[100 to 995 / 233 / 1%/step]
2-531-039	Thick3:SizeCorrection:BW	Wide Roller:PaperTransfer:1Side:S5	EN G	[100 to 995 / 100 / 1%/step]
2-531-040	Thick3:SizeCorrection:BW	Wide Roller:PaperTransfer:2Side:S5	EN G	[100 to 995 / 267 / 1%/step]
2-532-003	Thick3:SizeCorrection:FC	PaperTransfer:1Side:S1	EN G	[100 to 995 / 100 / 1%/step]
2-532-	Thick3:SizeCorrection:FC	PaperTransfer:2Side:S1	EN G	[100 to 995 / 100 / 1%/step]

3.SP Mode Tables

SP No.	Large Category	Small Category	EN G or CTL	[Min to Max/Init./Step]
004				
2-532-007	Thick3:SizeCorrection:FC	PaperTransfer:1Side:S2	EN G	[100 to 995 / 100 / 1%/step]
2-532-008	Thick3:SizeCorrection:FC	PaperTransfer:2Side:S2	EN G	[100 to 995 / 181 / 1%/step]
2-532-011	Thick3:SizeCorrection:FC	PaperTransfer:1Side:S3	EN G	[100 to 995 / 100 / 1%/step]
2-532-012	Thick3:SizeCorrection:FC	PaperTransfer:2Side:S3	EN G	[100 to 995 / 229 / 1%/step]
2-532-015	Thick3:SizeCorrection:FC	PaperTransfer:1Side:S4	EN G	[100 to 995 / 100 / 1%/step]
2-532-016	Thick3:SizeCorrection:FC	PaperTransfer:2Side:S4	EN G	[100 to 995 / 286 / 1%/step]
2-532-019	Thick3:SizeCorrection:FC	PaperTransfer:1Side:S5	EN G	[100 to 995 / 100 / 1%/step]
2-532-020	Thick3:SizeCorrection:FC	PaperTransfer:2Side:S5	EN G	[100 to 995 / 381 / 1%/step]
2-532-	Thick3:SizeCorrection:FC	Wide Roller:PaperTransfer:1Side:S1	EN G	[100 to 995 / 100 / 1%/step]

3.SP Mode Tables

SP No.	Large Category	Small Category	EN G or CTL	[Min to Max/Init./Step]
023				
2-532-024	Thick3:SizeCorrection:FC	Wide Roller:PaperTransfer:2Side:S1	EN G	[100 to 995 / 100 / 1%/step]
2-532-027	Thick3:SizeCorrection:FC	Wide Roller:PaperTransfer:1Side:S2	EN G	[100 to 995 / 100 / 1%/step]
2-532-028	Thick3:SizeCorrection:FC	Wide Roller:PaperTransfer:2Side:S2	EN G	[100 to 995 / 181 / 1%/step]
2-532-031	Thick3:SizeCorrection:FC	Wide Roller:PaperTransfer:1Side:S3	EN G	[100 to 995 / 100 / 1%/step]
2-532-032	Thick3:SizeCorrection:FC	Wide Roller:PaperTransfer:2Side:S3	EN G	[100 to 995 / 229 / 1%/step]
2-532-035	Thick3:SizeCorrection:FC	Wide Roller:PaperTransfer:1Side:S4	EN G	[100 to 995 / 100 / 1%/step]
2-532-036	Thick3:SizeCorrection:FC	Wide Roller:PaperTransfer:2Side:S4	EN G	[100 to 995 / 286 / 1%/step]
2-532-039	Thick3:SizeCorrection:FC	Wide Roller:PaperTransfer:1Side:S5	EN G	[100 to 995 / 100 / 1%/step]
2-532-	Thick3:SizeCorrection:FC	Wide Roller:PaperTransfer:2Side:S5	EN G	[100 to 995 / 381 / 1%/step]

3.SP Mode Tables

SP No.	Large Category	Small Category	EN G or CTL	[Min to Max/Init./Step]
040				
2-533-003	Thick3:Size-Env.Correct:BW	PaperTransfer:1Side:S1	EN G	[1 to 110 / 85 / 1/step]
2-533-004	Thick3:Size-Env.Correct:BW	PaperTransfer:2Side:S1	EN G	[1 to 110 / 87 / 1/step]
2-533-007	Thick3:Size-Env.Correct:BW	PaperTransfer:1Side:S2	EN G	[1 to 110 / 86 / 1/step]
2-533-008	Thick3:Size-Env.Correct:BW	PaperTransfer:2Side:S2	EN G	[1 to 110 / 88 / 1/step]
2-533-011	Thick3:Size-Env.Correct:BW	PaperTransfer:1Side:S3	EN G	[1 to 110 / 86 / 1/step]
2-533-012	Thick3:Size-Env.Correct:BW	PaperTransfer:2Side:S3	EN G	[1 to 110 / 89 / 1/step]
2-533-015	Thick3:Size-Env.Correct:BW	PaperTransfer:1Side:S4	EN G	[1 to 110 / 86 / 1/step]
2-533-016	Thick3:Size-Env.Correct:BW	PaperTransfer:2Side:S4	EN G	[1 to 110 / 90 / 1/step]
2-533-	Thick3:Size-Env.Correct:BW	PaperTransfer:1Side:S5	EN G	[1 to 110 / 86 / 1/step]

3.SP Mode Tables

SP No.	Large Category	Small Category	EN G or CTL	[Min to Max/Init./Step]
019				
2-533-020	Thick3:Size-Env.Correct:BW	PaperTransfer:2Side:S5	EN G	[1 to 110 / 91 / 1/step]
2-533-023	Thick3:Size-Env.Correct:BW	Wide Roller:PaperTransfer:1Side:S1	EN G	[1 to 110 / 85 / 1/step]
2-533-024	Thick3:Size-Env.Correct:BW	Wide Roller:PaperTransfer:2Side:S1	EN G	[1 to 110 / 87 / 1/step]
2-533-027	Thick3:Size-Env.Correct:BW	Wide Roller:PaperTransfer:1Side:S2	EN G	[1 to 110 / 86 / 1/step]
2-533-028	Thick3:Size-Env.Correct:BW	Wide Roller:PaperTransfer:2Side:S2	EN G	[1 to 110 / 88 / 1/step]
2-533-031	Thick3:Size-Env.Correct:BW	Wide Roller:PaperTransfer:1Side:S3	EN G	[1 to 110 / 86 / 1/step]
2-533-032	Thick3:Size-Env.Correct:BW	Wide Roller:PaperTransfer:2Side:S3	EN G	[1 to 110 / 89 / 1/step]
2-533-035	Thick3:Size-Env.Correct:BW	Wide Roller:PaperTransfer:1Side:S4	EN G	[1 to 110 / 86 / 1/step]
2-533-	Thick3:Size-Env.Correct:BW	Wide Roller:PaperTransfer:2Side:S4	EN G	[1 to 110 / 90 / 1/step]

3.SP Mode Tables

SP No.	Large Category	Small Category	EN G or CTL	[Min to Max/Init./Step]
036				
2-533-039	Thick3:Size-Env.Correct:BW	Wide Roller:PaperTransfer:1Side:S5	EN G	[1 to 110 / 86 / 1/step]
2-533-040	Thick3:Size-Env.Correct:BW	Wide Roller:PaperTransfer:2Side:S5	EN G	[1 to 110 / 91 / 1/step]
2-534-003	Thick3:Size-Env.Correct:FC	PaperTransfer:1Side:S1	EN G	[1 to 110 / 77 / 1/step]
2-534-004	Thick3:Size-Env.Correct:FC	PaperTransfer:2Side:S1	EN G	[1 to 110 / 92 / 1/step]
2-534-007	Thick3:Size-Env.Correct:FC	PaperTransfer:1Side:S2	EN G	[1 to 110 / 78 / 1/step]
2-534-008	Thick3:Size-Env.Correct:FC	PaperTransfer:2Side:S2	EN G	[1 to 110 / 93 / 1/step]
2-534-011	Thick3:Size-Env.Correct:FC	PaperTransfer:1Side:S3	EN G	[1 to 110 / 79 / 1/step]
2-534-012	Thick3:Size-Env.Correct:FC	PaperTransfer:2Side:S3	EN G	[1 to 110 / 94 / 1/step]
2-534-	Thick3:Size-Env.Correct:FC	PaperTransfer:1Side:S4	EN G	[1 to 110 / 79 / 1/step]

3.SP Mode Tables

SP No.	Large Category	Small Category	EN G or CTL	[Min to Max/Init./Step]
015				
2-534-016	Thick3:Size-Env.Correct:FC	PaperTransfer:2Side:S4	EN G	[1 to 110 / 95 / 1/step]
2-534-019	Thick3:Size-Env.Correct:FC	PaperTransfer:1Side:S5	EN G	[1 to 110 / 79 / 1/step]
2-534-020	Thick3:Size-Env.Correct:FC	PaperTransfer:2Side:S5	EN G	[1 to 110 / 96 / 1/step]
2-534-023	Thick3:Size-Env.Correct:FC	Wide Roller:PaperTransfer:1Side:S1	EN G	[1 to 110 / 77 / 1/step]
2-534-024	Thick3:Size-Env.Correct:FC	Wide Roller:PaperTransfer:2Side:S1	EN G	[1 to 110 / 92 / 1/step]
2-534-027	Thick3:Size-Env.Correct:FC	Wide Roller:PaperTransfer:1Side:S2	EN G	[1 to 110 / 78 / 1/step]
2-534-028	Thick3:Size-Env.Correct:FC	Wide Roller:PaperTransfer:2Side:S2	EN G	[1 to 110 / 93 / 1/step]
2-534-031	Thick3:Size-Env.Correct:FC	Wide Roller:PaperTransfer:1Side:S3	EN G	[1 to 110 / 79 / 1/step]
2-534-	Thick3:Size-Env.Correct:FC	Wide Roller:PaperTransfer:2Side:S3	EN G	[1 to 110 / 94 / 1/step]

3.SP Mode Tables

SP No.	Large Category	Small Category	EN G or CTL	[Min to Max/Init./Step]
032				
2-534-035	Thick3:Size-Env.Correct:FC	Wide Roller:PaperTransfer:1Side:S4	EN G	[1 to 110 / 79 / 1/step]
2-534-036	Thick3:Size-Env.Correct:FC	Wide Roller:PaperTransfer:2Side:S4	EN G	[1 to 110 / 95 / 1/step]
2-534-039	Thick3:Size-Env.Correct:FC	Wide Roller:PaperTransfer:1Side:S5	EN G	[1 to 110 / 79 / 1/step]
2-534-040	Thick3:Size-Env.Correct:FC	Wide Roller:PaperTransfer:2Side:S5	EN G	[1 to 110 / 96 / 1/step]
2-535-003	Thick3:LeadingEdgeCorrection	Paper Transfer:1side	EN G	[0 to 995 / 100 / 5%/step]
2-535-004	Thick3:LeadingEdgeCorrection	Paper Transfer:2side	EN G	[0 to 995 / 100 / 5%/step]
2-536-003	Thick3:SwitchTimingLeadEdge	Paper Transfer:1side	EN G	[0 to 50 / 0 / 2mm/step]
2-536-004	Thick3:SwitchTimingLeadEdge	Paper Transfer:2side	EN G	[0 to 50 / 0 / 2mm/step]
2-537-	Thick3:TrailEdgeCorrection	Paper Transfer:1side	EN G	[0 to 995 / 100 / 5%/step]

3.SP Mode Tables

SP No.	Large Category	Small Category	EN G or CTL	[Min to Max/Init./Step]
003				
2-537-004	Thick3:TrailEdgeCorrection	Paper Transfer:2side	EN G	[0 to 995 / 100 / 5%/step]
2-538-003	Thick3:SwitchTimingTrailEdge	Paper Transfer:1side	EN G	[0 to 50 / 0 / 2mm/step]
2-538-004	Thick3:SwitchTimingTrailEdge	Paper Transfer:2side	EN G	[0 to 50 / 0 / 2mm/step]
2-543-003	OHP:Bias:BW	PaperTransfer	EN G	IM C3500: [0 to 200 / 11 / 1-uA/step] IM C2500: [0 to 200 / 11 / 1-uA/step] IM C2000: [0 to 200 / 11 / 1-uA/step] IM C3000: [0 to 200 / 11 / 1-uA/step]
2-547-003	OHP:Bias:FC	PaperTransfer	EN G	IM C3500: [0 to 200 / 19 / 1-uA/step] IM C2500: [0 to 200 / 19 / 1-uA/step] IM C2000: [0 to 200 / 19 / 1-uA/step] IM C3000: [0 to 200 / 19

3.SP Mode Tables

SP No.	Large Category	Small Category	EN G or CTL	[Min to Max/Init./Step]
				/ 1-uA/step]
2-551-003	OHP:SizeCorrection:BW	PaperTransfer:S1	EN G	[100 to 995 / 100 / 1%/step]
2-551-007	OHP:SizeCorrection:BW	PaperTransfer:S2	EN G	[100 to 995 / 100 / 1%/step]
2-551-011	OHP:SizeCorrection:BW	PaperTransfer:S3	EN G	[100 to 995 / 100 / 1%/step]
2-551-015	OHP:SizeCorrection:BW	PaperTransfer:S4	EN G	[100 to 995 / 100 / 1%/step]
2-551-019	OHP:SizeCorrection:BW	PaperTransfer:S5	EN G	[100 to 995 / 100 / 1%/step]
2-551-023	OHP:SizeCorrection:BW	Wide Roller:PaperTransfer:S1	EN G	[100 to 995 / 100 / 1%/step]
2-551-027	OHP:SizeCorrection:BW	Wide Roller:PaperTransfer:S2	EN G	[100 to 995 / 100 / 1%/step]
2-551-031	OHP:SizeCorrection:BW	Wide Roller:PaperTransfer:S3	EN G	[100 to 995 / 100 / 1%/step]
2-551-	OHP:SizeCorrection:BW	Wide Roller:PaperTransfer:S4	EN G	[100 to 995 / 100 / 1%/step]

3.SP Mode Tables

SP No.	Large Category	Small Category	EN G or CTL	[Min to Max/Init./Step]
035				
2-551-039	OHP:SizeCorrection:BW	Wide Roller:PaperTransfer:S5	EN G	[100 to 995 / 100 / 1%/step]
2-552-003	OHP:SizeCorrection:FC	PaperTransfer:S1	EN G	[100 to 995 / 100 / 1%/step]
2-552-007	OHP:SizeCorrection:FC	PaperTransfer:S2	EN G	[100 to 995 / 181 / 1%/step]
2-552-011	OHP:SizeCorrection:FC	PaperTransfer:S3	EN G	[100 to 995 / 229 / 1%/step]
2-552-015	OHP:SizeCorrection:FC	PaperTransfer:S4	EN G	[100 to 995 / 286 / 1%/step]
2-552-019	OHP:SizeCorrection:FC	PaperTransfer:S5	EN G	[100 to 995 / 381 / 1%/step]
2-552-023	OHP:SizeCorrection:FC	Wide Roller:PaperTransfer:S1	EN G	[100 to 995 / 100 / 1%/step]
2-552-027	OHP:SizeCorrection:FC	Wide Roller:PaperTransfer:S2	EN G	[100 to 995 / 181 / 1%/step]
2-552-	OHP:SizeCorrection:FC	Wide Roller:PaperTransfer:S3	EN G	[100 to 995 / 229 / 1%/step]

3.SP Mode Tables

SP No.	Large Category	Small Category	EN G or CTL	[Min to Max/Init./Step]
031				
2-552-035	OHP:SizeCorrection:FC	Wide Roller:PaperTransfer:S4	EN G	[100 to 995 / 286 / 1%/step]
2-552-039	OHP:SizeCorrection:FC	Wide Roller:PaperTransfer:S5	EN G	[100 to 995 / 381 / 1%/step]
2-553-003	OHP:Size-Env.Correct:BW	PaperTransfer:S1	EN G	[1 to 110 / 70 / 1/step]
2-553-007	OHP:Size-Env.Correct:BW	PaperTransfer:S2	EN G	[1 to 110 / 71 / 1/step]
2-553-011	OHP:Size-Env.Correct:BW	PaperTransfer:S3	EN G	[1 to 110 / 72 / 1/step]
2-553-015	OHP:Size-Env.Correct:BW	PaperTransfer:S4	EN G	[1 to 110 / 72 / 1/step]
2-553-019	OHP:Size-Env.Correct:BW	PaperTransfer:S5	EN G	[1 to 110 / 72 / 1/step]
2-553-023	OHP:Size-Env.Correct:BW	Wide Roller:PaperTransfer:S1	EN G	[1 to 110 / 70 / 1/step]
2-553-	OHP:Size-Env.Correct:BW	Wide Roller:PaperTransfer:S2	EN G	[1 to 110 / 71 / 1/step]

3.SP Mode Tables

SP No.	Large Category	Small Category	EN G or CTL	[Min to Max/Init./Step]
027				
2-553-031	OHP:Size-Env.Correct:BW	Wide Roller:PaperTransfer:S3	EN G	[1 to 110 / 72 / 1/step]
2-553-035	OHP:Size-Env.Correct:BW	Wide Roller:PaperTransfer:S4	EN G	[1 to 110 / 72 / 1/step]
2-553-039	OHP:Size-Env.Correct:BW	Wide Roller:PaperTransfer:S5	EN G	[1 to 110 / 72 / 1/step]
2-554-003	OHP:Size-Env.Correct:FC	PaperTransfer:S1	EN G	[1 to 110 / 77 / 1/step]
2-554-007	OHP:Size-Env.Correct:FC	PaperTransfer:S2	EN G	[1 to 110 / 78 / 1/step]
2-554-011	OHP:Size-Env.Correct:FC	PaperTransfer:S3	EN G	[1 to 110 / 79 / 1/step]
2-554-015	OHP:Size-Env.Correct:FC	PaperTransfer:S4	EN G	[1 to 110 / 79 / 1/step]
2-554-019	OHP:Size-Env.Correct:FC	PaperTransfer:S5	EN G	[1 to 110 / 79 / 1/step]
2-554-	OHP:Size-Env.Correct:FC	Wide Roller:PaperTransfer:S1	EN G	[1 to 110 / 77 / 1/step]

3.SP Mode Tables

SP No.	Large Category	Small Category	EN G or CTL	[Min to Max/Init./Step]
023				
2-554-027	OHP:Size-Env.Correct:FC	Wide Roller:PaperTransfer:S2	EN G	[1 to 110 / 78 / 1/step]
2-554-031	OHP:Size-Env.Correct:FC	Wide Roller:PaperTransfer:S3	EN G	[1 to 110 / 79 / 1/step]
2-554-035	OHP:Size-Env.Correct:FC	Wide Roller:PaperTransfer:S4	EN G	[1 to 110 / 79 / 1/step]
2-554-039	OHP:Size-Env.Correct:FC	Wide Roller:PaperTransfer:S5	EN G	[1 to 110 / 79 / 1/step]
2-555-003	OHP:LeadingEdgeCorrection	Paper Transfer	EN G	[0 to 995 / 100 / 5%/step]
2-556-003	OHP:SwitchTimingLeadEdge	Paper Transfer	EN G	[0 to 50 / 0 / 2mm/step]
2-557-003	OHP:TrailEdgeCorrection	Paper Transfer	EN G	[0 to 995 / 100 / 5%/step]
2-558-003	OHP:SwitchTimingTrailEdge	Paper Transfer	EN G	[0 to 50 / 0 / 2mm/step]
2-563-	Special1:Bias:BW	PaperTransfer:standard:1side	EN G	IM C3500: [0 to 200 / 22 / 1-uA/step]

3.SP Mode Tables

SP No.	Large Category	Small Category	EN G or CTL	[Min to Max/Init./Step]
001				IM C2500: [0 to 200 / 22 / 1-uA/step] IM C2000: [0 to 200 / 22 / 1-uA/step] IM C3000: [0 to 200 / 22 / 1-uA/step]
2-563-002	Special1:Bias:BW	PaperTransfer:standard:2side	EN G	IM C3500: [0 to 200 / 22 / 1-uA/step] IM C2500: [0 to 200 / 22 / 1-uA/step] IM C2000: [0 to 200 / 22 / 1-uA/step] IM C3000: [0 to 200 / 22 / 1-uA/step]
2-563-003	Special1:Bias:BW	PaperTransfer:low:1side	EN G	IM C3500: [0 to 200 / 11 / 1-uA/step] IM C2500: [0 to 200 / 11 / 1-uA/step] IM C2000: [0 to 200 / 11 / 1-uA/step] IM C3000: [0 to 200 / 11 / 1-uA/step]
2-563-	Special1:Bias:BW	PaperTransfer:low:2side	EN G	IM C3500: [0 to 200 / 11 / 1-uA/step]

3.SP Mode Tables

SP No.	Large Category	Small Category	EN G or CTL	[Min to Max/Init./Step]
004				IM C2500: [0 to 200 / 11 / 1-uA/step] IM C2000: [0 to 200 / 11 / 1-uA/step] IM C3000: [0 to 200 / 11 / 1-uA/step]
2-567-001	Special1:Bias:FC	PaperTransfer:standard:1side	EN G	IM C3500: [0 to 200 / 29 / 1-uA/step] IM C2500: [0 to 200 / 29 / 1-uA/step] IM C2000: [0 to 200 / 29 / 1-uA/step] IM C3000: [0 to 200 / 29 / 1-uA/step]
2-567-002	Special1:Bias:FC	PaperTransfer:standard:2side	EN G	IM C3500: [0 to 200 / 29 / 1-uA/step] IM C2500: [0 to 200 / 29 / 1-uA/step] IM C2000: [0 to 200 / 29 / 1-uA/step] IM C3000: [0 to 200 / 29 / 1-uA/step]
2-567-	Special1:Bias:FC	PaperTransfer:low:1side	EN G	IM C3500: [0 to 200 / 14 / 1-uA/step]

3.SP Mode Tables

SP No.	Large Category	Small Category	EN G or CTL	[Min to Max/Init./Step]
003				IM C2500: [0 to 200 / 14 / 1-uA/step] IM C2000: [0 to 200 / 14 / 1-uA/step] IM C3000: [0 to 200 / 14 / 1-uA/step]
2-567-004	Special1:Bias:FC	PaperTransfer:low:2side	EN G	IM C3500: [0 to 200 / 14 / 1-uA/step] IM C2500: [0 to 200 / 14 / 1-uA/step] IM C2000: [0 to 200 / 14 / 1-uA/step] IM C3000: [0 to 200 / 14 / 1-uA/step]
2-571-001	Special1:SizeCorrection:BW	PaperTransfer:Standard:1Sid:S1	EN G	[100 to 995 / 100 / 1%/step]
2-571-002	Special1:SizeCorrection:BW	PaperTransfer:Standard:2Sid:S1	EN G	[100 to 995 / 100 / 1%/step]
2-571-003	Special1:SizeCorrection:BW	PaperTransfer:Low:1Side:S1	EN G	[100 to 995 / 100 / 1%/step]
2-571-	Special1:SizeCorrection:BW	PaperTransfer:Low:2Side:S1	EN G	[100 to 995 / 100 / 1%/step]

3.SP Mode Tables

SP No.	Large Category	Small Category	EN G or CTL	[Min to Max/Init./Step]
004				
2-571-005	Special1:SizeCorrection:BW	PaperTransfer:Standard:1Sid:S2	EN G	[100 to 995 / 100 / 1%/step]
2-571-006	Special1:SizeCorrection:BW	PaperTransfer:Standard:2Sid:S2	EN G	[100 to 995 / 105 / 1%/step]
2-571-007	Special1:SizeCorrection:BW	PaperTransfer:Low:1Side:S2	EN G	[100 to 995 / 100 / 1%/step]
2-571-008	Special1:SizeCorrection:BW	PaperTransfer:Low:2Side:S2	EN G	[100 to 995 / 105 / 1%/step]
2-571-009	Special1:SizeCorrection:BW	PaperTransfer:Standard:1Sid:S3	EN G	[100 to 995 / 105 / 1%/step]
2-571-010	Special1:SizeCorrection:BW	PaperTransfer:Standard:2Sid:S3	EN G	[100 to 995 / 118 / 1%/step]
2-571-011	Special1:SizeCorrection:BW	PaperTransfer:Low:1Side:S3	EN G	[100 to 995 / 105 / 1%/step]
2-571-012	Special1:SizeCorrection:BW	PaperTransfer:Low:2Side:S3	EN G	[100 to 995 / 118 / 1%/step]
2-571-	Special1:SizeCorrection:BW	PaperTransfer:Standard:1Sid:S4	EN G	[100 to 995 / 118 / 1%/step]

3.SP Mode Tables

SP No.	Large Category	Small Category	EN G or CTL	[Min to Max/Init./Step]
013				
2-571-014	Special1:SizeCorrection:BW	PaperTransfer:Standard:2Sid:S4	EN G	[100 to 995 / 131 / 1%/step]
2-571-015	Special1:SizeCorrection:BW	PaperTransfer:Low:1Side:S4	EN G	[100 to 995 / 118 / 1%/step]
2-571-016	Special1:SizeCorrection:BW	PaperTransfer:Low:2Side:S4	EN G	[100 to 995 / 131 / 1%/step]
2-571-017	Special1:SizeCorrection:BW	PaperTransfer:Standard:1Sid:S5	EN G	[100 to 995 / 132 / 1%/step]
2-571-018	Special1:SizeCorrection:BW	PaperTransfer:Standard:2Sid:S5	EN G	[100 to 995 / 184 / 1%/step]
2-571-019	Special1:SizeCorrection:BW	PaperTransfer:Low:1Side:S5	EN G	[100 to 995 / 132 / 1%/step]
2-571-020	Special1:SizeCorrection:BW	PaperTransfer:Low:2Side:S5	EN G	[100 to 995 / 184 / 1%/step]
2-571-021	Special1:SizeCorrection:BW	Wide Roller:PaperTransfer:Standard:1Sid:S1	EN G	[100 to 995 / 100 / 1%/step]
2-571-	Special1:SizeCorrection:BW	Wide Roller:PaperTransfer:Standard:2Sid:S1	EN G	[100 to 995 / 100 / 1%/step]

3.SP Mode Tables

SP No.	Large Category	Small Category	EN G or CTL	[Min to Max/Init./Step]
022				
2-571-023	Special1:SizeCorrection:BW	Wide Roller:PaperTransfer:Low:1Side:S1	EN G	[100 to 995 / 100 / 1%/step]
2-571-024	Special1:SizeCorrection:BW	Wide Roller:PaperTransfer:Low:2Side:S1	EN G	[100 to 995 / 100 / 1%/step]
2-571-025	Special1:SizeCorrection:BW	Wide Roller:PaperTransfer:Standard:1Sid:S2	EN G	[100 to 995 / 100 / 1%/step]
2-571-026	Special1:SizeCorrection:BW	Wide Roller:PaperTransfer:Standard:2Sid:S2	EN G	[100 to 995 / 105 / 1%/step]
2-571-027	Special1:SizeCorrection:BW	Wide Roller:PaperTransfer:Low:1Side:S2	EN G	[100 to 995 / 100 / 1%/step]
2-571-028	Special1:SizeCorrection:BW	Wide Roller:PaperTransfer:Low:2Side:S2	EN G	[100 to 995 / 105 / 1%/step]
2-571-029	Special1:SizeCorrection:BW	Wide Roller:PaperTransfer:Standard:1Sid:S3	EN G	[100 to 995 / 105 / 1%/step]
2-571-030	Special1:SizeCorrection:BW	Wide Roller:PaperTransfer:Standard:2Sid:S3	EN G	[100 to 995 / 118 / 1%/step]
2-571-	Special1:SizeCorrection:BW	Wide Roller:PaperTransfer:Low:1Side:S3	EN G	[100 to 995 / 105 / 1%/step]

3.SP Mode Tables

SP No.	Large Category	Small Category	EN G or CTL	[Min to Max/Init./Step]
031				
2-571-032	Special1:SizeCorrection:BW	Wide Roller:PaperTransfer:Low:2Side:S3	EN G	[100 to 995 / 118 / 1%/step]
2-571-033	Special1:SizeCorrection:BW	Wide Roller:PaperTransfer:Standard:1Sid:S4	EN G	[100 to 995 / 118 / 1%/step]
2-571-034	Special1:SizeCorrection:BW	Wide Roller:PaperTransfer:Standard:2Sid:S4	EN G	[100 to 995 / 131 / 1%/step]
2-571-035	Special1:SizeCorrection:BW	Wide Roller:PaperTransfer:Low:1Side:S4	EN G	[100 to 995 / 118 / 1%/step]
2-571-036	Special1:SizeCorrection:BW	Wide Roller:PaperTransfer:Low:2Side:S4	EN G	[100 to 995 / 131 / 1%/step]
2-571-037	Special1:SizeCorrection:BW	Wide Roller:PaperTransfer:Standard:1Sid:S5	EN G	[100 to 995 / 132 / 1%/step]
2-571-038	Special1:SizeCorrection:BW	Wide Roller:PaperTransfer:Standard:2Sid:S5	EN G	[100 to 995 / 184 / 1%/step]
2-571-039	Special1:SizeCorrection:BW	Wide Roller:PaperTransfer:Low:1Side:S5	EN G	[100 to 995 / 132 / 1%/step]
2-571-	Special1:SizeCorrection:BW	Wide Roller:PaperTransfer:Low:2Side:S5	EN G	[100 to 995 / 184 / 1%/step]

3.SP Mode Tables

SP No.	Large Category	Small Category	EN G or CTL	[Min to Max/Init./Step]
040				
2-572-001	Special1:SizeCorrection:FC	PaperTransfer:Standard:1Sid:S1	EN G	[100 to 995 / 100 / 1%/step]
2-572-002	Special1:SizeCorrection:FC	PaperTransfer:Standard:2Sid:S1	EN G	[100 to 995 / 100 / 1%/step]
2-572-003	Special1:SizeCorrection:FC	PaperTransfer:Low:1Side:S1	EN G	[100 to 995 / 100 / 1%/step]
2-572-004	Special1:SizeCorrection:FC	PaperTransfer:Low:2Side:S1	EN G	[100 to 995 / 100 / 1%/step]
2-572-005	Special1:SizeCorrection:FC	PaperTransfer:Standard:1Sid:S2	EN G	[100 to 995 / 120 / 1%/step]
2-572-006	Special1:SizeCorrection:FC	PaperTransfer:Standard:2Sid:S2	EN G	[100 to 995 / 140 / 1%/step]
2-572-007	Special1:SizeCorrection:FC	PaperTransfer:Low:1Side:S2	EN G	[100 to 995 / 120 / 1%/step]
2-572-008	Special1:SizeCorrection:FC	PaperTransfer:Low:2Side:S2	EN G	[100 to 995 / 140 / 1%/step]
2-572-	Special1:SizeCorrection:FC	PaperTransfer:Standard:1Sid:S3	EN G	[100 to 995 / 118 / 1%/step]

3.SP Mode Tables

SP No.	Large Category	Small Category	EN G or CTL	[Min to Max/Init./Step]
009				
2-572-010	Special1:SizeCorrection:FC	PaperTransfer:Standard:2Sid:S3	EN G	[100 to 995 / 180 / 1%/step]
2-572-011	Special1:SizeCorrection:FC	PaperTransfer:Low:1Side:S3	EN G	[100 to 995 / 118 / 1%/step]
2-572-012	Special1:SizeCorrection:FC	PaperTransfer:Low:2Side:S3	EN G	[100 to 995 / 180 / 1%/step]
2-572-013	Special1:SizeCorrection:FC	PaperTransfer:Standard:1Sid:S4	EN G	[100 to 995 / 130 / 1%/step]
2-572-014	Special1:SizeCorrection:FC	PaperTransfer:Standard:2Sid:S4	EN G	[100 to 995 / 200 / 1%/step]
2-572-015	Special1:SizeCorrection:FC	PaperTransfer:Low:1Side:S4	EN G	[100 to 995 / 130 / 1%/step]
2-572-016	Special1:SizeCorrection:FC	PaperTransfer:Low:2Side:S4	EN G	[100 to 995 / 200 / 1%/step]
2-572-017	Special1:SizeCorrection:FC	PaperTransfer:Standard:1Sid:S5	EN G	[100 to 995 / 140 / 1%/step]
2-572-	Special1:SizeCorrection:FC	PaperTransfer:Standard:2Sid:S5	EN G	[100 to 995 / 240 / 1%/step]

3.SP Mode Tables

SP No.	Large Category	Small Category	EN G or CTL	[Min to Max/Init./Step]
018				
2-572-019	Special1:SizeCorrection:FC	PaperTransfer:Low:1Side:S5	EN G	[100 to 995 / 140 / 1%/step]
2-572-020	Special1:SizeCorrection:FC	PaperTransfer:Low:2Side:S5	EN G	[100 to 995 / 240 / 1%/step]
2-572-021	Special1:SizeCorrection:FC	Wide Roller:PaperTransfer:Standard:1Sid:S1	EN G	[100 to 995 / 100 / 1%/step]
2-572-022	Special1:SizeCorrection:FC	Wide Roller:PaperTransfer:Standard:2Sid:S1	EN G	[100 to 995 / 100 / 1%/step]
2-572-023	Special1:SizeCorrection:FC	Wide Roller:PaperTransfer:Low:1Side:S1	EN G	[100 to 995 / 100 / 1%/step]
2-572-024	Special1:SizeCorrection:FC	Wide Roller:PaperTransfer:Low:2Side:S1	EN G	[100 to 995 / 100 / 1%/step]
2-572-025	Special1:SizeCorrection:FC	Wide Roller:PaperTransfer:Standard:1Sid:S2	EN G	[100 to 995 / 120 / 1%/step]
2-572-026	Special1:SizeCorrection:FC	Wide Roller:PaperTransfer:Standard:2Sid:S2	EN G	[100 to 995 / 140 / 1%/step]
2-572-	Special1:SizeCorrection:FC	Wide Roller:PaperTransfer:Low:1Side:S2	EN G	[100 to 995 / 120 / 1%/step]

3.SP Mode Tables

SP No.	Large Category	Small Category	EN G or CTL	[Min to Max/Init./Step]
027				
2-572-028	Special1:SizeCorrection:FC	Wide Roller:PaperTransfer:Low:2Side:S2	EN G	[100 to 995 / 140 / 1%/step]
2-572-029	Special1:SizeCorrection:FC	Wide Roller:PaperTransfer:Standard:1Sid:S3	EN G	[100 to 995 / 118 / 1%/step]
2-572-030	Special1:SizeCorrection:FC	Wide Roller:PaperTransfer:Standard:2Sid:S3	EN G	[100 to 995 / 180 / 1%/step]
2-572-031	Special1:SizeCorrection:FC	Wide Roller:PaperTransfer:Low:1Side:S3	EN G	[100 to 995 / 118 / 1%/step]
2-572-032	Special1:SizeCorrection:FC	Wide Roller:PaperTransfer:Low:2Side:S3	EN G	[100 to 995 / 180 / 1%/step]
2-572-033	Special1:SizeCorrection:FC	Wide Roller:PaperTransfer:Standard:1Sid:S4	EN G	[100 to 995 / 130 / 1%/step]
2-572-034	Special1:SizeCorrection:FC	Wide Roller:PaperTransfer:Standard:2Sid:S4	EN G	[100 to 995 / 200 / 1%/step]
2-572-035	Special1:SizeCorrection:FC	Wide Roller:PaperTransfer:Low:1Side:S4	EN G	[100 to 995 / 130 / 1%/step]
2-572-	Special1:SizeCorrection:FC	Wide Roller:PaperTransfer:Low:2Side:S4	EN G	[100 to 995 / 200 / 1%/step]

3.SP Mode Tables

SP No.	Large Category	Small Category	EN G or CTL	[Min to Max/Init./Step]
036				
2-572-037	Special1:SizeCorrection:FC	Wide Roller:PaperTransfer:Standard:1Sid:S5	EN G	[100 to 995 / 140 / 1%/step]
2-572-038	Special1:SizeCorrection:FC	Wide Roller:PaperTransfer:Standard:2Sid:S5	EN G	[100 to 995 / 240 / 1%/step]
2-572-039	Special1:SizeCorrection:FC	Wide Roller:PaperTransfer:Low:1Side:S5	EN G	[100 to 995 / 140 / 1%/step]
2-572-040	Special1:SizeCorrection:FC	Wide Roller:PaperTransfer:Low:2Side:S5	EN G	[100 to 995 / 240 / 1%/step]
2-573-001	Special1:Size-Env.Correct:BW	PaperTransfer:Standard:1Sid:S1	EN G	[1 to 110 / 10 / 1/step]
2-573-002	Special1:Size-Env.Correct:BW	PaperTransfer:Standard:2Sid:S1	EN G	[1 to 110 / 15 / 1/step]
2-573-003	Special1:Size-Env.Correct:BW	PaperTransfer:Low:1Side:S1	EN G	[1 to 110 / 10 / 1/step]
2-573-004	Special1:Size-Env.Correct:BW	PaperTransfer:Low:2Side:S1	EN G	[1 to 110 / 15 / 1/step]
2-573-	Special1:Size-Env.Correct:BW	PaperTransfer:Standard:1Sid:S2	EN G	[1 to 110 / 11 / 1/step]

3.SP Mode Tables

SP No.	Large Category	Small Category	EN G or CTL	[Min to Max/Init./Step]
005				
2-573-006	Special1:Size-Env.Correct:BW	PaperTransfer:Standard:2Sid:S2	EN G	[1 to 110 / 16 / 1/step]
2-573-007	Special1:Size-Env.Correct:BW	PaperTransfer:Low:1Side:S2	EN G	[1 to 110 / 11 / 1/step]
2-573-008	Special1:Size-Env.Correct:BW	PaperTransfer:Low:2Side:S2	EN G	[1 to 110 / 16 / 1/step]
2-573-009	Special1:Size-Env.Correct:BW	PaperTransfer:Standard:1Sid:S3	EN G	[1 to 110 / 12 / 1/step]
2-573-010	Special1:Size-Env.Correct:BW	PaperTransfer:Standard:2Sid:S3	EN G	[1 to 110 / 17 / 1/step]
2-573-011	Special1:Size-Env.Correct:BW	PaperTransfer:Low:1Side:S3	EN G	[1 to 110 / 12 / 1/step]
2-573-012	Special1:Size-Env.Correct:BW	PaperTransfer:Low:2Side:S3	EN G	[1 to 110 / 17 / 1/step]
2-573-013	Special1:Size-Env.Correct:BW	PaperTransfer:Standard:1Sid:S4	EN G	[1 to 110 / 13 / 1/step]
2-573-	Special1:Size-Env.Correct:BW	PaperTransfer:Standard:2Sid:S4	EN G	[1 to 110 / 18 / 1/step]

3.SP Mode Tables

SP No.	Large Category	Small Category	EN G or CTL	[Min to Max/Init./Step]
014				
2-573-015	Special1:Size-Env.Correct:BW	PaperTransfer:Low:1Side:S4	EN G	[1 to 110 / 13 / 1/step]
2-573-016	Special1:Size-Env.Correct:BW	PaperTransfer:Low:2Side:S4	EN G	[1 to 110 / 18 / 1/step]
2-573-017	Special1:Size-Env.Correct:BW	PaperTransfer:Standard:1Sid:S5	EN G	[1 to 110 / 14 / 1/step]
2-573-018	Special1:Size-Env.Correct:BW	PaperTransfer:Standard:2Sid:S5	EN G	[1 to 110 / 19 / 1/step]
2-573-019	Special1:Size-Env.Correct:BW	PaperTransfer:Low:1Side:S5	EN G	[1 to 110 / 14 / 1/step]
2-573-020	Special1:Size-Env.Correct:BW	PaperTransfer:Low:2Side:S5	EN G	[1 to 110 / 19 / 1/step]
2-573-021	Special1:Size-Env.Correct:BW	Wide Roller:PaperTransfer:Standard:1Sid:S1	EN G	[1 to 110 / 10 / 1/step]
2-573-022	Special1:Size-Env.Correct:BW	Wide Roller:PaperTransfer:Standard:2Sid:S1	EN G	[1 to 110 / 15 / 1/step]
2-573-	Special1:Size-Env.Correct:BW	Wide Roller:PaperTransfer:Low:1Side:S1	EN G	[1 to 110 / 10 / 1/step]

3.SP Mode Tables

SP No.	Large Category	Small Category	EN G or CTL	[Min to Max/Init./Step]
023				
2-573-024	Special1:Size-Env.Correct:BW	Wide Roller:PaperTransfer:Low:2Side:S1	EN G	[1 to 110 / 15 / 1/step]
2-573-025	Special1:Size-Env.Correct:BW	Wide Roller:PaperTransfer:Standard:1Side:S2	EN G	[1 to 110 / 11 / 1/step]
2-573-026	Special1:Size-Env.Correct:BW	Wide Roller:PaperTransfer:Standard:2Side:S2	EN G	[1 to 110 / 16 / 1/step]
2-573-027	Special1:Size-Env.Correct:BW	Wide Roller:PaperTransfer:Low:1Side:S2	EN G	[1 to 110 / 11 / 1/step]
2-573-028	Special1:Size-Env.Correct:BW	Wide Roller:PaperTransfer:Low:2Side:S2	EN G	[1 to 110 / 16 / 1/step]
2-573-029	Special1:Size-Env.Correct:BW	Wide Roller:PaperTransfer:Standard:1Side:S3	EN G	[1 to 110 / 12 / 1/step]
2-573-030	Special1:Size-Env.Correct:BW	Wide Roller:PaperTransfer:Standard:2Side:S3	EN G	[1 to 110 / 17 / 1/step]
2-573-031	Special1:Size-Env.Correct:BW	Wide Roller:PaperTransfer:Low:1Side:S3	EN G	[1 to 110 / 12 / 1/step]
2-573-	Special1:Size-Env.Correct:BW	Wide Roller:PaperTransfer:Low:2Side:S3	EN G	[1 to 110 / 17 / 1/step]

3.SP Mode Tables

SP No.	Large Category	Small Category	EN G or CTL	[Min to Max/Init./Step]
032				
2-573-033	Special1:Size-Env.Correct:BW	Wide Roller:PaperTransfer:Standard:1Sid:S4	EN G	[1 to 110 / 13 / 1/step]
2-573-034	Special1:Size-Env.Correct:BW	Wide Roller:PaperTransfer:Standard:2Sid:S4	EN G	[1 to 110 / 18 / 1/step]
2-573-035	Special1:Size-Env.Correct:BW	Wide Roller:PaperTransfer:Low:1Side:S4	EN G	[1 to 110 / 13 / 1/step]
2-573-036	Special1:Size-Env.Correct:BW	Wide Roller:PaperTransfer:Low:2Side:S4	EN G	[1 to 110 / 18 / 1/step]
2-573-037	Special1:Size-Env.Correct:BW	Wide Roller:PaperTransfer:Standard:1Sid:S5	EN G	[1 to 110 / 14 / 1/step]
2-573-038	Special1:Size-Env.Correct:BW	Wide Roller:PaperTransfer:Standard:2Sid:S5	EN G	[1 to 110 / 19 / 1/step]
2-573-039	Special1:Size-Env.Correct:BW	Wide Roller:PaperTransfer:Low:1Side:S5	EN G	[1 to 110 / 14 / 1/step]
2-573-040	Special1:Size-Env.Correct:BW	Wide Roller:PaperTransfer:Low:2Side:S5	EN G	[1 to 110 / 19 / 1/step]
2-574-	Special1:Size-Env.Correct:FC	PaperTransfer:Standard:1Sid:S1	EN G	[1 to 110 / 20 / 1/step]

3.SP Mode Tables

SP No.	Large Category	Small Category	EN G or CTL	[Min to Max/Init./Step]
001				
2-574-002	Special1:Size-Env.Correct:FC	PaperTransfer:Standard:2Sid:S1	EN G	[1 to 110 / 25 / 1/step]
2-574-003	Special1:Size-Env.Correct:FC	PaperTransfer:Low:1Side:S1	EN G	[1 to 110 / 20 / 1/step]
2-574-004	Special1:Size-Env.Correct:FC	PaperTransfer:Low:2Side:S1	EN G	[1 to 110 / 25 / 1/step]
2-574-005	Special1:Size-Env.Correct:FC	PaperTransfer:Standard:1Sid:S2	EN G	[1 to 110 / 21 / 1/step]
2-574-006	Special1:Size-Env.Correct:FC	PaperTransfer:Standard:2Sid:S2	EN G	[1 to 110 / 26 / 1/step]
2-574-007	Special1:Size-Env.Correct:FC	PaperTransfer:Low:1Side:S2	EN G	[1 to 110 / 21 / 1/step]
2-574-008	Special1:Size-Env.Correct:FC	PaperTransfer:Low:2Side:S2	EN G	[1 to 110 / 26 / 1/step]
2-574-009	Special1:Size-Env.Correct:FC	PaperTransfer:Standard:1Sid:S3	EN G	[1 to 110 / 22 / 1/step]
2-574-	Special1:Size-Env.Correct:FC	PaperTransfer:Standard:2Sid:S3	EN G	[1 to 110 / 27 / 1/step]

3.SP Mode Tables

SP No.	Large Category	Small Category	EN G or CTL	[Min to Max/Init./Step]
010				
2-574-011	Special1:Size-Env.Correct:FC	PaperTransfer:Low:1Side:S3	EN G	[1 to 110 / 22 / 1/step]
2-574-012	Special1:Size-Env.Correct:FC	PaperTransfer:Low:2Side:S3	EN G	[1 to 110 / 27 / 1/step]
2-574-013	Special1:Size-Env.Correct:FC	PaperTransfer:Standard:1Sid:S4	EN G	[1 to 110 / 23 / 1/step]
2-574-014	Special1:Size-Env.Correct:FC	PaperTransfer:Standard:2Sid:S4	EN G	[1 to 110 / 28 / 1/step]
2-574-015	Special1:Size-Env.Correct:FC	PaperTransfer:Low:1Side:S4	EN G	[1 to 110 / 23 / 1/step]
2-574-016	Special1:Size-Env.Correct:FC	PaperTransfer:Low:2Side:S4	EN G	[1 to 110 / 28 / 1/step]
2-574-017	Special1:Size-Env.Correct:FC	PaperTransfer:Standard:1Sid:S5	EN G	[1 to 110 / 24 / 1/step]
2-574-018	Special1:Size-Env.Correct:FC	PaperTransfer:Standard:2Sid:S5	EN G	[1 to 110 / 29 / 1/step]
2-574-	Special1:Size-Env.Correct:FC	PaperTransfer:Low:1Side:S5	EN G	[1 to 110 / 24 / 1/step]

3.SP Mode Tables

SP No.	Large Category	Small Category	EN G or CTL	[Min to Max/Init./Step]
019				
2-574-020	Special1:Size-Env.Correct:FC	PaperTransfer:Low:2Side:S5	EN G	[1 to 110 / 29 / 1/step]
2-574-021	Special1:Size-Env.Correct:FC	Wide Roller:PaperTransfer:Standard:1Side:S1	EN G	[1 to 110 / 20 / 1/step]
2-574-022	Special1:Size-Env.Correct:FC	Wide Roller:PaperTransfer:Standard:2Side:S1	EN G	[1 to 110 / 25 / 1/step]
2-574-023	Special1:Size-Env.Correct:FC	Wide Roller:PaperTransfer:Low:1Side:S1	EN G	[1 to 110 / 20 / 1/step]
2-574-024	Special1:Size-Env.Correct:FC	Wide Roller:PaperTransfer:Low:2Side:S1	EN G	[1 to 110 / 25 / 1/step]
2-574-025	Special1:Size-Env.Correct:FC	Wide Roller:PaperTransfer:Standard:1Side:S2	EN G	[1 to 110 / 21 / 1/step]
2-574-026	Special1:Size-Env.Correct:FC	Wide Roller:PaperTransfer:Standard:2Side:S2	EN G	[1 to 110 / 26 / 1/step]
2-574-027	Special1:Size-Env.Correct:FC	Wide Roller:PaperTransfer:Low:1Side:S2	EN G	[1 to 110 / 21 / 1/step]
2-574-	Special1:Size-Env.Correct:FC	Wide Roller:PaperTransfer:Low:2Side:S2	EN G	[1 to 110 / 26 / 1/step]

3.SP Mode Tables

SP No.	Large Category	Small Category	EN G or CTL	[Min to Max/Init./Step]
028				
2-574-029	Special1:Size-Env.Correct:FC	Wide Roller:PaperTransfer:Standard:1Sid:S3	EN G	[1 to 110 / 22 / 1/step]
2-574-030	Special1:Size-Env.Correct:FC	Wide Roller:PaperTransfer:Standard:2Sid:S3	EN G	[1 to 110 / 27 / 1/step]
2-574-031	Special1:Size-Env.Correct:FC	Wide Roller:PaperTransfer:Low:1Side:S3	EN G	[1 to 110 / 22 / 1/step]
2-574-032	Special1:Size-Env.Correct:FC	Wide Roller:PaperTransfer:Low:2Side:S3	EN G	[1 to 110 / 27 / 1/step]
2-574-033	Special1:Size-Env.Correct:FC	Wide Roller:PaperTransfer:Standard:1Sid:S4	EN G	[1 to 110 / 23 / 1/step]
2-574-034	Special1:Size-Env.Correct:FC	Wide Roller:PaperTransfer:Standard:2Sid:S4	EN G	[1 to 110 / 28 / 1/step]
2-574-035	Special1:Size-Env.Correct:FC	Wide Roller:PaperTransfer:Low:1Side:S4	EN G	[1 to 110 / 23 / 1/step]
2-574-036	Special1:Size-Env.Correct:FC	Wide Roller:PaperTransfer:Low:2Side:S4	EN G	[1 to 110 / 28 / 1/step]
2-574-	Special1:Size-Env.Correct:FC	Wide Roller:PaperTransfer:Standard:1Sid:S5	EN G	[1 to 110 / 24 / 1/step]

3.SP Mode Tables

SP No.	Large Category	Small Category	EN G or CTL	[Min to Max/Init./Step]
037				
2-574-038	Special1:Size-Env.Correct:FC	Wide Roller:PaperTransfer:Standard:2Sid:S5	EN G	[1 to 110 / 29 / 1/step]
2-574-039	Special1:Size-Env.Correct:FC	Wide Roller:PaperTransfer:Low:1Side:S5	EN G	[1 to 110 / 24 / 1/step]
2-574-040	Special1:Size-Env.Correct:FC	Wide Roller:PaperTransfer:Low:2Side:S5	EN G	[1 to 110 / 29 / 1/step]
2-575-001	Special1:LeadingEdgeCorrection	PaperTransfer:Standard:1Side	EN G	[0 to 995 / 100 / 5%/step]
2-575-002	Special1:LeadingEdgeCorrection	PaperTransfer:Standard:2Side	EN G	[0 to 995 / 100 / 5%/step]
2-575-003	Special1:LeadingEdgeCorrection	Paper Transfer:Low:1side	EN G	[0 to 995 / 100 / 5%/step]
2-575-004	Special1:LeadingEdgeCorrection	Paper Transfer:Low:2side	EN G	[0 to 995 / 100 / 5%/step]
2-576-001	Special1:SwitchTimingLeadEdge	PaperTransfer:Standard:1side	EN G	[0 to 50 / 0 / 2mm/step]
2-576-	Special1:SwitchTimingLeadEdge	PaperTransfer:Standard:2side	EN G	[0 to 50 / 0 / 2mm/step]

3.SP Mode Tables

SP No.	Large Category	Small Category	EN G or CTL	[Min to Max/Init./Step]
002				
2-576-003	Special1:SwitchTimingLeadEdge	Paper Transfer:Low:1side	EN G	[0 to 50 / 0 / 2mm/step]
2-576-004	Special1:SwitchTimingLeadEdge	Paper Transfer:Low:2side	EN G	[0 to 50 / 0 / 2mm/step]
2-577-001	Special1:TrailEdgeCorrection	PaperTransfer:Standard:1Side	EN G	[0 to 995 / 100 / 5%/step]
2-577-002	Special1:TrailEdgeCorrection	PaperTransfer:Standard:2Side	EN G	[0 to 995 / 100 / 5%/step]
2-577-003	Special1:TrailEdgeCorrection	Paper Transfer:Low:1side	EN G	[0 to 995 / 100 / 5%/step]
2-577-004	Special1:TrailEdgeCorrection	Paper Transfer:Low:2side	EN G	[0 to 995 / 100 / 5%/step]
2-578-001	Special1:SwitchTimingTrailEdge	PaperTransfer:Standard:1side	EN G	[0 to 50 / 0 / 2mm/step]
2-578-002	Special1:SwitchTimingTrailEdge	PaperTransfer:Standard:2side	EN G	[0 to 50 / 0 / 2mm/step]
2-578-	Special1:SwitchTimingTrailEdge	Paper Transfer:Low:1side	EN G	[0 to 50 / 0 / 2mm/step]

3.SP Mode Tables

SP No.	Large Category	Small Category	EN G or CTL	[Min to Max/Init./Step]
003				
2-578-004	Special1:SwitchTimingTrailEdge	Paper Transfer:Low:2side	EN G	[0 to 50 / 0 / 2mm/step]
2-583-001	Special2:Bias:BW	PaperTransfer:standard:1side	EN G	IM C3500: [0 to 200 / 22 / 1-uA/step] IM C2500: [0 to 200 / 22 / 1-uA/step] IM C2000: [0 to 200 / 22 / 1-uA/step] IM C3000: [0 to 200 / 22 / 1-uA/step]
2-583-002	Special2:Bias:BW	PaperTransfer:standard:2side	EN G	IM C3500: [0 to 200 / 22 / 1-uA/step] IM C2500: [0 to 200 / 22 / 1-uA/step] IM C2000: [0 to 200 / 22 / 1-uA/step] IM C3000: [0 to 200 / 22 / 1-uA/step]
2-583-003	Special2:Bias:BW	PaperTransfer:low:1side	EN G	IM C3500: [0 to 200 / 11 / 1-uA/step] IM C2500: [0 to 200 / 11 / 1-uA/step] IM C2000:

3.SP Mode Tables

SP No.	Large Category	Small Category	EN G or CTL	[Min to Max/Init./Step]
				[0 to 200 / 11 / 1-uA/step] IM C3000: [0 to 200 / 11 / 1-uA/step]
2-583-004	Special2:Bias:BW	PaperTransfer:low:2side	EN G	IM C3500: [0 to 200 / 11 / 1-uA/step] IM C2500: [0 to 200 / 11 / 1-uA/step] IM C2000: [0 to 200 / 11 / 1-uA/step] IM C3000: [0 to 200 / 11 / 1-uA/step]
2-587-001	Special2:Bias:FC	PaperTransfer:standard:1side	EN G	IM C3500: [0 to 200 / 29 / 1-uA/step] IM C2500: [0 to 200 / 29 / 1-uA/step] IM C2000: [0 to 200 / 29 / 1-uA/step] IM C3000: [0 to 200 / 29 / 1-uA/step]
2-587-002	Special2:Bias:FC	PaperTransfer:standard:2side	EN G	IM C3500: [0 to 200 / 29 / 1-uA/step] IM C2500: [0 to 200 / 29 / 1-uA/step] IM C2000:

3.SP Mode Tables

SP No.	Large Category	Small Category	EN G or CTL	[Min to Max/Init./Step]
				[0 to 200 / 29 / 1-uA/step] IM C3000: [0 to 200 / 29 / 1-uA/step]
2-587-003	Special2:Bias:FC	PaperTransfer:low:1side	EN G	IM C3500: [0 to 200 / 14 / 1-uA/step] IM C2500: [0 to 200 / 14 / 1-uA/step] IM C2000: [0 to 200 / 14 / 1-uA/step] IM C3000: [0 to 200 / 14 / 1-uA/step]
2-587-004	Special2:Bias:FC	PaperTransfer:low:2side	EN G	IM C3500: [0 to 200 / 14 / 1-uA/step] IM C2500: [0 to 200 / 14 / 1-uA/step] IM C2000: [0 to 200 / 14 / 1-uA/step] IM C3000: [0 to 200 / 14 / 1-uA/step]
2-591-001	Special2:SizeCorrection:BW	PaperTransfer:standard:1Sid:S1	EN G	[100 to 995 / 100 / 1%/step]
2-591-	Special2:SizeCorrection:BW	PaperTransfer:standard:2Sid:S1	EN G	[100 to 995 / 100 / 1%/step]

3.SP Mode Tables

SP No.	Large Category	Small Category	EN G or CTL	[Min to Max/Init./Step]
002				
2-591-003	Special2:SizeCorrection:BW	PaperTransfer:Low:1Side:S1	EN G	[100 to 995 / 100 / 1%/step]
2-591-004	Special2:SizeCorrection:BW	PaperTransfer:Low:2Side:S1	EN G	[100 to 995 / 100 / 1%/step]
2-591-005	Special2:SizeCorrection:BW	PaperTransfer:standard:1Sid:S2	EN G	[100 to 995 / 100 / 1%/step]
2-591-006	Special2:SizeCorrection:BW	PaperTransfer:standard:2Sid:S2	EN G	[100 to 995 / 105 / 1%/step]
2-591-007	Special2:SizeCorrection:BW	PaperTransfer:Low:1Side:S2	EN G	[100 to 995 / 100 / 1%/step]
2-591-008	Special2:SizeCorrection:BW	PaperTransfer:Low:2Side:S2	EN G	[100 to 995 / 105 / 1%/step]
2-591-009	Special2:SizeCorrection:BW	PaperTransfer:standard:1Sid:S3	EN G	[100 to 995 / 105 / 1%/step]
2-591-010	Special2:SizeCorrection:BW	PaperTransfer:standard:2Sid:S3	EN G	[100 to 995 / 118 / 1%/step]
2-591-	Special2:SizeCorrection:BW	PaperTransfer:Low:1Side:S3	EN G	[100 to 995 / 105 / 1%/step]

3.SP Mode Tables

SP No.	Large Category	Small Category	EN G or CTL	[Min to Max/Init./Step]
011				
2-591-012	Special2:SizeCorrection:BW	PaperTransfer:Low:2Side:S3	EN G	[100 to 995 / 118 / 1%/step]
2-591-013	Special2:SizeCorrection:BW	PaperTransfer:standard:1Sid:S4	EN G	[100 to 995 / 118 / 1%/step]
2-591-014	Special2:SizeCorrection:BW	PaperTransfer:standard:2Sid:S4	EN G	[100 to 995 / 131 / 1%/step]
2-591-015	Special2:SizeCorrection:BW	PaperTransfer:Low:1Side:S4	EN G	[100 to 995 / 118 / 1%/step]
2-591-016	Special2:SizeCorrection:BW	PaperTransfer:Low:2Side:S4	EN G	[100 to 995 / 131 / 1%/step]
2-591-017	Special2:SizeCorrection:BW	PaperTransfer:Standard:1Sid:S5	EN G	[100 to 995 / 132 / 1%/step]
2-591-018	Special2:SizeCorrection:BW	PaperTransfer:Standard:2Sid:S5	EN G	[100 to 995 / 184 / 1%/step]
2-591-019	Special2:SizeCorrection:BW	PaperTransfer:Low:1Side:S5	EN G	[100 to 995 / 132 / 1%/step]
2-591-	Special2:SizeCorrection:BW	PaperTransfer:Low:2Side:S5	EN G	[100 to 995 / 184 / 1%/step]

3.SP Mode Tables

SP No.	Large Category	Small Category	EN G or CTL	[Min to Max/Init./Step]
020				
2-591-021	Special2:SizeCorrection:BW	Wide Roller:PaperTransfer:Standard:1Sid:S1	EN G	[100 to 995 / 100 / 1%/step]
2-591-022	Special2:SizeCorrection:BW	Wide Roller:PaperTransfer:Standard:2Sid:S1	EN G	[100 to 995 / 100 / 1%/step]
2-591-023	Special2:SizeCorrection:BW	Wide Roller:PaperTransfer:Low:1Side:S1	EN G	[100 to 995 / 100 / 1%/step]
2-591-024	Special2:SizeCorrection:BW	Wide Roller:PaperTransfer:Low:2Side:S1	EN G	[100 to 995 / 100 / 1%/step]
2-591-025	Special2:SizeCorrection:BW	Wide Roller:PaperTransfer:Standard:1Sid:S2	EN G	[100 to 995 / 100 / 1%/step]
2-591-026	Special2:SizeCorrection:BW	Wide Roller:PaperTransfer:Standard:2Sid:S2	EN G	[100 to 995 / 105 / 1%/step]
2-591-027	Special2:SizeCorrection:BW	Wide Roller:PaperTransfer:Low:1Side:S2	EN G	[100 to 995 / 100 / 1%/step]
2-591-028	Special2:SizeCorrection:BW	Wide Roller:PaperTransfer:Low:2Side:S2	EN G	[100 to 995 / 105 / 1%/step]
2-591-	Special2:SizeCorrection:BW	Wide Roller:PaperTransfer:Standard:1Sid:S3	EN G	[100 to 995 / 105 / 1%/step]

3.SP Mode Tables

SP No.	Large Category	Small Category	EN G or CTL	[Min to Max/Init./Step]
029				
2-591-030	Special2:SizeCorrection:BW	Wide Roller:PaperTransfer:Standard:2Sid:S3	EN G	[100 to 995 / 118 / 1%/step]
2-591-031	Special2:SizeCorrection:BW	Wide Roller:PaperTransfer:Low:1Side:S3	EN G	[100 to 995 / 105 / 1%/step]
2-591-032	Special2:SizeCorrection:BW	Wide Roller:PaperTransfer:Low:2Side:S3	EN G	[100 to 995 / 118 / 1%/step]
2-591-033	Special2:SizeCorrection:BW	Wide Roller:PaperTransfer:Standard:1Sid:S4	EN G	[100 to 995 / 118 / 1%/step]
2-591-034	Special2:SizeCorrection:BW	Wide Roller:PaperTransfer:Standard:2Sid:S4	EN G	[100 to 995 / 131 / 1%/step]
2-591-035	Special2:SizeCorrection:BW	Wide Roller:PaperTransfer:Low:1Side:S4	EN G	[100 to 995 / 118 / 1%/step]
2-591-036	Special2:SizeCorrection:BW	Wide Roller:PaperTransfer:Low:2Side:S4	EN G	[100 to 995 / 131 / 1%/step]
2-591-037	Special2:SizeCorrection:BW	Wide Roller:PaperTransfer:Standard:1Sid:S5	EN G	[100 to 995 / 132 / 1%/step]
2-591-	Special2:SizeCorrection:BW	Wide Roller:PaperTransfer:Standard:2Sid:S5	EN G	[100 to 995 / 184 / 1%/step]

3.SP Mode Tables

SP No.	Large Category	Small Category	EN G or CTL	[Min to Max/Init./Step]
038				
2-591-039	Special2:SizeCorrection:BW	Wide Roller:PaperTransfer:Low:1Side:S5	EN G	[100 to 995 / 132 / 1%/step]
2-591-040	Special2:SizeCorrection:BW	Wide Roller:PaperTransfer:Low:2Side:S5	EN G	[100 to 995 / 184 / 1%/step]
2-592-001	Special2:SizeCorrection:FC	PaperTransfer:standard:1Sid:S1	EN G	[100 to 995 / 100 / 1%/step]
2-592-002	Special2:SizeCorrection:FC	PaperTransfer:standard:2Sid:S1	EN G	[100 to 995 / 100 / 1%/step]
2-592-003	Special2:SizeCorrection:FC	PaperTransfer:Low:1Side:S1	EN G	[100 to 995 / 100 / 1%/step]
2-592-004	Special2:SizeCorrection:FC	PaperTransfer:Low:2Side:S1	EN G	[100 to 995 / 100 / 1%/step]
2-592-005	Special2:SizeCorrection:FC	PaperTransfer:standard:1Sid:S2	EN G	[100 to 995 / 120 / 1%/step]
2-592-006	Special2:SizeCorrection:FC	PaperTransfer:standard:2Sid:S2	EN G	[100 to 995 / 140 / 1%/step]
2-592-	Special2:SizeCorrection:FC	PaperTransfer:Low:1Side:S2	EN G	[100 to 995 / 120 / 1%/step]

3.SP Mode Tables

SP No.	Large Category	Small Category	EN G or CTL	[Min to Max/Init./Step]
007				
2-592-008	Special2:SizeCorrection:FC	PaperTransfer:Low:2Side:S2	EN G	[100 to 995 / 140 / 1%/step]
2-592-009	Special2:SizeCorrection:FC	PaperTransfer:standard:1Sid:S3	EN G	[100 to 995 / 118 / 1%/step]
2-592-010	Special2:SizeCorrection:FC	PaperTransfer:standard:2Sid:S3	EN G	[100 to 995 / 180 / 1%/step]
2-592-011	Special2:SizeCorrection:FC	PaperTransfer:Low:1Side:S3	EN G	[100 to 995 / 118 / 1%/step]
2-592-012	Special2:SizeCorrection:FC	PaperTransfer:Low:2Side:S3	EN G	[100 to 995 / 180 / 1%/step]
2-592-013	Special2:SizeCorrection:FC	PaperTransfer:standard:1Sid:S4	EN G	[100 to 995 / 130 / 1%/step]
2-592-014	Special2:SizeCorrection:FC	PaperTransfer:standard:2Sid:S4	EN G	[100 to 995 / 200 / 1%/step]
2-592-015	Special2:SizeCorrection:FC	PaperTransfer:Low:1Side:S4	EN G	[100 to 995 / 130 / 1%/step]
2-592-	Special2:SizeCorrection:FC	PaperTransfer:Low:2Side:S4	EN G	[100 to 995 / 200 / 1%/step]

3.SP Mode Tables

SP No.	Large Category	Small Category	EN G or CTL	[Min to Max/Init./Step]
016				
2-592-017	Special2:SizeCorrection:FC	PaperTransfer:Standard:1Sid:S5	EN G	[100 to 995 / 140 / 1%/step]
2-592-018	Special2:SizeCorrection:FC	PaperTransfer:Standard:2Sid:S5	EN G	[100 to 995 / 240 / 1%/step]
2-592-019	Special2:SizeCorrection:FC	PaperTransfer:Low:1Side:S5	EN G	[100 to 995 / 140 / 1%/step]
2-592-020	Special2:SizeCorrection:FC	PaperTransfer:Low:2Side:S5	EN G	[100 to 995 / 240 / 1%/step]
2-592-021	Special2:SizeCorrection:FC	Wide Roller:PaperTransfer:Standard:1Sid:S1	EN G	[100 to 995 / 100 / 1%/step]
2-592-022	Special2:SizeCorrection:FC	Wide Roller:PaperTransfer:Standard:2Sid:S1	EN G	[100 to 995 / 100 / 1%/step]
2-592-023	Special2:SizeCorrection:FC	Wide Roller:PaperTransfer:Low:1Side:S1	EN G	[100 to 995 / 100 / 1%/step]
2-592-024	Special2:SizeCorrection:FC	Wide Roller:PaperTransfer:Low:2Side:S1	EN G	[100 to 995 / 100 / 1%/step]
2-592-	Special2:SizeCorrection:FC	Wide Roller:PaperTransfer:Standard:1Sid:S2	EN G	[100 to 995 / 120 / 1%/step]

3.SP Mode Tables

SP No.	Large Category	Small Category	EN G or CTL	[Min to Max/Init./Step]
025				
2-592-026	Special2:SizeCorrection:FC	Wide Roller:PaperTransfer:Standard:2Sid:S2	EN G	[100 to 995 / 140 / 1%/step]
2-592-027	Special2:SizeCorrection:FC	Wide Roller:PaperTransfer:Low:1Side:S2	EN G	[100 to 995 / 120 / 1%/step]
2-592-028	Special2:SizeCorrection:FC	Wide Roller:PaperTransfer:Low:2Side:S2	EN G	[100 to 995 / 140 / 1%/step]
2-592-029	Special2:SizeCorrection:FC	Wide Roller:PaperTransfer:Standard:1Sid:S3	EN G	[100 to 995 / 118 / 1%/step]
2-592-030	Special2:SizeCorrection:FC	Wide Roller:PaperTransfer:Standard:2Sid:S3	EN G	[100 to 995 / 180 / 1%/step]
2-592-031	Special2:SizeCorrection:FC	Wide Roller:PaperTransfer:Low:1Side:S3	EN G	[100 to 995 / 118 / 1%/step]
2-592-032	Special2:SizeCorrection:FC	Wide Roller:PaperTransfer:Low:2Side:S3	EN G	[100 to 995 / 180 / 1%/step]
2-592-033	Special2:SizeCorrection:FC	Wide Roller:PaperTransfer:Standard:1Sid:S4	EN G	[100 to 995 / 130 / 1%/step]
2-592-	Special2:SizeCorrection:FC	Wide Roller:PaperTransfer:Standard:2Sid:S4	EN G	[100 to 995 / 200 / 1%/step]

3.SP Mode Tables

SP No.	Large Category	Small Category	EN G or CTL	[Min to Max/Init./Step]
034				
2-592-035	Special2:SizeCorrection:FC	Wide Roller:PaperTransfer:Low:1Side:S4	EN G	[100 to 995 / 130 / 1%/step]
2-592-036	Special2:SizeCorrection:FC	Wide Roller:PaperTransfer:Low:2Side:S4	EN G	[100 to 995 / 200 / 1%/step]
2-592-037	Special2:SizeCorrection:FC	Wide Roller:PaperTransfer:Standard:1Sid:S5	EN G	[100 to 995 / 140 / 1%/step]
2-592-038	Special2:SizeCorrection:FC	Wide Roller:PaperTransfer:Standard:2Sid:S5	EN G	[100 to 995 / 240 / 1%/step]
2-592-039	Special2:SizeCorrection:FC	Wide Roller:PaperTransfer:Low:1Side:S5	EN G	[100 to 995 / 140 / 1%/step]
2-592-040	Special2:SizeCorrection:FC	Wide Roller:PaperTransfer:Low:2Side:S5	EN G	[100 to 995 / 240 / 1%/step]
2-593-001	Special2:Size-Env.Correct:BW	PaperTransfer:standard:1Sid:S1	EN G	[1 to 110 / 10 / 1/step]
2-593-002	Special2:Size-Env.Correct:BW	PaperTransfer:standard:2Sid:S1	EN G	[1 to 110 / 15 / 1/step]
2-593-	Special2:Size-Env.Correct:BW	PaperTransfer:Low:1Side:S1	EN G	[1 to 110 / 10 / 1/step]

3.SP Mode Tables

SP No.	Large Category	Small Category	EN G or CTL	[Min to Max/Init./Step]
003				
2-593-004	Special2:Size-Env.Correct:BW	PaperTransfer:Low:2Side:S1	EN G	[1 to 110 / 15 / 1/step]
2-593-005	Special2:Size-Env.Correct:BW	PaperTransfer:standard:1Sid:S2	EN G	[1 to 110 / 11 / 1/step]
2-593-006	Special2:Size-Env.Correct:BW	PaperTransfer:standard:2Sid:S2	EN G	[1 to 110 / 16 / 1/step]
2-593-007	Special2:Size-Env.Correct:BW	PaperTransfer:Low:1Side:S2	EN G	[1 to 110 / 11 / 1/step]
2-593-008	Special2:Size-Env.Correct:BW	PaperTransfer:Low:2Side:S2	EN G	[1 to 110 / 16 / 1/step]
2-593-009	Special2:Size-Env.Correct:BW	PaperTransfer:standard:1Sid:S3	EN G	[1 to 110 / 12 / 1/step]
2-593-010	Special2:Size-Env.Correct:BW	PaperTransfer:standard:2Sid:S3	EN G	[1 to 110 / 17 / 1/step]
2-593-011	Special2:Size-Env.Correct:BW	PaperTransfer:Low:1Side:S3	EN G	[1 to 110 / 12 / 1/step]
2-593-	Special2:Size-Env.Correct:BW	PaperTransfer:Low:2Side:S3	EN G	[1 to 110 / 17 / 1/step]

3.SP Mode Tables

SP No.	Large Category	Small Category	EN G or CTL	[Min to Max/Init./Step]
012				
2-593-013	Special2:Size-Env.Correct:BW	PaperTransfer:standard:1Sid:S4	EN G	[1 to 110 / 13 / 1/step]
2-593-014	Special2:Size-Env.Correct:BW	PaperTransfer:standard:2Sid:S4	EN G	[1 to 110 / 18 / 1/step]
2-593-015	Special2:Size-Env.Correct:BW	PaperTransfer:Low:1Side:S4	EN G	[1 to 110 / 13 / 1/step]
2-593-016	Special2:Size-Env.Correct:BW	PaperTransfer:Low:2Side:S4	EN G	[1 to 110 / 18 / 1/step]
2-593-017	Special2:Size-Env.Correct:BW	PaperTransfer:Standard:1Sid:S5	EN G	[1 to 110 / 14 / 1/step]
2-593-018	Special2:Size-Env.Correct:BW	PaperTransfer:Standard:2Sid:S5	EN G	[1 to 110 / 19 / 1/step]
2-593-019	Special2:Size-Env.Correct:BW	PaperTransfer:Low:1Side:S5	EN G	[1 to 110 / 14 / 1/step]
2-593-020	Special2:Size-Env.Correct:BW	PaperTransfer:Low:2Side:S5	EN G	[1 to 110 / 19 / 1/step]
2-593-	Special2:Size-Env.Correct:BW	Wide Roller:PaperTransfer:Standard:1Sid:S1	EN G	[1 to 110 / 10 / 1/step]

3.SP Mode Tables

SP No.	Large Category	Small Category	EN G or CTL	[Min to Max/Init./Step]
021				
2-593-022	Special2:Size-Env.Correct:BW	Wide Roller:PaperTransfer:Standard:2Sid:S1	EN G	[1 to 110 / 15 / 1/step]
2-593-023	Special2:Size-Env.Correct:BW	Wide Roller:PaperTransfer:Low:1Side:S1	EN G	[1 to 110 / 10 / 1/step]
2-593-024	Special2:Size-Env.Correct:BW	Wide Roller:PaperTransfer:Low:2Side:S1	EN G	[1 to 110 / 15 / 1/step]
2-593-025	Special2:Size-Env.Correct:BW	Wide Roller:PaperTransfer:Standard:1Sid:S2	EN G	[1 to 110 / 11 / 1/step]
2-593-026	Special2:Size-Env.Correct:BW	Wide Roller:PaperTransfer:Standard:2Sid:S2	EN G	[1 to 110 / 16 / 1/step]
2-593-027	Special2:Size-Env.Correct:BW	Wide Roller:PaperTransfer:Low:1Side:S2	EN G	[1 to 110 / 11 / 1/step]
2-593-028	Special2:Size-Env.Correct:BW	Wide Roller:PaperTransfer:Low:2Side:S2	EN G	[1 to 110 / 16 / 1/step]
2-593-029	Special2:Size-Env.Correct:BW	Wide Roller:PaperTransfer:Standard:1Sid:S3	EN G	[1 to 110 / 12 / 1/step]
2-593-	Special2:Size-Env.Correct:BW	Wide Roller:PaperTransfer:Standard:2Sid:S3	EN G	[1 to 110 / 17 / 1/step]

3.SP Mode Tables

SP No.	Large Category	Small Category	EN G or CTL	[Min to Max/Init./Step]
030				
2-593-031	Special2:Size-Env.Correct:BW	Wide Roller:PaperTransfer:Low:1Side:S3	EN G	[1 to 110 / 12 / 1/step]
2-593-032	Special2:Size-Env.Correct:BW	Wide Roller:PaperTransfer:Low:2Side:S3	EN G	[1 to 110 / 17 / 1/step]
2-593-033	Special2:Size-Env.Correct:BW	Wide Roller:PaperTransfer:Standard:1Sid: S4	EN G	[1 to 110 / 13 / 1/step]
2-593-034	Special2:Size-Env.Correct:BW	Wide Roller:PaperTransfer:Standard:2Sid: S4	EN G	[1 to 110 / 18 / 1/step]
2-593-035	Special2:Size-Env.Correct:BW	Wide Roller:PaperTransfer:Low:1Side:S4	EN G	[1 to 110 / 13 / 1/step]
2-593-036	Special2:Size-Env.Correct:BW	Wide Roller:PaperTransfer:Low:2Side:S4	EN G	[1 to 110 / 18 / 1/step]
2-593-037	Special2:Size-Env.Correct:BW	Wide Roller:PaperTransfer:Standard:1Sid: S5	EN G	[1 to 110 / 14 / 1/step]
2-593-038	Special2:Size-Env.Correct:BW	Wide Roller:PaperTransfer:Standard:2Sid: S5	EN G	[1 to 110 / 19 / 1/step]
2-593-	Special2:Size-Env.Correct:BW	Wide Roller:PaperTransfer:Low:1Side:S5	EN G	[1 to 110 / 14 / 1/step]

3.SP Mode Tables

SP No.	Large Category	Small Category	EN G or CTL	[Min to Max/Init./Step]
039				
2-593-040	Special2:Size-Env.Correct:BW	Wide Roller:PaperTransfer:Low:2Side:S5	EN G	[1 to 110 / 19 / 1/step]
2-594-001	Special2:Size-Env.Correct:FC	PaperTransfer:standard:1Sid:S1	EN G	[1 to 110 / 20 / 1/step]
2-594-002	Special2:Size-Env.Correct:FC	PaperTransfer:standard:2Sid:S1	EN G	[1 to 110 / 25 / 1/step]
2-594-003	Special2:Size-Env.Correct:FC	PaperTransfer:Low:1Side:S1	EN G	[1 to 110 / 20 / 1/step]
2-594-004	Special2:Size-Env.Correct:FC	PaperTransfer:Low:2Side:S1	EN G	[1 to 110 / 25 / 1/step]
2-594-005	Special2:Size-Env.Correct:FC	PaperTransfer:standard:1Sid:S2	EN G	[1 to 110 / 21 / 1/step]
2-594-006	Special2:Size-Env.Correct:FC	PaperTransfer:standard:2Sid:S2	EN G	[1 to 110 / 26 / 1/step]
2-594-007	Special2:Size-Env.Correct:FC	PaperTransfer:Low:1Side:S2	EN G	[1 to 110 / 21 / 1/step]
2-594-	Special2:Size-Env.Correct:FC	PaperTransfer:Low:2Side:S2	EN G	[1 to 110 / 26 / 1/step]

3.SP Mode Tables

SP No.	Large Category	Small Category	EN G or CTL	[Min to Max/Init./Step]
008				
2-594-009	Special2:Size-Env.Correct:FC	PaperTransfer:standard:1Sid:S3	EN G	[1 to 110 / 22 / 1/step]
2-594-010	Special2:Size-Env.Correct:FC	PaperTransfer:standard:2Sid:S3	EN G	[1 to 110 / 27 / 1/step]
2-594-011	Special2:Size-Env.Correct:FC	PaperTransfer:Low:1Side:S3	EN G	[1 to 110 / 22 / 1/step]
2-594-012	Special2:Size-Env.Correct:FC	PaperTransfer:Low:2Side:S3	EN G	[1 to 110 / 27 / 1/step]
2-594-013	Special2:Size-Env.Correct:FC	PaperTransfer:standard:1Sid:S4	EN G	[1 to 110 / 23 / 1/step]
2-594-014	Special2:Size-Env.Correct:FC	PaperTransfer:standard:2Sid:S4	EN G	[1 to 110 / 28 / 1/step]
2-594-015	Special2:Size-Env.Correct:FC	PaperTransfer:Low:1Side:S4	EN G	[1 to 110 / 23 / 1/step]
2-594-016	Special2:Size-Env.Correct:FC	PaperTransfer:Low:2Side:S4	EN G	[1 to 110 / 28 / 1/step]
2-594-	Special2:Size-Env.Correct:FC	PaperTransfer:Standard:1Sid:S5	EN G	[1 to 110 / 24 / 1/step]

3.SP Mode Tables

SP No.	Large Category	Small Category	EN G or CTL	[Min to Max/Init./Step]
017				
2-594-018	Special2:Size-Env.Correct:FC	PaperTransfer:Standard:2Sid:S5	EN G	[1 to 110 / 29 / 1/step]
2-594-019	Special2:Size-Env.Correct:FC	PaperTransfer:Low:1Side:S5	EN G	[1 to 110 / 24 / 1/step]
2-594-020	Special2:Size-Env.Correct:FC	PaperTransfer:Low:2Side:S5	EN G	[1 to 110 / 29 / 1/step]
2-594-021	Special2:Size-Env.Correct:FC	Wide Roller:PaperTransfer:Standard:1Sid:S1	EN G	[1 to 110 / 20 / 1/step]
2-594-022	Special2:Size-Env.Correct:FC	Wide Roller:PaperTransfer:Standard:2Sid:S1	EN G	[1 to 110 / 25 / 1/step]
2-594-023	Special2:Size-Env.Correct:FC	Wide Roller:PaperTransfer:Low:1Side:S1	EN G	[1 to 110 / 20 / 1/step]
2-594-024	Special2:Size-Env.Correct:FC	Wide Roller:PaperTransfer:Low:2Side:S1	EN G	[1 to 110 / 25 / 1/step]
2-594-025	Special2:Size-Env.Correct:FC	Wide Roller:PaperTransfer:Standard:1Sid:S2	EN G	[1 to 110 / 21 / 1/step]
2-594-	Special2:Size-Env.Correct:FC	Wide Roller:PaperTransfer:Standard:2Sid:S2	EN G	[1 to 110 / 26 / 1/step]

3.SP Mode Tables

SP No.	Large Category	Small Category	EN G or CTL	[Min to Max/Init./Step]
026				
2-594-027	Special2:Size-Env.Correct:FC	Wide Roller:PaperTransfer:Low:1Side:S2	EN G	[1 to 110 / 21 / 1/step]
2-594-028	Special2:Size-Env.Correct:FC	Wide Roller:PaperTransfer:Low:2Side:S2	EN G	[1 to 110 / 26 / 1/step]
2-594-029	Special2:Size-Env.Correct:FC	Wide Roller:PaperTransfer:Standard:1Sid:S3	EN G	[1 to 110 / 22 / 1/step]
2-594-030	Special2:Size-Env.Correct:FC	Wide Roller:PaperTransfer:Standard:2Sid:S3	EN G	[1 to 110 / 27 / 1/step]
2-594-031	Special2:Size-Env.Correct:FC	Wide Roller:PaperTransfer:Low:1Side:S3	EN G	[1 to 110 / 22 / 1/step]
2-594-032	Special2:Size-Env.Correct:FC	Wide Roller:PaperTransfer:Low:2Side:S3	EN G	[1 to 110 / 27 / 1/step]
2-594-033	Special2:Size-Env.Correct:FC	Wide Roller:PaperTransfer:Standard:1Sid:S4	EN G	[1 to 110 / 23 / 1/step]
2-594-034	Special2:Size-Env.Correct:FC	Wide Roller:PaperTransfer:Standard:2Sid:S4	EN G	[1 to 110 / 28 / 1/step]
2-594-	Special2:Size-Env.Correct:FC	Wide Roller:PaperTransfer:Low:1Side:S4	EN G	[1 to 110 / 23 / 1/step]

3.SP Mode Tables

SP No.	Large Category	Small Category	EN G or CTL	[Min to Max/Init./Step]
035				
2-594-036	Special2:Size-Env.Correct:FC	Wide Roller:PaperTransfer:Low:2Side:S4	EN G	[1 to 110 / 28 / 1/step]
2-594-037	Special2:Size-Env.Correct:FC	Wide Roller:PaperTransfer:Standard:1Side:S5	EN G	[1 to 110 / 24 / 1/step]
2-594-038	Special2:Size-Env.Correct:FC	Wide Roller:PaperTransfer:Standard:2Side:S5	EN G	[1 to 110 / 29 / 1/step]
2-594-039	Special2:Size-Env.Correct:FC	Wide Roller:PaperTransfer:Low:1Side:S5	EN G	[1 to 110 / 24 / 1/step]
2-594-040	Special2:Size-Env.Correct:FC	Wide Roller:PaperTransfer:Low:2Side:S5	EN G	[1 to 110 / 29 / 1/step]
2-595-001	Special2:LeadingEdgeCorrection	PaperTransfer:standard:1Side	EN G	[0 to 995 / 100 / 5%/step]
2-595-002	Special2:LeadingEdgeCorrection	PaperTransfer:standard:2Side	EN G	[0 to 995 / 100 / 5%/step]
2-595-003	Special2:LeadingEdgeCorrection	Paper Transfer:Low:1side	EN G	[0 to 995 / 100 / 5%/step]
2-595-	Special2:LeadingEdgeCorrection	Paper Transfer:Low:2side	EN G	[0 to 995 / 100 / 5%/step]

3.SP Mode Tables

SP No.	Large Category	Small Category	EN G or CTL	[Min to Max/Init./Step]
004				
2-596-001	Special2:SwitchTimingLeadEdge	PaperTransfer:standard:1side	EN G	[0 to 50 / 0 / 2mm/step]
2-596-002	Special2:SwitchTimingLeadEdge	PaperTransfer:standard:2side	EN G	[0 to 50 / 0 / 2mm/step]
2-596-003	Special2:SwitchTimingLeadEdge	Paper Transfer:Low:1side	EN G	[0 to 50 / 0 / 2mm/step]
2-596-004	Special2:SwitchTimingLeadEdge	Paper Transfer:Low:2side	EN G	[0 to 50 / 0 / 2mm/step]
2-597-001	Special2:TrailEdgeCorrection	PaperTransfer:standard:1Side	EN G	[0 to 995 / 100 / 5%/step]
2-597-002	Special2:TrailEdgeCorrection	PaperTransfer:standard:2Side	EN G	[0 to 995 / 100 / 5%/step]
2-597-003	Special2:TrailEdgeCorrection	Paper Transfer:Low:1side	EN G	[0 to 995 / 100 / 5%/step]
2-597-004	Special2:TrailEdgeCorrection	Paper Transfer:Low:2side	EN G	[0 to 995 / 100 / 5%/step]
2-598-	Special2:SwitchTimingTrailEdge	PaperTransfer:standard:1side	EN G	[0 to 50 / 0 / 2mm/step]

3.SP Mode Tables

SP No.	Large Category	Small Category	EN G or CTL	[Min to Max/Init./Step]
001				
2-598-002	Special2:SwitchTimingTrailEdge	PaperTransfer:standard:2side	EN G	[0 to 50 / 0 / 2mm/step]
2-598-003	Special2:SwitchTimingTrailEdge	Paper Transfer:Low:1side	EN G	[0 to 50 / 0 / 2mm/step]
2-598-004	Special2:SwitchTimingTrailEdge	Paper Transfer:Low:2side	EN G	[0 to 50 / 0 / 2mm/step]
2-603-001	Special3:Bias:BW	PaperTransfer:standard:1side	EN G	IM C3500: [0 to 200 / 22 / 1-uA/step] IM C2500: [0 to 200 / 22 / 1-uA/step] IM C2000: [0 to 200 / 22 / 1-uA/step] IM C3000: [0 to 200 / 22 / 1-uA/step]
2-603-002	Special3:Bias:BW	PaperTransfer:standard:2side	EN G	IM C3500: [0 to 200 / 22 / 1-uA/step] IM C2500: [0 to 200 / 22 / 1-uA/step] IM C2000: [0 to 200 / 22 / 1-uA/step] IM C3000: [0 to 200 / 22

3.SP Mode Tables

SP No.	Large Category	Small Category	EN G or CTL	[Min to Max/Init./Step]
				/ 1-uA/step]
2-603-003	Special3:Bias:BW	PaperTransfer:low:1side	EN G	IM C3500: [0 to 200 / 11 / 1-uA/step] IM C2500: [0 to 200 / 11 / 1-uA/step] IM C2000: [0 to 200 / 11 / 1-uA/step] IM C3000: [0 to 200 / 11 / 1-uA/step]
2-603-004	Special3:Bias:BW	PaperTransfer:low:2side	EN G	IM C3500: [0 to 200 / 11 / 1-uA/step] IM C2500: [0 to 200 / 11 / 1-uA/step] IM C2000: [0 to 200 / 11 / 1-uA/step] IM C3000: [0 to 200 / 11 / 1-uA/step]
2-607-001	Special3:Bias:FC	PaperTransfer:standard:1side	EN G	IM C3500: [0 to 200 / 29 / 1-uA/step] IM C2500: [0 to 200 / 29 / 1-uA/step] IM C2000: [0 to 200 / 29 / 1-uA/step] IM C3000: [0 to 200 / 29

3.SP Mode Tables

SP No.	Large Category	Small Category	EN G or CTL	[Min to Max/Init./Step]
				/ 1-uA/step]
2-607-002	Special3:Bias:FC	PaperTransfer:standard:2side	EN G	IM C3500: [0 to 200 / 29 / 1-uA/step] IM C2500: [0 to 200 / 29 / 1-uA/step] IM C2000: [0 to 200 / 29 / 1-uA/step] IM C3000: [0 to 200 / 29 / 1-uA/step]
2-607-003	Special3:Bias:FC	PaperTransfer:low:1side	EN G	IM C3500: [0 to 200 / 14 / 1-uA/step] IM C2500: [0 to 200 / 14 / 1-uA/step] IM C2000: [0 to 200 / 14 / 1-uA/step] IM C3000: [0 to 200 / 14 / 1-uA/step]
2-607-004	Special3:Bias:FC	PaperTransfer:low:2side	EN G	IM C3500: [0 to 200 / 14 / 1-uA/step] IM C2500: [0 to 200 / 14 / 1-uA/step] IM C2000: [0 to 200 / 14 / 1-uA/step] IM C3000: [0 to 200 / 14

3.SP Mode Tables

SP No.	Large Category	Small Category	EN G or CTL	[Min to Max/Init./Step]
				/ 1-uA/step]
2-611-001	Special3:SizeCorrection:BW	PaperTransfer:standard:1Sid:S1	EN G	[100 to 995 / 100 / 1%/step]
2-611-002	Special3:SizeCorrection:BW	PaperTransfer:standard:2Sid:S1	EN G	[100 to 995 / 100 / 1%/step]
2-611-003	Special3:SizeCorrection:BW	PaperTransfer:Low:1Side:S1	EN G	[100 to 995 / 100 / 1%/step]
2-611-004	Special3:SizeCorrection:BW	PaperTransfer:Low:2Side:S1	EN G	[100 to 995 / 100 / 1%/step]
2-611-005	Special3:SizeCorrection:BW	PaperTransfer:standard:1Sid:S2	EN G	[100 to 995 / 100 / 1%/step]
2-611-006	Special3:SizeCorrection:BW	PaperTransfer:standard:2Sid:S2	EN G	[100 to 995 / 105 / 1%/step]
2-611-007	Special3:SizeCorrection:BW	PaperTransfer:Low:1Side:S2	EN G	[100 to 995 / 100 / 1%/step]
2-611-008	Special3:SizeCorrection:BW	PaperTransfer:Low:2Side:S2	EN G	[100 to 995 / 105 / 1%/step]
2-611-	Special3:SizeCorrection:BW	PaperTransfer:standard:1Sid:S3	EN G	[100 to 995 / 105 / 1%/step]

3.SP Mode Tables

SP No.	Large Category	Small Category	EN G or CTL	[Min to Max/Init./Step]
009				
2-611-010	Special3:SizeCorrection:BW	PaperTransfer:standard:2Sid:S3	EN G	[100 to 995 / 118 / 1%/step]
2-611-011	Special3:SizeCorrection:BW	PaperTransfer:Low:1Side:S3	EN G	[100 to 995 / 105 / 1%/step]
2-611-012	Special3:SizeCorrection:BW	PaperTransfer:Low:2Side:S3	EN G	[100 to 995 / 118 / 1%/step]
2-611-013	Special3:SizeCorrection:BW	PaperTransfer:standard:1Sid:S4	EN G	[100 to 995 / 118 / 1%/step]
2-611-014	Special3:SizeCorrection:BW	PaperTransfer:standard:2Sid:S4	EN G	[100 to 995 / 131 / 1%/step]
2-611-015	Special3:SizeCorrection:BW	PaperTransfer:Low:1Side:S4	EN G	[100 to 995 / 118 / 1%/step]
2-611-016	Special3:SizeCorrection:BW	PaperTransfer:Low:2Side:S4	EN G	[100 to 995 / 131 / 1%/step]
2-611-017	Special3:SizeCorrection:BW	PaperTransfer:Standard:1Sid:S5	EN G	[100 to 995 / 132 / 1%/step]
2-611-	Special3:SizeCorrection:BW	PaperTransfer:Standard:2Sid:S5	EN G	[100 to 995 / 184 / 1%/step]

3.SP Mode Tables

SP No.	Large Category	Small Category	EN G or CTL	[Min to Max/Init./Step]
018				
2-611-019	Special3:SizeCorrection:BW	PaperTransfer:Low:1Side:S5	EN G	[100 to 995 / 132 / 1%/step]
2-611-020	Special3:SizeCorrection:BW	PaperTransfer:Low:2Side:S5	EN G	[100 to 995 / 184 / 1%/step]
2-611-021	Special3:SizeCorrection:BW	Wide Roller:PaperTransfer:Standard:1Sid:S1	EN G	[100 to 995 / 100 / 1%/step]
2-611-022	Special3:SizeCorrection:BW	Wide Roller:PaperTransfer:Standard:2Sid:S1	EN G	[100 to 995 / 100 / 1%/step]
2-611-023	Special3:SizeCorrection:BW	Wide Roller:PaperTransfer:Low:1Side:S1	EN G	[100 to 995 / 100 / 1%/step]
2-611-024	Special3:SizeCorrection:BW	Wide Roller:PaperTransfer:Low:2Side:S1	EN G	[100 to 995 / 100 / 1%/step]
2-611-025	Special3:SizeCorrection:BW	Wide Roller:PaperTransfer:Standard:1Sid:S2	EN G	[100 to 995 / 100 / 1%/step]
2-611-026	Special3:SizeCorrection:BW	Wide Roller:PaperTransfer:Standard:2Sid:S2	EN G	[100 to 995 / 105 / 1%/step]
2-611-	Special3:SizeCorrection:BW	Wide Roller:PaperTransfer:Low:1Side:S2	EN G	[100 to 995 / 100 / 1%/step]

3.SP Mode Tables

SP No.	Large Category	Small Category	EN G or CTL	[Min to Max/Init./Step]
027				
2-611-028	Special3:SizeCorrection:BW	Wide Roller:PaperTransfer:Low:2Side:S2	EN G	[100 to 995 / 105 / 1%/step]
2-611-029	Special3:SizeCorrection:BW	Wide Roller:PaperTransfer:Standard:1Sid:S3	EN G	[100 to 995 / 105 / 1%/step]
2-611-030	Special3:SizeCorrection:BW	Wide Roller:PaperTransfer:Standard:2Sid:S3	EN G	[100 to 995 / 118 / 1%/step]
2-611-031	Special3:SizeCorrection:BW	Wide Roller:PaperTransfer:Low:1Side:S3	EN G	[100 to 995 / 105 / 1%/step]
2-611-032	Special3:SizeCorrection:BW	Wide Roller:PaperTransfer:Low:2Side:S3	EN G	[100 to 995 / 118 / 1%/step]
2-611-033	Special3:SizeCorrection:BW	Wide Roller:PaperTransfer:Standard:1Sid:S4	EN G	[100 to 995 / 118 / 1%/step]
2-611-034	Special3:SizeCorrection:BW	Wide Roller:PaperTransfer:Standard:2Sid:S4	EN G	[100 to 995 / 131 / 1%/step]
2-611-035	Special3:SizeCorrection:BW	Wide Roller:PaperTransfer:Low:1Side:S4	EN G	[100 to 995 / 118 / 1%/step]
2-611-	Special3:SizeCorrection:BW	Wide Roller:PaperTransfer:Low:2Side:S4	EN G	[100 to 995 / 131 / 1%/step]

3.SP Mode Tables

SP No.	Large Category	Small Category	EN G or CTL	[Min to Max/Init./Step]
036				
2-611-037	Special3:SizeCorrection:BW	Wide Roller:PaperTransfer:Standard:1Sid:S5	EN G	[100 to 995 / 132 / 1%/step]
2-611-038	Special3:SizeCorrection:BW	Wide Roller:PaperTransfer:Standard:2Sid:S5	EN G	[100 to 995 / 184 / 1%/step]
2-611-039	Special3:SizeCorrection:BW	Wide Roller:PaperTransfer:Low:1Side:S5	EN G	[100 to 995 / 132 / 1%/step]
2-611-040	Special3:SizeCorrection:BW	Wide Roller:PaperTransfer:Low:2Side:S5	EN G	[100 to 995 / 184 / 1%/step]
2-612-001	Special3:SizeCorrection:FC	PaperTransfer:standard:1Sid:S1	EN G	[100 to 995 / 100 / 1%/step]
2-612-002	Special3:SizeCorrection:FC	PaperTransfer:standard:2Sid:S1	EN G	[100 to 995 / 100 / 1%/step]
2-612-003	Special3:SizeCorrection:FC	PaperTransfer:Low:1Side:S1	EN G	[100 to 995 / 100 / 1%/step]
2-612-004	Special3:SizeCorrection:FC	PaperTransfer:Low:2Side:S1	EN G	[100 to 995 / 100 / 1%/step]
2-612-	Special3:SizeCorrection:FC	PaperTransfer:standard:1Sid:S2	EN G	[100 to 995 / 120 / 1%/step]

3.SP Mode Tables

SP No.	Large Category	Small Category	EN G or CTL	[Min to Max/Init./Step]
005				
2-612-006	Special3:SizeCorrection:FC	PaperTransfer:standard:2Sid:S2	EN G	[100 to 995 / 140 / 1%/step]
2-612-007	Special3:SizeCorrection:FC	PaperTransfer:Low:1Side:S2	EN G	[100 to 995 / 120 / 1%/step]
2-612-008	Special3:SizeCorrection:FC	PaperTransfer:Low:2Side:S2	EN G	[100 to 995 / 140 / 1%/step]
2-612-009	Special3:SizeCorrection:FC	PaperTransfer:standard:1Sid:S3	EN G	[100 to 995 / 118 / 1%/step]
2-612-010	Special3:SizeCorrection:FC	PaperTransfer:standard:2Sid:S3	EN G	[100 to 995 / 180 / 1%/step]
2-612-011	Special3:SizeCorrection:FC	PaperTransfer:Low:1Side:S3	EN G	[100 to 995 / 118 / 1%/step]
2-612-012	Special3:SizeCorrection:FC	PaperTransfer:Low:2Side:S3	EN G	[100 to 995 / 180 / 1%/step]
2-612-013	Special3:SizeCorrection:FC	PaperTransfer:standard:1Sid:S4	EN G	[100 to 995 / 130 / 1%/step]
2-612-	Special3:SizeCorrection:FC	PaperTransfer:standard:2Sid:S4	EN G	[100 to 995 / 200 / 1%/step]

3.SP Mode Tables

SP No.	Large Category	Small Category	EN G or CTL	[Min to Max/Init./Step]
014				
2-612-015	Special3:SizeCorrection:FC	PaperTransfer:Low:1Side:S4	EN G	[100 to 995 / 130 / 1%/step]
2-612-016	Special3:SizeCorrection:FC	PaperTransfer:Low:2Side:S4	EN G	[100 to 995 / 200 / 1%/step]
2-612-017	Special3:SizeCorrection:FC	PaperTransfer:Standard:1Sid:S5	EN G	[100 to 995 / 140 / 1%/step]
2-612-018	Special3:SizeCorrection:FC	PaperTransfer:Standard:2Sid:S5	EN G	[100 to 995 / 240 / 1%/step]
2-612-019	Special3:SizeCorrection:FC	PaperTransfer:Low:1Side:S5	EN G	[100 to 995 / 140 / 1%/step]
2-612-020	Special3:SizeCorrection:FC	PaperTransfer:Low:2Side:S5	EN G	[100 to 995 / 240 / 1%/step]
2-612-021	Special3:SizeCorrection:FC	Wide Roller:PaperTransfer:Standard:1Sid:S1	EN G	[100 to 995 / 100 / 1%/step]
2-612-022	Special3:SizeCorrection:FC	Wide Roller:PaperTransfer:Standard:2Sid:S1	EN G	[100 to 995 / 100 / 1%/step]
2-612-	Special3:SizeCorrection:FC	Wide Roller:PaperTransfer:Low:1Side:S1	EN G	[100 to 995 / 100 / 1%/step]

3.SP Mode Tables

SP No.	Large Category	Small Category	EN G or CTL	[Min to Max/Init./Step]
023				
2-612-024	Special3:SizeCorrection:FC	Wide Roller:PaperTransfer:Low:2Side:S1	EN G	[100 to 995 / 100 / 1%/step]
2-612-025	Special3:SizeCorrection:FC	Wide Roller:PaperTransfer:Standard:1Sid:S2	EN G	[100 to 995 / 120 / 1%/step]
2-612-026	Special3:SizeCorrection:FC	Wide Roller:PaperTransfer:Standard:2Sid:S2	EN G	[100 to 995 / 140 / 1%/step]
2-612-027	Special3:SizeCorrection:FC	Wide Roller:PaperTransfer:Low:1Side:S2	EN G	[100 to 995 / 120 / 1%/step]
2-612-028	Special3:SizeCorrection:FC	Wide Roller:PaperTransfer:Low:2Side:S2	EN G	[100 to 995 / 140 / 1%/step]
2-612-029	Special3:SizeCorrection:FC	Wide Roller:PaperTransfer:Standard:1Sid:S3	EN G	[100 to 995 / 118 / 1%/step]
2-612-030	Special3:SizeCorrection:FC	Wide Roller:PaperTransfer:Standard:2Sid:S3	EN G	[100 to 995 / 180 / 1%/step]
2-612-031	Special3:SizeCorrection:FC	Wide Roller:PaperTransfer:Low:1Side:S3	EN G	[100 to 995 / 118 / 1%/step]
2-612-	Special3:SizeCorrection:FC	Wide Roller:PaperTransfer:Low:2Side:S3	EN G	[100 to 995 / 180 / 1%/step]

3.SP Mode Tables

SP No.	Large Category	Small Category	EN G or CTL	[Min to Max/Init./Step]
032				
2-612-033	Special3:SizeCorrection:FC	Wide Roller:PaperTransfer:Standard:1Sid:S4	EN G	[100 to 995 / 130 / 1%/step]
2-612-034	Special3:SizeCorrection:FC	Wide Roller:PaperTransfer:Standard:2Sid:S4	EN G	[100 to 995 / 200 / 1%/step]
2-612-035	Special3:SizeCorrection:FC	Wide Roller:PaperTransfer:Low:1Side:S4	EN G	[100 to 995 / 130 / 1%/step]
2-612-036	Special3:SizeCorrection:FC	Wide Roller:PaperTransfer:Low:2Side:S4	EN G	[100 to 995 / 200 / 1%/step]
2-612-037	Special3:SizeCorrection:FC	Wide Roller:PaperTransfer:Standard:1Sid:S5	EN G	[100 to 995 / 140 / 1%/step]
2-612-038	Special3:SizeCorrection:FC	Wide Roller:PaperTransfer:Standard:2Sid:S5	EN G	[100 to 995 / 240 / 1%/step]
2-612-039	Special3:SizeCorrection:FC	Wide Roller:PaperTransfer:Low:1Side:S5	EN G	[100 to 995 / 140 / 1%/step]
2-612-040	Special3:SizeCorrection:FC	Wide Roller:PaperTransfer:Low:2Side:S5	EN G	[100 to 995 / 240 / 1%/step]
2-613-	Special3:Size-Env.Correct:BW	PaperTransfer:standard:1Sid:S1	EN G	[1 to 110 / 10 / 1/step]

3.SP Mode Tables

SP No.	Large Category	Small Category	EN G or CTL	[Min to Max/Init./Step]
001				
2-613-002	Special3:Size-Env.Correct:BW	PaperTransfer:standard:2Sid:S1	EN G	[1 to 110 / 15 / 1/step]
2-613-003	Special3:Size-Env.Correct:BW	PaperTransfer:Low:1Side:S1	EN G	[1 to 110 / 10 / 1/step]
2-613-004	Special3:Size-Env.Correct:BW	PaperTransfer:Low:2Side:S1	EN G	[1 to 110 / 15 / 1/step]
2-613-005	Special3:Size-Env.Correct:BW	PaperTransfer:standard:1Sid:S2	EN G	[1 to 110 / 11 / 1/step]
2-613-006	Special3:Size-Env.Correct:BW	PaperTransfer:standard:2Sid:S2	EN G	[1 to 110 / 16 / 1/step]
2-613-007	Special3:Size-Env.Correct:BW	PaperTransfer:Low:1Side:S2	EN G	[1 to 110 / 11 / 1/step]
2-613-008	Special3:Size-Env.Correct:BW	PaperTransfer:Low:2Side:S2	EN G	[1 to 110 / 16 / 1/step]
2-613-009	Special3:Size-Env.Correct:BW	PaperTransfer:standard:1Sid:S3	EN G	[1 to 110 / 12 / 1/step]
2-613-	Special3:Size-Env.Correct:BW	PaperTransfer:standard:2Sid:S3	EN G	[1 to 110 / 17 / 1/step]

3.SP Mode Tables

SP No.	Large Category	Small Category	EN G or CTL	[Min to Max/Init./Step]
010				
2-613-011	Special3:Size-Env.Correct:BW	PaperTransfer:Low:1Side:S3	EN G	[1 to 110 / 12 / 1/step]
2-613-012	Special3:Size-Env.Correct:BW	PaperTransfer:Low:2Side:S3	EN G	[1 to 110 / 17 / 1/step]
2-613-013	Special3:Size-Env.Correct:BW	PaperTransfer:standard:1Sid:S4	EN G	[1 to 110 / 13 / 1/step]
2-613-014	Special3:Size-Env.Correct:BW	PaperTransfer:standard:2Sid:S4	EN G	[1 to 110 / 18 / 1/step]
2-613-015	Special3:Size-Env.Correct:BW	PaperTransfer:Low:1Side:S4	EN G	[1 to 110 / 13 / 1/step]
2-613-016	Special3:Size-Env.Correct:BW	PaperTransfer:Low:2Side:S4	EN G	[1 to 110 / 18 / 1/step]
2-613-017	Special3:Size-Env.Correct:BW	PaperTransfer:Standard:1Sid:S5	EN G	[1 to 110 / 14 / 1/step]
2-613-018	Special3:Size-Env.Correct:BW	PaperTransfer:Standard:2Sid:S5	EN G	[1 to 110 / 19 / 1/step]
2-613-	Special3:Size-Env.Correct:BW	PaperTransfer:Low:1Side:S5	EN G	[1 to 110 / 14 / 1/step]

3.SP Mode Tables

SP No.	Large Category	Small Category	EN G or CTL	[Min to Max/Init./Step]
019				
2-613-020	Special3:Size-Env.Correct:BW	PaperTransfer:Low:2Side:S5	EN G	[1 to 110 / 19 / 1/step]
2-613-021	Special3:Size-Env.Correct:BW	Wide Roller:PaperTransfer:Standard:1Side:S1	EN G	[1 to 110 / 10 / 1/step]
2-613-022	Special3:Size-Env.Correct:BW	Wide Roller:PaperTransfer:Standard:2Side:S1	EN G	[1 to 110 / 15 / 1/step]
2-613-023	Special3:Size-Env.Correct:BW	Wide Roller:PaperTransfer:Low:1Side:S1	EN G	[1 to 110 / 10 / 1/step]
2-613-024	Special3:Size-Env.Correct:BW	Wide Roller:PaperTransfer:Low:2Side:S1	EN G	[1 to 110 / 15 / 1/step]
2-613-025	Special3:Size-Env.Correct:BW	Wide Roller:PaperTransfer:Standard:1Side:S2	EN G	[1 to 110 / 11 / 1/step]
2-613-026	Special3:Size-Env.Correct:BW	Wide Roller:PaperTransfer:Standard:2Side:S2	EN G	[1 to 110 / 16 / 1/step]
2-613-027	Special3:Size-Env.Correct:BW	Wide Roller:PaperTransfer:Low:1Side:S2	EN G	[1 to 110 / 11 / 1/step]
2-613-	Special3:Size-Env.Correct:BW	Wide Roller:PaperTransfer:Low:2Side:S2	EN G	[1 to 110 / 16 / 1/step]

3.SP Mode Tables

SP No.	Large Category	Small Category	EN G or CTL	[Min to Max/Init./Step]
028				
2-613-029	Special3:Size-Env.Correct:BW	Wide Roller:PaperTransfer:Standard:1Sid:S3	EN G	[1 to 110 / 12 / 1/step]
2-613-030	Special3:Size-Env.Correct:BW	Wide Roller:PaperTransfer:Standard:2Sid:S3	EN G	[1 to 110 / 17 / 1/step]
2-613-031	Special3:Size-Env.Correct:BW	Wide Roller:PaperTransfer:Low:1Side:S3	EN G	[1 to 110 / 12 / 1/step]
2-613-032	Special3:Size-Env.Correct:BW	Wide Roller:PaperTransfer:Low:2Side:S3	EN G	[1 to 110 / 17 / 1/step]
2-613-033	Special3:Size-Env.Correct:BW	Wide Roller:PaperTransfer:Standard:1Sid:S4	EN G	[1 to 110 / 13 / 1/step]
2-613-034	Special3:Size-Env.Correct:BW	Wide Roller:PaperTransfer:Standard:2Sid:S4	EN G	[1 to 110 / 18 / 1/step]
2-613-035	Special3:Size-Env.Correct:BW	Wide Roller:PaperTransfer:Low:1Side:S4	EN G	[1 to 110 / 13 / 1/step]
2-613-036	Special3:Size-Env.Correct:BW	Wide Roller:PaperTransfer:Low:2Side:S4	EN G	[1 to 110 / 18 / 1/step]
2-613-	Special3:Size-Env.Correct:BW	Wide Roller:PaperTransfer:Standard:1Sid:S5	EN G	[1 to 110 / 14 / 1/step]

3.SP Mode Tables

SP No.	Large Category	Small Category	EN G or CTL	[Min to Max/Init./Step]
037				
2-613-038	Special3:Size-Env.Correct:BW	Wide Roller:PaperTransfer:Standard:2Sid:S5	EN G	[1 to 110 / 19 / 1/step]
2-613-039	Special3:Size-Env.Correct:BW	Wide Roller:PaperTransfer:Low:1Side:S5	EN G	[1 to 110 / 14 / 1/step]
2-613-040	Special3:Size-Env.Correct:BW	Wide Roller:PaperTransfer:Low:2Side:S5	EN G	[1 to 110 / 19 / 1/step]
2-614-001	Special3:Size-Env.Correct:FC	PaperTransfer:standard:1Sid:S1	EN G	[1 to 110 / 20 / 1/step]
2-614-002	Special3:Size-Env.Correct:FC	PaperTransfer:standard:2Sid:S1	EN G	[1 to 110 / 25 / 1/step]
2-614-003	Special3:Size-Env.Correct:FC	PaperTransfer:Low:1Side:S1	EN G	[1 to 110 / 20 / 1/step]
2-614-004	Special3:Size-Env.Correct:FC	PaperTransfer:Low:2Side:S1	EN G	[1 to 110 / 25 / 1/step]
2-614-005	Special3:Size-Env.Correct:FC	PaperTransfer:standard:1Sid:S2	EN G	[1 to 110 / 21 / 1/step]
2-614-	Special3:Size-Env.Correct:FC	PaperTransfer:standard:2Sid:S2	EN G	[1 to 110 / 26 / 1/step]

3.SP Mode Tables

SP No.	Large Category	Small Category	EN G or CTL	[Min to Max/Init./Step]
006				
2-614-007	Special3:Size-Env.Correct:FC	PaperTransfer:Low:1Side:S2	EN G	[1 to 110 / 21 / 1/step]
2-614-008	Special3:Size-Env.Correct:FC	PaperTransfer:Low:2Side:S2	EN G	[1 to 110 / 26 / 1/step]
2-614-009	Special3:Size-Env.Correct:FC	PaperTransfer:standard:1Sid:S3	EN G	[1 to 110 / 22 / 1/step]
2-614-010	Special3:Size-Env.Correct:FC	PaperTransfer:standard:2Sid:S3	EN G	[1 to 110 / 27 / 1/step]
2-614-011	Special3:Size-Env.Correct:FC	PaperTransfer:Low:1Side:S3	EN G	[1 to 110 / 22 / 1/step]
2-614-012	Special3:Size-Env.Correct:FC	PaperTransfer:Low:2Side:S3	EN G	[1 to 110 / 27 / 1/step]
2-614-013	Special3:Size-Env.Correct:FC	PaperTransfer:standard:1Sid:S4	EN G	[1 to 110 / 23 / 1/step]
2-614-014	Special3:Size-Env.Correct:FC	PaperTransfer:standard:2Sid:S4	EN G	[1 to 110 / 28 / 1/step]
2-614-	Special3:Size-Env.Correct:FC	PaperTransfer:Low:1Side:S4	EN G	[1 to 110 / 23 / 1/step]

3.SP Mode Tables

SP No.	Large Category	Small Category	EN G or CTL	[Min to Max/Init./Step]
015				
2-614-016	Special3:Size-Env.Correct:FC	PaperTransfer:Low:2Side:S4	EN G	[1 to 110 / 28 / 1/step]
2-614-017	Special3:Size-Env.Correct:FC	PaperTransfer:Standard:1Sid:S5	EN G	[1 to 110 / 24 / 1/step]
2-614-018	Special3:Size-Env.Correct:FC	PaperTransfer:Standard:2Sid:S5	EN G	[1 to 110 / 29 / 1/step]
2-614-019	Special3:Size-Env.Correct:FC	PaperTransfer:Low:1Side:S5	EN G	[1 to 110 / 24 / 1/step]
2-614-020	Special3:Size-Env.Correct:FC	PaperTransfer:Low:2Side:S5	EN G	[1 to 110 / 29 / 1/step]
2-614-021	Special3:Size-Env.Correct:FC	Wide Roller:PaperTransfer:Standard:1Sid:S1	EN G	[1 to 110 / 20 / 1/step]
2-614-022	Special3:Size-Env.Correct:FC	Wide Roller:PaperTransfer:Standard:2Sid:S1	EN G	[1 to 110 / 25 / 1/step]
2-614-023	Special3:Size-Env.Correct:FC	Wide Roller:PaperTransfer:Low:1Side:S1	EN G	[1 to 110 / 20 / 1/step]
2-614-	Special3:Size-Env.Correct:FC	Wide Roller:PaperTransfer:Low:2Side:S1	EN G	[1 to 110 / 25 / 1/step]

3.SP Mode Tables

SP No.	Large Category	Small Category	EN G or CTL	[Min to Max/Init./Step]
024				
2-614-025	Special3:Size-Env.Correct:FC	Wide Roller:PaperTransfer:Standard:1Sid:S2	EN G	[1 to 110 / 21 / 1/step]
2-614-026	Special3:Size-Env.Correct:FC	Wide Roller:PaperTransfer:Standard:2Sid:S2	EN G	[1 to 110 / 26 / 1/step]
2-614-027	Special3:Size-Env.Correct:FC	Wide Roller:PaperTransfer:Low:1Side:S2	EN G	[1 to 110 / 21 / 1/step]
2-614-028	Special3:Size-Env.Correct:FC	Wide Roller:PaperTransfer:Low:2Side:S2	EN G	[1 to 110 / 26 / 1/step]
2-614-029	Special3:Size-Env.Correct:FC	Wide Roller:PaperTransfer:Standard:1Sid:S3	EN G	[1 to 110 / 22 / 1/step]
2-614-030	Special3:Size-Env.Correct:FC	Wide Roller:PaperTransfer:Standard:2Sid:S3	EN G	[1 to 110 / 27 / 1/step]
2-614-031	Special3:Size-Env.Correct:FC	Wide Roller:PaperTransfer:Low:1Side:S3	EN G	[1 to 110 / 22 / 1/step]
2-614-032	Special3:Size-Env.Correct:FC	Wide Roller:PaperTransfer:Low:2Side:S3	EN G	[1 to 110 / 27 / 1/step]
2-614-	Special3:Size-Env.Correct:FC	Wide Roller:PaperTransfer:Standard:1Sid:S4	EN G	[1 to 110 / 23 / 1/step]

3.SP Mode Tables

SP No.	Large Category	Small Category	EN G or CTL	[Min to Max/Init./Step]
033				
2-614-034	Special3:Size-Env.Correct:FC	Wide Roller:PaperTransfer:Standard:2Sid:S4	EN G	[1 to 110 / 28 / 1/step]
2-614-035	Special3:Size-Env.Correct:FC	Wide Roller:PaperTransfer:Low:1Side:S4	EN G	[1 to 110 / 23 / 1/step]
2-614-036	Special3:Size-Env.Correct:FC	Wide Roller:PaperTransfer:Low:2Side:S4	EN G	[1 to 110 / 28 / 1/step]
2-614-037	Special3:Size-Env.Correct:FC	Wide Roller:PaperTransfer:Standard:1Sid:S5	EN G	[1 to 110 / 24 / 1/step]
2-614-038	Special3:Size-Env.Correct:FC	Wide Roller:PaperTransfer:Standard:2Sid:S5	EN G	[1 to 110 / 29 / 1/step]
2-614-039	Special3:Size-Env.Correct:FC	Wide Roller:PaperTransfer:Low:1Side:S5	EN G	[1 to 110 / 24 / 1/step]
2-614-040	Special3:Size-Env.Correct:FC	Wide Roller:PaperTransfer:Low:2Side:S5	EN G	[1 to 110 / 29 / 1/step]
2-615-001	Special3:LeadingEdgeCorrection	Paper Transfer:standard:1side	EN G	[0 to 995 / 100 / 5%/step]
2-615-	Special3:LeadingEdgeCorrection	Paper Transfer:standard:2side	EN G	[0 to 995 / 100 / 5%/step]

3.SP Mode Tables

SP No.	Large Category	Small Category	EN G or CTL	[Min to Max/Init./Step]
002				
2-615-003	Special3:LeadingEdgeCorrection	Paper Transfer:Low:1side	EN G	[0 to 995 / 100 / 5%/step]
2-615-004	Special3:LeadingEdgeCorrection	Paper Transfer:Low:2side	EN G	[0 to 995 / 100 / 5%/step]
2-616-001	Special3:SwitchTimingLeadEdge	Paper Transfer:standard:1side	EN G	[0 to 50 / 0 / 2mm/step]
2-616-002	Special3:SwitchTimingLeadEdge	Paper Transfer:standard:2side	EN G	[0 to 50 / 0 / 2mm/step]
2-616-003	Special3:SwitchTimingLeadEdge	Paper Transfer:Low:1side	EN G	[0 to 50 / 0 / 2mm/step]
2-616-004	Special3:SwitchTimingLeadEdge	Paper Transfer:Low:2side	EN G	[0 to 50 / 0 / 2mm/step]
2-617-001	Special3:TrailEdgeCorrection	Paper Transfer:standard:1side	EN G	[0 to 995 / 100 / 5%/step]
2-617-002	Special3:TrailEdgeCorrection	Paper Transfer:standard:2side	EN G	[0 to 995 / 100 / 5%/step]
2-617-	Special3:TrailEdgeCorrection	Paper Transfer:Low:1side	EN G	[0 to 995 / 100 / 5%/step]

3.SP Mode Tables

SP No.	Large Category	Small Category	EN G or CTL	[Min to Max/Init./Step]
003				
2-617-004	Special3:TrailEdgeCorrection	Paper Transfer:Low:2side	EN G	[0 to 995 / 100 / 5%/step]
2-618-001	Special3:SwitchTimingTrailEdge	Paper Transfer:standard:1side	EN G	[0 to 50 / 0 / 2mm/step]
2-618-002	Special3:SwitchTimingTrailEdge	Paper Transfer:standard:2side	EN G	[0 to 50 / 0 / 2mm/step]
2-618-003	Special3:SwitchTimingTrailEdge	Paper Transfer:Low:1side	EN G	[0 to 50 / 0 / 2mm/step]
2-618-004	Special3:SwitchTimingTrailEdge	Paper Transfer:Low:2side	EN G	[0 to 50 / 0 / 2mm/step]

SP2-XXX (Drum) - 4

SP No.	Large Category	Small Category	ENG or CTL	[Min to Max/Init./Step]
2-623-003	Special1 Thick:Bias:BW	PaperTransfer:1side	ENG	IM C3500: [0 to 200 / 11 / 1-uA/step] IM C2500: [0 to 200 / 11 / 1-uA/step] IM C2000: [0 to 200 / 11 / 1-uA/step] IM C3000:

3.SP Mode Tables

SP No.	Large Category	Small Category	ENG or CTL	[Min to Max/Init./Step]
				[0 to 200 / 11 / 1-uA/step]
2-623-004	Special1 Thick:Bias:BW	PaperTransfer:2side	ENG	IM C3500: [0 to 200 / 15 / 1-uA/step] IM C2500: [0 to 200 / 15 / 1-uA/step] IM C2000: [0 to 200 / 15 / 1-uA/step] IM C3000: [0 to 200 / 15 / 1-uA/step]
2-627-003	Special1 Thick:Bias:FC	PaperTransfer:1side	ENG	IM C3500: [0 to 200 / 19 / 1-uA/step] IM C2500: [0 to 200 / 19 / 1-uA/step] IM C2000: [0 to 200 / 19 / 1-uA/step] IM C3000: [0 to 200 / 19 / 1-uA/step]
2-627-004	Special1 Thick:Bias:FC	PaperTransfer:2side	ENG	IM C3500: [0 to 200 / 21 / 1-uA/step] IM C2500: [0 to 200 / 21 / 1-uA/step] IM C2000: [0 to 200 / 21 / 1-uA/step] IM C3000:

3.SP Mode Tables

SP No.	Large Category	Small Category	ENG or CTL	[Min to Max/Init./Step]
				[0 to 200 / 21 / 1-uA/step]
2-631-003	Special1Thick:PaperSizeCorr:BW	PaperTransfer:1Side:S1	ENG	[100 to 995 / 100 / 1%/step]
2-631-004	Special1Thick:PaperSizeCorr:BW	PaperTransfer:2Side:S1	ENG	[100 to 995 / 100 / 1%/step]
2-631-007	Special1Thick:PaperSizeCorr:BW	PaperTransfer:1Side:S2	ENG	[100 to 995 / 100 / 1%/step]
2-631-008	Special1Thick:PaperSizeCorr:BW	PaperTransfer:2Side:S2	ENG	[100 to 995 / 133 / 1%/step]
2-631-011	Special1Thick:PaperSizeCorr:BW	PaperTransfer:1Side:S3	ENG	[100 to 995 / 100 / 1%/step]
2-631-012	Special1Thick:PaperSizeCorr:BW	PaperTransfer:2Side:S3	ENG	[100 to 995 / 167 / 1%/step]
2-631-015	Special1Thick:PaperSizeCorr:BW	PaperTransfer:1Side:S4	ENG	[100 to 995 / 100 / 1%/step]
2-631-016	Special1Thick:PaperSizeCorr:BW	PaperTransfer:2Side:S4	ENG	[100 to 995 / 233 / 1%/step]
2-631-019	Special1Thick:PaperSizeCorr:BW	PaperTransfer:1Side:S5	ENG	[100 to 995 / 100 / 1%/step]
2-631-020	Special1Thick:PaperSizeCorr:BW	PaperTransfer:2Side:S5	ENG	[100 to 995 / 267 / 1%/step]
2-631-023	Special1Thick:PaperSizeCorr:BW	Wide Roller:PaperTransfer:1Side:S1	ENG	[100 to 995 / 100 / 1%/step]

3.SP Mode Tables

SP No.	Large Category	Small Category	ENG or CTL	[Min to Max/Init./Step]
2-631-024	Special1Thick:PaperSizeCorr:BW	Wide Roller:PaperTransfer:2Side:S1	ENG	[100 to 995 / 100 / 1%/step]
2-631-027	Special1Thick:PaperSizeCorr:BW	Wide Roller:PaperTransfer:1Side:S2	ENG	[100 to 995 / 100 / 1%/step]
2-631-028	Special1Thick:PaperSizeCorr:BW	Wide Roller:PaperTransfer:2Side:S2	ENG	[100 to 995 / 133 / 1%/step]
2-631-031	Special1Thick:PaperSizeCorr:BW	Wide Roller:PaperTransfer:1Side:S3	ENG	[100 to 995 / 100 / 1%/step]
2-631-032	Special1Thick:PaperSizeCorr:BW	Wide Roller:PaperTransfer:2Side:S3	ENG	[100 to 995 / 167 / 1%/step]
2-631-035	Special1Thick:PaperSizeCorr:BW	Wide Roller:PaperTransfer:1Side:S4	ENG	[100 to 995 / 100 / 1%/step]
2-631-036	Special1Thick:PaperSizeCorr:BW	Wide Roller:PaperTransfer:2Side:S4	ENG	[100 to 995 / 233 / 1%/step]
2-631-039	Special1Thick:PaperSizeCorr:BW	Wide Roller:PaperTransfer:1Side:S5	ENG	[100 to 995 / 100 / 1%/step]
2-631-040	Special1Thick:PaperSizeCorr:BW	Wide Roller:PaperTransfer:2Side:S5	ENG	[100 to 995 / 267 / 1%/step]
2-632-003	Special1Thick:PaperSizeCorr:FC	PaperTransfer:1Side:S1	ENG	[100 to 995 / 100 / 1%/step]
2-632-004	Special1Thick:PaperSizeCorr:FC	PaperTransfer:2Side:S1	ENG	[100 to 995 / 100 / 1%/step]
2-632-007	Special1Thick:PaperSizeCorr:FC	PaperTransfer:1Side:S2	ENG	[100 to 995 / 100 / 1%/step]

3.SP Mode Tables

SP No.	Large Category	Small Category	ENG or CTL	[Min to Max/Init./Step]
2-632-008	Special1Thick:PaperSizeCorr:FC	PaperTransfer:2Side:S2	ENG	[100 to 995 / 181 / 1%/step]
2-632-011	Special1Thick:PaperSizeCorr:FC	PaperTransfer:1Side:S3	ENG	[100 to 995 / 100 / 1%/step]
2-632-012	Special1Thick:PaperSizeCorr:FC	PaperTransfer:2Side:S3	ENG	[100 to 995 / 229 / 1%/step]
2-632-015	Special1Thick:PaperSizeCorr:FC	PaperTransfer:1Side:S4	ENG	[100 to 995 / 100 / 1%/step]
2-632-016	Special1Thick:PaperSizeCorr:FC	PaperTransfer:2Side:S4	ENG	[100 to 995 / 286 / 1%/step]
2-632-019	Special1Thick:PaperSizeCorr:FC	PaperTransfer:1Side:S5	ENG	[100 to 995 / 100 / 1%/step]
2-632-020	Special1Thick:PaperSizeCorr:FC	PaperTransfer:2Side:S5	ENG	[100 to 995 / 381 / 1%/step]
2-632-023	Special1Thick:PaperSizeCorr:FC	Wide Roller:PaperTransfer:1Side:S1	ENG	[100 to 995 / 100 / 1%/step]
2-632-024	Special1Thick:PaperSizeCorr:FC	Wide Roller:PaperTransfer:2Side:S1	ENG	[100 to 995 / 100 / 1%/step]
2-632-027	Special1Thick:PaperSizeCorr:FC	Wide Roller:PaperTransfer:1Side:S2	ENG	[100 to 995 / 100 / 1%/step]
2-632-028	Special1Thick:PaperSizeCorr:FC	Wide Roller:PaperTransfer:2Side:S2	ENG	[100 to 995 / 181 / 1%/step]
2-632-031	Special1Thick:PaperSizeCorr:FC	Wide Roller:PaperTransfer:1Side:S3	ENG	[100 to 995 / 100 / 1%/step]

3.SP Mode Tables

SP No.	Large Category	Small Category	ENG or CTL	[Min to Max/Init./Step]
2-632-032	Special1Thick:PaperSizeCorr:FC	Wide Roller:PaperTransfer:2Side:S3	ENG	[100 to 995 / 229 / 1%/step]
2-632-035	Special1Thick:PaperSizeCorr:FC	Wide Roller:PaperTransfer:1Side:S4	ENG	[100 to 995 / 100 / 1%/step]
2-632-036	Special1Thick:PaperSizeCorr:FC	Wide Roller:PaperTransfer:2Side:S4	ENG	[100 to 995 / 286 / 1%/step]
2-632-039	Special1Thick:PaperSizeCorr:FC	Wide Roller:PaperTransfer:1Side:S5	ENG	[100 to 995 / 100 / 1%/step]
2-632-040	Special1Thick:PaperSizeCorr:FC	Wide Roller:PaperTransfer:2Side:S5	ENG	[100 to 995 / 381 / 1%/step]
2-633-003	Sp1Thick:PaperSizeEnvCorr:BW	PaperTransfer:1Side:S1	ENG	[1 to 110 / 85 / 1/step]
2-633-004	Sp1Thick:PaperSizeEnvCorr:BW	PaperTransfer:2Side:S1	ENG	[1 to 110 / 87 / 1/step]
2-633-007	Sp1Thick:PaperSizeEnvCorr:BW	PaperTransfer:1Side:S2	ENG	[1 to 110 / 86 / 1/step]
2-633-008	Sp1Thick:PaperSizeEnvCorr:BW	PaperTransfer:2Side:S2	ENG	[1 to 110 / 88 / 1/step]
2-633-011	Sp1Thick:PaperSizeEnvCorr:BW	PaperTransfer:1Side:S3	ENG	[1 to 110 / 86 / 1/step]
2-633-012	Sp1Thick:PaperSizeEnvCorr:BW	PaperTransfer:2Side:S3	ENG	[1 to 110 / 89 / 1/step]
2-633-015	Sp1Thick:PaperSizeEnvCorr:BW	PaperTransfer:1Side:S4	ENG	[1 to 110 / 86 / 1/step]

3.SP Mode Tables

SP No.	Large Category	Small Category	ENG or CTL	[Min to Max/Init./Step]
2-633-016	Sp1Thick:PaperSizeEnvCorr:BW	PaperTransfer:2Side:S4	ENG	[1 to 110 / 90 / 1/step]
2-633-019	Sp1Thick:PaperSizeEnvCorr:BW	PaperTransfer:1Side:S5	ENG	[1 to 110 / 86 / 1/step]
2-633-020	Sp1Thick:PaperSizeEnvCorr:BW	PaperTransfer:2Side:S5	ENG	[1 to 110 / 91 / 1/step]
2-633-023	Sp1Thick:PaperSizeEnvCorr:BW	Wide Roller:PaperTransfer:1Side:S1	ENG	[1 to 110 / 85 / 1/step]
2-633-024	Sp1Thick:PaperSizeEnvCorr:BW	Wide Roller:PaperTransfer:2Side:S1	ENG	[1 to 110 / 87 / 1/step]
2-633-027	Sp1Thick:PaperSizeEnvCorr:BW	Wide Roller:PaperTransfer:1Side:S2	ENG	[1 to 110 / 86 / 1/step]
2-633-028	Sp1Thick:PaperSizeEnvCorr:BW	Wide Roller:PaperTransfer:2Side:S2	ENG	[1 to 110 / 88 / 1/step]
2-633-031	Sp1Thick:PaperSizeEnvCorr:BW	Wide Roller:PaperTransfer:1Side:S3	ENG	[1 to 110 / 86 / 1/step]
2-633-032	Sp1Thick:PaperSizeEnvCorr:BW	Wide Roller:PaperTransfer:2Side:S3	ENG	[1 to 110 / 89 / 1/step]
2-633-035	Sp1Thick:PaperSizeEnvCorr:BW	Wide Roller:PaperTransfer:1Side:S4	ENG	[1 to 110 / 86 / 1/step]
2-633-036	Sp1Thick:PaperSizeEnvCorr:BW	Wide Roller:PaperTransfer:2Side:S4	ENG	[1 to 110 / 90 / 1/step]
2-633-039	Sp1Thick:PaperSizeEnvCorr:BW	Wide Roller:PaperTransfer:1Side:S5	ENG	[1 to 110 / 86 / 1/step]

3.SP Mode Tables

SP No.	Large Category	Small Category	ENG or CTL	[Min to Max/Init./Step]
2-633-040	Sp1Thick:PaperSizeEnvCorr:BW	Wide Roller:PaperTransfer:2Side:S5	ENG	[1 to 110 / 91 / 1/step]
2-634-003	Sp1Thick:PaperSizeEnvCorr:FC	PaperTransfer:1Side:S1	ENG	[1 to 110 / 77 / 1/step]
2-634-004	Sp1Thick:PaperSizeEnvCorr:FC	PaperTransfer:2Side:S1	ENG	[1 to 110 / 92 / 1/step]
2-634-007	Sp1Thick:PaperSizeEnvCorr:FC	PaperTransfer:1Side:S2	ENG	[1 to 110 / 78 / 1/step]
2-634-008	Sp1Thick:PaperSizeEnvCorr:FC	PaperTransfer:2Side:S2	ENG	[1 to 110 / 93 / 1/step]
2-634-011	Sp1Thick:PaperSizeEnvCorr:FC	PaperTransfer:1Side:S3	ENG	[1 to 110 / 79 / 1/step]
2-634-012	Sp1Thick:PaperSizeEnvCorr:FC	PaperTransfer:2Side:S3	ENG	[1 to 110 / 94 / 1/step]
2-634-015	Sp1Thick:PaperSizeEnvCorr:FC	PaperTransfer:1Side:S4	ENG	[1 to 110 / 79 / 1/step]
2-634-016	Sp1Thick:PaperSizeEnvCorr:FC	PaperTransfer:2Side:S4	ENG	[1 to 110 / 95 / 1/step]
2-634-019	Sp1Thick:PaperSizeEnvCorr:FC	PaperTransfer:1Side:S5	ENG	[1 to 110 / 79 / 1/step]
2-634-020	Sp1Thick:PaperSizeEnvCorr:FC	PaperTransfer:2Side:S5	ENG	[1 to 110 / 96 / 1/step]
2-634-023	Sp1Thick:PaperSizeEnvCorr:FC	Wide Roller:PaperTransfer:1Side:S1	ENG	[1 to 110 / 77 / 1/step]

3.SP Mode Tables

SP No.	Large Category	Small Category	ENG or CTL	[Min to Max/Init./Step]
2-634-024	Sp1Thick:PaperSizeEnvCorr:FC	Wide Roller:PaperTransfer:2Side:S1	ENG	[1 to 110 / 92 / 1/step]
2-634-027	Sp1Thick:PaperSizeEnvCorr:FC	Wide Roller:PaperTransfer:1Side:S2	ENG	[1 to 110 / 78 / 1/step]
2-634-028	Sp1Thick:PaperSizeEnvCorr:FC	Wide Roller:PaperTransfer:2Side:S2	ENG	[1 to 110 / 93 / 1/step]
2-634-031	Sp1Thick:PaperSizeEnvCorr:FC	Wide Roller:PaperTransfer:1Side:S3	ENG	[1 to 110 / 79 / 1/step]
2-634-032	Sp1Thick:PaperSizeEnvCorr:FC	Wide Roller:PaperTransfer:2Side:S3	ENG	[1 to 110 / 94 / 1/step]
2-634-035	Sp1Thick:PaperSizeEnvCorr:FC	Wide Roller:PaperTransfer:1Side:S4	ENG	[1 to 110 / 79 / 1/step]
2-634-036	Sp1Thick:PaperSizeEnvCorr:FC	Wide Roller:PaperTransfer:2Side:S4	ENG	[1 to 110 / 95 / 1/step]
2-634-039	Sp1Thick:PaperSizeEnvCorr:FC	Wide Roller:PaperTransfer:1Side:S5	ENG	[1 to 110 / 79 / 1/step]
2-634-040	Sp1Thick:PaperSizeEnvCorr:FC	Wide Roller:PaperTransfer:2Side:S5	ENG	[1 to 110 / 96 / 1/step]
2-635-003	Sp1Thick:LeadingEdgeCorrection	Paper Transfer:1side	ENG	[0 to 995 / 100 / 5%/step]
2-635-004	Sp1Thick:LeadingEdgeCorrection	Paper Transfer:2side	ENG	[0 to 995 / 100 / 5%/step]
2-636-003	Sp1Thick:SwitchTimingLeadEdge	Paper Transfer:1side	ENG	[0 to 50 / 0 / 2mm/step]

3.SP Mode Tables

SP No.	Large Category	Small Category	ENG or CTL	[Min to Max/Init./Step]
2-636-004	Sp1Thick:SwitchTimingLeadEdge	Paper Transfer:2side	ENG	[0 to 50 / 0 / 2mm/step]
2-637-003	Sp1Thick:TrailEdgeCorrection	Paper Transfer:1side	ENG	[0 to 995 / 100 / 5%/step]
2-637-004	Sp1Thick:TrailEdgeCorrection	Paper Transfer:2side	ENG	[0 to 995 / 100 / 5%/step]
2-638-003	Sp1Thick:SwitchTimingTrailEdge	Paper Transfer:1side	ENG	[0 to 50 / 0 / 2mm/step]
2-638-004	Sp1Thick:SwitchTimingTrailEdge	Paper Transfer:2side	ENG	[0 to 50 / 0 / 2mm/step]
2-643-003	Special2 Thick:Bias:BW	PaperTransfer:1side	ENG	IM C3500: [0 to 200 / 11 / 1-uA/step] IM C2500: [0 to 200 / 11 / 1-uA/step] IM C2000: [0 to 200 / 11 / 1-uA/step] IM C3000: [0 to 200 / 11 / 1-uA/step]
2-643-004	Special2 Thick:Bias:BW	PaperTransfer:2side	ENG	IM C3500: [0 to 200 / 15 / 1-uA/step] IM C2500: [0 to 200 / 15 / 1-uA/step] IM C2000: [0 to 200 / 15 / 1-uA/step]

3.SP Mode Tables

SP No.	Large Category	Small Category	ENG or CTL	[Min to Max/Init./Step]
				IM C3000: [0 to 200 / 15 / 1-uA/step]
2-647-003	Special2 Thick:Bias:FC	PaperTransfer:1side	ENG	IM C3500: [0 to 200 / 19 / 1-uA/step] IM C2500: [0 to 200 / 19 / 1-uA/step] IM C2000: [0 to 200 / 19 / 1-uA/step] IM C3000: [0 to 200 / 19 / 1-uA/step]
2-647-004	Special2 Thick:Bias:FC	PaperTransfer:2side	ENG	IM C3500: [0 to 200 / 21 / 1-uA/step] IM C2500: [0 to 200 / 21 / 1-uA/step] IM C2000: [0 to 200 / 21 / 1-uA/step] IM C3000: [0 to 200 / 21 / 1-uA/step]
2-651-003	Special2Thick:PaperSizeCorr:BW	PaperTransfer:1Side:S1	ENG	[100 to 995 / 100 / 1%/step]
2-651-004	Special2Thick:PaperSizeCorr:BW	PaperTransfer:2Side:S1	ENG	[100 to 995 / 100 / 1%/step]
2-651-007	Special2Thick:PaperSizeCorr:BW	PaperTransfer:1Side:S2	ENG	[100 to 995 / 100 / 1%/step]

3.SP Mode Tables

SP No.	Large Category	Small Category	ENG or CTL	[Min to Max/Init./Step]
2-651-008	Special2Thick:PaperSizeCorr:BW	PaperTransfer:2Side:S2	ENG	[100 to 995 / 133 / 1%/step]
2-651-011	Special2Thick:PaperSizeCorr:BW	PaperTransfer:1Side:S3	ENG	[100 to 995 / 100 / 1%/step]
2-651-012	Special2Thick:PaperSizeCorr:BW	PaperTransfer:2Side:S3	ENG	[100 to 995 / 167 / 1%/step]
2-651-015	Special2Thick:PaperSizeCorr:BW	PaperTransfer:1Side:S4	ENG	[100 to 995 / 100 / 1%/step]
2-651-016	Special2Thick:PaperSizeCorr:BW	PaperTransfer:2Side:S4	ENG	[100 to 995 / 233 / 1%/step]
2-651-019	Special2Thick:PaperSizeCorr:BW	PaperTransfer:1Side:S5	ENG	[100 to 995 / 100 / 1%/step]
2-651-020	Special2Thick:PaperSizeCorr:BW	PaperTransfer:2Side:S5	ENG	[100 to 995 / 267 / 1%/step]
2-651-023	Special2Thick:PaperSizeCorr:BW	Wide Roller:PaperTransfer:1Side:S1	ENG	[100 to 995 / 100 / 1%/step]
2-651-024	Special2Thick:PaperSizeCorr:BW	Wide Roller:PaperTransfer:2Side:S1	ENG	[100 to 995 / 100 / 1%/step]
2-651-027	Special2Thick:PaperSizeCorr:BW	Wide Roller:PaperTransfer:1Side:S2	ENG	[100 to 995 / 100 / 1%/step]
2-651-028	Special2Thick:PaperSizeCorr:BW	Wide Roller:PaperTransfer:2Side:S2	ENG	[100 to 995 / 133 / 1%/step]
2-651-031	Special2Thick:PaperSizeCorr:BW	Wide Roller:PaperTransfer:1Side:S3	ENG	[100 to 995 / 100 / 1%/step]

3.SP Mode Tables

SP No.	Large Category	Small Category	ENG or CTL	[Min to Max/Init./Step]
2-651-032	Special2Thick:PaperSizeCorr:BW	Wide Roller:PaperTransfer:2Side:S3	ENG	[100 to 995 / 167 / 1%/step]
2-651-035	Special2Thick:PaperSizeCorr:BW	Wide Roller:PaperTransfer:1Side:S4	ENG	[100 to 995 / 100 / 1%/step]
2-651-036	Special2Thick:PaperSizeCorr:BW	Wide Roller:PaperTransfer:2Side:S4	ENG	[100 to 995 / 233 / 1%/step]
2-651-039	Special2Thick:PaperSizeCorr:BW	Wide Roller:PaperTransfer:1Side:S5	ENG	[100 to 995 / 100 / 1%/step]
2-651-040	Special2Thick:PaperSizeCorr:BW	Wide Roller:PaperTransfer:2Side:S5	ENG	[100 to 995 / 267 / 1%/step]
2-652-003	Special2Thick:PaperSizeCorr:FC	PaperTransfer:1Side:S1	ENG	[100 to 995 / 100 / 1%/step]
2-652-004	Special2Thick:PaperSizeCorr:FC	PaperTransfer:2Side:S1	ENG	[100 to 995 / 100 / 1%/step]
2-652-007	Special2Thick:PaperSizeCorr:FC	PaperTransfer:1Side:S2	ENG	[100 to 995 / 100 / 1%/step]
2-652-008	Special2Thick:PaperSizeCorr:FC	PaperTransfer:2Side:S2	ENG	[100 to 995 / 181 / 1%/step]
2-652-011	Special2Thick:PaperSizeCorr:FC	PaperTransfer:1Side:S3	ENG	[100 to 995 / 100 / 1%/step]
2-652-012	Special2Thick:PaperSizeCorr:FC	PaperTransfer:2Side:S3	ENG	[100 to 995 / 229 / 1%/step]
2-652-015	Special2Thick:PaperSizeCorr:FC	PaperTransfer:1Side:S4	ENG	[100 to 995 / 100 / 1%/step]

3.SP Mode Tables

SP No.	Large Category	Small Category	ENG or CTL	[Min to Max/Init./Step]
2-652-016	Special2Thick:PaperSizeCorr:FC	PaperTransfer:2Side:S4	ENG	[100 to 995 / 286 / 1%/step]
2-652-019	Special2Thick:PaperSizeCorr:FC	PaperTransfer:1Side:S5	ENG	[100 to 995 / 100 / 1%/step]
2-652-020	Special2Thick:PaperSizeCorr:FC	PaperTransfer:2Side:S5	ENG	[100 to 995 / 381 / 1%/step]
2-652-023	Special2Thick:PaperSizeCorr:FC	Wide Roller:PaperTransfer:1Side:S1	ENG	[100 to 995 / 100 / 1%/step]
2-652-024	Special2Thick:PaperSizeCorr:FC	Wide Roller:PaperTransfer:2Side:S1	ENG	[100 to 995 / 100 / 1%/step]
2-652-027	Special2Thick:PaperSizeCorr:FC	Wide Roller:PaperTransfer:1Side:S2	ENG	[100 to 995 / 100 / 1%/step]
2-652-028	Special2Thick:PaperSizeCorr:FC	Wide Roller:PaperTransfer:2Side:S2	ENG	[100 to 995 / 181 / 1%/step]
2-652-031	Special2Thick:PaperSizeCorr:FC	Wide Roller:PaperTransfer:1Side:S3	ENG	[100 to 995 / 100 / 1%/step]
2-652-032	Special2Thick:PaperSizeCorr:FC	Wide Roller:PaperTransfer:2Side:S3	ENG	[100 to 995 / 229 / 1%/step]
2-652-035	Special2Thick:PaperSizeCorr:FC	Wide Roller:PaperTransfer:1Side:S4	ENG	[100 to 995 / 100 / 1%/step]
2-652-036	Special2Thick:PaperSizeCorr:FC	Wide Roller:PaperTransfer:2Side:S4	ENG	[100 to 995 / 286 / 1%/step]
2-652-039	Special2Thick:PaperSizeCorr:FC	Wide Roller:PaperTransfer:1Side:S5	ENG	[100 to 995 / 100 / 1%/step]

3.SP Mode Tables

SP No.	Large Category	Small Category	ENG or CTL	[Min to Max/Init./Step]
2-652-040	Special2Thick:PaperSizeCorr:FC	Wide Roller:PaperTransfer:2Side:S5	ENG	[100 to 995 / 381 / 1%/step]
2-653-003	Sp2Thick:PaperSizeEnvCorr:BW	PaperTransfer:1Side:S1	ENG	[1 to 110 / 70 / 1/step]
2-653-004	Sp2Thick:PaperSizeEnvCorr:BW	PaperTransfer:2Side:S1	ENG	[1 to 110 / 72 / 1/step]
2-653-007	Sp2Thick:PaperSizeEnvCorr:BW	PaperTransfer:1Side:S2	ENG	[1 to 110 / 71 / 1/step]
2-653-008	Sp2Thick:PaperSizeEnvCorr:BW	PaperTransfer:2Side:S2	ENG	[1 to 110 / 73 / 1/step]
2-653-011	Sp2Thick:PaperSizeEnvCorr:BW	PaperTransfer:1Side:S3	ENG	[1 to 110 / 72 / 1/step]
2-653-012	Sp2Thick:PaperSizeEnvCorr:BW	PaperTransfer:2Side:S3	ENG	[1 to 110 / 74 / 1/step]
2-653-015	Sp2Thick:PaperSizeEnvCorr:BW	PaperTransfer:1Side:S4	ENG	[1 to 110 / 72 / 1/step]
2-653-016	Sp2Thick:PaperSizeEnvCorr:BW	PaperTransfer:2Side:S4	ENG	[1 to 110 / 75 / 1/step]
2-653-019	Sp2Thick:PaperSizeEnvCorr:BW	PaperTransfer:1Side:S5	ENG	[1 to 110 / 72 / 1/step]
2-653-020	Sp2Thick:PaperSizeEnvCorr:BW	PaperTransfer:2Side:S5	ENG	[1 to 110 / 76 / 1/step]
2-653-023	Sp2Thick:PaperSizeEnvCorr:BW	Wide Roller:PaperTransfer:1Side:S1	ENG	[1 to 110 / 70 / 1/step]

3.SP Mode Tables

SP No.	Large Category	Small Category	ENG or CTL	[Min to Max/Init./Step]
2-653-024	Sp2Thick:PaperSizeEnvCorr:BW	Wide Roller:PaperTransfer:2Side:S1	ENG	[1 to 110 / 72 / 1/step]
2-653-027	Sp2Thick:PaperSizeEnvCorr:BW	Wide Roller:PaperTransfer:1Side:S2	ENG	[1 to 110 / 71 / 1/step]
2-653-028	Sp2Thick:PaperSizeEnvCorr:BW	Wide Roller:PaperTransfer:2Side:S2	ENG	[1 to 110 / 73 / 1/step]
2-653-031	Sp2Thick:PaperSizeEnvCorr:BW	Wide Roller:PaperTransfer:1Side:S3	ENG	[1 to 110 / 72 / 1/step]
2-653-032	Sp2Thick:PaperSizeEnvCorr:BW	Wide Roller:PaperTransfer:2Side:S3	ENG	[1 to 110 / 74 / 1/step]
2-653-035	Sp2Thick:PaperSizeEnvCorr:BW	Wide Roller:PaperTransfer:1Side:S4	ENG	[1 to 110 / 72 / 1/step]
2-653-036	Sp2Thick:PaperSizeEnvCorr:BW	Wide Roller:PaperTransfer:2Side:S4	ENG	[1 to 110 / 75 / 1/step]
2-653-039	Sp2Thick:PaperSizeEnvCorr:BW	Wide Roller:PaperTransfer:1Side:S5	ENG	[1 to 110 / 72 / 1/step]
2-653-040	Sp2Thick:PaperSizeEnvCorr:BW	Wide Roller:PaperTransfer:2Side:S5	ENG	[1 to 110 / 76 / 1/step]
2-654-003	Sp2Thick:PaperSizeEnvCorr:FC	PaperTransfer:1Side:S1	ENG	[1 to 110 / 77 / 1/step]
2-654-004	Sp2Thick:PaperSizeEnvCorr:FC	PaperTransfer:2Side:S1	ENG	[1 to 110 / 80 / 1/step]
2-654-007	Sp2Thick:PaperSizeEnvCorr:FC	PaperTransfer:1Side:S2	ENG	[1 to 110 / 78 / 1/step]

3.SP Mode Tables

SP No.	Large Category	Small Category	ENG or CTL	[Min to Max/Init./Step]
2-654-008	Sp2Thick:PaperSizeEnvCorr:FC	PaperTransfer:2Side:S2	ENG	[1 to 110 / 81 / 1/step]
2-654-011	Sp2Thick:PaperSizeEnvCorr:FC	PaperTransfer:1Side:S3	ENG	[1 to 110 / 79 / 1/step]
2-654-012	Sp2Thick:PaperSizeEnvCorr:FC	PaperTransfer:2Side:S3	ENG	[1 to 110 / 82 / 1/step]
2-654-015	Sp2Thick:PaperSizeEnvCorr:FC	PaperTransfer:1Side:S4	ENG	[1 to 110 / 79 / 1/step]
2-654-016	Sp2Thick:PaperSizeEnvCorr:FC	PaperTransfer:2Side:S4	ENG	[1 to 110 / 83 / 1/step]
2-654-019	Sp2Thick:PaperSizeEnvCorr:FC	PaperTransfer:1Side:S5	ENG	[1 to 110 / 79 / 1/step]
2-654-020	Sp2Thick:PaperSizeEnvCorr:FC	PaperTransfer:2Side:S5	ENG	[1 to 110 / 84 / 1/step]
2-654-023	Sp2Thick:PaperSizeEnvCorr:FC	Wide Roller:PaperTransfer:1Side:S1	ENG	[1 to 110 / 77 / 1/step]
2-654-024	Sp2Thick:PaperSizeEnvCorr:FC	Wide Roller:PaperTransfer:2Side:S1	ENG	[1 to 110 / 80 / 1/step]
2-654-027	Sp2Thick:PaperSizeEnvCorr:FC	Wide Roller:PaperTransfer:1Side:S2	ENG	[1 to 110 / 78 / 1/step]
2-654-028	Sp2Thick:PaperSizeEnvCorr:FC	Wide Roller:PaperTransfer:2Side:S2	ENG	[1 to 110 / 81 / 1/step]
2-654-031	Sp2Thick:PaperSizeEnvCorr:FC	Wide Roller:PaperTransfer:1Side:S3	ENG	[1 to 110 / 79 / 1/step]

3.SP Mode Tables

SP No.	Large Category	Small Category	ENG or CTL	[Min to Max/Init./Step]
2-654-032	Sp2Thick:PaperSizeEnvCorr:FC	Wide Roller:PaperTransfer:2Side:S3	ENG	[1 to 110 / 82 / 1/step]
2-654-035	Sp2Thick:PaperSizeEnvCorr:FC	Wide Roller:PaperTransfer:1Side:S4	ENG	[1 to 110 / 79 / 1/step]
2-654-036	Sp2Thick:PaperSizeEnvCorr:FC	Wide Roller:PaperTransfer:2Side:S4	ENG	[1 to 110 / 83 / 1/step]
2-654-039	Sp2Thick:PaperSizeEnvCorr:FC	Wide Roller:PaperTransfer:1Side:S5	ENG	[1 to 110 / 79 / 1/step]
2-654-040	Sp2Thick:PaperSizeEnvCorr:FC	Wide Roller:PaperTransfer:2Side:S5	ENG	[1 to 110 / 84 / 1/step]
2-655-003	Sp2Thick:LeadingEdgeCorrection	Paper Transfer:1side	ENG	[0 to 995 / 100 / 5%/step]
2-655-004	Sp2Thick:LeadingEdgeCorrection	Paper Transfer:2side	ENG	[0 to 995 / 100 / 5%/step]
2-656-003	Sp2Thick:SwitchTimingLeadEdge	Paper Transfer:1side	ENG	[0 to 50 / 0 / 2mm/step]
2-656-004	Sp2Thick:SwitchTimingLeadEdge	Paper Transfer:2side	ENG	[0 to 50 / 0 / 2mm/step]
2-657-003	Sp2Thick:TrailEdgeCorrection	Paper Transfer:1side	ENG	[0 to 995 / 100 / 5%/step]
2-657-004	Sp2Thick:TrailEdgeCorrection	Paper Transfer:2side	ENG	[0 to 995 / 100 / 5%/step]
2-658-003	Sp2Thick:SwitchTimingTrailEdge	Paper Transfer:1side	ENG	[0 to 50 / 0 / 2mm/step]

3.SP Mode Tables

SP No.	Large Category	Small Category	ENG or CTL	[Min to Max/Init./Step]
2-658-004	Sp2Thick:SwitchTimingTrailEdge	Paper Transfer:2side	ENG	[0 to 50 / 0 / 2mm/step]
2-663-003	Special3 Thick:Bias:BW	PaperTransfer:1side	ENG	IM C3500: [0 to 200 / 11 / 1-uA/step] IM C2500: [0 to 200 / 11 / 1-uA/step] IM C2000: [0 to 200 / 11 / 1-uA/step] IM C3000: [0 to 200 / 11 / 1-uA/step]
2-663-004	Special3 Thick:Bias:BW	PaperTransfer:2side	ENG	IM C3500: [0 to 200 / 15 / 1-uA/step] IM C2500: [0 to 200 / 15 / 1-uA/step] IM C2000: [0 to 200 / 15 / 1-uA/step] IM C3000: [0 to 200 / 15 / 1-uA/step]
2-667-003	Special3 Thick:Bias:FC	PaperTransfer:1side	ENG	IM C3500: [0 to 200 / 19 / 1-uA/step] IM C2500: [0 to 200 / 19 / 1-uA/step] IM C2000: [0 to 200 / 19 / 1-uA/step]

3.SP Mode Tables

SP No.	Large Category	Small Category	ENG or CTL	[Min to Max/Init./Step]
				IM C3000: [0 to 200 / 19 / 1-uA/step]
2-667-004	Special3 Thick:Bias:FC	PaperTransfer:2side	ENG	IM C3500: [0 to 200 / 21 / 1-uA/step] IM C2500: [0 to 200 / 21 / 1-uA/step] IM C2000: [0 to 200 / 21 / 1-uA/step] IM C3000: [0 to 200 / 21 / 1-uA/step]
2-671-003	Special3Thick:PaperSizeCorr:BW	PaperTransfer:1Side:S1	ENG	[100 to 995 / 100 / 5%/step]
2-671-004	Special3Thick:PaperSizeCorr:BW	PaperTransfer:2Side:S1	ENG	[100 to 995 / 100 / 5%/step]
2-671-007	Special3Thick:PaperSizeCorr:BW	PaperTransfer:1Side:S2	ENG	[100 to 995 / 100 / 5%/step]
2-671-008	Special3Thick:PaperSizeCorr:BW	PaperTransfer:2Side:S2	ENG	[100 to 995 / 133 / 5%/step]
2-671-011	Special3Thick:PaperSizeCorr:BW	PaperTransfer:1Side:S3	ENG	[100 to 995 / 100 / 5%/step]
2-671-012	Special3Thick:PaperSizeCorr:BW	PaperTransfer:2Side:S3	ENG	[100 to 995 / 167 / 5%/step]
2-671-015	Special3Thick:PaperSizeCorr:BW	PaperTransfer:1Side:S4	ENG	[100 to 995 / 100 / 5%/step]

3.SP Mode Tables

SP No.	Large Category	Small Category	ENG or CTL	[Min to Max/Init./Step]
2-671-016	Special3Thick:PaperSizeCorr:BW	PaperTransfer:2Side:S4	ENG	[100 to 995 / 233 / 5%/step]
2-671-019	Special3Thick:PaperSizeCorr:BW	PaperTransfer:1Side:S5	ENG	[100 to 995 / 100 / 5%/step]
2-671-020	Special3Thick:PaperSizeCorr:BW	PaperTransfer:2Side:S5	ENG	[100 to 995 / 267 / 5%/step]
2-671-023	Special3Thick:PaperSizeCorr:BW	Wide Roller:PaperTransfer:1Side:S1	ENG	[100 to 995 / 100 / 5%/step]
2-671-024	Special3Thick:PaperSizeCorr:BW	Wide Roller:PaperTransfer:2Side:S1	ENG	[100 to 995 / 100 / 5%/step]
2-671-027	Special3Thick:PaperSizeCorr:BW	Wide Roller:PaperTransfer:1Side:S2	ENG	[100 to 995 / 100 / 5%/step]
2-671-028	Special3Thick:PaperSizeCorr:BW	Wide Roller:PaperTransfer:2Side:S2	ENG	[100 to 995 / 133 / 5%/step]
2-671-031	Special3Thick:PaperSizeCorr:BW	Wide Roller:PaperTransfer:1Side:S3	ENG	[100 to 995 / 100 / 5%/step]
2-671-032	Special3Thick:PaperSizeCorr:BW	Wide Roller:PaperTransfer:2Side:S3	ENG	[100 to 995 / 167 / 5%/step]
2-671-035	Special3Thick:PaperSizeCorr:BW	Wide Roller:PaperTransfer:1Side:S4	ENG	[100 to 995 / 100 / 5%/step]
2-671-036	Special3Thick:PaperSizeCorr:BW	Wide Roller:PaperTransfer:2Side:S4	ENG	[100 to 995 / 233 / 5%/step]
2-671-039	Special3Thick:PaperSizeCorr:BW	Wide Roller:PaperTransfer:1Side:S5	ENG	[100 to 995 / 100 / 5%/step]

3.SP Mode Tables

SP No.	Large Category	Small Category	ENG or CTL	[Min to Max/Init./Step]
2-671-040	Special3Thick:PaperSizeCorr:BW	Wide Roller:PaperTransfer:2Side:S5	ENG	[100 to 995 / 267 / 5%/step]
2-672-003	Special3Thick:PaperSizeCorr:FC	PaperTransfer:1Side:S1	ENG	[100 to 995 / 100 / 5%/step]
2-672-004	Special3Thick:PaperSizeCorr:FC	PaperTransfer:2Side:S1	ENG	[100 to 995 / 100 / 5%/step]
2-672-007	Special3Thick:PaperSizeCorr:FC	PaperTransfer:1Side:S2	ENG	[100 to 995 / 100 / 5%/step]
2-672-008	Special3Thick:PaperSizeCorr:FC	PaperTransfer:2Side:S2	ENG	[100 to 995 / 181 / 5%/step]
2-672-011	Special3Thick:PaperSizeCorr:FC	PaperTransfer:1Side:S3	ENG	[100 to 995 / 100 / 5%/step]
2-672-012	Special3Thick:PaperSizeCorr:FC	PaperTransfer:2Side:S3	ENG	[100 to 995 / 229 / 5%/step]
2-672-015	Special3Thick:PaperSizeCorr:FC	PaperTransfer:1Side:S4	ENG	[100 to 995 / 100 / 5%/step]
2-672-016	Special3Thick:PaperSizeCorr:FC	PaperTransfer:2Side:S4	ENG	[100 to 995 / 286 / 5%/step]
2-672-019	Special3Thick:PaperSizeCorr:FC	PaperTransfer:1Side:S5	ENG	[100 to 995 / 100 / 5%/step]
2-672-020	Special3Thick:PaperSizeCorr:FC	PaperTransfer:2Side:S5	ENG	[100 to 995 / 381 / 5%/step]
2-672-023	Special3Thick:PaperSizeCorr:FC	Wide Roller:PaperTransfer:1Side:S1	ENG	[100 to 995 / 100 / 5%/step]

3.SP Mode Tables

SP No.	Large Category	Small Category	ENG or CTL	[Min to Max/Init./Step]
2-672-024	Special3Thick:PaperSizeCorr:FC	Wide Roller:PaperTransfer:2Side:S1	ENG	[100 to 995 / 100 / 5%/step]
2-672-027	Special3Thick:PaperSizeCorr:FC	Wide Roller:PaperTransfer:1Side:S2	ENG	[100 to 995 / 100 / 5%/step]
2-672-028	Special3Thick:PaperSizeCorr:FC	Wide Roller:PaperTransfer:2Side:S2	ENG	[100 to 995 / 181 / 5%/step]
2-672-031	Special3Thick:PaperSizeCorr:FC	Wide Roller:PaperTransfer:1Side:S3	ENG	[100 to 995 / 100 / 5%/step]
2-672-032	Special3Thick:PaperSizeCorr:FC	Wide Roller:PaperTransfer:2Side:S3	ENG	[100 to 995 / 229 / 5%/step]
2-672-035	Special3Thick:PaperSizeCorr:FC	Wide Roller:PaperTransfer:1Side:S4	ENG	[100 to 995 / 100 / 5%/step]
2-672-036	Special3Thick:PaperSizeCorr:FC	Wide Roller:PaperTransfer:2Side:S4	ENG	[100 to 995 / 286 / 5%/step]
2-672-039	Special3Thick:PaperSizeCorr:FC	Wide Roller:PaperTransfer:1Side:S5	ENG	[100 to 995 / 100 / 5%/step]
2-672-040	Special3Thick:PaperSizeCorr:FC	Wide Roller:PaperTransfer:2Side:S5	ENG	[100 to 995 / 381 / 5%/step]
2-673-003	Sp3Thick:PaperSizeEnvCorr:BW	PaperTransfer:1Side:S1	ENG	[1 to 110 / 70 / 1/step]
2-673-004	Sp3Thick:PaperSizeEnvCorr:BW	PaperTransfer:2Side:S1	ENG	[1 to 110 / 72 / 1/step]
2-673-007	Sp3Thick:PaperSizeEnvCorr:BW	PaperTransfer:1Side:S2	ENG	[1 to 110 / 71 / 1/step]

3.SP Mode Tables

SP No.	Large Category	Small Category	ENG or CTL	[Min to Max/Init./Step]
2-673-008	Sp3Thick:PaperSizeEnvCorr:BW	PaperTransfer:2Side:S2	ENG	[1 to 110 / 73 / 1/step]
2-673-011	Sp3Thick:PaperSizeEnvCorr:BW	PaperTransfer:1Side:S3	ENG	[1 to 110 / 72 / 1/step]
2-673-012	Sp3Thick:PaperSizeEnvCorr:BW	PaperTransfer:2Side:S3	ENG	[1 to 110 / 74 / 1/step]
2-673-015	Sp3Thick:PaperSizeEnvCorr:BW	PaperTransfer:1Side:S4	ENG	[1 to 110 / 72 / 1/step]
2-673-016	Sp3Thick:PaperSizeEnvCorr:BW	PaperTransfer:2Side:S4	ENG	[1 to 110 / 75 / 1/step]
2-673-019	Sp3Thick:PaperSizeEnvCorr:BW	PaperTransfer:1Side:S5	ENG	[1 to 110 / 72 / 1/step]
2-673-020	Sp3Thick:PaperSizeEnvCorr:BW	PaperTransfer:2Side:S5	ENG	[1 to 110 / 76 / 1/step]
2-673-023	Sp3Thick:PaperSizeEnvCorr:BW	Wide Roller:PaperTransfer:1Side:S1	ENG	[1 to 110 / 70 / 1/step]
2-673-024	Sp3Thick:PaperSizeEnvCorr:BW	Wide Roller:PaperTransfer:2Side:S1	ENG	[1 to 110 / 72 / 1/step]
2-673-027	Sp3Thick:PaperSizeEnvCorr:BW	Wide Roller:PaperTransfer:1Side:S2	ENG	[1 to 110 / 71 / 1/step]
2-673-028	Sp3Thick:PaperSizeEnvCorr:BW	Wide Roller:PaperTransfer:2Side:S2	ENG	[1 to 110 / 73 / 1/step]
2-673-031	Sp3Thick:PaperSizeEnvCorr:BW	Wide Roller:PaperTransfer:1Side:S3	ENG	[1 to 110 / 72 / 1/step]

3.SP Mode Tables

SP No.	Large Category	Small Category	ENG or CTL	[Min to Max/Init./Step]
2-673-032	Sp3Thick:PaperSizeEnvCorr:BW	Wide Roller:PaperTransfer:2Side:S3	ENG	[1 to 110 / 74 / 1/step]
2-673-035	Sp3Thick:PaperSizeEnvCorr:BW	Wide Roller:PaperTransfer:1Side:S4	ENG	[1 to 110 / 72 / 1/step]
2-673-036	Sp3Thick:PaperSizeEnvCorr:BW	Wide Roller:PaperTransfer:2Side:S4	ENG	[1 to 110 / 75 / 1/step]
2-673-039	Sp3Thick:PaperSizeEnvCorr:BW	Wide Roller:PaperTransfer:1Side:S5	ENG	[1 to 110 / 72 / 1/step]
2-673-040	Sp3Thick:PaperSizeEnvCorr:BW	Wide Roller:PaperTransfer:2Side:S5	ENG	[1 to 110 / 76 / 1/step]
2-674-003	Sp3Thick:PaperSizeEnvCorr:FC	PaperTransfer:1Side:S1	ENG	[1 to 110 / 77 / 1/step]
2-674-004	Sp3Thick:PaperSizeEnvCorr:FC	PaperTransfer:2Side:S1	ENG	[1 to 110 / 80 / 1/step]
2-674-007	Sp3Thick:PaperSizeEnvCorr:FC	PaperTransfer:1Side:S2	ENG	[1 to 110 / 78 / 1/step]
2-674-008	Sp3Thick:PaperSizeEnvCorr:FC	PaperTransfer:2Side:S2	ENG	[1 to 110 / 81 / 1/step]
2-674-011	Sp3Thick:PaperSizeEnvCorr:FC	PaperTransfer:1Side:S3	ENG	[1 to 110 / 79 / 1/step]
2-674-012	Sp3Thick:PaperSizeEnvCorr:FC	PaperTransfer:2Side:S3	ENG	[1 to 110 / 82 / 1/step]
2-674-015	Sp3Thick:PaperSizeEnvCorr:FC	PaperTransfer:1Side:S4	ENG	[1 to 110 / 79 / 1/step]

3.SP Mode Tables

SP No.	Large Category	Small Category	ENG or CTL	[Min to Max/Init./Step]
2-674-016	Sp3Thick:PaperSizeEnvCorr:FC	PaperTransfer:2Side:S4	ENG	[1 to 110 / 83 / 1/step]
2-674-019	Sp3Thick:PaperSizeEnvCorr:FC	PaperTransfer:1Side:S5	ENG	[1 to 110 / 79 / 1/step]
2-674-020	Sp3Thick:PaperSizeEnvCorr:FC	PaperTransfer:2Side:S5	ENG	[1 to 110 / 84 / 1/step]
2-674-023	Sp3Thick:PaperSizeEnvCorr:FC	Wide Roller:PaperTransfer:1Side:S1	ENG	[1 to 110 / 77 / 1/step]
2-674-024	Sp3Thick:PaperSizeEnvCorr:FC	Wide Roller:PaperTransfer:2Side:S1	ENG	[1 to 110 / 80 / 1/step]
2-674-027	Sp3Thick:PaperSizeEnvCorr:FC	Wide Roller:PaperTransfer:1Side:S2	ENG	[1 to 110 / 78 / 1/step]
2-674-028	Sp3Thick:PaperSizeEnvCorr:FC	Wide Roller:PaperTransfer:2Side:S2	ENG	[1 to 110 / 81 / 1/step]
2-674-031	Sp3Thick:PaperSizeEnvCorr:FC	Wide Roller:PaperTransfer:1Side:S3	ENG	[1 to 110 / 79 / 1/step]
2-674-032	Sp3Thick:PaperSizeEnvCorr:FC	Wide Roller:PaperTransfer:2Side:S3	ENG	[1 to 110 / 82 / 1/step]
2-674-035	Sp3Thick:PaperSizeEnvCorr:FC	Wide Roller:PaperTransfer:1Side:S4	ENG	[1 to 110 / 79 / 1/step]
2-674-036	Sp3Thick:PaperSizeEnvCorr:FC	Wide Roller:PaperTransfer:2Side:S4	ENG	[1 to 110 / 83 / 1/step]
2-674-039	Sp3Thick:PaperSizeEnvCorr:FC	Wide Roller:PaperTransfer:1Side:S5	ENG	[1 to 110 / 79 / 1/step]

3.SP Mode Tables

SP No.	Large Category	Small Category	ENG or CTL	[Min to Max/Init./Step]
2-674-040	Sp3Thick:PaperSizeEnvCorr:FC	Wide Roller:PaperTransfer:2Side:S5	ENG	[1 to 110 / 84 / 1/step]
2-675-003	Sp3Thick:LeadingEdgeCorrection	Paper Transfer:1side	ENG	[0 to 995 / 100 / 5%/step]
2-675-004	Sp3Thick:LeadingEdgeCorrection	Paper Transfer:2side	ENG	[0 to 995 / 100 / 5%/step]
2-676-003	Sp3Thick:SwitchTimingLeadEdge	Paper Transfer:1side	ENG	[0 to 50 / 0 / 2mm/step]
2-676-004	Sp3Thick:SwitchTimingLeadEdge	Paper Transfer:2side	ENG	[0 to 50 / 0 / 2mm/step]
2-677-003	Sp3Thick:TrailEdgeCorrection	Paper Transfer:1side	ENG	[0 to 995 / 100 / 5%/step]
2-677-004	Sp3Thick:TrailEdgeCorrection	Paper Transfer:2side	ENG	[0 to 995 / 100 / 5%/step]
2-678-003	Sp3Thick:SwitchTimingTrailEdge	Paper Transfer:1side	ENG	[0 to 50 / 0 / 2mm/step]
2-678-004	Sp3Thick:SwitchTimingTrailEdge	Paper Transfer:2side	ENG	[0 to 50 / 0 / 2mm/step]
2-690-001	ITB Contact Setting	Thick1	ENG	[0 to 1 / 0 / 1/step]
2-690-002	ITB Contact Setting	Thick2	ENG	[0 to 1 / 0 / 1/step]
2-690-003	ITB Contact Setting	Thick3	ENG	[0 to 1 / 0 / 1/step]

3.SP Mode Tables

SP No.	Large Category	Small Category	ENG or CTL	[Min to Max/Init./Step]
2-690-004	ITB Contact Setting	Thick4	ENG	[0 to 1 / 0 / 1/step]
2-690-014	ITB Contact Setting	Special1Thick1234	ENG	[0 to 1 / 0 / 1/step]
2-690-015	ITB Contact Setting	Special2Thick1234	ENG	[0 to 1 / 0 / 1/step]
2-690-016	ITB Contact Setting	Special3Thick1234	ENG	[0 to 1 / 0 / 1/step]
2-703-003	Thick4:Bias:BW	PaperTransfer:1side	ENG	IM C3500: [0 to 200 / 11 / 1-uA/step] IM C2500: [0 to 200 / 11 / 1-uA/step] IM C2000: [0 to 200 / 11 / 1-uA/step] IM C3000: [0 to 200 / 11 / 1-uA/step]
2-703-004	Thick4:Bias:BW	PaperTransfer:2side	ENG	IM C3500: [0 to 200 / 15 / 1-uA/step] IM C2500: [0 to 200 / 15 / 1-uA/step] IM C2000: [0 to 200 / 15 / 1-uA/step] IM C3000: [0 to 200 / 15 / 1-uA/step]

3.SP Mode Tables

SP No.	Large Category	Small Category	ENG or CTL	[Min to Max/Init./Step]
2-707-003	Thick4:Bias:FC	PaperTransfer:1side	ENG	IM C3500: [0 to 200 / 19 / 1-uA/step] IM C2500: [0 to 200 / 19 / 1-uA/step] IM C2000: [0 to 200 / 19 / 1-uA/step] IM C3000: [0 to 200 / 19 / 1-uA/step]
2-707-004	Thick4:Bias:FC	PaperTransfer:2side	ENG	IM C3500: [0 to 200 / 21 / 1-uA/step] IM C2500: [0 to 200 / 21 / 1-uA/step] IM C2000: [0 to 200 / 21 / 1-uA/step] IM C3000: [0 to 200 / 21 / 1-uA/step]
2-711-003	Thick4:SizeCorrection:BW	PaperTransfer:1Side:S1	ENG	[100 to 995 / 100 / 1%/step]
2-711-004	Thick4:SizeCorrection:BW	PaperTransfer:2Side:S1	ENG	[100 to 995 / 100 / 1%/step]
2-711-007	Thick4:SizeCorrection:BW	PaperTransfer:1Side:S2	ENG	[100 to 995 / 100 / 1%/step]
2-711-008	Thick4:SizeCorrection:BW	PaperTransfer:2Side:S2	ENG	[100 to 995 / 133 / 1%/step]

3.SP Mode Tables

SP No.	Large Category	Small Category	ENG or CTL	[Min to Max/Init./Step]
2-711-011	Thick4:SizeCorrection:BW	PaperTransfer:1Side:S3	ENG	[100 to 995 / 100 / 1%/step]
2-711-012	Thick4:SizeCorrection:BW	PaperTransfer:2Side:S3	ENG	[100 to 995 / 167 / 1%/step]
2-711-015	Thick4:SizeCorrection:BW	PaperTransfer:1Side:S4	ENG	[100 to 995 / 100 / 1%/step]
2-711-016	Thick4:SizeCorrection:BW	PaperTransfer:2Side:S4	ENG	[100 to 995 / 233 / 1%/step]
2-711-019	Thick4:SizeCorrection:BW	PaperTransfer:1Side:S5	ENG	[100 to 995 / 100 / 1%/step]
2-711-020	Thick4:SizeCorrection:BW	PaperTransfer:2Side:S5	ENG	[100 to 995 / 267 / 1%/step]
2-711-023	Thick4:SizeCorrection:BW	Wide Roller:PaperTransfer:1Side:S1	ENG	[100 to 995 / 100 / 1%/step]
2-711-024	Thick4:SizeCorrection:BW	Wide Roller:PaperTransfer:2Side:S1	ENG	[100 to 995 / 100 / 1%/step]
2-711-027	Thick4:SizeCorrection:BW	Wide Roller:PaperTransfer:1Side:S2	ENG	[100 to 995 / 100 / 1%/step]
2-711-028	Thick4:SizeCorrection:BW	Wide Roller:PaperTransfer:2Side:S2	ENG	[100 to 995 / 133 / 1%/step]
2-711-031	Thick4:SizeCorrection:BW	Wide Roller:PaperTransfer:1Side:S3	ENG	[100 to 995 / 100 / 1%/step]
2-711-032	Thick4:SizeCorrection:BW	Wide Roller:PaperTransfer:2Side:S3	ENG	[100 to 995 / 167 / 1%/step]

3.SP Mode Tables

SP No.	Large Category	Small Category	ENG or CTL	[Min to Max/Init./Step]
2-711-035	Thick4:SizeCorrection:BW	Wide Roller:PaperTransfer:1Side:S4	ENG	[100 to 995 / 100 / 1%/step]
2-711-036	Thick4:SizeCorrection:BW	Wide Roller:PaperTransfer:2Side:S4	ENG	[100 to 995 / 233 / 1%/step]
2-711-039	Thick4:SizeCorrection:BW	Wide Roller:PaperTransfer:1Side:S5	ENG	[100 to 995 / 100 / 1%/step]
2-711-040	Thick4:SizeCorrection:BW	Wide Roller:PaperTransfer:2Side:S5	ENG	[100 to 995 / 267 / 1%/step]
2-712-003	Thick4:SizeCorrection:FC	PaperTransfer:1Side:S1	ENG	[100 to 995 / 100 / 1%/step]
2-712-004	Thick4:SizeCorrection:FC	PaperTransfer:2Side:S1	ENG	[100 to 995 / 100 / 1%/step]
2-712-007	Thick4:SizeCorrection:FC	PaperTransfer:1Side:S2	ENG	[100 to 995 / 100 / 1%/step]
2-712-008	Thick4:SizeCorrection:FC	PaperTransfer:2Side:S2	ENG	[100 to 995 / 181 / 1%/step]
2-712-011	Thick4:SizeCorrection:FC	PaperTransfer:1Side:S3	ENG	[100 to 995 / 100 / 1%/step]
2-712-012	Thick4:SizeCorrection:FC	PaperTransfer:2Side:S3	ENG	[100 to 995 / 229 / 1%/step]
2-712-015	Thick4:SizeCorrection:FC	PaperTransfer:1Side:S4	ENG	[100 to 995 / 100 / 1%/step]
2-712-016	Thick4:SizeCorrection:FC	PaperTransfer:2Side:S4	ENG	[100 to 995 / 286 / 1%/step]

3.SP Mode Tables

SP No.	Large Category	Small Category	ENG or CTL	[Min to Max/Init./Step]
2-712-019	Thick4:SizeCorrection:FC	PaperTransfer:1Side:S5	ENG	[100 to 995 / 100 / 1%/step]
2-712-020	Thick4:SizeCorrection:FC	PaperTransfer:2Side:S5	ENG	[100 to 995 / 381 / 1%/step]
2-712-023	Thick4:SizeCorrection:FC	Wide Roller:PaperTransfer:1Side:S1	ENG	[100 to 995 / 100 / 1%/step]
2-712-024	Thick4:SizeCorrection:FC	Wide Roller:PaperTransfer:2Side:S1	ENG	[100 to 995 / 100 / 1%/step]
2-712-027	Thick4:SizeCorrection:FC	Wide Roller:PaperTransfer:1Side:S2	ENG	[100 to 995 / 100 / 1%/step]
2-712-028	Thick4:SizeCorrection:FC	Wide Roller:PaperTransfer:2Side:S2	ENG	[100 to 995 / 181 / 1%/step]
2-712-031	Thick4:SizeCorrection:FC	Wide Roller:PaperTransfer:1Side:S3	ENG	[100 to 995 / 100 / 1%/step]
2-712-032	Thick4:SizeCorrection:FC	Wide Roller:PaperTransfer:2Side:S3	ENG	[100 to 995 / 229 / 1%/step]
2-712-035	Thick4:SizeCorrection:FC	Wide Roller:PaperTransfer:1Side:S4	ENG	[100 to 995 / 100 / 1%/step]
2-712-036	Thick4:SizeCorrection:FC	Wide Roller:PaperTransfer:2Side:S4	ENG	[100 to 995 / 286 / 1%/step]
2-712-039	Thick4:SizeCorrection:FC	Wide Roller:PaperTransfer:1Side:S5	ENG	[100 to 995 / 100 / 1%/step]
2-712-040	Thick4:SizeCorrection:FC	Wide Roller:PaperTransfer:2Side:S5	ENG	[100 to 995 / 381 / 1%/step]

3.SP Mode Tables

SP No.	Large Category	Small Category	ENG or CTL	[Min to Max/Init./Step]
2-713-003	Thick4:Size-Env.Correct:BW	PaperTransfer:1Side:S1	ENG	[1 to 110 / 70 / 1/step]
2-713-004	Thick4:Size-Env.Correct:BW	PaperTransfer:2Side:S1	ENG	[1 to 110 / 72 / 1/step]
2-713-007	Thick4:Size-Env.Correct:BW	PaperTransfer:1Side:S2	ENG	[1 to 110 / 71 / 1/step]
2-713-008	Thick4:Size-Env.Correct:BW	PaperTransfer:2Side:S2	ENG	[1 to 110 / 73 / 1/step]
2-713-011	Thick4:Size-Env.Correct:BW	PaperTransfer:1Side:S3	ENG	[1 to 110 / 72 / 1/step]
2-713-012	Thick4:Size-Env.Correct:BW	PaperTransfer:2Side:S3	ENG	[1 to 110 / 74 / 1/step]
2-713-015	Thick4:Size-Env.Correct:BW	PaperTransfer:1Side:S4	ENG	[1 to 110 / 72 / 1/step]
2-713-016	Thick4:Size-Env.Correct:BW	PaperTransfer:2Side:S4	ENG	[1 to 110 / 75 / 1/step]
2-713-019	Thick4:Size-Env.Correct:BW	PaperTransfer:1Side:S5	ENG	[1 to 110 / 72 / 1/step]
2-713-020	Thick4:Size-Env.Correct:BW	PaperTransfer:2Side:S5	ENG	[1 to 110 / 76 / 1/step]
2-713-023	Thick4:Size-Env.Correct:BW	Wide Roller:PaperTransfer:1Side:S1	ENG	[1 to 110 / 70 / 1/step]
2-713-024	Thick4:Size-Env.Correct:BW	Wide Roller:PaperTransfer:2Side:S1	ENG	[1 to 110 / 72 / 1/step]

3.SP Mode Tables

SP No.	Large Category	Small Category	ENG or CTL	[Min to Max/Init./Step]
2-713-027	Thick4:Size-Env.Correct:BW	Wide Roller:PaperTransfer:1Side:S2	ENG	[1 to 110 / 71 / 1/step]
2-713-028	Thick4:Size-Env.Correct:BW	Wide Roller:PaperTransfer:2Side:S2	ENG	[1 to 110 / 73 / 1/step]
2-713-031	Thick4:Size-Env.Correct:BW	Wide Roller:PaperTransfer:1Side:S3	ENG	[1 to 110 / 72 / 1/step]
2-713-032	Thick4:Size-Env.Correct:BW	Wide Roller:PaperTransfer:2Side:S3	ENG	[1 to 110 / 74 / 1/step]
2-713-035	Thick4:Size-Env.Correct:BW	Wide Roller:PaperTransfer:1Side:S4	ENG	[1 to 110 / 72 / 1/step]
2-713-036	Thick4:Size-Env.Correct:BW	Wide Roller:PaperTransfer:2Side:S4	ENG	[1 to 110 / 75 / 1/step]
2-713-039	Thick4:Size-Env.Correct:BW	Wide Roller:PaperTransfer:1Side:S5	ENG	[1 to 110 / 72 / 1/step]
2-713-040	Thick4:Size-Env.Correct:BW	Wide Roller:PaperTransfer:2Side:S5	ENG	[1 to 110 / 76 / 1/step]
2-714-003	Thick4:Size-Env.Correct:FC	PaperTransfer:1Side:S1	ENG	[1 to 110 / 77 / 1/step]
2-714-004	Thick4:Size-Env.Correct:FC	PaperTransfer:2Side:S1	ENG	[1 to 110 / 80 / 1/step]
2-714-007	Thick4:Size-Env.Correct:FC	PaperTransfer:1Side:S2	ENG	[1 to 110 / 78 / 1/step]
2-714-008	Thick4:Size-Env.Correct:FC	PaperTransfer:2Side:S2	ENG	[1 to 110 / 81 / 1/step]

3.SP Mode Tables

SP No.	Large Category	Small Category	ENG or CTL	[Min to Max/Init./Step]
2-714-011	Thick4:Size-Env.Correct:FC	PaperTransfer:1Side:S3	ENG	[1 to 110 / 79 / 1/step]
2-714-012	Thick4:Size-Env.Correct:FC	PaperTransfer:2Side:S3	ENG	[1 to 110 / 82 / 1/step]
2-714-015	Thick4:Size-Env.Correct:FC	PaperTransfer:1Side:S4	ENG	[1 to 110 / 79 / 1/step]
2-714-016	Thick4:Size-Env.Correct:FC	PaperTransfer:2Side:S4	ENG	[1 to 110 / 83 / 1/step]
2-714-019	Thick4:Size-Env.Correct:FC	PaperTransfer:1Side:S5	ENG	[1 to 110 / 79 / 1/step]
2-714-020	Thick4:Size-Env.Correct:FC	PaperTransfer:2Side:S5	ENG	[1 to 110 / 84 / 1/step]
2-714-023	Thick4:Size-Env.Correct:FC	Wide Roller:PaperTransfer:1Side:S1	ENG	[1 to 110 / 77 / 1/step]
2-714-024	Thick4:Size-Env.Correct:FC	Wide Roller:PaperTransfer:2Side:S1	ENG	[1 to 110 / 80 / 1/step]
2-714-027	Thick4:Size-Env.Correct:FC	Wide Roller:PaperTransfer:1Side:S2	ENG	[1 to 110 / 78 / 1/step]
2-714-028	Thick4:Size-Env.Correct:FC	Wide Roller:PaperTransfer:2Side:S2	ENG	[1 to 110 / 81 / 1/step]
2-714-031	Thick4:Size-Env.Correct:FC	Wide Roller:PaperTransfer:1Side:S3	ENG	[1 to 110 / 79 / 1/step]
2-714-032	Thick4:Size-Env.Correct:FC	Wide Roller:PaperTransfer:2Side:S3	ENG	[1 to 110 / 82 / 1/step]

3.SP Mode Tables

SP No.	Large Category	Small Category	ENG or CTL	[Min to Max/Init./Step]
2-714-035	Thick4:Size-Env.Correct:FC	Wide Roller:PaperTransfer:1Side:S4	ENG	[1 to 110 / 79 / 1/step]
2-714-036	Thick4:Size-Env.Correct:FC	Wide Roller:PaperTransfer:2Side:S4	ENG	[1 to 110 / 83 / 1/step]
2-714-039	Thick4:Size-Env.Correct:FC	Wide Roller:PaperTransfer:1Side:S5	ENG	[1 to 110 / 79 / 1/step]
2-714-040	Thick4:Size-Env.Correct:FC	Wide Roller:PaperTransfer:2Side:S5	ENG	[1 to 110 / 84 / 1/step]
2-715-003	Thick4:LeadingEdgeCorrection	Paper Transfer:1side	ENG	[0 to 995 / 100 / 5%/step]
2-715-004	Thick4:LeadingEdgeCorrection	Paper Transfer:2side	ENG	[0 to 995 / 100 / 5%/step]
2-716-003	Thick4:SwitchTimingLeadEdge	Paper Transfer:1side	ENG	[0 to 50 / 0 / 2mm/step]
2-716-004	Thick4:SwitchTimingLeadEdge	Paper Transfer:2side	ENG	[0 to 50 / 0 / 2mm/step]
2-717-003	Thick4:TrailEdgeCorrection	Paper Transfer:1side	ENG	[0 to 995 / 100 / 5%/step]
2-717-004	Thick4:TrailEdgeCorrection	Paper Transfer:2side	ENG	[0 to 995 / 100 / 5%/step]
2-718-003	Thick4:SwitchTimingTrailEdge	Paper Transfer:1side	ENG	[0 to 50 / 0 / 2mm/step]
2-718-004	Thick4:SwitchTimingTrailEdge	Paper Transfer:2side	ENG	[0 to 50 / 0 / 2mm/step]

3.SP Mode Tables

SP No.	Large Category	Small Category	ENG or CTL	[Min to Max/Init./Step]
2-901-001	OPC Drum Brake Time	All	ENG*	[50 to 240000 / 50 / 10msec/step]
2-902-001	OPC Drum Reverse Time	All: BW	ENG*	[0 to 200 / 50 / 10msec/step]
2-902-002	OPC Drum Reverse Time	All: FC	ENG*	[0 to 200 / 50 / 10msec/step]
2-903-003	Image Transfer Brake Time	All	ENG*	[50 to 240000 / 50 / 10msec/step]
2-905-003	Dev Rvs Time	K	ENG*	[0 to 200 / 80 / 10msec/step]
2-905-004	Dev Rvs Time	CI	ENG*	[0 to 200 / 80 / 10msec/step]
2-905-005	Dev Rvs Threshold Counter	ALL	ENG*	[0 to 400000 / 4000 / 10mm/step]
2-905-006	Dev Rvs Counter	K	ENG*	[0 to 4294967295 / 0 / 1mm/step]
2-905-007	Dev Rvs Counter	CI	ENG*	[0 to 4294967295 / 0 / 1mm/step]
2-907-001	ACS Setting (FC to Bk)	Continuous Bk Pages	ENG*	[0 to 10 / 0 / 1sheet/step]
2-908-156	Outer Motor Load	OPC Transfer M	ENG*	[0 to 65535 / 0 / 1/step]
2-908-157	Outer Motor Load	Color Opc M	ENG*	[0 to 65535 / 0 / 1/step]

3.SP Mode Tables

SP No.	Large Category	Small Category	ENG or CTL	[Min to Max/Init./Step]
2-908-158	Outer Motor Load	Bk Dev M	ENG*	[0 to 65535 / 0 / 1/step]
2-908-159	Outer Motor Load	Color Dev M	ENG*	[0 to 65535 / 0 / 1/step]
2-908-160	Outer Motor Load	Fusing M	ENG*	[0 to 65535 / 0 / 1/step]
2-908-161	Out M Signal Line	OPC Transfer M	ENG*	[0 to 65535 / 0 / 1/step]
2-908-162	Out M Signal Line	Color Opc M	ENG*	[0 to 65535 / 0 / 1/step]
2-908-163	Out M Signal Line	Bk Dev M	ENG*	[0 to 65535 / 0 / 1/step]
2-908-164	Out M Signal Line	Color Dev M	ENG*	[0 to 65535 / 0 / 1/step]
2-908-165	Out M Signal Line	Fusing M	ENG*	[0 to 65535 / 0 / 1/step]
2-930-001	Transfer:Bias Limiter	Bias	ENG*	[0 to 7000 / 6000 / 10-V/step]
2-960-001	Process Interval	Additional Time	ENG*	[0 to 10 / 0 / 1sec/step]
2-972-001	B/W Image Request Timing	T14:standard speed	ENG*	[0 to 4000 / 0 / 10msec/step]
2-972-003	B/W Image Request Timing	T14:low speed	ENG*	[0 to 4000 / 0 / 10msec/step]

3.SP Mode Tables

SP No.	Large Category	Small Category	ENG or CTL	[Min to Max/Init./Step]
2-974-001	Trans. Contact Fgate Timing: Y	Fwait:Y std	ENG*	[0 to 3000 / 0 / 10msec/step]
2-974-002	Trans. Contact Fgate Timing: Y	Fwait:Y mid	ENG*	[0 to 3000 / 0 / 10msec/step]
2-974-003	Trans. Contact Fgate Timing: Y	Fwait:Y low	ENG*	[0 to 3000 / 0 / 10msec/step]
2-980-001	LubricantApplication Operation	Lubricant Application Setting	ENG*	IM C3500: [0 to 300 / 100 / 10page/step] IM C2500: [0 to 300 / 0 / 10page/step] IM C2000: [0 to 300 / 0 / 10page/step] IM C3000: [0 to 300 / 100 / 10page/step]
2-980-002	LubricantApplication Operation	Idle Time: BK	ENG*	IM C3500: [0 to 600 / 30 / 1sec/step] IM C2500: [0 to 600 / 1 / 1sec/step] IM C2000: [0 to 600 / 1 / 1sec/step] IM C3000: [0 to 600 / 30 / 1sec/step]
2-980-003	LubricantApplication Operation	Idle Time: FC	ENG*	IM C3500: [0 to 600 / 30 / 1sec/step]

3.SP Mode Tables

SP No.	Large Category	Small Category	ENG or CTL	[Min to Max/Init./Step]
				IM C2500: [0 to 600 / 1 / 1sec/step] IM C2000: [0 to 600 / 1 / 1sec/step] IM C3000: [0 to 600 / 30 / 1sec/step]
2-990-001	Print Duty Control	Duty Control State	ENG*	[0 to 2 / 0 / 1/step]
2-990-002	Print Duty Control	Exec Interval: Duty Control	ENG*	[60 to 3600 / 60 / 10sec/step]
2-990-004	Print Duty Control	Forced CPM Down Thresh: No Duty Control	ENG*	[0 to 5000 / 0 / 1page/step]
2-990-005	Print Duty Control	Down-time_BW: No Duty Control	ENG*	[0 to 20000 / 0 / 10msec/step]
2-990-006	Print Duty Control	Down-time_FC: No Duty Control	ENG*	[0 to 20000 / 0 / 10msec/step]
2-990-007	Print Duty Control	Forced CPM Down Thresh: Duty Control	ENG*	IM C3500: [0 to 5000 / 20 / 1page/step] IM C2500: [0 to 5000 / 8 / 1page/step] IM C2000: [0 to 5000 / 8 / 1page/step] IM C3000: [0 to 5000 / 20 / 1page/step]

3.SP Mode Tables

SP No.	Large Category	Small Category	ENG or CTL	[Min to Max/Init./Step]
2-990-008	Print Duty Control	Down-time_BW: Duty Control	ENG*	IM C3500: [0 to 240000 / 25000 / 10msec/step] IM C2500: [0 to 240000 / 60000 / 10msec/step] IM C2000: [0 to 240000 / 60000 / 10msec/step] IM C3000: [0 to 240000 / 25000 / 10msec/step]
2-990-009	Print Duty Control	Down-time_FC: Duty Control	ENG*	IM C3500: [0 to 240000 / 25000 / 10msec/step] IM C2500: [0 to 240000 / 60000 / 10msec/step] IM C2000: [0 to 240000 / 60000 / 10msec/step] IM C3000: [0 to 240000 / 25000 / 10msec/step]
2-990-010	Print Duty Control	Ambient Temp Correction Coeff	ENG*	[-1.0 to 1.0 / 0.0 / 0.1/step]
2-	Print Duty Control	Execution Temp. Threshold	ENG*	IM C3500:

3.SP Mode Tables

SP No.	Large Category	Small Category	ENG or CTL	[Min to Max/Init./Step]
990-011				[20.0 to 70.0 / 41.0 / 0.1deg/step] IM C2500: [20.0 to 70.0 / 38.5 / 0.1deg/step] IM C2000: [20.0 to 70.0 / 38.5 / 0.1deg/step] IM C3000: [20.0 to 70.0 / 41.0 / 0.1deg/step]
2-990-012	Print Duty Control	Cancellation Temp. Threshold	ENG*	[0.1 to 20.0 / 0.1 / 0.1deg/step]
2-990-013	Print Duty Control	ON/OFF Setting	ENG*	[0 to 1 / 1 / 1/step]
2-990-014	Print Duty Control	Duty Control_Down-time_BW	ENG*	[0 to 240000 / 0 / 10msec/step]
2-990-015	Print Duty Control	Duty Control_Down-time_FC	ENG*	[0 to 240000 / 0 / 10msec/step]
2-990-041	Print Duty Control	ON/OFF Setting: BL Protection	ENG*	IM C3500: [0 to 1 / 0 / 1/step] IM C2500: [0 to 1 / 0 / 1/step] IM C2000: [0 to 1 / 0 / 1/step]

3.SP Mode Tables

SP No.	Large Category	Small Category	ENG or CTL	[Min to Max/Init./Step]
				IM C3000: [0 to 1 / 0 / 1/step]
2-990-051	Print Duty Control	Execution Temp. Threshold: BL Protection	ENG*	IM C3500: [20.0 to 70.0 / 35.0 / 0.1deg/step] IM C2500: [20.0 to 70.0 / 35.0 / 0.1deg/step] IM C2000: [20.0 to 70.0 / 35.0 / 0.1deg/step] IM C3000: [20.0 to 70.0 / 35.0 / 0.1deg/step]
2-990-052	Print Duty Control	Cancellation Temp. Threshold: BL Protection	ENG*	[0.1 to 20.0 / 0.1 / 0.1deg/step]
2-990-057	Print Duty Control	Forced CPM Down Thresh: BL Protection	ENG*	IM C3500: [0 to 5000 / 50 / 1page/step] IM C2500: [0 to 5000 / 50 / 1page/step] IM C2000: [0 to 5000 / 50 / 1page/step] IM C3000: [0 to 5000 / 50 / 1page/step]
2-990-	Print Duty Control	Down-time_BW: Duty Control: BL Protection	ENG*	[0 to 240000 / 0 /

3.SP Mode Tables

SP No.	Large Category	Small Category	ENG or CTL	[Min to Max/Init./Step]
058				10msec/step]
2-990-059	Print Duty Control	Down-time_FC: Duty Control: BL Protection	ENG*	[0 to 240000 / 0 / 10msec/step]
2-998-002	Engine Design Area UL	UL02	ENG*	[0 to 0xFFFFFFFF / 1 / 1/step]
2-998-003	Engine Design Area UL	UL03	ENG*	[0 to 0xFFFFFFFF / 1 / 1/step]
2-998-004	Engine Design Area UL	UL04	ENG*	[0 to 0xFFFFFFFF / 1 / 1/step]
2-998-005	Engine Design Area UL	UL05	ENG*	[0 to 0xFFFFFFFF / 1 / 1/step]
2-998-006	Engine Design Area UL	UL06	ENG*	[0 to 0xFFFFFFFF / 1 / 1/step]
2-998-007	Engine Design Area UL	UL07	ENG*	[0 to 0xFFFFFFFF / 1 / 1/step]
2-998-008	Engine Design Area UL	UL08	ENG*	[0 to 0xFFFFFFFF / 1 / 1/step]
2-998-009	Engine Design Area UL	UL09	ENG*	[0 to 0xFFFFFFFF / 1 / 1/step]
2-998-010	Engine Design Area UL	UL10	ENG*	[0 to 0xFFFFFFFF / 1 / 1/step]
2-998-011	Engine Design Area UL	UL11	ENG*	[0 to 0xFFFFFFFF / 1 / 1/step]

Engine SP Tables-3

SP3-XXX (Process)

SP No.	Large Category	Small Category	ENG or CTL	[Min to Max/Init./Step]
3-011-001	Manual ProCon :Exe	Normal ProCon	ENG	[0 to 1 / 0 / 1/step]
3-011-002	Manual ProCon :Exe	Density Adjustment	ENG	[0 to 1 / 0 / 1/step]
3-011-003	Manual ProCon :Exe	ACC RunTime ProCon	ENG	[0 to 1 / 0 / 1/step]
3-011-004	Manual ProCon :Exe	Full MUSIC	ENG	[0 to 1 / 0 / 1/step]
3-011-005	Manual ProCon :Exe	Normal MUSIC	ENG	[0 to 1 / 0 / 1/step]
3-012-001	ProCon OK?	History:Last(Front)	ENG*	[0 to 99999999 / 0 / 1/step]
3-012-002	ProCon OK?	History:Last 2(Front)	ENG*	[0 to 99999999 / 0 / 1/step]
3-012-003	ProCon OK?	History:Last 3(Front)	ENG*	[0 to 99999999 / 0 / 1/step]
3-012-004	ProCon OK?	History:Last 4(Front)	ENG*	[0 to 99999999 / 0 / 1/step]
3-012-005	ProCon OK?	History:Last 5(Front)	ENG*	[0 to 99999999 / 0 / 1/step]
3-012-	ProCon OK?	History:Last 6(Front)	ENG*	[0 to 99999999 / 0 / 1/step]

3.SP Mode Tables

SP No.	Large Category	Small Category	ENG or CTL	[Min to Max/Init./Step]
006				
3-012-007	ProCon OK?	History:Last 7(Front)	ENG*	[0 to 99999999 / 0 / 1/step]
3-012-008	ProCon OK?	History:Last 8(Front)	ENG*	[0 to 99999999 / 0 / 1/step]
3-012-009	ProCon OK?	History:Last 9(Front)	ENG*	[0 to 99999999 / 0 / 1/step]
3-012-010	ProCon OK?	History:Last 10(Front)	ENG*	[0 to 99999999 / 0 / 1/step]
3-012-011	ProCon OK?	History:Last(Center)	ENG*	[0 to 99999999 / 0 / 1/step]
3-012-012	ProCon OK?	History:Last 2(Center)	ENG*	[0 to 99999999 / 0 / 1/step]
3-012-013	ProCon OK?	History:Last 3(Center)	ENG*	[0 to 99999999 / 0 / 1/step]
3-012-014	ProCon OK?	History:Last 4(Center)	ENG*	[0 to 99999999 / 0 / 1/step]
3-012-015	ProCon OK?	History:Last 5(Center)	ENG*	[0 to 99999999 / 0 / 1/step]
3-012-016	ProCon OK?	History:Last 6(Center)	ENG*	[0 to 99999999 / 0 / 1/step]
3-012-017	ProCon OK?	History:Last 7(Center)	ENG*	[0 to 99999999 / 0 / 1/step]
3-	ProCon OK?	History:Last 8(Center)	ENG*	[0 to 99999999 / 0 /

3.SP Mode Tables

SP No.	Large Category	Small Category	ENG or CTL	[Min to Max/Init./Step]
012-018				1/step]
3-012-019	ProCon OK?	History:Last 9(Center)	ENG*	[0 to 99999999 / 0 / 1/step]
3-012-020	ProCon OK?	History:Last 10(Center)	ENG*	[0 to 99999999 / 0 / 1/step]
3-012-021	ProCon OK?	History:Last(Rear)	ENG*	[0 to 99999999 / 0 / 1/step]
3-012-022	ProCon OK?	History:Last 2(Rear)	ENG*	[0 to 99999999 / 0 / 1/step]
3-012-023	ProCon OK?	History:Last 3(Rear)	ENG*	[0 to 99999999 / 0 / 1/step]
3-012-024	ProCon OK?	History:Last 4(Rear)	ENG*	[0 to 99999999 / 0 / 1/step]
3-012-025	ProCon OK?	History:Last 5(Rear)	ENG*	[0 to 99999999 / 0 / 1/step]
3-012-026	ProCon OK?	History:Last 6(Rear)	ENG*	[0 to 99999999 / 0 / 1/step]
3-012-027	ProCon OK?	History:Last 7(Rear)	ENG*	[0 to 99999999 / 0 / 1/step]
3-012-028	ProCon OK?	History:Last 8(Rear)	ENG*	[0 to 99999999 / 0 / 1/step]
3-012-029	ProCon OK?	History:Last 9(Rear)	ENG*	[0 to 99999999 / 0 / 1/step]

3.SP Mode Tables

SP No.	Large Category	Small Category	ENG or CTL	[Min to Max/Init./Step]
3-012-030	ProCon OK?	History:Last 10(Rear)	ENG*	[0 to 99999999 / 0 / 1/step]
3-014-001	IBACC OK?	History:Last	ENG*	[0 to 9999 / 0 / 1/step]
3-014-002	IBACC OK?	History:Last 2	ENG*	[0 to 9999 / 0 / 1/step]
3-014-003	IBACC OK?	History:Last 3	ENG*	[0 to 9999 / 0 / 1/step]
3-014-004	IBACC OK?	History:Last 4	ENG*	[0 to 9999 / 0 / 1/step]
3-014-005	IBACC OK?	History:Last 5	ENG*	[0 to 9999 / 0 / 1/step]
3-014-006	IBACC OK?	History:Last 6	ENG*	[0 to 9999 / 0 / 1/step]
3-014-007	IBACC OK?	History:Last 7	ENG*	[0 to 9999 / 0 / 1/step]
3-014-008	IBACC OK?	History:Last 8	ENG*	[0 to 9999 / 0 / 1/step]
3-014-009	IBACC OK?	History:Last 9	ENG*	[0 to 9999 / 0 / 1/step]
3-014-010	IBACC OK?	History:Last 10	ENG*	[0 to 9999 / 0 / 1/step]
3-015-001	Background Pot ProCon OK?	History:Front:Latest	ENG*	[0 to 9999 / 0 / 1/step]

3.SP Mode Tables

SP No.	Large Category	Small Category	ENG or CTL	[Min to Max/Init./Step]
3-015-002	Background Pot ProCon OK?	History:Front:Last 2	ENG*	[0 to 9999 / 0 / 1/step]
3-015-003	Background Pot ProCon OK?	History:Front:Last 3	ENG*	[0 to 9999 / 0 / 1/step]
3-015-004	Background Pot ProCon OK?	History:Front:Last 4	ENG*	[0 to 9999 / 0 / 1/step]
3-015-005	Background Pot ProCon OK?	History:Front:Last 5	ENG*	[0 to 9999 / 0 / 1/step]
3-015-006	Background Pot ProCon OK?	history:Center:Latest	ENG*	[0 to 9999 / 0 / 1/step]
3-015-007	Background Pot ProCon OK?	History:Center:Last 2	ENG*	[0 to 9999 / 0 / 1/step]
3-015-008	Background Pot ProCon OK?	History:Center:Last 3	ENG*	[0 to 9999 / 0 / 1/step]
3-015-009	Background Pot ProCon OK?	History:Center:Last 4	ENG*	[0 to 9999 / 0 / 1/step]
3-015-010	Background Pot ProCon OK?	History:Center:Last 5	ENG*	[0 to 9999 / 0 / 1/step]
3-015-011	Background Pot ProCon OK?	history:Rear:Latest	ENG*	[0 to 9999 / 0 / 1/step]
3-015-012	Background Pot ProCon OK?	History:Rear:Last 2	ENG*	[0 to 9999 / 0 / 1/step]
3-015-013	Background Pot ProCon OK?	History:Rear:Last 3	ENG*	[0 to 9999 / 0 / 1/step]

3.SP Mode Tables

SP No.	Large Category	Small Category	ENG or CTL	[Min to Max/Init./Step]
3-015-014	Background Pot ProCon OK?	History:Rear>Last 4	ENG*	[0 to 9999 / 0 / 1/step]
3-015-015	Background Pot ProCon OK?	History:Rear>Last 5	ENG*	[0 to 9999 / 0 / 1/step]
3-030-001	Init TD Sensor :Exe	Execute: ALL	ENG	[0 to 1 / 0 / 1/step]
3-030-002	Init TD Sensor :Exe	Execute: Col	ENG	[0 to 1 / 0 / 1/step]
3-030-003	Init TD Sensor :Exe	Execute: K	ENG	[0 to 1 / 0 / 1/step]
3-030-004	Init TD Sensor :Exe	Execute: C	ENG	[0 to 1 / 0 / 1/step]
3-030-005	Init TD Sensor :Exe	Execute: M	ENG	[0 to 1 / 0 / 1/step]
3-030-006	Init TD Sensor :Exe	Execute: Y	ENG	[0 to 1 / 0 / 1/step]
3-030-071	Init TD Sensor :Exe	Init Temp: K	ENG*	[-100.0 to 100.0 / 23.0 / 0.1deg/step]
3-030-072	Init TD Sensor :Exe	Init Temp: C	ENG*	[-100.0 to 100.0 / 23.0 / 0.1deg/step]
3-030-073	Init TD Sensor :Exe	Init Temp: M	ENG*	[-100.0 to 100.0 / 23.0 / 0.1deg/step]
3-030-074	Init TD Sensor :Exe	Init Temp: Y	ENG*	[-100.0 to 100.0 / 23.0 / 0.1deg/step]

3.SP Mode Tables

SP No.	Large Category	Small Category	ENG or CTL	[Min to Max/Init./Step]
3-030-081	Init TD Sensor :Exe	Init Rel Hum: K	ENG*	[0.0 to 100.0 / 50.0 / 0.1%RH/step]
3-030-082	Init TD Sensor :Exe	Init Rel Hum: C	ENG*	[0.0 to 100.0 / 50.0 / 0.1%RH/step]
3-030-083	Init TD Sensor :Exe	Init Rel Hum: M	ENG*	[0.0 to 100.0 / 50.0 / 0.1%RH/step]
3-030-084	Init TD Sensor :Exe	Init Rel Hum: Y	ENG*	[0.0 to 100.0 / 50.0 / 0.1%RH/step]
3-030-091	Init TD Sensor :Exe	Init Abs Hum: K	ENG*	[0.00 to 100.00 / 10.30 / 0.01g/m3/step]
3-030-092	Init TD Sensor :Exe	Init Abs Hum: C	ENG*	[0.00 to 100.00 / 10.30 / 0.01g/m3/step]
3-030-093	Init TD Sensor :Exe	Init Abs Hum: M	ENG*	[0.00 to 100.00 / 10.30 / 0.01g/m3/step]
3-030-094	Init TD Sensor :Exe	Init Abs Hum: Y	ENG*	[0.00 to 100.00 / 10.30 / 0.01g/m3/step]
3-031-001	TD Sens Init OK?	From Left:YMCK	ENG*	[0 to 9999 / 0 / 1/step]
3-050-001	Force Tnr Supply :Exe	Execute: ALL	ENG	[0 to 1 / 0 / 1/step]
3-050-002	Force Tnr Supply :Exe	Execute: Col	ENG	[0 to 1 / 0 / 1/step]
3-050-003	Force Tnr Supply :Exe	Execute: K	ENG	[0 to 1 / 0 / 1/step]

3.SP Mode Tables

SP No.	Large Category	Small Category	ENG or CTL	[Min to Max/Init./Step]
3-050-004	Force Tnr Supply :Exe	Execute: C	ENG	[0 to 1 / 0 / 1/step]
3-050-005	Force Tnr Supply :Exe	Execute: M	ENG	[0 to 1 / 0 / 1/step]
3-050-006	Force Tnr Supply :Exe	Execute: Y	ENG	[0 to 1 / 0 / 1/step]
3-050-021	Force Tnr Supply :Exe	Supply Quantity:K	ENG*	[0.0 to 5.0 / 0.5 / 0.1wt%/step]
3-050-022	Force Tnr Supply :Exe	Supply Quantity:C	ENG*	[0.0 to 5.0 / 0.5 / 0.1wt%/step]
3-050-023	Force Tnr Supply :Exe	Supply Quantity:M	ENG*	[0.0 to 5.0 / 0.5 / 0.1wt%/step]
3-050-024	Force Tnr Supply :Exe	Supply Quantity:Y	ENG*	[0.0 to 5.0 / 0.5 / 0.1wt%/step]
3-050-033	Force Tnr Supply :Exe	RepeatCount	ENG*	[0 to 255 / 8 / 1times/step]
3-072-001	T Sensor: Check	Execute Check	ENG	[0 to 1 / 0 / 1/step]
3-073-001	T Sensor Measurement Value:	mu count:K	ENG*	[0 to 65535 / 0 / 1/step]
3-073-002	T Sensor Measurement Value:	mu count:C	ENG*	[0 to 65535 / 0 / 1/step]
3-073-003	T Sensor Measurement Value:	mu count:M	ENG*	[0 to 65535 / 0 / 1/step]

3.SP Mode Tables

SP No.	Large Category	Small Category	ENG or CTL	[Min to Max/Init./Step]
3-073-004	T Sensor Measurement Value:	mu count:Y	ENG*	[0 to 65535 / 0 / 1/step]
3-100-001	Tonner End Detection: Set	ON/OFF	ENG*	[0 to 1 / 0 / 1/step]
3-100-002	Tonner End Detection: Set	NE Detection	ENG*	[0 to 1 / 0 / 1/step]
3-100-003	Toner End Detection: Set	Estimated NE Detection	ENG*	[0 to 3 / 1 / 1/step]
3-101-001	Toner Status :Disp	K	ENG*	[0 to 10 / 10 / 1/step]
3-101-002	Toner Status :Disp	C	ENG*	[0 to 10 / 10 / 1/step]
3-101-003	Toner Status :Disp	M	ENG*	[0 to 10 / 10 / 1/step]
3-101-004	Toner Status :Disp	Y	ENG*	[0 to 10 / 10 / 1/step]
3-102-001	Toner Remain:Disp	Bottle Motor: Bk	ENG*	[0.000 to 700.000 / 560.000 / 0.001g/step]
3-102-002	Toner Remain:Disp	Bottle Motor: C	ENG*	[0.000 to 700.000 / 440.000 / 0.001g/step]
3-102-003	Toner Remain:Disp	Bottle Motor: M	ENG*	[0.000 to 700.000 / 440.000 / 0.001g/step]
3-102-004	Toner Remain:Disp	Bottle Motor: Y	ENG*	[0.000 to 700.000 / 440.000 / 0.001g/step]

3.SP Mode Tables

SP No.	Large Category	Small Category	ENG or CTL	[Min to Max/Init./Step]
3-102-011	Toner Remain:Disp	Pixel: Bk	ENG*	[0.000 to 700.000 / 560.000 / 0.001g/step]
3-102-012	Toner Remain:Disp	Pixel: C	ENG*	[0.000 to 700.000 / 440.000 / 0.001g/step]
3-102-013	Toner Remain:Disp	Pixel: M	ENG*	[0.000 to 700.000 / 440.000 / 0.001g/step]
3-102-014	Toner Remain:Disp	Pixel: Y	ENG*	[0.000 to 700.000 / 440.000 / 0.001g/step]
3-102-021	Toner Remaining: Display	Fill Amount: Bk	ENG*	[0 to 600 / 560 / 1g/step]
3-102-022	Toner Remaining: Display	Fill Amount: C	ENG*	[0 to 600 / 440 / 1g/step]
3-102-023	Toner Remaining: Display	Fill Amount: M	ENG*	[0 to 600 / 440 / 1g/step]
3-102-024	Toner Remaining: Display	Fill Amount: Y	ENG*	[0 to 600 / 440 / 1g/step]
3-102-031	Toner Remain:Disp	Pixel: Toner Consumption x 2: Bk	ENG*	[0.000 to 1000.000 / 0.000 / 0.001g/step]
3-102-032	Toner Remain:Disp	Pixel: Toner Consumption x 2: C	ENG*	[0.000 to 1000.000 / 0.000 / 0.001g/step]
3-102-033	Toner Remain:Disp	Pixel: Toner Consumption x 2: M	ENG*	[0.000 to 1000.000 / 0.000 / 0.001g/step]
3-102-034	Toner Remain:Disp	Pixel: Toner Consumption x 2: Y	ENG*	[0.000 to 1000.000 / 0.000 / 0.001g/step]

3.SP Mode Tables

SP No.	Large Category	Small Category	ENG or CTL	[Min to Max/Init./Step]
3-102-041	Toner Remain:Disp	Drive Motor: Toner Consumption x 1: Bk	ENG*	[0.000 to 1000.000 / 0.000 / 0.001g/step]
3-102-042	Toner Remain:Disp	Drive Motor: Toner Consumption x 1: C	ENG*	[0.000 to 1000.000 / 0.000 / 0.001g/step]
3-102-043	Toner Remain:Disp	Drive Motor: Toner Consumption x 1: M	ENG*	[0.000 to 1000.000 / 0.000 / 0.001g/step]
3-102-044	Toner Remain:Disp	Drive Motor: Toner Consumption x 1: Y	ENG*	[0.000 to 1000.000 / 0.000 / 0.001g/step]
3-102-051	Toner Remain:Disp	Calculated Toner Consumption: Bk	ENG*	[0.000 to 1000.000 / 0.000 / 0.001g/step]
3-102-052	Toner Remain:Disp	Calculated Toner Consumption: C	ENG*	[0.000 to 1000.000 / 0.000 / 0.001g/step]
3-102-053	Toner Remain:Disp	Calculated Toner Consumption: M	ENG*	[0.000 to 1000.000 / 0.000 / 0.001g/step]
3-102-054	Toner Remain:Disp	Calculated Toner Consumption: Y	ENG*	[0.000 to 1000.000 / 0.000 / 0.001g/step]
3-104-001	Flag: Display	NE Toner: Bk	ENG*	[0 to 1 / 0 / 1/step]
3-104-002	Flag: Display	NE Toner: C	ENG*	[0 to 1 / 0 / 1/step]
3-104-003	Flag: Display	NE Toner: M	ENG*	[0 to 1 / 0 / 1/step]
3-104-004	Flag: Display	NE Toner: Y	ENG*	[0 to 1 / 0 / 1/step]

3.SP Mode Tables

SP No.	Large Category	Small Category	ENG or CTL	[Min to Max/Init./Step]
3-104-011	Flag: Display	Vt end:Bk	ENG*	[0 to 1 / 0 / 1/step]
3-104-012	Flag: Display	Vt end:C	ENG*	[0 to 1 / 0 / 1/step]
3-104-013	Flag: Display	Vt end:M	ENG*	[0 to 1 / 0 / 1/step]
3-104-014	Flag: Display	Vt end:Y	ENG*	[0 to 1 / 0 / 1/step]
3-110-001	Near End Thresh 1	Bk	ENG*	IM C3500: [0 to 500 / 65 / 1g/step] IM C2500: [0 to 500 / 65 / 1g/step] IM C2000: [0 to 500 / 65 / 1g/step] IM C3000: [0 to 500 / 65 / 1g/step]
3-110-002	Near End Thresh 1	C	ENG*	IM C3500: [0 to 500 / 45 / 1g/step] IM C2500: [0 to 500 / 45 / 1g/step] IM C2000: [0 to 500 / 45 / 1g/step] IM C3000: [0 to 500 / 45 / 1g/step]

SP No.	Large Category	Small Category	ENG or CTL	[Min to Max/Init./Step]
3-110-003	Near End Thresh 1	M	ENG*	IM C3500: [0 to 500 / 45 / 1g/step] IM C2500: [0 to 500 / 45 / 1g/step] IM C2000: [0 to 500 / 45 / 1g/step] IM C3000: [0 to 500 / 45 / 1g/step]
3-110-004	Near End Thresh 1	Y	ENG*	IM C3500: [0 to 500 / 45 / 1g/step] IM C2500: [0 to 500 / 45 / 1g/step] IM C2000: [0 to 500 / 45 / 1g/step] IM C3000: [0 to 500 / 45 / 1g/step]
3-110-011	Near End Thresh 2	Bk	ENG*	[0 to 500 / 65 / 1g/step]
3-110-012	Near End Thresh 2	C	ENG*	[0 to 500 / 65 / 1g/step]
3-110-013	Near End Thresh 2	M	ENG*	[0 to 500 / 65 / 1g/step]
3-110-014	Near End Thresh 2	Y	ENG*	[0 to 500 / 65 / 1g/step]

3.SP Mode Tables

SP No.	Large Category	Small Category	ENG or CTL	[Min to Max/Init./Step]
3-110-021	NE Thresh 2 Upper Limit :Set	Bk	ENG*	[0 to 600 / 600 / 1g/step]
3-110-022	NE Thresh 2 Upper Limit :Set	C	ENG*	[0 to 600 / 600 / 1g/step]
3-110-023	NE Thresh 2 Upper Limit :Set	M	ENG*	[0 to 600 / 600 / 1g/step]
3-110-024	NE Thresh 2 Upper Limit :Set	Y	ENG*	[0 to 600 / 600 / 1g/step]
3-110-031	NE Thresh 2 Lower Limit :Set	Bk	ENG*	[0 to 600 / 20 / 1g/step]
3-110-032	NE Thresh 2 Lower Limit :Set	C	ENG*	[0 to 600 / 20 / 1g/step]
3-110-033	NE Thresh 2 Lower Limit :Set	M	ENG*	[0 to 600 / 20 / 1g/step]
3-110-034	NE Thresh 2 Lower Limit :Set	Y	ENG*	[0 to 600 / 20 / 1g/step]
3-112-001	Near End Thresh 2 (Day)	Bk	ENG*	[0 to 2000 / 15 / 1day/step]
3-112-002	Near End Thresh 2 (Day)	C	ENG*	[0 to 2000 / 15 / 1day/step]
3-112-003	Near End Thresh 2 (Day)	M	ENG*	[0 to 2000 / 15 / 1day/step]
3-112-004	Near End Thresh 2 (Day)	Y	ENG*	[0 to 2000 / 15 / 1day/step]

3.SP Mode Tables

SP No.	Large Category	Small Category	ENG or CTL	[Min to Max/Init./Step]
3-113-001	Correction Factor Ave.	Bk	ENG*	IM C3500: [0.000 to 2.000 / 0.865 / 0.001/step] IM C2500: [0.000 to 2.000 / 0.865 / 0.001/step] IM C2000: [0.000 to 2.000 / 0.865 / 0.001/step] IM C3000: [0.000 to 2.000 / 0.865 / 0.001/step]
3-113-002	Correction Factor Ave.	C	ENG*	IM C3500: [0.000 to 2.000 / 0.816 / 0.001/step] IM C2500: [0.000 to 2.000 / 0.816 / 0.001/step] IM C2000: [0.000 to 2.000 / 0.816 / 0.001/step] IM C3000: [0.000 to 2.000 / 0.816 / 0.001/step]
3-113-003	Correction Factor Ave.	M	ENG*	IM C3500: [0.000 to 2.000 / 0.853 / 0.001/step] IM C2500: [0.000 to 2.000 / 0.853 / 0.001/step] IM C2000: [0.000 to 2.000 / 0.853 / 0.001/step] IM C3000: [0.000 to 2.000 / 0.853 / 0.001/step]

3.SP Mode Tables

SP No.	Large Category	Small Category	ENG or CTL	[Min to Max/Init./Step]
3-113-004	Correction Factor Ave.	Y	ENG*	IM C3500: [0.000 to 2.000 / 0.860 / 0.001/step] IM C2500: [0.000 to 2.000 / 0.860 / 0.001/step] IM C2000: [0.000 to 2.000 / 0.860 / 0.001/step] IM C3000: [0.000 to 2.000 / 0.860 / 0.001/step]
3-114-001	Correction Factor Dispersion	Bk	ENG*	IM C3500: [0.000 to 1.000 / 0.044 / 0.001/step] IM C2500: [0.000 to 1.000 / 0.044 / 0.001/step] IM C2000: [0.000 to 1.000 / 0.044 / 0.001/step] IM C3000: [0.000 to 1.000 / 0.044 / 0.001/step]
3-114-002	Correction Factor Dispersion	C	ENG*	IM C3500: [0.000 to 1.000 / 0.083 / 0.001/step] IM C2500: [0.000 to 1.000 / 0.083 / 0.001/step] IM C2000: [0.000 to 1.000 / 0.083 / 0.001/step] IM C3000: [0.000 to 1.000 / 0.083 / 0.001/step]

3.SP Mode Tables

SP No.	Large Category	Small Category	ENG or CTL	[Min to Max/Init./Step]
3-114-003	Correction Factor Dispersion	M	ENG*	IM C3500: [0.000 to 1.000 / 0.063 / 0.001/step] IM C2500: [0.000 to 1.000 / 0.063 / 0.001/step] IM C2000: [0.000 to 1.000 / 0.063 / 0.001/step] IM C3000: [0.000 to 1.000 / 0.063 / 0.001/step]
3-114-004	Correction Factor Dispersion	Y	ENG*	IM C3500: [0.000 to 1.000 / 0.060 / 0.001/step] IM C2500: [0.000 to 1.000 / 0.060 / 0.001/step] IM C2000: [0.000 to 1.000 / 0.060 / 0.001/step] IM C3000: [0.000 to 1.000 / 0.060 / 0.001/step]
3-115-001	Ordered Flag	Bk	ENG*	[0 to 2000 / 0 / 1/step]
3-115-002	Ordered Flag	C	ENG*	[0 to 2000 / 0 / 1/step]
3-115-003	Ordered Flag	M	ENG*	[0 to 2000 / 0 / 1/step]
3-115-004	Ordered Flag	Y	ENG*	[0 to 2000 / 0 / 1/step]

3.SP Mode Tables

SP No.	Large Category	Small Category	ENG or CTL	[Min to Max/Init./Step]
3-116-001	Dates of Thresh	Bk	ENG*	[0 to 2000 / 14 / 1day/step]
3-116-002	Dates of Thresh	C	ENG*	[0 to 2000 / 14 / 1day/step]
3-116-003	Dates of Thresh	M	ENG*	[0 to 2000 / 14 / 1day/step]
3-116-004	Dates of Thresh	Y	ENG*	[0 to 2000 / 14 / 1day/step]
3-121-001	TE Counter: Disp	Bk	ENG*	[0 to 99 / 0 / 1times/step]
3-121-002	TE Counter: Disp	C	ENG*	[0 to 99 / 0 / 1times/step]
3-121-003	TE Counter: Disp	M	ENG*	[0 to 99 / 0 / 1times/step]
3-121-004	TE Counter: Disp	Y	ENG*	[0 to 99 / 0 / 1times/step]
3-121-011	TE Counter: Clearcount	Bk	ENG*	[0 to 10 / 0 / 1times/step]
3-121-012	TE Counter: Clearcount	C	ENG*	[0 to 10 / 0 / 1times/step]
3-121-013	TE Counter: Clearcount	M	ENG*	[0 to 10 / 0 / 1times/step]
3-121-014	TE Counter: Clearcount	Y	ENG*	[0 to 10 / 0 / 1times/step]

3.SP Mode Tables

SP No.	Large Category	Small Category	ENG or CTL	[Min to Max/Init./Step]
3-131-001	Vt TE Thresh	Delta Vt Thresh	ENG*	[0.00 to 5.00 / 0.50 / 0.01V/step]
3-131-002	Vt TE Thresh	Delta Vt Sum Thresh	ENG*	[0 to 99 / 10 / 1V/step]
3-131-011	Vt TE Thresh	Delta Vt Thresh BF NE	ENG*	[0.00 to 5.00 / 0.50 / 0.01V/step]
3-131-012	Vt TE Thresh	Delta Vt Sum Thresh BF NE	ENG*	[0 to 99 / 10 / 1V/step]
3-132-001	Delta Vt Sum	Bk	ENG*	[0.00 to 99.00 / 0.00 / 0.01V/step]
3-132-002	Delta Vt Sum	C	ENG*	[0.00 to 99.00 / 0.00 / 0.01V/step]
3-132-003	Delta Vt Sum	M	ENG*	[0.00 to 99.00 / 0.00 / 0.01V/step]
3-132-004	Delta Vt Sum	Y	ENG*	[0.00 to 99.00 / 0.00 / 0.01V/step]
3-133-001	TE Detect :Set	Set Sheets(Min)	ENG*	[0 to 50 / 10 / 1sheets/step]
3-133-002	TE Detect :Set	Set Sheets(Max)	ENG*	[0 to 5000 / 1000 / 1sheets/step]
3-133-011	TE Detect :Set	Page Cnt:K	ENG*	[0 to 5000 / 0 / 1sheets/step]
3-133-012	TE Detect :Set	Page Cnt:C	ENG*	[0 to 5000 / 0 / 1sheets/step]

3.SP Mode Tables

SP No.	Large Category	Small Category	ENG or CTL	[Min to Max/Init./Step]
3-133-013	TE Detect :Set	Page Cnt:M	ENG*	[0 to 5000 / 0 / 1sheets/step]
3-133-014	TE Detect :Set	Page Cnt:Y	ENG*	[0 to 5000 / 0 / 1sheets/step]
3-133-021	TE Detect :Set	Set Pxl Cnt	ENG*	[0 to 1000000 / 3900 / 1cm2/step]
3-133-031	TE Detect :Set	Pxl Cnt:K	ENG*	[0 to 1000000 / 0 / 1cm2/step]
3-133-032	TE Detect :Set	Pxl Cnt:C	ENG*	[0 to 1000000 / 0 / 1cm2/step]
3-133-033	TE Detect :Set	Pxl Cnt:M	ENG*	[0 to 1000000 / 0 / 1cm2/step]
3-133-034	TE Detect :Set	Pxl Cnt:Y	ENG*	[0 to 1000000 / 0 / 1cm2/step]
3-134-001	Toner End Toner Remain	Bk	ENG*	[0.000 to 1000.000 / 20.000 / 0.001g/step]
3-134-002	Toner End Toner Remain	C	ENG*	[0.000 to 1000.000 / 20.000 / 0.001g/step]
3-134-003	Toner End Toner Remain	M	ENG*	[0.000 to 1000.000 / 20.000 / 0.001g/step]
3-134-004	Toner End Toner Remain	Y	ENG*	[0.000 to 1000.000 / 20.000 / 0.001g/step]
3-150-001	TE Sensor :Set	SamplingCount	ENG*	[4 to 20 / 10 / 1counts/step]

3.SP Mode Tables

SP No.	Large Category	Small Category	ENG or CTL	[Min to Max/Init./Step]
3-150-002	TE Sensor :Set	Judge:p	ENG*	[0.2 to 1.0 / 0.8 / 0.1/step]
3-150-003	TE Sensor :Set	result:K	ENG*	[0.0 to 1.0 / 0.5 / 0.1/step]
3-150-004	TE Sensor :Set	result:C	ENG*	[0.0 to 1.0 / 0.5 / 0.1/step]
3-150-005	TE Sensor :Set	result:M	ENG*	[0.0 to 1.0 / 0.5 / 0.1/step]
3-150-006	TE Sensor :Set	result:Y	ENG*	[0.0 to 1.0 / 0.5 / 0.1/step]
3-160-001	Bottle Drive :Set	Bottle Drive System	ENG*	[0 to 1 / 0 / 1/step]
3-200-001	TnrDensity	K	ENG*	[0.0 to 25.5 / 0.0 / 0.1wt%/step]
3-200-002	TnrDensity	C	ENG*	[0.0 to 25.5 / 0.0 / 0.1wt%/step]
3-200-003	TnrDensity	M	ENG*	[0.0 to 25.5 / 0.0 / 0.1wt%/step]
3-200-004	TnrDensity	Y	ENG*	[0.0 to 25.5 / 0.0 / 0.1wt%/step]
3-201-001	TnrDensity	Upper TC_K	ENG*	[1.0 to 15.0 / 9.0 / 0.1wt%/step]
3-201-002	TnrDensity	Upper TC_C	ENG*	[1.0 to 15.0 / 9.0 / 0.1wt%/step]

3.SP Mode Tables

SP No.	Large Category	Small Category	ENG or CTL	[Min to Max/Init./Step]
3-201-003	TnrDensity	Upper TC_M	ENG*	[1.0 to 15.0 / 9.0 / 0.1wt%/step]
3-201-004	TnrDensity	Upper TC_Y	ENG*	[1.0 to 15.0 / 9.0 / 0.1wt%/step]
3-201-011	TnrDensity	Lower TC_K	ENG*	IM C3500: [-1.0 to 15.0 / 1.0 / 0.1wt%/step] IM C2500: [-1.0 to 15.0 / 2.0 / 0.1wt%/step] IM C2000: [-1.0 to 15.0 / 2.0 / 0.1wt%/step] IM C3000: [-1.0 to 15.0 / 1.0 / 0.1wt%/step]
3-201-012	TnrDensity	Lower TC_C	ENG*	IM C3500: [-1.0 to 15.0 / 1.0 / 0.1wt%/step] IM C2500: [-1.0 to 15.0 / 2.0 / 0.1wt%/step] IM C2000: [-1.0 to 15.0 / 2.0 / 0.1wt%/step] IM C3000: [-1.0 to 15.0 / 1.0 / 0.1wt%/step]
3-201-013	TnrDensity	Lower TC_M	ENG*	IM C3500: [-1.0 to 15.0 / 1.0 / 0.1wt%/step] IM C2500: [-1.0 to 15.0 / 2.0 / 0.1wt%/step]

SP No.	Large Category	Small Category	ENG or CTL	[Min to Max/Init./Step]
				IM C2000: [-1.0 to 15.0 / 2.0 / 0.1wt%/step] IM C3000: [-1.0 to 15.0 / 1.0 / 0.1wt%/step]
3-201-014	TnrDensity	Lower TC_Y	ENG*	IM C3500: [-1.0 to 15.0 / 1.0 / 0.1wt%/step] IM C2500: [-1.0 to 15.0 / 2.0 / 0.1wt%/step] IM C2000: [-1.0 to 15.0 / 2.0 / 0.1wt%/step] IM C3000: [-1.0 to 15.0 / 1.0 / 0.1wt%/step]
3-205-051	TD.Sens Sensitivity	Mu Cnv Coef:K	ENG*	IM C3500: [0.001 to 0.100 / 0.017 / 0.001V/count/step] IM C2500: [0.001 to 0.100 / 0.014 / 0.001V/count/step] IM C2000: [0.001 to 0.100 / 0.014 / 0.001V/count/step] IM C3000: [0.001 to 0.100 / 0.017 / 0.001V/count/step]
3-205-	TD.Sens Sensitivity	Mu Cnv Coef:C	ENG*	[0.001 to 0.100 / 0.016 /

3.SP Mode Tables

SP No.	Large Category	Small Category	ENG or CTL	[Min to Max/Init./Step]
052				0.001V/count/step]
3-205-053	TD.Sens Sensitivity	Mu Cnv Coef:M	ENG*	[0.001 to 0.100 / 0.016 / 0.001V/count/step]
3-205-054	TD.Sens Sensitivity	Mu Cnv Coef:Y	ENG*	[0.001 to 0.100 / 0.016 / 0.001V/count/step]
3-205-101	TD.Sens Sensitivity	Bulk Density: K	ENG*	[-5.00 to 5.00 / 0.00 / 0.01V/step]
3-205-102	TD.Sens Sensitivity	Bulk Density: C	ENG*	[-5.00 to 5.00 / 0.00 / 0.01V/step]
3-205-103	TD.Sens Sensitivity	Bulk Density: M	ENG*	[-5.00 to 5.00 / 0.00 / 0.01V/step]
3-205-104	TD.Sens Sensitivity	Bulk Density: Y	ENG*	[-5.00 to 5.00 / 0.00 / 0.01V/step]
3-210-001	TD.Sens:Vt :Disp	Current: K	ENG*	[0.00 to 5.50 / 0.00 / 0.01V/step]
3-210-002	TD.Sens:Vt :Disp	Current: C	ENG*	[0.00 to 5.50 / 0.00 / 0.01V/step]
3-210-003	TD.Sens:Vt :Disp	Current: M	ENG*	[0.00 to 5.50 / 0.00 / 0.01V/step]
3-210-004	TD.Sens:Vt :Disp	Current: Y	ENG*	[0.00 to 5.50 / 0.00 / 0.01V/step]
3-212-101	Vt Shift :Set	TC Cor.(ON/OFF)	ENG*	[0 to 1 / 0 / 1/step]
3-	Vt Shift :Set	TC Mid Spd:K	ENG*	[-0.50 to 0.50 / 0.00 /

3.SP Mode Tables

SP No.	Large Category	Small Category	ENG or CTL	[Min to Max/Init./Step]
212-111				0.01V/step]
3-212-112	Vt Shift :Set	TC Mid Spd:C	ENG*	[-0.50 to 0.50 / 0.00 / 0.01V/step]
3-212-113	Vt Shift :Set	TC Mid Spd:M	ENG*	[-0.50 to 0.50 / 0.00 / 0.01V/step]
3-212-114	Vt Shift :Set	TC Mid Spd:Y	ENG*	[-0.50 to 0.50 / 0.00 / 0.01V/step]
3-212-121	Vt Shift :Set	TC Low Spd:K	ENG*	[-0.50 to 0.50 / 0.00 / 0.01V/step]
3-212-122	Vt Shift :Set	TC Low Spd:C	ENG*	[-0.50 to 0.50 / 0.00 / 0.01V/step]
3-212-123	Vt Shift :Set	TC Low Spd:M	ENG*	[-0.50 to 0.50 / 0.00 / 0.01V/step]
3-212-124	Vt Shift :Set	TC Low Spd:Y	ENG*	[-0.50 to 0.50 / 0.00 / 0.01V/step]
3-214-001	Vt Save :Set	Coverage Thresh	ENG*	[0 to 100 / 20 / 1%/step]
3-230-001	Vtref :Disp/Set	Current: K	ENG*	[0.00 to 5.00 / 1.80 / 0.01V/step]
3-230-002	Vtref :Disp/Set	Current: C	ENG*	[0.00 to 5.00 / 1.80 / 0.01V/step]
3-230-003	Vtref :Disp/Set	Current: M	ENG*	[0.00 to 5.00 / 1.80 / 0.01V/step]

3.SP Mode Tables

SP No.	Large Category	Small Category	ENG or CTL	[Min to Max/Init./Step]
3-230-004	Vtref :Disp/Set	Current: Y	ENG*	[0.00 to 5.00 / 1.80 / 0.01V/step]
3-232-001	Vtref Correct:Pixel	ON/OFF	ENG*	[0 to 1 / 1 / 1/step]
3-232-011	Vtref Correct:Pixel	Low Coverage Coef:K	ENG*	[0.0 to 5.0 / 1.0 / 0.1/step]
3-232-012	Vtref Correct:Pixel	Low Coverage Coef:C	ENG*	[0.0 to 5.0 / 1.0 / 0.1/step]
3-232-013	Vtref Correct:Pixel	Low Coverage Coef:M	ENG*	[0.0 to 5.0 / 1.0 / 0.1/step]
3-232-014	Vtref Correct:Pixel	Low Coverage Coef:Y	ENG*	[0.0 to 5.0 / 1.0 / 0.1/step]
3-232-021	Vtref Correct:Pixel	High Coverage Coeff:K	ENG*	[0.0 to 5.0 / 0.5 / 0.1/step]
3-232-022	Vtref Correct:Pixel	High Coverage Coeff:C	ENG*	IM C3500: [0.0 to 5.0 / 0.5 / 0.1/step] IM C2500: [0.0 to 5.0 / 1.0 / 0.1/step] IM C2000: [0.0 to 5.0 / 1.0 / 0.1/step] IM C3000: [0.0 to 5.0 / 0.5 / 0.1/step]
3-232-023	Vtref Correct:Pixel	High Coverage Coeff:M	ENG*	IM C3500: [0.0 to 5.0 / 0.5 / 0.1/step]

SP No.	Large Category	Small Category	ENG or CTL	[Min to Max/Init./Step]
				IM C2500: [0.0 to 5.0 / 1.0 / 0.1/step] IM C2000: [0.0 to 5.0 / 1.0 / 0.1/step] IM C3000: [0.0 to 5.0 / 0.5 / 0.1/step]
3-232-024	Vtref Correct:Pixel	High Coverage Coeff:Y	ENG*	IM C3500: [0.0 to 5.0 / 0.5 / 0.1/step] IM C2500: [0.0 to 5.0 / 1.0 / 0.1/step] IM C2000: [0.0 to 5.0 / 1.0 / 0.1/step] IM C3000: [0.0 to 5.0 / 0.5 / 0.1/step]
3-232-040	Vtref Correct:Pixel	Initial ProCon Thresh	ENG*	[0 to 255 / 100 / 1times/step]
3-232-041	Vtref Correct:Pixel	High Coverage Thresh:H	ENG*	[0 to 100 / 100 / 1%/step]
3-232-050	Vtref Correct:Pixel	ProCon Thresh	ENG*	[0 to 255 / 100 / 1times/step]
3-232-060	Vtref Correct:Pixel	Low Coverage Thresh	ENG*	[0.0 to 20.0 / 3.0 / 0.1%/step]
3-232-071	Vtref Correct:Pixel	TC Upper Limit:Display:Bk	ENG*	[1.0 to 15.0 / 9.0 / 0.1wt%/step]

3.SP Mode Tables

SP No.	Large Category	Small Category	ENG or CTL	[Min to Max/Init./Step]
3-232-072	Vtref Correct:Pixel	TC Upper Limit:Display:C	ENG*	[1.0 to 15.0 / 9.0 / 0.1wt%/step]
3-232-073	Vtref Correct:Pixel	TC Upper Limit:Display:M	ENG*	[1.0 to 15.0 / 9.0 / 0.1wt%/step]
3-232-074	Vtref Correct:Pixel	TC Upper Limit:Display:Y	ENG*	[1.0 to 15.0 / 9.0 / 0.1wt%/step]
3-232-081	Vtref Correct:Pixel	TC Upper Limit Correction:K	ENG*	[0.0 to 5.0 / 0.5 / 0.1wt%/step]
3-232-082	Vtref Correct:Pixel	TC Upper Limit Correction:C	ENG*	[0.0 to 5.0 / 0.5 / 0.1wt%/step]
3-232-083	Vtref Correct:Pixel	TC Upper Limit Correction:M	ENG*	[0.0 to 5.0 / 0.5 / 0.1wt%/step]
3-232-084	Vtref Correct:Pixel	TC Upper Limit Correction:Y	ENG*	[0.0 to 5.0 / 0.5 / 0.1wt%/step]
3-233-001	RTP Vtref Corr :Disp/Set	ON/OFF	ENG*	[0 to 1 / 1 / 1/step]
3-233-011	RTP Vtref Corr :Disp/Set	Corr Amt(+):K	ENG*	[0.00 to 1.00 / 0.03 / 0.01V/step]
3-233-012	RTP Vtref Corr :Disp/Set	Corr Amt(+):C	ENG*	[0.00 to 1.00 / 0.03 / 0.01V/step]
3-233-013	RTP Vtref Corr :Disp/Set	Corr Amt(+):M	ENG*	[0.00 to 1.00 / 0.03 / 0.01V/step]
3-233-014	RTP Vtref Corr :Disp/Set	Corr Amt(+):Y	ENG*	[0.00 to 1.00 / 0.03 / 0.01V/step]

3.SP Mode Tables

SP No.	Large Category	Small Category	ENG or CTL	[Min to Max/Init./Step]
3-233-021	RTP Vtref Corr :Disp/Set	Corr Amt(-):K	ENG*	[0.00 to 1.00 / 0.03 / 0.01V/step]
3-233-022	RTP Vtref Corr :Disp/Set	Corr Amt(-):C	ENG*	[0.00 to 1.00 / 0.03 / 0.01V/step]
3-233-023	RTP Vtref Corr :Disp/Set	Corr Amt(-):M	ENG*	[0.00 to 1.00 / 0.03 / 0.01V/step]
3-233-024	RTP Vtref Corr :Disp/Set	Corr Amt(-):Y	ENG*	[0.00 to 1.00 / 0.03 / 0.01V/step]
3-233-031	RTP Vtref Corr :Disp/Set	Corr Thresh:K	ENG*	[0.000 to 0.100 / 0.005 / 0.001mg/cm2/step]
3-233-032	RTP Vtref Corr :Disp/Set	Corr Thresh:C	ENG*	[0.000 to 0.100 / 0.010 / 0.001mg/cm2/step]
3-233-033	RTP Vtref Corr :Disp/Set	Corr Thresh:M	ENG*	[0.000 to 0.100 / 0.010 / 0.001mg/cm2/step]
3-233-034	RTP Vtref Corr :Disp/Set	Corr Thresh:Y	ENG*	[0.000 to 0.100 / 0.010 / 0.001mg/cm2/step]
3-233-041	RTP Vtref Corr :Disp/Set	Vtavg Weight Coeff (H)	ENG*	[0 to 100 / 30 / 1%/step]
3-233-051	RTP Vtref Corr :Disp/Set	Vtavg Weight Coeff (M)	ENG*	[0 to 100 / 0 / 1%/step]
3-233-061	RTP Vtref Corr :Disp/Set	Vtavg Weight Coeff (L)	ENG*	[0 to 100 / 5 / 1%/step]
3-234-001	Vtref Corr :Disp/Set	ON/OFF	ENG*	[0 to 1 / 1 / 1/step]

3.SP Mode Tables

SP No.	Large Category	Small Category	ENG or CTL	[Min to Max/Init./Step]
3-234-011	Vtref Corr :Disp/Set	Corr Amt(+):K	ENG*	[0.00 to 1.00 / 0.01 / 0.01V/step]
3-234-012	Vtref Corr :Disp/Set	Corr Amt(+):C	ENG*	[0.00 to 1.00 / 0.01 / 0.01V/step]
3-234-013	Vtref Corr :Disp/Set	Corr Amt(+):M	ENG*	[0.00 to 1.00 / 0.01 / 0.01V/step]
3-234-014	Vtref Corr :Disp/Set	Corr Amt(+):Y	ENG*	[0.00 to 1.00 / 0.01 / 0.01V/step]
3-234-021	Vtref Corr :Disp/Set	Corr Amt(-):K	ENG*	[0.00 to 1.00 / 0.01 / 0.01V/step]
3-234-022	Vtref Corr :Disp/Set	Corr Amt(-):C	ENG*	[0.00 to 1.00 / 0.01 / 0.01V/step]
3-234-023	Vtref Corr :Disp/Set	Corr Amt(-):M	ENG*	[0.00 to 1.00 / 0.01 / 0.01V/step]
3-234-024	Vtref Corr :Disp/Set	Corr Amt(-):Y	ENG*	[0.00 to 1.00 / 0.01 / 0.01V/step]
3-234-031	Vtref Corr :Disp/Set	P Rank 1 Threshold	ENG*	[0.00 to 2.00 / 0.15 / 0.01/step]
3-234-032	Vtref Corr :Disp/Set	P Rank 2 Threshold	ENG*	[0.00 to 2.00 / 0.05 / 0.01/step]
3-234-033	Vtref Corr :Disp/Set	P Rank 3 Threshold	ENG*	[-2.00 to 0.00 / -0.05 / 0.01/step]
3-234-034	Vtref Corr :Disp/Set	P Rank 4 Threshold	ENG*	IM C3500: [-2.00 to 0.00 / -0.25 / 0.01/step]

SP No.	Large Category	Small Category	ENG or CTL	[Min to Max/Init./Step]
				IM C2500: [-2.00 to 0.00 / -0.15 / 0.01/step] IM C2000: [-2.00 to 0.00 / -0.15 / 0.01/step] IM C3000: [-2.00 to 0.00 / -0.25 / 0.01/step]
3-234-041	Vtref Corr :Disp/Set	T Rank 1 Threshold	ENG*	[-1.00 to 0.00 / -0.20 / 0.01V/step]
3-234-042	Vtref Corr :Disp/Set	T Rank 2 Threshold	ENG*	[0.00 to 1.00 / 0.20 / 0.01V/step]
3-234-050	Vtref Corr :Disp/Set	Correction Coefficient	ENG*	[1.0 to 10.0 / 10.0 / 0.1/step]
3-250-001	ImgArea :Disp	ImgArea:K	ENG*	[0 to 9999 / 0 / 1cm2/step]
3-250-002	ImgArea :Disp	ImgArea:C	ENG*	[0 to 9999 / 0 / 1cm2/step]
3-250-003	ImgArea :Disp	ImgArea:M	ENG*	[0 to 9999 / 0 / 1cm2/step]
3-250-004	ImgArea :Disp	ImgArea:Y	ENG*	[0 to 9999 / 0 / 1cm2/step]
3-251-001	DotCoverage :Disp	DotCoverage:K	ENG*	[0.00 to 100.00 / 0.00 / 0.01%/step]
3-251-002	DotCoverage :Disp	DotCoverage:C	ENG*	[0.00 to 100.00 / 0.00 / 0.01%/step]

3.SP Mode Tables

SP No.	Large Category	Small Category	ENG or CTL	[Min to Max/Init./Step]
3-251-003	DotCoverage :Disp	DotCoverage:M	ENG*	[0.00 to 100.00 / 0.00 / 0.01%/step]
3-251-004	DotCoverage :Disp	DotCoverage:Y	ENG*	[0.00 to 100.00 / 0.00 / 0.01%/step]
3-251-011	DotCoverage :Disp	DC Avg.:S:K	ENG*	[0.00 to 100.00 / 5.00 / 0.01%/step]
3-251-012	DotCoverage :Disp	DC Avg.:S:C	ENG*	[0.00 to 100.00 / 5.00 / 0.01%/step]
3-251-013	DotCoverage :Disp	DC Avg.:S:M	ENG*	[0.00 to 100.00 / 5.00 / 0.01%/step]
3-251-014	DotCoverage :Disp	DC Avg.:S:Y	ENG*	[0.00 to 100.00 / 5.00 / 0.01%/step]
3-251-021	DotCoverage :Disp	DC Avg.:M:K	ENG*	[0.00 to 100.00 / 5.00 / 0.01%/step]
3-251-022	DotCoverage :Disp	DC Avg.:M:C	ENG*	[0.00 to 100.00 / 5.00 / 0.01%/step]
3-251-023	DotCoverage :Disp	DC Avg.:M:M	ENG*	[0.00 to 100.00 / 5.00 / 0.01%/step]
3-251-024	DotCoverage :Disp	DC Avg.:M:Y	ENG*	[0.00 to 100.00 / 5.00 / 0.01%/step]
3-251-031	DotCoverage :Disp	DC Avg.:L:K	ENG*	[0.00 to 100.00 / 5.00 / 0.01%/step]
3-251-032	DotCoverage :Disp	DC Avg.:L:C	ENG*	[0.00 to 100.00 / 5.00 / 0.01%/step]

3.SP Mode Tables

SP No.	Large Category	Small Category	ENG or CTL	[Min to Max/Init./Step]
3-251-033	DotCoverage :Disp	DC Avg.:L:M	ENG*	[0.00 to 100.00 / 5.00 / 0.01%/step]
3-251-034	DotCoverage :Disp	DC Avg.:L:Y	ENG*	[0.00 to 100.00 / 5.00 / 0.01%/step]
3-251-041	DotCoverage :Disp	TotalPage:S:Set	ENG*	[1 to 255 / 50 / 1counts/step]
3-251-042	DotCoverage :Disp	TotalPage:S:Set	ENG*	[1 to 500 / 50 / 1counts/step]
3-251-043	DotCoverage :Disp	TotalPage:S:Set	ENG*	[1 to 999 / 250 / 1counts/step]
3-251-051	DotCoverage :Disp	TotalPage:S:Set	ENG*	[1 to 255 / 100 / 1counts/step]
3-251-052	DotCoverage :Disp	TotalPage:S:Set	ENG*	[1 to 500 / 50 / 1counts/step]
3-251-053	DotCoverage :Disp	TotalPage:S:Set	ENG*	[1 to 999 / 250 / 1counts/step]
3-251-151	DotCoverage :Disp	Total DC: Dev: K	ENG*	[0.00 to 100.00 / 0.00 / 0.01%/step]
3-251-152	DotCoverage :Disp	Total DC: Dev: C	ENG*	[0.00 to 100.00 / 0.00 / 0.01%/step]
3-251-153	DotCoverage :Disp	Total DC: Dev: M	ENG*	[0.00 to 100.00 / 0.00 / 0.01%/step]
3-251-154	DotCoverage :Disp	Total DC: Dev: Y	ENG*	[0.00 to 100.00 / 0.00 / 0.01%/step]

3.SP Mode Tables

SP No.	Large Category	Small Category	ENG or CTL	[Min to Max/Init./Step]
3-252-001	AccumImgArea :Disp	ImgArea:K	ENG*	[0 to 65535 / 0 / 1cm ² /step]
3-252-002	AccumImgArea :Disp	ImgArea:C	ENG*	[0 to 65535 / 0 / 1cm ² /step]
3-252-003	AccumImgArea :Disp	ImgArea:M	ENG*	[0 to 65535 / 0 / 1cm ² /step]
3-252-004	AccumImgArea :Disp	ImgArea:Y	ENG*	[0 to 65535 / 0 / 1cm ² /step]
3-252-011	AccumImgArea :Disp	Tatal dev:K	ENG*	[0 to 4294967295 / 0 / 1cm ² /step]
3-252-012	AccumImgArea :Disp	Tatal dev:C	ENG*	[0 to 4294967295 / 0 / 1cm ² /step]
3-252-013	AccumImgArea :Disp	Tatal dev:M	ENG*	[0 to 4294967295 / 0 / 1cm ² /step]
3-252-014	AccumImgArea :Disp	Tatal dev:Y	ENG*	[0 to 4294967295 / 0 / 1cm ² /step]
3-260-001	Temperature/Humidity: Display	Temperature	ENG	[-5.0 to 45.0 / 0.0 / 0.1deg/step]
3-260-002	Temperature/Humidity: Display	Relative Humidity	ENG	[0.0 to 100.0 / 0.0 / 0.1%RH/step]
3-260-003	Temperature/Humidity: Display	Absolute Humidity	ENG	[0.00 to 100.00 / 0.00 / 0.01g/m ³ /step]
3-300-001	RTP Pattern :Disp	M/A(Latest):K	ENG*	[0.000 to 1.000 / 0.000 / 0.001mg/cm ² /step]

3.SP Mode Tables

SP No.	Large Category	Small Category	ENG or CTL	[Min to Max/Init./Step]
3-300-002	RTP Pattern :Disp	M/A(Latest):C	ENG*	[0.000 to 2.000 / 0.000 / 0.001mg/cm2/step]
3-300-003	RTP Pattern :Disp	M/A(Latest):M	ENG*	[0.000 to 2.000 / 0.000 / 0.001mg/cm2/step]
3-300-004	RTP Pattern :Disp	M/A(Latest):Y	ENG*	[0.000 to 2.000 / 0.000 / 0.001mg/cm2/step]
3-300-011	RTP Pattern :Disp	M/A(Target):K	ENG*	IM C3500: [0.000 to 1.000 / 0.244 / 0.001mg/cm2/step] IM C2500: [0.000 to 1.000 / 0.280 / 0.001mg/cm2/step] IM C2000: [0.000 to 1.000 / 0.280 / 0.001mg/cm2/step] IM C3000: [0.000 to 1.000 / 0.244 / 0.001mg/cm2/step]
3-300-012	RTP Pattern :Disp	M/A(Target):C	ENG*	[0.000 to 1.000 / 0.400 / 0.001mg/cm2/step]
3-300-013	RTP Pattern :Disp	M/A(Target):M	ENG*	[0.000 to 1.000 / 0.450 / 0.001mg/cm2/step]
3-300-014	RTP Pattern :Disp	M/A(Target):Y	ENG*	[0.000 to 1.000 / 0.400 / 0.001mg/cm2/step]
3-301-	RTP Pattern :Set	Create Intrvl:BW	ENG	[0 to 200 / 10 / 1pages/step]

3.SP Mode Tables

SP No.	Large Category	Small Category	ENG or CTL	[Min to Max/Init./Step]
001				
3-301-002	RTP Pattern :Set	Create Intrvl:FC	ENG	[0 to 200 / 10 / 1pages/step]
3-301-011	RTP Pattern :Set	Page Cnt:BW	ENG*	[0 to 200 / 0 / 1pages/step]
3-301-012	RTP Pattern :Set	Page Cnt:FC	ENG*	[0 to 200 / 0 / 1pages/step]
3-301-021	RTP Pattern :Set	M/A UpErr:K	ENG	[0.000 to 1.000 / 0.600 / 0.001mg/cm2/step]
3-301-022	RTP Pattern :Set	M/A UpErr:Col	ENG	[0.000 to 2.000 / 1.200 / 0.001mg/cm2/step]
3-301-023	RTP Pattern :Set	M/A LowErr:K	ENG	[0.000 to 1.000 / 0.100 / 0.001mg/cm2/step]
3-301-024	RTP Pattern :Set	M/A LowErr:Col	ENG	[0.000 to 1.000 / 0.200 / 0.001mg/cm2/step]
3-301-031	RTP Pattern :Set	Feed Cnt :Set	ENG*	[0 to 99999999 / 50000 / 1ms/step]
3-301-041	RTP Pattern :Set	Feed Cnt :K	ENG*	[0 to 99999999 / 0 / 1ms/step]
3-301-042	RTP Pattern :Set	Feed Cnt :C	ENG*	[0 to 99999999 / 0 / 1ms/step]
3-301-043	RTP Pattern :Set	Feed Cnt :M	ENG*	[0 to 99999999 / 0 / 1ms/step]
3-	RTP Pattern :Set	Feed Cnt :Y	ENG*	[0 to 99999999 / 0 /

3.SP Mode Tables

SP No.	Large Category	Small Category	ENG or CTL	[Min to Max/Init./Step]
301-044				1ms/step]
3-301-081	RTP Pattern :Set	M/A(RTP)_Std	ENG*	IM C3500: [0.000 to 1.000 / 0.244 / 0.001mg/cm2/step] IM C2500: [0.000 to 1.000 / 0.280 / 0.001mg/cm2/step] IM C2000: [0.000 to 1.000 / 0.280 / 0.001mg/cm2/step] IM C3000: [0.000 to 1.000 / 0.244 / 0.001mg/cm2/step]
3-301-091	RTP Pattern :Set	M/A Thresh_Upp:K	ENG*	IM C3500: [0.000 to 1.000 / 0.111 / 0.001mg/cm2/step] IM C2500: [0.000 to 1.000 / 0.123 / 0.001mg/cm2/step] IM C2000: [0.000 to 1.000 / 0.123 / 0.001mg/cm2/step] IM C3000: [0.000 to 1.000 / 0.111 / 0.001mg/cm2/step]
3-301-092	RTP Pattern :Set	M/A Thresh_Upp:C	ENG*	[0.000 to 1.000 / 0.050 / 0.001mg/cm2/step]
3-	RTP Pattern :Set	M/A Thresh_Upp:M	ENG*	[0.000 to 1.000 /

3.SP Mode Tables

SP No.	Large Category	Small Category	ENG or CTL	[Min to Max/Init./Step]
301-093				0.050 / 0.001mg/cm2/step]
3-301-094	RTP Pattern :Set	M/A Thresh_Upp:Y	ENG*	[0.000 to 1.000 / 0.050 / 0.001mg/cm2/step]
3-301-101	RTP Pattern :Set	M/A Thresh_Low:K	ENG*	IM C3500: [0.000 to 1.000 / 0.111 / 0.001mg/cm2/step] IM C2500: [0.000 to 1.000 / 0.123 / 0.001mg/cm2/step] IM C2000: [0.000 to 1.000 / 0.123 / 0.001mg/cm2/step] IM C3000: [0.000 to 1.000 / 0.111 / 0.001mg/cm2/step]
3-301-102	RTP Pattern :Set	M/A Thresh_Low:C	ENG*	[0.000 to 1.000 / 0.100 / 0.001mg/cm2/step]
3-301-103	RTP Pattern :Set	M/A Thresh_Low:M	ENG*	[0.000 to 1.000 / 0.100 / 0.001mg/cm2/step]
3-301-104	RTP Pattern :Set	M/A Thresh_Low:Y	ENG*	[0.000 to 1.000 / 0.100 / 0.001mg/cm2/step]
3-301-111	RTP Pattern :Set	Weight Coeff:K	ENG*	[1 to 10 / 1 / 1/step]
3-301-112	RTP Pattern :Set	Weight Coeff:Col	ENG*	[1 to 10 / 1 / 1/step]
3-310-	ID.Sens :Voffset	Voffset reg (Front)	ENG*	[0.00 to 5.50 / 0.00 / 0.01V/step]

3.SP Mode Tables

SP No.	Large Category	Small Category	ENG or CTL	[Min to Max/Init./Step]
001				
3-310-002	ID.Sens :Voffset	Voffset reg (Center)	ENG*	[0.00 to 5.50 / 0.00 / 0.01V/step]
3-310-003	ID.Sens :Voffset	Voffset reg (Rear)	ENG*	[0.00 to 5.50 / 0.00 / 0.01V/step]
3-310-011	ID.Sens :Voffset	Voffset dif (Front)	ENG*	[0.00 to 5.50 / 0.00 / 0.01V/step]
3-310-012	ID.Sens :Voffset	Voffset dif (Center)	ENG*	[0.00 to 5.50 / 0.00 / 0.01V/step]
3-310-013	ID.Sens :Voffset	Voffset dif (Rear)	ENG*	[0.00 to 5.50 / 0.00 / 0.01V/step]
3-310-021	ID.Sens :Voffset	Voffset TM(Front)	ENG*	[0.00 to 5.50 / 0.00 / 0.01V/step]
3-310-022	ID.Sens :Voffset	Voffset TM(Center)	ENG*	[0.00 to 5.50 / 0.00 / 0.01V/step]
3-310-023	ID.Sens :Voffset	Voffset TM(Rear)	ENG*	[0.00 to 5.50 / 0.00 / 0.01V/step]
3-311-001	ID.Sens :Vmin	Vmin_K(Front)	ENG*	[0.000 to 5.000 / 0.000 / 0.001V/step]
3-311-002	ID.Sens :Vmin	Vmin_K(Center)	ENG*	[0.000 to 5.000 / 0.000 / 0.001V/step]
3-311-003	ID.Sens :Vmin	Vmin_K(Rear)	ENG*	[0.000 to 5.000 / 0.000 / 0.001V/step]
3-	ID.Sens :Vct	Vct_reg(Front)	ENG*	[0.000 to 5.000 /

3.SP Mode Tables

SP No.	Large Category	Small Category	ENG or CTL	[Min to Max/Init./Step]
312-001				0.000 / 0.001V/step]
3-312-002	ID.Sens :Vct	Vct_reg(Center)	ENG*	[0.000 to 5.000 / 0.000 / 0.001V/step]
3-312-003	ID.Sens :Vct	Vct_reg(Rear)	ENG*	[0.000 to 5.000 / 0.000 / 0.001V/step]
3-312-011	ID.Sens :Vct	Vct_dif(Front)	ENG*	[0.000 to 5.000 / 0.000 / 0.001V/step]
3-312-012	ID.Sens :Vct	Vct_dif(Center)	ENG*	[0.000 to 5.000 / 0.000 / 0.001V/step]
3-312-013	ID.Sens :Vct	Vct_dif(Rear)	ENG*	[0.000 to 5.000 / 0.000 / 0.001V/step]
3-320-001	Vsg Adj: Execute	P Sensor	ENG	[0 to 1 / 0 / 1/step]
3-320-031	Vsg Adj: Execute	Vsg Error Counter (Front)	ENG*	[0 to 99 / 0 / 1times/step]
3-320-032	Vsg Adj: Execute	Vsg Error Counter (Center)	ENG*	[0 to 99 / 0 / 1times/step]
3-320-033	Vsg Adj: Execute	Vsg Error Counter (Rear)	ENG*	[0 to 99 / 0 / 1times/step]
3-321-001	Adjusted Vsg	Vsg reg (Front)	ENG*	[0.00 to 5.50 / 4.00 / 0.01V/step]
3-321-002	Adjusted Vsg	Vsg reg (Center)	ENG*	[0.00 to 5.50 / 4.00 / 0.01V/step]

3.SP Mode Tables

SP No.	Large Category	Small Category	ENG or CTL	[Min to Max/Init./Step]
3-321-003	Adjusted Vsg	Vsg reg (Rear)	ENG*	[0.00 to 5.50 / 4.00 / 0.01V/step]
3-321-011	Adjusted Vsg	Vsg dif (Front)	ENG*	[0.00 to 5.50 / 0.00 / 0.01V/step]
3-321-012	Adjusted Vsg	Vsg dif (Center)	ENG*	[0.00 to 5.50 / 0.00 / 0.01V/step]
3-321-013	Adjusted Vsg	Vsg dif (Rear)	ENG*	[0.00 to 5.50 / 0.00 / 0.01V/step]
3-321-041	Adjusted Vsg	Vsg TM(Front)	ENG*	[0.00 to 5.50 / 4.00 / 0.01V/step]
3-321-042	Adjusted Vsg	Vsg TM(Center)	ENG*	[0.00 to 5.50 / 4.00 / 0.01V/step]
3-321-043	Adjusted Vsg	Vsg TM(Rear)	ENG*	[0.00 to 5.50 / 4.00 / 0.01V/step]
3-321-071	Adjusted Vsg	Vsg reg sd(Front) Avg.	ENG*	[0.00 to 5.50 / 0.00 / 0.01V/step]
3-321-072	Adjusted Vsg	Vsg reg sd(Center) Avg.	ENG*	[0.00 to 5.50 / 0.00 / 0.01V/step]
3-321-073	Adjusted Vsg	Vsg reg sd(Rear) Avg.	ENG*	[0.00 to 5.50 / 0.00 / 0.01V/step]
3-321-081	Adjusted Vsg	Vsg reg sd(BW Front) Avg.	ENG*	[0.00 to 5.50 / 0.00 / 0.01V/step]
3-321-082	Adjusted Vsg	Vsg reg sd(BW Center) Avg.	ENG*	[0.00 to 5.50 / 0.00 / 0.01V/step]

3.SP Mode Tables

SP No.	Large Category	Small Category	ENG or CTL	[Min to Max/Init./Step]
3-321-083	Adjusted Vsg	Vsg reg sd(BW Rear) Avg.	ENG*	[0.00 to 5.50 / 0.00 / 0.01V/step]
3-321-091	Adjusted Vsg	Vsg reg sd_Avg. Count:Set	ENG*	[1 to 255 / 5 / 1/step]
3-322-001	Adjusted Ifsg	Ifsg RTP (Front)	ENG*	[0.000 to 50.000 / 10.000 / 0.001mA/step]
3-322-002	Adjusted Ifsg	Ifsg RTP (Center)	ENG*	[0.000 to 50.000 / 10.000 / 0.001mA/step]
3-322-003	Adjusted Ifsg	Ifsg RTP (Rear)	ENG*	[0.000 to 50.000 / 10.000 / 0.001mA/step]
3-322-011	Adjusted Ifsg	Ifsg Min (Front)	ENG*	[0.000 to 50.000 / 27.000 / 0.001mA/step]
3-322-012	Adjusted Ifsg	Ifsg Min (Center)	ENG*	[0.000 to 50.000 / 27.000 / 0.001mA/step]
3-322-013	Adjusted Ifsg	Ifsg Min (Rear)	ENG*	[0.000 to 50.000 / 27.000 / 0.001mA/step]
3-322-021	Adjusted Ifsg	Ifsg: TM(Front)	ENG*	[0.000 to 50.000 / 10.000 / 0.001mA/step]
3-322-022	Adjusted Ifsg	Ifsg: TM(Center)	ENG*	[0.000 to 50.000 / 10.000 / 0.001mA/step]
3-322-023	Adjusted Ifsg	Ifsg: TM(Rear)	ENG*	[0.000 to 50.000 / 10.000 / 0.001mA/step]
3-323-001	Vsg Adj OK?	Latest	ENG*	[0 to 999 / 0 / 1/step]

3.SP Mode Tables

SP No.	Large Category	Small Category	ENG or CTL	[Min to Max/Init./Step]
3-323-002	Vsg Adj OK?	Latest 2	ENG*	[0 to 999 / 0 / 1/step]
3-323-003	Vsg Adj OK?	Latest 3	ENG*	[0 to 999 / 0 / 1/step]
3-323-004	Vsg Adj OK?	Latest 4	ENG*	[0 to 999 / 0 / 1/step]
3-323-005	Vsg Adj OK?	Latest 5	ENG*	[0 to 999 / 0 / 1/step]
3-323-006	Vsg Adj OK?	Latest 6	ENG*	[0 to 999 / 0 / 1/step]
3-323-007	Vsg Adj OK?	Latest 7	ENG*	[0 to 999 / 0 / 1/step]
3-323-008	Vsg Adj OK?	Latest 8	ENG*	[0 to 999 / 0 / 1/step]
3-323-009	Vsg Adj OK?	Latest 9	ENG*	[0 to 999 / 0 / 1/step]
3-323-010	Vsg Adj OK?	Latest 10	ENG*	[0 to 999 / 0 / 1/step]
3-330-001	ID.Sens Coef :Disp	K2(Latest) (Front)	ENG*	[0.0000 to 5.0000 / 0.0000 / 0.0001/step]
3-330-002	ID.Sens Coef :Disp	K2(Latest) (Center)	ENG*	[0.0000 to 5.0000 / 0.0000 / 0.0001/step]
3-330-003	ID.Sens Coef :Disp	K2(Latest) (Rear)	ENG*	[0.0000 to 5.0000 / 0.0000 / 0.0001/step]

3.SP Mode Tables

SP No.	Large Category	Small Category	ENG or CTL	[Min to Max/Init./Step]
3-330-011	ID.Sens Coef :Disp	K5(Latest) (Front)	ENG*	[0.0000 to 10.0000 / 5.0000 / 0.0001/step]
3-330-012	ID.Sens Coef :Disp	K5(Latest) (Center)	ENG*	[0.0000 to 10.0000 / 5.0000 / 0.0001/step]
3-330-013	ID.Sens Coef :Disp	K5(Latest) (Rear)	ENG*	[0.0000 to 10.0000 / 5.0000 / 0.0001/step]
3-333-001	ID.Sens TestVal:F	K2: Check	ENG*	[0.000 to 1.000 / 0.516 / 0.001/step]
3-333-002	ID.Sens TestVal:F	Diffuse Corr	ENG*	[0.75 to 1.35 / 1.00 / 0.01/step]
3-333-003	ID.Sens TestVal:F	Vct_reg Check:Slope	ENG*	[0.0 to 200.0 / 0.0 / 0.1mV/mA/step]
3-333-004	ID.Sens TestVal:F	Vct_reg Check:Xint	ENG*	[0.0 to 25.5 / 0.0 / 0.1mA/step]
3-333-005	ID.Sens TestVal:F	Vct_dif Check:Slope	ENG*	[0.0 to 200.0 / 0.0 / 0.1mV/mA/step]
3-333-006	ID.Sens TestVal:F	Vct_dif Check:Xint	ENG*	[0.0 to 25.5 / 0.0 / 0.1mA/step]
3-334-001	ID.Sens TestVal:C	K2: Check	ENG*	[0.000 to 1.000 / 0.516 / 0.001/step]
3-334-002	ID.Sens TestVal:C	Diffuse Corr	ENG*	[0.75 to 1.35 / 1.00 / 0.01/step]
3-334-003	ID.Sens TestVal:C	Vct_reg Check:Slope	ENG*	[0.0 to 200.0 / 0.0 / 0.1mV/mA/step]

3.SP Mode Tables

SP No.	Large Category	Small Category	ENG or CTL	[Min to Max/Init./Step]
3-334-004	ID.Sens TestVal:C	Vct_reg Check:Xint	ENG*	[0.0 to 25.5 / 0.0 / 0.1mA/step]
3-334-005	ID.Sens TestVal:C	Vct_dif Check:Slope	ENG*	[0.0 to 200.0 / 0.0 / 0.1mV/mA/step]
3-334-006	ID.Sens TestVal:C	Vct_dif Check:Xint	ENG*	[0.0 to 25.5 / 0.0 / 0.1mA/step]
3-335-001	ID.Sens TestVal:R	K2: Check	ENG*	[0.000 to 1.000 / 0.516 / 0.001/step]
3-335-002	ID.Sens TestVal:R	Diffuse Corr	ENG*	[0.75 to 1.35 / 1.00 / 0.01/step]
3-335-003	ID.Sens TestVal:R	Vct_reg Check:Slope	ENG*	[0.0 to 200.0 / 0.0 / 0.1mV/mA/step]
3-335-004	ID.Sens TestVal:R	Vct_reg Check:Xint	ENG*	[0.0 to 25.5 / 0.0 / 0.1mA/step]
3-335-005	ID.Sens TestVal:R	Vct_dif Check:Slope	ENG*	[0.0 to 200.0 / 0.0 / 0.1mV/mA/step]
3-335-006	ID.Sens TestVal:R	Vct_dif Check:Xint	ENG*	[0.0 to 25.5 / 0.0 / 0.1mA/step]
3-400-001	Toner Supply Type	K	ENG*	[0 to 4 / 4 / 1/step]
3-400-002	Toner Supply Type	C	ENG*	[0 to 4 / 4 / 1/step]
3-400-003	Toner Supply Type	M	ENG*	[0 to 4 / 4 / 1/step]

3.SP Mode Tables

SP No.	Large Category	Small Category	ENG or CTL	[Min to Max/Init./Step]
3-400-004	Toner Supply Type	Y	ENG*	[0 to 4 / 4 / 1/step]
3-411-001	Toner Supply Qty	K	ENG	[0.0 to 40000.0 / 0.0 / 0.1mg/step]
3-411-002	Toner Supply Qty	C	ENG	[0.0 to 40000.0 / 0.0 / 0.1mg/step]
3-411-003	Toner Supply Qty	M	ENG	[0.0 to 40000.0 / 0.0 / 0.1mg/step]
3-411-004	Toner Supply Qty	Y	ENG	[0.0 to 40000.0 / 0.0 / 0.1mg/step]
3-420-001	DeveloperWeight :Set	DeveloperWeight:K	ENG*	IM C3500: [50 to 2000 / 380 / 1g/step] IM C2500: [50 to 2000 / 240 / 1g/step] IM C2000: [50 to 2000 / 240 / 1g/step] IM C3000: [50 to 2000 / 380 / 1g/step]
3-420-002	DeveloperWeight :Set	DeveloperWeight:C	ENG*	[50 to 2000 / 240 / 1g/step]
3-420-003	DeveloperWeight :Set	DeveloperWeight:M	ENG*	[50 to 2000 / 240 / 1g/step]
3-420-004	DeveloperWeight :Set	DeveloperWeight:Y	ENG*	[50 to 2000 / 240 / 1g/step]

3.SP Mode Tables

SP No.	Large Category	Small Category	ENG or CTL	[Min to Max/Init./Step]
3-421-001	TnrSplyAbility	K	ENG*	[0.001 to 2.000 / 0.710 / 0.001mg/msec/step]
3-421-002	TnrSplyAbility	C	ENG*	[0.001 to 2.000 / 0.710 / 0.001mg/msec/step]
3-421-003	TnrSplyAbility	M	ENG*	[0.001 to 2.000 / 0.710 / 0.001mg/msec/step]
3-421-004	TnrSplyAbility	Y	ENG*	[0.001 to 2.000 / 0.710 / 0.001mg/msec/step]
3-421-011	TnrSplyAbility	TnrSplyAbilityCoef1	ENG*	[0.50 to 2.00 / 1.12 / 0.01/step]
3-421-012	TnrSplyAbility	TnrSplyAbilityCoef2	ENG*	[0.50 to 2.00 / 1.12 / 0.01/step]
3-421-013	TnrSplyAbility	TnrSplyAbilityCoef3	ENG*	[0.50 to 2.00 / 1.10 / 0.01/step]
3-421-014	TnrSplyAbility	TnrSplyAbilityCoef4	ENG*	[0.50 to 2.00 / 1.06 / 0.01/step]
3-421-015	TnrSplyAbility	TnrSplyAbilityCoef5	ENG*	[0.50 to 2.00 / 1.00 / 0.01/step]
3-421-016	TnrSplyAbility	TnrSplyAbilityCoef6	ENG*	[0.50 to 2.00 / 0.99 / 0.01/step]
3-421-017	TnrSplyAbility	TnrSplyAbilityCoef7	ENG*	[0.50 to 2.00 / 0.98 / 0.01/step]
3-421-018	TnrSplyAbility	TnrSplyAbilityCoef8	ENG*	[0.50 to 2.00 / 0.95 / 0.01/step]

3.SP Mode Tables

SP No.	Large Category	Small Category	ENG or CTL	[Min to Max/Init./Step]
3-421-019	TnrSplyAbility	TnrSplyAbilityCoef9	ENG*	[0.50 to 2.00 / 0.95 / 0.01/step]
3-421-020	TnrSplyAbility	TnrSplyAbilityCoef10	ENG*	[0.50 to 2.00 / 0.95 / 0.01/step]
3-421-031	TnrSplyAbility	AbsHum Threshold:1	ENG*	[0.0 to 65.0 / 6.0 / 0.1g/m3/step]
3-421-032	TnrSplyAbility	AbsHum Threshold:2	ENG*	[0.0 to 65.0 / 12.0 / 0.1g/m3/step]
3-421-033	TnrSplyAbility	AbsHum Threshold:3	ENG*	[0.0 to 65.0 / 24.0 / 0.1g/m3/step]
3-421-041	TnrSplyAbility	Environ Coef1	ENG*	[0.50 to 2.00 / 1.00 / 0.01/step]
3-421-042	TnrSplyAbility	Environ Coef2	ENG*	[0.50 to 2.00 / 1.00 / 0.01/step]
3-421-043	TnrSplyAbility	Environ Coef3	ENG*	[0.50 to 2.00 / 1.00 / 0.01/step]
3-421-044	TnrSplyAbility	Environ Coef4	ENG*	[0.50 to 2.00 / 1.00 / 0.01/step]
3-422-001	Tnr Supply Limits :Set	Max Supply Rate:K	ENG*	[0 to 255 / 87 / 1%/step]
3-422-002	Tnr Supply Limits :Set	Max Supply Rate:C	ENG*	[0 to 255 / 87 / 1%/step]
3-422-003	Tnr Supply Limits :Set	Max Supply Rate:M	ENG*	[0 to 255 / 87 / 1%/step]

3.SP Mode Tables

SP No.	Large Category	Small Category	ENG or CTL	[Min to Max/Init./Step]
3-422-004	Tnr Supply Limits :Set	Max Supply Rate:Y	ENG*	[0 to 255 / 87 / 1%/step]
3-422-011	Tnr Supply Limits :Set	Min Supply Time: K	ENG*	[0 to 255 / 100 / 1msec/step]
3-422-012	Tnr Supply Limits :Set	Min Supply Time: C	ENG*	[0 to 255 / 100 / 1msec/step]
3-422-013	Tnr Supply Limits :Set	Min Supply Time: M	ENG*	[0 to 255 / 100 / 1msec/step]
3-422-014	Tnr Supply Limits :Set	Min Supply Time: Y	ENG*	[0 to 255 / 100 / 1msec/step]
3-428-001	TnrSplyDelay : Setting	Delay	ENG*	[0 to 255 / 0 / 1msec/step]
3-440-001	Fixed Supply Mode	Fixed Rate: K	ENG*	[0 to 100 / 10 / 1%/step]
3-440-002	Fixed Supply Mode	Fixed Rate: C	ENG*	[0 to 100 / 10 / 1%/step]
3-440-003	Fixed Supply Mode	Fixed Rate: M	ENG*	[0 to 100 / 10 / 1%/step]
3-440-004	Fixed Supply Mode	Fixed Rate: Y	ENG*	[0 to 100 / 10 / 1%/step]
3-460-011	TonerSupply :DANC	Time_Min	ENG*	[0 to 250 / 0 / 1msec/step]
3-460-012	TonerSupply :DANC	Time_Max	ENG*	[0 to 1000 / 200 / 1msec/step]

3.SP Mode Tables

SP No.	Large Category	Small Category	ENG or CTL	[Min to Max/Init./Step]
3-460-022	TonerSupply :DANC	SMITH_Weight:K	ENG*	IM C3500: [1 to 500 / 140 / 1mg/step] IM C2500: [1 to 500 / 71 / 1mg/step] IM C2000: [1 to 500 / 71 / 1mg/step] IM C3000: [1 to 500 / 140 / 1mg/step]
3-460-023	TonerSupply :DANC	SMITH_Weight:CMY	ENG*	[1 to 500 / 71 / 1mg/step]
3-460-111	TonerSupply :DANC	Rev_Fix:K	ENG*	[1.00 to 1.50 / 1.00 / 0.01/step]
3-460-112	TonerSupply :DANC	Rev_Fix:C	ENG*	[1.00 to 1.50 / 1.00 / 0.01/step]
3-460-113	TonerSupply :DANC	Rev_Fix:M	ENG*	[1.00 to 1.50 / 1.00 / 0.01/step]
3-460-114	TonerSupply :DANC	Rev_Fix:Y	ENG*	[1.00 to 1.50 / 1.00 / 0.01/step]
3-461-001	TonerSupply :DANC	PI:Power	ENG*	[5 to 200 / 100 / 1%/step]
3-461-011	TonerSupply :DANC	PI:P Gain:K	ENG*	IM C3500: [0.0000 to 1.0000 / 0.0100 / 0.0001/step] IM C2500: [0.0000 to 1.0000 / 0.0010 / 0.0001/step]

3.SP Mode Tables

SP No.	Large Category	Small Category	ENG or CTL	[Min to Max/Init./Step]
				IM C2000: [0.0000 to 1.0000 / 0.0010 / 0.0001/step] IM C3000: [0.0000 to 1.0000 / 0.0100 / 0.0001/step]
3-461-012	TonerSupply :DANC	PI:P Limits:Up:K	ENG*	[0.00 to 1.00 / 0.10 / 0.01/step]
3-461-013	TonerSupply :DANC	PI:P Limits:Low:K	ENG*	[0.00 to 1.00 / 0.10 / 0.01/step]
3-461-021	TonerSupply :DANC	PI:I Gain:K	ENG*	IM C3500: [0.0000 to 0.1000 / 0.0010 / 0.0001/step] IM C2500: [0.0000 to 0.1000 / 0.0005 / 0.0001/step] IM C2000: [0.0000 to 0.1000 / 0.0005 / 0.0001/step] IM C3000: [0.0000 to 0.1000 / 0.0010 / 0.0001/step]
3-461-022	TonerSupply :DANC	PI:I Limits:Up:K	ENG*	IM C3500: [0.00 to 1.00 / 0.10 / 0.01/step] IM C2500: [0.00 to 1.00 / 0.20 / 0.01/step] IM C2000: [0.00 to 1.00 / 0.20 / 0.01/step] IM C3000: [0.00 to 1.00 / 0.10 / 0.01/step]

3.SP Mode Tables

SP No.	Large Category	Small Category	ENG or CTL	[Min to Max/Init./Step]
3-461-023	TonerSupply :DANC	PI:I Limits:Low:K	ENG*	IM C3500: [0.00 to 1.00 / 0.10 / 0.01/step] IM C2500: [0.00 to 1.00 / 0.20 / 0.01/step] IM C2000: [0.00 to 1.00 / 0.20 / 0.01/step] IM C3000: [0.00 to 1.00 / 0.10 / 0.01/step]
3-461-031	TonerSupply :DANC	PI:P Gain:CMY	ENG*	[0.0000 to 1.0000 / 0.0010 / 0.0001/step]
3-461-032	TonerSupply :DANC	PI:P Limits:Up:CMY	ENG*	[0.00 to 1.00 / 0.10 / 0.01/step]
3-461-033	TonerSupply :DANC	PI:P Limits:Low:CMY	ENG*	[0.00 to 1.00 / 0.10 / 0.01/step]
3-461-041	TonerSupply :DANC	PI:I Gain:CMY	ENG*	[0.0000 to 0.1000 / 0.0005 / 0.0001/step]
3-461-042	TonerSupply :DANC	PI:I Limits:Up:CMY	ENG*	[0.00 to 1.00 / 0.20 / 0.01/step]
3-461-043	TonerSupply :DANC	PI:I Limits:Low:CMY	ENG*	[0.00 to 1.00 / 0.20 / 0.01/step]
3-461-052	TonerSupply :DANC	AW:AWIpnI:K	ENG*	IM C3500: [0 to 2000 / 1000 / 1/step] IM C2500: [0 to 2000 / 100 / 1/step]

3.SP Mode Tables

SP No.	Large Category	Small Category	ENG or CTL	[Min to Max/Init./Step]
				IM C2000: [0 to 2000 / 100 / 1/step] IM C3000: [0 to 2000 / 1000 / 1/step]
3-461-062	TonerSupply :DANC	AW:AWIpn:CMY	ENG*	[0 to 2000 / 100 / 1/step]
3-461-102	TonerSupply :DANC	PI:LineSpdCoef:MidSpd:K	ENG*	[0.05 to 1.00 / 0.50 / 0.01/step]
3-461-103	TonerSupply :DANC	PI:LineSpdCoef:LowSpd:K	ENG*	[0.05 to 1.00 / 0.50 / 0.01/step]
3-461-112	TonerSupply :DANC	PI:LineSpdCoef:StdSpd:CMY	ENG*	[0.05 to 1.00 / 0.50 / 0.01/step]
3-461-113	TonerSupply :DANC	PI:LineSpdCoef:LowSpd:CMY	ENG*	[0.05 to 1.00 / 0.50 / 0.01/step]
3-461-121	TonerSupply :DANC	SMITH:Gain:K	ENG*	[0.00 to 2.00 / 1.00 / 0.01/step]
3-461-122	TonerSupply :DANC	SMITH:MidSpd:K	ENG*	[0.00 to 1.00 / 1.00 / 0.01/step]
3-461-123	TonerSupply :DANC	SMITH:LowSpd:K	ENG*	[0.00 to 1.00 / 1.00 / 0.01/step]
3-461-131	TonerSupply :DANC	SMITH:Gain:CMY	ENG*	[0.00 to 2.00 / 1.00 / 0.01/step]
3-461-132	TonerSupply :DANC	SMITH:MidSpd:CMY	ENG*	[0.00 to 1.00 / 1.00 / 0.01/step]

3.SP Mode Tables

SP No.	Large Category	Small Category	ENG or CTL	[Min to Max/Init./Step]
3-461-133	TonerSupply :DANC	SMITH:LowSpd:CMY	ENG*	[0.00 to 1.00 / 1.00 / 0.01/step]
3-462-001	TonerSupply :DANC	ANC:Power	ENG*	[0 to 200 / 100 / 1%/step]
3-462-101	TonerSupply :DANC	ANC:Gain:K	ENG*	[0.00 to 2.00 / 1.00 / 0.01/step]
3-462-102	TonerSupply :DANC	ANC:MidSpd:K	ENG*	[0.05 to 1.00 / 1.00 / 0.01/step]
3-462-103	TonerSupply :DANC	ANC:LowSpd:K	ENG*	[0.05 to 1.00 / 1.00 / 0.01/step]
3-462-111	TonerSupply :DANC	ANC:Gain:CMY	ENG*	[0.00 to 2.00 / 1.00 / 0.01/step]
3-462-112	TonerSupply :DANC	ANC:MidSpd:CMY	ENG*	[0.05 to 1.00 / 1.00 / 0.01/step]
3-462-113	TonerSupply :DANC	ANC:LowSpd:CMY	ENG*	[0.05 to 1.00 / 1.00 / 0.01/step]
3-463-101	TonerSupply :DANC	Int:I:K	ENG*	[-1000.0000 to 1000.0000 / 0.0000 / 0.0001/step]
3-463-102	TonerSupply :DANC	Int:I:C	ENG*	[-1000.0000 to 1000.0000 / 0.0000 / 0.0001/step]
3-463-103	TonerSupply :DANC	Int:I:M	ENG*	[-1000.0000 to 1000.0000 / 0.0000 / 0.0001/step]
3-463-104	TonerSupply :DANC	Int:I:Y	ENG*	[-1000.0000 to 1000.0000 / 0.0000 / 0.0001/step]

3.SP Mode Tables

SP No.	Large Category	Small Category	ENG or CTL	[Min to Max/Init./Step]
3-463-111	TonerSupply :DANC	ANC:ref Sum:K	ENG*	[-1000.0000 to 1000.0000 / 0.0000 / 0.0001/step]
3-463-112	TonerSupply :DANC	ANC:ref Sum:C	ENG*	[-1000.0000 to 1000.0000 / 0.0000 / 0.0001/step]
3-463-113	TonerSupply :DANC	ANC:ref Sum:M	ENG*	[-1000.0000 to 1000.0000 / 0.0000 / 0.0001/step]
3-463-114	TonerSupply :DANC	ANC:ref Sum:Y	ENG*	[-1000.0000 to 1000.0000 / 0.0000 / 0.0001/step]
3-463-201	TonerSupply :DANC	ImgArea:K	ENG	[0 to 9999 / 0 / 1cm2/step]
3-463-202	TonerSupply :DANC	ImgArea:C	ENG	[0 to 9999 / 0 / 1cm2/step]
3-463-203	TonerSupply :DANC	ImgArea:M	ENG	[0 to 9999 / 0 / 1cm2/step]
3-463-204	TonerSupply :DANC	ImgArea:Y	ENG	[0 to 9999 / 0 / 1cm2/step]
3-500-001	ImgQtyAdj :ON/OFF	ALL	ENG*	[0 to 1 / 1 / 1/step]
3-500-002	ImgQtyAdj :ON/OFF	ProCon	ENG*	[0 to 1 / 1 / 1/step]
3-500-003	ImgQtyAdj :ON/OFF	MUSIC Condition:Auto Exe	ENG*	[0 to 1 / 1 / 1/step]
3-500-004	ImgQtyAdj :ON/OFF	Init TD Sensor	ENG*	[0 to 1 / 1 / 1/step]

3.SP Mode Tables

SP No.	Large Category	Small Category	ENG or CTL	[Min to Max/Init./Step]
3-500-006	ImgQltyAdj :ON/OFF	PresetSealWindup Exe	ENG*	IM C3500: [0 to 1 / 1 / 1/step] IM C2500: [0 to 1 / 0 / 1/step] IM C2000: [0 to 1 / 0 / 1/step] IM C3000: [0 to 1 / 1 / 1/step]
3-509-011	ImgQltyAdj :ModeSelect	ImgQltyAdj Mode Setting	ENG*	[0 to 2 / 0 / 1/step]
3-510-024	ImgQltyAdj :ExeFlag	MUSIC	ENG*	[0 to 3 / 0 / 1/step]
3-520-001	ImgQltyAdj :Interval	During Job	ENG*	[0 to 100 / 30 / 1pages/step]
3-520-002	ImgQltyAdj :Interval	During Stand-by	ENG*	[0 to 100 / 5 / 1minute/step]
3-521-001	Drum Stop Time :Disp	Year:K	ENG*	[0 to 99 / 0 / 1year/step]
3-521-002	Drum Stop Time :Disp	Month:K	ENG*	[1 to 12 / 1 / 1month/step]
3-521-003	Drum Stop Time :Disp	Day:K	ENG*	[1 to 31 / 1 / 1day/step]
3-521-004	Drum Stop Time :Disp	Hour:K	ENG*	[0 to 23 / 0 / 1hour/step]
3-521-005	Drum Stop Time :Disp	Minute:K	ENG*	[0 to 59 / 0 / 1minute/step]
3-	Drum Stop Time :Disp	Year:Col	ENG*	[0 to 99 / 0 /

3.SP Mode Tables

SP No.	Large Category	Small Category	ENG or CTL	[Min to Max/Init./Step]
521-011				1year/step]
3-521-012	Drum Stop Time :Disp	Month:Col	ENG*	[1 to 12 / 1 / 1month/step]
3-521-013	Drum Stop Time :Disp	Day:Col	ENG*	[1 to 31 / 1 / 1day/step]
3-521-014	Drum Stop Time :Disp	Hour:Col	ENG*	[0 to 23 / 0 / 1hour/step]
3-521-015	Drum Stop Time :Disp	Minute:Col	ENG*	[0 to 59 / 0 / 1minute/step]
3-522-001	Drum Stop Environ :Disp	Temperature:K	ENG*	[-1280.0 to 1270.0 / 0.0 / 0.1deg/step]
3-522-002	Drum Stop Environ :Disp	Rel Humidity:K	ENG*	[0.0 to 1000.0 / 0.0 / 0.1%RH/step]
3-522-003	Drum Stop Environ :Disp	Abs Humidity:K	ENG*	[0.0 to 1000.0 / 0.0 / 0.1g/m3/step]
3-522-011	Drum Stop Environ :Disp	Temperature:Col	ENG*	[-1280.0 to 1270.0 / 0.0 / 0.1deg/step]
3-522-012	Drum Stop Environ :Disp	Rel Humidity:Col	ENG*	[0.0 to 1000.0 / 0.0 / 0.1%RH/step]
3-522-013	Drum Stop Environ :Disp	Abs Humidity:Col	ENG*	[0.0 to 1000.0 / 0.0 / 0.1g/m3/step]
3-529-001	ProCon Interval Control :Set	Gamma Corr	ENG*	[0 to 1 / 1 / 1/step]

3.SP Mode Tables

SP No.	Large Category	Small Category	ENG or CTL	[Min to Max/Init./Step]
3-529-002	ProCon Interval Control :Set	Environ Corr	ENG*	[0 to 1 / 1 / 1/step]
3-529-003	ProCon Interval Control :Set	AbsHum Threshold	ENG*	[0.0 to 99.0 / 4.3 / 0.1g/m3/step]
3-529-004	ProCon Interval Control :Set	Max Cnt Threshold	ENG*	[0 to 99 / 2 / 1counts/step]
3-529-005	ProCon Interval Control :Set	Exe Cnt	ENG	[0 to 255 / 0 / 1counts/step]
3-529-006	ProCon Interval Control :Set	Page Cnt:BW	ENG*	[0 to 5000 / 0 / 1sheets/step]
3-529-007	ProCon Interval Control :Set	Page Cnt:FC	ENG*	[0 to 5000 / 0 / 1sheets/step]
3-530-001	PowerON ProCon :Set	Non-use Time Setting	ENG*	[0 to 1440 / 360 / 1minute/step]
3-530-002	PowerON ProCon :Set	Temperature Range	ENG*	[0 to 99 / 10 / 1deg/step]
3-530-003	PowerON ProCon :Set	Relative Humidity Range	ENG*	[0 to 99 / 50 / 1%RH/step]
3-530-004	PowerON ProCon :Set	Absolute Humidity Range	ENG*	[0 to 99 / 6 / 1g/m3/step]
3-530-005	PowerON ProCon :Set	Interval:BW	ENG*	[0 to 5000 / 250 / 1sheets/step]
3-530-006	PowerON ProCon :Set	Interval:FC	ENG*	[0 to 5000 / 100 / 1sheets/step]

3.SP Mode Tables

SP No.	Large Category	Small Category	ENG or CTL	[Min to Max/Init./Step]
3-530-007	PowerON ProCon :Set	Page Cnt:BW	ENG*	[0 to 5000 / 0 / 1sheets/step]
3-530-008	PowerON ProCon :Set	Page Cnt:FC	ENG*	[0 to 5000 / 0 / 1sheets/step]
3-531-001	Non-useTime Procon :Set	Non-use Time Setting	ENG*	[0 to 1440 / 360 / 1minute/step]
3-531-002	Non-useTime Procon :Set	Temperature Range	ENG*	[0 to 99 / 10 / 1deg/step]
3-531-003	Non-useTime Procon :Set	Relative Humidity Range	ENG*	[0 to 99 / 50 / 1%RH/step]
3-531-004	Non-useTime Procon :Set	Absolute Humidity Range	ENG*	[0 to 99 / 6 / 1g/m3/step]
3-531-005	Non-useTime Procon :Set	Maximum Execution Number	ENG*	[0 to 99 / 10 / 1times/step]
3-533-001	Interrupt ProCon :Set	Interval:Set:BW	ENG*	[0 to 5000 / 500 / 1sheets/step]
3-533-002	Interrupt ProCon :Set	Interval:Disp:BW	ENG*	[0 to 5000 / 500 / 1sheets/step]
3-533-003	Interrupt ProCon :Set	Corr(Short):BW	ENG*	[0.00 to 1.00 / 1.00 / 0.01/step]
3-533-004	Interrupt ProCon :Set	Corr(Mid):BW	ENG*	[0.00 to 1.00 / 1.00 / 0.01/step]
3-533-011	Interrupt ProCon :Set	Interval:Set:FC	ENG*	[0 to 5000 / 200 / 1sheets/step]

3.SP Mode Tables

SP No.	Large Category	Small Category	ENG or CTL	[Min to Max/Init./Step]
3-533-012	Interrupt ProCon :Set	Interval:Disp:FC	ENG*	[0 to 5000 / 200 / 1sheets/step]
3-533-013	Interrupt ProCon :Set	Corr(Short):FC	ENG*	[0.00 to 1.00 / 1.00 / 0.01/step]
3-533-014	Interrupt ProCon :Set	Corr(Mid):FC	ENG*	[0.00 to 1.00 / 1.00 / 0.01/step]
3-534-001	JobEnd ProCon :Set	Interval:Set:BW	ENG*	[0 to 5000 / 500 / 1sheets/step]
3-534-002	JobEnd ProCon :Set	Interval:Disp:BW	ENG*	[0 to 5000 / 500 / 1sheets/step]
3-534-003	JobEnd ProCon :Set	Corr(Short):BW	ENG*	[0.00 to 1.00 / 1.00 / 0.01/step]
3-534-004	JobEnd ProCon :Set	Corr(Mid):BW	ENG*	[0.00 to 1.00 / 1.00 / 0.01/step]
3-534-011	JobEnd ProCon :Set	Interval:Set:FC	ENG*	[0 to 1000 / 200 / 1sheets/step]
3-534-012	JobEnd ProCon :Set	Interval:Disp:FC	ENG*	[0 to 5000 / 200 / 1sheets/step]
3-534-013	JobEnd ProCon :Set	Corr(Short):FC	ENG*	[0.00 to 1.00 / 1.00 / 0.01/step]
3-534-014	JobEnd ProCon :Set	Corr(Mid):FC	ENG*	[0.00 to 1.00 / 1.00 / 0.01/step]
3-539-001	Dev Agitating Time :Set	Time	ENG*	[0 to 3000 / 10 / 1sec/step]

3.SP Mode Tables

SP No.	Large Category	Small Category	ENG or CTL	[Min to Max/Init./Step]
3-539-010	Dev Agitating Time :Set	ON/OFF(by AbsHum)	ENG*	[0 to 1 / 1 / 1/step]
3-539-011	Dev Agitating Time :Set	by AbsHum:1	ENG*	[0 to 3000 / 0 / 1sec/step]
3-539-012	Dev Agitating Time :Set	by AbsHum:2	ENG*	[0 to 3000 / 5 / 1sec/step]
3-539-013	Dev Agitating Time :Set	by AbsHum:3	ENG*	[0 to 3000 / 5 / 1sec/step]
3-539-014	Dev Agitating Time :Set	by AbsHum:4	ENG*	[0 to 3000 / 5 / 1sec/step]
3-539-015	Dev Agitating Time :Set	by AbsHum:5	ENG*	[0 to 3000 / 5 / 1sec/step]
3-539-016	Dev Agitating Time :Set	by AbsHum:6	ENG*	[0 to 3000 / 5 / 1sec/step]
3-539-021	Dev Agitating Time :Set	AbsHum Threshold:1	ENG*	[0 to 100 / 4 / 1g/m3/step]
3-539-022	Dev Agitating Time :Set	AbsHum Threshold:2	ENG*	[0 to 100 / 8 / 1g/m3/step]
3-539-023	Dev Agitating Time :Set	AbsHum Threshold:3	ENG*	[0 to 100 / 12 / 1g/m3/step]
3-539-024	Dev Agitating Time :Set	AbsHum Threshold:4	ENG*	[0 to 100 / 16 / 1g/m3/step]
3-539-025	Dev Agitating Time :Set	AbsHum Threshold:5	ENG*	[0 to 100 / 24 / 1g/m3/step]

3.SP Mode Tables

SP No.	Large Category	Small Category	ENG or CTL	[Min to Max/Init./Step]
3-539-030	Dev Agitating Time :Set	ON/OFF(by Non-use Time)	ENG*	[0 to 1 / 1 / 1/step]
3-539-050	Dev Agitating Time :Set	ON/OFF(by Non-use Time)	ENG*	[0 to 1 / 1 / 1/step]
3-539-051	Dev Agitating Time :Set	by DotCoverage :1	ENG*	[0 to 3000 / 0 / 1sec/step]
3-539-052	Dev Agitating Time :Set	by DotCoverage :2	ENG*	[0 to 3000 / 0 / 1sec/step]
3-539-053	Dev Agitating Time :Set	by DotCoverage :3	ENG*	[0 to 3000 / 5 / 1sec/step]
3-539-054	Dev Agitating Time :Set	by DotCoverage :4	ENG*	[0 to 3000 / 5 / 1sec/step]
3-539-055	Dev Agitating Time :Set	by DotCoverage :5	ENG*	[0 to 3000 / 5 / 1sec/step]
3-539-056	Dev Agitating Time :Set	by DotCoverage :6	ENG*	[0 to 3000 / 5 / 1sec/step]
3-539-061	Dev Agitating Time :Set	DotCoverage Threshold:1	ENG*	[0 to 5000 / 10 / 1%/step]
3-539-062	Dev Agitating Time :Set	DotCoverage Threshold:2	ENG*	[0 to 5000 / 20 / 1%/step]
3-539-063	Dev Agitating Time :Set	DotCoverage Threshold:3	ENG*	[0 to 5000 / 30 / 1%/step]
3-539-064	Dev Agitating Time :Set	DotCoverage Threshold:4	ENG*	[0 to 5000 / 40 / 1%/step]

3.SP Mode Tables

SP No.	Large Category	Small Category	ENG or CTL	[Min to Max/Init./Step]
3-539-065	Dev Agitating Time :Set	DotCoverage Threshold:5	ENG*	[0 to 5000 / 50 / 1%/step]
3-539-099	Dev Agitating Time :Set	UpperLimit	ENG*	[0 to 3600 / 30 / 1sec/step]
3-541-001	Music Interval :Set	Page Cnt:BW	ENG*	[0 to 5000 / 0 / 1sheets/step]
3-541-002	Music Interval :Set	Page Cnt:FC	ENG*	[0 to 5000 / 0 / 1sheets/step]
3-541-004	Music Interval :Set	Distance Cnt:BW	ENG*	[0 to 64999 / 0 / 1mm/step]
3-541-005	Music Interval :Set	Distance Cnt:FC	ENG*	[0 to 64999 / 0 / 1mm/step]
3-550-001	Refresh Mode	Required Area: K	ENG*	[0 to 65535 / 0 / 1cm ² /step]
3-550-002	Refresh Mode	Required Area: C	ENG*	[0 to 65535 / 0 / 1cm ² /step]
3-550-003	Refresh Mode	Required Area: M	ENG*	[0 to 65535 / 0 / 1cm ² /step]
3-550-004	Refresh Mode	Required Area: Y	ENG*	[0 to 65535 / 0 / 1cm ² /step]
3-550-011	Refresh Mode	Dev. Unit Rotation: Display: Bk	ENG*	[0.0 to 1000.0 / 0.0 / 0.1m/step]
3-550-012	Refresh Mode	Dev. Unit Rotation: Display: C	ENG*	[0.0 to 1000.0 / 0.0 / 0.1m/step]

3.SP Mode Tables

SP No.	Large Category	Small Category	ENG or CTL	[Min to Max/Init./Step]
3-550-013	Refresh Mode	Dev. Unit Rotation: Display: M	ENG*	[0.0 to 1000.0 / 0.0 / 0.1m/step]
3-550-014	Refresh Mode	Dev. Unit Rotation: Display: Y	ENG*	[0.0 to 1000.0 / 0.0 / 0.1m/step]
3-550-031	Refresh Mode	Refresh Threshold: Bk	ENG*	IM C3500: [0 to 255 / 17 / 1cm ² /step] IM C2500: [0 to 255 / 84 / 1cm ² /step] IM C2000: [0 to 255 / 75 / 1cm ² /step] IM C3000: [0 to 255 / 17 / 1cm ² /step]
3-550-032	Refresh Mode	Refresh Threshold: C	ENG*	IM C3500: [0 to 255 / 34 / 1cm ² /step] IM C2500: [0 to 255 / 56 / 1cm ² /step] IM C2000: [0 to 255 / 52 / 1cm ² /step] IM C3000: [0 to 255 / 34 / 1cm ² /step]
3-550-033	Refresh Mode	Refresh Threshold: M	ENG*	IM C3500: [0 to 255 / 34 / 1cm ² /step] IM C2500: [0 to 255 / 56 / 1cm ² /step]

3.SP Mode Tables

SP No.	Large Category	Small Category	ENG or CTL	[Min to Max/Init./Step]
				IM C2000: [0 to 255 / 52 / 1cm ² /step] IM C3000: [0 to 255 / 34 / 1cm ² /step]
3-550-034	Refresh Mode	Refresh Threshold: Y	ENG*	IM C3500: [0 to 255 / 34 / 1cm ² /step] IM C2500: [0 to 255 / 56 / 1cm ² /step] IM C2000: [0 to 255 / 52 / 1cm ² /step] IM C3000: [0 to 255 / 34 / 1cm ² /step]
3-550-041	Refresh Mode	Job End Area Coefficient:K	ENG*	IM C3500: [0.1 to 25.5 / 1.0 / 0.1/step] IM C2500: [0.1 to 25.5 / 4.9 / 0.1/step] IM C2000: [0.1 to 25.5 / 4.4 / 0.1/step] IM C3000: [0.1 to 25.5 / 1.0 / 0.1/step]
3-550-042	Refresh Mode	Job End Vb Coefficient:K	ENG*	[0 to 100 / 40 / 1%/step]
3-550-043	Refresh Mode	Job End Length:K	ENG*	IM C3500: [0 to 255 / 25 / 1mm/step]

3.SP Mode Tables

SP No.	Large Category	Small Category	ENG or CTL	[Min to Max/Init./Step]
				IM C2500: [0 to 255 / 10 / 1mm/step] IM C2000: [0 to 255 / 10 / 1mm/step] IM C3000: [0 to 255 / 25 / 1mm/step]
3-550-044	Refresh Mode	Job End Supply	ENG*	IM C3500: [0.000 to 1.000 / 0.000 / 0.001mg/cm ² /step] IM C2500: [0.000 to 1.000 / 0.000 / 0.001mg/cm ² /step] IM C2000: [0.000 to 1.000 / 0.000 / 0.001mg/cm ² /step] IM C3000: [0.000 to 1.000 / 0.000 / 0.001mg/cm ² /step]
3-550-045	Refresh Mode	Job End Area Coefficient:YMC	ENG*	IM C3500: [0.1 to 25.5 / 1.0 / 0.1/step] IM C2500: [0.1 to 25.5 / 3.3 / 0.1/step] IM C2000: [0.1 to 25.5 / 3.1 / 0.1/step] IM C3000: [0.1 to 25.5 / 1.0 /

3.SP Mode Tables

SP No.	Large Category	Small Category	ENG or CTL	[Min to Max/Init./Step]
				0.1/step]
3-550-046	Refresh Mode	Job End Vb Coefficient:YMC	ENG*	[0 to 100 / 40 / 1%/step]
3-550-047	Refresh Mode	Job End Length:YMC	ENG*	IM C3500: [0 to 255 / 25 / 1mm/step] IM C2500: [0 to 255 / 10 / 1mm/step] IM C2000: [0 to 255 / 10 / 1mm/step] IM C3000: [0 to 255 / 25 / 1mm/step]
3-550-050	Refresh Mode	Threshold	ENG*	IM C3500: [0 to 65535 / 3400 / 1cm ² /step] IM C2500: [0 to 65535 / 62 / 1cm ² /step] IM C2000: [0 to 65535 / 56 / 1cm ² /step] IM C3000: [0 to 65535 / 3400 / 1cm ² /step]
3-550-081	Refresh Mode	TC Adj. Consume(Upp Limit)	ENG*	[0 to 255 / 0 / 1times/step]
3-553-001	Transfer belt cleaning	TransferIdleTime Temperature:H	ENG*	[0.0 to 3.0 / 0.0 / 0.1revolutions/step]
3-553-	Transfer belt cleaning	TransferIdleTime Temperature:M	ENG*	[0.0 to 3.0 / 0.0 / 0.1revolutions/step]

3.SP Mode Tables

SP No.	Large Category	Small Category	ENG or CTL	[Min to Max/Init./Step]
002				
3-553-003	Transfer belt cleaning	TransferIdleTime Temperature:L	ENG*	[0.0 to 3.0 / 0.0 / 0.1revolutions/step]
3-553-004	Transfer belt cleaning	TransferIdleTime Temperature:L:ON	ENG*	[0.0 to 3.0 / 0.0 / 0.1revolutions/step]
3-553-005	Transfer belt cleaning	Temperature Threshold:T2	ENG*	[20 to 30 / 25 / 1deg/step]
3-553-006	Transfer belt cleaning	Temperature Threshold:T1	ENG*	[0 to 15 / 15 / 1deg/step]
3-553-007	Transfer belt cleaning	Temperature Threshold:T3	ENG*	[0 to 30 / 5 / 1deg/step]
3-553-008	Transfer belt cleaning	TransferIdleTime Rotation :Initial	ENG*	[0.0 to 3.0 / 0.0 / 0.1revolutions/step]
3-553-009	Transfer belt cleaning	TransferIdleTime Rotation :Middle	ENG*	[0.0 to 3.0 / 0.0 / 0.1revolutions/step]
3-553-010	Transfer belt cleaning	TransferIdleTime Rotation :End	ENG*	[0.0 to 3.0 / 0.0 / 0.1revolutions/step]
3-553-011	Transfer belt cleaning	Transfer Rotation Threshold:L1	ENG*	[0 to 999999999 / 24000000 / 1mm/step]
3-553-012	Transfer belt cleaning	Transfer Rotation Threshold:L2	ENG*	[0 to 999999999 / 96000000 / 1mm/step]
3-555-001	ImageQuality Adj. Counter:Disp	Charge AC Control	ENG*	[0 to 2000 / 0 / 1page/step]
3-	Select ProCon	Potential Control	ENG*	[0 to 1 / 1 / 1/step]

3.SP Mode Tables

SP No.	Large Category	Small Category	ENG or CTL	[Min to Max/Init./Step]
600-001				
3-600-002	Select ProCon	LD Control	ENG*	[0 to 3 / 1 / 1/step]
3-600-003	Select ProCon	TC Adj. Mode	ENG*	[0 to 4 / 4 / 1/step]
3-600-004	Select ProCon	ACC Before ProCon	ENG*	[0 to 3 / 2 / 1/step]
3-600-010	Select ProCon	ActivePotentialControl	ENG*	[0 to 1 / 1 / 1/step]
3-600-030	Select ProCon	IBACC:ON/OFF	ENG*	[0 to 1 / 1 / 1/step]
3-600-060	Select ProCon	Vsg ITB Internal Circumference Correction	ENG*	[0 to 1 / 0 / 1/step]
3-600-080	ProCon System>Select	Background Pot ProCon:ON/OFF setting	ENG*	[0 to 1 / 1 / 1/step]
3-610-001	Chrg AC Control	Std Speed: K	ENG*	[0.00 to 3.00 / 2.20 / 0.01kV/step]
3-610-002	Chrg AC Control	Std Speed: C	ENG*	[0.00 to 3.00 / 2.20 / 0.01kV/step]
3-610-003	Chrg AC Control	Std Speed: M	ENG*	[0.00 to 3.00 / 2.20 / 0.01kV/step]
3-610-004	Chrg AC Control	Std Speed: Y	ENG*	[0.00 to 3.00 / 2.20 / 0.01kV/step]

3.SP Mode Tables

SP No.	Large Category	Small Category	ENG or CTL	[Min to Max/Init./Step]
3-611-001	Chrg DC Control	Std Speed: K	ENG*	[300 to 1000 / 670 / 1-V/step]
3-611-002	Chrg DC Control	Std Speed: C	ENG*	[300 to 1000 / 670 / 1-V/step]
3-611-003	Chrg DC Control	Std Speed: M	ENG*	[300 to 1000 / 670 / 1-V/step]
3-611-004	Chrg DC Control	Std Speed: Y	ENG*	[300 to 1000 / 670 / 1-V/step]
3-611-011	Chrg DC Control	Mid Speed: K	ENG*	[300 to 1000 / 670 / 1-V/step]
3-611-012	Chrg DC Control	Mid Speed: C	ENG*	[300 to 1000 / 670 / 1-V/step]
3-611-013	Chrg DC Control	Mid Speed: M	ENG*	[300 to 1000 / 670 / 1-V/step]
3-611-014	Chrg DC Control	Mid Speed: Y	ENG*	[300 to 1000 / 670 / 1-V/step]
3-611-021	Chrg DC Control	Low Speed: K	ENG*	[300 to 1000 / 670 / 1-V/step]
3-611-022	Chrg DC Control	Low Speed: C	ENG*	[300 to 1000 / 670 / 1-V/step]
3-611-023	Chrg DC Control	Low Speed: M	ENG*	[300 to 1000 / 670 / 1-V/step]
3-611-024	Chrg DC Control	Low Speed: Y	ENG*	[300 to 1000 / 670 / 1-V/step]

3.SP Mode Tables

SP No.	Large Category	Small Category	ENG or CTL	[Min to Max/Init./Step]
3-611-201	Chrg DC Control	Now:Std Speed: K	ENG	[300 to 1000 / 670 / 1-V/step]
3-611-202	Chrg DC Control	Now:Std Speed: C	ENG	[300 to 1000 / 670 / 1-V/step]
3-611-203	Chrg DC Control	Now:Std Speed: M	ENG	[300 to 1000 / 670 / 1-V/step]
3-611-204	Chrg DC Control	Now:Std Speed: Y	ENG	[300 to 1000 / 670 / 1-V/step]
3-611-211	Chrg DC Control	Now:Mid Speed: K	ENG	[300 to 1000 / 670 / 1-V/step]
3-611-212	Chrg DC Control	Now:Mid Speed: C	ENG	[300 to 1000 / 670 / 1-V/step]
3-611-213	Chrg DC Control	Now:Mid Speed: M	ENG	[300 to 1000 / 670 / 1-V/step]
3-611-214	Chrg DC Control	Now:Mid Speed: Y	ENG	[300 to 1000 / 670 / 1-V/step]
3-611-221	Chrg DC Control	Now:Low Speed: K	ENG	[300 to 1000 / 670 / 1-V/step]
3-611-222	Chrg DC Control	Now:Low Speed: C	ENG	[300 to 1000 / 670 / 1-V/step]
3-611-223	Chrg DC Control	Now:Low Speed: M	ENG	[300 to 1000 / 670 / 1-V/step]
3-611-224	Chrg DC Control	Now:Low Speed: Y	ENG	[300 to 1000 / 670 / 1-V/step]

3.SP Mode Tables

SP No.	Large Category	Small Category	ENG or CTL	[Min to Max/Init./Step]
3-612-001	Dev DC Control	Std Speed: K	ENG*	[200 to 800 / 550 / 1-V/step]
3-612-002	Dev DC Control	Std Speed: C	ENG*	[200 to 800 / 550 / 1-V/step]
3-612-003	Dev DC Control	Std Speed: M	ENG*	[200 to 800 / 550 / 1-V/step]
3-612-004	Dev DC Control	Std Speed: Y	ENG*	[200 to 800 / 550 / 1-V/step]
3-612-011	Dev DC Control	Mid Speed: K	ENG*	[200 to 800 / 550 / 1-V/step]
3-612-012	Dev DC Control	Mid Speed: C	ENG*	[200 to 800 / 550 / 1-V/step]
3-612-013	Dev DC Control	Mid Speed: M	ENG*	[200 to 800 / 550 / 1-V/step]
3-612-014	Dev DC Control	Mid Speed: Y	ENG*	[200 to 800 / 550 / 1-V/step]
3-612-021	Dev DC Control	Low Speed: K	ENG*	[200 to 800 / 550 / 1-V/step]
3-612-022	Dev DC Control	Low Speed: C	ENG*	[200 to 800 / 550 / 1-V/step]
3-612-023	Dev DC Control	Low Speed: M	ENG*	[200 to 800 / 550 / 1-V/step]
3-612-024	Dev DC Control	Low Speed: Y	ENG*	[200 to 800 / 550 / 1-V/step]

3.SP Mode Tables

SP No.	Large Category	Small Category	ENG or CTL	[Min to Max/Init./Step]
3-612-120	Dev DC Control	Set:Vb Limit	ENG*	[0 to 500 / 50 / 1V/step]
3-612-123	Dev DC Control	Set:Page Thresh_K	ENG*	[0 to 999999 / 35000 / 1page/step]
3-612-124	Dev DC Control	Set:Page Thresh_C	ENG*	[0 to 999999 / 35000 / 1page/step]
3-612-125	Dev DC Control	Set:Page Thresh_M	ENG*	[0 to 999999 / 35000 / 1page/step]
3-612-126	Dev DC Control	Set:Page Thresh_Y	ENG*	[0 to 999999 / 35000 / 1page/step]
3-612-131	Dev DC Control	Set:Upper Vb Current:K	ENG*	[0 to 800 / 600 / 1V/step]
3-612-132	Dev DC Control	Set:Upper Vb Current:C	ENG*	[0 to 800 / 600 / 1V/step]
3-612-133	Dev DC Control	Set:Upper Vb Current:M	ENG*	[0 to 800 / 600 / 1V/step]
3-612-134	Dev DC Control	Set:Upper Vb Current:Y	ENG*	[0 to 800 / 600 / 1V/step]
3-612-141	Dev DC Control	Set:Limit TC1_K	ENG*	[1.0 to 15.0 / 6.5 / 0.1wt%/step]
3-612-142	Dev DC Control	Set:Limit TC1_C	ENG*	[1.0 to 15.0 / 6.5 / 0.1wt%/step]
3-612-143	Dev DC Control	Set:Limit TC1_M	ENG*	[1.0 to 15.0 / 6.5 / 0.1wt%/step]

3.SP Mode Tables

SP No.	Large Category	Small Category	ENG or CTL	[Min to Max/Init./Step]
3-612-144	Dev DC Control	Set:Limit TC1_Y	ENG*	[1.0 to 15.0 / 6.5 / 0.1wt%/step]
3-612-151	Dev DC Control	Set:Limit TC2_K	ENG*	[1.0 to 15.0 / 7.0 / 0.1wt%/step]
3-612-152	Dev DC Control	Set:Limit TC2_C	ENG*	[1.0 to 15.0 / 7.0 / 0.1wt%/step]
3-612-153	Dev DC Control	Set:Limit TC2_M	ENG*	[1.0 to 15.0 / 7.0 / 0.1wt%/step]
3-612-154	Dev DC Control	Set:Limit TC2_Y	ENG*	[1.0 to 15.0 / 7.0 / 0.1wt%/step]
3-612-201	Dev DC Control	Now:Std Speed: K	ENG	[200 to 800 / 550 / 1-V/step]
3-612-202	Dev DC Control	Now:Std Speed: C	ENG	[200 to 800 / 550 / 1-V/step]
3-612-203	Dev DC Control	Now:Std Speed: M	ENG	[200 to 800 / 550 / 1-V/step]
3-612-204	Dev DC Control	Now:Std Speed: Y	ENG	[200 to 800 / 550 / 1-V/step]
3-612-211	Dev DC Control	Now:Mid Speed: K	ENG	[200 to 800 / 550 / 1-V/step]
3-612-212	Dev DC Control	Now:Mid Speed: C	ENG	[200 to 800 / 550 / 1-V/step]
3-612-213	Dev DC Control	Now:Mid Speed: M	ENG	[200 to 800 / 550 / 1-V/step]

3.SP Mode Tables

SP No.	Large Category	Small Category	ENG or CTL	[Min to Max/Init./Step]
3-612-214	Dev DC Control	Now:Mid Speed: Y	ENG	[200 to 800 / 550 / 1-V/step]
3-612-221	Dev DC Control	Now:Low Speed: K	ENG	[200 to 800 / 550 / 1-V/step]
3-612-222	Dev DC Control	Now:Low Speed: C	ENG	[200 to 800 / 550 / 1-V/step]
3-612-223	Dev DC Control	Now:Low Speed: M	ENG	[200 to 800 / 550 / 1-V/step]
3-612-224	Dev DC Control	Now:Low Speed: Y	ENG	[200 to 800 / 550 / 1-V/step]
3-613-001	LD Power Control	Std Speed: K	ENG*	[0 to 200 / 100 / 1%/step]
3-613-002	LD Power Control	Std Speed: C	ENG*	[0 to 200 / 100 / 1%/step]
3-613-003	LD Power Control	Std Speed: M	ENG*	[0 to 200 / 100 / 1%/step]
3-613-004	LD Power Control	Std Speed: Y	ENG*	[0 to 200 / 100 / 1%/step]
3-613-011	LD Power Control	Mid Speed: K	ENG*	[0 to 200 / 100 / 1%/step]
3-613-012	LD Power Control	Mid Speed: C	ENG*	[0 to 200 / 100 / 1%/step]
3-613-013	LD Power Control	Mid Speed: M	ENG*	[0 to 200 / 100 / 1%/step]

3.SP Mode Tables

SP No.	Large Category	Small Category	ENG or CTL	[Min to Max/Init./Step]
3-613-014	LD Power Control	Mid Speed: Y	ENG*	[0 to 200 / 100 / 1%/step]
3-613-021	LD Power Control	Low Speed: K	ENG*	[0 to 200 / 100 / 1%/step]
3-613-022	LD Power Control	Low Speed: C	ENG*	[0 to 200 / 100 / 1%/step]
3-613-023	LD Power Control	Low Speed: M	ENG*	[0 to 200 / 100 / 1%/step]
3-613-024	LD Power Control	Low Speed: Y	ENG*	[0 to 200 / 100 / 1%/step]
3-613-101	LD Power Control	PrcsCntrlCorrect:K	ENG*	IM C3500: [0 to 200 / 140 / 1%/step] IM C2500: [0 to 200 / 176 / 1%/step] IM C2000: [0 to 200 / 176 / 1%/step] IM C3000: [0 to 200 / 140 / 1%/step]
3-613-102	LD Power Control	PrcsCntrlCorrect:C	ENG*	IM C3500: [0 to 200 / 140 / 1%/step] IM C2500: [0 to 200 / 176 / 1%/step] IM C2000: [0 to 200 / 176 / 1%/step]

3.SP Mode Tables

SP No.	Large Category	Small Category	ENG or CTL	[Min to Max/Init./Step]
				IM C3000: [0 to 200 / 140 / 1%/step]
3-613-103	LD Power Control	PrcsCntrlCorrect:M	ENG*	IM C3500: [0 to 200 / 140 / 1%/step] IM C2500: [0 to 200 / 176 / 1%/step] IM C2000: [0 to 200 / 176 / 1%/step] IM C3000: [0 to 200 / 140 / 1%/step]
3-613-104	LD Power Control	PrcsCntrlCorrect:Y	ENG*	IM C3500: [0 to 200 / 140 / 1%/step] IM C2500: [0 to 200 / 176 / 1%/step] IM C2000: [0 to 200 / 176 / 1%/step] IM C3000: [0 to 200 / 140 / 1%/step]
3-613-201	LD Power Control	Now:Std Speed: K	ENG	[0 to 200 / 100 / 1%/step]
3-613-202	LD Power Control	Now:Std Speed: C	ENG	[0 to 200 / 100 / 1%/step]
3-613-203	LD Power Control	Now:Std Speed: M	ENG	[0 to 200 / 100 / 1%/step]

3.SP Mode Tables

SP No.	Large Category	Small Category	ENG or CTL	[Min to Max/Init./Step]
3-613-204	LD Power Control	Now:Std Speed: Y	ENG	[0 to 200 / 100 / 1%/step]
3-613-211	LD Power Control	Now:Mid Speed: K	ENG	[0 to 200 / 100 / 1%/step]
3-613-212	LD Power Control	Now:Mid Speed: C	ENG	[0 to 200 / 100 / 1%/step]
3-613-213	LD Power Control	Now:Mid Speed: M	ENG	[0 to 200 / 100 / 1%/step]
3-613-214	LD Power Control	Now:Mid Speed: Y	ENG	[0 to 200 / 100 / 1%/step]
3-613-221	LD Power Control	Now:Low Speed: K	ENG	[0 to 200 / 100 / 1%/step]
3-613-222	LD Power Control	Now:Low Speed: C	ENG	[0 to 200 / 100 / 1%/step]
3-613-223	LD Power Control	Now:Low Speed: M	ENG	[0 to 200 / 100 / 1%/step]
3-613-224	LD Power Control	Now:Low Speed: Y	ENG	[0 to 200 / 100 / 1%/step]
3-619-011	Bias:Spd Corr	VbCoef:Mid Spd: K	ENG*	[0.50 to 1.50 / 1.00 / 0.01/step]
3-619-012	Bias:Spd Corr	VbCoef:Mid Spd: C	ENG*	[0.50 to 1.50 / 1.00 / 0.01/step]
3-619-013	Bias:Spd Corr	VbCoef:Mid Spd: M	ENG*	[0.50 to 1.50 / 1.00 / 0.01/step]

3.SP Mode Tables

SP No.	Large Category	Small Category	ENG or CTL	[Min to Max/Init./Step]
3-619-014	Bias:Spd Corr	VbCoef:Mid Spd: Y	ENG*	[0.50 to 1.50 / 1.00 / 0.01/step]
3-619-021	Bias:Spd Corr	VbCoef:Low Spd: K	ENG*	[0.50 to 1.50 / 1.00 / 0.01/step]
3-619-022	Bias:Spd Corr	VbCoef:Low Spd: C	ENG*	[0.50 to 1.50 / 1.00 / 0.01/step]
3-619-023	Bias:Spd Corr	VbCoef:Low Spd: M	ENG*	[0.50 to 1.50 / 1.00 / 0.01/step]
3-619-024	Bias:Spd Corr	VbCoef:Low Spd: Y	ENG*	[0.50 to 1.50 / 1.00 / 0.01/step]
3-619-051	Bias:Spd Corr	Offset: Std Spd: K	ENG*	IM C3500: [-128 to 127 / 39 / 1V/step] IM C2500: [-128 to 127 / 2 / 1V/step] IM C2000: [-128 to 127 / 2 / 1V/step] IM C3000: [-128 to 127 / 39 / 1V/step]
3-619-052	Bias:Spd Corr	Offset: Std Spd: C	ENG*	IM C3500: [-128 to 127 / 39 / 1V/step] IM C2500: [-128 to 127 / 2 / 1V/step] IM C2000: [-128 to 127 / 2 / 1V/step]

3.SP Mode Tables

SP No.	Large Category	Small Category	ENG or CTL	[Min to Max/Init./Step]
				IM C3000: [-128 to 127 / 39 / 1V/step]
3-619-053	Bias:Spd Corr	Offset: Std Spd: M	ENG*	IM C3500: [-128 to 127 / 39 / 1V/step] IM C2500: [-128 to 127 / 2 / 1V/step] IM C2000: [-128 to 127 / 2 / 1V/step] IM C3000: [-128 to 127 / 39 / 1V/step]
3-619-054	Bias:Spd Corr	Offset: Std Spd: Y	ENG*	IM C3500: [-128 to 127 / 39 / 1V/step] IM C2500: [-128 to 127 / 2 / 1V/step] IM C2000: [-128 to 127 / 2 / 1V/step] IM C3000: [-128 to 127 / 39 / 1V/step]
3-619-061	Bias:Spd Corr	Offset: Mid Spd: K	ENG*	IM C3500: [-128 to 127 / 39 / 1V/step] IM C2500: [-128 to 127 / 2 / 1V/step] IM C2000: [-128 to 127 / 2 / 1V/step]

3.SP Mode Tables

SP No.	Large Category	Small Category	ENG or CTL	[Min to Max/Init./Step]
				IM C3000: [-128 to 127 / 39 / 1V/step]
3-619-062	Bias:Spd Corr	Offset: Mid Spd: C	ENG*	IM C3500: [-128 to 127 / 39 / 1V/step] IM C2500: [-128 to 127 / 2 / 1V/step] IM C2000: [-128 to 127 / 2 / 1V/step] IM C3000: [-128 to 127 / 39 / 1V/step]
3-619-063	Bias:Spd Corr	Offset: Mid Spd: M	ENG*	IM C3500: [-128 to 127 / 39 / 1V/step] IM C2500: [-128 to 127 / 2 / 1V/step] IM C2000: [-128 to 127 / 2 / 1V/step] IM C3000: [-128 to 127 / 39 / 1V/step]
3-619-064	Bias:Spd Corr	Offset: Mid Spd: Y	ENG*	IM C3500: [-128 to 127 / 39 / 1V/step] IM C2500: [-128 to 127 / 2 / 1V/step] IM C2000: [-128 to 127 / 2 / 1V/step]

3.SP Mode Tables

SP No.	Large Category	Small Category	ENG or CTL	[Min to Max/Init./Step]
				IM C3000: [-128 to 127 / 39 / 1V/step]
3-619-071	Bias:Spd Corr	Offset: Low Spd: K	ENG*	IM C3500: [-128 to 127 / 29 / 1V/step] IM C2500: [-128 to 127 / 2 / 1V/step] IM C2000: [-128 to 127 / 2 / 1V/step] IM C3000: [-128 to 127 / 29 / 1V/step]
3-619-072	Bias:Spd Corr	Offset: Low Spd: C	ENG*	IM C3500: [-128 to 127 / 29 / 1V/step] IM C2500: [-128 to 127 / 2 / 1V/step] IM C2000: [-128 to 127 / 2 / 1V/step] IM C3000: [-128 to 127 / 29 / 1V/step]
3-619-073	Bias:Spd Corr	Offset: Low Spd: M	ENG*	IM C3500: [-128 to 127 / 29 / 1V/step] IM C2500: [-128 to 127 / 2 / 1V/step] IM C2000: [-128 to 127 / 2 / 1V/step]

3.SP Mode Tables

SP No.	Large Category	Small Category	ENG or CTL	[Min to Max/Init./Step]
				IM C3000: [-128 to 127 / 29 / 1V/step]
3-619-074	Bias:Spd Corr	Offset: Low Spd: Y	ENG*	IM C3500: [-128 to 127 / 29 / 1V/step] IM C2500: [-128 to 127 / 2 / 1V/step] IM C2000: [-128 to 127 / 2 / 1V/step] IM C3000: [-128 to 127 / 29 / 1V/step]
3-620-001	ProCon Target M/A	Maximum M/A:K	ENG*	[0.250 to 0.750 / 0.370 / 0.001mg/cm2/step]
3-620-002	ProCon Target M/A	Maximum M/A:C	ENG*	[0.250 to 0.750 / 0.400 / 0.001mg/cm2/step]
3-620-003	ProCon Target M/A	Maximum M/A:M	ENG*	[0.250 to 0.750 / 0.450 / 0.001mg/cm2/step]
3-620-004	ProCon Target M/A	Maximum M/A:Y	ENG*	[0.250 to 0.750 / 0.400 / 0.001mg/cm2/step]
3-622-001	Dev Pot :Set	Current:K	ENG*	[0 to 800 / 0 / 1V/step]
3-622-002	Dev Pot :Set	Current:C	ENG*	[0 to 800 / 0 / 1V/step]
3-622-003	Dev Pot :Set	Current:M	ENG*	[0 to 800 / 0 / 1V/step]

3.SP Mode Tables

SP No.	Large Category	Small Category	ENG or CTL	[Min to Max/Init./Step]
3-622-004	Dev Pot :Set	Current:Y	ENG*	[0 to 800 / 0 / 1V/step]
3-622-011	Dev Pot :Set	Current:F_K	ENG	[0 to 800 / 0 / 1V/step]
3-622-012	Dev Pot :Set	Current:F_C	ENG	[0 to 800 / 0 / 1V/step]
3-622-013	Dev Pot :Set	Current:F_M	ENG	[0 to 800 / 0 / 1V/step]
3-622-014	Dev Pot :Set	Current:F_Y	ENG	[0 to 800 / 0 / 1V/step]
3-622-021	Dev Pot :Set	Current:C_K	ENG	[0 to 800 / 0 / 1V/step]
3-622-022	Dev Pot :Set	Current:C_C	ENG	[0 to 800 / 0 / 1V/step]
3-622-023	Dev Pot :Set	Current:C_M	ENG	[0 to 800 / 0 / 1V/step]
3-622-024	Dev Pot :Set	Current:C_Y	ENG	[0 to 800 / 0 / 1V/step]
3-622-031	Dev Pot :Set	Current:R_K	ENG	[0 to 800 / 0 / 1V/step]
3-622-032	Dev Pot :Set	Current:R_C	ENG	[0 to 800 / 0 / 1V/step]
3-622-033	Dev Pot :Set	Current:R_M	ENG	[0 to 800 / 0 / 1V/step]

3.SP Mode Tables

SP No.	Large Category	Small Category	ENG or CTL	[Min to Max/Init./Step]
3-622-034	Dev Pot :Set	Current:R_Y	ENG	[0 to 800 / 0 / 1V/step]
3-622-051	Dev Pot :Set	UpperLimit	ENG*	[400 to 800 / 700 / 1V/step]
3-622-052	Dev Pot :Set	UpperLimit	ENG*	[400 to 800 / 700 / 1V/step]
3-622-053	Dev Pot :Set	UpperLimit	ENG*	[400 to 800 / 700 / 1V/step]
3-622-054	Dev Pot :Set	UpperLimit	ENG*	[400 to 800 / 700 / 1V/step]
3-622-061	Dev Pot :Set	LowerLimit	ENG*	[0 to 400 / 200 / 1V/step]
3-622-062	Dev Pot :Set	LowerLimit	ENG*	[0 to 400 / 200 / 1V/step]
3-622-063	Dev Pot :Set	LowerLimit	ENG*	[0 to 400 / 200 / 1V/step]
3-622-064	Dev Pot :Set	LowerLimit	ENG*	[0 to 400 / 200 / 1V/step]
3-622-101	Dev DC Spd Correct:Set	Target:K	ENG*	[0 to 800 / 0 / 1V/step]
3-622-102	Dev DC Spd Correct:Set	Target:C	ENG*	[0 to 800 / 0 / 1V/step]
3-622-103	Dev DC Spd Correct:Set	Target:M	ENG*	[0 to 800 / 0 / 1V/step]

3.SP Mode Tables

SP No.	Large Category	Small Category	ENG or CTL	[Min to Max/Init./Step]
3-622-104	Dev DC Spd Correct:Set	Target:Y	ENG*	[0 to 800 / 0 / 1V/step]
3-622-111	Dev DC Spd Correct:Set	Target Corr:K	ENG*	[-128 to 127 / 0 / 1/step]
3-622-112	Dev DC Spd Correct:Set	Target Corr:C	ENG*	[-128 to 127 / 0 / 1/step]
3-622-113	Dev DC Spd Correct:Set	Target Corr:M	ENG*	[-128 to 127 / 0 / 1/step]
3-622-114	Dev DC Spd Correct:Set	Target Corr:Y	ENG*	[-128 to 127 / 0 / 1/step]
3-622-121	Dev DC Spd Correct:Set	Vk:Upper_K	ENG*	[0 to 255 / 30 / 1-V/step]
3-622-122	Dev DC Spd Correct:Set	Vk:Upper_C	ENG*	[0 to 255 / 30 / 1-V/step]
3-622-123	Dev DC Spd Correct:Set	Vk:Upper_M	ENG*	[0 to 255 / 30 / 1-V/step]
3-622-124	Dev DC Spd Correct:Set	Vk:Upper_Y	ENG*	[0 to 255 / 30 / 1-V/step]
3-622-131	Dev DC Spd Correct:Set	Vk:Lower_K	ENG*	[-128 to 0 / -90 / 1-V/step]
3-622-132	Dev DC Spd Correct:Set	Vk:Lower_C	ENG*	[-128 to 0 / -60 / 1-V/step]
3-622-133	Dev DC Spd Correct:Set	Vk:Lower_M	ENG*	[-128 to 0 / -60 / 1-V/step]

3.SP Mode Tables

SP No.	Large Category	Small Category	ENG or CTL	[Min to Max/Init./Step]
3-622-134	Dev DC Spd Correct:Set	Vk:Lower_Y	ENG*	[-128 to 0 / -60 / 1-V/step]
3-623-001	LD Power :Set	Std Speed Slope:K	ENG*	IM C3500: [-1000 to 1000 / 213 / 1/step] IM C2500: [-1000 to 1000 / 133 / 1/step] IM C2000: [-1000 to 1000 / 133 / 1/step] IM C3000: [-1000 to 1000 / 213 / 1/step]
3-623-002	LD Power :Set	Std Speed Slope:C	ENG*	IM C3500: [-1000 to 1000 / 213 / 1/step] IM C2500: [-1000 to 1000 / 133 / 1/step] IM C2000: [-1000 to 1000 / 133 / 1/step] IM C3000: [-1000 to 1000 / 213 / 1/step]
3-623-003	LD Power :Set	Std Speed Slope:M	ENG*	IM C3500: [-1000 to 1000 / 213 / 1/step] IM C2500: [-1000 to 1000 / 133 / 1/step] IM C2000: [-1000 to 1000 / 133 / 1/step]

3.SP Mode Tables

SP No.	Large Category	Small Category	ENG or CTL	[Min to Max/Init./Step]
				IM C3000: [-1000 to 1000 / 213 / 1/step]
3-623-004	LD Power :Set	Std Speed Slope:Y	ENG*	IM C3500: [-1000 to 1000 / 213 / 1/step] IM C2500: [-1000 to 1000 / 133 / 1/step] IM C2000: [-1000 to 1000 / 133 / 1/step] IM C3000: [-1000 to 1000 / 213 / 1/step]
3-623-011	LD Power :Set	Std Speed intercept:K	ENG*	IM C3500: [-1000 to 1000 / -7 / 1/step] IM C2500: [-1000 to 1000 / 31 / 1/step] IM C2000: [-1000 to 1000 / 31 / 1/step] IM C3000: [-1000 to 1000 / -7 / 1/step]
3-623-012	LD Power :Set	Std Speed intercept:C	ENG*	IM C3500: [-1000 to 1000 / -7 / 1/step] IM C2500: [-1000 to 1000 / 31 / 1/step] IM C2000: [-1000 to 1000 / 31 / 1/step]

3.SP Mode Tables

SP No.	Large Category	Small Category	ENG or CTL	[Min to Max/Init./Step]
				IM C3000: [-1000 to 1000 / -7 / 1/step]
3-623-013	LD Power :Set	Std Speed intercept:M	ENG*	IM C3500: [-1000 to 1000 / -7 / 1/step] IM C2500: [-1000 to 1000 / 31 / 1/step] IM C2000: [-1000 to 1000 / 31 / 1/step] IM C3000: [-1000 to 1000 / -7 / 1/step]
3-623-014	LD Power :Set	Std Speed intercept:Y	ENG*	IM C3500: [-1000 to 1000 / -7 / 1/step] IM C2500: [-1000 to 1000 / 31 / 1/step] IM C2000: [-1000 to 1000 / 31 / 1/step] IM C3000: [-1000 to 1000 / -7 / 1/step]
3-623-021	LD Power :Set	Mid Speed Slope:K	ENG*	IM C3500: [-1000 to 1000 / 213 / 1/step] IM C2500: [-1000 to 1000 / 133 / 1/step] IM C2000: [-1000 to 1000 / 133 / 1/step]

3.SP Mode Tables

SP No.	Large Category	Small Category	ENG or CTL	[Min to Max/Init./Step]
				IM C3000: [-1000 to 1000 / 213 / 1/step]
3-623-022	LD Power :Set	Mid Speed Slope:C	ENG*	IM C3500: [-1000 to 1000 / 213 / 1/step] IM C2500: [-1000 to 1000 / 133 / 1/step] IM C2000: [-1000 to 1000 / 133 / 1/step] IM C3000: [-1000 to 1000 / 213 / 1/step]
3-623-023	LD Power :Set	Mid Speed Slope:M	ENG*	IM C3500: [-1000 to 1000 / 213 / 1/step] IM C2500: [-1000 to 1000 / 133 / 1/step] IM C2000: [-1000 to 1000 / 133 / 1/step] IM C3000: [-1000 to 1000 / 213 / 1/step]
3-623-024	LD Power :Set	Mid Speed Slope:Y	ENG*	IM C3500: [-1000 to 1000 / 213 / 1/step] IM C2500: [-1000 to 1000 / 133 / 1/step] IM C2000: [-1000 to 1000 / 133 / 1/step]

3.SP Mode Tables

SP No.	Large Category	Small Category	ENG or CTL	[Min to Max/Init./Step]
				IM C3000: [-1000 to 1000 / 213 / 1/step]
3-623-031	LD Power :Set	Mid Speed intercept:K	ENG*	IM C3500: [-1000 to 1000 / -15 / 1/step] IM C2500: [-1000 to 1000 / 31 / 1/step] IM C2000: [-1000 to 1000 / 31 / 1/step] IM C3000: [-1000 to 1000 / -15 / 1/step]
3-623-032	LD Power :Set	Mid Speed intercept:C	ENG*	IM C3500: [-1000 to 1000 / -15 / 1/step] IM C2500: [-1000 to 1000 / 31 / 1/step] IM C2000: [-1000 to 1000 / 31 / 1/step] IM C3000: [-1000 to 1000 / -15 / 1/step]
3-623-033	LD Power :Set	Mid Speed intercept:M	ENG*	IM C3500: [-1000 to 1000 / -15 / 1/step] IM C2500: [-1000 to 1000 / 31 / 1/step] IM C2000: [-1000 to 1000 / 31 / 1/step]

3.SP Mode Tables

SP No.	Large Category	Small Category	ENG or CTL	[Min to Max/Init./Step]
				IM C3000: [-1000 to 1000 / -15 / 1/step]
3-623-034	LD Power :Set	Mid Speed intercept:Y	ENG*	IM C3500: [-1000 to 1000 / -15 / 1/step] IM C2500: [-1000 to 1000 / 31 / 1/step] IM C2000: [-1000 to 1000 / 31 / 1/step] IM C3000: [-1000 to 1000 / -15 / 1/step]
3-623-041	LD Power :Set	Low Speed Slope:K	ENG*	IM C3500: [-1000 to 1000 / 182 / 1/step] IM C2500: [-1000 to 1000 / 133 / 1/step] IM C2000: [-1000 to 1000 / 133 / 1/step] IM C3000: [-1000 to 1000 / 182 / 1/step]
3-623-042	LD Power :Set	Low Speed Slope:C	ENG*	IM C3500: [-1000 to 1000 / 182 / 1/step] IM C2500: [-1000 to 1000 / 133 / 1/step] IM C2000: [-1000 to 1000 / 133 / 1/step]

3.SP Mode Tables

SP No.	Large Category	Small Category	ENG or CTL	[Min to Max/Init./Step]
				IM C3000: [-1000 to 1000 / 182 / 1/step]
3-623-043	LD Power :Set	Low Speed Slope:M	ENG*	IM C3500: [-1000 to 1000 / 182 / 1/step] IM C2500: [-1000 to 1000 / 133 / 1/step] IM C2000: [-1000 to 1000 / 133 / 1/step] IM C3000: [-1000 to 1000 / 182 / 1/step]
3-623-044	LD Power :Set	Low Speed Slope:Y	ENG*	IM C3500: [-1000 to 1000 / 182 / 1/step] IM C2500: [-1000 to 1000 / 133 / 1/step] IM C2000: [-1000 to 1000 / 133 / 1/step] IM C3000: [-1000 to 1000 / 182 / 1/step]
3-623-051	LD Power :Set	Low Speed intercept:K	ENG*	IM C3500: [-1000 to 1000 / 0 / 1/step] IM C2500: [-1000 to 1000 / 18 / 1/step] IM C2000: [-1000 to 1000 / 18 / 1/step]

3.SP Mode Tables

SP No.	Large Category	Small Category	ENG or CTL	[Min to Max/Init./Step]
				IM C3000: [-1000 to 1000 / 0 / 1/step]
3-623-052	LD Power :Set	Low Speed intercept:C	ENG*	IM C3500: [-1000 to 1000 / 0 / 1/step] IM C2500: [-1000 to 1000 / 18 / 1/step] IM C2000: [-1000 to 1000 / 18 / 1/step] IM C3000: [-1000 to 1000 / 0 / 1/step]
3-623-053	LD Power :Set	Low Speed intercept:M	ENG*	IM C3500: [-1000 to 1000 / 0 / 1/step] IM C2500: [-1000 to 1000 / 18 / 1/step] IM C2000: [-1000 to 1000 / 18 / 1/step] IM C3000: [-1000 to 1000 / 0 / 1/step]
3-623-054	LD Power :Set	Low Speed intercept:Y	ENG*	IM C3500: [-1000 to 1000 / 0 / 1/step] IM C2500: [-1000 to 1000 / 18 / 1/step] IM C2000: [-1000 to 1000 / 18 / 1/step]

3.SP Mode Tables

SP No.	Large Category	Small Category	ENG or CTL	[Min to Max/Init./Step]
				IM C3000: [-1000 to 1000 / 0 / 1/step]
3-624-001	TC Adj. Mode	Target(Upp Limit)	ENG*	IM C3500: [0.00 to 1.00 / 0.15 / 0.01mg/cm2/-kV/step] IM C2500: [0.00 to 1.00 / 0.10 / 0.01mg/cm2/-kV/step] IM C2000: [0.00 to 1.00 / 0.10 / 0.01mg/cm2/-kV/step] IM C3000: [0.00 to 1.00 / 0.15 / 0.01mg/cm2/-kV/step]
3-624-002	TC Adj. Mode	Target(Lwr Limit)	ENG*	[-1.00 to 0.00 / -0.12 / 0.01mg/cm2/-kV/step]
3-624-021	TC Adj. Mode	Consumption Pat: DUTY: K	ENG*	[0 to 15 / 15 / 1/step]
3-624-022	TC Adj. Mode	Consumption Pat: DUTY: C	ENG*	[0 to 15 / 15 / 1/step]
3-624-023	TC Adj. Mode	Consumption Pat: DUTY: M	ENG*	[0 to 15 / 15 / 1/step]
3-624-024	TC Adj. Mode	Consumption Pat: DUTY: Y	ENG*	[0 to 15 / 15 / 1/step]
3-624-031	TC Adj. Mode	Max Counts:PowerON	ENG*	[0 to 10 / 1 / 1/step]
3-624-032	TC Adj. Mode	Max Counts:Job In	ENG*	[0 to 10 / 0 / 1/step]

3.SP Mode Tables

SP No.	Large Category	Small Category	ENG or CTL	[Min to Max/Init./Step]
3-624-033	TC Adj. Mode	Max Counts:Printing	ENG*	[0 to 10 / 0 / 1/step]
3-624-034	TC Adj. Mode	Max Counts:Job End	ENG*	[0 to 10 / 1 / 1/step]
3-624-035	TC Adj. Mode	Max Counts:ACC	ENG*	[0 to 10 / 2 / 1/step]
3-624-036	TC Adj. Mode	Max Counts:Initial Setting	ENG*	[0 to 10 / 3 / 1/step]
3-624-037	TC Adj. Mode	Max Counts:Replenishment	ENG*	[0 to 10 / 3 / 1/step]
3-624-038	TC Adj. Mode	Max Counts:Recovery	ENG*	[0 to 10 / 3 / 1/step]
3-624-071	TC Adj. Mode	AbsHumThresh(Upp)	ENG*	[0.00 to 100.00 / 18.00 / 0.01g/m3/step]
3-624-072	TC Adj. Mode	AbsHumThresh(Low)	ENG*	[0.00 to 100.00 / 4.00 / 0.01g/m3/step]
3-624-073	TC Adj. Mode	AbsHumThresh(Range)	ENG*	[0.00 to 100.00 / 12.00 / 0.01g/m3/step]
3-624-101	TC Adj. Mode	AbsHum: Threshold 2	ENG*	[0.00 to 100.00 / 15.00 / 0.01g/m3/step]
3-624-102	TC Adj. Mode	Delta AbsHum: Threshold 2	ENG*	[0.00 to 100.00 / 5.50 / 0.01g/m3/step]
3-624-111	TC Adj. Mode	Development DC Division Table	ENG*	[0 to 99 / 11 / 1-/step]

SP No.	Large Category	Small Category	ENG or CTL	[Min to Max/Init./Step]
3-624-112	TC Adj. Mode	Consumption Coefficient	ENG*	[0.0 to 1.0 / 0.0 / 0.1- /step]
3-624-113	TC Adj. Mode	Consumption: Threshold 1	ENG*	[0 to 10000 / 150 / 1mg/step]
3-624-114	TC Adj. Mode	Consumption: Threshold 2	ENG*	[0 to 10000 / 300 / 1mg/step]
3-624-115	TC Adj. Mode	Consumption: Threshold 3	ENG*	[0 to 10000 / 450 / 1mg/step]
3-624-116	TC Adj. Mode	Consumption: Threshold 4	ENG*	[0 to 10000 / 600 / 1mg/step]
3-624-117	TC Adj. Mode	Consumption: Threshold 5	ENG*	[0 to 10000 / 750 / 1mg/step]
3-624-118	TC Adj. Mode	Consumption: Threshold 6	ENG*	[0 to 10000 / 900 / 1mg/step]
3-624-121	TC Adj. Mode	Consumption: Threshold (Upp)	ENG*	[0 to 10000 / 150 / 1mg/step]
3-627-001	P Pattern Extraction :Set	Edge Detection Threshold :K	ENG*	[0.0 to 5.0 / 2.0 / 0.1V/step]
3-627-002	P Pattern Extraction :Set	Edge Detection Threshold :C	ENG*	[0.0 to 5.0 / 2.5 / 0.1V/step]
3-627-003	P Pattern Extraction :Set	Edge Detection Threshold :M	ENG*	[0.0 to 5.0 / 2.5 / 0.1V/step]
3-627-004	P Pattern Extraction :Set	Edge Detection Threshold :Y	ENG*	[0.0 to 5.0 / 2.5 / 0.1V/step]

3.SP Mode Tables

SP No.	Large Category	Small Category	ENG or CTL	[Min to Max/Init./Step]
3-627-011	P Pattern Extraction :Set	Edge Upper Limit:Potential Control	ENG*	[7.0 to 10.0 / 9.0 / 0.1mm/step]
3-627-012	P Pattern Extraction :Set	Edge Upper Limit:IBACC	ENG*	[10.0 to 13.0 / 12.0 / 0.1mm/step]
3-627-013	P Pattern Extraction :Set	Edge Upper Limit:RTP	ENG*	[5.0 to 8.0 / 7.0 / 0.1mm/step]
3-627-021	P Pattern Extraction :Set	Edge Lower Limit:Potential Control	ENG*	[4.0 to 7.0 / 5.0 / 0.1mm/step]
3-627-022	P Pattern Extraction :Set	Edge Lower Limit:IBACC	ENG*	[7.0 to 10.0 / 8.0 / 0.1mm/step]
3-627-023	P Pattern Extraction :Set	Edge Lower Limit:RTP	ENG*	[2.0 to 5.0 / 3.0 / 0.1mm/step]
3-628-001	ID Pattern Timing :Set	Scan: YCMK	ENG*	[-500.0 to 500.0 / 0.0 / 0.1mm/step]
3-628-002	ID Pattern Timing :Set	Detection Delay Time	ENG*	[0 to 2500 / 0 / 1msec/step]
3-628-003	ID Pattern Timing :Set	Delay Time	ENG*	[0 to 2500 / 778 / 1msec/step]
3-628-004	ID Pattern Timing :Set	MUSIC Delay Time	ENG*	[0 to 2500 / 150 / 1msec/step]
3-630-001	Dev gamma :Disp/Set	Current:K	ENG*	IM C3500: [0.10 to 6.00 / 0.81 / 0.01mg/cm2/-kV/step] IM C2500: [0.10 to 6.00 / 0.84 / 0.01mg/cm2/-kV/step]

3.SP Mode Tables

SP No.	Large Category	Small Category	ENG or CTL	[Min to Max/Init./Step]
				IM C2000: [0.10 to 6.00 / 0.84 / 0.01mg/cm2/-kV/step] IM C3000: [0.10 to 6.00 / 0.81 / 0.01mg/cm2/-kV/step]
3-630-002	Dev gamma :Disp/Set	Current:C	ENG*	IM C3500: [0.10 to 6.00 / 0.88 / 0.01mg/cm2/-kV/step] IM C2500: [0.10 to 6.00 / 0.88 / 0.01mg/cm2/-kV/step] IM C2000: [0.10 to 6.00 / 0.88 / 0.01mg/cm2/-kV/step] IM C3000: [0.10 to 6.00 / 0.88 / 0.01mg/cm2/-kV/step]
3-630-003	Dev gamma :Disp/Set	Current:M	ENG*	IM C3500: [0.10 to 6.00 / 0.80 / 0.01mg/cm2/-kV/step] IM C2500: [0.10 to 6.00 / 0.79 / 0.01mg/cm2/-kV/step] IM C2000: [0.10 to 6.00 / 0.79 / 0.01mg/cm2/-kV/step] IM C3000: [0.10 to 6.00 / 0.80 / 0.01mg/cm2/-kV/step]
3-630-004	Dev gamma :Disp/Set	Current:Y	ENG*	IM C3500: [0.10 to 6.00 / 0.88 / 0.01mg/cm2/-kV/step] IM C2500: [0.10 to 6.00 / 0.92 / 0.01mg/cm2/-kV/step]

3.SP Mode Tables

SP No.	Large Category	Small Category	ENG or CTL	[Min to Max/Init./Step]
				IM C2000: [0.10 to 6.00 / 0.92 / 0.01mg/cm2/-kV/step] IM C3000: [0.10 to 6.00 / 0.88 / 0.01mg/cm2/-kV/step]
3-630-011	Dev gamma :Disp/Set	Target:K	ENG*	IM C3500: [0.50 to 2.55 / 0.81 / 0.01mg/cm2/-kV/step] IM C2500: [0.50 to 2.55 / 0.84 / 0.01mg/cm2/-kV/step] IM C2000: [0.50 to 2.55 / 0.84 / 0.01mg/cm2/-kV/step] IM C3000: [0.50 to 2.55 / 0.81 / 0.01mg/cm2/-kV/step]
3-630-012	Dev gamma :Disp/Set	Target:C	ENG*	IM C3500: [0.50 to 2.55 / 0.88 / 0.01mg/cm2/-kV/step] IM C2500: [0.50 to 2.55 / 0.88 / 0.01mg/cm2/-kV/step] IM C2000: [0.50 to 2.55 / 0.88 / 0.01mg/cm2/-kV/step] IM C3000: [0.50 to 2.55 / 0.88 / 0.01mg/cm2/-kV/step]
3-630-013	Dev gamma :Disp/Set	Target:M	ENG*	IM C3500: [0.50 to 2.55 / 0.80 / 0.01mg/cm2/-kV/step] IM C2500: [0.50 to 2.55 / 0.79 / 0.01mg/cm2/-kV/step]

3.SP Mode Tables

SP No.	Large Category	Small Category	ENG or CTL	[Min to Max/Init./Step]
				IM C2000: [0.50 to 2.55 / 0.79 / 0.01mg/cm2/-kV/step] IM C3000: [0.50 to 2.55 / 0.80 / 0.01mg/cm2/-kV/step]
3-630-014	Dev gamma :Disp/Set	Target:Y	ENG*	IM C3500: [0.50 to 2.55 / 0.88 / 0.01mg/cm2/-kV/step] IM C2500: [0.50 to 2.55 / 0.92 / 0.01mg/cm2/-kV/step] IM C2000: [0.50 to 2.55 / 0.92 / 0.01mg/cm2/-kV/step] IM C3000: [0.50 to 2.55 / 0.88 / 0.01mg/cm2/-kV/step]
3-630-061	Dev gamma :Disp/Set	TnrDensity:K	ENG*	[0.0 to 25.5 / 0.0 / 0.1wt%/step]
3-630-062	Dev gamma :Disp/Set	TnrDensity:C	ENG*	[0.0 to 25.5 / 0.0 / 0.1wt%/step]
3-630-063	Dev gamma :Disp/Set	TnrDensity:M	ENG*	[0.0 to 25.5 / 0.0 / 0.1wt%/step]
3-630-064	Dev gamma :Disp/Set	TnrDensity:Y	ENG*	[0.0 to 25.5 / 0.0 / 0.1wt%/step]
3-630-111	Dev gamma :Disp/Set	Current:F_K	ENG	[0.10 to 6.00 / 0.90 / 0.01mg/cm2/-kV/step]
3-630-112	Dev gamma :Disp/Set	Current:F_C	ENG	[0.10 to 6.00 / 0.80 / 0.01mg/cm2/-kV/step]

3.SP Mode Tables

SP No.	Large Category	Small Category	ENG or CTL	[Min to Max/Init./Step]
3-630-113	Dev gamma :Disp/Set	Current:F_M	ENG	[0.10 to 6.00 / 0.80 / 0.01mg/cm2/-kV/step]
3-630-114	Dev gamma :Disp/Set	Current:F_Y	ENG	[0.10 to 6.00 / 0.80 / 0.01mg/cm2/-kV/step]
3-630-121	Dev gamma :Disp/Set	Current:C_K	ENG	[0.10 to 6.00 / 0.90 / 0.01mg/cm2/-kV/step]
3-630-122	Dev gamma :Disp/Set	Current:C_C	ENG	[0.10 to 6.00 / 0.80 / 0.01mg/cm2/-kV/step]
3-630-123	Dev gamma :Disp/Set	Current:C_M	ENG	[0.10 to 6.00 / 0.80 / 0.01mg/cm2/-kV/step]
3-630-124	Dev gamma :Disp/Set	Current:C_Y	ENG	[0.10 to 6.00 / 0.80 / 0.01mg/cm2/-kV/step]
3-630-131	Dev gamma :Disp/Set	Current:R_K	ENG	[0.10 to 6.00 / 0.90 / 0.01mg/cm2/-kV/step]
3-630-132	Dev gamma :Disp/Set	Current:R_C	ENG	[0.10 to 6.00 / 0.80 / 0.01mg/cm2/-kV/step]
3-630-133	Dev gamma :Disp/Set	Current:R_M	ENG	[0.10 to 6.00 / 0.80 / 0.01mg/cm2/-kV/step]
3-630-134	Dev gamma :Disp/Set	Current:R_Y	ENG	[0.10 to 6.00 / 0.80 / 0.01mg/cm2/-kV/step]
3-630-141	Dev gamma :Disp/Set	Range M/A Upp:K	ENG*	[0.20 to 1.00 / 0.40 / 0.01mg/cm2/step]
3-630-142	Dev gamma :Disp/Set	Range M/A Low:K	ENG*	[0.00 to 0.20 / 0.05 / 0.01mg/cm2/step]

3.SP Mode Tables

SP No.	Large Category	Small Category	ENG or CTL	[Min to Max/Init./Step]
3-630-143	Dev gamma :Disp/Set	Range M/A Upp:Col	ENG*	[0.20 to 1.00 / 0.50 / 0.01mg/cm2/step]
3-630-144	Dev gamma :Disp/Set	Range M/A Low:Col	ENG*	[0.00 to 0.20 / 0.05 / 0.01mg/cm2/step]
3-631-001	Vk :Disp	Current:K	ENG*	[-300 to 300 / 0 / 1-V/step]
3-631-002	Vk :Disp	Current:C	ENG*	[-300 to 300 / 0 / 1-V/step]
3-631-003	Vk :Disp	Current:M	ENG*	[-300 to 300 / 0 / 1-V/step]
3-631-004	Vk :Disp	Current:Y	ENG*	[-300 to 300 / 0 / 1-V/step]
3-631-111	Vk :Disp	Current:F_K	ENG	[-300 to 300 / 0 / 1-V/step]
3-631-112	Vk :Disp	Current:F_C	ENG	[-300 to 300 / 0 / 1-V/step]
3-631-113	Vk :Disp	Current:F_M	ENG	[-300 to 300 / 0 / 1-V/step]
3-631-114	Vk :Disp	Current:F_Y	ENG	[-300 to 300 / 0 / 1-V/step]
3-631-121	Vk :Disp	Current:C_K	ENG	[-300 to 300 / 0 / 1-V/step]
3-631-122	Vk :Disp	Current:C_C	ENG	[-300 to 300 / 0 / 1-V/step]

3.SP Mode Tables

SP No.	Large Category	Small Category	ENG or CTL	[Min to Max/Init./Step]
3-631-123	Vk :Disp	Current:C_M	ENG	[-300 to 300 / 0 / 1-V/step]
3-631-124	Vk :Disp	Current:C_Y	ENG	[-300 to 300 / 0 / 1-V/step]
3-631-131	Vk :Disp	Current:R_K	ENG	[-300 to 300 / 0 / 1-V/step]
3-631-132	Vk :Disp	Current:R_C	ENG	[-300 to 300 / 0 / 1-V/step]
3-631-133	Vk :Disp	Current:R_M	ENG	[-300 to 300 / 0 / 1-V/step]
3-631-134	Vk :Disp	Current:R_Y	ENG	[-300 to 300 / 0 / 1-V/step]
3-680-001	Shading Compensation	Plus Image Quantity: K	ENG*	[-20 to 20 / 0 / 1/step]
3-680-002	Shading Compensation	Plus Image Quantity: C	ENG*	[-20 to 20 / 0 / 1/step]
3-680-003	Shading Compensation	Plus Image Quantity: M	ENG*	[-20 to 20 / 0 / 1/step]
3-680-004	Shading Compensation	Plus Image Quantity: Y	ENG*	[-20 to 20 / 0 / 1/step]
3-680-011	Shading Compensation	Minus Image Quantity: K	ENG*	[-20 to 20 / 0 / 1/step]
3-680-012	Shading Compensation	Minus Image Quantity: C	ENG*	[-20 to 20 / 0 / 1/step]

3.SP Mode Tables

SP No.	Large Category	Small Category	ENG or CTL	[Min to Max/Init./Step]
3-680-013	Shading Compensation	Minus Image Quantity: M	ENG*	[-20 to 20 / 0 / 1/step]
3-680-014	Shading Compensation	Minus Image Quantity: Y	ENG*	[-20 to 20 / 0 / 1/step]
3-690-001	Background Pot ProCon	Correction Coefficient h:Disp: K	ENG*	[-100 to 100 / 0 / 1-V/step]
3-690-002	Background Pot ProCon	Correction Coefficient h:Disp: C	ENG*	[-100 to 100 / 0 / 1-V/step]
3-690-003	Background Pot ProCon	Correction Coefficient h:Disp: M	ENG*	[-100 to 100 / 0 / 1-V/step]
3-690-004	Background Pot ProCon	Correction Coefficient h:Disp: Y	ENG*	[-100 to 100 / 0 / 1-V/step]
3-690-011	Background Pot ProCon	Correction Coefficient h_1: K	ENG*	[-100 to 100 / 0 / 1-V/step]
3-690-012	Background Pot ProCon	Correction Coefficient h_1: C	ENG*	[-100 to 100 / 0 / 1-V/step]
3-690-013	Background Pot ProCon	Correction Coefficient h_1: M	ENG*	[-100 to 100 / 0 / 1-V/step]
3-690-014	Background Pot ProCon	Correction Coefficient h_1: Y	ENG*	[-100 to 100 / 0 / 1-V/step]
3-690-021	Background Pot ProCon	Correction Coefficient h_1:Upper	ENG*	[-100 to 100 / 50 / 1-V/step]
3-690-022	Background Pot ProCon	Correction Coefficient h_1:Lower	ENG*	[-100 to 100 / 0 / 1-V/step]

3.SP Mode Tables

SP No.	Large Category	Small Category	ENG or CTL	[Min to Max/Init./Step]
3-690-025	Background Pot ProCon	h_1 Coefficient	ENG*	[0.00 to 2.55 / 0.50 / 0.01-/step]
3-690-031	Background Pot ProCon	Dev gamma h_1 :Disp:K	ENG*	[0.00 to 6.00 / 0.00 / 0.01mg/cm2/-kV/step]
3-690-032	Background Pot ProCon	Dev gamma h_1 :Disp:C	ENG*	[0.00 to 6.00 / 0.00 / 0.01mg/cm2/-kV/step]
3-690-033	Background Pot ProCon	Dev gamma h_1 :Disp:M	ENG*	[0.00 to 6.00 / 0.00 / 0.01mg/cm2/-kV/step]
3-690-034	Background Pot ProCon	Dev gamma h_1 :Disp:Y	ENG*	[0.00 to 6.00 / 0.00 / 0.01mg/cm2/-kV/step]
3-690-051	Background Pot ProCon	Vkh_1 :Disp:K	ENG*	[-300 to 300 / 0 / 1-V/step]
3-690-052	Background Pot ProCon	Vkh_1 :Disp:C	ENG*	[-300 to 300 / 0 / 1-V/step]
3-690-053	Background Pot ProCon	Vkh_1 :Disp:M	ENG*	[-300 to 300 / 0 / 1-V/step]
3-690-054	Background Pot ProCon	Vkh_1 :Disp:Y	ENG*	[-300 to 300 / 0 / 1-V/step]
3-690-101	Background Pot ProCon	Threshold:Correction Coefficient h	ENG*	[0 to 255 / 10 / 1-V/step]
3-690-102	Background Pot ProCon	Threshold:Temperature	ENG*	[0.0 to 99.0 / 10.0 / 0.1deg/step]
3-690-103	Background Pot ProCon	Threshold:AbsoluteHumidity:Low	ENG*	[0.0 to 10.0 / 5.0 / 0.1g/m3/step]

3.SP Mode Tables

SP No.	Large Category	Small Category	ENG or CTL	[Min to Max/Init./Step]
3-690-104	Background Pot ProCon	Threshold:AbsoluteHumidity:Hi	ENG*	[10.0 to 99.0 / 16.0 / 0.1g/m3/step]
3-690-105	Background Pot ProCon	Temperature At Prev Correction	ENG*	[-99.0 to 99.0 / 0.0 / 0.1deg/step]
3-690-106	Background Pot ProCon	Threshold: Temperature change	ENG*	[0.0 to 99.0 / 10.0 / 0.1deg/step]
3-690-107	Background Pot ProCon	AbsoluteHumidity At Prev Correction	ENG*	[0.0 to 99.0 / 0.0 / 0.1g/m3/step]
3-690-108	Background Pot ProCon	Threshold:Humidity change	ENG*	[0.0 to 99.0 / 5.0 / 0.1g/m3/step]
3-690-109	Background Pot ProCon	Count:Disp:Pages	ENG*	[0 to 999 / 0 / 1page/step]
3-690-110	Background Pot ProCon	Threshold:Interval	ENG*	[0 to 999 / 0 / 1page/step]
3-690-111	Background Pot ProCon	Max: Correction Coefficient change	ENG*	[0 to 255 / 0 / 1-V/step]
3-690-112	Background Pot ProCon	Threshold: Correction Coefficient change	ENG*	[0 to 255 / 0 / 1-V/step]
3-690-113	Background Pot ProCon	Threshold:Correction Coefficient h:JobEnd	ENG*	[0 to 255 / 0 / 1-V/step]
3-690-141	Background Pot ProCon	Vk Offset:Low Humidity:K	ENG*	[0 to 255 / 100 / 1-V/step]
3-690-142	Background Pot ProCon	Vk Offset:Low Humidity:CMY	ENG*	[0 to 255 / 100 / 1-V/step]

3.SP Mode Tables

SP No.	Large Category	Small Category	ENG or CTL	[Min to Max/Init./Step]
3-690-143	Background Pot ProCon	Vk Offset:Std Humidity:K	ENG*	[0 to 255 / 100 / 1-V/step]
3-690-144	Background Pot ProCon	Vk Offset:Std Humidity:CMY	ENG*	[0 to 255 / 100 / 1-V/step]
3-690-145	Background Pot ProCon	Vk Offset:Hi Humidity:K	ENG*	[0 to 255 / 100 / 1-V/step]
3-690-146	Background Pot ProCon	Vk Offset:Hi Humidity:CMY	ENG*	[0 to 255 / 100 / 1-V/step]
3-700-001	New Unit Detection	ON/OFF Setting	ENG*	[0 to 1 / 1 / 1/step]
3-701-002	Manual New Unit Set	# PCU:K	ENG*	[0 to 1 / 0 / 1/step]
3-701-003	Manual New Unit Set	# Dev Unit:K	ENG*	[0 to 1 / 0 / 1/step]
3-701-025	Manual New Unit Set	# PCU:C	ENG*	[0 to 1 / 0 / 1/step]
3-701-026	Manual New Unit Set	# Dev Unit:C	ENG*	[0 to 1 / 0 / 1/step]
3-701-048	Manual New Unit Set	# PCU:M	ENG*	[0 to 1 / 0 / 1/step]
3-701-049	Manual New Unit Set	# Dev Unit:M	ENG*	[0 to 1 / 0 / 1/step]
3-701-071	Manual New Unit Set	# PCU:Y	ENG*	[0 to 1 / 0 / 1/step]

3.SP Mode Tables

SP No.	Large Category	Small Category	ENG or CTL	[Min to Max/Init./Step]
3-701-072	Manual New Unit Set	# Dev Unit:Y	ENG*	[0 to 1 / 0 / 1/step]
3-701-093	Manual New Unit Set	# ITB Unit	ENG*	[0 to 1 / 0 / 1/step]
3-701-102	Manual New Unit Set	# ITB Cleaning Unit	ENG*	[0 to 1 / 0 / 1/step]
3-701-109	Manual New Unit Set	# PTR Unit	ENG*	[0 to 1 / 0 / 1/step]
3-701-115	Manual New Unit Set	# Fusing Unit	ENG*	[0 to 1 / 0 / 1/step]
3-701-116	Manual New Unit Set	Fusing Belt	ENG*	[0 to 1 / 0 / 1/step]
3-701-118	Manual New Unit Set	Pressure Roller	ENG*	[0 to 1 / 0 / 1/step]
3-701-131	Manual New Unit Set	Dust Filter	ENG*	[0 to 1 / 0 / 1/step]
3-701-142	Manual New Unit Set	Waste Toner Bottle	ENG*	[0 to 1 / 0 / 1/step]
3-701-206	Manual New Unit Set	ADF Pick-up Roller	ENG*	[0 to 1 / 0 / 1/step]
3-701-207	Manual New Unit Set	ADF Supply Belt	ENG*	[0 to 1 / 0 / 1/step]
3-701-208	Manual New Unit Set	ADF Reverse Roller	ENG*	[0 to 1 / 0 / 1/step]

3.SP Mode Tables

SP No.	Large Category	Small Category	ENG or CTL	[Min to Max/Init./Step]
3-704-001	PCU Voltage Correction	ON/OFF Setting	ENG*	IM C3500: [0 to 1 / 0 / 1/step] IM C2500: [0 to 1 / 1 / 1/step] IM C2000: [0 to 1 / 1 / 1/step] IM C3000: [0 to 1 / 0 / 1/step]
3-800-001	Waste Toner Full Detection	Condition	ENG*	[0 to 4 / 0 / 1/step]
3-800-002	Waste Toner Full Detection	Page Count 1 After Near Full	ENG*	[0 to 1000000 / 0 / 1sheet/step]
3-800-003	Waste Toner Full Detection	Volume Count 1 After Near Full	ENG*	[0.0 to 10000000.0 / 0.0 / 0.1mg/step]
3-800-004	Waste Toner Full Detection	Volume Count 1 After Replacement	ENG*	[0.0 to 10000000.0 / 0.0 / 0.1mg/step]
3-800-005	Waste Toner Full Detection	Volume Count 2 After Replacement	ENG*	[0.0 to 10000000.0 / 0.0 / 0.1mg/step]
3-800-006	Waste Toner Full Detection	Page Count 2 After Near Full	ENG*	[0 to 1000000 / 0 / 1sheet/step]
3-800-007	Waste Toner Full Detection	Volume Count 2 After Near Full	ENG*	[0.0 to 10000000.0 / 0.0 / 0.1mg/step]
3-800-014	Waste Toner Full Detection	Threshold : Remainder days	ENG*	IM C3500: [1 to 255 / 15 / 1day/step] IM C2500: [1 to 255 / 15 / 1day/step] IM C2000:

3.SP Mode Tables

SP No.	Large Category	Small Category	ENG or CTL	[Min to Max/Init./Step]
				[1 to 255 / 15 / 1day/step] IM C3000: [1 to 255 / 15 / 1day/step]
3-800-024	Waste Toner Full Detection	Date of detection for near full	ENG*	[0 to 1 / 0 / 1/step]
3-802-001	Waste Toner Bottle Call	Automatic Ordering Thresh	ENG*	[26.0 to 90.0 / 50.0 / 0.1%/step]
3-831-011	SFBVSC:Choice	Reflect of Correction	ENG*	[0 to 1 / 0 / 1/step]
3-905-001	Recycled Parts: New/Old Flag	OPC:K	ENG*	[0 to 1 / 0 / 1/step]
3-905-002	Recycled Parts: New/Old Flag	OPC:C	ENG*	[0 to 1 / 0 / 1/step]
3-905-003	Recycled Parts: New/Old Flag	OPC:M	ENG*	[0 to 1 / 0 / 1/step]
3-905-004	Recycled Parts: New/Old Flag	OPC:Y	ENG*	[0 to 1 / 0 / 1/step]
3-946-001	Processing Stop Times: Display	BW	ENG*	[0 to 4000000000 / 0 / 1counts/step]
3-946-002	Processing Stop Times: Display	FC	ENG*	[0 to 4000000000 / 0 / 1counts/step]
3-990-001	Abs Temp.:Get Charge Load	Temperature: Display	ENG*	[0.0 to 70.0 / 0.0 / 0.1deg/step]
3-	Abs Humidity:Get	Abs Humidity: Display	ENG*	[0.00 to 100.00 / 0.00]

3.SP Mode Tables

SP No.	Large Category	Small Category	ENG or CTL	[Min to Max/Init./Step]
990-002	Charge Load			/ 0.01g/m3/step]

Engine SP Tables-4

SP4-XXX (Scanner)

SP No.	Large Category	Small Category	ENG or CTL	[Min to Max/Init./Step]
4-008-001	Sub Scan Magnification Adj		ENG*	[-1.0 to 1.0 / 0.0 / 0.1%/step]
4-010-001	Sub Scan Registration Adj		ENG*	[-2.0 to 2.0 / 0.0 / 0.1mm/step]
4-011-001	Main Scan Reg		ENG*	[-2.5 to 2.5 / 0.0 / 0.1mm/step]
4-012-001	Set Scale Mask	Book:Sub LEdge	ENG	[0.0 to 3.0 / 1.0 / 0.1mm/step]
4-012-002	Set Scale Mask	Book:Sub TEdge	ENG	[0.0 to 3.0 / 0.0 / 0.1mm/step]
4-012-003	Set Scale Mask	Book:Main:LEdge	ENG	[0.0 to 3.0 / 1.0 / 0.1mm/step]
4-012-004	Set Scale Mask	Book:Main:TEdge	ENG	[0.0 to 3.0 / 0.0 / 0.1mm/step]
4-012-005	Set Scale Mask	ADF: Leading Edge	ENG*	[0.0 to 3.0 / 0.0 / 0.1mm/step]
4-012-007	Set Scale Mask	ADF: Right	ENG*	[0.0 to 3.0 / 0.0 / 0.1mm/step]
4-012-008	Set Scale Mask	ADF: left	ENG*	[0.0 to 3.0 / 0.0 / 0.1mm/step]
4-013-001	Scanner Free run	Book mode :Lamp Off	ENG	[0 to 1 / 0 / 1/step]
4-013-002	Scanner Free run	Book mode :Lamp On	ENG	[0 to 1 / 0 / 1/step]
4-020-001	Dust Check	Dust Detect:On/Off	ENG	[0 to 1 / 0 / 1/step]
4-020-002	Dust Check	Dust Detect:Lvl	ENG	[0 to 8 / 4 / 1/step]

3.SP Mode Tables

SP No.	Large Category	Small Category	ENG or CTL	[Min to Max/Init./Step]
4-020-003	Dust Check Lvl	Dust Reject:Lvl	ENG	[0 to 4 / 0 / 1/step]
4-020-011	DF Dust Check	Dust Detect Level:Rear	ENG	[0 to 1 / 0 / 1/step]
4-020-012	DF Dust Check	Correction Level:Rear	ENG	[0 to 8 / 4 / 1/step]
4-201-001	LoCPP edge lv:K	600dpi 2bit edge1	ENG*	[0 to 15 / 11 / 1/step]
4-201-002	LoCPP edge lv:K	600dpi 2bit edge2	ENG*	[0 to 15 / 11 / 1/step]
4-201-003	LoCPP edge lv:K	600dpi 4bit edge1	ENG*	[0 to 15 / 11 / 1/step]
4-201-004	LoCPP edge lv:K	600dpi 4bit edge2	ENG*	[0 to 15 / 11 / 1/step]
4-201-005	LoCPP edge lv:K	600dpi 1bit edge1	ENG*	[0 to 15 / 15 / 1/step]
4-201-006	LoCPP edge lv:K	600dpi 1bit edge2	ENG*	[0 to 15 / 15 / 1/step]
4-201-011	LoCPP edge lv:K	1200dpi1bit edge12	ENG*	[0 to 15 / 12 / 1/step]
4-201-012	LoCPP edge lv:K	1200dpi1bit edge34	ENG*	[0 to 15 / 12 / 1/step]
4-201-013	LoCPP edge lv:K	1200dpi2bit edge12	ENG*	[0 to 15 / 15 / 1/step]
4-201-014	LoCPP edge lv:K	1200dpi2bit edge34	ENG*	[0 to 15 / 15 / 1/step]
4-202-001	LoCPP edge lv:C	600dpi 2bit edge1	ENG*	[0 to 15 / 15 / 1/step]
4-202-002	LoCPP edge lv:C	600dpi 2bit edge2	ENG*	[0 to 15 / 15 / 1/step]
4-202-003	LoCPP edge lv:C	600dpi 4bit edge1	ENG*	[0 to 15 / 15 / 1/step]
4-202-004	LoCPP edge lv:C	600dpi 4bit edge2	ENG*	[0 to 15 / 15 / 1/step]
4-202-005	LoCPP edge lv:C	600dpi 1bit edge1	ENG*	[0 to 15 / 15 / 1/step]

3.SP Mode Tables

SP No.	Large Category	Small Category	ENG or CTL	[Min to Max/Init./Step]
4-202-006	LoCPP edge lv:C	600dpi 1bit edge2	ENG*	[0 to 15 / 15 / 1/step]
4-202-011	LoCPP edge lv:C	1200dpi1bit edge12	ENG*	[0 to 15 / 15 / 1/step]
4-202-012	LoCPP edge lv:C	1200dpi1bit edge34	ENG*	[0 to 15 / 15 / 1/step]
4-202-013	LoCPP edge lv:C	1200dpi2bit edge12	ENG*	[0 to 15 / 15 / 1/step]
4-202-014	LoCPP edge lv:C	1200dpi2bit edge34	ENG*	[0 to 15 / 15 / 1/step]
4-203-001	LoCPP edge lv:M	600dpi 2bit edge1	ENG*	[0 to 15 / 15 / 1/step]
4-203-002	LoCPP edge lv:M	600dpi 2bit edge2	ENG*	[0 to 15 / 15 / 1/step]
4-203-003	LoCPP edge lv:M	600dpi 4bit edge1	ENG*	[0 to 15 / 15 / 1/step]
4-203-004	LoCPP edge lv:M	600dpi 4bit edge2	ENG*	[0 to 15 / 15 / 1/step]
4-203-005	LoCPP edge lv:M	600dpi 1bit edge1	ENG*	[0 to 15 / 15 / 1/step]
4-203-006	LoCPP edge lv:M	600dpi 1bit edge2	ENG*	[0 to 15 / 15 / 1/step]
4-203-011	LoCPP edge lv:M	1200dpi 1bit edge12	ENG*	[0 to 15 / 15 / 1/step]
4-203-012	LoCPP edge lv:M	1200dpi 1bit edge34	ENG*	[0 to 15 / 15 / 1/step]
4-203-013	LoCPP edge lv:M	1200dpi 2bit edge12	ENG*	[0 to 15 / 15 / 1/step]
4-203-014	LoCPP edge lv:M	1200dpi 2bit edge34	ENG*	[0 to 15 / 15 / 1/step]
4-204-001	LoCPP edge lv:Y	600dpi 2bit edge1	ENG*	[0 to 15 / 15 / 1/step]
4-204-002	LoCPP edge lv:Y	600dpi 2bit edge2	ENG*	[0 to 15 / 15 / 1/step]
4-204-003	LoCPP edge lv:Y	600dpi 4bit edge1	ENG*	[0 to 15 / 15 / 1/step]

3.SP Mode Tables

SP No.	Large Category	Small Category	ENG or CTL	[Min to Max/Init./Step]
4-204-004	LoCPP edge lv:Y	600dpi 4bit edge2	ENG*	[0 to 15 / 15 / 1/step]
4-204-005	LoCPP edge lv:Y	600dpi 1bit edge1	ENG*	[0 to 15 / 15 / 1/step]
4-204-006	LoCPP edge lv:Y	600dpi 1bit edge2	ENG*	[0 to 15 / 15 / 1/step]
4-204-011	LoCPP edge lv:Y	1200dpi 1bit edge12	ENG*	[0 to 15 / 15 / 1/step]
4-204-012	LoCPP edge lv:Y	1200dpi 1bit edge34	ENG*	[0 to 15 / 15 / 1/step]
4-204-013	LoCPP edge lv:Y	1200dpi 2bit edge12	ENG*	[0 to 15 / 15 / 1/step]
4-204-014	LoCPP edge lv:Y	1200dpi 2bit edge34	ENG*	[0 to 15 / 15 / 1/step]
4-301-001	Operation Check APS Sensor		ENG	[0 to 255 / 0 / 1/step]
4-303-001	Min Size for APS		ENG*	[0 to 1 / 0 / 1/step]
4-305-001	8K/16K Detection		ENG*	[0 to 3 / 0 / 1/step]
4-308-001	Scan Size Detection	Detection ON/OFF	ENG*	[0 to 2 / 1 / 1/step]
4-311-001	Detection:Start Position	Detection:Start Position	ENG*	[0 to 2 / 0 / 1/step]
4-312-001	Scan Size Detect:Setting	Original Density Thresh:S1	ENG*	[0 to 255 / 7 / 1digit/step]
4-312-002	Scan Size Detect:Setting	Original Density Thresh:S2	ENG*	[0 to 255 / 7 / 1digit/step]
4-312-003	Scan Size Detect:Setting	Original Density Thresh:S3	ENG*	[0 to 255 / 7 / 1digit/step]
4-312-004	Scan Size Detect:Setting	Detection Time	ENG*	[10 to 20 / 10 / 10msec/step]
4-312-005	Scan Size Detect:Setting	Detection:Delay Time	ENG*	[0 to 200 / 0 / 10msec/step]
4-312-006	Scan Size Detect:Setting	LED PWM Duty	ENG*	[0 to 100 / 22 / 1/step]

3.SP Mode Tables

SP No.	Large Category	Small Category	ENG or CTL	[Min to Max/Init./Step]
4-313-001	Scan Size Detect Value	S1:R:LEDOFF	ENG	[0 to 255 / 0 / 1digit/step]
4-313-002	Scan Size Detect Value	S1:G:LEDOFF	ENG	[0 to 255 / 0 / 1digit/step]
4-313-003	Scan Size Detect Value	S1:B:LEDOFF	ENG	[0 to 255 / 0 / 1digit/step]
4-313-004	Scan Size Detect Value	S2:R:LEDOFF	ENG	[0 to 255 / 0 / 1digit/step]
4-313-005	Scan Size Detect Value	S2:G:LEDOFF	ENG	[0 to 255 / 0 / 1digit/step]
4-313-006	Scan Size Detect Value	S2:B:LEDOFF	ENG	[0 to 255 / 0 / 1digit/step]
4-313-007	Scan Size Detect Value	S3:R:LEDOFF	ENG	[0 to 255 / 0 / 1digit/step]
4-313-008	Scan Size Detect Value	S3:G:LEDOFF	ENG	[0 to 255 / 0 / 1digit/step]
4-313-009	Scan Size Detect Value	S3:B:LEDOFF	ENG	[0 to 255 / 0 / 1digit/step]
4-313-010	Scan Size Detect Value	S1:R:LEDON:AREA1	ENG	[0 to 255 / 0 / 1digit/step]
4-313-011	Scan Size Detect Value	S1:G:LEDON:AREA1	ENG	[0 to 255 / 0 / 1digit/step]
4-313-012	Scan Size Detect Value	S1:B:LEDON:AREA1	ENG	[0 to 255 / 0 / 1digit/step]
4-313-013	Scan Size Detect Value	S2:R:LEDON:AREA1	ENG	[0 to 255 / 0 / 1digit/step]
4-313-014	Scan Size Detect Value	S2:G:LEDON:AREA1	ENG	[0 to 255 / 0 / 1digit/step]
4-313-015	Scan Size Detect Value	S2:B:LEDON:AREA1	ENG	[0 to 255 / 0 / 1digit/step]
4-313-016	Scan Size Detect Value	S3:R:LEDON:AREA1	ENG	[0 to 255 / 0 / 1digit/step]
4-313-017	Scan Size Detect Value	S3:G:LEDON:AREA1	ENG	[0 to 255 / 0 / 1digit/step]
4-313-018	Scan Size Detect Value	S3:B:LEDON:AREA1	ENG	[0 to 255 / 0 / 1digit/step]

3.SP Mode Tables

SP No.	Large Category	Small Category	ENG or CTL	[Min to Max/Init./Step]
4-313-019	Scan Size Detect Value	S1:R:LEDON:AREA2	ENG	[0 to 255 / 0 / 1digit/step]
4-313-020	Scan Size Detect Value	S1:G:LEDON:AREA2	ENG	[0 to 255 / 0 / 1digit/step]
4-313-021	Scan Size Detect Value	S1:B:LEDON:AREA2	ENG	[0 to 255 / 0 / 1digit/step]
4-313-022	Scan Size Detect Value	S2:R:LEDON:AREA2	ENG	[0 to 255 / 0 / 1digit/step]
4-313-023	Scan Size Detect Value	S2:G:LEDON:AREA2	ENG	[0 to 255 / 0 / 1digit/step]
4-313-024	Scan Size Detect Value	S2:B:LEDON:AREA2	ENG	[0 to 255 / 0 / 1digit/step]
4-313-025	Scan Size Detect Value	S3:R:LEDON:AREA2	ENG	[0 to 255 / 0 / 1digit/step]
4-313-026	Scan Size Detect Value	S3:G:LEDON:AREA2	ENG	[0 to 255 / 0 / 1digit/step]
4-313-027	Scan Size Detect Value	S3:B:LEDON:AREA2	ENG	[0 to 255 / 0 / 1digit/step]
4-313-028	Scan Size Detect Value	S1:R:LEDON:AREA3	ENG	[0 to 255 / 0 / 1digit/step]
4-313-029	Scan Size Detect Value	S1:G:LEDON:AREA3	ENG	[0 to 255 / 0 / 1digit/step]
4-313-030	Scan Size Detect Value	S1:B:LEDON:AREA3	ENG	[0 to 255 / 0 / 1digit/step]
4-313-031	Scan Size Detect Value	S2:R:LEDON:AREA3	ENG	[0 to 255 / 0 / 1digit/step]
4-313-032	Scan Size Detect Value	S2:G:LEDON:AREA3	ENG	[0 to 255 / 0 / 1digit/step]
4-313-033	Scan Size Detect Value	S2:B:LEDON:AREA3	ENG	[0 to 255 / 0 / 1digit/step]
4-313-034	Scan Size Detect Value	S3:R:LEDON:AREA3	ENG	[0 to 255 / 0 / 1digit/step]
4-313-035	Scan Size Detect Value	S3:G:LEDON:AREA3	ENG	[0 to 255 / 0 / 1digit/step]
4-313-036	Scan Size Detect Value	S3:B:LEDON:AREA3	ENG	[0 to 255 / 0 / 1digit/step]

3.SP Mode Tables

SP No.	Large Category	Small Category	ENG or CTL	[Min to Max/Init./Step]
4-400-001	Org Edge Mask	Book:Sub:LEdge(Left)	ENG	[0.0 to 3.0 / 0.0 / 0.1mm/step]
4-400-002	Org Edge Mask	Book:Sub:TEdge(Right)	ENG	[0.0 to 3.0 / 0.0 / 0.1mm/step]
4-400-003	Org Edge Mask	Book:Main:LEdge(Rear)	ENG	[0.0 to 3.0 / 0.0 / 0.1mm/step]
4-400-004	Org Edge Mask	Book:Main:Tedge(Front)	ENG	[0.0 to 3.0 / 0.0 / 0.1mm/step]
4-400-005	Org Edge Mask	ADF: Leading Edge	ENG*	[0.0 to 3.0 / 0.0 / 0.1mm/step]
4-400-007	Org Edge Mask	ADF: Right	ENG*	[0.0 to 3.0 / 0.0 / 0.1mm/step]
4-400-008	Org Edge Mask	ADF: left	ENG*	[0.0 to 3.0 / 0.0 / 0.1mm/step]
4-417-001	IPU Test Pattern	Test Pattern	ENG	[0 to 9 / 0 / 1/step]
4-429-001	Select Copy Data Security	Copying	ENG	[0 to 3 / 3 / 1/step]
4-429-002	Select Copy Data Security	Scanning	ENG	[0 to 3 / 3 / 1/step]
4-429-003	Select Copy Data Security	Fax Operation	ENG	[0 to 3 / 3 / 1/step]
4-460-001	Digital AE	Low Limit Value	ENG	[0 to 1023 / 364 / 1/step]
4-460-002	Digital AE	Background level	ENG*	[512 to 1535 / 932 / 1/step]
4-501-001	ACC Target Den	Copy:K:Text	ENG*	[0 to 10 / 0 / 1/step]
4-501-002	ACC Target Den	Copy:C:Text	ENG*	[0 to 10 / 0 / 1/step]
4-501-003	ACC Target Den	Copy:M:Text	ENG*	[0 to 10 / 0 / 1/step]
4-501-004	ACC Target Den	Copy:Y:Text	ENG*	[0 to 10 / 0 / 1/step]
4-501-005	ACC Target Den	Copy:K:Photo	ENG*	[0 to 10 / 0 / 1/step]

3.SP Mode Tables

SP No.	Large Category	Small Category	ENG or CTL	[Min to Max/Init./Step]
4-501-006	ACC Target Den	Copy:C:Photo	ENG*	[0 to 10 / 0 / 1/step]
4-501-007	ACC Target Den	Copy:M:Photo	ENG*	[0 to 10 / 0 / 1/step]
4-501-008	ACC Target Den	Copy:Y:Photo	ENG*	[0 to 10 / 0 / 1/step]
4-505-001	ACC Cor:Bright	Master:K	ENG*	[-128 to 127 / 0 / 1/step]
4-505-002	ACC Cor:Bright	Master:C	ENG*	[-128 to 127 / 0 / 1/step]
4-505-003	ACC Cor:Bright	Master:M	ENG*	[-128 to 127 / 0 / 1/step]
4-505-004	ACC Cor:Bright	Master:Y	ENG*	[-128 to 127 / 0 / 1/step]
4-505-005	ACC Cor:Bright	Slave:K	ENG*	[-128 to 127 / 0 / 1/step]
4-505-006	ACC Cor:Bright	Slave:C	ENG*	[-128 to 127 / 0 / 1/step]
4-505-007	ACC Cor:Bright	Slave:M	ENG*	[-128 to 127 / 0 / 1/step]
4-505-008	ACC Cor:Bright	Slave:Y	ENG*	[-128 to 127 / 0 / 1/step]
4-506-001	ACC Cor:Dark	Master:K	ENG*	[-128 to 127 / 0 / 1/step]
4-506-002	ACC Cor:Dark	Master:C	ENG*	[-128 to 127 / 0 / 1/step]
4-506-003	ACC Cor:Dark	Master:M	ENG*	[-128 to 127 / 0 / 1/step]
4-506-004	ACC Cor:Dark	Master:Y	ENG*	[-128 to 127 / 0 / 1/step]
4-506-005	ACC Cor:Dark	Slave:K	ENG*	[-128 to 127 / 0 / 1/step]
4-506-006	ACC Cor:Dark	Slave:C	ENG*	[-128 to 127 / 0 / 1/step]
4-506-007	ACC Cor:Dark	Slave:M	ENG*	[-128 to 127 / 0 / 1/step]

3.SP Mode Tables

SP No.	Large Category	Small Category	ENG or CTL	[Min to Max/Init./Step]
4-506-008	ACC Cor:Dark	Slave:Y	ENG*	[-128 to 127 / 0 / 1/step]
4-520-001	IBACC:DetectedValue	Latest:K_P1	ENG*	[0 to 1023 / 0 / 1/step]
4-520-002	IBACC:DetectedValue	Latest:K_P2	ENG*	[0 to 1023 / 0 / 1/step]
4-520-003	IBACC:DetectedValue	Latest:K_P3	ENG*	[0 to 1023 / 0 / 1/step]
4-520-004	IBACC:DetectedValue	Latest:K_P4	ENG*	[0 to 1023 / 0 / 1/step]
4-520-005	IBACC:DetectedValue	Latest:K_P5	ENG*	[0 to 1023 / 0 / 1/step]
4-520-006	IBACC:DetectedValue	Latest:K_P6	ENG*	[0 to 1023 / 0 / 1/step]
4-520-007	IBACC:DetectedValue	Latest:K_P6	ENG*	[0 to 1023 / 0 / 1/step]
4-520-008	IBACC:DetectedValue	Latest:K_P6	ENG*	[0 to 1023 / 0 / 1/step]
4-520-021	IBACC:DetectedValue	Latest:C_P1	ENG*	[0 to 1023 / 0 / 1/step]
4-520-022	IBACC:DetectedValue	Latest:C_P2	ENG*	[0 to 1023 / 0 / 1/step]
4-520-023	IBACC:DetectedValue	Latest:C_P3	ENG*	[0 to 1023 / 0 / 1/step]
4-520-024	IBACC:DetectedValue	Latest:C_P4	ENG*	[0 to 1023 / 0 / 1/step]
4-520-025	IBACC:DetectedValue	Latest:C_P5	ENG*	[0 to 1023 / 0 / 1/step]
4-520-026	IBACC:DetectedValue	Latest:C_P6	ENG*	[0 to 1023 / 0 / 1/step]
4-520-027	IBACC:DetectedValue	Latest:C_P6	ENG*	[0 to 1023 / 0 / 1/step]
4-520-028	IBACC:DetectedValue	Latest:C_P6	ENG*	[0 to 1023 / 0 / 1/step]
4-520-041	IBACC:DetectedValue	Latest:M_P1	ENG*	[0 to 1023 / 0 / 1/step]

3.SP Mode Tables

SP No.	Large Category	Small Category	ENG or CTL	[Min to Max/Init./Step]
4-520-042	IBACC:DetectedValue	Latest:M_P2	ENG*	[0 to 1023 / 0 / 1/step]
4-520-043	IBACC:DetectedValue	Latest:M_P3	ENG*	[0 to 1023 / 0 / 1/step]
4-520-044	IBACC:DetectedValue	Latest:M_P4	ENG*	[0 to 1023 / 0 / 1/step]
4-520-045	IBACC:DetectedValue	Latest:M_P5	ENG*	[0 to 1023 / 0 / 1/step]
4-520-046	IBACC:DetectedValue	Latest:M_P6	ENG*	[0 to 1023 / 0 / 1/step]
4-520-047	IBACC:DetectedValue	Latest:M_P6	ENG*	[0 to 1023 / 0 / 1/step]
4-520-048	IBACC:DetectedValue	Latest:M_P6	ENG*	[0 to 1023 / 0 / 1/step]
4-520-061	IBACC:DetectedValue	Latest:Y_P1	ENG*	[0 to 1023 / 0 / 1/step]
4-520-062	IBACC:DetectedValue	Latest:Y_P2	ENG*	[0 to 1023 / 0 / 1/step]
4-520-063	IBACC:DetectedValue	Latest:Y_P3	ENG*	[0 to 1023 / 0 / 1/step]
4-520-064	IBACC:DetectedValue	Latest:Y_P4	ENG*	[0 to 1023 / 0 / 1/step]
4-520-065	IBACC:DetectedValue	Latest:Y_P5	ENG*	[0 to 1023 / 0 / 1/step]
4-520-066	IBACC:DetectedValue	Latest:Y_P6	ENG*	[0 to 1023 / 0 / 1/step]
4-520-067	IBACC:DetectedValue	Latest:Y_P6	ENG*	[0 to 1023 / 0 / 1/step]
4-520-068	IBACC:DetectedValue	Latest:Y_P6	ENG*	[0 to 1023 / 0 / 1/step]
4-520-101	IBACC:DetectedValue	Reference:K_P1	ENG*	[0 to 1023 / 0 / 1/step]
4-520-102	IBACC:DetectedValue	Reference:K_P2	ENG*	[0 to 1023 / 0 / 1/step]
4-520-103	IBACC:DetectedValue	Reference:K_P3	ENG*	[0 to 1023 / 0 / 1/step]

3.SP Mode Tables

SP No.	Large Category	Small Category	ENG or CTL	[Min to Max/Init./Step]
4-520-104	IBACC:DetectedValue	Reference:K_P4	ENG*	[0 to 1023 / 0 / 1/step]
4-520-105	IBACC:DetectedValue	Reference:K_P5	ENG*	[0 to 1023 / 0 / 1/step]
4-520-106	IBACC:DetectedValue	Reference:K_P6	ENG*	[0 to 1023 / 0 / 1/step]
4-520-107	IBACC:DetectedValue	Reference:K_P6	ENG*	[0 to 1023 / 0 / 1/step]
4-520-108	IBACC:DetectedValue	Reference:K_P6	ENG*	[0 to 1023 / 0 / 1/step]
4-520-121	IBACC:DetectedValue	Reference:C_P1	ENG*	[0 to 1023 / 0 / 1/step]
4-520-122	IBACC:DetectedValue	Reference:C_P2	ENG*	[0 to 1023 / 0 / 1/step]
4-520-123	IBACC:DetectedValue	Reference:C_P3	ENG*	[0 to 1023 / 0 / 1/step]
4-520-124	IBACC:DetectedValue	Reference:C_P4	ENG*	[0 to 1023 / 0 / 1/step]
4-520-125	IBACC:DetectedValue	Reference:C_P5	ENG*	[0 to 1023 / 0 / 1/step]
4-520-126	IBACC:DetectedValue	Reference:C_P6	ENG*	[0 to 1023 / 0 / 1/step]
4-520-127	IBACC:DetectedValue	Reference:C_P6	ENG*	[0 to 1023 / 0 / 1/step]
4-520-128	IBACC:DetectedValue	Reference:C_P6	ENG*	[0 to 1023 / 0 / 1/step]
4-520-141	IBACC:DetectedValue	Reference:M_P1	ENG*	[0 to 1023 / 0 / 1/step]
4-520-142	IBACC:DetectedValue	Reference:M_P2	ENG*	[0 to 1023 / 0 / 1/step]
4-520-143	IBACC:DetectedValue	Reference:M_P3	ENG*	[0 to 1023 / 0 / 1/step]
4-520-144	IBACC:DetectedValue	Reference:M_P4	ENG*	[0 to 1023 / 0 / 1/step]
4-520-145	IBACC:DetectedValue	Reference:M_P5	ENG*	[0 to 1023 / 0 / 1/step]

3.SP Mode Tables

SP No.	Large Category	Small Category	ENG or CTL	[Min to Max/Init./Step]
4-520-146	IBACC:DetectedValue	Reference:M_P6	ENG*	[0 to 1023 / 0 / 1/step]
4-520-147	IBACC:DetectedValue	Reference:M_P6	ENG*	[0 to 1023 / 0 / 1/step]
4-520-148	IBACC:DetectedValue	Reference:M_P6	ENG*	[0 to 1023 / 0 / 1/step]
4-520-161	IBACC:DetectedValue	Reference:Y_P1	ENG*	[0 to 1023 / 0 / 1/step]
4-520-162	IBACC:DetectedValue	Reference:Y_P2	ENG*	[0 to 1023 / 0 / 1/step]
4-520-163	IBACC:DetectedValue	Reference:Y_P3	ENG*	[0 to 1023 / 0 / 1/step]
4-520-164	IBACC:DetectedValue	Reference:Y_P4	ENG*	[0 to 1023 / 0 / 1/step]
4-520-165	IBACC:DetectedValue	Reference:Y_P5	ENG*	[0 to 1023 / 0 / 1/step]
4-520-166	IBACC:DetectedValue	Reference:Y_P6	ENG*	[0 to 1023 / 0 / 1/step]
4-520-167	IBACC:DetectedValue	Reference:Y_P6	ENG*	[0 to 1023 / 0 / 1/step]
4-520-168	IBACC:DetectedValue	Reference:Y_P6	ENG*	[0 to 1023 / 0 / 1/step]
4-540-001	Print Coverage	RY Phase: Option	ENG	[0 to 255 / 0 / 1/step]
4-540-002	Print Coverage	RY Phase: R	ENG	[-256 to 255 / 0 / 1/step]
4-540-003	Print Coverage	RY Phase: G	ENG	[-256 to 255 / 0 / 1/step]
4-540-004	Print Coverage	RY Phase: B	ENG	[-256 to 255 / 0 / 1/step]
4-540-005	Print Coverage	YR Phase: Option	ENG	[0 to 255 / 0 / 1/step]
4-540-006	Print Coverage	YR Phase: R	ENG	[-256 to 255 / 0 / 1/step]
4-540-007	Print Coverage	YR Phase: G	ENG	[-256 to 255 / 0 / 1/step]

3.SP Mode Tables

SP No.	Large Category	Small Category	ENG or CTL	[Min to Max/Init./Step]
4-540-008	Print Coverage	YR Phase: B	ENG	[-256 to 255 / 0 / 1/step]
4-540-009	Print Coverage	YG Phase: Option	ENG	[0 to 255 / 0 / 1/step]
4-540-010	Print Coverage	YG Phase: R	ENG	[-256 to 255 / 0 / 1/step]
4-540-011	Print Coverage	YG Phase: G	ENG	[-256 to 255 / 0 / 1/step]
4-540-012	Print Coverage	YG Phase: B	ENG	[-256 to 255 / 0 / 1/step]
4-540-013	Print Coverage	GY Phase: Option	ENG	[0 to 255 / 0 / 1/step]
4-540-014	Print Coverage	GY Phase: R	ENG	[-256 to 255 / 0 / 1/step]
4-540-015	Print Coverage	GY Phase: G	ENG	[-256 to 255 / 0 / 1/step]
4-540-016	Print Coverage	GY Phase: B	ENG	[-256 to 255 / 0 / 1/step]
4-540-017	Print Coverage	GC Phase: Option	ENG	[0 to 255 / 0 / 1/step]
4-540-018	Print Coverage	GC Phase: R	ENG	[-256 to 255 / 0 / 1/step]
4-540-019	Print Coverage	GC Phase: G	ENG	[-256 to 255 / 0 / 1/step]
4-540-020	Print Coverage	GC Phase: B	ENG	[-256 to 255 / 0 / 1/step]
4-540-021	Print Coverage	CG Phase: Option	ENG	[0 to 255 / 0 / 1/step]
4-540-022	Print Coverage	CG Phase: R	ENG	[-256 to 255 / 0 / 1/step]
4-540-023	Print Coverage	CG Phase: G	ENG	[-256 to 255 / 0 / 1/step]
4-540-024	Print Coverage	CG Phase: B	ENG	[-256 to 255 / 0 / 1/step]
4-540-025	Print Coverage	CB Phase: Option	ENG	[0 to 255 / 0 / 1/step]

3.SP Mode Tables

SP No.	Large Category	Small Category	ENG or CTL	[Min to Max/Init./Step]
4-540-026	Print Coverage	CB Phase: R	ENG	[-256 to 255 / 0 / 1/step]
4-540-027	Print Coverage	CB Phase: G	ENG	[-256 to 255 / 0 / 1/step]
4-540-028	Print Coverage	CB Phase: B	ENG	[-256 to 255 / 0 / 1/step]
4-540-029	Print Coverage	BC Phase: Option	ENG	[0 to 255 / 0 / 1/step]
4-540-030	Print Coverage	BC Phase: R	ENG	[-256 to 255 / 0 / 1/step]
4-540-031	Print Coverage	BC Phase: G	ENG	[-256 to 255 / 0 / 1/step]
4-540-032	Print Coverage	BC Phase: B	ENG	[-256 to 255 / 0 / 1/step]
4-540-033	Print Coverage	BM Phase: Option	ENG	[0 to 255 / 0 / 1/step]
4-540-034	Print Coverage	BM Phase: R	ENG	[-256 to 255 / 0 / 1/step]
4-540-035	Print Coverage	BM Phase: G	ENG	[-256 to 255 / 0 / 1/step]
4-540-036	Print Coverage	BM Phase: B	ENG	[-256 to 255 / 0 / 1/step]
4-540-037	Print Coverage	MB Phase: Option	ENG	[0 to 255 / 0 / 1/step]
4-540-038	Print Coverage	MB Phase: R	ENG	[-256 to 255 / 0 / 1/step]
4-540-039	Print Coverage	MB Phase: G	ENG	[-256 to 255 / 0 / 1/step]
4-540-040	Print Coverage	MB Phase: B	ENG	[-256 to 255 / 0 / 1/step]
4-540-041	Print Coverage	MR Phase: Option	ENG	[0 to 255 / 0 / 1/step]
4-540-042	Print Coverage	MR Phase: R	ENG	[-256 to 255 / 0 / 1/step]
4-540-043	Print Coverage	MR Phase: G	ENG	[-256 to 255 / 0 / 1/step]

3.SP Mode Tables

SP No.	Large Category	Small Category	ENG or CTL	[Min to Max/Init./Step]
4-540-044	Print Coverage	MR Phase: B	ENG	[-256 to 255 / 0 / 1/step]
4-540-045	Print Coverage	RM Phase: Option	ENG	[0 to 255 / 0 / 1/step]
4-540-046	Print Coverage	RM Phase: R	ENG	[-256 to 255 / 0 / 1/step]
4-540-047	Print Coverage	RM Phase: G	ENG	[-256 to 255 / 0 / 1/step]
4-540-048	Print Coverage	RM Phase: B	ENG	[-256 to 255 / 0 / 1/step]
4-540-049	Print Coverage	WHITE: Option	ENG	[0 to 255 / 0 / 1/step]
4-540-050	Print Coverage	WHITE:R	ENG	[-256 to 255 / 0 / 1/step]
4-540-051	Print Coverage	WHITE:G	ENG	[-256 to 255 / 0 / 1/step]
4-540-052	Print Coverage	WHITE:B	ENG	[-256 to 255 / 0 / 1/step]
4-540-053	Print Coverage	BLACK: Option	ENG	[0 to 255 / 0 / 1/step]
4-540-054	Print Coverage	BLACK:R	ENG	[-256 to 255 / 0 / 1/step]
4-540-055	Print Coverage	BLACK:G	ENG	[-256 to 255 / 0 / 1/step]
4-540-056	Print Coverage	BLACK:B	ENG	[-256 to 255 / 0 / 1/step]
4-541-001	Photo Correction	Copied Photo	ENG*	[0 to 1 / 0 / 1/step]
4-550-005	Scan Apli:Txt/Print	MTF: 0(Off) 1-15 (Weak-Strong)	ENG	[0 to 15 / 8 / 1/step]
4-550-006	Scan Apli:Txt/Print	Smoothing: 0(x1) 1-7 (Weak-Strong)	ENG	[0 to 7 / 4 / 1/step]
4-550-007	Scan Apli:Txt/Print	Brightness: 1-255	ENG	[1 to 255 / 128 / 1/step]
4-550-008	Scan Apli:Txt/Print	Contrast: 1-255	ENG	[1 to 255 / 128 / 1/step]

3.SP Mode Tables

SP No.	Large Category	Small Category	ENG or CTL	[Min to Max/Init./Step]
4-550-009	Scan Apli:Txt/Print	Ind Dot Erase: 0(Off) 1-7 (Weak-Strong)	ENG	[0 to 7 / 0 / 1/step]
4-551-005	Scan Apli:Txt	MTF: 0(Off) 1-15 (Weak-Strong)	ENG	[0 to 15 / 8 / 1/step]
4-551-006	Scan Apli:Txt	Smoothing: 0(x1) 1-7 (Weak-Strong)	ENG	[0 to 7 / 4 / 1/step]
4-551-007	Scan Apli:Txt	Brightness: 1-255	ENG	[1 to 255 / 128 / 1/step]
4-551-008	Scan Apli:Txt	Contrast: 1-255	ENG	[1 to 255 / 128 / 1/step]
4-551-009	Scan Apli:Txt	Ind Dot Erase: 0(Off) 1-7 (Weak-Strong)	ENG	[0 to 7 / 0 / 1/step]
4-552-005	Scan Apli:Txt Dropout	MTF: 0(Off) 1-15 (Weak-Strong)	ENG	[0 to 15 / 8 / 1/step]
4-552-006	Scan Apli:Txt Dropout	Smoothing: 0(x1) 1-7 (Weak-Strong)	ENG	[0 to 7 / 4 / 1/step]
4-552-007	Scan Apli:Txt Dropout	Brightness: 1-255	ENG	[1 to 255 / 128 / 1/step]
4-552-008	Scan Apli:Txt Dropout	Contrast: 1-255	ENG	[1 to 255 / 128 / 1/step]
4-552-009	Scan Apli:Txt Dropout	Ind Dot Erase: 0(Off) 1-7 (Weak-Strong)	ENG	[0 to 7 / 0 / 1/step]
4-553-005	Scan Apli:Txt/Photo	MTF: 0(Off) 1-15 (Weak-Strong)	ENG	[0 to 15 / 8 / 1/step]
4-553-006	Scan Apli:Txt/Photo	Smoothing: 0(x1) 1-7 (Weak-Strong)	ENG	[0 to 7 / 4 / 1/step]
4-553-007	Scan Apli:Txt/Photo	Brightness: 1-255	ENG	[1 to 255 / 128 / 1/step]
4-553-008	Scan Apli:Txt/Photo	Contrast: 1-255	ENG	[1 to 255 / 128 / 1/step]
4-553-009	Scan Apli:Txt/Photo	Ind Dot Erase: 0(Off) 1-7 (Weak-Strong)	ENG	[0 to 7 / 0 / 1/step]
4-554-005	Scan Apli:Photo	MTF: 0(Off) 1-15 (Weak-Strong)	ENG	[0 to 15 / 8 / 1/step]
4-554-006	Scan Apli:Photo	Smoothing: 0(x1) 1-7 (Weak-Strong)	ENG	[0 to 7 / 4 / 1/step]

3.SP Mode Tables

SP No.	Large Category	Small Category	ENG or CTL	[Min to Max/Init./Step]
4-554-007	Scan Apli:Photo	Brightness: 1-255	ENG	[1 to 255 / 128 / 1/step]
4-554-008	Scan Apli:Photo	Contrast: 1-255	ENG	[1 to 255 / 128 / 1/step]
4-554-009	Scan Apli:Photo	Ind Dot Erase: 0(Off) 1-7 (Weak-Strong)	ENG	[0 to 7 / 0 / 1/step]
4-565-005	Scan Apli:GrayScale	MTF: 0(Off) 1-15 (Weak-Strong)	ENG	[0 to 15 / 8 / 1/step]
4-565-006	Scan Apli:GrayScale	Smoothing: 0(x1) 1-7 (Weak-Strong)	ENG	[0 to 7 / 4 / 1/step]
4-565-007	Scan Apli:GrayScale	Brightness: 1-255	ENG	[1 to 255 / 128 / 1/step]
4-565-008	Scan Apli:GrayScale	Contrast: 1-255	ENG	[1 to 255 / 128 / 1/step]
4-565-009	Scan Apli:GrayScale	Ind Dot Erase: 0(Off) 1-7 (Weak-Strong)	ENG	[0 to 7 / 0 / 1/step]
4-570-005	Scan Apli:Col Txt/Photo	MTF: 0(Off) 1-15 (Weak-Strong)	ENG	[0 to 15 / 8 / 1/step]
4-570-006	Scan Apli:Col Txt/Photo	Smoothing: 0(x1) 1-7 (Weak-Strong)	ENG	[0 to 7 / 4 / 1/step]
4-570-007	Scan Apli:Col Txt/Photo	Brightness: 1-255	ENG	[1 to 255 / 128 / 1/step]
4-570-008	Scan Apli:Col Txt/Photo	Contrast: 1-255	ENG	[1 to 255 / 128 / 1/step]
4-570-009	Scan Apli:Col Txt/Photo	Ind Dot Erase: 0(Off) 1-7 (Weak-Strong)	ENG	[0 to 7 / 0 / 1/step]
4-571-005	Scan Apli:Col Gloss Photo	MTF: 0(Off) 1-15 (Weak-Strong)	ENG	[0 to 15 / 8 / 1/step]
4-571-006	Scan Apli:Col Gloss Photo	Smoothing: 0(x1) 1-7 (Weak-Strong)	ENG	[0 to 7 / 4 / 1/step]
4-571-007	Scan Apli:Col Gloss Photo	Brightness: 1-255	ENG	[1 to 255 / 128 / 1/step]
4-571-008	Scan Apli:Col Gloss Photo	Contrast: 1-255	ENG	[1 to 255 / 128 / 1/step]
4-571-009	Scan Apli:Col Gloss Photo	Ind Dot Erase: 0(Off) 1-7 (Weak-Strong)	ENG	[0 to 7 / 0 / 1/step]

3.SP Mode Tables

SP No.	Large Category	Small Category	ENG or CTL	[Min to Max/Init./Step]
4-572-005	Scan Apli:AutoCol	MTF: 0(Off) 1-15 (Weak-Strong)	ENG	[0 to 15 / 8 / 1/step]
4-572-006	Scan Apli:AutoCol	Smoothing: 0(x1) 1-7 (Weak-Strong)	ENG	[0 to 7 / 4 / 1/step]
4-572-007	Scan Apli:AutoCol	Brightness: 1-255	ENG	[1 to 255 / 128 / 1/step]
4-572-008	Scan Apli:AutoCol	Contrast: 1-255	ENG	[1 to 255 / 128 / 1/step]
4-572-009	Scan Apli:AutoCol	Ind Dot Erase: 0(Off) 1-7 (Weak-Strong)	ENG	[0 to 7 / 0 / 1/step]
4-573-005	Scan Apli:Shiny Materials	MTF: 0(Off) 1-15 (Weak-Strong)	ENG	[0 to 15 / 8 / 1/step]
4-573-006	Scan Apli:Shiny Materials	Smoothing: 0(x1) 1-7 (Weak-Strong)	ENG	[0 to 7 / 4 / 1/step]
4-573-007	Scan Apli:Shiny Materials	Brightness: 1-255	ENG	[1 to 255 / 128 / 1/step]
4-573-008	Scan Apli:Shiny Materials	Contrast: 1-255	ENG	[1 to 255 / 128 / 1/step]
4-573-009	Scan Apli:Shiny Materials	Ind Dot Erase: 0(Off) 1-7 (Weak-Strong)	ENG	[0 to 7 / 0 / 1/step]
4-580-005	Fax Apli:Txt/Chart	MTF: 0(Off) 1-15 (Weak-Strong)	ENG	[0 to 15 / 8 / 1/step]
4-580-006	Fax Apli:Txt/Chart	Smoothing: 0(x1) 1-7 (Weak-Strong)	ENG	[0 to 7 / 4 / 1/step]
4-580-007	Fax Apli:Txt/Chart	Brightness: 1-255	ENG	[1 to 255 / 128 / 1/step]
4-580-008	Fax Apli:Txt/Chart	Contrast: 1-255	ENG	[1 to 255 / 128 / 1/step]
4-580-009	Fax Apli:Txt/Chart	Ind Dot Erase: 0(Off) 1-7 (Weak-Strong)	ENG	[0 to 7 / 0 / 1/step]
4-580-010	Fax Apli:Txt/Chart	Texture Erase: 0	ENG	[0 to 2 / 0 / 1/step]
4-581-005	Fax Apli:Txt	MTF: 0(Off) 1-15 (Weak-Strong)	ENG	[0 to 15 / 8 / 1/step]
4-581-006	Fax Apli:Txt	Smoothing: 0(x1) 1-7 (Weak-Strong)	ENG	[0 to 7 / 4 / 1/step]

3.SP Mode Tables

SP No.	Large Category	Small Category	ENG or CTL	[Min to Max/Init./Step]
4-581-007	Fax Apli:Txt	Brightness: 1-255	ENG	[1 to 255 / 128 / 1/step]
4-581-008	Fax Apli:Txt	Contrast: 1-255	ENG	[1 to 255 / 128 / 1/step]
4-581-009	Fax Apli:Txt	Ind Dot Erase: 0(Off) 1-7 (Weak-Strong)	ENG	[0 to 7 / 0 / 1/step]
4-582-005	Fax Apli:Txt/Photo	MTF: 0(Off) 1-15 (Weak-Strong)	ENG	[0 to 15 / 8 / 1/step]
4-582-006	Fax Apli:Txt/Photo	Smoothing: 0(x1) 1-7 (Weak-Strong)	ENG	[0 to 7 / 4 / 1/step]
4-582-007	Fax Apli:Txt/Photo	Brightness: 1-255	ENG	[1 to 255 / 128 / 1/step]
4-582-008	Fax Apli:Txt/Photo	Contrast: 1-255	ENG	[1 to 255 / 128 / 1/step]
4-582-009	Fax Apli:Txt/Photo	Ind Dot Erase: 0(Off) 1-7 (Weak-Strong)	ENG	[0 to 7 / 0 / 1/step]
4-582-010	Fax Apli:Txt/Photo	Texture Erase: 0	ENG	[0 to 2 / 0 / 1/step]
4-583-005	Fax Apli:Photo	MTF: 0(Off) 1-15 (Weak-Strong)	ENG	[0 to 15 / 8 / 1/step]
4-583-006	Fax Apli:Photo	Smoothing: 0(x1) 1-7 (Weak-Strong)	ENG	[0 to 7 / 4 / 1/step]
4-583-007	Fax Apli:Photo	Brightness: 1-255	ENG	[1 to 255 / 128 / 1/step]
4-583-008	Fax Apli:Photo	Contrast: 1-255	ENG	[1 to 255 / 128 / 1/step]
4-583-009	Fax Apli:Photo	Ind Dot Erase: 0(Off) 1-7 (Weak-Strong)	ENG	[0 to 7 / 0 / 1/step]
4-583-010	Fax Apli:Photo	Texture Erase: 0	ENG	[0 to 2 / 0 / 1/step]
4-584-005	Fax Apli:Original 1	MTF: 0(Off) 1-15 (Weak-Strong)	ENG	[0 to 15 / 8 / 1/step]
4-584-006	Fax Apli:Original 1	Smoothing: 0(x1) 1-7 (Weak-Strong)	ENG	[0 to 7 / 4 / 1/step]
4-584-007	Fax Apli:Original 1	Brightness: 1-255	ENG	[1 to 255 / 128 / 1/step]

3.SP Mode Tables

SP No.	Large Category	Small Category	ENG or CTL	[Min to Max/Init./Step]
4-584-008	Fax Apli:Original 1	Contrast: 1-255	ENG	[1 to 255 / 128 / 1/step]
4-584-009	Fax Apli:Original 1	Ind Dot Erase: 0(Off) 1-7 (Weak-Strong)	ENG	[0 to 7 / 0 / 1/step]
4-585-005	Fax Apli:Original 2	MTF: 0(Off) 1-15 (Weak-Strong)	ENG	[0 to 15 / 8 / 1/step]
4-585-006	Fax Apli:Original 2	Smoothing: 0(x1) 1-7 (Weak-Strong)	ENG	[0 to 7 / 4 / 1/step]
4-585-007	Fax Apli:Original 2	Brightness: 1-255	ENG	[1 to 255 / 128 / 1/step]
4-585-008	Fax Apli:Original 2	Contrast: 1-255	ENG	[1 to 255 / 128 / 1/step]
4-585-009	Fax Apli:Original 2	Independent Dot Erase (0)/ 1-7 (Strong)	ENG	[0 to 7 / 0 / 1/step]
4-600-001	SBU Version Display	SBU ID	ENG	[0x0000 to 0xFFFF / 0 / 1/step]
4-609-001	Gray Balance Set: R	Book Scan	ENG*	[-384 to 255 / -100 / 1digit/step]
4-609-002	Gray Balance Set: R	DF Scan	ENG*	[-384 to 255 / -100 / 1digit/step]
4-610-001	Gray Balance Set: G	Book Scan	ENG*	[-384 to 255 / -100 / 1digit/step]
4-610-002	Gray Balance Set: G	DF Scan	ENG*	[-384 to 255 / -100 / 1digit/step]
4-611-001	Gray Balance Set: B	Book Scan	ENG*	[-384 to 255 / -100 / 1digit/step]
4-611-002	Gray Balance Set: B	DF Scan	ENG*	[-384 to 255 / -100 / 1digit/step]
4-646-001	Scan Adjust Error	White level	ENG*	[0 to 65535 / 0 / 1/step]
4-646-002	Scan Adjust Error	Black level	ENG*	[0 to 65535 / 0 / 1/step]
4-647-001	Scanner Hard Error	Power-ON	ENG	[0 to 65535 / 0 / 1/step]
4-688-001	DF Density Adjustment	ARDF	ENG*	[80 to 120 / 104 / 1%/step]

3.SP Mode Tables

SP No.	Large Category	Small Category	ENG or CTL	[Min to Max/Init./Step]
4-688-002	Scan Image Density Adjustment	1-pass DF	ENG*	[80 to 120 / 101 / 1%/step]
4-699-001	SBU Test Pattern Change		ENG	[0 to 255 / 0 / 1/step]
4-700-001	CIS ID Display		ENG	[0x00 to 0xFF / 0 / 1/step]
4-712-001	CIS GB Adj. Value: R		ENG*	[0 to 2048 / 1023 / 1digit/step]
4-713-001	CIS GB Adj. Value: G		ENG*	[0 to 2048 / 1023 / 1digit/step]
4-714-001	CIS GB Adj. Value: B		ENG*	[0 to 2048 / 1023 / 1digit/step]
4-730-001	FROM ADF Factory Setting	CIS Parameter	ENG	[0 to 1 / 0 / 0/step]
4-730-002	FROM Main Factory Setting	Execution ON/OFF	ENG	[0 to 1 / 0 / 0/step]
4-730-003	FROM Main Factory Setting	Execution Flag	ENG*	[0 to 1 / 0 / 1/step]
4-730-004	FROM Data Update		ENG	[0 to 1 / 0 / 0/step]
4-745-001	CIS Image Level Error Flag		ENG	[0 to 65535 / 0 / 1/step]
4-746-001	CIS GB Adj Error Flag		ENG	[0 to 7 / 0 / 1/step]
4-747-001	CIS Hard Error Flag		ENG	[0 to 15 / 0 / 1/step]
4-796-001	Low Density Color Correction	Front Side	ENG*	[0 to 3 / 0 / 1/step]
4-796-002	Low Density Color Correction	Rear Side	ENG*	[0 to 3 / 0 / 1/step]
4-797-001	Rear Side: Digital AE	Low Limit Setting	ENG	[0 to 1023 / 364 / 1/step]
4-797-002	Rear Side: Digital AE	Background Erase Level	ENG*	[512 to 1535 / 932 / 1/step]
4-799-001	CIS TEST Pattern	select	ENG	[0 to 5 / 0 / 1/step]

3.SP Mode Tables

SP No.	Large Category	Small Category	ENG or CTL	[Min to Max/Init./Step]
4-799-002	CIS TEST Pattern	Even Output Level Setting	ENG	[0 to 1023 / 0 / 1digit/step]
4-799-003	CIS TEST Pattern	Odd Output Level Setting	ENG	[0 to 1023 / 0 / 1digit/step]
4-803-001	Home Position Adj Value		ENG*	[-2.0 to 2.0 / 0.0 / 0.1mm/step]
4-853-001	Partial LED ON	ON/OFF(Scan)	ENG*	[0 to 1 / 1 / 1/step]
4-853-002	Partial LED ON	ON/OFF(Size Detection)	ENG*	[0 to 1 / 1 / 1/step]
4-871-001	Distortion Correction	Distortion Corr. ON/OFF	ENG	[0 to 1 / 1 / 1/step]
4-871-002	Distortion Corr.	Distortion Initialization	ENG	[0 to 21 / 0 / 1/step]
4-871-003	Distortion Correction	Magnification Adjust(DF)	ENG*	[-0.35 to 0.35 / 0.11 / 0.01%/step]
4-871-004	Distortion Correction	Magnification Adjust(FB)	ENG*	[-0.35 to 0.35 / 0.00 / 0.01%/step]
4-902-001	Disp ACC Data	ditect patch(up)1	ENG	[0 to 255 / 0 / 1/step]
4-902-002	Disp ACC Data	ditect patch(up)2	ENG	[0 to 255 / 0 / 1/step]
4-902-003	Disp ACC Data	ditect patch(up)3	ENG	[0 to 255 / 0 / 1/step]
4-902-004	Disp ACC Data	ditect patch(up)4	ENG	[0 to 255 / 0 / 1/step]
4-902-005	Disp ACC Data	ditect patch(up)5	ENG	[0 to 255 / 0 / 1/step]
4-902-006	Disp ACC Data	ditect patch(up)6	ENG	[0 to 255 / 0 / 1/step]
4-902-007	Disp ACC Data	ditect patch(up)7	ENG	[0 to 255 / 0 / 1/step]
4-902-008	Disp ACC Data	ditect patch(up)8	ENG	[0 to 255 / 0 / 1/step]
4-902-009	Disp ACC Data	ditect patch(up)9	ENG	[0 to 255 / 0 / 1/step]

3.SP Mode Tables

SP No.	Large Category	Small Category	ENG or CTL	[Min to Max/Init./Step]
4-902-010	Disp ACC Data	ditect patch(up)10	ENG	[0 to 255 / 0 / 1/step]
4-902-011	Disp ACC Data	ditect patch(up)11	ENG	[0 to 255 / 0 / 1/step]
4-902-012	Disp ACC Data	ditect patch(up)12	ENG	[0 to 255 / 0 / 1/step]
4-902-013	Disp ACC Data	ditect patch(up)13	ENG	[0 to 255 / 0 / 1/step]
4-902-014	Disp ACC Data	ditect patch(up)14	ENG	[0 to 255 / 0 / 1/step]
4-902-015	Disp ACC Data	ditect patch(up)15	ENG	[0 to 255 / 0 / 1/step]
4-902-016	Disp ACC Data	ditect patch(up)16	ENG	[0 to 255 / 0 / 1/step]
4-902-017	Disp ACC Data	ditect patch(up)17	ENG	[0 to 255 / 0 / 1/step]
4-902-018	Disp ACC Data	ditect patch(up)18	ENG	[0 to 255 / 0 / 1/step]
4-902-019	Disp ACC Data	ditect patch(up)19	ENG	[0 to 255 / 0 / 1/step]
4-902-020	Disp ACC Data	ditect patch(up)20	ENG	[0 to 255 / 0 / 1/step]
4-902-021	Disp ACC Data	K patch (text)1	ENG	[0 to 255 / 0 / 1/step]
4-902-038	Disp ACC Data	K patch (text)18	ENG	[0 to 255 / 0 / 1/step]
4-902-039	Disp ACC Data	K patch (text)19	ENG	[0 to 255 / 0 / 1/step]
4-902-040	Disp ACC Data	K patch (text)20	ENG	[0 to 255 / 0 / 1/step]
4-902-041	Disp ACC Data	C patch (text)1	ENG	[0 to 255 / 0 / 1/step]
4-902-058	Disp ACC Data	C patch (text)18	ENG	[0 to 255 / 0 / 1/step]
4-902-059	Disp ACC Data	C patch (text)19	ENG	[0 to 255 / 0 / 1/step]

3.SP Mode Tables

SP No.	Large Category	Small Category	ENG or CTL	[Min to Max/Init./Step]
4-902-060	Disp ACC Data	C patch (text)20	ENG	[0 to 255 / 0 / 1/step]
4-902-061	Disp ACC Data	M patch (text)1	ENG	[0 to 255 / 0 / 1/step]
4-902-078	Disp ACC Data	M patch (text)18	ENG	[0 to 255 / 0 / 1/step]
4-902-079	Disp ACC Data	M patch (text)19	ENG	[0 to 255 / 0 / 1/step]
4-902-080	Disp ACC Data	M patch (text)20	ENG	[0 to 255 / 0 / 1/step]
4-902-081	Disp ACC Data	Y patch (text)1	ENG	[0 to 255 / 0 / 1/step]
4-902-098	Disp ACC Data	Y patch (text)18	ENG	[0 to 255 / 0 / 1/step]
4-902-099	Disp ACC Data	Y patch (text)19	ENG	[0 to 255 / 0 / 1/step]
4-902-100	Disp ACC Data	Y patch (text)20	ENG	[0 to 255 / 0 / 1/step]
4-902-101	Disp ACC Data	K patch (photo)1	ENG	[0 to 255 / 0 / 1/step]
4-902-118	Disp ACC Data	K patch (photo)18	ENG	[0 to 255 / 0 / 1/step]
4-902-119	Disp ACC Data	K patch (photo)19	ENG	[0 to 255 / 0 / 1/step]
4-902-120	Disp ACC Data	K patch (photo)20	ENG	[0 to 255 / 0 / 1/step]
4-902-121	Disp ACC Data	C patch (photo)1	ENG	[0 to 255 / 0 / 1/step]
4-902-138	Disp ACC Data	C patch (photo)18	ENG	[0 to 255 / 0 / 1/step]
4-902-139	Disp ACC Data	C patch (photo)19	ENG	[0 to 255 / 0 / 1/step]
4-902-140	Disp ACC Data	C patch (photo)20	ENG	[0 to 255 / 0 / 1/step]
4-902-141	Disp ACC Data	M patch (photo)1	ENG	[0 to 255 / 0 / 1/step]

3.SP Mode Tables

SP No.	Large Category	Small Category	ENG or CTL	[Min to Max/Init./Step]
4-902-158	Disp ACC Data	M patch (photo)18	ENG	[0 to 255 / 0 / 1/step]
4-902-159	Disp ACC Data	M patch (photo)19	ENG	[0 to 255 / 0 / 1/step]
4-902-160	Disp ACC Data	M patch (photo)20	ENG	[0 to 255 / 0 / 1/step]
4-902-161	Disp ACC Data	Y patch (photo)1	ENG	[0 to 255 / 0 / 1/step]
4-902-178	Disp ACC Data	Y patch (photo)18	ENG	[0 to 255 / 0 / 1/step]
4-902-179	Disp ACC Data	Y patch (photo)19	ENG	[0 to 255 / 0 / 1/step]
4-902-180	Disp ACC Data	Y patch (photo)20	ENG	[0 to 255 / 0 / 1/step]
4-902-181	Disp ACC Data	ditectpatch down1	ENG	[0 to 255 / 0 / 1/step]
4-902-182	Disp ACC Data	ditectpatch down2	ENG	[0 to 255 / 0 / 1/step]
4-902-183	Disp ACC Data	ditectpatch down3	ENG	[0 to 255 / 0 / 1/step]
4-902-184	Disp ACC Data	ditectpatch down4	ENG	[0 to 255 / 0 / 1/step]
4-902-185	Disp ACC Data	ditectpatch down5	ENG	[0 to 255 / 0 / 1/step]
4-902-186	Disp ACC Data	ditectpatch down6	ENG	[0 to 255 / 0 / 1/step]
4-902-187	Disp ACC Data	ditectpatch down7	ENG	[0 to 255 / 0 / 1/step]
4-902-188	Disp ACC Data	ditectpatch down8	ENG	[0 to 255 / 0 / 1/step]
4-902-189	Disp ACC Data	ditectpatch down9	ENG	[0 to 255 / 0 / 1/step]
4-902-190	Disp ACC Data	ditectpatch down10	ENG	[0 to 255 / 0 / 1/step]
4-902-191	Disp ACC Data	ditectpatch down11	ENG	[0 to 255 / 0 / 1/step]

3.SP Mode Tables

SP No.	Large Category	Small Category	ENG or CTL	[Min to Max/Init./Step]
4-902-192	Disp ACC Data	ditectpatch down12	ENG	[0 to 255 / 0 / 1/step]
4-902-193	Disp ACC Data	ditectpatch down13	ENG	[0 to 255 / 0 / 1/step]
4-902-194	Disp ACC Data	ditectpatch down14	ENG	[0 to 255 / 0 / 1/step]
4-902-195	Disp ACC Data	ditectpatch down15	ENG	[0 to 255 / 0 / 1/step]
4-902-196	Disp ACC Data	ditectpatch down16	ENG	[0 to 255 / 0 / 1/step]
4-902-197	Disp ACC Data	ditectpatch down17	ENG	[0 to 255 / 0 / 1/step]
4-902-198	Disp ACC Data	ditectpatch down18	ENG	[0 to 255 / 0 / 1/step]
4-902-199	Disp ACC Data	ditectpatch down19	ENG	[0 to 255 / 0 / 1/step]
4-902-200	Disp ACC Data	ditectpatch down20	ENG	[0 to 255 / 0 / 1/step]
4-903-001	Filter Setting	Ind Dot Erase: Text	ENG*	[0 to 7 / 0 / 1/step]
4-903-002	Filter Setting	Ind Dot Erase: Generation Copy	ENG*	[0 to 7 / 0 / 1/step]
4-905-001	Select Gradation Level		ENG*	[0 to 255 / 0 / 1/step]
4-907-001	Gamma Correction	Stamp Entry	ENG	[0 to 2 / 1 / 1/step]
4-918-009	Man Gamma Adj		ENG	[0 to 0 / 0 / 0/step]
4-930-001	Coverage Ctrl: Text	Copy: Full Color 1	ENG	[0 to 400 / 200 / 1/step]
4-930-002	Coverage Ctrl: Text	Copy: Full Color 2	ENG	[0 to 400 / 200 / 1/step]
4-930-003	Coverage Ctrl: Text	Copy: Single Color	ENG	[0 to 400 / 100 / 1/step]
4-930-004	Coverage Ctrl: Text	Copy: Color Conversion	ENG	[0 to 400 / 180 / 1/step]

3.SP Mode Tables

SP No.	Large Category	Small Category	ENG or CTL	[Min to Max/Init./Step]
4-930-005	Coverage Ctrl: Text	Coverage Ctrl OFF	ENG	[0 to 400 / 400 / 1/step]
4-931-001	Coverage Ctrl: Photo	Copy: Full Color 1	ENG	[0 to 400 / 240 / 1/step]
4-931-002	Coverage Ctrl: Photo	Copy: Full Color 2	ENG	[0 to 400 / 260 / 1/step]
4-931-003	Coverage Ctrl: Photo	Copy: Single Color	ENG	[0 to 400 / 100 / 1/step]
4-931-004	Coverage Ctrl: Photo	Copy: Color Conversion	ENG	[0 to 400 / 200 / 1/step]
4-931-005	Coverage Ctrl: Photo	Coverage Ctrl OFF	ENG	[0 to 400 / 400 / 1/step]
4-938-001	ACS:Edge Mask	Copy:Sub LEdge	ENG*	[0 to 31 / 10 / 1mm/step]
4-938-002	ACS:Edge Mask	Copy:Sub TEdge	ENG*	[0 to 31 / 10 / 1mm/step]
4-938-003	ACS:Edge Mask	Copy:Main LEdge	ENG*	[0 to 31 / 10 / 1mm/step]
4-938-004	ACS:Edge Mask	Copy:Main TEdge	ENG*	[0 to 31 / 10 / 1mm/step]
4-938-005	ACS:Edge Mask	Scan:Sub LEdge	ENG*	[0 to 31 / 15 / 1mm/step]
4-938-006	ACS:Edge Mask	Scan:Sub TEdge	ENG*	[0 to 31 / 15 / 1mm/step]
4-938-007	ACS:Edge Mask	Scan:Main LEdge	ENG*	[0 to 31 / 15 / 1mm/step]
4-938-008	ACS:Edge Mask	Scan:Main TEdge	ENG*	[0 to 31 / 15 / 1mm/step]
4-939-001	ACS:Color Range		ENG*	[-2 to 2 / 0 / 1/step]
4-950-001	ACC Position Error Count		ENG	[0 to 65535 / 0 / 1/step]
4-954-005	Restore Test Chart	Chromaticity Rank	ENG*	[0 to 255 / 0 / 1/step]
4-958-005	Restore Test Chart: Rear	Chromaticity Rank	ENG*	[0 to 255 / 0 / 1/step]

3.SP Mode Tables

SP No.	Large Category	Small Category	ENG or CTL	[Min to Max/Init./Step]
4-984-001	IBACC Target Den	IBACC notch K	ENG*	[0 to 10 / 5 / 1/step]
4-984-002	IBACC Target Den	IBACC notch C	ENG*	[0 to 10 / 5 / 1/step]
4-984-003	IBACC Target Den	IBACC notch M	ENG*	[0 to 10 / 5 / 1/step]
4-984-004	IBACC Target Den	IBACC notch Y	ENG*	[0 to 10 / 5 / 1/step]
4-993-001	High Light Correction	Sensitivity Selection	ENG	[0 to 9 / 4 / 1/step]
4-993-002	High Light Correction	Range Selection	ENG	[0 to 9 / 4 / 1/step]
4-994-001	Adj Txt/Photo Recog Level	High Compression PDF	ENG	[0 to 2 / 1 / 1/step]
4-996-001	White Paper Detection Level	strength(fax)	ENG	[0 to 6 / 3 / 1/step]
4-997-001	White Paper count conditions	conditions 1	ENG	[0 to 255 / 255 / 1/step]
4-997-002	White Paper count conditions	conditions 2	ENG	[0 to 255 / 255 / 1/step]
4-997-003	White Paper count conditions	conditions 3	ENG	[0 to 255 / 80 / 1/step]
4-997-004	White Paper count conditions	conditions 4	ENG	[0 to 16777215 / 16777215 / 1/step]
4-998-001	White Paper Binary thresh	strength 0:up side	ENG	[0 to 255 / 20 / 1/step]
4-998-002	White Paper Binary thresh	strength 1:up side	ENG	[0 to 255 / 36 / 1/step]
4-998-003	White Paper Binary thresh	strength 2:up side	ENG	[0 to 255 / 52 / 1/step]
4-998-004	White Paper Binary thresh	strength 3:up side	ENG	[0 to 255 / 68 / 1/step]
4-998-005	White Paper Binary thresh	strength 4:up side	ENG	[0 to 255 / 84 / 1/step]
4-998-006	White Paper Binary thresh	strength 5:up side	ENG	[0 to 255 / 100 / 1/step]

3.SP Mode Tables

SP No.	Large Category	Small Category	ENG or CTL	[Min to Max/Init./Step]
4-998-007	White Paper Binary thresh	strength 6:up side	ENG	[0 to 255 / 116 / 1/step]
4-998-008	White Paper Binary thresh	strength 0:down side	ENG	[0 to 255 / 20 / 1/step]
4-998-009	White Paper Binary thresh	strength 1:down side	ENG	[0 to 255 / 36 / 1/step]
4-998-010	White Paper Binary thresh	strength 2:down side	ENG	[0 to 255 / 52 / 1/step]
4-998-011	White Paper Binary thresh	strength 3:down side	ENG	[0 to 255 / 68 / 1/step]
4-998-012	White Paper Binary thresh	strength 4:down side	ENG	[0 to 255 / 84 / 1/step]
4-998-013	White Paper Binary thresh	strength 5:down side	ENG	[0 to 255 / 100 / 1/step]
4-998-014	White Paper Binary thresh	strength 6:down side	ENG	[0 to 255 / 116 / 1/step]

Engine SP Tables-5

SP5-XXX (Mode)

SP No.	Large Category	Small Category	ENG or CTL	[Min to Max/Init./Step]
5-126-001	Set F-size Document		ENG	[0 to 2 / 0 / 1/step]
5-131-001	Paper Size Type Selection		ENG*	IM C3500: TWN: [0 to 2 / 2 / 1/step] NA: [0 to 2 / 1 / 1/step] KOR: [0 to 2 / 2 / 1/step] EU: [0 to 2 / 2 / 1/step] CHN: [0 to 2 / 2 / 1/step] AS: [0 to 2 / 2 / 1/step]

3.SP Mode Tables

SP No.	Large Category	Small Category	ENG or CTL	[Min to Max/Init./Step]
				IM C2500: TWN: [0 to 2 / 2 / 1/step] NA: [0 to 2 / 1 / 1/step] KOR: [0 to 2 / 2 / 1/step] EU: [0 to 2 / 2 / 1/step] CHN: [0 to 2 / 2 / 1/step] AS: [0 to 2 / 2 / 1/step] IM C2000: TWN: [0 to 2 / 2 / 1/step] NA: [0 to 2 / 1 / 1/step] KOR: [0 to 2 / 2 / 1/step] EU: [0 to 2 / 2 / 1/step] CHN: [0 to 2 / 2 / 1/step] AS: [0 to 2 / 2 / 1/step] IM C3000: TWN: [0 to 2 / 2 / 1/step] NA: [0 to 2 / 1 / 1/step] KOR: [0 to 2 / 2 / 1/step] EU: [0 to 2 / 2 / 1/step] CHN: [0 to 2 / 2 / 1/step]

3.SP Mode Tables

SP No.	Large Category	Small Category	ENG or CTL	[Min to Max/Init./Step]
				AS: [0 to 2 / 2 / 1/step]
5-135-001	LG_Oficio Change		ENG*	[0 to 1 / 0 / 1/step]
5-181-001	Size Adjust	TRAY 1	ENG*	IM C3500: TWN: [0 to 3 / 0 / 1/step] NA: [0 to 3 / 1 / 1/step] KOR: [0 to 3 / 0 / 1/step] EU: [0 to 3 / 0 / 1/step] CHN: [0 to 3 / 0 / 1/step] AS: [0 to 3 / 0 / 1/step] IM C2500: TWN: [0 to 3 / 0 / 1/step] NA: [0 to 3 / 1 / 1/step] KOR: [0 to 3 / 0 / 1/step] EU: [0 to 3 / 0 / 1/step] CHN: [0 to 3 / 0 / 1/step] AS: [0 to 3 / 0 / 1/step] IM C2000: TWN: [0 to 3 / 0 / 1/step] NA: [0 to 3 / 1 / 1/step] KOR: [0 to 3 / 0 / 1/step]

3.SP Mode Tables

SP No.	Large Category	Small Category	ENG or CTL	[Min to Max/Init./Step]
				EU: [0 to 3 / 0 / 1/step] CHN: [0 to 3 / 0 / 1/step] AS: [0 to 3 / 0 / 1/step] IM C3000: TWN: [0 to 3 / 0 / 1/step] NA: [0 to 3 / 1 / 1/step] KOR: [0 to 3 / 0 / 1/step] EU: [0 to 3 / 0 / 1/step] CHN: [0 to 3 / 0 / 1/step] AS: [0 to 3 / 0 / 1/step]
5-181-002	Size Adjust	TRAY 2: 1	ENG*	IM C3500: TWN: [0 to 1 / 0 / 1/step] NA: [0 to 1 / 1 / 1/step] KOR: [0 to 1 / 0 / 1/step] EU: [0 to 1 / 0 / 1/step] CHN: [0 to 1 / 0 / 1/step] AS: [0 to 1 / 0 / 1/step] IM C2500: TWN: [0 to 1 / 0 / 1/step] NA: [0 to 1 / 1 / 1/step]

3.SP Mode Tables

SP No.	Large Category	Small Category	ENG or CTL	[Min to Max/Init./Step]
				KOR: [0 to 1 / 0 / 1/step] EU: [0 to 1 / 0 / 1/step] CHN: [0 to 1 / 0 / 1/step] AS: [0 to 1 / 0 / 1/step] IM C2000: TWN: [0 to 1 / 0 / 1/step] NA: [0 to 1 / 1 / 1/step] KOR: [0 to 1 / 0 / 1/step] EU: [0 to 1 / 0 / 1/step] CHN: [0 to 1 / 0 / 1/step] AS: [0 to 1 / 0 / 1/step] IM C3000: TWN: [0 to 1 / 0 / 1/step] NA: [0 to 1 / 1 / 1/step] KOR: [0 to 1 / 0 / 1/step] EU: [0 to 1 / 0 / 1/step] CHN: [0 to 1 / 0 / 1/step] AS: [0 to 1 / 0 / 1/step]
5-181-003	Size Adjust	TRAY 2: 2	ENG*	IM C3500: TWN: [0 to 1 / 0 / 1/step]

3.SP Mode Tables

SP No.	Large Category	Small Category	ENG or CTL	[Min to Max/Init./Step]
				NA: [0 to 1 / 1 / 1/step] KOR: [0 to 1 / 0 / 1/step] EU: [0 to 1 / 0 / 1/step] CHN: [0 to 1 / 0 / 1/step] AS: [0 to 1 / 0 / 1/step] IM C2500: TWN: [0 to 1 / 0 / 1/step] NA: [0 to 1 / 1 / 1/step] KOR: [0 to 1 / 0 / 1/step] EU: [0 to 1 / 0 / 1/step] CHN: [0 to 1 / 0 / 1/step] AS: [0 to 1 / 0 / 1/step] IM C2000: TWN: [0 to 1 / 0 / 1/step] NA: [0 to 1 / 1 / 1/step] KOR: [0 to 1 / 0 / 1/step] EU: [0 to 1 / 0 / 1/step] CHN: [0 to 1 / 0 / 1/step] AS: [0 to 1 / 0 / 1/step] IM C3000:

3.SP Mode Tables

SP No.	Large Category	Small Category	ENG or CTL	[Min to Max/Init./Step]
				TWN: [0 to 1 / 0 / 1/step] NA: [0 to 1 / 1 / 1/step] KOR: [0 to 1 / 0 / 1/step] EU: [0 to 1 / 0 / 1/step] CHN: [0 to 1 / 0 / 1/step] AS: [0 to 1 / 0 / 1/step]
5-181-004	Size Adjust	TRAY 2: 3	ENG*	IM C3500: TWN: [0 to 1 / 0 / 1/step] NA: [0 to 1 / 1 / 1/step] KOR: [0 to 1 / 0 / 1/step] EU: [0 to 1 / 0 / 1/step] CHN: [0 to 1 / 0 / 1/step] AS: [0 to 1 / 0 / 1/step] IM C2500: TWN: [0 to 1 / 0 / 1/step] NA: [0 to 1 / 1 / 1/step] KOR: [0 to 1 / 0 / 1/step] EU: [0 to 1 / 0 / 1/step] CHN: [0 to 1 / 0 / 1/step] AS: [0 to 1 / 0 / 1/step]

3.SP Mode Tables

SP No.	Large Category	Small Category	ENG or CTL	[Min to Max/Init./Step]
				1/step] IM C2000: TWN: [0 to 1 / 0 / 1/step] NA: [0 to 1 / 1 / 1/step] KOR: [0 to 1 / 0 / 1/step] EU: [0 to 1 / 0 / 1/step] CHN: [0 to 1 / 0 / 1/step] AS: [0 to 1 / 0 / 1/step] IM C3000: TWN: [0 to 1 / 0 / 1/step] NA: [0 to 1 / 1 / 1/step] KOR: [0 to 1 / 0 / 1/step] EU: [0 to 1 / 0 / 1/step] CHN: [0 to 1 / 0 / 1/step] AS: [0 to 1 / 0 / 1/step]
5-181-005	Size Adjust	TRAY 2: 4	ENG*	IM C3500: TWN: [0 to 1 / 0 / 1/step] NA: [0 to 1 / 1 / 1/step] KOR: [0 to 1 / 0 / 1/step] EU: [0 to 1 / 0 / 1/step] CHN: [0 to 1 / 0 /

3.SP Mode Tables

SP No.	Large Category	Small Category	ENG or CTL	[Min to Max/Init./Step]
				1/step] AS: [0 to 1 / 0 / 1/step] IM C2500: TWN: [0 to 1 / 0 / 1/step] NA: [0 to 1 / 1 / 1/step] KOR: [0 to 1 / 0 / 1/step] EU: [0 to 1 / 0 / 1/step] CHN: [0 to 1 / 0 / 1/step] AS: [0 to 1 / 0 / 1/step] IM C2000: TWN: [0 to 1 / 0 / 1/step] NA: [0 to 1 / 1 / 1/step] KOR: [0 to 1 / 0 / 1/step] EU: [0 to 1 / 0 / 1/step] CHN: [0 to 1 / 0 / 1/step] AS: [0 to 1 / 0 / 1/step] IM C3000: TWN: [0 to 1 / 0 / 1/step] NA: [0 to 1 / 1 / 1/step] KOR: [0 to 1 / 0 / 1/step] EU: [0 to 1 / 0 /

3.SP Mode Tables

SP No.	Large Category	Small Category	ENG or CTL	[Min to Max/Init./Step]
				1/step] CHN: [0 to 1 / 0 / 1/step] AS: [0 to 1 / 0 / 1/step]
5-181-006	Size Adjust	TRAY 2: 5	ENG*	IM C3500: TWN: [0 to 1 / 0 / 1/step] NA: [0 to 1 / 1 / 1/step] KOR: [0 to 1 / 0 / 1/step] EU: [0 to 1 / 0 / 1/step] CHN: [0 to 1 / 0 / 1/step] AS: [0 to 1 / 0 / 1/step] IM C2500: TWN: [0 to 1 / 0 / 1/step] NA: [0 to 1 / 1 / 1/step] KOR: [0 to 1 / 0 / 1/step] EU: [0 to 1 / 0 / 1/step] CHN: [0 to 1 / 0 / 1/step] AS: [0 to 1 / 0 / 1/step] IM C2000: TWN: [0 to 1 / 0 / 1/step] NA: [0 to 1 / 1 / 1/step] KOR: [0 to 1 / 0 /

3.SP Mode Tables

SP No.	Large Category	Small Category	ENG or CTL	[Min to Max/Init./Step]
				1/step] EU: [0 to 1 / 0 / 1/step] CHN: [0 to 1 / 0 / 1/step] AS: [0 to 1 / 0 / 1/step] IM C3000: TWN: [0 to 1 / 0 / 1/step] NA: [0 to 1 / 1 / 1/step] KOR: [0 to 1 / 0 / 1/step] EU: [0 to 1 / 0 / 1/step] CHN: [0 to 1 / 0 / 1/step] AS: [0 to 1 / 0 / 1/step]
5-181-007	Size Adjust	TRAY 3/T-LCT: 1	ENG*	IM C3500: TWN: [0 to 1 / 0 / 1/step] NA: [0 to 1 / 1 / 1/step] KOR: [0 to 1 / 0 / 1/step] EU: [0 to 1 / 0 / 1/step] CHN: [0 to 1 / 0 / 1/step] AS: [0 to 1 / 0 / 1/step] IM C2500: TWN: [0 to 1 / 0 / 1/step] NA: [0 to 1 / 1 /

3.SP Mode Tables

SP No.	Large Category	Small Category	ENG or CTL	[Min to Max/Init./Step]
				1/step] KOR: [0 to 1 / 0 / 1/step] EU: [0 to 1 / 0 / 1/step] CHN: [0 to 1 / 0 / 1/step] AS: [0 to 1 / 0 / 1/step] IM C2000: TWN: [0 to 1 / 0 / 1/step] NA: [0 to 1 / 1 / 1/step] KOR: [0 to 1 / 0 / 1/step] EU: [0 to 1 / 0 / 1/step] CHN: [0 to 1 / 0 / 1/step] AS: [0 to 1 / 0 / 1/step] IM C3000: TWN: [0 to 1 / 0 / 1/step] NA: [0 to 1 / 1 / 1/step] KOR: [0 to 1 / 0 / 1/step] EU: [0 to 1 / 0 / 1/step] CHN: [0 to 1 / 0 / 1/step] AS: [0 to 1 / 0 / 1/step]
5-181-008	Size Adjust	TRAY 3: 2	ENG*	IM C3500: TWN: [0 to 1 / 0 /

3.SP Mode Tables

SP No.	Large Category	Small Category	ENG or CTL	[Min to Max/Init./Step]
				1/step] NA: [0 to 1 / 1 / 1/step] KOR: [0 to 1 / 0 / 1/step] EU: [0 to 1 / 0 / 1/step] CHN: [0 to 1 / 0 / 1/step] AS: [0 to 1 / 0 / 1/step] IM C2500: TWN: [0 to 1 / 0 / 1/step] NA: [0 to 1 / 1 / 1/step] KOR: [0 to 1 / 0 / 1/step] EU: [0 to 1 / 0 / 1/step] CHN: [0 to 1 / 0 / 1/step] AS: [0 to 1 / 0 / 1/step] IM C2000: TWN: [0 to 1 / 0 / 1/step] NA: [0 to 1 / 1 / 1/step] KOR: [0 to 1 / 0 / 1/step] EU: [0 to 1 / 0 / 1/step] CHN: [0 to 1 / 0 / 1/step] AS: [0 to 1 / 0 / 1/step]

3.SP Mode Tables

SP No.	Large Category	Small Category	ENG or CTL	[Min to Max/Init./Step]
				IM C3000: TWN: [0 to 1 / 0 / 1/step] NA: [0 to 1 / 1 / 1/step] KOR: [0 to 1 / 0 / 1/step] EU: [0 to 1 / 0 / 1/step] CHN: [0 to 1 / 0 / 1/step] AS: [0 to 1 / 0 / 1/step]
5-181-009	Size Adjust	TRAY 3: 3	ENG*	IM C3500: TWN: [0 to 1 / 0 / 1/step] NA: [0 to 1 / 1 / 1/step] KOR: [0 to 1 / 0 / 1/step] EU: [0 to 1 / 0 / 1/step] CHN: [0 to 1 / 0 / 1/step] AS: [0 to 1 / 0 / 1/step] IM C2500: TWN: [0 to 1 / 0 / 1/step] NA: [0 to 1 / 1 / 1/step] KOR: [0 to 1 / 0 / 1/step] EU: [0 to 1 / 0 / 1/step] CHN: [0 to 1 / 0 / 1/step]

3.SP Mode Tables

SP No.	Large Category	Small Category	ENG or CTL	[Min to Max/Init./Step]
				AS: [0 to 1 / 0 / 1/step] IM C2000: TWN: [0 to 1 / 0 / 1/step] NA: [0 to 1 / 1 / 1/step] KOR: [0 to 1 / 0 / 1/step] EU: [0 to 1 / 0 / 1/step] CHN: [0 to 1 / 0 / 1/step] AS: [0 to 1 / 0 / 1/step] IM C3000: TWN: [0 to 1 / 0 / 1/step] NA: [0 to 1 / 1 / 1/step] KOR: [0 to 1 / 0 / 1/step] EU: [0 to 1 / 0 / 1/step] CHN: [0 to 1 / 0 / 1/step] AS: [0 to 1 / 0 / 1/step]
5-181-010	Size Adjust	TRAY 3: 4	ENG*	IM C3500: TWN: [0 to 1 / 0 / 1/step] NA: [0 to 1 / 1 / 1/step] KOR: [0 to 1 / 0 / 1/step] EU: [0 to 1 / 0 / 1/step]

3.SP Mode Tables

SP No.	Large Category	Small Category	ENG or CTL	[Min to Max/Init./Step]
				CHN: [0 to 1 / 0 / 1/step] AS: [0 to 1 / 0 / 1/step] IM C2500: TWN: [0 to 1 / 0 / 1/step] NA: [0 to 1 / 1 / 1/step] KOR: [0 to 1 / 0 / 1/step] EU: [0 to 1 / 0 / 1/step] CHN: [0 to 1 / 0 / 1/step] AS: [0 to 1 / 0 / 1/step] IM C2000: TWN: [0 to 1 / 0 / 1/step] NA: [0 to 1 / 1 / 1/step] KOR: [0 to 1 / 0 / 1/step] EU: [0 to 1 / 0 / 1/step] CHN: [0 to 1 / 0 / 1/step] AS: [0 to 1 / 0 / 1/step] IM C3000: TWN: [0 to 1 / 0 / 1/step] NA: [0 to 1 / 1 / 1/step] KOR: [0 to 1 / 0 / 1/step]

3.SP Mode Tables

SP No.	Large Category	Small Category	ENG or CTL	[Min to Max/Init./Step]
				EU: [0 to 1 / 0 / 1/step] CHN: [0 to 1 / 0 / 1/step] AS: [0 to 1 / 0 / 1/step]
5-181-011	Size Adjust	TRAY 3: 5	ENG*	IM C3500: TWN: [0 to 1 / 0 / 1/step] NA: [0 to 1 / 1 / 1/step] KOR: [0 to 1 / 0 / 1/step] EU: [0 to 1 / 0 / 1/step] CHN: [0 to 1 / 0 / 1/step] AS: [0 to 1 / 0 / 1/step] IM C2500: TWN: [0 to 1 / 0 / 1/step] NA: [0 to 1 / 1 / 1/step] KOR: [0 to 1 / 0 / 1/step] EU: [0 to 1 / 0 / 1/step] CHN: [0 to 1 / 0 / 1/step] AS: [0 to 1 / 0 / 1/step] IM C2000: TWN: [0 to 1 / 0 / 1/step] NA: [0 to 1 / 1 / 1/step]

3.SP Mode Tables

SP No.	Large Category	Small Category	ENG or CTL	[Min to Max/Init./Step]
				KOR: [0 to 1 / 0 / 1/step] EU: [0 to 1 / 0 / 1/step] CHN: [0 to 1 / 0 / 1/step] AS: [0 to 1 / 0 / 1/step] IM C3000: TWN: [0 to 1 / 0 / 1/step] NA: [0 to 1 / 1 / 1/step] KOR: [0 to 1 / 0 / 1/step] EU: [0 to 1 / 0 / 1/step] CHN: [0 to 1 / 0 / 1/step] AS: [0 to 1 / 0 / 1/step]
5-181-012	Size Adjust	TRAY 4: 1	ENG*	IM C3500: TWN: [0 to 1 / 0 / 1/step] NA: [0 to 1 / 1 / 1/step] KOR: [0 to 1 / 0 / 1/step] EU: [0 to 1 / 0 / 1/step] CHN: [0 to 1 / 0 / 1/step] AS: [0 to 1 / 0 / 1/step] IM C2500: TWN: [0 to 1 / 0 / 1/step]

3.SP Mode Tables

SP No.	Large Category	Small Category	ENG or CTL	[Min to Max/Init./Step]
				NA: [0 to 1 / 1 / 1/step] KOR: [0 to 1 / 0 / 1/step] EU: [0 to 1 / 0 / 1/step] CHN: [0 to 1 / 0 / 1/step] AS: [0 to 1 / 0 / 1/step] IM C2000: TWN: [0 to 1 / 0 / 1/step] NA: [0 to 1 / 1 / 1/step] KOR: [0 to 1 / 0 / 1/step] EU: [0 to 1 / 0 / 1/step] CHN: [0 to 1 / 0 / 1/step] AS: [0 to 1 / 0 / 1/step] IM C3000: TWN: [0 to 1 / 0 / 1/step] NA: [0 to 1 / 1 / 1/step] KOR: [0 to 1 / 0 / 1/step] EU: [0 to 1 / 0 / 1/step] CHN: [0 to 1 / 0 / 1/step] AS: [0 to 1 / 0 / 1/step]
5-181-	Size Adjust	TRAY 4: 2	ENG*	IM C3500:

3.SP Mode Tables

SP No.	Large Category	Small Category	ENG or CTL	[Min to Max/Init./Step]
013				TWN: [0 to 1 / 0 / 1/step] NA: [0 to 1 / 1 / 1/step] KOR: [0 to 1 / 0 / 1/step] EU: [0 to 1 / 0 / 1/step] CHN: [0 to 1 / 0 / 1/step] AS: [0 to 1 / 0 / 1/step] IM C2500: TWN: [0 to 1 / 0 / 1/step] NA: [0 to 1 / 1 / 1/step] KOR: [0 to 1 / 0 / 1/step] EU: [0 to 1 / 0 / 1/step] CHN: [0 to 1 / 0 / 1/step] AS: [0 to 1 / 0 / 1/step] IM C2000: TWN: [0 to 1 / 0 / 1/step] NA: [0 to 1 / 1 / 1/step] KOR: [0 to 1 / 0 / 1/step] EU: [0 to 1 / 0 / 1/step] CHN: [0 to 1 / 0 / 1/step] AS: [0 to 1 / 0 / 1/step]

3.SP Mode Tables

SP No.	Large Category	Small Category	ENG or CTL	[Min to Max/Init./Step]
				1/step] IM C3000: TWN: [0 to 1 / 0 / 1/step] NA: [0 to 1 / 1 / 1/step] KOR: [0 to 1 / 0 / 1/step] EU: [0 to 1 / 0 / 1/step] CHN: [0 to 1 / 0 / 1/step] AS: [0 to 1 / 0 / 1/step]
5-181-014	Size Adjust	TRAY 4: 3	ENG*	IM C3500: TWN: [0 to 1 / 0 / 1/step] NA: [0 to 1 / 1 / 1/step] KOR: [0 to 1 / 0 / 1/step] EU: [0 to 1 / 0 / 1/step] CHN: [0 to 1 / 0 / 1/step] AS: [0 to 1 / 0 / 1/step] IM C2500: TWN: [0 to 1 / 0 / 1/step] NA: [0 to 1 / 1 / 1/step] KOR: [0 to 1 / 0 / 1/step] EU: [0 to 1 / 0 / 1/step] CHN: [0 to 1 / 0 /

3.SP Mode Tables

SP No.	Large Category	Small Category	ENG or CTL	[Min to Max/Init./Step]
				1/step] AS: [0 to 1 / 0 / 1/step] IM C2000: TWN: [0 to 1 / 0 / 1/step] NA: [0 to 1 / 1 / 1/step] KOR: [0 to 1 / 0 / 1/step] EU: [0 to 1 / 0 / 1/step] CHN: [0 to 1 / 0 / 1/step] AS: [0 to 1 / 0 / 1/step] IM C3000: TWN: [0 to 1 / 0 / 1/step] NA: [0 to 1 / 1 / 1/step] KOR: [0 to 1 / 0 / 1/step] EU: [0 to 1 / 0 / 1/step] CHN: [0 to 1 / 0 / 1/step] AS: [0 to 1 / 0 / 1/step]
5-181-015	Size Adjust	TRAY 4: 4	ENG*	IM C3500: TWN: [0 to 1 / 0 / 1/step] NA: [0 to 1 / 1 / 1/step] KOR: [0 to 1 / 0 / 1/step] EU: [0 to 1 / 0 /

3.SP Mode Tables

SP No.	Large Category	Small Category	ENG or CTL	[Min to Max/Init./Step]
				1/step] CHN: [0 to 1 / 0 / 1/step] AS: [0 to 1 / 0 / 1/step] IM C2500: TWN: [0 to 1 / 0 / 1/step] NA: [0 to 1 / 1 / 1/step] KOR: [0 to 1 / 0 / 1/step] EU: [0 to 1 / 0 / 1/step] CHN: [0 to 1 / 0 / 1/step] AS: [0 to 1 / 0 / 1/step] IM C2000: TWN: [0 to 1 / 0 / 1/step] NA: [0 to 1 / 1 / 1/step] KOR: [0 to 1 / 0 / 1/step] EU: [0 to 1 / 0 / 1/step] CHN: [0 to 1 / 0 / 1/step] AS: [0 to 1 / 0 / 1/step] IM C3000: TWN: [0 to 1 / 0 / 1/step] NA: [0 to 1 / 1 / 1/step] KOR: [0 to 1 / 0 /

3.SP Mode Tables

SP No.	Large Category	Small Category	ENG or CTL	[Min to Max/Init./Step]
				1/step] EU: [0 to 1 / 0 / 1/step] CHN: [0 to 1 / 0 / 1/step] AS: [0 to 1 / 0 / 1/step]
5-181-016	Size Adjust	TRAY 4: 5	ENG*	IM C3500: TWN: [0 to 1 / 0 / 1/step] NA: [0 to 1 / 1 / 1/step] KOR: [0 to 1 / 0 / 1/step] EU: [0 to 1 / 0 / 1/step] CHN: [0 to 1 / 0 / 1/step] AS: [0 to 1 / 0 / 1/step] IM C2500: TWN: [0 to 1 / 0 / 1/step] NA: [0 to 1 / 1 / 1/step] KOR: [0 to 1 / 0 / 1/step] EU: [0 to 1 / 0 / 1/step] CHN: [0 to 1 / 0 / 1/step] AS: [0 to 1 / 0 / 1/step] IM C2000: TWN: [0 to 1 / 0 / 1/step] NA: [0 to 1 / 1 /

3.SP Mode Tables

SP No.	Large Category	Small Category	ENG or CTL	[Min to Max/Init./Step]
				1/step] KOR: [0 to 1 / 0 / 1/step] EU: [0 to 1 / 0 / 1/step] CHN: [0 to 1 / 0 / 1/step] AS: [0 to 1 / 0 / 1/step] IM C3000: TWN: [0 to 1 / 0 / 1/step] NA: [0 to 1 / 1 / 1/step] KOR: [0 to 1 / 0 / 1/step] EU: [0 to 1 / 0 / 1/step] CHN: [0 to 1 / 0 / 1/step] AS: [0 to 1 / 0 / 1/step]
5-181-017	Size Adjust	LCT	ENG*	IM C3500: TWN: [0 to 2 / 0 / 1/step] NA: [0 to 2 / 1 / 1/step] KOR: [0 to 2 / 0 / 1/step] EU: [0 to 2 / 0 / 1/step] CHN: [0 to 2 / 0 / 1/step] AS: [0 to 2 / 0 / 1/step] IM C2500: TWN: [0 to 2 / 0 /

3.SP Mode Tables

SP No.	Large Category	Small Category	ENG or CTL	[Min to Max/Init./Step]
				1/step] NA: [0 to 2 / 1 / 1/step] KOR: [0 to 2 / 0 / 1/step] EU: [0 to 2 / 0 / 1/step] CHN: [0 to 2 / 0 / 1/step] AS: [0 to 2 / 0 / 1/step] IM C2000: TWN: [0 to 2 / 0 / 1/step] NA: [0 to 2 / 1 / 1/step] KOR: [0 to 2 / 0 / 1/step] EU: [0 to 2 / 0 / 1/step] CHN: [0 to 2 / 0 / 1/step] AS: [0 to 2 / 0 / 1/step] IM C3000: TWN: [0 to 2 / 0 / 1/step] NA: [0 to 2 / 1 / 1/step] KOR: [0 to 2 / 0 / 1/step] EU: [0 to 2 / 0 / 1/step] CHN: [0 to 2 / 0 / 1/step] AS: [0 to 2 / 0 / 1/step]

3.SP Mode Tables

SP No.	Large Category	Small Category	ENG or CTL	[Min to Max/Init./Step]
5-186-001	RK4		ENG*	[0 to 1 / 0 / 1/step]
5-610-004	Base Gamma Ctrl Pt:Execute	Get Factory Default	ENG	[0 to 1 / 0 / 1/step]
5-610-005	Base Gamma Ctrl Pt:Execute	Set Factory Default	ENG	[0 to 1 / 0 / 1/step]
5-610-006	Base Gamma Ctrl Pt:Execute	Restore Orginal Value	ENG	[0 to 1 / 0 / 1/step]
5-611-001	Toner Color in 2C	B-C	ENG	[0 to 128 / 100 / 1/step]
5-611-002	Toner Color in 2C	B-M	ENG	[0 to 128 / 100 / 1/step]
5-611-003	Toner Color in 2C	G-C	ENG	[0 to 128 / 100 / 1/step]
5-611-004	Toner Color in 2C	G-Y	ENG	[0 to 128 / 100 / 1/step]
5-611-005	Toner Color in 2C	R-M	ENG	[0 to 128 / 100 / 1/step]
5-611-006	Tonner Color in 2C	R-Y	ENG	[0 to 128 / 100 / 1/step]
5-801-002	Memory Clear	Engine	ENG	[0 to 1 / 0 / 1/step]
5-805-001	Dehumid Heater ON at Stand-by	0:OFF / 1:ON	ENG*	[0 to 1 / 0 / 1/step]
5-805-101	HT for PaperTray/Scanner&PCU	Jan.:Heater for PaperTray	ENG*	IM C3500: [0 to 0 / 0 / 1/step] IM C2500: [0 to 0 / 0 / 1/step] IM C2000: [0 to 0 / 0 / 1/step] IM C3000: [0 to 0 / 0 / 1/step]
5-805-102	HT for PaperTray/Scanner&PCU	Feb.:Heater for PaperTray	ENG*	IM C3500: [0 to 0 / 0 / 1/step] IM C2500: [0 to 0 / 0 / 1/step]

3.SP Mode Tables

SP No.	Large Category	Small Category	ENG or CTL	[Min to Max/Init./Step]
				IM C2000: [0 to 0 / 0 / 1/step] IM C3000: [0 to 0 / 0 / 1/step]
5-805-103	HT for PaperTray/Scanner&PCU	Mar.:Heater for PaperTray	ENG*	IM C3500: [0 to 0 / 0 / 1/step] IM C2500: [0 to 0 / 0 / 1/step] IM C2000: [0 to 0 / 0 / 1/step] IM C3000: [0 to 0 / 0 / 1/step]
5-805-104	HT for PaperTray/Scanner&PCU	Apr.:Heater for PaperTray	ENG*	IM C3500: [0 to 0 / 0 / 1/step] IM C2500: [0 to 0 / 0 / 1/step] IM C2000: [0 to 0 / 0 / 1/step] IM C3000: [0 to 0 / 0 / 1/step]
5-805-105	HT for PaperTray/Scanner&PCU	May:Heater for PaperTray	ENG*	IM C3500: [0 to 0 / 0 / 1/step] IM C2500: [0 to 0 / 0 / 1/step] IM C2000: [0 to 0 / 0 / 1/step] IM C3000: [0 to 0 / 0 / 1/step]
5-805-106	HT for PaperTray/Scanner&PCU	Jun.:Heater for PaperTray	ENG*	IM C3500: [0 to 0 / 0 / 1/step] IM C2500: [0 to 0 / 0 / 1/step] IM C2000: [0 to 0 / 0 / 1/step] IM C3000: [0 to 0 / 0 / 1/step]
5-805-	HT for	Jul.:Heater for	ENG*	IM C3500:

3.SP Mode Tables

SP No.	Large Category	Small Category	ENG or CTL	[Min to Max/Init./Step]
107	PaperTray/Scanner&PCU	PaperTray		[0 to 0 / 0 / 1/step] IM C2500: [0 to 0 / 0 / 1/step] IM C2000: [0 to 0 / 0 / 1/step] IM C3000: [0 to 0 / 0 / 1/step]
5-805-108	HT for PaperTray/Scanner&PCU	Aug.:Heater for PaperTray	ENG*	IM C3500: [0 to 0 / 0 / 1/step] IM C2500: [0 to 0 / 0 / 1/step] IM C2000: [0 to 0 / 0 / 1/step] IM C3000: [0 to 0 / 0 / 1/step]
5-805-109	HT for PaperTray/Scanner&PCU	Sep.:Heater for PaperTray	ENG*	IM C3500: [0 to 0 / 0 / 1/step] IM C2500: [0 to 0 / 0 / 1/step] IM C2000: [0 to 0 / 0 / 1/step] IM C3000: [0 to 0 / 0 / 1/step]
5-805-110	HT for PaperTray/Scanner&PCU	Oct.:Heater for PaperTray	ENG*	IM C3500: [0 to 0 / 0 / 1/step] IM C2500: [0 to 0 / 0 / 1/step] IM C2000: [0 to 0 / 0 / 1/step] IM C3000: [0 to 0 / 0 / 1/step]
5-805-111	HT for PaperTray/Scanner&PCU	Nov.:Heater for PaperTray	ENG*	IM C3500: [0 to 0 / 0 / 1/step] IM C2500: [0 to 0 / 0 / 1/step] IM C2000: [0 to 0 / 0 / 1/step] IM C3000: [0 to 0 / 0 / 1/step]

3.SP Mode Tables

SP No.	Large Category	Small Category	ENG or CTL	[Min to Max/Init./Step]
				IM C3000: [0 to 0 / 0 / 1/step]
5-805-112	HT for PaperTray/Scanner&PCU	Dec.:Heater for PaperTray	ENG*	IM C3500: [0 to 0 / 0 / 1/step] IM C2500: [0 to 0 / 0 / 1/step] IM C2000: [0 to 0 / 0 / 1/step] IM C3000: [0 to 0 / 0 / 1/step]
5-805-201	HT for PaperTray/Scanner&PCU	Jan.:Heater for Scanner&PCU	ENG*	IM C3500: [0 to 0 / 0 / 1/step] IM C2500: [0 to 0 / 0 / 1/step] IM C2000: [0 to 0 / 0 / 1/step] IM C3000: [0 to 0 / 0 / 1/step]
5-805-202	HT for PaperTray/Scanner&PCU	Feb.:Heater for Scanner&PCU	ENG*	IM C3500: [0 to 0 / 0 / 1/step] IM C2500: [0 to 0 / 0 / 1/step] IM C2000: [0 to 0 / 0 / 1/step] IM C3000: [0 to 0 / 0 / 1/step]
5-805-203	HT for PaperTray/Scanner&PCU	Mar.:Heater for Scanner&PCU	ENG*	IM C3500: [0 to 0 / 0 / 1/step] IM C2500: [0 to 0 / 0 / 1/step] IM C2000: [0 to 0 / 0 / 1/step] IM C3000: [0 to 0 / 0 / 1/step]
5-805-204	HT for PaperTray/Scanner&PCU	Apr.:Heater for Scanner&PCU	ENG*	IM C3500: [0 to 0 / 0 / 1/step] IM C2500:

3.SP Mode Tables

SP No.	Large Category	Small Category	ENG or CTL	[Min to Max/Init./Step]
				[0 to 0 / 0 / 1/step] IM C2000: [0 to 0 / 0 / 1/step] IM C3000: [0 to 0 / 0 / 1/step]
5-805-205	HT for PaperTray/Scanner&PCU	May:Heater for Scanner&PCU	ENG*	IM C3500: [0 to 0 / 0 / 1/step] IM C2500: [0 to 0 / 0 / 1/step] IM C2000: [0 to 0 / 0 / 1/step] IM C3000: [0 to 0 / 0 / 1/step]
5-805-206	HT for PaperTray/Scanner&PCU	Jun.:Heater for Scanner&PCU	ENG*	IM C3500: [0 to 0 / 0 / 1/step] IM C2500: [0 to 0 / 0 / 1/step] IM C2000: [0 to 0 / 0 / 1/step] IM C3000: [0 to 0 / 0 / 1/step]
5-805-207	HT for PaperTray/Scanner&PCU	Jul.:Heater for Scanner&PCU	ENG*	IM C3500: [0 to 0 / 0 / 1/step] IM C2500: [0 to 0 / 0 / 1/step] IM C2000: [0 to 0 / 0 / 1/step] IM C3000: [0 to 0 / 0 / 1/step]
5-805-208	HT for PaperTray/Scanner&PCU	Aug.:Heater for Scanner&PCU	ENG*	IM C3500: [0 to 0 / 0 / 1/step] IM C2500: [0 to 0 / 0 / 1/step] IM C2000: [0 to 0 / 0 / 1/step] IM C3000: [0 to 0 / 0 / 1/step]

3.SP Mode Tables

SP No.	Large Category	Small Category	ENG or CTL	[Min to Max/Init./Step]
5-805-209	HT for PaperTray/Scanner&PCU	Sep.:Heater for Scanner&PCU	ENG*	IM C3500: [0 to 0 / 0 / 1/step] IM C2500: [0 to 0 / 0 / 1/step] IM C2000: [0 to 0 / 0 / 1/step] IM C3000: [0 to 0 / 0 / 1/step]
5-805-210	HT for PaperTray/Scanner&PCU	Oct.:Heater for Scanner&PCU	ENG*	IM C3500: [0 to 0 / 0 / 1/step] IM C2500: [0 to 0 / 0 / 1/step] IM C2000: [0 to 0 / 0 / 1/step] IM C3000: [0 to 0 / 0 / 1/step]
5-805-211	HT for PaperTray/Scanner&PCU	Nov.:Heater for Scanner&PCU	ENG*	IM C3500: [0 to 0 / 0 / 1/step] IM C2500: [0 to 0 / 0 / 1/step] IM C2000: [0 to 0 / 0 / 1/step] IM C3000: [0 to 0 / 0 / 1/step]
5-805-212	HT for PaperTray/Scanner&PCU	Dec.:Heater for Scanner&PCU	ENG*	IM C3500: [0 to 0 / 0 / 1/step] IM C2500: [0 to 0 / 0 / 1/step] IM C2000: [0 to 0 / 0 / 1/step] IM C3000: [0 to 0 / 0 / 1/step]
5-810-001	SC Reset	Fusing SC Reset	ENG	[0 to 1 / 0 / 1/step]
5-810-002	SC Reset	Hard High Temp. Detection	ENG	[0 to 1 / 0 / 1/step]
5-811-	MachineSerial	Display	ENG*	[0 to 255 / 0 /

3.SP Mode Tables

SP No.	Large Category	Small Category	ENG or CTL	[Min to Max/Init./Step]
002				1/step]
5-811-004	MachineSerial Set	BCU	ENG	[0 to 255 / 0 / 1/step]
5-811-021	Machine Serial Update Date	Latest	ENG*	[0 to 1 / 0 / 1/step]
5-811-022	Machine Serial Update Date	Previous	ENG*	[0 to 1 / 0 / 1/step]
5-811-023	Machine Serial	Previous	ENG*	[0 to 255 / 0 / 1/step]
5-811-024	Machine Serial Update Date	Latest(BCU)	ENG*	[0 to 1 / 0 / 1/step]
5-811-025	Machine Serial Update Date	Previous(BCU)	ENG*	[0 to 1 / 0 / 1/step]
5-811-026	Machine Serial	Previous(BCU)	ENG*	[0 to 255 / 0 / 1/step]
5-894-001	External Mech Count Setting	Mech Counter Switch Setting	ENG*	[0 to 2 / 0 / 1/step]
5-900-001	Engine Log Upload	Pattern	ENG*	[0 to 4 / 0 / 1/step]
5-900-002	Engine Log Upload	Trigger	ENG*	[0 to 3 / 0 / 1/step]
5-900-003	Engine Log Upload	Execute	ENG	[0 to 1 / 0 / 1/step]
5-998-001	Fusing Warm UP	Warm Up In Advance ON/OFF	ENG*	[0 to 1 / 0 / 1/step]

Engine SP Tables-6

SP6-XXX (Peripherals)

SP No.	Large Category	Small Category	ENG or CTL	[Min to Max/Init./Step]
6-006-001	ADF Adjustment	Side-to-Side Regist: Front	ENG*	[-3.0 to 3.0 / 0.0 / 0.1mm/step]
6-006-	ADF Adjustment	Side-to-Side Regist: Rear	ENG*	[-3.0 to 3.0 / 0.0 / 0.1mm/step]

3.SP Mode Tables

SP No.	Large Category	Small Category	ENG or CTL	[Min to Max/Init./Step]
002				
6-006-003	ADF Adjustment	Leading Edge Registration: Front	ENG*	[-5.0 to 5.0 / 0.0 / 0.1mm/step]
6-006-004	ADF Adjustment	Leading Edge Registration: Rear	ENG*	[-5.0 to 5.0 / 0.0 / 0.1mm/step]
6-006-005	ADF Adjustment	Buckle: Duplex Front	ENG*	[-10.0 to 10.0 / 0.0 / 0.1mm/step]
6-006-006	ADF Adjustment	Buckle: Duplex Rear	ENG*	[-10.0 to 10.0 / 0.0 / 0.1mm/step]
6-006-007	ADF Adjustment	Rear Edge Erase Front	ENG*	[-10.0 to 10.0 / -2.3 / 0.1mm/step]
6-006-008	ADF Adjustment	Rear Edge Erase Rear	ENG*	[-10.0 to 10.0 / -2.3 / 0.1mm/step]
6-006-010	ADF Adjustment	L-Edge Regist (1-Pass): Front	ENG*	[-5.0 to 5.0 / 0.0 / 0.1mm/step]
6-006-011	ADF Adjustment	L-Edge Regist (1-Pass): Rear	ENG*	[-5.0 to 5.0 / 0.0 / 0.1mm/step]
6-006-012	ADF Adjustment	1st Buckle (1-Pass)	ENG*	[-3.0 to 3.0 / 0.0 / 0.1mm/step]
6-006-013	ADF Adjustment	2nd Buckle (1-Pass)	ENG*	[-2.0 to 3.0 / 0.0 / 0.1mm/step]
6-006-014	ADF Adjustment	T-Edge Erase (1-Pass): Front	ENG*	[-5.0 to 5.0 / -3.0 / 0.1mm/step]
6-	ADF Adjustment	T-Edge Erase (1-Pass):	ENG*	[-5.0 to 5.0 / -2.5 /

3.SP Mode Tables

SP No.	Large Category	Small Category	ENG or CTL	[Min to Max/Init./Step]
006-015		Rear		0.1mm/step]
6-006-016	ADF Adjustment	ADF Feed Jam	ENG*	[0 to 1 / 0 / 1/step]
6-006-017	ADF Adjustment	Side-to-Side Regist:Front: with Feeding Unit	ENG*	[-3.0 to 3.0 / 0.0 / 0.1mm/step]
6-006-018	ADF Adjustment	Side-to-Side Regist:Rear: with Feeding Unit	ENG*	[-3.0 to 3.0 / 0.0 / 0.1mm/step]
6-006-019	ADF Adjustment	L-Edge Regist(1-Pass):Front:with FeedingUnit	ENG*	[-5.0 to 5.0 / 0.0 / 0.1mm/step]
6-006-020	ADF Adjustment	L-Edge Regist(1-Pass):Rear:with Feeding Unit	ENG*	[-5.0 to 5.0 / 0.0 / 0.1mm/step]
6-006-021	ADF Adjustment	T-Edge Erase(1-Pass):Front:with FeedingUnit	ENG*	[-5.0 to 5.0 / -3.0 / 0.1mm/step]
6-006-022	ADF Adjustment	T-Edge Erase(1-Pass):Rear:with Feeding Unit	ENG*	[-5.0 to 5.0 / -2.5 / 0.1mm/step]
6-006-023	ADF Adjustment	1st Buckle(1-Pass):with Feeding Unit	ENG*	[0.0 to 2.0 / 0.0 / 0.1mm/step]
6-009-001	ADF FreeRun	Free Run Simplex Motion	ENG	[0 to 1 / 0 / 1/step]
6-009-002	ADF FreeRun	Free Run Duplex Motion	ENG	[0 to 1 / 0 / 1/step]
6-009-003	ADF FreeRun	Free Run Stamp Motion	ENG	[0 to 1 / 0 / 1/step]

3.SP Mode Tables

SP No.	Large Category	Small Category	ENG or CTL	[Min to Max/Init./Step]
6-009-004	ADF FreeRun	Free Run Simplex Motion(low speed)	ENG	[0 to 1 / 0 / 1/step]
6-009-005	ADF FreeRun	Free Run Simplex Motion(high speed)	ENG	[0 to 1 / 0 / 1/step]
6-009-006	ADF FreeRun	Free Run Duplex Motion(low speed)	ENG	[0 to 1 / 0 / 1/step]
6-009-007	ADF FreeRun	Free Run Duplex Motion(high speed)	ENG	[0 to 1 / 0 / 1/step]
6-010-001	Stamp Position Adj.		ENG*	[-5.0 to 5.0 / 0.0 / 0.1mm/step]
6-016-001	Original Size Detect Setting		ENG*	[0 to 255 / 0 / 1/step]
6-017-001	DF Magnification Adj.		ENG*	[-5.0 to 5.0 / 0.0 / 0.1%/step]
6-020-001	Skew Correction Moving Setting		ENG*	[0 to 1 / 0 / 1/step]
6-040-001	ADF Double Feed Detect Setup	Double Feed Detect Sensor (1-Pass)	ENG*	[0 to 1 / 0 / 1/step]
6-040-002	ADF Double Feed Detect Setup	Detect enable (1-Pass)	ENG*	[0 to 1 / 0 / 1/step]
6-040-003	ADF Double Feed Detect Setup	Detect decide (1-Pass)	ENG*	[10 to 15 / 10 / 1Times/step]
6-040-006	ADF Double Feed Detect Setup	Detect number (1-Pass)	ENG*	[1 to 8 / 2 / 1Times/step]

3.SP Mode Tables

SP No.	Large Category	Small Category	ENG or CTL	[Min to Max/Init./Step]
6-040-008	ADF Double Feed Detect Setup	Detect Test (1-Pass)	ENG	[0 to 1 / 0 / 1/step]
6-040-009	ADF Double Feed Detect Setup	Detect Adjust Result (1-Pass)	ENG	[0 to 255 / 0 / 1/step]
6-050-001	DF Feeding Unit detect ON/OFF		ENG*	[0 to 1 / 0 / 1/step]
6-099-001	Sel. ShiftTray Full:2K/3K FIN	Sel. ShiftTray Full	ENG	[0 to 1 / 0 / 1/step]
6-100-001	Sub-scanPunchPosAdj:2K/3K FIN	JPN/EU: 2-Hole	ENG	[-7.5 to 7.5 / 0.0 / 0.5mm/step]
6-100-002	Sub-scanPunchPosAdj:2K/3K FIN	NA: 3-Hole	ENG	[-7.5 to 7.5 / 0.0 / 0.5mm/step]
6-100-003	Sub-scanPunchPosAdj:2K/3K FIN	Europe: 4-Hole	ENG	[-7.5 to 7.5 / 0.0 / 0.5mm/step]
6-100-004	Sub-scanPunchPosAdj:2K/3K FIN	NEU: 4-Hole	ENG	[-7.5 to 7.5 / 0.0 / 0.5mm/step]
6-100-005	Sub-scanPunchPosAdj:2K/3K FIN	NA: 2-Hole	ENG	[-7.5 to 7.5 / 0.0 / 0.5mm/step]
6-100-006	Sub-scanPunchPosAdj:2K/3K FIN	JPN: 1-Hole	ENG	[-7.5 to 7.5 / 0.0 / 0.5mm/step]
6-101-001	Main-scanPunchPosAdj:2K/3K FIN	JPN/EU: 2-Hole	ENG	[-2.0 to 2.0 / 0.0 / 0.4mm/step]
6-101-002	Main-scanPunchPosAdj:2K/3K FIN	NA: 3-Hole	ENG	[-2.0 to 2.0 / 0.0 / 0.4mm/step]

3.SP Mode Tables

SP No.	Large Category	Small Category	ENG or CTL	[Min to Max/Init./Step]
6-101-003	Main-scanPunchPosAdj:2K/3K FIN	Europe: 4-Hole	ENG	[-2.0 to 2.0 / 0.0 / 0.4mm/step]
6-101-004	Main-scanPunchPosAdj:2K/3K FIN	NEU: 4-Hole	ENG	[-2.0 to 2.0 / 0.0 / 0.4mm/step]
6-101-005	Main-scanPunchPosAdj:2K/3K FIN	NA: 2-Hole	ENG	[-2.0 to 2.0 / 0.0 / 0.4mm/step]
6-101-006	Main-scanPunchPosAdj:2K/3K FIN	JPN:1-1Hole	ENG	[-2.0 to 2.0 / 0.0 / 0.4mm/step]
6-102-001	SkewCorrectBuckleAdj:2K/3K FIN	A3 SEF	ENG	[-5.0 to 5.0 / 0.0 / 0.2mm/step]
6-102-002	SkewCorrectBuckleAdj:2K/3K FIN	B4 SEF	ENG	[-5.0 to 5.0 / 0.0 / 0.2mm/step]
6-102-003	SkewCorrectBuckleAdj:2K/3K FIN	A4 SEF	ENG	[-5.0 to 5.0 / 0.0 / 0.2mm/step]
6-102-004	SkewCorrectBuckleAdj:2K/3K FIN	A4 LEF	ENG	[-5.0 to 5.0 / 0.0 / 0.2mm/step]
6-102-005	SkewCorrectBuckleAdj:2K/3K FIN	B5 SEF	ENG	[-5.0 to 5.0 / 0.0 / 0.2mm/step]
6-102-006	SkewCorrectBuckleAdj:2K/3K FIN	B5 LEF	ENG	[-5.0 to 5.0 / 0.0 / 0.2mm/step]
6-102-007	SkewCorrectBuckleAdj:2K/3K FIN	A5 LEF	ENG	[-5.0 to 5.0 / 0.0 / 0.2mm/step]
6-102-008	SkewCorrectBuckleAdj:2K/3K FIN	DLT SEF	ENG	[-5.0 to 5.0 / 0.0 / 0.2mm/step]

3.SP Mode Tables

SP No.	Large Category	Small Category	ENG or CTL	[Min to Max/Init./Step]
6-102-009	SkewCorrectBuckleAdj:2K/3K FIN	LG SEF	ENG	[-5.0 to 5.0 / 0.0 / 0.2mm/step]
6-102-010	SkewCorrectBuckleAdj:2K/3K FIN	Oficio SEF	ENG	[-5.0 to 5.0 / 0.0 / 0.2mm/step]
6-102-011	SkewCorrectBuckleAdj:2K/3K FIN	LT SEF	ENG	[-5.0 to 5.0 / 0.0 / 0.2mm/step]
6-102-012	SkewCorrectBuckleAdj:2K/3K FIN	LT LEF	ENG	[-5.0 to 5.0 / 0.0 / 0.2mm/step]
6-102-013	SkewCorrectBuckleAdj:2K/3K FIN	HLT LEF	ENG	[-5.0 to 5.0 / 0.0 / 0.2mm/step]
6-102-014	SkewCorrectBuckleAdj:2K/3K FIN	12"x18"	ENG	[-5.0 to 5.0 / 0.0 / 0.2mm/step]
6-102-015	SkewCorrectBuckleAdj:2K/3K FIN	8K SEF	ENG	[-5.0 to 5.0 / 0.0 / 0.2mm/step]
6-102-016	SkewCorrectBuckleAdj:2K/3K FIN	16K SEF	ENG	[-5.0 to 5.0 / 0.0 / 0.2mm/step]
6-102-017	SkewCorrectBuckleAdj:2K/3K FIN	16K LEF	ENG	[-5.0 to 5.0 / 0.0 / 0.2mm/step]
6-102-018	SkewCorrectBuckleAdj:2K/3K FIN	Other	ENG	[-5.0 to 5.0 / 0.0 / 0.2mm/step]
6-103-001	SkewCorrectCtrlSW:2K/3K FIN	A3 SEF	ENG	[0 to 1 / 0 / 1/step]
6-103-002	SkewCorrectCtrlSW:2K/3K FIN	B4 SEF	ENG	[0 to 1 / 0 / 1/step]

3.SP Mode Tables

SP No.	Large Category	Small Category	ENG or CTL	[Min to Max/Init./Step]
6-103-003	SkewCorrectCtrlSW:2K/3K FIN	A4 SEF	ENG	[0 to 1 / 0 / 1/step]
6-103-004	SkewCorrectCtrlSW:2K/3K FIN	A4 LEF	ENG	[0 to 1 / 0 / 1/step]
6-103-005	SkewCorrectCtrlSW:2K/3K FIN	B5 SEF	ENG	[0 to 1 / 0 / 1/step]
6-103-006	SkewCorrectCtrlSW:2K/3K FIN	B5 LEF	ENG	[0 to 1 / 0 / 1/step]
6-103-007	SkewCorrectCtrlSW:2K/3K FIN	A5 LEF	ENG	[0 to 1 / 0 / 1/step]
6-103-008	SkewCorrectCtrlSW:2K/3K FIN	DLT SEF	ENG	[0 to 1 / 0 / 1/step]
6-103-009	SkewCorrectCtrlSW:2K/3K FIN	LG SEF	ENG	[0 to 1 / 0 / 1/step]
6-103-010	SkewCorrectCtrlSW:2K/3K FIN	Oficio SEF	ENG	[0 to 1 / 0 / 1/step]
6-103-011	SkewCorrectCtrlSW:2K/3K FIN	LT SEF	ENG	[0 to 1 / 0 / 1/step]
6-103-012	SkewCorrectCtrlSW:2K/3K FIN	LT LEF	ENG	[0 to 1 / 0 / 1/step]
6-103-013	SkewCorrectCtrlSW:2K/3K FIN	HLT LEF	ENG	[0 to 1 / 0 / 1/step]
6-103-014	SkewCorrectCtrlSW:2K/3K FIN	12"x18"	ENG	[0 to 1 / 0 / 1/step]

3.SP Mode Tables

SP No.	Large Category	Small Category	ENG or CTL	[Min to Max/Init./Step]
6-103-015	SkewCorrectCtrlSW:2K/3K FIN	8K SEF	ENG	[0 to 1 / 0 / 1/step]
6-103-016	SkewCorrectCtrlSW:2K/3K FIN	16K SEF	ENG	[0 to 1 / 0 / 1/step]
6-103-017	SkewCorrectCtrlSW:2K/3K FIN	16K LEF	ENG	[0 to 1 / 0 / 1/step]
6-103-018	SkewCorrectCtrlSW:2K/3K FIN	Other	ENG	[0 to 1 / 0 / 1/step]
6-104-001	ShiftTrayJogPosAdj:2K/3K FIN	A3 SEF	ENG	[-1.5 to 1.5 / 0.0 / 0.5mm/step]
6-104-002	ShiftTrayJogPosAdj:2K/3K FIN	B4 SEF	ENG	[-1.5 to 1.5 / 0.0 / 0.5mm/step]
6-104-003	ShiftTrayJogPosAdj:2K/3K FIN	A4 SEF	ENG	[-1.5 to 1.5 / 0.0 / 0.5mm/step]
6-104-004	ShiftTrayJogPosAdj:2K/3K FIN	A4 LEF	ENG	[-1.5 to 1.5 / 0.0 / 0.5mm/step]
6-104-005	ShiftTrayJogPosAdj:2K/3K FIN	B5 LEF	ENG	[-1.5 to 1.5 / 0.0 / 0.5mm/step]
6-104-006	ShiftTrayJogPosAdj:2K/3K FIN	A5 LEF	ENG	[-1.5 to 1.5 / 0.0 / 0.5mm/step]
6-104-007	ShiftTrayJogPosAdj:2K/3K FIN	DLT SEF	ENG	[-1.5 to 1.5 / 0.0 / 0.5mm/step]
6-104-008	ShiftTrayJogPosAdj:2K/3K FIN	LG SEF	ENG	[-1.5 to 1.5 / 0.0 / 0.5mm/step]

3.SP Mode Tables

SP No.	Large Category	Small Category	ENG or CTL	[Min to Max/Init./Step]
6-104-009	ShiftTrayJogPosAdj:2K/3K FIN	Oficio SEF	ENG	[-1.5 to 1.5 / 0.0 / 0.5mm/step]
6-104-010	ShiftTrayJogPosAdj:2K/3K FIN	LT SEF	ENG	[-1.5 to 1.5 / 0.0 / 0.5mm/step]
6-104-011	ShiftTrayJogPosAdj:2K/3K FIN	LT LEF	ENG	[-1.5 to 1.5 / 0.0 / 0.5mm/step]
6-104-012	ShiftTrayJogPosAdj:2K/3K FIN	HLT LEF	ENG	[-1.5 to 1.5 / 0.0 / 0.5mm/step]
6-104-013	ShiftTrayJogPosAdj:2K/3K FIN	8K SEF	ENG	[-1.5 to 1.5 / 0.0 / 0.5mm/step]
6-104-014	ShiftTrayJogPosAdj:2K/3K FIN	16K LEF	ENG	[-1.5 to 1.5 / 0.0 / 0.5mm/step]
6-104-015	ShiftTrayJogPosAdj:2K/3K FIN	Other	ENG	[-1.5 to 1.5 / 0.0 / 0.5mm/step]
6-105-001	ShftTJogRtrctAngAdj:2K/3K FIN	A3 SEF	ENG	[-10 to 10 / 0 / 5deg/step]
6-105-002	ShftTJogRtrctAngAdj:2K/3K FIN	B4 SEF	ENG	[-10 to 10 / 0 / 5deg/step]
6-105-003	ShftTJogRtrctAngAdj:2K/3K FIN	A4 SEF	ENG	[-10 to 10 / 0 / 5deg/step]
6-105-004	ShftTJogRtrctAngAdj:2K/3K FIN	DLT SEF	ENG	[-10 to 10 / 0 / 5deg/step]
6-105-005	ShftTJogRtrctAngAdj:2K/3K FIN	LG SEF	ENG	[-10 to 10 / 0 / 5deg/step]

3.SP Mode Tables

SP No.	Large Category	Small Category	ENG or CTL	[Min to Max/Init./Step]
6-105-006	ShftTJogRtrctAngAdj:2K/3K FIN	Oficio SEF	ENG	[-10 to 10 / 0 / 5deg/step]
6-105-007	ShftTJogRtrctAngAdj:2K/3K FIN	LT SEF	ENG	[-10 to 10 / 0 / 5deg/step]
6-105-008	ShftTJogRtrctAngAdj:2K/3K FIN	8K SEF	ENG	[-10 to 10 / 0 / 5deg/step]
6-105-009	ShftTJogRtrctAngAdj:2K/3K FIN	Other	ENG	[-10 to 10 / 0 / 5deg/step]
6-106-001	Use Paper Jogger: 2K/3K FIN	A3 SEF	ENG	[0 to 1 / 0 / 1/step]
6-106-002	Use Paper Jogger: 2K/3K FIN	B4 SEF	ENG	[0 to 1 / 0 / 1/step]
6-106-003	Use Paper Jogger: 2K/3K FIN	A4 SEF	ENG	[0 to 1 / 0 / 1/step]
6-106-004	Use Paper Jogger: 2K/3K FIN	A4 LEF	ENG	[0 to 1 / 0 / 1/step]
6-106-005	Use Paper Jogger: 2K/3K FIN	B5 LEF	ENG	[0 to 1 / 0 / 1/step]
6-106-006	Use Paper Jogger: 2K/3K FIN	A5 LEF	ENG	[0 to 1 / 0 / 1/step]
6-106-007	Use Paper Jogger: 2K/3K FIN	DLT SEF	ENG	[0 to 1 / 0 / 1/step]
6-106-008	Use Paper Jogger: 2K/3K FIN	LG SEF	ENG	[0 to 1 / 0 / 1/step]

3.SP Mode Tables

SP No.	Large Category	Small Category	ENG or CTL	[Min to Max/Init./Step]
6-106-009	Use Paper Jogger: 2K/3K FIN	Oficio SEF	ENG	[0 to 1 / 0 / 1/step]
6-106-010	Use Paper Jogger: 2K/3K FIN	LT SEF	ENG	[0 to 1 / 0 / 1/step]
6-106-011	Use Paper Jogger: 2K/3K FIN	LT LEF	ENG	[0 to 1 / 0 / 1/step]
6-106-012	Use Paper Jogger: 2K/3K FIN	HLT LEF	ENG	[0 to 1 / 0 / 1/step]
6-106-013	Use Paper Jogger: 2K/3K FIN	8K SEF	ENG	[0 to 1 / 0 / 1/step]
6-106-014	Use Paper Jogger: 2K/3K FIN	16K LEF	ENG	[0 to 1 / 0 / 1/step]
6-106-015	Use Paper Jogger: 2K/3K FIN	Other	ENG	[0 to 1 / 0 / 1/step]
6-107-001	JogPosAdj(CmrStplr):2K/3K FIN	A3 SEF	ENG	[-1.5 to 1.5 / 0.0 / 0.5mm/step]
6-107-002	JogPosAdj(CmrStplr):2K/3K FIN	B4 SEF	ENG	[-1.5 to 1.5 / 0.0 / 0.5mm/step]
6-107-003	JogPosAdj(CmrStplr):2K/3K FIN	A4 SEF	ENG	[-1.5 to 1.5 / 0.0 / 0.5mm/step]
6-107-004	JogPosAdj(CmrStplr):2K/3K FIN	A4 LEF	ENG	[-1.5 to 1.5 / 0.0 / 0.5mm/step]
6-107-005	JogPosAdj(CmrStplr):2K/3K FIN	B5 SEF	ENG	[-1.5 to 1.5 / 0.0 / 0.5mm/step]

3.SP Mode Tables

SP No.	Large Category	Small Category	ENG or CTL	[Min to Max/Init./Step]
6-107-006	JogPosAdj(CmrStplr):2K/3K FIN	B5 LEF	ENG	[-1.5 to 1.5 / 0.0 / 0.5mm/step]
6-107-007	JogPosAdj(CmrStplr):2K/3K FIN	DLT SEF	ENG	[-1.5 to 1.5 / 0.0 / 0.5mm/step]
6-107-008	JogPosAdj(CmrStplr):2K/3K FIN	LG SEF	ENG	[-1.5 to 1.5 / 0.0 / 0.5mm/step]
6-107-009	JogPosAdj(CmrStplr):2K/3K FIN	Oficio SEF	ENG	[-1.5 to 1.5 / 0.0 / 0.5mm/step]
6-107-010	JogPosAdj(CmrStplr):2K/3K FIN	LT SEF	ENG	[-1.5 to 1.5 / 0.0 / 0.5mm/step]
6-107-011	JogPosAdj(CmrStplr):2K/3K FIN	LT LEF	ENG	[-1.5 to 1.5 / 0.0 / 0.5mm/step]
6-107-012	JogPosAdj(CmrStplr):2K/3K FIN	8K SEF	ENG	[-1.5 to 1.5 / 0.0 / 0.5mm/step]
6-107-013	JogPosAdj(CmrStplr):2K/3K FIN	16K SEF	ENG	[-1.5 to 1.5 / 0.0 / 0.5mm/step]
6-107-014	JogPosAdj(CmrStplr):2K/3K FIN	16K LEF	ENG	[-1.5 to 1.5 / 0.0 / 0.5mm/step]
6-107-015	JogPosAdj(CmrStplr):2K/3K FIN	Other	ENG	[-1.5 to 1.5 / 0.0 / 0.5mm/step]
6-108-001	JogPosAdj(BookStplr):2K/3K FIN	A3 SEF	ENG	[-1.5 to 1.5 / 0.0 / 0.5mm/step]
6-108-002	JogPosAdj(BookStplr):2K/3K FIN	B4 SEF	ENG	[-1.5 to 1.5 / 0.0 / 0.5mm/step]

3.SP Mode Tables

SP No.	Large Category	Small Category	ENG or CTL	[Min to Max/Init./Step]
6-108-003	JogPosAdj(BookStplr):2K/3K FIN	A4 SEF	ENG	[-1.5 to 1.5 / 0.0 / 0.5mm/step]
6-108-004	JogPosAdj(BookStplr):2K/3K FIN	B5 SEF	ENG	[-1.5 to 1.5 / 0.0 / 0.5mm/step]
6-108-005	JogPosAdj(BookStplr):2K/3K FIN	DLT SEF	ENG	[-1.5 to 1.5 / 0.0 / 0.5mm/step]
6-108-006	JogPosAdj(BookStplr):2K/3K FIN	LG SEF	ENG	[-1.5 to 1.5 / 0.0 / 0.5mm/step]
6-108-007	JogPosAdj(BookStplr):2K/3K FIN	Oficio SEF	ENG	[-1.5 to 1.5 / 0.0 / 0.5mm/step]
6-108-008	JogPosAdj(BookStplr):2K/3K FIN	LT SEF	ENG	[-1.5 to 1.5 / 0.0 / 0.5mm/step]
6-108-009	JogPosAdj(BookStplr):2K/3K FIN	12"x18"	ENG	[-1.5 to 1.5 / 0.0 / 0.5mm/step]
6-108-010	JogPosAdj(BookStplr):2K/3K FIN	8K SEF	ENG	[-1.5 to 1.5 / 0.0 / 0.5mm/step]
6-108-011	JogPosAdj(BookStplr):2K/3K FIN	Other	ENG	[-1.5 to 1.5 / 0.0 / 0.5mm/step]
6-109-001	CnrStplrJogTimeAdj:2K/3K FIN	A3 SEF	ENG	[0 to 2 / 0 / 1times/step]
6-109-002	CnrStplrJogTimeAdj:2K/3K FIN	B4 SEF	ENG	[0 to 2 / 0 / 1times/step]
6-109-003	CnrStplrJogTimeAdj:2K/3K FIN	A4 SEF	ENG	[0 to 2 / 0 / 1times/step]

3.SP Mode Tables

SP No.	Large Category	Small Category	ENG or CTL	[Min to Max/Init./Step]
6-109-004	CmnrStplrJogTimeAdj:2K/3K FIN	A4 LEF	ENG	[0 to 2 / 0 / 1times/step]
6-109-005	CmnrStplrJogTimeAdj:2K/3K FIN	B5 SEF	ENG	[0 to 2 / 0 / 1times/step]
6-109-006	CmnrStplrJogTimeAdj:2K/3K FIN	B5 LEF	ENG	[0 to 2 / 0 / 1times/step]
6-109-007	CmnrStplrJogTimeAdj:2K/3K FIN	DLT SEF	ENG	[0 to 2 / 0 / 1times/step]
6-109-008	CmnrStplrJogTimeAdj:2K/3K FIN	LG SEF	ENG	[0 to 2 / 0 / 1times/step]
6-109-009	CmnrStplrJogTimeAdj:2K/3K FIN	Oficio SEF	ENG	[0 to 2 / 0 / 1times/step]
6-109-010	CmnrStplrJogTimeAdj:2K/3K FIN	LT SEF	ENG	[0 to 2 / 0 / 1times/step]
6-109-011	CmnrStplrJogTimeAdj:2K/3K FIN	LT LEF	ENG	[0 to 2 / 0 / 1times/step]
6-109-012	CmnrStplrJogTimeAdj:2K/3K FIN	8K SEF	ENG	[0 to 2 / 0 / 1times/step]
6-109-013	CmnrStplrJogTimeAdj:2K/3K FIN	16K SEF	ENG	[0 to 2 / 0 / 1times/step]
6-109-014	CmnrStplrJogTimeAdj:2K/3K FIN	16K LEF	ENG	[0 to 2 / 0 / 1times/step]
6-109-015	CmnrStplrJogTimeAdj:2K/3K FIN	Other	ENG	[0 to 2 / 0 / 1times/step]

3.SP Mode Tables

SP No.	Large Category	Small Category	ENG or CTL	[Min to Max/Init./Step]
6-110-001	BookStplrJogTimeAdj:2K/3K FIN	A3 SEF	ENG	[0 to 2 / 0 / 1times/step]
6-110-002	BookStplrJogTimeAdj:2K/3K FIN	B4 SEF	ENG	[0 to 2 / 0 / 1times/step]
6-110-003	BookStplrJogTimeAdj:2K/3K FIN	A4 SEF	ENG	[0 to 2 / 0 / 1times/step]
6-110-004	BookStplrJogTimeAdj:2K/3K FIN	B5 SEF	ENG	[0 to 2 / 0 / 1times/step]
6-110-005	BookStplrJogTimeAdj:2K/3K FIN	DLT SEF	ENG	[0 to 2 / 0 / 1times/step]
6-110-006	BookStplrJogTimeAdj:2K/3K FIN	LG SEF	ENG	[0 to 2 / 0 / 1times/step]
6-110-007	BookStplrJogTimeAdj:2K/3K FIN	Oficio SEF	ENG	[0 to 2 / 0 / 1times/step]
6-110-008	BookStplrJogTimeAdj:2K/3K FIN	LT SEF	ENG	[0 to 2 / 0 / 1times/step]
6-110-009	BookStplrJogTimeAdj:2K/3K FIN	12"x18"	ENG	[0 to 2 / 0 / 1times/step]
6-110-010	BookStplrJogTimeAdj:2K/3K FIN	8K SEF	ENG	[0 to 2 / 0 / 1times/step]
6-110-011	BookStplrJogTimeAdj:2K/3K FIN	Other	ENG	[0 to 2 / 0 / 1times/step]
6-111-001	Staple Position Adj: 2K/3K FIN	A3 SEF	ENG	[-3.5 to 3.5 / 0.0 / 0.5mm/step]

3.SP Mode Tables

SP No.	Large Category	Small Category	ENG or CTL	[Min to Max/Init./Step]
6-111-002	Staple Position Adj: 2K/3K FIN	B4 SEF	ENG	[-3.5 to 3.5 / 0.0 / 0.5mm/step]
6-111-003	Staple Position Adj: 2K/3K FIN	A4 SEF	ENG	[-3.5 to 3.5 / 0.0 / 0.5mm/step]
6-111-004	Staple Position Adj: 2K/3K FIN	A4 LEF	ENG	[-3.5 to 3.5 / 0.0 / 0.5mm/step]
6-111-005	Staple Position Adj: 2K/3K FIN	B5 SEF	ENG	[-3.5 to 3.5 / 0.0 / 0.5mm/step]
6-111-006	Staple Position Adj: 2K/3K FIN	B5 LEF	ENG	[-3.5 to 3.5 / 0.0 / 0.5mm/step]
6-111-007	Staple Position Adj: 2K/3K FIN	DLT SEF	ENG	[-3.5 to 3.5 / 0.0 / 0.5mm/step]
6-111-008	Staple Position Adj: 2K/3K FIN	LG SEF	ENG	[-3.5 to 3.5 / 0.0 / 0.5mm/step]
6-111-009	Staple Position Adj: 2K/3K FIN	Oficio SEF	ENG	[-3.5 to 3.5 / 0.0 / 0.5mm/step]
6-111-010	Staple Position Adj: 2K/3K FIN	LT SEF	ENG	[-3.5 to 3.5 / 0.0 / 0.5mm/step]
6-111-011	Staple Position Adj: 2K/3K FIN	LT LEF	ENG	[-3.5 to 3.5 / 0.0 / 0.5mm/step]
6-111-012	Staple Position Adj: 2K/3K FIN	8K SEF	ENG	[-3.5 to 3.5 / 0.0 / 0.5mm/step]
6-111-013	Staple Position Adj: 2K/3K FIN	16K SEF	ENG	[-3.5 to 3.5 / 0.0 / 0.5mm/step]

3.SP Mode Tables

SP No.	Large Category	Small Category	ENG or CTL	[Min to Max/Init./Step]
6-111-014	Staple Position Adj: 2K/3K FIN	16K LEF	ENG	[-3.5 to 3.5 / 0.0 / 0.5mm/step]
6-111-015	Staple Position Adj: 2K/3K FIN	Other	ENG	[-3.5 to 3.5 / 0.0 / 0.5mm/step]
6-112-001	BookletStaplerPosAdj:2K/3K FIN	A3 SEF	ENG	[-3.0 to 3.0 / 0.0 / 0.2mm/step]
6-112-002	BookletStaplerPosAdj:2K/3K FIN	B4 SEF	ENG	[-3.0 to 3.0 / 0.0 / 0.2mm/step]
6-112-003	BookletStaplerPosAdj:2K/3K FIN	A4 SEF	ENG	[-3.0 to 3.0 / 0.0 / 0.2mm/step]
6-112-004	BookletStaplerPosAdj:2K/3K FIN	B5 SEF	ENG	[-3.0 to 3.0 / 0.0 / 0.2mm/step]
6-112-005	BookletStaplerPosAdj:2K/3K FIN	DLT SEF	ENG	[-3.0 to 3.0 / 0.0 / 0.2mm/step]
6-112-006	BookletStaplerPosAdj:2K/3K FIN	LG SEF	ENG	[-3.0 to 3.0 / 0.0 / 0.2mm/step]
6-112-007	BookletStaplerPosAdj:2K/3K FIN	Oficio SEF	ENG	[-3.0 to 3.0 / 0.0 / 0.2mm/step]
6-112-008	BookletStaplerPosAdj:2K/3K FIN	LT SEF	ENG	[-3.0 to 3.0 / 0.0 / 0.2mm/step]
6-112-009	BookletStaplerPosAdj:2K/3K FIN	12"x18"	ENG	[-1.8 to 1.8 / 0.0 / 0.2mm/step]
6-112-010	BookletStaplerPosAdj:2K/3K FIN	8K SEF	ENG	[-3.0 to 3.0 / 0.0 / 0.2mm/step]

3.SP Mode Tables

SP No.	Large Category	Small Category	ENG or CTL	[Min to Max/Init./Step]
6-112-011	BookletStaplerPosAdj:2K/3K FIN	Other	ENG	[-1.8 to 1.8 / 0.0 / 0.2mm/step]
6-113-001	BookletFolderPosAdj:2K/3K FIN	A3 SEF	ENG	[-3.0 to 3.0 / 0.0 / 0.2mm/step]
6-113-002	BookletFolderPosAdj:2K/3K FIN	B4 SEF	ENG	[-3.0 to 3.0 / 0.0 / 0.2mm/step]
6-113-003	BookletFolderPosAdj:2K/3K FIN	A4 SEF	ENG	[-3.0 to 3.0 / 0.0 / 0.2mm/step]
6-113-004	BookletFolderPosAdj:2K/3K FIN	B5 SEF	ENG	[-3.0 to 3.0 / 0.0 / 0.2mm/step]
6-113-005	BookletFolderPosAdj:2K/3K FIN	DLT SEF	ENG	[-3.0 to 3.0 / 0.0 / 0.2mm/step]
6-113-006	BookletFolderPosAdj:2K/3K FIN	LG SEF	ENG	[-3.0 to 3.0 / 0.0 / 0.2mm/step]
6-113-007	BookletFolderPosAdj:2K/3K FIN	Oficio SEF	ENG	[-3.0 to 3.0 / 0.0 / 0.2mm/step]
6-113-008	BookletFolderPosAdj:2K/3K FIN	LT SEF	ENG	[-3.0 to 3.0 / 0.0 / 0.2mm/step]
6-113-009	BookletFolderPosAdj:2K/3K FIN	12"x18"	ENG	[-3.0 to 3.0 / 0.0 / 0.2mm/step]
6-113-010	BookletFolderPosAdj:2K/3K FIN	8K SEF	ENG	[-3.0 to 3.0 / 0.0 / 0.2mm/step]
6-113-011	BookletFolderPosAdj:2K/3K FIN	Other	ENG	[-3.0 to 3.0 / 0.0 / 0.2mm/step]

3.SP Mode Tables

SP No.	Large Category	Small Category	ENG or CTL	[Min to Max/Init./Step]
6-113-012	BookletFolderPosAdj:2K/3K FIN	A3 SEF(1-5)	ENG	[-3.0 to 3.0 / 0.0 / 0.2mm/step]
6-113-013	BookletFolderPosAdj:2K/3K FIN	A3 SEF(6-10)	ENG	[-3.0 to 3.0 / 0.0 / 0.2mm/step]
6-113-014	BookletFolderPosAdj:2K/3K FIN	A3 SEF(11-15)	ENG	[-3.0 to 3.0 / 0.0 / 0.2mm/step]
6-113-015	BookletFolderPosAdj:2K/3K FIN	A3 SEF(16-over)	ENG	[-3.0 to 3.0 / 0.0 / 0.2mm/step]
6-113-016	BookletFolderPosAdj:2K/3K FIN	B4 SEF(1-5)	ENG	[-3.0 to 3.0 / 0.0 / 0.2mm/step]
6-113-017	BookletFolderPosAdj:2K/3K FIN	B4 SEF(6-10)	ENG	[-3.0 to 3.0 / 0.0 / 0.2mm/step]
6-113-018	BookletFolderPosAdj:2K/3K FIN	B4 SEF(11-15)	ENG	[-3.0 to 3.0 / 0.0 / 0.2mm/step]
6-113-019	BookletFolderPosAdj:2K/3K FIN	B4 SEF(16-over)	ENG	[-3.0 to 3.0 / 0.0 / 0.2mm/step]
6-113-020	BookletFolderPosAdj:2K/3K FIN	A4 SEF(1-5)	ENG	[-3.0 to 3.0 / 0.0 / 0.2mm/step]
6-113-021	BookletFolderPosAdj:2K/3K FIN	A4 SEF(6-10)	ENG	[-3.0 to 3.0 / 0.0 / 0.2mm/step]
6-113-022	BookletFolderPosAdj:2K/3K FIN	A4 SEF(11-15)	ENG	[-3.0 to 3.0 / 0.0 / 0.2mm/step]
6-113-023	BookletFolderPosAdj:2K/3K FIN	A4 SEF(16-over)	ENG	[-3.0 to 3.0 / 0.0 / 0.2mm/step]

3.SP Mode Tables

SP No.	Large Category	Small Category	ENG or CTL	[Min to Max/Init./Step]
6-113-024	BookletFolderPosAdj:2K/3K FIN	B5 SEF(1-5)	ENG	[-3.0 to 3.0 / 0.0 / 0.2mm/step]
6-113-025	BookletFolderPosAdj:2K/3K FIN	B5 SEF(6-10)	ENG	[-3.0 to 3.0 / 0.0 / 0.2mm/step]
6-113-026	BookletFolderPosAdj:2K/3K FIN	B5 SEF(11-15)	ENG	[-3.0 to 3.0 / 0.0 / 0.2mm/step]
6-113-027	BookletFolderPosAdj:2K/3K FIN	B5 SEF(16-over)	ENG	[-3.0 to 3.0 / 0.0 / 0.2mm/step]
6-113-028	BookletFolderPosAdj:2K/3K FIN	DLT SEF(1-5)	ENG	[-3.0 to 3.0 / 0.0 / 0.2mm/step]
6-113-029	BookletFolderPosAdj:2K/3K FIN	DLT SEF(6-10)	ENG	[-3.0 to 3.0 / 0.0 / 0.2mm/step]
6-113-030	BookletFolderPosAdj:2K/3K FIN	DLT SEF(11-15)	ENG	[-3.0 to 3.0 / 0.0 / 0.2mm/step]
6-113-031	BookletFolderPosAdj:2K/3K FIN	DLT SEF(16-over)	ENG	[-3.0 to 3.0 / 0.0 / 0.2mm/step]
6-113-032	BookletFolderPosAdj:2K/3K FIN	LG SEF(1-5)	ENG	[-3.0 to 3.0 / 0.0 / 0.2mm/step]
6-113-033	BookletFolderPosAdj:2K/3K FIN	LG SEF(6-10)	ENG	[-3.0 to 3.0 / 0.0 / 0.2mm/step]
6-113-034	BookletFolderPosAdj:2K/3K FIN	LG SEF(11-15)	ENG	[-3.0 to 3.0 / 0.0 / 0.2mm/step]
6-113-035	BookletFolderPosAdj:2K/3K FIN	LG SEF(16-over)	ENG	[-3.0 to 3.0 / 0.0 / 0.2mm/step]

3.SP Mode Tables

SP No.	Large Category	Small Category	ENG or CTL	[Min to Max/Init./Step]
6-113-036	BookletFolderPosAdj:2K/3K FIN	Oficio SEF(1-5)	ENG	[-3.0 to 3.0 / 0.0 / 0.2mm/step]
6-113-037	BookletFolderPosAdj:2K/3K FIN	Oficio SEF(6-10)	ENG	[-3.0 to 3.0 / 0.0 / 0.2mm/step]
6-113-038	BookletFolderPosAdj:2K/3K FIN	Oficio SEF(11-15)	ENG	[-3.0 to 3.0 / 0.0 / 0.2mm/step]
6-113-039	BookletFolderPosAdj:2K/3K FIN	Oficio SEF(16-over)	ENG	[-3.0 to 3.0 / 0.0 / 0.2mm/step]
6-113-040	BookletFolderPosAdj:2K/3K FIN	LT SEF(1-5)	ENG	[-3.0 to 3.0 / 0.0 / 0.2mm/step]
6-113-041	BookletFolderPosAdj:2K/3K FIN	LT SEF(6-10)	ENG	[-3.0 to 3.0 / 0.0 / 0.2mm/step]
6-113-042	BookletFolderPosAdj:2K/3K FIN	LT SEF(11-15)	ENG	[-3.0 to 3.0 / 0.0 / 0.2mm/step]
6-113-043	BookletFolderPosAdj:2K/3K FIN	LT SEF(16-over)	ENG	[-3.0 to 3.0 / 0.0 / 0.2mm/step]
6-113-044	BookletFolderPosAdj:2K/3K FIN	12"x18"(1-5)	ENG	[-3.0 to 3.0 / 0.0 / 0.2mm/step]
6-113-045	BookletFolderPosAdj:2K/3K FIN	12"x18"(6-10)	ENG	[-3.0 to 3.0 / 0.0 / 0.2mm/step]
6-113-046	BookletFolderPosAdj:2K/3K FIN	12"x18"(11-15)	ENG	[-3.0 to 3.0 / 0.0 / 0.2mm/step]
6-113-047	BookletFolderPosAdj:2K/3K FIN	12"x18"(16-over)	ENG	[-3.0 to 3.0 / 0.0 / 0.2mm/step]

3.SP Mode Tables

SP No.	Large Category	Small Category	ENG or CTL	[Min to Max/Init./Step]
6-113-048	BookletFolderPosAdj:2K/3K FIN	8K SEF(1-5)	ENG	[-3.0 to 3.0 / 0.0 / 0.2mm/step]
6-113-049	BookletFolderPosAdj:2K/3K FIN	8K SEF(6-10)	ENG	[-3.0 to 3.0 / 0.0 / 0.2mm/step]
6-113-050	BookletFolderPosAdj:2K/3K FIN	8K SEF(11-15)	ENG	[-3.0 to 3.0 / 0.0 / 0.2mm/step]
6-113-051	BookletFolderPosAdj:2K/3K FIN	8K SEF(16-over)	ENG	[-3.0 to 3.0 / 0.0 / 0.2mm/step]
6-113-052	BookletFolderPosAdj:2K/3K FIN	Other(1-5)	ENG	[-3.0 to 3.0 / 0.0 / 0.2mm/step]
6-113-053	BookletFolderPosAdj:2K/3K FIN	Other(6-10)	ENG	[-3.0 to 3.0 / 0.0 / 0.2mm/step]
6-113-054	BookletFolderPosAdj:2K/3K FIN	Other(11-15)	ENG	[-3.0 to 3.0 / 0.0 / 0.2mm/step]
6-113-055	BookletFolderPosAdj:2K/3K FIN	Other(16-over)	ENG	[-3.0 to 3.0 / 0.0 / 0.2mm/step]
6-114-001	Fold Speed Adj.: 2K/3K FIN	A3 SEF	ENG	[0 to 2 / 0 / 1/step]
6-114-002	Fold Speed Adj.: 2K/3K FIN	B4 SEF	ENG	[0 to 2 / 0 / 1/step]
6-114-003	Fold Speed Adj.: 2K/3K FIN	A4 SEF	ENG	[0 to 2 / 0 / 1/step]
6-114-004	Fold Speed Adj.: 2K/3K FIN	B5 SEF	ENG	[0 to 2 / 0 / 1/step]

3.SP Mode Tables

SP No.	Large Category	Small Category	ENG or CTL	[Min to Max/Init./Step]
6-114-005	Fold Speed Adj.: 2K/3K FIN	DLT SEF	ENG	[0 to 2 / 0 / 1/step]
6-114-006	Fold Speed Adj.: 2K/3K FIN	LG SEF	ENG	[0 to 2 / 0 / 1/step]
6-114-007	Fold Speed Adj.: 2K/3K FIN	Oficio SEF	ENG	[0 to 2 / 0 / 1/step]
6-114-008	Fold Speed Adj.: 2K/3K FIN	LT SEF	ENG	[0 to 2 / 0 / 1/step]
6-114-009	Fold Speed Adj.: 2K/3K FIN	12"x18"	ENG	[0 to 2 / 0 / 1/step]
6-114-010	Fold Speed Adj.: 2K/3K FIN	8K SEF	ENG	[0 to 2 / 0 / 1/step]
6-114-011	Fold Speed Adj.: 2K/3K FIN	Other	ENG	[0 to 2 / 0 / 1/step]
6-115-001	Finisher Free Run: 2K/3K FIN	Free Run 1	ENG	[0 to 1 / 0 / 1/step]
6-115-002	Finisher Free Run: 2K/3K FIN	Free Run 2	ENG	[0 to 1 / 0 / 1/step]
6-115-003	Finisher Free Run: 2K/3K FIN	Free Run 3	ENG	[0 to 1 / 0 / 1/step]
6-115-004	Finisher Free Run: 2K/3K FIN	Free Run 4	ENG	[0 to 1 / 0 / 1/step]
6-115-005	Finisher Free Run: 2K/3K FIN	Free Run 5	ENG	[0 to 1 / 0 / 1/step]

3.SP Mode Tables

SP No.	Large Category	Small Category	ENG or CTL	[Min to Max/Init./Step]
6-116-001	CmrStplrMxPrstkShAdj:2K/3KFIN	A3 SEF	ENG	[-1 to 0 / 0 / 1sheets/step]
6-116-002	CmrStplrMxPrstkShAdj:2K/3KFIN	B4 SEF	ENG	[-1 to 0 / 0 / 1sheets/step]
6-116-003	CmrStplrMxPrstkShAdj:2K/3KFIN	A4 SEF	ENG	[-1 to 0 / 0 / 1sheets/step]
6-116-004	CmrStplrMxPrstkShAdj:2K/3KFIN	A4 LEF	ENG	[-1 to 0 / 0 / 1sheets/step]
6-116-005	CmrStplrMxPrstkShAdj:2K/3KFIN	B5 SEF	ENG	[-1 to 0 / 0 / 1sheets/step]
6-116-006	CmrStplrMxPrstkShAdj:2K/3KFIN	B5 LEF	ENG	[-1 to 0 / 0 / 1sheets/step]
6-116-007	CmrStplrMxPrstkShAdj:2K/3KFIN	DLT SEF	ENG	[-1 to 0 / 0 / 1sheets/step]
6-116-008	CmrStplrMxPrstkShAdj:2K/3KFIN	LG SEF	ENG	[-1 to 0 / 0 / 1sheets/step]
6-116-009	CmrStplrMxPrstkShAdj:2K/3KFIN	Oficio SEF	ENG	[-1 to 0 / 0 / 1sheets/step]
6-116-010	CmrStplrMxPrstkShAdj:2K/3KFIN	LT SEF	ENG	[-1 to 0 / 0 / 1sheets/step]
6-116-011	CmrStplrMxPrstkShAdj:2K/3KFIN	LT LEF	ENG	[-1 to 0 / 0 / 1sheets/step]
6-116-012	CmrStplrMxPrstkShAdj:2K/3KFIN	8K SEF	ENG	[-1 to 0 / 0 / 1sheets/step]

3.SP Mode Tables

SP No.	Large Category	Small Category	ENG or CTL	[Min to Max/Init./Step]
6-116-013	CmnrStplrMxPrstkShAdj:2K/3KFIN	16K SEF	ENG	[-1 to 0 / 0 / 1sheets/step]
6-116-014	CmnrStplrMxPrstkShAdj:2K/3KFIN	16K LEF	ENG	[-1 to 0 / 0 / 1sheets/step]
6-116-015	CmnrStplrMxPrstkShAdj:2K/3KFIN	Other	ENG	[-1 to 0 / 0 / 1sheets/step]
6-117-001	BookStplrMxPrstkShAdj:2K/3KFIN	A3 SEF	ENG	[-2 to 0 / 0 / 1sheets/step]
6-117-002	BookStplrMxPrstkShAdj:2K/3KFIN	B4 SEF	ENG	[-2 to 0 / 0 / 1sheets/step]
6-117-003	BookStplrMxPrstkShAdj:2K/3KFIN	A4 SEF	ENG	[-2 to 0 / 0 / 1sheets/step]
6-117-004	BookStplrMxPrstkShAdj:2K/3KFIN	B5 SEF	ENG	[-2 to 0 / 0 / 1sheets/step]
6-117-005	BookStplrMxPrstkShAdj:2K/3KFIN	DLT SEF	ENG	[-2 to 0 / 0 / 1sheets/step]
6-117-006	BookStplrMxPrstkShAdj:2K/3KFIN	LG SEF	ENG	[-2 to 0 / 0 / 1sheets/step]
6-117-007	BookStplrMxPrstkShAdj:2K/3KFIN	Oficio SEF	ENG	[-2 to 0 / 0 / 1sheets/step]
6-117-008	BookStplrMxPrstkShAdj:2K/3KFIN	LT SEF	ENG	[-2 to 0 / 0 / 1sheets/step]
6-117-009	BookStplrMxPrstkShAdj:2K/3KFIN	12"x18"	ENG	[-2 to 0 / 0 / 1sheets/step]

3.SP Mode Tables

SP No.	Large Category	Small Category	ENG or CTL	[Min to Max/Init./Step]
6-117-010	BookStplrMxPrstkShAdj:2K/3KFIN	8K SEF	ENG	[-2 to 0 / 0 / 1sheets/step]
6-117-011	BookStplrMxPrstkShAdj:2K/3KFIN	Other	ENG	[-2 to 0 / 0 / 1sheets/step]
6-118-001	CmnrStplrPrstkOffsAdj:2K/3KFIN	A3 SEF	ENG	[-16 to 16 / 0 / 2mm/step]
6-118-002	CmnrStplrPrstkOffsAdj:2K/3KFIN	B4 SEF	ENG	[-16 to 16 / 0 / 2mm/step]
6-118-003	CmnrStplrPrstkOffsAdj:2K/3KFIN	A4 SEF	ENG	[-16 to 16 / 0 / 2mm/step]
6-118-004	CmnrStplrPrstkOffsAdj:2K/3KFIN	A4 LEF	ENG	[-16 to 16 / 0 / 2mm/step]
6-118-005	CmnrStplrPrstkOffsAdj:2K/3KFIN	B5 SEF	ENG	[-16 to 16 / 0 / 2mm/step]
6-118-006	CmnrStplrPrstkOffsAdj:2K/3KFIN	B5 LEF	ENG	[-16 to 16 / 0 / 2mm/step]
6-118-007	CmnrStplrPrstkOffsAdj:2K/3KFIN	DLT SEF	ENG	[-16 to 16 / 0 / 2mm/step]
6-118-008	CmnrStplrPrstkOffsAdj:2K/3KFIN	LG SEF	ENG	[-16 to 16 / 0 / 2mm/step]
6-118-009	CmnrStplrPrstkOffsAdj:2K/3KFIN	Oficio SEF	ENG	[-16 to 16 / 0 / 2mm/step]
6-118-010	CmnrStplrPrstkOffsAdj:2K/3KFIN	LT SEF	ENG	[-16 to 16 / 0 / 2mm/step]

3.SP Mode Tables

SP No.	Large Category	Small Category	ENG or CTL	[Min to Max/Init./Step]
6-118-011	CmnrStplrPrstkOfsAdj:2K/3KFIN	LT LEF	ENG	[-16 to 16 / 0 / 2mm/step]
6-118-012	CmnrStplrPrstkOfsAdj:2K/3KFIN	8K SEF	ENG	[-16 to 16 / 0 / 2mm/step]
6-118-013	CmnrStplrPrstkOfsAdj:2K/3KFIN	16K SEF	ENG	[-16 to 16 / 0 / 2mm/step]
6-118-014	CmnrStplrPrstkOfsAdj:2K/3KFIN	16K LEF	ENG	[-16 to 16 / 0 / 2mm/step]
6-118-015	CmnrStplrPrstkOfsAdj:2K/3KFIN	Other	ENG	[-16 to 16 / 0 / 2mm/step]
6-119-001	BookStplrPrstkOfsAdj:2K/3KFIN	A3 SEF	ENG	[-30 to 30 / 0 / 2mm/step]
6-119-002	BookStplrPrstkOfsAdj:2K/3KFIN	B4 SEF	ENG	[-30 to 30 / 0 / 2mm/step]
6-119-003	BookStplrPrstkOfsAdj:2K/3KFIN	A4 SEF	ENG	[-30 to 30 / 0 / 2mm/step]
6-119-004	BookStplrPrstkOfsAdj:2K/3KFIN	B5 SEF	ENG	[-30 to 30 / 0 / 2mm/step]
6-119-005	BookStplrPrstkOfsAdj:2K/3KFIN	DLT SEF	ENG	[-30 to 30 / 0 / 2mm/step]
6-119-006	BookStplrPrstkOfsAdj:2K/3KFIN	LG SEF	ENG	[-30 to 30 / 0 / 2mm/step]
6-119-007	BookStplrPrstkOfsAdj:2K/3KFIN	Oficio SEF	ENG	[-30 to 30 / 0 / 2mm/step]

3.SP Mode Tables

SP No.	Large Category	Small Category	ENG or CTL	[Min to Max/Init./Step]
6-119-008	BookStplrPrstkOffsAdj:2K/3KFIN	LT SEF	ENG	[-30 to 30 / 0 / 2mm/step]
6-119-009	BookStplrPrstkOffsAdj:2K/3KFIN	12"x18"	ENG	[-30 to 30 / 0 / 2mm/step]
6-119-010	BookStplrPrstkOffsAdj:2K/3KFIN	8K SEF	ENG	[-30 to 30 / 0 / 2mm/step]
6-119-011	BookStplrPrstkOffsAdj:2K/3KFIN	Other	ENG	[-30 to 30 / 0 / 2mm/step]
6-120-001	CrnStpPosExFeedAmtAdj:2K/3KFIN	A3 SEF	ENG	[0 to 30 / 0 / 10mm/step]
6-120-002	CrnStpPosExFeedAmtAdj:2K/3KFIN	B4 SEF	ENG	[0 to 30 / 0 / 10mm/step]
6-120-003	CrnStpPosExFeedAmtAdj:2K/3KFIN	A4 SEF	ENG	[0 to 30 / 0 / 10mm/step]
6-120-004	CrnStpPosExFeedAmtAdj:2K/3KFIN	A4 LEF	ENG	[0 to 30 / 0 / 10mm/step]
6-120-005	CrnStpPosExFeedAmtAdj:2K/3KFIN	B5 SEF	ENG	[0 to 30 / 0 / 10mm/step]
6-120-006	CrnStpPosExFeedAmtAdj:2K/3KFIN	B5 LEF	ENG	[0 to 30 / 0 / 10mm/step]
6-120-007	CrnStpPosExFeedAmtAdj:2K/3KFIN	DLT SEF	ENG	[0 to 30 / 0 / 10mm/step]
6-120-008	CrnStpPosExFeedAmtAdj:2K/3KFIN	LG SEF	ENG	[0 to 30 / 0 / 10mm/step]

3.SP Mode Tables

SP No.	Large Category	Small Category	ENG or CTL	[Min to Max/Init./Step]
6-120-009	CrnStpPosExFeedAmtAdj:2K/3KFIN	Oficio SEF	ENG	[0 to 30 / 0 / 10mm/step]
6-120-010	CrnStpPosExFeedAmtAdj:2K/3KFIN	LT SEF	ENG	[0 to 30 / 0 / 10mm/step]
6-120-011	CrnStpPosExFeedAmtAdj:2K/3KFIN	LT LEF	ENG	[0 to 30 / 0 / 10mm/step]
6-120-012	CrnStpPosExFeedAmtAdj:2K/3KFIN	8K SEF	ENG	[0 to 30 / 0 / 10mm/step]
6-120-013	CrnStpPosExFeedAmtAdj:2K/3KFIN	16K SEF	ENG	[0 to 30 / 0 / 10mm/step]
6-120-014	CrnStpPosExFeedAmtAdj:2K/3KFIN	16K LEF	ENG	[0 to 30 / 0 / 10mm/step]
6-120-015	CrnStpPosExFeedAmtAdj:2K/3KFIN	Other	ENG	[0 to 30 / 0 / 10mm/step]
6-121-001	NV Adj. Data Mod.	Jogger Pos. Factory Adj.	ENG	[-3.0 to 3.0 / 0.0 / 0.5mm/step]
6-121-002	NV Adj. Data Mod.	Folding Pos. Factory Adj.	ENG	[-1.4 to 1.4 / 0.0 / 0.2mm/step]
6-121-003	NV Adj. Data Mod.	Staple Stacking Fence Pos. Factory Adj.	ENG	[-1.0 to 1.0 / 0.0 / 0.2mm/step]
6-122-001	BkFoldJogSolMovAmtAdj:2K/3KFIN	A3 SEF	ENG	[-5 to 5 / 0 / 1mm/step]
6-122-002	BkFoldJogSolMovAmtAdj:2K/3KFIN	B4 SEF	ENG	[-5 to 5 / 0 / 1mm/step]

3.SP Mode Tables

SP No.	Large Category	Small Category	ENG or CTL	[Min to Max/Init./Step]
6-122-003	BkFoldJogSolMovAmtAdj:2K/3KFIN	A4 SEF	ENG	[-5 to 5 / 0 / 1mm/step]
6-122-004	BkFoldJogSolMovAmtAdj:2K/3KFIN	B5 SEF	ENG	[-5 to 5 / 0 / 1mm/step]
6-122-005	BkFoldJogSolMovAmtAdj:2K/3KFIN	DLT SEF	ENG	[-5 to 5 / 0 / 1mm/step]
6-122-006	BkFoldJogSolMovAmtAdj:2K/3KFIN	LG SEF	ENG	[-5 to 5 / 0 / 1mm/step]
6-122-007	BkFoldJogSolMovAmtAdj:2K/3KFIN	Oficio SEF	ENG	[-5 to 5 / 0 / 1mm/step]
6-122-008	BkFoldJogSolMovAmtAdj:2K/3KFIN	LT SEF	ENG	[-5 to 5 / 0 / 1mm/step]
6-122-009	BkFoldJogSolMovAmtAdj:2K/3KFIN	12"x18"	ENG	[-5 to 5 / 0 / 1mm/step]
6-122-010	BkFoldJogSolMovAmtAdj:2K/3KFIN	8K SEF	ENG	[-5 to 5 / 0 / 1mm/step]
6-122-011	BkFoldJogSolMovAmtAdj:2K/3KFIN	Other	ENG	[-5 to 5 / 0 / 1mm/step]
6-125-001	Use Paper Guide(Big Size)	All Size	ENG	[0 to 1 / 0 / 1/step]
6-126-001	Use Paper Guide(Small Size)	All Size	ENG	[0 to 1 / 0 / 1/step]
6-127-001	Paper Guide PossAdj:2K/3K FIN	All Size	ENG	[-10 to 10 / 0 / 1mm/step]

3.SP Mode Tables

SP No.	Large Category	Small Category	ENG or CTL	[Min to Max/Init./Step]
6-128-001	Paper Guide RetraAdj:2K/3K FIN	All Size	ENG	[-50 to 50 / 0 / 5mm/step]
6-129-001	Paper Guide AceptAdj:2K/3K FIN	All Size	ENG	[-50 to 50 / 0 / 5msec/step]
6-130-001	Sub-scan PunchPosAdj:FrontFIN	Domestic 2Hole(Europe 2Hole)	ENG	[-7.5 to 7.5 / 0.0 / 0.5mm/step]
6-130-002	Sub-scan PunchPosAdj:FrontFIN	North America 3Hole	ENG	[-7.5 to 7.5 / 0.0 / 0.5mm/step]
6-130-003	Sub-scan PunchPosAdj:FrontFIN	Europe 4Hole	ENG	[-7.5 to 7.5 / 0.0 / 0.5mm/step]
6-130-004	Sub-scan PunchPosAdj:FrontFIN	North Europe 4Hole	ENG	[-7.5 to 7.5 / 0.0 / 0.5mm/step]
6-130-005	Sub-scan PunchPosAdj:FrontFIN	North America 2Hole	ENG	[-7.5 to 7.5 / 0.0 / 0.5mm/step]
6-131-001	Main-scan PunchPosAdj:FrontFIN	Domestic 2Hole(Europe 2Hole)	ENG	[-2.0 to 2.0 / 0.0 / 0.4mm/step]
6-131-002	Main-scan PunchPosAdj:FrontFIN	North America 3Hole	ENG	[-2.0 to 2.0 / 0.0 / 0.4mm/step]
6-131-003	Main-scan PunchPosAdj:FrontFIN	Europe 4Hole	ENG	[-2.0 to 2.0 / 0.0 / 0.4mm/step]
6-131-004	Main-scan PunchPosAdj:FrontFIN	North Europe 4Hole	ENG	[-2.0 to 2.0 / 0.0 / 0.4mm/step]
6-131-005	Main-scan PunchPosAdj:FrontFIN	North America 2Hole	ENG	[-2.0 to 2.0 / 0.0 / 0.4mm/step]

3.SP Mode Tables

SP No.	Large Category	Small Category	ENG or CTL	[Min to Max/Init./Step]
6-132-001	Jogger Fence Fine Adj:FrontFIN	A3T	ENG	[-1.5 to 1.5 / 0.0 / 0.5mm/step]
6-132-002	Jogger Fence Fine Adj:FrontFIN	B4T	ENG	[-3.0 to 3.0 / 0.0 / 0.5mm/step]
6-132-003	Jogger Fence Fine Adj:FrontFIN	A4T	ENG	[-3.0 to 3.0 / 0.0 / 0.5mm/step]
6-132-004	Jogger Fence Fine Adj:FrontFIN	A4Y	ENG	[-1.5 to 1.5 / 0.0 / 0.5mm/step]
6-132-005	Jogger Fence Fine Adj:FrontFIN	B5T	ENG	[-3.0 to 3.0 / 0.0 / 0.5mm/step]
6-132-006	Jogger Fence Fine Adj:FrontFIN	B5Y	ENG	[-3.0 to 3.0 / 0.0 / 0.5mm/step]
6-132-007	Jogger Fence Fine Adj:FrontFIN	DLT-T	ENG	[-3.0 to 3.0 / 0.0 / 0.5mm/step]
6-132-008	Jogger Fence Fine Adj:FrontFIN	LG-T	ENG	[-3.0 to 3.0 / 0.0 / 0.5mm/step]
6-132-009	Jogger Fence Fine Adj:FrontFIN	Oficio-T	ENG	[-3.0 to 3.0 / 0.0 / 0.5mm/step]
6-132-010	Jogger Fence Fine Adj:FrontFIN	LT-T	ENG	[-3.0 to 3.0 / 0.0 / 0.5mm/step]
6-132-011	Jogger Fence Fine Adj:FrontFIN	LT-Y	ENG	[-3.0 to 3.0 / 0.0 / 0.5mm/step]
6-132-012	Jogger Fence Fine Adj:FrontFIN	8K-T	ENG	[-3.0 to 3.0 / 0.0 / 0.5mm/step]

3.SP Mode Tables

SP No.	Large Category	Small Category	ENG or CTL	[Min to Max/Init./Step]
6-132-013	Jogger Fence Fine Adj:FrontFIN	16K-T	ENG	[-3.0 to 3.0 / 0.0 / 0.5mm/step]
6-132-014	Jogger Fence Fine Adj:FrontFIN	16K-Y	ENG	[-3.0 to 3.0 / 0.0 / 0.5mm/step]
6-132-015	Jogger Fence Fine Adj:FrontFIN	Other	ENG	[-3.0 to 3.0 / 0.0 / 0.5mm/step]
6-133-001	Staple Position Adj: FrontFIN	Finisher1	ENG	[-2.0 to 2.0 / 0.0 / 0.5mm/step]
6-134-001	Finisher Free Run: FrontFIN	Free Run1	ENG	[0 to 1 / 0 / 1/step]
6-134-002	Finisher Free Run: FrontFIN	Free Run2	ENG	[0 to 1 / 0 / 1/step]
6-134-003	Finisher Free Run: FrontFIN	Free Run3	ENG	[0 to 1 / 0 / 1/step]
6-134-004	Finisher Free Run: FrontFIN	Free Run4	ENG	[0 to 1 / 0 / 1/step]
6-137-001	Pos Time Adj: FrontFIN	A3 SEF	ENG	[-100 to 100 / 0 / 1msec/step]
6-137-002	Pos Time Adj: FrontFIN	B4 SEF	ENG	[-100 to 100 / 0 / 1msec/step]
6-137-003	Pos Time Adj: FrontFIN	A4 SEF	ENG	[-100 to 100 / 0 / 1msec/step]
6-137-004	Pos Time Adj: FrontFIN	A4 LEF	ENG	[-100 to 100 / 0 / 1msec/step]

3.SP Mode Tables

SP No.	Large Category	Small Category	ENG or CTL	[Min to Max/Init./Step]
6-137-005	Pos Time Adj: FrontFIN	B5 SEF	ENG	[-100 to 100 / 0 / 1msec/step]
6-137-006	Pos Time Adj: FrontFIN	B5 LEF	ENG	[-100 to 100 / 0 / 1msec/step]
6-137-007	Pos Time Adj: FrontFIN	DLT SEF	ENG	[-100 to 100 / 0 / 1msec/step]
6-137-008	Pos Time Adj: FrontFIN	LG SEF	ENG	[-100 to 100 / 0 / 1msec/step]
6-137-009	Pos Time Adj: FrontFIN	Oficio SEF	ENG	[-100 to 100 / 0 / 1msec/step]
6-137-010	Pos Time Adj: FrontFIN	LT SEF	ENG	[-100 to 100 / 0 / 1msec/step]
6-137-011	Pos Time Adj: FrontFIN	LT LEF	ENG	[-100 to 100 / 0 / 1msec/step]
6-137-012	Pos Time Adj: FrontFIN	8K SEF	ENG	[-100 to 100 / 0 / 1msec/step]
6-137-013	Pos Time Adj: FrontFIN	16K SEF	ENG	[-100 to 100 / 0 / 1msec/step]
6-137-014	Pos Time Adj: FrontFIN	16K LEF	ENG	[-100 to 100 / 0 / 1msec/step]
6-137-015	Pos Time Adj: FrontFIN	Other	ENG	[-100 to 100 / 0 / 1msec/step]
6-140-001	Staple Position Adj: 1K FIN	Staple Stapler	ENG	[-3.5 to 3.5 / 0.0 / 0.5mm/step]

3.SP Mode Tables

SP No.	Large Category	Small Category	ENG or CTL	[Min to Max/Init./Step]
6-140-002	Staple Position Adj: 1K FIN	Stapleless Stapler	ENG	[-3.0 to 3.0 / 0.0 / 0.3mm/step]
6-141-001	Booklet Stapler Pos Adj:1K FIN	A3 SEF	ENG	[-3.0 to 3.0 / 0.0 / 0.2mm/step]
6-141-002	Booklet Stapler Pos Adj:1K FIN	B4 SEF	ENG	[-3.0 to 3.0 / 0.0 / 0.2mm/step]
6-141-003	Booklet Stapler Pos Adj:1K FIN	A4 SEF	ENG	[-3.0 to 3.0 / 0.0 / 0.2mm/step]
6-141-004	Booklet Stapler Pos Adj:1K FIN	B5 SEF	ENG	[-3.0 to 3.0 / 0.0 / 0.2mm/step]
6-141-005	Booklet Stapler Pos Adj:1K FIN	DLT SEF	ENG	[-3.0 to 3.0 / 0.0 / 0.2mm/step]
6-141-006	Booklet Stapler Pos Adj:1K FIN	LG SEF	ENG	[-3.0 to 3.0 / 0.0 / 0.2mm/step]
6-141-007	Booklet Stapler Pos Adj:1K FIN	Oficio SEF	ENG	[-3.0 to 3.0 / 0.0 / 0.2mm/step]
6-141-008	Booklet Stapler Pos Adj:1K FIN	LT SEF	ENG	[-3.0 to 3.0 / 0.0 / 0.2mm/step]
6-141-009	Booklet Stapler Pos Adj:1K FIN	12"x18"	ENG	[-3.0 to 3.0 / 0.0 / 0.2mm/step]
6-142-001	Sub-scan Punch Pos Adj:1K FIN	JPN/EU: 2-Hole	ENG	[-7.5 to 7.5 / 0.0 / 0.5mm/step]
6-142-002	Sub-scan Punch Pos Adj:1K FIN	NA: 3-Hole	ENG	[-7.5 to 7.5 / 0.0 / 0.5mm/step]

3.SP Mode Tables

SP No.	Large Category	Small Category	ENG or CTL	[Min to Max/Init./Step]
6-142-003	Sub-scan Punch Pos Adj:1K FIN	Europe: 4-Hole	ENG	[-7.5 to 7.5 / 0.0 / 0.5mm/step]
6-142-004	Sub-scan Punch Pos Adj:1K FIN	NEU: 4-Hole	ENG	[-7.5 to 7.5 / 0.0 / 0.5mm/step]
6-142-005	Sub-scan Punch Pos Adj:1K FIN	NA: 2-Hole	ENG	[-7.5 to 7.5 / 0.0 / 0.5mm/step]
6-143-001	Jogger Pos Adj:1K FIN	A3 SEF	ENG	[-1.5 to 1.5 / 0.0 / 0.5mm/step]
6-143-002	Jogger Pos Adj:1K FIN	B4 SEF	ENG	[-1.5 to 1.5 / 0.0 / 0.5mm/step]
6-143-003	Jogger Pos Adj:1K FIN	A4 SEF	ENG	[-1.5 to 1.5 / 0.0 / 0.5mm/step]
6-143-004	Jogger Pos Adj:1K FIN	A4 LEF	ENG	[-1.5 to 1.5 / 0.0 / 0.5mm/step]
6-143-005	Jogger Pos Adj:1K FIN	B5 SEF	ENG	[-1.5 to 1.5 / 0.0 / 0.5mm/step]
6-143-006	Jogger Pos Adj:1K FIN	B5 LEF	ENG	[-1.5 to 1.5 / 0.0 / 0.5mm/step]
6-143-007	Jogger Pos Adj:1K FIN	DLT SEF	ENG	[-1.5 to 1.5 / 0.0 / 0.5mm/step]
6-143-008	Jogger Pos Adj:1K FIN	LG SEF	ENG	[-1.5 to 1.5 / 0.0 / 0.5mm/step]
6-143-009	Jogger Pos Adj:1K FIN	Oficio SEF	ENG	[-1.5 to 1.5 / 0.0 / 0.5mm/step]

3.SP Mode Tables

SP No.	Large Category	Small Category	ENG or CTL	[Min to Max/Init./Step]
6-143-010	Jogger Pos Adj:1K FIN	LT SEF	ENG	[-1.5 to 1.5 / 0.0 / 0.5mm/step]
6-143-011	Jogger Pos Adj:1K FIN	LT LEF	ENG	[-1.5 to 1.5 / 0.0 / 0.5mm/step]
6-143-012	Jogger Pos Adj:1K FIN	12"x18"	ENG	[-1.5 to 1.5 / 0.0 / 0.5mm/step]
6-143-013	Jogger Pos Adj:1K FIN	8K SEF	ENG	[-1.5 to 1.5 / 0.0 / 0.5mm/step]
6-143-014	Jogger Pos Adj:1K FIN	16K SEF	ENG	[-1.5 to 1.5 / 0.0 / 0.5mm/step]
6-143-015	Jogger Pos Adj:1K FIN	16K LEF	ENG	[-1.5 to 1.5 / 0.0 / 0.5mm/step]
6-143-016	Jogger Pos Adj:1K FIN	Other	ENG	[-1.5 to 1.5 / 0.0 / 0.5mm/step]
6-144-001	Main-scan Punch Pos Adj:1K FIN	JPN/EU: 2-Hole	ENG	[-2.0 to 2.0 / 0.0 / 0.4mm/step]
6-144-002	Main-scan Punch Pos Adj:1K FIN	NA: 3-Hole	ENG	[-2.0 to 2.0 / 0.0 / 0.4mm/step]
6-144-003	Main-scan Punch Pos Adj:1K FIN	Europe: 4-Hole	ENG	[-2.0 to 2.0 / 0.0 / 0.4mm/step]
6-144-004	Main-scan Punch Pos Adj:1K FIN	NEU: 4-Hole	ENG	[-2.0 to 2.0 / 0.0 / 0.4mm/step]
6-144-005	Main-scan Punch Pos Adj:1K FIN	NA: 2-Hole	ENG	[-2.0 to 2.0 / 0.0 / 0.4mm/step]

3.SP Mode Tables

SP No.	Large Category	Small Category	ENG or CTL	[Min to Max/Init./Step]
6-145-001	Skew Correct Buckle Adj:1K FIN	A3 SEF	ENG	[-5.0 to 5.0 / 0.0 / 0.2mm/step]
6-145-002	Skew Correct Buckle Adj:1K FIN	B4 SEF	ENG	[-5.0 to 5.0 / 0.0 / 0.2mm/step]
6-145-003	Skew Correct Buckle Adj:1K FIN	A4 SEF	ENG	[-5.0 to 5.0 / 0.0 / 0.2mm/step]
6-145-004	Skew Correct Buckle Adj:1K FIN	A4 LEF	ENG	[-5.0 to 5.0 / 0.0 / 0.2mm/step]
6-145-005	Skew Correct Buckle Adj:1K FIN	B5 SEF	ENG	[-5.0 to 5.0 / 0.0 / 0.2mm/step]
6-145-006	Skew Correct Buckle Adj:1K FIN	B5 LEF	ENG	[-5.0 to 5.0 / 0.0 / 0.2mm/step]
6-145-007	Skew Correct Buckle Adj:1K FIN	A5 LEF	ENG	[-5.0 to 5.0 / 0.0 / 0.2mm/step]
6-145-008	Skew Correct Buckle Adj:1K FIN	DLT SEF	ENG	[-5.0 to 5.0 / 0.0 / 0.2mm/step]
6-145-009	Skew Correct Buckle Adj:1K FIN	LG SEF	ENG	[-5.0 to 5.0 / 0.0 / 0.2mm/step]
6-145-010	Skew Correct Buckle Adj:1K FIN	Oficio SEF	ENG	[-5.0 to 5.0 / 0.0 / 0.2mm/step]
6-145-011	Skew Correct Buckle Adj:1K FIN	LT SEF	ENG	[-5.0 to 5.0 / 0.0 / 0.2mm/step]
6-145-012	Skew Correct Buckle Adj:1K FIN	LT LEF	ENG	[-5.0 to 5.0 / 0.0 / 0.2mm/step]

3.SP Mode Tables

SP No.	Large Category	Small Category	ENG or CTL	[Min to Max/Init./Step]
6-145-013	Skew Correct Buckle Adj:1K FIN	HLT LEF	ENG	[-5.0 to 5.0 / 0.0 / 0.2mm/step]
6-145-014	Skew Correct Buckle Adj:1K FIN	12"x18"	ENG	[-5.0 to 5.0 / 0.0 / 0.2mm/step]
6-145-015	Skew Correct Buckle Adj:1K FIN	8K SEF	ENG	[-5.0 to 5.0 / 0.0 / 0.2mm/step]
6-145-016	Skew Correct Buckle Adj:1K FIN	16K SEF	ENG	[-5.0 to 5.0 / 0.0 / 0.2mm/step]
6-145-017	Skew Correct Buckle Adj:1K FIN	16K LEF	ENG	[-5.0 to 5.0 / 0.0 / 0.2mm/step]
6-145-018	Skew Correct Buckle Adj:1K FIN	Other	ENG	[-5.0 to 5.0 / 0.0 / 0.2mm/step]
6-146-001	Skew Correct Ctrl SW:1K FIN	A3 SEF	ENG	[0 to 1 / 0 / 1/step]
6-146-002	Skew Correct Ctrl SW:1K FIN	B4 SEF	ENG	[0 to 1 / 0 / 1/step]
6-146-003	Skew Correct Ctrl SW:1K FIN	A4 SEF	ENG	[0 to 1 / 0 / 1/step]
6-146-004	Skew Correct Ctrl SW:1K FIN	A4 LEF	ENG	[0 to 1 / 0 / 1/step]
6-146-005	Skew Correct Ctrl SW:1K FIN	B5 SEF	ENG	[0 to 1 / 0 / 1/step]
6-146-006	Skew Correct Ctrl SW:1K FIN	B5 LEF	ENG	[0 to 1 / 0 / 1/step]

3.SP Mode Tables

SP No.	Large Category	Small Category	ENG or CTL	[Min to Max/Init./Step]
6-146-007	Skew Correct Ctrl SW:1K FIN	A5 LEF	ENG	[0 to 1 / 0 / 1/step]
6-146-008	Skew Correct Ctrl SW:1K FIN	DLT SEF	ENG	[0 to 1 / 0 / 1/step]
6-146-009	Skew Correct Ctrl SW:1K FIN	LG SEF	ENG	[0 to 1 / 0 / 1/step]
6-146-010	Skew Correct Ctrl SW:1K FIN	Oficio SEF	ENG	[0 to 1 / 0 / 1/step]
6-146-011	Skew Correct Ctrl SW:1K FIN	LT SEF	ENG	[0 to 1 / 0 / 1/step]
6-146-012	Skew Correct Ctrl SW:1K FIN	LT LEF	ENG	[0 to 1 / 0 / 1/step]
6-146-013	Skew Correct Ctrl SW:1K FIN	HLT LEF	ENG	[0 to 1 / 0 / 1/step]
6-146-014	Skew Correct Ctrl SW:1K FIN	12"x18"	ENG	[0 to 1 / 0 / 1/step]
6-146-015	Skew Correct Ctrl SW:1K FIN	8K SEF	ENG	[0 to 1 / 0 / 1/step]
6-146-016	Skew Correct Ctrl SW:1K FIN	16K SEF	ENG	[0 to 1 / 0 / 1/step]
6-146-017	Skew Correct Ctrl SW:1K FIN	16K LEF	ENG	[0 to 1 / 0 / 1/step]
6-146-018	Skew Correct Ctrl SW:1K FIN	Other	ENG	[0 to 1 / 0 / 1/step]

3.SP Mode Tables

SP No.	Large Category	Small Category	ENG or CTL	[Min to Max/Init./Step]
6-147-001	Booklet Folder Pos Adj:1K FIN	A3 SEF	ENG	[-3.0 to 3.0 / 0.0 / 0.2mm/step]
6-147-002	Booklet Folder Pos Adj:1K FIN	B4 SEF	ENG	[-3.0 to 3.0 / 0.0 / 0.2mm/step]
6-147-003	Booklet Folder Pos Adj:1K FIN	A4 SEF	ENG	[-3.0 to 3.0 / 0.0 / 0.2mm/step]
6-147-004	Booklet Folder Pos Adj:1K FIN	B5 SEF	ENG	[-3.0 to 3.0 / 0.0 / 0.2mm/step]
6-147-005	Booklet Folder Pos Adj:1K FIN	DLT SEF	ENG	[-3.0 to 3.0 / 0.0 / 0.2mm/step]
6-147-006	Booklet Folder Pos Adj:1K FIN	LG SEF	ENG	[-3.0 to 3.0 / 0.0 / 0.2mm/step]
6-147-007	Booklet Folder Pos Adj:1K FIN	Oficio SEF	ENG	[-3.0 to 3.0 / 0.0 / 0.2mm/step]
6-147-008	Booklet Folder Pos Adj:1K FIN	LT SEF	ENG	[-3.0 to 3.0 / 0.0 / 0.2mm/step]
6-147-009	Booklet Folder Pos Adj:1K FIN	12"x18"	ENG	[-3.0 to 3.0 / 0.0 / 0.2mm/step]
6-147-010	Booklet Folder Pos Adj:1K FIN	A3 SEF(1-5)	ENG	[-3.0 to 3.0 / 0.0 / 0.2mm/step]
6-147-011	Booklet Folder Pos Adj:1K FIN	A3 SEF(6-10)	ENG	[-3.0 to 3.0 / 0.0 / 0.2mm/step]
6-147-012	Booklet Folder Pos Adj:1K FIN	A3 SEF(11-over)	ENG	[-3.0 to 3.0 / 0.0 / 0.2mm/step]

3.SP Mode Tables

SP No.	Large Category	Small Category	ENG or CTL	[Min to Max/Init./Step]
6-147-013	Booklet Folder Pos Adj:1K FIN	B4 SEF(1-5)	ENG	[-3.0 to 3.0 / 0.0 / 0.2mm/step]
6-147-014	Booklet Folder Pos Adj:1K FIN	B4 SEF(6-10)	ENG	[-3.0 to 3.0 / 0.0 / 0.2mm/step]
6-147-015	Booklet Folder Pos Adj:1K FIN	B4 SEF(11-over)	ENG	[-3.0 to 3.0 / 0.0 / 0.2mm/step]
6-147-016	Booklet Folder Pos Adj:1K FIN	A4 SEF(1-5)	ENG	[-3.0 to 3.0 / 0.0 / 0.2mm/step]
6-147-017	Booklet Folder Pos Adj:1K FIN	A4 SEF(6-10)	ENG	[-3.0 to 3.0 / 0.0 / 0.2mm/step]
6-147-018	Booklet Folder Pos Adj:1K FIN	A4 SEF(11-over)	ENG	[-3.0 to 3.0 / 0.0 / 0.2mm/step]
6-147-019	Booklet Folder Pos Adj:1K FIN	B5 SEF(1-5)	ENG	[-3.0 to 3.0 / 0.0 / 0.2mm/step]
6-147-020	Booklet Folder Pos Adj:1K FIN	B5 SEF(6-10)	ENG	[-3.0 to 3.0 / 0.0 / 0.2mm/step]
6-147-021	Booklet Folder Pos Adj:1K FIN	B5 SEF(11-over)	ENG	[-3.0 to 3.0 / 0.0 / 0.2mm/step]
6-147-022	Booklet Folder Pos Adj:1K FIN	DLT SEF(1-5)	ENG	[-3.0 to 3.0 / 0.0 / 0.2mm/step]
6-147-023	Booklet Folder Pos Adj:1K FIN	DLT SEF(6-10)	ENG	[-3.0 to 3.0 / 0.0 / 0.2mm/step]
6-147-024	Booklet Folder Pos Adj:1K FIN	DLT SEF(11-over)	ENG	[-3.0 to 3.0 / 0.0 / 0.2mm/step]

3.SP Mode Tables

SP No.	Large Category	Small Category	ENG or CTL	[Min to Max/Init./Step]
6-147-025	Booklet Folder Pos Adj:1K FIN	LG SEF(1-5)	ENG	[-3.0 to 3.0 / 0.0 / 0.2mm/step]
6-147-026	Booklet Folder Pos Adj:1K FIN	LG SEF(6-10)	ENG	[-3.0 to 3.0 / 0.0 / 0.2mm/step]
6-147-027	Booklet Folder Pos Adj:1K FIN	LG SEF(11-over)	ENG	[-3.0 to 3.0 / 0.0 / 0.2mm/step]
6-147-028	Booklet Folder Pos Adj:1K FIN	Oficio SEF(1-5)	ENG	[-3.0 to 3.0 / 0.0 / 0.2mm/step]
6-147-029	Booklet Folder Pos Adj:1K FIN	Oficio SEF(6-10)	ENG	[-3.0 to 3.0 / 0.0 / 0.2mm/step]
6-147-030	Booklet Folder Pos Adj:1K FIN	Oficio SEF(11-over)	ENG	[-3.0 to 3.0 / 0.0 / 0.2mm/step]
6-147-031	Booklet Folder Pos Adj:1K FIN	LT SEF(1-5)	ENG	[-3.0 to 3.0 / 0.0 / 0.2mm/step]
6-147-032	Booklet Folder Pos Adj:1K FIN	LT SEF(6-10)	ENG	[-3.0 to 3.0 / 0.0 / 0.2mm/step]
6-147-033	Booklet Folder Pos Adj:1K FIN	LT SEF(11-over)	ENG	[-3.0 to 3.0 / 0.0 / 0.2mm/step]
6-147-034	Booklet Folder Pos Adj:1K FIN	12"x18"(1-5)	ENG	[-3.0 to 3.0 / 0.0 / 0.2mm/step]
6-147-035	Booklet Folder Pos Adj:1K FIN	12"x18"(6-10)	ENG	[-3.0 to 3.0 / 0.0 / 0.2mm/step]
6-147-036	Booklet Folder Pos Adj:1K FIN	12"x18"(11-over)	ENG	[-3.0 to 3.0 / 0.0 / 0.2mm/step]

3.SP Mode Tables

SP No.	Large Category	Small Category	ENG or CTL	[Min to Max/Init./Step]
6-148-001	Fold Times Adj: 1K FIN		ENG	[0 to 29 / 0 / 1sec/step]
6-149-001	Last Paper Pos Time Adj:1K FIN		ENG	[0 to 1 / 0 / 1times/step]
6-150-001	PositioningStrtTimingAdj:1KFIN	A3 SEF	ENG	[-100 to 100 / 0 / 10msec/step]
6-150-002	PositioningStrtTimingAdj:1KFIN	B4 SEF	ENG	[-100 to 100 / 0 / 10msec/step]
6-150-003	PositioningStrtTimingAdj:1KFIN	A4 SEF	ENG	[-100 to 100 / 0 / 10msec/step]
6-150-004	PositioningStrtTimingAdj:1KFIN	A4 LEF	ENG	[-100 to 100 / 0 / 10msec/step]
6-150-005	PositioningStrtTimingAdj:1KFIN	B5 SEF	ENG	[-100 to 100 / 0 / 10msec/step]
6-150-006	PositioningStrtTimingAdj:1KFIN	B5 LEF	ENG	[-100 to 100 / 0 / 10msec/step]
6-150-007	PositioningStrtTimingAdj:1KFIN	DLT SEF	ENG	[-100 to 100 / 0 / 10msec/step]
6-150-008	PositioningStrtTimingAdj:1KFIN	LG SEF	ENG	[-100 to 100 / 0 / 10msec/step]
6-150-009	PositioningStrtTimingAdj:1KFIN	Oficio SEF	ENG	[-100 to 100 / 0 / 10msec/step]
6-150-010	PositioningStrtTimingAdj:1KFIN	LT SEF	ENG	[-100 to 100 / 0 / 10msec/step]

3.SP Mode Tables

SP No.	Large Category	Small Category	ENG or CTL	[Min to Max/Init./Step]
6-150-011	PositioningStrtTimingAdj:1KFIN	LT LEF	ENG	[-100 to 100 / 0 / 10msec/step]
6-150-012	PositioningStrtTimingAdj:1KFIN	12"x18"	ENG	[-100 to 100 / 0 / 10msec/step]
6-150-013	PositioningStrtTimingAdj:1KFIN	8K SEF	ENG	[-100 to 100 / 0 / 10msec/step]
6-150-014	PositioningStrtTimingAdj:1KFIN	16K SEF	ENG	[-100 to 100 / 0 / 10msec/step]
6-150-015	PositioningStrtTimingAdj:1KFIN	16K LEF	ENG	[-100 to 100 / 0 / 10msec/step]
6-150-016	PositioningStrtTimingAdj:1KFIN	Other	ENG	[-100 to 100 / 0 / 10msec/step]
6-151-001	PosTimeAdj(LstPr2ndTime):1KFIN		ENG	[-100 to 100 / 0 / 10msec/step]
6-152-001	PosTiAdj(ExcLstPr3rdTi):1KFIN	A3 SEF	ENG	[-100 to 100 / 0 / 10msec/step]
6-152-002	PosTiAdj(ExcLstPr3rdTi):1KFIN	B4 SEF	ENG	[-100 to 100 / 0 / 10msec/step]
6-152-003	PosTiAdj(ExcLstPr3rdTi):1KFIN	A4 SEF	ENG	[-100 to 100 / 0 / 10msec/step]
6-152-004	PosTiAdj(ExcLstPr3rdTi):1KFIN	A4 LEF	ENG	[-100 to 100 / 0 / 10msec/step]
6-152-005	PosTiAdj(ExcLstPr3rdTi):1KFIN	B5 SEF	ENG	[-100 to 100 / 0 / 10msec/step]

3.SP Mode Tables

SP No.	Large Category	Small Category	ENG or CTL	[Min to Max/Init./Step]
6-152-006	PosTiAdj(ExcLstPr3rdTi):1KFIN	B5 LEF	ENG	[-100 to 100 / 0 / 10msec/step]
6-152-007	PosTiAdj(ExcLstPr3rdTi):1KFIN	DLT SEF	ENG	[-100 to 100 / 0 / 10msec/step]
6-152-008	PosTiAdj(ExcLstPr3rdTi):1KFIN	LG SEF	ENG	[-100 to 100 / 0 / 10msec/step]
6-152-009	PosTiAdj(ExcLstPr3rdTi):1KFIN	Oficio SEF	ENG	[-100 to 100 / 0 / 10msec/step]
6-152-010	PosTiAdj(ExcLstPr3rdTi):1KFIN	LT SEF	ENG	[-100 to 100 / 0 / 10msec/step]
6-152-011	PosTiAdj(ExcLstPr3rdTi):1KFIN	LT LEF	ENG	[-100 to 100 / 0 / 10msec/step]
6-152-012	PosTiAdj(ExcLstPr3rdTi):1KFIN	12"x18"	ENG	[-100 to 100 / 0 / 10msec/step]
6-152-013	PosTiAdj(ExcLstPr3rdTi):1KFIN	8K SEF	ENG	[-100 to 100 / 0 / 10msec/step]
6-152-014	PosTiAdj(ExcLstPr3rdTi):1KFIN	16K SEF	ENG	[-100 to 100 / 0 / 10msec/step]
6-152-015	PosTiAdj(ExcLstPr3rdTi):1KFIN	16K LEF	ENG	[-100 to 100 / 0 / 10msec/step]
6-152-016	PosTiAdj(ExcLstPr3rdTi):1KFIN	Other	ENG	[-100 to 100 / 0 / 10msec/step]
6-154-001	Pos Time Adj By Sheet: 1K FIN	1 - 10 Sheets	ENG	[-100 to 100 / 0 / 10msec/step]

3.SP Mode Tables

SP No.	Large Category	Small Category	ENG or CTL	[Min to Max/Init./Step]
6-154-002	Pos Time Adj By Sheet: 1K FIN	11 - 20 Sheets	ENG	[-100 to 100 / 0 / 10msec/step]
6-154-003	Pos Time Adj By Sheet: 1K FIN	21 - 30 Sheets	ENG	[-100 to 100 / 0 / 10msec/step]
6-154-004	Pos Time Adj By Sheet: 1K FIN	31 - 40 Sheets	ENG	[-100 to 100 / 0 / 10msec/step]
6-154-005	Pos Time Adj By Sheet: 1K FIN	41 - 50 Sheets	ENG	[-100 to 100 / 0 / 10msec/step]
6-155-001	Paper Guide Poss Adj: 1K FIN		ENG	[-10 to 10 / 0 / 1mm/step]
6-156-001	Paper Guide Retra Adj: 1K FIN		ENG	[-50 to 50 / 0 / 5mm/step]
6-157-001	Paper Guide Acept Adj: 1K FIN		ENG	[-50 to 50 / 0 / 5msec/step]
6-158-001	Bind Speed Setting: 1K FIN_HY		ENG	[1 to 3 / 3 / 2/step]
6-159-001	Bind Times: 1K FIN_HY		ENG*	[1 to 2 / 2 / 1/step]
6-160-001	Finisher Free Run: 1K FIN	Free Run 1	ENG	[0 to 1 / 0 / 1/step]
6-160-002	Finisher Free Run: 1K FIN	Free Run 2	ENG	[0 to 1 / 0 / 1/step]
6-160-003	Finisher Free Run: 1K FIN	Free Run 3	ENG	[0 to 1 / 0 / 1/step]

3.SP Mode Tables

SP No.	Large Category	Small Category	ENG or CTL	[Min to Max/Init./Step]
6-160-004	Finisher Free Run: 1K FIN	Maintenance Part Positioning Free Run	ENG	[0 to 1 / 0 / 1/step]
6-163-001	Use Paper Guide	Big Size	ENG	[0 to 1 / 1 / 1/step]
6-163-002	Use Paper Guide	Small Size	ENG	[0 to 1 / 0 / 1/step]
6-164-001	NV Adj. Data Mod. 1KShtFIN	Jogger Pos. Factory Adj.	ENG	[-1.5 to 1.5 / 0.0 / 0.5mm/step]
6-164-002	NV Adj. Data Mod. 1KShtFIN	Stapling Pos. Factory Adj.	ENG	[-2.0 to 2.0 / 0.0 / 0.5mm/step]
6-164-003	NV Adj. Data Mod. 1KShtFIN HY	Stapling Pos. Factory Adj. (HY)	ENG	[-2.1 to 2.1 / 0.0 / 0.3mm/step]
6-164-004	NV Adj. Data Mod. 1KShtFIN HY	Stapleless Stapling Pos. Factory Adj.	ENG	[-2.1 to 2.1 / 0.0 / 0.3mm/step]
6-164-005	NV Adj. Data Mod. 1KShtFIN	Folding Pos. Factory Adj.	ENG	[-2.0 to 2.0 / 0.0 / 0.1mm/step]
6-164-006	NV Adj. Data Mod. 1KShtFIN	Booklet Stapler Pos. Factory Adj.	ENG	[-3.0 to 3.0 / 0.0 / 0.1mm/step]
6-180-001	M-ScanBindPosAdj:NoStplBindFIN		ENG	[-1.0 to 1.0 / 0.0 / 0.5mm/step]
6-182-001	ExitSpeedSwitch:NoStplBindFIN	PaperLength:297.0-457.2mm,Thick(106-300g/m2)	ENG	[0 to 4 / 1 / 1/step]
6-182-002	ExitSpeedSwitch:NoStplBindFIN	PaperLength:297.0-457.2mm,Plain(60-105g/m2)	ENG	[0 to 4 / 1 / 1/step]

3.SP Mode Tables

SP No.	Large Category	Small Category	ENG or CTL	[Min to Max/Init./Step]
6-182-003	ExitSpeedSwitch:NoStplBindFIN	PaperLength:297.0-457.2mm,Thin(52-59g/m2)	ENG	[0 to 4 / 3 / 1/step]
6-182-004	ExitSpeedSwitch:NoStplBindFIN	PaperLength:210.0-296.9mm,Thick(106-300g/m2)	ENG	[0 to 4 / 1 / 1/step]
6-182-005	ExitSpeedSwitch:NoStplBindFIN	PaperLength:210.0-296.9mm,Plain(60-105g/m2)	ENG	[0 to 4 / 1 / 1/step]
6-182-006	ExitSpeedSwitch:NoStplBindFIN	PaperLength:210.0-296.9mm,Thin(52-59g/m2)	ENG	[0 to 4 / 3 / 1/step]
6-182-007	ExitSpeedSwitch:NoStplBindFIN	PaperLength:148.0-209.9mm,Thick(106-300g/m2)	ENG	[0 to 4 / 1 / 1/step]
6-182-008	ExitSpeedSwitch:NoStplBindFIN	PaperLength:148.0-209.9mm,Plain(60-105g/m2)	ENG	[0 to 4 / 1 / 1/step]
6-182-009	ExitSpeedSwitch:NoStplBindFIN	PaperLength:148.0-209.9mm,Thin(52-59g/m2)	ENG	[0 to 4 / 3 / 1/step]
6-183-001	FinisherFreeRun:NoStplBindFIN	Free Run 1	ENG	[0 to 1 / 0 / 0/step]
6-183-002	FinisherFreeRun:NoStplBindFIN	Free Run 2	ENG	[0 to 1 / 0 / 0/step]
6-183-003	FinisherFreeRun:NoStplBindFIN	Free Run 3	ENG	[0 to 1 / 0 / 0/step]
6-186-001	BindTimes NoStplBindFIN		ENG*	[1 to 2 / 2 / 1/step]
6-301-001	Z-Fold:FineAdj 1st	A3 SEF	ENG	[-4.0 to 4.0 / 0.0 / 0.1mm/step]

3.SP Mode Tables

SP No.	Large Category	Small Category	ENG or CTL	[Min to Max/Init./Step]
6-301-002	Z-Fold:FineAdj 1st	B4 SEF	ENG	[-4.0 to 4.0 / 0.0 / 0.1mm/step]
6-301-003	Z-Fold:FineAdj 1st	A4 SEF	ENG	[-4.0 to 4.0 / 0.0 / 0.1mm/step]
6-301-004	Z-Fold:FineAdj 1st	DLT SEF	ENG	[-4.0 to 4.0 / 0.0 / 0.1mm/step]
6-301-005	Z-Fold:FineAdj 1st	LG SEF	ENG	[-4.0 to 4.0 / 0.0 / 0.1mm/step]
6-301-006	Z-Fold:FineAdj 1st	LT SEF	ENG	[-4.0 to 4.0 / 0.0 / 0.1mm/step]
6-301-007	Z-Fold:FineAdj 1st	8K SEF	ENG	[-4.0 to 4.0 / 0.0 / 0.1mm/step]
6-301-008	Z-Fold:FineAdj 1st	Oficio SEF	ENG	[-4.0 to 4.0 / 0.0 / 0.1mm/step]
6-301-009	Z-Fold:FineAdj 1st	Other	ENG	[-4.0 to 4.0 / 0.0 / 0.1mm/step]
6-302-001	Z-Fold:FineAdj 2nd	A3 SEF	ENG	[-4.0 to 4.0 / 0.0 / 0.2mm/step]
6-302-002	Z-Fold:FineAdj 2nd	B4 SEF	ENG	[-4.0 to 4.0 / 0.0 / 0.2mm/step]
6-302-003	Z-Fold:FineAdj 2nd	A4 SEF	ENG	[-4.0 to 4.0 / 0.0 / 0.2mm/step]
6-302-004	Z-Fold:FineAdj 2nd	DLT SEF	ENG	[-4.0 to 4.0 / 0.0 / 0.2mm/step]

3.SP Mode Tables

SP No.	Large Category	Small Category	ENG or CTL	[Min to Max/Init./Step]
6-302-005	Z-Fold:FineAdj 2nd	LG SEF	ENG	[-4.0 to 4.0 / 0.0 / 0.2mm/step]
6-302-006	Z-Fold:FineAdj 2nd	LT SEF	ENG	[-4.0 to 4.0 / 0.0 / 0.2mm/step]
6-302-007	Z-Fold:FineAdj 2nd	8K SEF	ENG	[-4.0 to 4.0 / 0.0 / 0.2mm/step]
6-302-008	Z-Fold:FineAdj 2nd	Oficio SEF	ENG	[-4.0 to 4.0 / 0.0 / 0.2mm/step]
6-302-009	Z-Fold:FineAdj 2nd	Other	ENG	[-4.0 to 4.0 / 0.0 / 0.2mm/step]
6-304-001	Equal 1/2:FineAdjFld	A3 SEF	ENG	[-4.0 to 4.0 / 0.0 / 0.1mm/step]
6-304-002	Equal 1/2:FineAdjFld	B4 SEF	ENG	[-4.0 to 4.0 / 0.0 / 0.1mm/step]
6-304-003	Equal 1/2:FineAdjFld	A4 SEF	ENG	[-4.0 to 4.0 / 0.0 / 0.1mm/step]
6-304-004	Equal 1/2:FineAdjFld	DLT SEF	ENG	[-4.0 to 4.0 / 0.0 / 0.1mm/step]
6-304-005	Equal 1/2:FineAdjFld	LG SEF	ENG	[-4.0 to 4.0 / 0.0 / 0.1mm/step]
6-304-006	Equal 1/2:FineAdjFld	LT SEF	ENG	[-4.0 to 4.0 / 0.0 / 0.1mm/step]
6-304-007	Equal 1/2:FineAdjFld	8K SEF	ENG	[-4.0 to 4.0 / 0.0 / 0.1mm/step]

3.SP Mode Tables

SP No.	Large Category	Small Category	ENG or CTL	[Min to Max/Init./Step]
6-304-008	Equal 1/2:FineAdjFld	12x18inch	ENG	[-4.0 to 4.0 / 0.0 / 0.1mm/step]
6-304-009	Equal 1/2:FineAdjFld	Oficio SEF	ENG	[-4.0 to 4.0 / 0.0 / 0.1mm/step]
6-304-010	Equal 1/2:FineAdjFld	Other	ENG	[-4.0 to 4.0 / 0.0 / 0.1mm/step]
6-307-001	Equal 3rds:Fine Adj 1st	A3 SEF	ENG	[-4.0 to 4.0 / 0.0 / 0.1mm/step]
6-307-002	Equal 3rds:Fine Adj 1st	DLT SEF	ENG	[-4.0 to 4.0 / 0.0 / 0.1mm/step]
6-307-003	Equal 3rds:Fine Adj 1st	A4 SEF	ENG	[-4.0 to 4.0 / 0.0 / 0.1mm/step]
6-307-004	Equal 3rds:Fine Adj 1st	LG SEF	ENG	[-4.0 to 4.0 / 0.0 / 0.1mm/step]
6-307-005	Equal 3rds:Fine Adj 1st	LT SEF	ENG	[-4.0 to 4.0 / 0.0 / 0.1mm/step]
6-307-006	Equal 3rds:Fine Adj 1st	Oficio SEF	ENG	[-4.0 to 4.0 / 0.0 / 0.1mm/step]
6-307-007	Equal 3rds:Fine Adj 1st	Other	ENG	[-4.0 to 4.0 / 0.0 / 0.1mm/step]
6-308-001	Equal 3rds:Fine Adj 2nd	A3 SEF	ENG	[-4.0 to 4.0 / 0.0 / 0.1mm/step]
6-308-002	Equal 3rds:Fine Adj 2nd	DLT SEF	ENG	[-4.0 to 4.0 / 0.0 / 0.1mm/step]

3.SP Mode Tables

SP No.	Large Category	Small Category	ENG or CTL	[Min to Max/Init./Step]
6-308-003	Equal 3rds:Fine Adj 2nd	A4 SEF	ENG	[-4.0 to 4.0 / 0.0 / 0.1mm/step]
6-308-004	Equal 3rds:Fine Adj 2nd	LG SEF	ENG	[-4.0 to 4.0 / 0.0 / 0.1mm/step]
6-308-005	Equal 3rds:Fine Adj 2nd	LT SEF	ENG	[-4.0 to 4.0 / 0.0 / 0.1mm/step]
6-308-006	Equal 3rds:Fine Adj 2nd	Oficio SEF	ENG	[-4.0 to 4.0 / 0.0 / 0.1mm/step]
6-308-007	Equal 3rds:Fine Adj 2nd	Other	ENG	[-4.0 to 4.0 / 0.0 / 0.1mm/step]
6-311-001	3rds 1 Flap:Fine Adj 1st	A3 SEF	ENG	[-4.0 to 4.0 / 0.0 / 0.1mm/step]
6-311-002	3rds 1 Flap:Fine Adj 1st	DLT SEF	ENG	[-4.0 to 4.0 / 0.0 / 0.1mm/step]
6-311-003	3rds 1 Flap:Fine Adj 1st	A4 SEF	ENG	[-4.0 to 4.0 / 0.0 / 0.1mm/step]
6-311-004	3rds 1 Flap:Fine Adj 1st	LG SEF	ENG	[-4.0 to 4.0 / 0.0 / 0.1mm/step]
6-311-005	3rds 1 Flap:Fine Adj 1st	LT SEF	ENG	[-4.0 to 4.0 / 0.0 / 0.1mm/step]
6-311-006	3rds 1 Flap:Fine Adj 1st	Oficio SEF	ENG	[-4.0 to 4.0 / 0.0 / 0.1mm/step]
6-311-007	3rds 1 Flap:Fine Adj 1st	Other	ENG	[-4.0 to 4.0 / 0.0 / 0.1mm/step]

3.SP Mode Tables

SP No.	Large Category	Small Category	ENG or CTL	[Min to Max/Init./Step]
6-312-001	3rds 1 Flap:Fine Adj 2nd	A3 SEF	ENG	[-4.0 to 4.0 / 0.0 / 0.1mm/step]
6-312-002	3rds 1 Flap:Fine Adj 2nd	DLT SEF	ENG	[-4.0 to 4.0 / 0.0 / 0.1mm/step]
6-312-003	3rds 1 Flap:Fine Adj 2nd	A4 SEF	ENG	[-4.0 to 4.0 / 0.0 / 0.1mm/step]
6-312-004	3rds 1 Flap:Fine Adj 2nd	LG SEF	ENG	[-4.0 to 4.0 / 0.0 / 0.1mm/step]
6-312-005	3rds 1 Flap:Fine Adj 2nd	LT SEF	ENG	[-4.0 to 4.0 / 0.0 / 0.1mm/step]
6-312-006	3rds 1 Flap:Fine Adj 2nd	Oficio SEF	ENG	[-4.0 to 4.0 / 0.0 / 0.1mm/step]
6-312-007	3rds 1 Flap:Fine Adj 2nd	Other	ENG	[-4.0 to 4.0 / 0.0 / 0.1mm/step]
6-313-001	Registration Buckle Adjust	A3 SEF	ENG	[0.0 to 5.0 / 2.0 / 0.5mm/step]
6-313-002	Registration Buckle Adjust	B4 SEF	ENG	[0.0 to 5.0 / 2.0 / 0.5mm/step]
6-313-003	Registration Buckle Adjust	A4 SEF	ENG	[0.0 to 5.0 / 2.0 / 0.5mm/step]
6-313-004	Registration Buckle Adjust	DLT SEF	ENG	[0.0 to 5.0 / 2.0 / 0.5mm/step]
6-313-005	Registration Buckle Adjust	LG SEF	ENG	[0.0 to 5.0 / 2.0 / 0.5mm/step]

3.SP Mode Tables

SP No.	Large Category	Small Category	ENG or CTL	[Min to Max/Init./Step]
6-313-006	Registration Buckle Adjust	LT SEF	ENG	[0.0 to 5.0 / 2.0 / 0.5mm/step]
6-313-007	Registration Buckle Adjust	8K SEF	ENG	[0.0 to 5.0 / 2.0 / 0.5mm/step]
6-313-008	Registration Buckle Adjust	12x18inch	ENG	[0.0 to 5.0 / 2.0 / 0.5mm/step]
6-313-009	Registration Buckle Adjust	Oficio SEF	ENG	[0.0 to 5.0 / 2.0 / 0.5mm/step]
6-313-010	Registration Buckle Adjust	Other	ENG	[0.0 to 5.0 / 2.0 / 0.5mm/step]
6-314-001	Registration Buckle Select		ENG	[0 to 1 / 0 / 1/step]
6-315-001	Set Number of Creasing		ENG	[0 to 4 / 1 / 1times/step]
6-316-001	Silent Mode Select		ENG	[0 to 1 / 0 / 1/step]
6-317-001	Not Fold Exit Speed	Plain: Large-Size	ENG	[0 to 4 / 3 / 1/step]
6-317-002	Not Fold Exit Speed	Plain: Middle-Size	ENG	[0 to 4 / 3 / 1/step]
6-317-003	Not Fold Exit Speed	Plain: Small-Size	ENG	[0 to 4 / 0 / 1/step]
6-317-004	Not Fold Exit Speed	Thick: Large-Size	ENG	[0 to 4 / 2 / 1/step]

3.SP Mode Tables

SP No.	Large Category	Small Category	ENG or CTL	[Min to Max/Init./Step]
6-317-005	Not Fold Exit Speed	Thick: Middle-Size	ENG	[0 to 4 / 2 / 1/step]
6-317-006	Not Fold Exit Speed	Thick: Small-Size	ENG	[0 to 4 / 2 / 1/step]
6-317-007	Not Fold Exit Speed	Thin: Large-Size	ENG	[0 to 4 / 4 / 1/step]
6-317-008	Not Fold Exit Speed	Thin: Middle-Size	ENG	[0 to 4 / 4 / 1/step]
6-317-009	Not Fold Exit Speed	Thin: Small-Size	ENG	[0 to 4 / 0 / 1/step]
6-317-010	Not Fold Exit Speed	Plain: Long-Size	ENG	[0 to 4 / 1 / 1/step]
6-317-011	Not Fold Exit Speed	Thick: Long-Size	ENG	[0 to 4 / 2 / 1/step]
6-317-012	Not Fold Exit Speed	Thin: Long-Size	ENG	[0 to 4 / 3 / 1/step]
6-318-001	Z-Fold Exit Speed	Plain: Large-Size	ENG	[0 to 4 / 2 / 1/step]
6-318-002	Z-Fold Exit Speed	Plain: Middle-Size	ENG	[0 to 4 / 2 / 1/step]
6-318-003	Z-Fold Exit Speed	Plain: Small-Size	ENG	[0 to 4 / 2 / 1/step]
6-319-001	Equal 1/2 Exit Speed	Plain: Large-Size	ENG	[0 to 4 / 2 / 1/step]

3.SP Mode Tables

SP No.	Large Category	Small Category	ENG or CTL	[Min to Max/Init./Step]
6-319-002	Equal 1/2 Exit Speed	Plain: Middle-Size	ENG	[0 to 4 / 2 / 1/step]
6-319-003	Equal 1/2 Exit Speed	Plain: Small-Size	ENG	[0 to 4 / 2 / 1/step]
6-320-001	Equal 3rds Exit Speed	Plain: Large-Size	ENG	[0 to 4 / 2 / 1/step]
6-320-002	Equal 3rds Exit Speed	Plain: Middle-Size	ENG	[0 to 4 / 2 / 1/step]
6-320-003	Equal 3rds Exit Speed	Plain: Small-Size	ENG	[0 to 4 / 2 / 1/step]
6-321-001	3rds 1 Flap Exit Fold	Plain: Large-Size	ENG	[0 to 4 / 2 / 1/step]
6-321-002	3rds 1 Flap Exit Fold	Plain: Middle-Size	ENG	[0 to 4 / 2 / 1/step]
6-321-003	3rds 1 Flap Exit Fold	Plain: Small-Size	ENG	[0 to 4 / 2 / 1/step]
6-324-001	NV Adj. Data Mod.	1st Fold Pos. Factory Setting	ENG	[-3.0 to 3.0 / 0.0 / 0.1mm/step]
6-324-002	NV Adj. Data Mod.	2nd Fold Pos. Factory Setting	ENG	[-3.0 to 3.0 / 0.0 / 0.1mm/step]
6-324-003	NV Adj. Data Mod.	Crease Pos. Factory Setting	ENG	[-3.0 to 3.0 / 0.0 / 0.1mm/step]
6-325-001	Folder. Free Run	Free Run1(Not Fold)	ENG	[0 to 1 / 0 / 1/step]

3.SP Mode Tables

SP No.	Large Category	Small Category	ENG or CTL	[Min to Max/Init./Step]
6-325-002	Folder. Free Run	Free Run2(Z-Fold)	ENG	[0 to 1 / 0 / 1/step]
6-325-003	Folder. Free Run	Free Run3(Equal 1/2)	ENG	[0 to 1 / 0 / 1/step]
6-325-004	Folder. Free Run	Free Run4(Equal 3rds)	ENG	[0 to 1 / 0 / 1/step]
6-325-005	Folder. Free Run	Free Run5(3rds 1 Flap)	ENG	[0 to 1 / 0 / 1/step]
6-326-001	Z-Fold Full Detact Adjust	Large Size	ENG	[-1.0 to 1.0 / 0.0 / 0.2v/step]
6-326-002	Z-Fold Full Detact Adjust	Middle Size	ENG	[-1.0 to 1.0 / 0.0 / 0.2v/step]
6-326-003	Z-Fold Full Detact Adjust	Small Size	ENG	[-1.0 to 1.0 / 0.0 / 0.2v/step]
6-327-001	Equal 1/2 Full Detact Adjust	Large Size	ENG	[-1.0 to 1.0 / 0.0 / 0.2v/step]
6-327-002	Equal 1/2 Full Detact Adjust	Middle Size	ENG	[-1.0 to 1.0 / 0.0 / 0.2v/step]
6-327-003	Equal 1/2 Full Detact Adjust	Small Size	ENG	[-1.0 to 1.0 / 0.0 / 0.2v/step]
6-795-001	Staple N.E. Setting 1KShtFIN	Near-End Threshold	ENG	[0 to 5000 / 500 / 100staples/step]
6-795-002	Staple N.E. Setting 1KShtFIN	Staple Remaining Setting	ENG	[0 to 5000 / 0 / 1staples/step]

3.SP Mode Tables

SP No.	Large Category	Small Category	ENG or CTL	[Min to Max/Init./Step]
6-795-003	Staple N.E. Setting 1KShtFIN	Anomaly Near-End Disp. Clear Setting	ENG	[0 to 1 / 0 / 1/step]
6-796-001	Staple N.E. Setting:2K/3K FIN	Near-End Threshold(CmnrStplr)	ENG	[0 to 5000 / 800 / 100staples/step]
6-796-002	Staple N.E. Setting:2K/3K FIN	Staple Remaining Setting(CmnrStplr)	ENG	[0 to 5000 / 0 / 1staples/step]
6-796-003	Staple N.E. Setting:2K/3K FIN	Near-End Threshold(BookStplr Front)	ENG	[0 to 2000 / 300 / 100staples/step]
6-796-004	Staple N.E. Setting:2K/3K FIN	Staple Remaining Setting(BookStplr Front)	ENG	[0 to 2000 / 0 / 1staples/step]
6-796-005	Staple N.E. Setting:2K/3K FIN	Near-End Threshold(BookStplr Rear)	ENG	[0 to 2000 / 300 / 100staples/step]
6-796-006	Staple N.E. Setting:2K/3K FIN	Staple Remaining Setting(BookStplr Rear)	ENG	[0 to 2000 / 0 / 1staples/step]
6-796-007	Staple N.E. Setting:2K/3K FIN	Anomaly Near-End Disp. Clear Setting	ENG	[0 to 1 / 0 / 1/step]
6-799-010	MachineSerial Display	ADF	ENG	[0 to 255 / 0 / 1/step]
6-799-020	MachineSerial Display	Bank	ENG	[0 to 255 / 0 / 1/step]
6-799-030	MachineSerial Display	LCT	ENG	[0 to 255 / 0 / 1/step]
6-799-040	MachineSerial Display	Finisher	ENG	[0 to 255 / 0 / 1/step]

3.SP Mode Tables

SP No.	Large Category	Small Category	ENG or CTL	[Min to Max/Init./Step]
6-799-050	MachineSerial Display	Folder	ENG	[0 to 255 / 0 / 1/step]
6-801-001	1-pass Stamp Unit		ENG*	[0 to 1 / 0 / 1/step]
6-900-001	ADF Bottom Plate Setting		ENG*	[0 to 1 / 0 / 1/step]
6-901-001	ADF Operation Setting		ENG	[0 to 1 / 0 / 1/step]
6-901-002	ADF Operation Setting	Stack Mode	ENG	[0 to 1 / 0 / 1/step]

Engine SP Tables-7

SP7-XXX (Data Log)

SP No.	Large Category	Small Category	ENG or CTL	[Min to Max/Init./Step]
7-621-002	PM Counter Display: Pages	# PCU:K	ENG	[0 to 99999999 / 0 / 1page/step]
7-621-003	PM Counter Display: Pages	# Dev Unit:K	ENG*	[0 to 99999999 / 0 / 1page/step]
7-621-004	PM Counter Display: Pages	Developer:K	ENG	[0 to 99999999 / 0 / 1page/step]
7-621-025	PM Counter Display: Pages	# PCU:C	ENG	[0 to 99999999 / 0 / 1page/step]
7-621-026	PM Counter Display: Pages	# Dev Unit:C	ENG*	[0 to 99999999 / 0 / 1page/step]

3.SP Mode Tables

SP No.	Large Category	Small Category	ENG or CTL	[Min to Max/Init./Step]
7-621-027	PM Counter Display: Pages	Developer:C	ENG	[0 to 99999999 / 0 / 1page/step]
7-621-048	PM Counter Display: Pages	# PCU:M	ENG	[0 to 99999999 / 0 / 1page/step]
7-621-049	PM Counter Display: Pages	# Dev Unit:M	ENG*	[0 to 99999999 / 0 / 1page/step]
7-621-050	PM Counter Display: Pages	Developer:M	ENG	[0 to 99999999 / 0 / 1page/step]
7-621-071	PM Counter Display: Pages	# PCU:Y	ENG	[0 to 99999999 / 0 / 1page/step]
7-621-072	PM Counter Display: Pages	# Dev Unit:Y	ENG*	[0 to 99999999 / 0 / 1page/step]
7-621-073	PM Counter Display: Pages	Developer:Y	ENG	[0 to 99999999 / 0 / 1page/step]
7-621-093	PM Counter Display: Pages	# ITB Unit	ENG	[0 to 99999999 / 0 / 1page/step]
7-621-102	PM Counter Display: Pages	# ITB Cleaning Unit	ENG	[0 to 99999999 / 0 / 1page/step]
7-621-109	PM Counter Display: Pages	# PTR Unit	ENG	[0 to 99999999 / 0 / 1page/step]
7-621-115	PM Counter Display: Pages	# Fusing Unit	ENG	[0 to 99999999 / 0 / 1page/step]
7-621-116	PM Counter Display: Pages	Fusing Belt	ENG	[0 to 99999999 / 0 / 1page/step]

3.SP Mode Tables

SP No.	Large Category	Small Category	ENG or CTL	[Min to Max/Init./Step]
7-621-118	PM Counter Display: Pages	Pressure Roller	ENG	[0 to 99999999 / 0 / 1page/step]
7-621-131	PM Counter Display: Pages	Dust Filter	ENG	[0 to 99999999 / 0 / 1page/step]
7-621-142	PM Counter Display: Pages	Waste Toner Bottle	ENG	[0 to 999999999 / 0 / 1mg/step]
7-621-206	PM Counter Display: Pages	ADF Pick-up Roller	ENG	[0 to 99999999 / 0 / 1page/step]
7-621-207	PM Counter Display: Pages	ADF Supply Belt	ENG	[0 to 99999999 / 0 / 1page/step]
7-621-208	PM Counter Display: Pages	ADF Reverse Roller	ENG	[0 to 99999999 / 0 / 1page/step]
7-622-002	PM Counter Reset	# PCU:K	ENG	[0 to 1 / 0 / 1/step]
7-622-003	PM Counter Reset	# Dev Unit:K	ENG	[0 to 1 / 0 / 1/step]
7-622-004	PM Counter Reset	Developer:K	ENG	[0 to 1 / 0 / 1/step]
7-622-025	PM Counter Reset	# PCU:C	ENG	[0 to 1 / 0 / 1/step]
7-622-026	PM Counter Reset	# Dev Unit:C	ENG	[0 to 1 / 0 / 1/step]
7-622-027	PM Counter Reset	Developer:C	ENG	[0 to 1 / 0 / 1/step]

3.SP Mode Tables

SP No.	Large Category	Small Category	ENG or CTL	[Min to Max/Init./Step]
7-622-048	PM Counter Reset	# PCU:M	ENG	[0 to 1 / 0 / 1/step]
7-622-049	PM Counter Reset	# Dev Unit:M	ENG	[0 to 1 / 0 / 1/step]
7-622-050	PM Counter Reset	Developer:M	ENG	[0 to 1 / 0 / 1/step]
7-622-071	PM Counter Reset	# PCU:Y	ENG	[0 to 1 / 0 / 1/step]
7-622-072	PM Counter Reset	# Dev Unit:Y	ENG	[0 to 1 / 0 / 1/step]
7-622-073	PM Counter Reset	Developer:Y	ENG	[0 to 1 / 0 / 1/step]
7-622-093	PM Counter Reset	# ITB Unit	ENG	[0 to 1 / 0 / 1/step]
7-622-102	PM Counter Reset	# ITB Cleaning Unit	ENG	[0 to 1 / 0 / 1/step]
7-622-109	PM Counter Reset	# PTR Unit	ENG	[0 to 1 / 0 / 1/step]
7-622-115	PM Counter Reset	# Fusing Unit	ENG	[0 to 1 / 0 / 1/step]
7-622-116	PM Counter Reset	Fusing Belt	ENG	[0 to 1 / 0 / 1/step]
7-622-118	PM Counter Reset	Pressure Roller	ENG	[0 to 1 / 0 / 1/step]

3.SP Mode Tables

SP No.	Large Category	Small Category	ENG or CTL	[Min to Max/Init./Step]
7-622-131	PM Counter Reset	Dust Filter	ENG	[0 to 1 / 0 / 1/step]
7-622-206	PM Counter Reset	ADF Pick-up Roller	ENG	[0 to 1 / 0 / 1/step]
7-622-207	PM Counter Reset	ADF Supply Belt	ENG	[0 to 1 / 0 / 1/step]
7-622-208	PM Counter Reset	ADF Reverse Roller	ENG	[0 to 1 / 0 / 1/step]
7-622-245	PM Counter Reset	PCU:All Colors	ENG	[0 to 1 / 0 / 1/step]
7-622-246	PM Counter Reset	Development Unit:All Colors	ENG	[0 to 1 / 0 / 1/step]
7-622-247	PM Counter Reset	Developer:All Colors	ENG	[0 to 1 / 0 / 1/step]
7-622-250	PM Counter Reset	SCS	ENG	[0 to 1 / 0 / 1/step]
7-623-002	PM Value Setting: Life Pages	# PCU:K	ENG	[0 to 99999999 / 0 / 1page/step]
7-623-003	PM Value Setting: Life Pages	# Dev Unit:K	ENG	[0 to 99999999 / 0 / 1page/step]
7-623-004	PM Value Setting: Life Pages	Developer:K	ENG	[0 to 99999999 / 0 / 1page/step]
7-623-025	PM Value Setting: Life Pages	# PCU:C	ENG	[0 to 99999999 / 0 / 1page/step]

3.SP Mode Tables

SP No.	Large Category	Small Category	ENG or CTL	[Min to Max/Init./Step]
7-623-026	PM Value Setting: Life Pages	# Dev Unit:C	ENG	[0 to 99999999 / 0 / 1page/step]
7-623-027	PM Value Setting: Life Pages	Developer:C	ENG	[0 to 99999999 / 0 / 1page/step]
7-623-048	PM Value Setting: Life Pages	# PCU:M	ENG	[0 to 99999999 / 0 / 1page/step]
7-623-049	PM Value Setting: Life Pages	# Dev Unit:M	ENG	[0 to 99999999 / 0 / 1page/step]
7-623-050	PM Value Setting: Life Pages	Developer:M	ENG	[0 to 99999999 / 0 / 1page/step]
7-623-071	PM Value Setting: Life Pages	# PCU:Y	ENG	[0 to 99999999 / 0 / 1page/step]
7-623-072	PM Value Setting: Life Pages	# Dev Unit:Y	ENG	[0 to 99999999 / 0 / 1page/step]
7-623-073	PM Value Setting: Life Pages	Developer:Y	ENG	[0 to 99999999 / 0 / 1page/step]
7-623-093	PM Value Setting: Life Pages	# ITB Unit	ENG	IM C3500: [0 to 99999999 / 600000 / 1page/step] IM C2500: [0 to 99999999 / 240000 / 1page/step] IM C2000: [0 to 99999999 / 240000 / 1page/step] IM C3000: [0 to 99999999 / 600000 / 1page/step]
7-	PM Value Setting: Life Pages	# ITB Cleaning Unit	ENG	IM C3500:

3.SP Mode Tables

SP No.	Large Category	Small Category	ENG or CTL	[Min to Max/Init./Step]
623-102				[0 to 99999999 / 600000 / 1page/step] IM C2500: [0 to 99999999 / 240000 / 1page/step] IM C2000: [0 to 99999999 / 240000 / 1page/step] IM C3000: [0 to 99999999 / 600000 / 1page/step]
7-623-109	PM Value Setting: Life Pages	# PTR Unit	ENG	IM C3500: [0 to 99999999 / 900000 / 1page/step] IM C2500: [0 to 99999999 / 240000 / 1page/step] IM C2000: [0 to 99999999 / 240000 / 1page/step] IM C3000: [0 to 99999999 / 900000 / 1page/step]
7-623-115	PM Value Setting: Life Pages	# Fusing Unit	ENG	IM C3500: [0 to 99999999 / 400000 / 1page/step] IM C2500: [0 to 99999999 / 240000 / 1page/step] IM C2000: [0 to 99999999 / 240000 / 1page/step] IM C3000: [0 to 99999999 / 400000 / 1page/step]
7-623-	PM Value Setting: Life Pages	Fusing Belt	ENG	IM C3500: [0 to 99999999 /

3.SP Mode Tables

SP No.	Large Category	Small Category	ENG or CTL	[Min to Max/Init./Step]
116				400000 / 1page/step] IM C2500: [0 to 99999999 / 240000 / 1page/step] IM C2000: [0 to 99999999 / 240000 / 1page/step] IM C3000: [0 to 99999999 / 400000 / 1page/step]
7- 623- 118	PM Value Setting: Life Pages	Pressure Roller	ENG	IM C3500: [0 to 99999999 / 400000 / 1page/step] IM C2500: [0 to 99999999 / 240000 / 1page/step] IM C2000: [0 to 99999999 / 240000 / 1page/step] IM C3000: [0 to 99999999 / 400000 / 1page/step]
7- 623- 131	PM Value Setting: Life Pages	Dust Filter	ENG	[0 to 99999999 / 400000 / 1page/step]
7- 623- 142	PM Value Setting: Life Pages	Waste Toner Bottle	ENG	[0 to 999999999 / 1200000 / 1mg/step]
7- 623- 206	PM Value Setting: Life Pages	ADF Pick-up Roller	ENG	[0 to 99999999 / 120000 / 1page/step]
7- 623- 207	PM Value Setting: Life Pages	ADF Supply Belt	ENG	[0 to 99999999 / 120000 / 1page/step]
7- 623- 208	PM Value Setting: Life Pages	ADF Reverse Roller	ENG	[0 to 99999999 / 120000 / 1page/step]

3.SP Mode Tables

SP No.	Large Category	Small Category	ENG or CTL	[Min to Max/Init./Step]
7-625-002	Previous Unit Counter: Pages	# PCU:K	ENG	[0 to 99999999 / 0 / 1page/step]
7-625-003	Previous Unit Counter: Pages	# Dev Unit:K	ENG	[0 to 99999999 / 0 / 1page/step]
7-625-004	Previous Unit Counter: Pages	Developer:K	ENG	[0 to 99999999 / 0 / 1page/step]
7-625-025	Previous Unit Counter: Pages	# PCU:C	ENG	[0 to 99999999 / 0 / 1page/step]
7-625-026	Previous Unit Counter: Pages	# Dev Unit:C	ENG	[0 to 99999999 / 0 / 1page/step]
7-625-027	Previous Unit Counter: Pages	Developer:C	ENG	[0 to 99999999 / 0 / 1page/step]
7-625-048	Previous Unit Counter: Pages	# PCU:M	ENG	[0 to 99999999 / 0 / 1page/step]
7-625-049	Previous Unit Counter: Pages	# Dev Unit:M	ENG	[0 to 99999999 / 0 / 1page/step]
7-625-050	Previous Unit Counter: Pages	Developer:M	ENG	[0 to 99999999 / 0 / 1page/step]
7-625-071	Previous Unit Counter: Pages	# PCU:Y	ENG	[0 to 99999999 / 0 / 1page/step]
7-625-072	Previous Unit Counter: Pages	# Dev Unit:Y	ENG	[0 to 99999999 / 0 / 1page/step]
7-625-073	Previous Unit Counter: Pages	Developer:Y	ENG	[0 to 99999999 / 0 / 1page/step]

3.SP Mode Tables

SP No.	Large Category	Small Category	ENG or CTL	[Min to Max/Init./Step]
7-625-093	Previous Unit Counter: Pages	# ITB Unit	ENG	[0 to 99999999 / 0 / 1page/step]
7-625-102	Previous Unit Counter: Pages	# ITB Cleaning Unit	ENG	[0 to 99999999 / 0 / 1page/step]
7-625-109	Previous Unit Counter: Pages	# PTR Unit	ENG	[0 to 99999999 / 0 / 1page/step]
7-625-115	Previous Unit Counter: Pages	# Fusing Unit	ENG	[0 to 99999999 / 0 / 1page/step]
7-625-116	Previous Unit Counter: Pages	Fusing Belt	ENG	[0 to 99999999 / 0 / 1page/step]
7-625-118	Previous Unit Counter: Pages	Pressure Roller	ENG	[0 to 99999999 / 0 / 1page/step]
7-625-131	Previous Unit Counter: Pages	Dust Filter	ENG	[0 to 99999999 / 0 / 1page/step]
7-625-142	Previous Unit Counter: Pages	Waste Toner Bottle	ENG	[0 to 999999999 / 0 / 1mg/step]
7-625-206	Previous Unit Counter: Pages	ADF Pick-up Roller	ENG	[0 to 99999999 / 0 / 1page/step]
7-625-207	Previous Unit Counter: Pages	ADF Supply Belt	ENG	[0 to 99999999 / 0 / 1page/step]
7-625-208	Previous Unit Counter: Pages	ADF Reverse Roller	ENG	[0 to 99999999 / 0 / 1page/step]
7-626-002	Previous Unit Counter2: Pages	# PCU:K	ENG	[0 to 99999999 / 0 / 1page/step]

3.SP Mode Tables

SP No.	Large Category	Small Category	ENG or CTL	[Min to Max/Init./Step]
7-626-003	Previous Unit Counter2: Pages	# Dev Unit:K	ENG	[0 to 99999999 / 0 / 1page/step]
7-626-004	Previous Unit Counter2: Pages	Developer:K	ENG	[0 to 99999999 / 0 / 1page/step]
7-626-025	Previous Unit Counter2: Pages	# PCU:C	ENG	[0 to 99999999 / 0 / 1page/step]
7-626-026	Previous Unit Counter2: Pages	# Dev Unit:C	ENG	[0 to 99999999 / 0 / 1page/step]
7-626-027	Previous Unit Counter2: Pages	Developer:C	ENG	[0 to 99999999 / 0 / 1page/step]
7-626-048	Previous Unit Counter2: Pages	# PCU:M	ENG	[0 to 99999999 / 0 / 1page/step]
7-626-049	Previous Unit Counter2: Pages	# Dev Unit:M	ENG	[0 to 99999999 / 0 / 1page/step]
7-626-050	Previous Unit Counter2: Pages	Developer:M	ENG	[0 to 99999999 / 0 / 1page/step]
7-626-071	Previous Unit Counter2: Pages	# PCU:Y	ENG	[0 to 99999999 / 0 / 1page/step]
7-626-072	Previous Unit Counter2: Pages	# Dev Unit:Y	ENG	[0 to 99999999 / 0 / 1page/step]
7-626-073	Previous Unit Counter2: Pages	Developer:Y	ENG	[0 to 99999999 / 0 / 1page/step]
7-626-093	Previous Unit Counter2: Pages	# ITB Unit	ENG	[0 to 99999999 / 0 / 1page/step]

3.SP Mode Tables

SP No.	Large Category	Small Category	ENG or CTL	[Min to Max/Init./Step]
7-626-102	Previous Unit Counter2: Pages	# ITB Cleaning Unit	ENG	[0 to 99999999 / 0 / 1page/step]
7-626-109	Previous Unit Counter2: Pages	# PTR Unit	ENG	[0 to 99999999 / 0 / 1page/step]
7-626-115	Previous Unit Counter2: Pages	# Fusing Unit	ENG	[0 to 99999999 / 0 / 1page/step]
7-626-116	Previous Unit Counter2: Pages	Fusing Belt	ENG	[0 to 99999999 / 0 / 1page/step]
7-626-118	Previous Unit Counter2: Pages	Pressure Roller	ENG	[0 to 99999999 / 0 / 1page/step]
7-626-131	Previous Unit Counter2: Pages	Dust Filter	ENG	[0 to 99999999 / 0 / 1page/step]
7-626-142	Previous Unit Counter2: Pages	Waste Toner Bottle	ENG	[0 to 99999999 / 0 / 1mg/step]
7-626-206	Previous Unit Counter2: Pages	ADF Pick-up Roller	ENG	[0 to 99999999 / 0 / 1page/step]
7-626-207	Previous Unit Counter2: Pages	ADF Supply Belt	ENG	[0 to 99999999 / 0 / 1page/step]
7-626-208	Previous Unit Counter2: Pages	ADF Reverse Roller	ENG	[0 to 99999999 / 0 / 1page/step]
7-628-002	PM Counter Reset	SCS	ENG	[0 to 1 / 0 / 1/step]
7-720-001	ave. cvrg for eng.	K	ENG*	[0.00 to 100.00 / 0.00 / 0.01%/step]

3.SP Mode Tables

SP No.	Large Category	Small Category	ENG or CTL	[Min to Max/Init./Step]
7-720-002	ave. cvrg for eng.	C	ENG*	[0.00 to 100.00 / 0.00 / 0.01%/step]
7-720-003	ave. cvrg for eng.	M	ENG*	[0.00 to 100.00 / 0.00 / 0.01%/step]
7-720-004	ave. cvrg for eng.	Y	ENG*	[0.00 to 100.00 / 0.00 / 0.01%/step]
7-801-002	ROM No.	Engine	ENG	[0 to 0 / 0 / 0/step]
7-801-005	ROM No.	ADF	ENG	[0 to 0 / 0 / 0/step]
7-801-007	ROM No.	Finisher	ENG	[0 to 0 / 0 / 0/step]
7-801-009	ROM No.	PTU	ENG	[0 to 0 / 0 / 0/step]
7-801-010	ROM No.	LCT	ENG	[0 to 0 / 0 / 0/step]
7-801-025	ROM No.	Folder	ENG	[0 to 0 / 0 / 0/step]
7-801-102	Firmware Version	Engine	ENG	[0 to 0 / 0 / 0/step]
7-801-105	Firmware Version	ADF	ENG	[0 to 0 / 0 / 0/step]
7-801-107	Firmware Version	Finisher	ENG	[0 to 0 / 0 / 0/step]

3.SP Mode Tables

SP No.	Large Category	Small Category	ENG or CTL	[Min to Max/Init./Step]
7-801-109	Firmware Version	PTU	ENG	[0 to 0 / 0 / 0/step]
7-801-110	Firmware Version	LCT	ENG	[0 to 0 / 0 / 0/step]
7-801-125	Firmware Version	Folder	ENG	[0 to 0 / 0 / 0/step]
7-853-002	Replace Counter	# PCU:K	ENG	[0 to 255 / 0 / 1/step]
7-853-003	Replace Counter	# Dev Unit:K	ENG	[0 to 255 / 0 / 1/step]
7-853-004	Replace Counter	Developer:K	ENG	[0 to 255 / 0 / 1/step]
7-853-025	Replace Counter	# PCU:C	ENG	[0 to 255 / 0 / 1/step]
7-853-026	Replace Counter	# Dev Unit:C	ENG	[0 to 255 / 0 / 1/step]
7-853-027	Replace Counter	Developer:C	ENG	[0 to 255 / 0 / 1/step]
7-853-048	Replace Counter	# PCU:M	ENG	[0 to 255 / 0 / 1/step]
7-853-049	Replace Counter	# Dev Unit:M	ENG	[0 to 255 / 0 / 1/step]
7-853-050	Replace Counter	Developer:M	ENG	[0 to 255 / 0 / 1/step]

3.SP Mode Tables

SP No.	Large Category	Small Category	ENG or CTL	[Min to Max/Init./Step]
7-853-071	Replace Counter	# PCU:Y	ENG	[0 to 255 / 0 / 1/step]
7-853-072	Replace Counter	# Dev Unit:Y	ENG	[0 to 255 / 0 / 1/step]
7-853-073	Replace Counter	Developer:Y	ENG	[0 to 255 / 0 / 1/step]
7-853-093	Replace Counter	# ITB Unit	ENG	[0 to 255 / 0 / 1/step]
7-853-102	Replace Counter	# ITB Cleaning Unit	ENG	[0 to 255 / 0 / 1/step]
7-853-109	Replace Counter	# PTR Unit	ENG	[0 to 255 / 0 / 1/step]
7-853-115	Replace Counter	# Fusing Unit	ENG	[0 to 255 / 0 / 1/step]
7-853-116	Replace Counter	Fusing Belt	ENG	[0 to 255 / 0 / 1/step]
7-853-118	Replace Counter	Pressure Roller	ENG	[0 to 255 / 0 / 1/step]
7-853-131	Replace Counter	Dust Filter	ENG	[0 to 255 / 0 / 1/step]
7-853-142	Replace Counter	Waste Toner Bottle	ENG	[0 to 255 / 0 / 1/step]
7-853-206	Replace Counter	ADF Pick-up Roller	ENG	[0 to 255 / 0 / 1/step]

3.SP Mode Tables

SP No.	Large Category	Small Category	ENG or CTL	[Min to Max/Init./Step]
7-853-207	Replace Counter	ADF Supply Belt	ENG	[0 to 255 / 0 / 1/step]
7-853-208	Replace Counter	ADF Reverse Roller	ENG	[0 to 255 / 0 / 1/step]
7-860-001	Paper Edge	Paper Width Division 1	ENG	[0 to 4294967295 / 0 / 1mm/step]
7-860-002	Paper Edge	Paper Width Division 2	ENG	[0 to 4294967295 / 0 / 1mm/step]
7-860-003	Paper Edge	Paper Width Division 3	ENG	[0 to 4294967295 / 0 / 1mm/step]
7-860-004	Paper Edge	Paper Width Division 4	ENG	[0 to 4294967295 / 0 / 1mm/step]
7-860-005	Paper Edge	Paper Width Division 5	ENG	[0 to 4294967295 / 0 / 1mm/step]
7-860-006	Paper Edge	Paper Width Division 6	ENG	[0 to 4294967295 / 0 / 1mm/step]
7-860-007	Paper Edge	Paper Width Division 7	ENG	[0 to 4294967295 / 0 / 1mm/step]
7-860-008	Paper Edge	Paper Width Division 8	ENG	[0 to 4294967295 / 0 / 1mm/step]
7-860-009	Paper Edge	Paper Width Division 9	ENG	[0 to 4294967295 / 0 / 1mm/step]
7-860-010	Paper Edge	Paper Width Division 10	ENG	[0 to 4294967295 / 0 / 1mm/step]

3.SP Mode Tables

SP No.	Large Category	Small Category	ENG or CTL	[Min to Max/Init./Step]
7-860-011	Paper Edge	Paper Width Division 11	ENG	[0 to 4294967295 / 0 / 1mm/step]
7-860-012	Paper Edge	Paper Width Division 12	ENG	[0 to 4294967295 / 0 / 1mm/step]
7-861-001	JAM record : include paper	Fuser Unit	ENG	[0 to 65535 / 0 / 1/step]
7-906-002	Previous Unit Counter:Distance	# PCU:K	ENG	[0 to 4294967295 / 0 / 1mm/step]
7-906-003	Previous Unit Counter:Distance	# Dev Unit:K	ENG	[0 to 4294967295 / 0 / 1mm/step]
7-906-004	Previous Unit Counter:Distance	Developer:K	ENG	[0 to 4294967295 / 0 / 1mm/step]
7-906-025	Previous Unit Counter:Distance	# PCU:C	ENG	[0 to 4294967295 / 0 / 1mm/step]
7-906-026	Previous Unit Counter:Distance	# Dev Unit:C	ENG	[0 to 4294967295 / 0 / 1mm/step]
7-906-027	Previous Unit Counter:Distance	Developer: C	ENG	[0 to 4294967295 / 0 / 1mm/step]
7-906-048	Previous Unit Counter:Distance	# PCU:M	ENG	[0 to 4294967295 / 0 / 1mm/step]
7-906-049	Previous Unit Counter:Distance	# Dev Unit:M	ENG	[0 to 4294967295 / 0 / 1mm/step]
7-906-050	Previous Unit Counter:Distance	Developer: M	ENG	[0 to 4294967295 / 0 / 1mm/step]

3.SP Mode Tables

SP No.	Large Category	Small Category	ENG or CTL	[Min to Max/Init./Step]
7-906-071	Previous Unit Counter:Distance	# PCU:Y	ENG	[0 to 4294967295 / 0 / 1mm/step]
7-906-072	Previous Unit Counter:Distance	# Dev Unit:Y	ENG	[0 to 4294967295 / 0 / 1mm/step]
7-906-073	Previous Unit Counter:Distance	Developer: Y	ENG	[0 to 4294967295 / 0 / 1mm/step]
7-906-093	Previous Unit Counter:Distance	# ITB Unit	ENG	[0 to 4294967295 / 0 / 1mm/step]
7-906-102	Previous Unit Counter:Distance	# ITB Cleaning Unit	ENG	[0 to 4294967295 / 0 / 1mm/step]
7-906-109	Previous Unit Counter:Distance	# PTR Unit	ENG	[0 to 4294967295 / 0 / 1mm/step]
7-906-115	Previous Unit Counter:Distance	# Fusing Unit	ENG	[0 to 4294967295 / 0 / 1mm/step]
7-906-116	Previous Unit Counter:Distance	Fusing Belt	ENG	[0 to 4294967295 / 0 / 1mm/step]
7-906-118	Previous Unit Counter:Distance	Pressure Roller	ENG	[0 to 4294967295 / 0 / 1mm/step]
7-906-230	Previous Unit Counter:Distance	Low Speed: # PCU:K	ENG	[0 to 4294967295 / 0 / 1mm/step]
7-906-231	Previous Unit Counter:Distance	Low Speed: # PCU:C	ENG	[0 to 4294967295 / 0 / 1mm/step]
7-906-232	Previous Unit Counter:Distance	Low Speed: # PCU:M	ENG	[0 to 4294967295 / 0 / 1mm/step]

3.SP Mode Tables

SP No.	Large Category	Small Category	ENG or CTL	[Min to Max/Init./Step]
7-906-233	Previous Unit Counter:Distance	Low Speed: # PCU:Y	ENG	[0 to 4294967295 / 0 / 1mm/step]
7-906-234	Previous Unit Counter:Distance	Middle Speed: # PCU:K	ENG	[0 to 4294967295 / 0 / 1mm/step]
7-906-235	Previous Unit Counter:Distance	Middle Speed: # PCU:C	ENG	[0 to 4294967295 / 0 / 1mm/step]
7-906-236	Previous Unit Counter:Distance	Middle Speed: # PCU:M	ENG	[0 to 4294967295 / 0 / 1mm/step]
7-906-237	Previous Unit Counter:Distance	Middle Speed: # PCU:Y	ENG	[0 to 4294967295 / 0 / 1mm/step]
7-907-002	Previous Unit Cntr:Distance(%)	# PCU:K	ENG	[0 to 255 / 0 / 1%/step]
7-907-003	Previous Unit Cntr:Distance(%)	# Dev Unit:K	ENG	[0 to 255 / 0 / 1%/step]
7-907-004	Previous Unit Cntr:Distance(%)	Developer:K	ENG	[0 to 255 / 0 / 1%/step]
7-907-025	Previous Unit Cntr:Distance(%)	# PCU:C	ENG	[0 to 255 / 0 / 1%/step]
7-907-026	Previous Unit Cntr:Distance(%)	# Dev Unit:C	ENG	[0 to 255 / 0 / 1%/step]
7-907-027	Previous Unit Cntr:Distance(%)	Developer:C	ENG	[0 to 255 / 0 / 1%/step]
7-907-048	Previous Unit Cntr:Distance(%)	# PCU:M	ENG	[0 to 255 / 0 / 1%/step]

3.SP Mode Tables

SP No.	Large Category	Small Category	ENG or CTL	[Min to Max/Init./Step]
7-907-049	Previous Unit Cntr:Distance(%)	# Dev Unit:M	ENG	[0 to 255 / 0 / 1%/step]
7-907-050	Previous Unit Cntr:Distance(%)	Developer:M	ENG	[0 to 255 / 0 / 1%/step]
7-907-071	Previous Unit Cntr:Distance(%)	# PCU:Y	ENG	[0 to 255 / 0 / 1%/step]
7-907-072	Previous Unit Cntr:Distance(%)	# Dev Unit:Y	ENG	[0 to 255 / 0 / 1%/step]
7-907-073	Previous Unit Cntr:Distance(%)	Developer:Y	ENG	[0 to 255 / 0 / 1%/step]
7-907-093	Previous Unit Cntr:Distance(%)	# ITB Unit	ENG	[0 to 255 / 0 / 1%/step]
7-907-102	Previous Unit Cntr:Distance(%)	# ITB Cleaning Unit	ENG	[0 to 255 / 0 / 1%/step]
7-907-109	Previous Unit Cntr:Distance(%)	# PTR Unit	ENG	[0 to 255 / 0 / 1%/step]
7-907-115	Previous Unit Cntr:Distance(%)	# Fusing Unit	ENG	[0 to 255 / 0 / 1%/step]
7-907-116	Previous Unit Cntr:Distance(%)	Fusing Belt	ENG	[0 to 255 / 0 / 1%/step]
7-907-118	Previous Unit Cntr:Distance(%)	Pressure Roller	ENG	[0 to 255 / 0 / 1%/step]
7-908-002	Previous Unit Counter:Pages(%)	# PCU:K	ENG	[0 to 255 / 0 / 1%/step]

3.SP Mode Tables

SP No.	Large Category	Small Category	ENG or CTL	[Min to Max/Init./Step]
7-908-003	Previous Unit Counter:Pages(%)	# Dev Unit:K	ENG	[0 to 255 / 0 / 1%/step]
7-908-004	Previous Unit Counter:Pages(%)	Developer:K	ENG	[0 to 255 / 0 / 1%/step]
7-908-025	Previous Unit Counter:Pages(%)	# PCU:C	ENG	[0 to 255 / 0 / 1%/step]
7-908-026	Previous Unit Counter:Pages(%)	# Dev Unit:C	ENG	[0 to 255 / 0 / 1%/step]
7-908-027	Previous Unit Counter:Pages(%)	Developer:C	ENG	[0 to 255 / 0 / 1%/step]
7-908-048	Previous Unit Counter:Pages(%)	# PCU:M	ENG	[0 to 255 / 0 / 1%/step]
7-908-049	Previous Unit Counter:Pages(%)	# Dev Unit:M	ENG	[0 to 255 / 0 / 1%/step]
7-908-050	Previous Unit Counter:Pages(%)	Developer:M	ENG	[0 to 255 / 0 / 1%/step]
7-908-071	Previous Unit Counter:Pages(%)	# PCU:Y	ENG	[0 to 255 / 0 / 1%/step]
7-908-072	Previous Unit Counter:Pages(%)	# Dev Unit:Y	ENG	[0 to 255 / 0 / 1%/step]
7-908-073	Previous Unit Counter:Pages(%)	Developer:Y	ENG	[0 to 255 / 0 / 1%/step]
7-908-093	Previous Unit Counter:Pages(%)	# ITB Unit	ENG	[0 to 255 / 0 / 1%/step]

3.SP Mode Tables

SP No.	Large Category	Small Category	ENG or CTL	[Min to Max/Init./Step]
7-908-102	Previous Unit Counter:Pages(%)	# ITB Cleaning Unit	ENG	[0 to 255 / 0 / 1%/step]
7-908-109	Previous Unit Counter:Pages(%)	# PTR Unit	ENG	[0 to 255 / 0 / 1%/step]
7-908-115	Previous Unit Counter:Pages(%)	# Fusing Unit	ENG	[0 to 255 / 0 / 1%/step]
7-908-116	Previous Unit Counter:Pages(%)	Fusing Belt	ENG	[0 to 255 / 0 / 1%/step]
7-908-118	Previous Unit Counter:Pages(%)	Pressure Roller	ENG	[0 to 255 / 0 / 1%/step]
7-908-131	Previous Unit Counter:Pages(%)	Dust Filter	ENG	[0 to 255 / 0 / 1%/step]
7-908-142	Previous Unit Counter:Pages(%)	Waste Toner Bottle	ENG	[0 to 255 / 0 / 1%/step]
7-908-206	Previous Unit Counter:Pages(%)	ADF Pick-up Roller	ENG	[0 to 255 / 0 / 1%/step]
7-908-207	Previous Unit Counter:Pages(%)	ADF Supply Belt	ENG	[0 to 255 / 0 / 1%/step]
7-908-208	Previous Unit Counter:Pages(%)	ADF Reverse Roller	ENG	[0 to 255 / 0 / 1%/step]
7-931-001	Toner Bottle Bk	Machine Serial ID	ENG*	[0 to 255 / 0 / 1/step]
7-931-002	Toner Bottle Bk	Cartridge Ver	ENG*	[0 to 255 / 0 / 1/step]

3.SP Mode Tables

SP No.	Large Category	Small Category	ENG or CTL	[Min to Max/Init./Step]
7-931-003	Toner Bottle Bk	Brand ID	ENG*	[0 to 255 / 0 / 1/step]
7-931-004	Toner Bottle Bk	Area ID	ENG*	[0 to 255 / 0 / 1/step]
7-931-005	Toner Bottle Bk	Product ID	ENG*	[0 to 255 / 0 / 1/step]
7-931-006	Toner Bottle Bk	Color ID	ENG*	[0 to 255 / 0 / 1/step]
7-931-007	Toner Bottle Bk	Maintenance ID	ENG*	[0 to 255 / 0 / 1/step]
7-931-008	Toner Bottle Bk	New Product Information	ENG*	[0 to 255 / 0 / 1/step]
7-931-009	Toner Bottle Bk	Recycle Counter	ENG*	[0 to 255 / 0 / 1/step]
7-931-010	Toner Bottle Bk	Date	ENG*	[0 to 1 / 0 / 1/step]
7-931-011	Toner Bottle Bk	SerialNo.	ENG*	[0 to 1 / 0 / 1/step]
7-931-012	Toner Bottle Bk	Toner Remaining	ENG*	[0 to 100 / 100 / 1%/step]
7-931-013	Toner Bottle Bk	EDP Code	ENG*	[0 to 1 / 0 / 1/step]
7-931-014	Toner Bottle Bk	End History	ENG*	[0 to 1 / 0 / 1/step]

3.SP Mode Tables

SP No.	Large Category	Small Category	ENG or CTL	[Min to Max/Init./Step]
7-931-015	Toner Bottle Bk	Refill Information	ENG*	[0 to 1 / 0 / 1/step]
7-931-016	Toner Bottle Bk	Attachment: Total Counter	ENG*	[0 to 99999999 / 0 / 1/step]
7-931-017	Toner Bottle Bk	Attachment: Color Counter	ENG*	[0 to 99999999 / 0 / 1/step]
7-931-018	Toner Bottle Bk	End: Total Counter	ENG*	[0 to 99999999 / 0 / 1/step]
7-931-019	Toner Bottle Bk	End: Color Counter	ENG*	[0 to 99999999 / 0 / 1/step]
7-931-020	Toner Bottle Bk	Attachment Date	ENG*	[0 to 1 / 0 / 1/step]
7-931-021	Toner Bottle Bk	End Date	ENG*	[0 to 1 / 0 / 1/step]
7-932-001	Toner Bottle M	Machine Serial ID	ENG*	[0 to 255 / 0 / 1/step]
7-932-002	Toner Bottle M	Cartridge Ver	ENG*	[0 to 255 / 0 / 1/step]
7-932-003	Toner Bottle M	Brand ID	ENG*	[0 to 255 / 0 / 1/step]
7-932-004	Toner Bottle M	Area ID	ENG*	[0 to 255 / 0 / 1/step]
7-932-005	Toner Bottle M	Product ID	ENG*	[0 to 255 / 0 / 1/step]

3.SP Mode Tables

SP No.	Large Category	Small Category	ENG or CTL	[Min to Max/Init./Step]
7-932-006	Toner Bottle M	Color ID	ENG*	[0 to 255 / 0 / 1/step]
7-932-007	Toner Bottle M	Maintenance ID	ENG*	[0 to 255 / 0 / 1/step]
7-932-008	Toner Bottle M	New Product Information	ENG*	[0 to 255 / 0 / 1/step]
7-932-009	Toner Bottle M	Recycle Counter	ENG*	[0 to 255 / 0 / 1/step]
7-932-010	Toner Bottle M	Date	ENG*	[0 to 1 / 0 / 1/step]
7-932-011	Toner Bottle M	SerialNo.	ENG*	[0 to 1 / 0 / 1/step]
7-932-012	Toner Bottle M	Toner Remaining	ENG*	[0 to 100 / 100 / 1%/step]
7-932-013	Toner Bottle M	EDP Code	ENG*	[0 to 1 / 0 / 1/step]
7-932-014	Toner Bottle M	End History	ENG*	[0 to 1 / 0 / 1/step]
7-932-015	Toner Bottle M	Refill Information	ENG*	[0 to 1 / 0 / 1/step]
7-932-016	Toner Bottle M	Attachment: Total Counter	ENG*	[0 to 99999999 / 0 / 1/step]
7-932-017	Toner Bottle M	Attachment: Color Counter	ENG*	[0 to 99999999 / 0 / 1/step]

3.SP Mode Tables

SP No.	Large Category	Small Category	ENG or CTL	[Min to Max/Init./Step]
7-932-018	Toner Bottle M	End: Total Counter	ENG*	[0 to 99999999 / 0 / 1/step]
7-932-019	Toner Bottle M	End: Color Counter	ENG*	[0 to 99999999 / 0 / 1/step]
7-932-020	Toner Bottle M	Attachment Date	ENG*	[0 to 1 / 0 / 1/step]
7-932-021	Toner Bottle M	End Date	ENG*	[0 to 1 / 0 / 1/step]
7-933-001	Toner Bottle C	MachineSerialID	ENG*	[0 to 255 / 0 / 1/step]
7-933-002	Toner Bottle C	Cartridge Ver	ENG*	[0 to 255 / 0 / 1/step]
7-933-003	Toner Bottle C	Brand ID	ENG*	[0 to 255 / 0 / 1/step]
7-933-004	Toner Bottle C	Area ID	ENG*	[0 to 255 / 0 / 1/step]
7-933-005	Toner Bottle C	Product ID	ENG*	[0 to 255 / 0 / 1/step]
7-933-006	Toner Bottle C	Color ID	ENG*	[0 to 255 / 0 / 1/step]
7-933-007	Toner Bottle C	Maintenance ID	ENG*	[0 to 255 / 0 / 1/step]
7-933-008	Toner Bottle C	New Product Information	ENG*	[0 to 255 / 0 / 1/step]

3.SP Mode Tables

SP No.	Large Category	Small Category	ENG or CTL	[Min to Max/Init./Step]
7-933-009	Toner Bottle C	Recycle Counter	ENG*	[0 to 255 / 0 / 1/step]
7-933-010	Toner Bottle C	Date	ENG*	[0 to 1 / 0 / 1/step]
7-933-011	Toner Bottle C	SerialNo.	ENG*	[0 to 1 / 0 / 1/step]
7-933-012	Toner Bottle C	Toner Remaining	ENG*	[0 to 100 / 100 / 1%/step]
7-933-013	Toner Bottle C	EDP Code	ENG*	[0 to 1 / 0 / 1/step]
7-933-014	Toner Bottle C	End History	ENG*	[0 to 1 / 0 / 1/step]
7-933-015	Toner Bottle C	Refill Information	ENG*	[0 to 1 / 0 / 1/step]
7-933-016	Toner Bottle C	Attachment: Total Counter	ENG*	[0 to 99999999 / 0 / 1/step]
7-933-017	Toner Bottle C	Attachment: Color Counter	ENG*	[0 to 99999999 / 0 / 1/step]
7-933-018	Toner Bottle C	End: Total Counter	ENG*	[0 to 99999999 / 0 / 1/step]
7-933-019	Toner Bottle C	End: Color Counter	ENG*	[0 to 99999999 / 0 / 1/step]
7-933-020	Toner Bottle C	Attachment Date	ENG*	[0 to 1 / 0 / 1/step]

3.SP Mode Tables

SP No.	Large Category	Small Category	ENG or CTL	[Min to Max/Init./Step]
7-933-021	Toner Bottle C	End Date	ENG*	[0 to 1 / 0 / 1/step]
7-934-001	Toner Bottle Y	MachineSerialID	ENG*	[0 to 255 / 0 / 1/step]
7-934-002	Toner Bottle Y	Cartridge Ver	ENG*	[0 to 255 / 0 / 1/step]
7-934-003	Toner Bottle Y	Brand ID	ENG*	[0 to 255 / 0 / 1/step]
7-934-004	Toner Bottle Y	Area ID	ENG*	[0 to 255 / 0 / 1/step]
7-934-005	Toner Bottle Y	Product ID	ENG*	[0 to 255 / 0 / 1/step]
7-934-006	Toner Bottle Y	Color ID	ENG*	[0 to 255 / 0 / 1/step]
7-934-007	Toner Bottle Y	Maintenance ID	ENG*	[0 to 255 / 0 / 1/step]
7-934-008	Toner Bottle Y	New Product Information	ENG*	[0 to 255 / 0 / 1/step]
7-934-009	Toner Bottle Y	Recycle Counter	ENG*	[0 to 255 / 0 / 1/step]
7-934-010	Toner Bottle Y	Date	ENG*	[0 to 1 / 0 / 1/step]
7-934-011	Toner Bottle Y	SerialNo.	ENG*	[0 to 1 / 0 / 1/step]

3.SP Mode Tables

SP No.	Large Category	Small Category	ENG or CTL	[Min to Max/Init./Step]
7-934-012	Toner Bottle Y	Toner Remaining	ENG*	[0 to 100 / 100 / 1%/step]
7-934-013	Toner Bottle Y	EDP Code	ENG*	[0 to 1 / 0 / 1/step]
7-934-014	Toner Bottle Y	End History	ENG*	[0 to 1 / 0 / 1/step]
7-934-015	Toner Bottle Y	Refill Information	ENG*	[0 to 1 / 0 / 1/step]
7-934-016	Toner Bottle Y	Attachment: Total Counter	ENG*	[0 to 99999999 / 0 / 1/step]
7-934-017	Toner Bottle Y	Attachment: Color Counter	ENG*	[0 to 99999999 / 0 / 1/step]
7-934-018	Toner Bottle Y	End: Total Counter	ENG*	[0 to 99999999 / 0 / 1/step]
7-934-019	Toner Bottle Y	End: Color Counter	ENG*	[0 to 99999999 / 0 / 1/step]
7-934-020	Toner Bottle Y	Attachment Date	ENG*	[0 to 1 / 0 / 1/step]
7-934-021	Toner Bottle Y	End Date	ENG*	[0 to 1 / 0 / 1/step]
7-935-001	Toner Bottle Log 1: Bk	SerialNo.	ENG	[0 to 1 / 0 / 1/step]
7-935-002	Toner Bottle Log 1: Bk	Attachment Date	ENG	[0 to 1 / 0 / 1/step]

3.SP Mode Tables

SP No.	Large Category	Small Category	ENG or CTL	[Min to Max/Init./Step]
7-935-003	Toner Bottle Log 1: Bk	Attachment: Total Counter	ENG	[0 to 99999999 / 0 / 1/step]
7-935-004	Toner Bottle Log 1: Bk	Refill Information	ENG*	[0 to 1 / 0 / 1/step]
7-935-011	Toner Bottle Log 2: Bk	SerialNo.	ENG	[0 to 1 / 0 / 1/step]
7-935-012	Toner Bottle Log 2: Bk	Attachment Date	ENG	[0 to 1 / 0 / 1/step]
7-935-013	Toner Bottle Log 2: Bk	Attachment: Total Counter	ENG	[0 to 99999999 / 0 / 1/step]
7-935-014	Toner Bottle Log 2: Bk	Refill Information	ENG*	[0 to 1 / 0 / 1/step]
7-935-021	Toner Bottle Log 3: Bk	SerialNo.	ENG	[0 to 1 / 0 / 1/step]
7-935-022	Toner Bottle Log 3: Bk	Attachment Date	ENG	[0 to 1 / 0 / 1/step]
7-935-023	Toner Bottle Log 3: Bk	Attachment: Total Counter	ENG	[0 to 99999999 / 0 / 1/step]
7-935-024	Toner Bottle Log 3: Bk	Refill Information	ENG*	[0 to 1 / 0 / 1/step]
7-935-031	Toner Bottle Log 4: Bk	SerialNo.	ENG	[0 to 1 / 0 / 1/step]
7-935-032	Toner Bottle Log 4: Bk	Attachment Date	ENG	[0 to 1 / 0 / 1/step]

3.SP Mode Tables

SP No.	Large Category	Small Category	ENG or CTL	[Min to Max/Init./Step]
7-935-033	Toner Bottle Log 4: Bk	Attachment: Total Counter	ENG	[0 to 99999999 / 0 / 1/step]
7-935-034	Toner Bottle Log 4: Bk	Refill Information	ENG*	[0 to 1 / 0 / 1/step]
7-935-041	Toner Bottle Log 5: Bk	SerialNo.	ENG	[0 to 1 / 0 / 1/step]
7-935-042	Toner Bottle Log 5: Bk	Attachment Date	ENG	[0 to 1 / 0 / 1/step]
7-935-043	Toner Bottle Log 5: Bk	Attachment: Total Counter	ENG	[0 to 99999999 / 0 / 1/step]
7-935-044	Toner Bottle Log 5: Bk	Refill Information	ENG*	[0 to 1 / 0 / 1/step]
7-936-001	Toner Bottle Log 1: M	SerialNo.	ENG	[0 to 1 / 0 / 1/step]
7-936-002	Toner Bottle Log 1: M	Attachment Date	ENG	[0 to 1 / 0 / 1/step]
7-936-003	Toner Bottle Log 1: M	Attachment: Total Counter	ENG	[0 to 99999999 / 0 / 1/step]
7-936-004	Toner Bottle Log 1: M	Refill Information	ENG*	[0 to 1 / 0 / 1/step]
7-936-011	Toner Bottle Log 2: M	SerialNo.	ENG	[0 to 1 / 0 / 1/step]
7-936-012	Toner Bottle Log 2: M	Attachment Date	ENG	[0 to 1 / 0 / 1/step]

3.SP Mode Tables

SP No.	Large Category	Small Category	ENG or CTL	[Min to Max/Init./Step]
7-936-013	Toner Bottle Log 2: M	Attachment: Total Counter	ENG	[0 to 99999999 / 0 / 1/step]
7-936-014	Toner Bottle Log 2: M	Refill Information	ENG*	[0 to 1 / 0 / 1/step]
7-936-021	Toner Bottle Log 3: M	SerialNo.	ENG	[0 to 1 / 0 / 1/step]
7-936-022	Toner Bottle Log 3: M	Attachment Date	ENG	[0 to 1 / 0 / 1/step]
7-936-023	Toner Bottle Log 3: M	Attachment: Total Counter	ENG	[0 to 99999999 / 0 / 1/step]
7-936-024	Toner Bottle Log 3: M	Refill Information	ENG*	[0 to 1 / 0 / 1/step]
7-936-031	Toner Bottle Log 4: M	SerialNo.	ENG	[0 to 1 / 0 / 1/step]
7-936-032	Toner Bottle Log 4: M	Attachment Date	ENG	[0 to 1 / 0 / 1/step]
7-936-033	Toner Bottle Log 4: M	Attachment: Total Counter	ENG	[0 to 99999999 / 0 / 1/step]
7-936-034	Toner Bottle Log 4: M	Refill Information	ENG*	[0 to 1 / 0 / 1/step]
7-936-041	Toner Bottle Log 5: M	SerialNo.	ENG	[0 to 1 / 0 / 1/step]
7-936-042	Toner Bottle Log 5: M	Attachment Date	ENG	[0 to 1 / 0 / 1/step]

3.SP Mode Tables

SP No.	Large Category	Small Category	ENG or CTL	[Min to Max/Init./Step]
7-936-043	Toner Bottle Log 5: M	Attachment: Total Counter	ENG	[0 to 99999999 / 0 / 1/step]
7-936-044	Toner Bottle Log 5: M	Refill Information	ENG*	[0 to 1 / 0 / 1/step]
7-937-001	Toner Bottle Log 1: C	SerialNo.	ENG	[0 to 1 / 0 / 1/step]
7-937-002	Toner Bottle Log 1: C	Attachment Date	ENG	[0 to 1 / 0 / 1/step]
7-937-003	Toner Bottle Log 1: C	Attachment: Total Counter	ENG	[0 to 99999999 / 0 / 1/step]
7-937-004	Toner Bottle Log 1: C	Refill Information	ENG*	[0 to 1 / 0 / 1/step]
7-937-011	Toner Bottle Log 2: C	SerialNo.	ENG	[0 to 1 / 0 / 1/step]
7-937-012	Toner Bottle Log 2: C	Attachment Date	ENG	[0 to 1 / 0 / 1/step]
7-937-013	Toner Bottle Log 2: C	Attachment: Total Counter	ENG	[0 to 99999999 / 0 / 1/step]
7-937-014	Toner Bottle Log 2: C	Refill Information	ENG*	[0 to 1 / 0 / 1/step]
7-937-021	Toner Bottle Log 3: C	SerialNo.	ENG	[0 to 1 / 0 / 1/step]
7-937-022	Toner Bottle Log 3: C	Attachment Date	ENG	[0 to 1 / 0 / 1/step]

3.SP Mode Tables

SP No.	Large Category	Small Category	ENG or CTL	[Min to Max/Init./Step]
7-937-023	Toner Bottle Log 3: C	Attachment: Total Counter	ENG	[0 to 99999999 / 0 / 1/step]
7-937-024	Toner Bottle Log 3: C	Refill Information	ENG*	[0 to 1 / 0 / 1/step]
7-937-031	Toner Bottle Log 4: C	SerialNo.	ENG	[0 to 1 / 0 / 1/step]
7-937-032	Toner Bottle Log 4: C	Attachment Date	ENG	[0 to 1 / 0 / 1/step]
7-937-033	Toner Bottle Log 4: C	Attachment: Total Counter	ENG	[0 to 99999999 / 0 / 1/step]
7-937-034	Toner Bottle Log 4: C	Refill Information	ENG*	[0 to 1 / 0 / 1/step]
7-937-041	Toner Bottle Log 5: C	SerialNo.	ENG	[0 to 1 / 0 / 1/step]
7-937-042	Toner Bottle Log 5: C	Attachment Date	ENG	[0 to 1 / 0 / 1/step]
7-937-043	Toner Bottle Log 5: C	Attachment: Total Counter	ENG	[0 to 99999999 / 0 / 1/step]
7-937-044	Toner Bottle Log 5: C	Refill Information	ENG*	[0 to 1 / 0 / 1/step]
7-938-001	Toner Bottle Log 1: Y	SerialNo.	ENG	[0 to 1 / 0 / 1/step]
7-938-002	Toner Bottle Log 1: Y	Attachment Date	ENG	[0 to 1 / 0 / 1/step]

3.SP Mode Tables

SP No.	Large Category	Small Category	ENG or CTL	[Min to Max/Init./Step]
7-938-003	Toner Bottle Log 1: Y	Attachment: Total Counter	ENG	[0 to 99999999 / 0 / 1/step]
7-938-004	Toner Bottle Log 1: Y	Refill Information	ENG*	[0 to 1 / 0 / 1/step]
7-938-011	Toner Bottle Log 2: Y	SerialNo.	ENG	[0 to 1 / 0 / 1/step]
7-938-012	Toner Bottle Log 2: Y	Attachment Date	ENG	[0 to 1 / 0 / 1/step]
7-938-013	Toner Bottle Log 2: Y	Attachment: Total Counter	ENG	[0 to 99999999 / 0 / 1/step]
7-938-014	Toner Bottle Log 2: Y	Refill Information	ENG*	[0 to 1 / 0 / 1/step]
7-938-021	Toner Bottle Log 3: Y	SerialNo.	ENG	[0 to 1 / 0 / 1/step]
7-938-022	Toner Bottle Log 3: Y	Attachment Date	ENG	[0 to 1 / 0 / 1/step]
7-938-023	Toner Bottle Log 3: Y	Attachment: Total Counter	ENG	[0 to 99999999 / 0 / 1/step]
7-938-024	Toner Bottle Log 3: Y	Refill Information	ENG*	[0 to 1 / 0 / 1/step]
7-938-031	Toner Bottle Log 4: Y	SerialNo.	ENG	[0 to 1 / 0 / 1/step]
7-938-032	Toner Bottle Log 4: Y	Attachment Date	ENG	[0 to 1 / 0 / 1/step]

3.SP Mode Tables

SP No.	Large Category	Small Category	ENG or CTL	[Min to Max/Init./Step]
7-938-033	Toner Bottle Log 4: Y	Attachment: Total Counter	ENG	[0 to 99999999 / 0 / 1/step]
7-938-034	Toner Bottle Log 4: Y	Refill Information	ENG*	[0 to 1 / 0 / 1/step]
7-938-041	Toner Bottle Log 5: Y	SerialNo.	ENG	[0 to 1 / 0 / 1/step]
7-938-042	Toner Bottle Log 5: Y	Attachment Date	ENG	[0 to 1 / 0 / 1/step]
7-938-043	Toner Bottle Log 5: Y	Attachment: Total Counter	ENG	[0 to 99999999 / 0 / 1/step]
7-938-044	Toner Bottle Log 5: Y	Refill Information	ENG*	[0 to 1 / 0 / 1/step]
7-940-002	PM Value Setting:Life Distance	# PCU:K	ENG	[0 to 999999999 / 0 / 1mm/step]
7-940-003	PM Value Setting:Life Distance	# Dev Unit:K	ENG	[0 to 999999999 / 0 / 1mm/step]
7-940-004	PM Value Setting:Life Distance	Developer:K	ENG	[0 to 999999999 / 0 / 1mm/step]
7-940-025	PM Value Setting:Life Distance	# PCU:C	ENG	[0 to 999999999 / 0 / 1mm/step]
7-940-026	PM Value Setting:Life Distance	# Dev Unit:C	ENG	[0 to 999999999 / 0 / 1mm/step]
7-940-027	PM Value Setting:Life Distance	Developer:C	ENG	[0 to 999999999 / 0 / 1mm/step]

3.SP Mode Tables

SP No.	Large Category	Small Category	ENG or CTL	[Min to Max/Init./Step]
7-940-048	PM Value Setting:Life Distance	# PCU:M	ENG	[0 to 999999999 / 0 / 1mm/step]
7-940-049	PM Value Setting:Life Distance	# Dev Unit:M	ENG	[0 to 999999999 / 0 / 1mm/step]
7-940-050	PM Value Setting:Life Distance	Developer:M	ENG	[0 to 999999999 / 0 / 1mm/step]
7-940-071	PM Value Setting:Life Distance	# PCU:Y	ENG	[0 to 999999999 / 0 / 1mm/step]
7-940-072	PM Value Setting:Life Distance	# Dev Unit:Y	ENG	[0 to 999999999 / 0 / 1mm/step]
7-940-073	PM Value Setting:Life Distance	Developer:Y	ENG	[0 to 999999999 / 0 / 1mm/step]
7-940-093	PM Value Setting:Life Distance	# ITB Unit	ENG	IM C3500: [0 to 999999999 / 261933861 / 1mm/step] IM C2500: [0 to 999999999 / 128410397 / 1mm/step] IM C2000: [0 to 999999999 / 128410397 / 1mm/step] IM C3000: [0 to 999999999 / 261933861 / 1mm/step]
7-940-102	PM Value Setting:Life Distance	# ITB Cleaning Unit	ENG	IM C3500: [0 to 999999999 / 261933860 /

SP No.	Large Category	Small Category	ENG or CTL	[Min to Max/Init./Step]
				1mm/step] IM C2500: [0 to 999999999 / 128410397 / 1mm/step] IM C2000: [0 to 999999999 / 128410397 / 1mm/step] IM C3000: [0 to 999999999 / 261933860 / 1mm/step]
7-940-109	PM Value Setting:Life Distance	# PTR Unit	ENG	IM C3500: [0 to 999999999 / 392900792 / 1mm/step] IM C2500: [0 to 999999999 / 128410397 / 1mm/step] IM C2000: [0 to 999999999 / 128410397 / 1mm/step] IM C3000: [0 to 999999999 / 392900792 / 1mm/step]
7-940-115	PM Value Setting:Life Distance	# Fusing Unit	ENG	IM C3500: [0 to 999999999 / 291305000 / 1mm/step] IM C2500: [0 to 999999999 / 291305000 / 1mm/step]

3.SP Mode Tables

SP No.	Large Category	Small Category	ENG or CTL	[Min to Max/Init./Step]
				IM C2000: [0 to 999999999 / 291305000 / 1mm/step] IM C3000: [0 to 999999999 / 291305000 / 1mm/step]
7-940-116	PM Value Setting:Life Distance	Fusing Belt	ENG	IM C3500: [0 to 999999999 / 291305000 / 1mm/step] IM C2500: [0 to 999999999 / 291305000 / 1mm/step] IM C2000: [0 to 999999999 / 291305000 / 1mm/step] IM C3000: [0 to 999999999 / 291305000 / 1mm/step]
7-940-118	PM Value Setting:Life Distance	Pressure Roller	ENG	IM C3500: [0 to 999999999 / 291305000 / 1mm/step] IM C2500: [0 to 999999999 / 291305000 / 1mm/step] IM C2000: [0 to 999999999 / 291305000 / 1mm/step] IM C3000:

3.SP Mode Tables

SP No.	Large Category	Small Category	ENG or CTL	[Min to Max/Init./Step]
				[0 to 999999999 / 291305000 / 1mm/step]
7-942-002	PM Counter Display:Distance(%)	# PCU:K	ENG	[0 to 255 / 0 / 1%/step]
7-942-003	PM Counter Display:Distance(%)	# Dev Unit:K	ENG	[0 to 255 / 0 / 1%/step]
7-942-004	PM Counter Display:Distance(%)	Developer:K	ENG	[0 to 255 / 0 / 1%/step]
7-942-025	PM Counter Display:Distance(%)	# PCU:C	ENG	[0 to 255 / 0 / 1%/step]
7-942-026	PM Counter Display:Distance(%)	# Dev Unit:C	ENG	[0 to 255 / 0 / 1%/step]
7-942-027	PM Counter Display:Distance(%)	Developer:C	ENG	[0 to 255 / 0 / 1%/step]
7-942-048	PM Counter Display:Distance(%)	# PCU:M	ENG	[0 to 255 / 0 / 1%/step]
7-942-049	PM Counter Display:Distance(%)	# Dev Unit:M	ENG	[0 to 255 / 0 / 1%/step]
7-942-050	PM Counter Display:Distance(%)	Developer:M	ENG	[0 to 255 / 0 / 1%/step]
7-942-071	PM Counter Display:Distance(%)	# PCU:Y	ENG	[0 to 255 / 0 / 1%/step]
7-942-072	PM Counter Display:Distance(%)	# Dev Unit:Y	ENG	[0 to 255 / 0 / 1%/step]

3.SP Mode Tables

SP No.	Large Category	Small Category	ENG or CTL	[Min to Max/Init./Step]
7-942-073	PM Counter Display:Distance(%)	Developer:Y	ENG	[0 to 255 / 0 / 1%/step]
7-942-093	PM Counter Display:Distance(%)	# ITB Unit	ENG	[0 to 255 / 0 / 1%/step]
7-942-102	PM Counter Display:Distance(%)	# ITB Cleaning Unit	ENG	[0 to 255 / 0 / 1%/step]
7-942-109	PM Counter Display:Distance(%)	# PTR Unit	ENG	[0 to 255 / 0 / 1%/step]
7-942-115	PM Counter Display:Distance(%)	# Fusing Unit	ENG	[0 to 255 / 0 / 1%/step]
7-942-116	PM Counter Display:Distance(%)	Fusing Belt	ENG	[0 to 255 / 0 / 1%/step]
7-942-118	PM Counter Display:Distance(%)	Pressure Roller	ENG	[0 to 255 / 0 / 1%/step]
7-944-002	PM Counter Display: Distance	# PCU:K	ENG*	[0 to 4294967295 / 0 / 1mm/step]
7-944-003	PM Counter Display: Distance	# Dev Unit:K	ENG*	[0 to 4294967295 / 0 / 1mm/step]
7-944-004	PM Counter Display: Distance	Developer:K	ENG*	[0 to 4294967295 / 0 / 1mm/step]
7-944-025	PM Counter Display: Distance	# PCU:C	ENG*	[0 to 4294967295 / 0 / 1mm/step]
7-944-026	PM Counter Display: Distance	# Dev Unit:C	ENG*	[0 to 4294967295 / 0 / 1mm/step]

3.SP Mode Tables

SP No.	Large Category	Small Category	ENG or CTL	[Min to Max/Init./Step]
7-944-027	PM Counter Display: Distance	Developer:C	ENG*	[0 to 4294967295 / 0 / 1mm/step]
7-944-048	PM Counter Display: Distance	# PCU:M	ENG*	[0 to 4294967295 / 0 / 1mm/step]
7-944-049	PM Counter Display: Distance	# Dev Unit:M	ENG*	[0 to 4294967295 / 0 / 1mm/step]
7-944-050	PM Counter Display: Distance	Developer:M	ENG*	[0 to 4294967295 / 0 / 1mm/step]
7-944-071	PM Counter Display: Distance	# PCU:Y	ENG*	[0 to 4294967295 / 0 / 1mm/step]
7-944-072	PM Counter Display: Distance	# Dev Unit:Y	ENG*	[0 to 4294967295 / 0 / 1mm/step]
7-944-073	PM Counter Display: Distance	Developer:Y	ENG*	[0 to 4294967295 / 0 / 1mm/step]
7-944-093	PM Counter Display: Distance	# ITB Unit	ENG*	[0 to 4294967295 / 0 / 1mm/step]
7-944-102	PM Counter Display: Distance	# ITB Cleaning Unit	ENG	[0 to 4294967295 / 0 / 1mm/step]
7-944-109	PM Counter Display: Distance	# PTR Unit	ENG	[0 to 4294967295 / 0 / 1mm/step]
7-944-115	PM Counter Display: Distance	# Fusing Unit	ENG	[0 to 4294967295 / 0 / 1mm/step]
7-944-116	PM Counter Display: Distance	Fusing Belt	ENG	[0 to 4294967295 / 0 / 1mm/step]

3.SP Mode Tables

SP No.	Large Category	Small Category	ENG or CTL	[Min to Max/Init./Step]
7-944-118	PM Counter Display: Distance	Pressure Roller	ENG	[0 to 4294967295 / 0 / 1mm/step]
7-944-230	PM Counter Display: Distance	Low Speed: # PCU:K	ENG	[0 to 4294967295 / 0 / 1mm/step]
7-944-231	PM Counter Display: Distance	Low Speed: # PCU:C	ENG	[0 to 4294967295 / 0 / 1mm/step]
7-944-232	PM Counter Display: Distance	Low Speed: # PCU:M	ENG	[0 to 4294967295 / 0 / 1mm/step]
7-944-233	PM Counter Display: Distance	Low Speed: # PCU:Y	ENG	[0 to 4294967295 / 0 / 1mm/step]
7-944-234	PM Counter Display: Distance	Middle Speed: # PCU:K	ENG	[0 to 4294967295 / 0 / 1mm/step]
7-944-235	PM Counter Display: Distance	Middle Speed: # PCU:C	ENG	[0 to 4294967295 / 0 / 1mm/step]
7-944-236	PM Counter Display: Distance	Middle Speed: # PCU:M	ENG	[0 to 4294967295 / 0 / 1mm/step]
7-944-237	PM Counter Display: Distance	Middle Speed: # PCU:Y	ENG	[0 to 4294967295 / 0 / 1mm/step]
7-950-002	Unit Replacement Date	# PCU:K	ENG*	[0 to 1 / 0 / 1/step]
7-950-003	Unit Replacement Date	# Dev Unit:K	ENG*	[0 to 1 / 0 / 1/step]
7-950-004	Unit Replacement Date	Developer:K	ENG*	[0 to 1 / 0 / 1/step]

3.SP Mode Tables

SP No.	Large Category	Small Category	ENG or CTL	[Min to Max/Init./Step]
7-950-025	Unit Replacement Date	# PCU:C	ENG*	[0 to 1 / 0 / 1/step]
7-950-026	Unit Replacement Date	# Dev Unit:C	ENG*	[0 to 1 / 0 / 1/step]
7-950-027	Unit Replacement Date	Developer:C	ENG*	[0 to 1 / 0 / 1/step]
7-950-048	Unit Replacement Date	# PCU:M	ENG*	[0 to 1 / 0 / 1/step]
7-950-049	Unit Replacement Date	# Dev Unit:M	ENG*	[0 to 1 / 0 / 1/step]
7-950-050	Unit Replacement Date	Developer:M	ENG*	[0 to 1 / 0 / 1/step]
7-950-071	Unit Replacement Date	# PCU:Y	ENG*	[0 to 1 / 0 / 1/step]
7-950-072	Unit Replacement Date	# Dev Unit:Y	ENG*	[0 to 1 / 0 / 1/step]
7-950-073	Unit Replacement Date	Developer:Y	ENG*	[0 to 1 / 0 / 1/step]
7-950-093	Unit Replacement Date	# ITB Unit	ENG*	[0 to 1 / 0 / 1/step]
7-950-102	Unit Replacement Date	# ITB Cleaning Unit	ENG*	[0 to 1 / 0 / 1/step]
7-950-109	Unit Replacement Date	# PTR Unit	ENG*	[0 to 1 / 0 / 1/step]

3.SP Mode Tables

SP No.	Large Category	Small Category	ENG or CTL	[Min to Max/Init./Step]
7-950-115	Unit Replacement Date	# Fusing Unit	ENG*	[0 to 1 / 0 / 1/step]
7-950-116	Unit Replacement Date	Fusing Belt	ENG*	[0 to 1 / 0 / 1/step]
7-950-118	Unit Replacement Date	Pressure Roller	ENG*	[0 to 1 / 0 / 1/step]
7-950-131	Unit Replacement Date	Dust Filter	ENG*	[0 to 1 / 0 / 1/step]
7-950-142	Unit Replacement Date	Waste Toner Bottle	ENG*	[0 to 1 / 0 / 1/step]
7-950-206	Unit Replacement Date	ADF Pick-up Roller	ENG*	[0 to 1 / 0 / 1/step]
7-950-207	Unit Replacement Date	ADF Supply Belt	ENG*	[0 to 1 / 0 / 1/step]
7-950-208	Unit Replacement Date	ADF Reverse Roller	ENG*	[0 to 1 / 0 / 1/step]
7-951-002	Remain Day Counter: Pages	# PCU:K	ENG	[0 to 255 / 255 / 1days/step]
7-951-003	Remain Day Counter: Pages	# Dev Unit:K	ENG	[0 to 255 / 255 / 1days/step]
7-951-004	Remain Day Counter: Pages	Developer:K	ENG	[0 to 255 / 255 / 1days/step]
7-951-025	Remain Day Counter: Pages	# PCU:C	ENG	[0 to 255 / 255 / 1days/step]

3.SP Mode Tables

SP No.	Large Category	Small Category	ENG or CTL	[Min to Max/Init./Step]
7-951-026	Remain Day Counter: Pages	# Dev Unit:C	ENG	[0 to 255 / 255 / 1days/step]
7-951-027	Remain Day Counter: Pages	Developer:C	ENG	[0 to 255 / 255 / 1days/step]
7-951-048	Remain Day Counter: Pages	# PCU:M	ENG	[0 to 255 / 255 / 1days/step]
7-951-049	Remain Day Counter: Pages	# Dev Unit:M	ENG	[0 to 255 / 255 / 1days/step]
7-951-050	Remain Day Counter: Pages	Developer:M	ENG	[0 to 255 / 255 / 1days/step]
7-951-071	Remain Day Counter: Pages	# PCU:Y	ENG	[0 to 255 / 255 / 1days/step]
7-951-072	Remain Day Counter: Pages	# Dev Unit:Y	ENG	[0 to 255 / 255 / 1days/step]
7-951-073	Remain Day Counter: Pages	Developer:Y	ENG	[0 to 255 / 255 / 1days/step]
7-951-093	Remain Day Counter: Pages	# ITB Unit	ENG	[0 to 255 / 255 / 1days/step]
7-951-102	Remain Day Counter: Pages	# ITB Cleaning Unit	ENG	[0 to 255 / 255 / 1days/step]
7-951-109	Remain Day Counter: Pages	# PTR Unit	ENG	[0 to 255 / 255 / 1days/step]
7-951-115	Remain Day Counter: Pages	# Fusing Unit	ENG	[0 to 255 / 255 / 1days/step]

3.SP Mode Tables

SP No.	Large Category	Small Category	ENG or CTL	[Min to Max/Init./Step]
7-951-116	Remain Day Counter: Pages	Fusing Belt	ENG	[0 to 255 / 255 / 1days/step]
7-951-118	Remain Day Counter: Pages	Pressure Roller	ENG	[0 to 255 / 255 / 1days/step]
7-951-131	Remain Day Counter: Pages	Dust Filter	ENG	[0 to 255 / 255 / 1days/step]
7-951-142	Remain Day Counter: Pages	Waste Toner Bottle	ENG	[0 to 255 / 255 / 1days/step]
7-951-206	Remain Day Counter: Pages	ADF Pick-up Roller	ENG	[0 to 255 / 255 / 1days/step]
7-951-207	Remain Day Counter: Pages	ADF Supply Belt	ENG	[0 to 255 / 255 / 1days/step]
7-951-208	Remain Day Counter: Pages	ADF Reverse Roller	ENG	[0 to 255 / 255 / 1days/step]
7-952-002	Remain Day Counter: Distance	# PCU:K	ENG	[0 to 255 / 255 / 1days/step]
7-952-003	Remain Day Counter: Distance	# Dev Unit:K	ENG	[0 to 255 / 255 / 1days/step]
7-952-004	Remain Day Counter: Distance	Developer:K	ENG	[0 to 255 / 255 / 1days/step]
7-952-025	Remain Day Counter: Distance	# PCU:C	ENG	[0 to 255 / 255 / 1days/step]
7-952-026	Remain Day Counter: Distance	# Dev Unit:C	ENG	[0 to 255 / 255 / 1days/step]

3.SP Mode Tables

SP No.	Large Category	Small Category	ENG or CTL	[Min to Max/Init./Step]
7-952-027	Remain Day Counter: Distance	Developer:C	ENG	[0 to 255 / 255 / 1days/step]
7-952-048	Remain Day Counter: Distance	# PCU:M	ENG	[0 to 255 / 255 / 1days/step]
7-952-049	Remain Day Counter: Distance	# Dev Unit:M	ENG	[0 to 255 / 255 / 1days/step]
7-952-050	Remain Day Counter: Distance	Developer:M	ENG	[0 to 255 / 255 / 1days/step]
7-952-071	Remain Day Counter: Distance	# PCU:Y	ENG	[0 to 255 / 255 / 1days/step]
7-952-072	Remain Day Counter: Distance	# Dev Unit:Y	ENG	[0 to 255 / 255 / 1days/step]
7-952-073	Remain Day Counter: Distance	Developer:Y	ENG	[0 to 255 / 255 / 1days/step]
7-952-093	Remain Day Counter: Distance	# ITB Unit	ENG	[0 to 255 / 255 / 1days/step]
7-952-102	Remain Day Counter: Distance	# ITB Cleaning Unit	ENG	[0 to 255 / 255 / 1days/step]
7-952-109	Remain Day Counter: Distance	# PTR Unit	ENG	[0 to 255 / 255 / 1days/step]
7-952-115	Remain Day Counter: Distance	# Fusing Unit	ENG	[0 to 255 / 255 / 1days/step]
7-952-116	Remain Day Counter: Distance	Fusing Belt	ENG	[0 to 255 / 255 / 1days/step]

3.SP Mode Tables

SP No.	Large Category	Small Category	ENG or CTL	[Min to Max/Init./Step]
7-952-118	Remain Day Counter: Distance	Pressure Roller	ENG	[0 to 255 / 255 / 1days/step]
7-953-001	Operation Env. Log: PCU: K	$T \leq 0$	ENG	[0 to 999999999 / 0 / 1mm/step]
7-953-002	Operation Env. Log: PCU: K	$0 < T \leq 5:0 \leq H < 30$	ENG	[0 to 999999999 / 0 / 1mm/step]
7-953-003	Operation Env. Log: PCU: K	$0 < T \leq 5:30 \leq H < 70$	ENG	[0 to 999999999 / 0 / 1mm/step]
7-953-004	Operation Env. Log: PCU: K	$0 < T \leq 5:70 \leq H \leq 100$	ENG	[0 to 999999999 / 0 / 1mm/step]
7-953-005	Operation Env. Log: PCU: K	$5 < T < 15:0 \leq H < 30$	ENG	[0 to 999999999 / 0 / 1mm/step]
7-953-006	Operation Env. Log: PCU: K	$5 < T < 15:30 \leq H < 55$	ENG	[0 to 999999999 / 0 / 1mm/step]
7-953-007	Operation Env. Log: PCU: K	$5 < T < 15:55 \leq H < 80$	ENG	[0 to 999999999 / 0 / 1mm/step]
7-953-008	Operation Env. Log: PCU: K	$5 < T < 15:80 \leq H \leq 100$	ENG	[0 to 999999999 / 0 / 1mm/step]
7-953-009	Operation Env. Log: PCU: K	$15 \leq T < 25:0 \leq H < 30$	ENG	[0 to 999999999 / 0 / 1mm/step]
7-953-010	Operation Env. Log: PCU: K	$15 \leq T < 25:30 \leq H < 55$	ENG	[0 to 999999999 / 0 / 1mm/step]
7-953-011	Operation Env. Log: PCU: K	$15 \leq T < 25:55 \leq H < 80$	ENG	[0 to 999999999 / 0 / 1mm/step]

3.SP Mode Tables

SP No.	Large Category	Small Category	ENG or CTL	[Min to Max/Init./Step]
7-953-012	Operation Env. Log: PCU: K	15<=T<25:80<=H<=100	ENG	[0 to 999999999 / 0 / 1mm/step]
7-953-013	Operation Env. Log: PCU: K	25<=T<30:0<=H<30	ENG	[0 to 999999999 / 0 / 1mm/step]
7-953-014	Operation Env. Log: PCU: K	25<=T<30:30<=H<55	ENG	[0 to 999999999 / 0 / 1mm/step]
7-953-015	Operation Env. Log: PCU: K	25<=T<30:55<=H<80	ENG	[0 to 999999999 / 0 / 1mm/step]
7-953-016	Operation Env. Log: PCU: K	25<=T<30:80<=H<=100	ENG	[0 to 999999999 / 0 / 1mm/step]
7-953-017	Operation Env. Log: PCU: K	30<=T:0<=H<30	ENG	[0 to 999999999 / 0 / 1mm/step]
7-953-018	Operation Env. Log: PCU: K	30<=T:30<=H<55	ENG	[0 to 999999999 / 0 / 1mm/step]
7-953-019	Operation Env. Log: PCU: K	30<=T:55<=H<80	ENG	[0 to 999999999 / 0 / 1mm/step]
7-953-020	Operation Env. Log: PCU: K	30<=T:80<=H<=100	ENG	[0 to 999999999 / 0 / 1mm/step]
7-953-021	Operation Env. Log: PCU: K	35<=T:0<=H<=100	ENG	[0 to 999999999 / 0 / 1mm/step]
7-953-100	Operation Env. Log Clear		ENG	[0 to 1 / 0 / 1/step]
7-954-002	PM Counter Display: Pages (%)	# PCU:K	ENG	[0 to 255 / 0 / 1%/step]

3.SP Mode Tables

SP No.	Large Category	Small Category	ENG or CTL	[Min to Max/Init./Step]
7-954-003	PM Counter Display: Pages (%)	# Dev Unit:K	ENG	[0 to 255 / 0 / 1%/step]
7-954-004	PM Counter Display: Pages (%)	Developer:K	ENG	[0 to 255 / 0 / 1%/step]
7-954-025	PM Counter Display: Pages (%)	# PCU:C	ENG	[0 to 255 / 0 / 1%/step]
7-954-026	PM Counter Display: Pages (%)	# Dev Unit:C	ENG	[0 to 255 / 0 / 1%/step]
7-954-027	PM Counter Display: Pages (%)	Developer:C	ENG	[0 to 255 / 0 / 1%/step]
7-954-048	PM Counter Display: Pages (%)	# PCU:M	ENG	[0 to 255 / 0 / 1%/step]
7-954-049	PM Counter Display: Pages (%)	# Dev Unit:M	ENG	[0 to 255 / 0 / 1%/step]
7-954-050	PM Counter Display: Pages (%)	Developer:M	ENG	[0 to 255 / 0 / 1%/step]
7-954-071	PM Counter Display: Pages (%)	# PCU:Y	ENG	[0 to 255 / 0 / 1%/step]
7-954-072	PM Counter Display: Pages (%)	# Dev Unit:Y	ENG	[0 to 255 / 0 / 1%/step]
7-954-073	PM Counter Display: Pages (%)	Developer:Y	ENG	[0 to 255 / 0 / 1%/step]
7-954-093	PM Counter Display: Pages (%)	# ITB Unit	ENG	[0 to 255 / 0 / 1%/step]

3.SP Mode Tables

SP No.	Large Category	Small Category	ENG or CTL	[Min to Max/Init./Step]
7-954-102	PM Counter Display: Pages (%)	# ITB Cleaning Unit	ENG	[0 to 255 / 0 / 1%/step]
7-954-109	PM Counter Display: Pages (%)	# PTR Unit	ENG	[0 to 255 / 0 / 1%/step]
7-954-115	PM Counter Display: Pages (%)	# Fusing Unit	ENG	[0 to 255 / 0 / 1%/step]
7-954-116	PM Counter Display: Pages (%)	Fusing Belt	ENG	[0 to 255 / 0 / 1%/step]
7-954-118	PM Counter Display: Pages (%)	Pressure Roller	ENG	[0 to 255 / 0 / 1%/step]
7-954-131	PM Counter Display: Pages (%)	Dust Filter	ENG	[0 to 255 / 0 / 1%/step]
7-954-142	PM Counter Display: Pages (%)	Waste Toner Bottle	ENG	[0 to 255 / 0 / 1%/step]
7-954-206	PM Counter Display: Pages (%)	ADF Pick-up Roller	ENG	[0 to 255 / 0 / 1%/step]
7-954-207	PM Counter Display: Pages (%)	ADF Supply Belt	ENG	[0 to 255 / 0 / 1%/step]
7-954-208	PM Counter Display: Pages (%)	ADF Reverse Roller	ENG	[0 to 255 / 0 / 1%/step]
7-955-002	Estimated Remain Pages	# PCU:K	ENG	[0 to 9999999 / 0 / 1page/step]
7-955-003	Estimated Remain Pages	# Dev Unit:K	ENG	[0 to 9999999 / 0 / 1page/step]

3.SP Mode Tables

SP No.	Large Category	Small Category	ENG or CTL	[Min to Max/Init./Step]
7-955-004	Estimated Remain Pages	Developer:K	ENG	[0 to 9999999 / 0 / 1page/step]
7-955-025	Estimated Remain Pages	# PCU:C	ENG	[0 to 9999999 / 0 / 1page/step]
7-955-026	Estimated Remain Pages	# Dev Unit:C	ENG	[0 to 9999999 / 0 / 1page/step]
7-955-027	Estimated Remain Pages	Developer:C	ENG	[0 to 9999999 / 0 / 1page/step]
7-955-048	Estimated Remain Pages	# PCU:M	ENG	[0 to 9999999 / 0 / 1page/step]
7-955-049	Estimated Remain Pages	# Dev Unit:M	ENG	[0 to 9999999 / 0 / 1page/step]
7-955-050	Estimated Remain Pages	Developer:M	ENG	[0 to 9999999 / 0 / 1page/step]
7-955-071	Estimated Remain Pages	# PCU:Y	ENG	[0 to 9999999 / 0 / 1page/step]
7-955-072	Estimated Remain Pages	# Dev Unit:Y	ENG	[0 to 9999999 / 0 / 1page/step]
7-955-073	Estimated Remain Pages	Developer:Y	ENG	[0 to 9999999 / 0 / 1page/step]
7-955-093	Estimated Remain Pages	# ITB Unit	ENG	[0 to 9999999 / 0 / 1page/step]
7-955-102	Estimated Remain Pages	# ITB Cleaning Unit	ENG	[0 to 9999999 / 0 / 1page/step]

3.SP Mode Tables

SP No.	Large Category	Small Category	ENG or CTL	[Min to Max/Init./Step]
7-955-109	Estimated Remain Pages	# PTR Unit	ENG	[0 to 9999999 / 0 / 1page/step]
7-955-115	Estimated Remain Pages	# Fusing Unit	ENG	[0 to 9999999 / 0 / 1page/step]
7-955-116	Estimated Remain Pages	Fusing Belt	ENG	[0 to 9999999 / 0 / 1page/step]
7-955-118	Estimated Remain Pages	Pressure Roller	ENG	[0 to 9999999 / 0 / 1page/step]
7-956-002	Estimated Remain Days	# PCU:K	ENG	[0 to 255 / 255 / 1days/step]
7-956-003	Estimated Remain Days	# Dev Unit:K	ENG	[0 to 255 / 255 / 1days/step]
7-956-004	Estimated Remain Days	Developer:K	ENG	[0 to 255 / 255 / 1days/step]
7-956-025	Estimated Remain Days	# PCU:C	ENG	[0 to 255 / 255 / 1days/step]
7-956-026	Estimated Remain Days	# Dev Unit:C	ENG	[0 to 255 / 255 / 1days/step]
7-956-027	Estimated Remain Days	Developer:C	ENG	[0 to 255 / 255 / 1days/step]
7-956-048	Estimated Remain Days	# PCU:M	ENG	[0 to 255 / 255 / 1days/step]
7-956-049	Estimated Remain Days	# Dev Unit:M	ENG	[0 to 255 / 255 / 1days/step]

3.SP Mode Tables

SP No.	Large Category	Small Category	ENG or CTL	[Min to Max/Init./Step]
7-956-050	Estimated Remain Days	Developer:M	ENG	[0 to 255 / 255 / 1days/step]
7-956-071	Estimated Remain Days	# PCU:Y	ENG	[0 to 255 / 255 / 1days/step]
7-956-072	Estimated Remain Days	# Dev Unit:Y	ENG	[0 to 255 / 255 / 1days/step]
7-956-073	Estimated Remain Days	Developer:Y	ENG	[0 to 255 / 255 / 1days/step]
7-956-093	Estimated Remain Days	# ITB Unit	ENG	[0 to 255 / 255 / 1days/step]
7-956-102	Estimated Remain Days	# ITB Cleaning Unit	ENG	[0 to 255 / 255 / 1days/step]
7-956-109	Estimated Remain Days	# PTR Unit	ENG	[0 to 255 / 255 / 1days/step]
7-956-115	Estimated Remain Days	# Fusing Unit	ENG	[0 to 255 / 255 / 1days/step]
7-956-116	Estimated Remain Days	Fusing Belt	ENG	[0 to 255 / 255 / 1days/step]
7-956-118	Estimated Remain Days	Pressure Roller	ENG	[0 to 255 / 255 / 1days/step]
7-956-131	Estimated Remain Days	Dust Filter	ENG	[0 to 255 / 255 / 1days/step]
7-956-142	Estimated Remain Days	Waste Toner Bottle	ENG	[0 to 255 / 255 / 1days/step]

3.SP Mode Tables

SP No.	Large Category	Small Category	ENG or CTL	[Min to Max/Init./Step]
7-956-206	Estimated Remain Days	ADF Pick-up Roller	ENG	[0 to 255 / 255 / 1days/step]
7-956-207	Estimated Remain Days	ADF Supply Belt	ENG	[0 to 255 / 255 / 1days/step]
7-956-208	Estimated Remain Days	ADF Reverse Roller	ENG	[0 to 255 / 255 / 1days/step]
7-957-002	Monthly Average Pages	# PCU:K	ENG	[0 to 9999999 / 0 / 1page/step]
7-957-003	Monthly Average Pages	# Dev Unit:K	ENG	[0 to 9999999 / 0 / 1page/step]
7-957-004	Monthly Average Pages	Developer:K	ENG	[0 to 9999999 / 0 / 1page/step]
7-957-025	Monthly Average Pages	# PCU:C	ENG	[0 to 9999999 / 0 / 1page/step]
7-957-026	Monthly Average Pages	# Dev Unit:C	ENG	[0 to 9999999 / 0 / 1page/step]
7-957-027	Monthly Average Pages	Developer:C	ENG	[0 to 9999999 / 0 / 1page/step]
7-957-048	Monthly Average Pages	# PCU:M	ENG	[0 to 9999999 / 0 / 1page/step]
7-957-049	Monthly Average Pages	# Dev Unit:M	ENG	[0 to 9999999 / 0 / 1page/step]
7-957-050	Monthly Average Pages	Developer:M	ENG	[0 to 9999999 / 0 / 1page/step]

3.SP Mode Tables

SP No.	Large Category	Small Category	ENG or CTL	[Min to Max/Init./Step]
7-957-071	Monthly Average Pages	# PCU:Y	ENG	[0 to 9999999 / 0 / 1page/step]
7-957-072	Monthly Average Pages	# Dev Unit:Y	ENG	[0 to 9999999 / 0 / 1page/step]
7-957-073	Monthly Average Pages	Developer:Y	ENG	[0 to 9999999 / 0 / 1page/step]
7-957-093	Monthly Average Pages	# ITB Unit	ENG	[0 to 9999999 / 0 / 1page/step]
7-957-102	Monthly Average Pages	# ITB Cleaning Unit	ENG	[0 to 9999999 / 0 / 1page/step]
7-957-109	Monthly Average Pages	# PTR Unit	ENG	[0 to 9999999 / 0 / 1page/step]
7-957-115	Monthly Average Pages	# Fusing Unit	ENG	[0 to 9999999 / 0 / 1page/step]
7-957-116	Monthly Average Pages	Fusing Belt	ENG	[0 to 9999999 / 0 / 1page/step]
7-957-118	Monthly Average Pages	Pressure Roller	ENG	[0 to 9999999 / 0 / 1page/step]
7-958-002	PM Value Setting:DaysThreshold	# PCU:K	ENG	[1 to 30 / 15 / 1days/step]
7-958-003	PM Value Setting:DaysThreshold	# Dev Unit:K	ENG	[1 to 30 / 15 / 1days/step]
7-958-004	PM Value Setting:DaysThreshold	Developer:K	ENG	[1 to 30 / 15 / 1days/step]

3.SP Mode Tables

SP No.	Large Category	Small Category	ENG or CTL	[Min to Max/Init./Step]
7-958-025	PM Value Setting:DaysThreshold	# PCU:C	ENG	[1 to 30 / 15 / 1days/step]
7-958-026	PM Value Setting:DaysThreshold	# Dev Unit:C	ENG	[1 to 30 / 15 / 1days/step]
7-958-027	PM Value Setting:DaysThreshold	Developer:C	ENG	[1 to 30 / 15 / 1days/step]
7-958-048	PM Value Setting:DaysThreshold	# PCU:M	ENG	[1 to 30 / 15 / 1days/step]
7-958-049	PM Value Setting:DaysThreshold	# Dev Unit:M	ENG	[1 to 30 / 15 / 1days/step]
7-958-050	PM Value Setting:DaysThreshold	Developer:M	ENG	[1 to 30 / 15 / 1days/step]
7-958-071	PM Value Setting:DaysThreshold	# PCU:Y	ENG	[1 to 30 / 15 / 1days/step]
7-958-072	PM Value Setting:DaysThreshold	# Dev Unit:Y	ENG	[1 to 30 / 15 / 1days/step]
7-958-073	PM Value Setting:DaysThreshold	Developer:Y	ENG	[1 to 30 / 15 / 1days/step]
7-958-093	PM Value Setting:DaysThreshold	# ITB Unit	ENG	[1 to 30 / 15 / 1days/step]
7-958-102	PM Value Setting:DaysThreshold	# ITB Cleaning Unit	ENG	[1 to 30 / 15 / 1days/step]
7-958-109	PM Value Setting:DaysThreshold	# PTR Unit	ENG	[1 to 30 / 15 / 1days/step]

3.SP Mode Tables

SP No.	Large Category	Small Category	ENG or CTL	[Min to Max/Init./Step]
7-958-115	PM Value Setting:DaysThreshold	# Fusing Unit	ENG	[1 to 30 / 15 / 1days/step]
7-958-116	PM Value Setting:DaysThreshold	Fusing Belt	ENG	[1 to 30 / 15 / 1days/step]
7-958-118	PM Value Setting:DaysThreshold	Pressure Roller	ENG	[1 to 30 / 15 / 1days/step]
7-958-131	PM Value Setting:DaysThreshold	Dust Filter	ENG	[1 to 30 / 15 / 1days/step]
7-958-142	PM Value Setting:DaysThreshold	Waste Toner Bottle	ENG	[1 to 30 / 15 / 1days/step]
7-958-206	PM Value Setting:DaysThreshold	ADF Pick-up Roller	ENG	[1 to 30 / 15 / 1days/step]
7-958-207	PM Value Setting:DaysThreshold	ADF Supply Belt	ENG	[1 to 30 / 15 / 1days/step]
7-958-208	PM Value Setting:DaysThreshold	ADF Reverse Roller	ENG	[1 to 30 / 15 / 1days/step]
7-960-002	Estimated Usage Rate	# PCU:K	ENG	[0 to 255 / 0 / 1%/step]
7-960-003	Estimated Usage Rate	# Dev Unit:K	ENG	[0 to 255 / 0 / 1%/step]
7-960-004	Estimated Usage Rate	Developer:K	ENG	[0 to 255 / 0 / 1%/step]
7-960-025	Estimated Usage Rate	# PCU:C	ENG	[0 to 255 / 0 / 1%/step]

3.SP Mode Tables

SP No.	Large Category	Small Category	ENG or CTL	[Min to Max/Init./Step]
7-960-026	Estimated Usage Rate	# Dev Unit:C	ENG	[0 to 255 / 0 / 1%/step]
7-960-027	Estimated Usage Rate	Developer:C	ENG	[0 to 255 / 0 / 1%/step]
7-960-048	Estimated Usage Rate	# PCU:M	ENG	[0 to 255 / 0 / 1%/step]
7-960-049	Estimated Usage Rate	# Dev Unit:M	ENG	[0 to 255 / 0 / 1%/step]
7-960-050	Estimated Usage Rate	Developer:M	ENG	[0 to 255 / 0 / 1%/step]
7-960-071	Estimated Usage Rate	# PCU:Y	ENG	[0 to 255 / 0 / 1%/step]
7-960-072	Estimated Usage Rate	# Dev Unit:Y	ENG	[0 to 255 / 0 / 1%/step]
7-960-073	Estimated Usage Rate	Developer:Y	ENG	[0 to 255 / 0 / 1%/step]
7-960-093	Estimated Usage Rate	# ITB Unit	ENG	[0 to 255 / 0 / 1%/step]
7-960-102	Estimated Usage Rate	# ITB Cleaning Unit	ENG	[0 to 255 / 0 / 1%/step]
7-960-109	Estimated Usage Rate	# PTR Unit	ENG	[0 to 255 / 0 / 1%/step]
7-960-115	Estimated Usage Rate	# Fusing Unit	ENG	[0 to 255 / 0 / 1%/step]

3.SP Mode Tables

SP No.	Large Category	Small Category	ENG or CTL	[Min to Max/Init./Step]
7-960-116	Estimated Usage Rate	Fusing Belt	ENG	[0 to 255 / 0 / 1%/step]
7-960-118	Estimated Usage Rate	Pressure Roller	ENG	[0 to 255 / 0 / 1%/step]
7-960-131	Estimated Usage Rate	Dust Filter	ENG	[0 to 255 / 0 / 1%/step]
7-960-142	Estimated Usage Rate	Waste Toner Bottle	ENG	[0 to 255 / 0 / 1%/step]
7-960-206	Estimated Usage Rate	ADF Pick-up Roller	ENG	[0 to 255 / 0 / 1%/step]
7-960-207	Estimated Usage Rate	ADF Supply Belt	ENG	[0 to 255 / 0 / 1%/step]
7-960-208	Estimated Usage Rate	ADF Reverse Roller	ENG	[0 to 255 / 0 / 1%/step]
7-978-001	SC670-01 Log	First Occurred	ENG*	[0 to 1 / 0 / 1/step]
7-978-002	SC670-01 Log	First Data1	ENG*	[0x00000000 to 0xFFFFFFFF / 0x00000000 / 1/step]
7-978-003	SC670-01 Log	First Data2	ENG*	[0x00000000 to 0xFFFFFFFF / 0x00000000 / 1/step]
7-978-004	SC670-01 Log	First Data3	ENG*	[0x00000000 to 0xFFFFFFFF / 0x00000000 / 1/step]
7-978-005	SC670-01 Log	First Data4	ENG*	[0x00000000 to 0xFFFFFFFF / 0x00000000 / 1/step]

SP No.	Large Category	Small Category	ENG or CTL	[Min to Max/Init./Step]
7-978-006	SC670-01 Log	First Data5	ENG*	[0x00000000 to 0xFFFFFFFF / 0x00000000 / 1/step]
7-978-011	SC670-01 Log	Latest Occurred	ENG*	[0 to 1 / 0 / 1/step]
7-978-012	SC670-01 Log	Latest Data1	ENG*	[0x00000000 to 0xFFFFFFFF / 0x00000000 / 1/step]
7-978-013	SC670-01 Log	Latest Data2	ENG*	[0x00000000 to 0xFFFFFFFF / 0x00000000 / 1/step]
7-978-014	SC670-01 Log	Latest Data3	ENG*	[0x00000000 to 0xFFFFFFFF / 0x00000000 / 1/step]
7-978-015	SC670-01 Log	Latest Data4	ENG*	[0x00000000 to 0xFFFFFFFF / 0x00000000 / 1/step]
7-978-016	SC670-01 Log	Latest Data5	ENG*	[0x00000000 to 0xFFFFFFFF / 0x00000000 / 1/step]
7-979-001	ENG Reset Log	Data1	ENG*	[0x00 to 0xFF / 0x00 / 1/step]
7-979-002	ENG Reset Log	Data2	ENG*	[0x0000 to 0xFFFF / 0x0000 / 1/step]
7-979-003	ENG Reset Log	Data3	ENG*	[0x0000 to 0xFFFF / 0x0000 / 1/step]
7-979-004	ENG Reset Log	Data4	ENG*	[0x0000 to 0xFFFF / 0x0000 / 1/step]
7-979-005	ENG Reset Log	Data5	ENG*	[0x0000 to 0xFFFF / 0x0000 / 1/step]

3.SP Mode Tables

SP No.	Large Category	Small Category	ENG or CTL	[Min to Max/Init./Step]
7-979-006	ENG Reset Log	Data6	ENG*	[0x0000 to 0xFFFF / 0x0000 / 1/step]
7-979-007	ENG Reset Log	Data7	ENG*	[0x0000 to 0xFFFF / 0x0000 / 1/step]
7-979-008	ENG Reset Log	Data8	ENG*	[0x0000 to 0xFFFF / 0x0000 / 1/step]
7-979-009	ENG Reset Log	Data9	ENG*	[0x0000 to 0xFFFF / 0x0000 / 1/step]
7-979-010	ENG Reset Log	Data10	ENG*	[0x0000 to 0xFFFF / 0x0000 / 1/step]
7-979-011	ENG Reset Log	Data11	ENG*	[0x0000 to 0xFFFF / 0x0000 / 1/step]
7-979-012	ENG Reset Log	Data12	ENG*	[0x0000 to 0xFFFF / 0x0000 / 1/step]
7-979-013	ENG Reset Log	Data13	ENG*	[0x0000 to 0xFFFF / 0x0000 / 1/step]
7-979-014	ENG Reset Log	Data14	ENG*	[0x0000 to 0xFFFF / 0x0000 / 1/step]
7-979-015	ENG Reset Log	Data15	ENG*	[0x0000 to 0xFFFF / 0x0000 / 1/step]
7-979-016	ENG Reset Log	Data16	ENG*	[0x0000 to 0xFFFF / 0x0000 / 1/step]
7-979-017	ENG Reset Log	Data17	ENG*	[0x0000 to 0xFFFF / 0x0000 / 1/step]

3.SP Mode Tables

SP No.	Large Category	Small Category	ENG or CTL	[Min to Max/Init./Step]
7-979-018	ENG Reset Log	Data18	ENG*	[0x0000 to 0xFFFF / 0x0000 / 1/step]
7-979-019	ENG Reset Log	Data19	ENG*	[0x0000 to 0xFFFF / 0x0000 / 1/step]
7-979-020	ENG Reset Log	Data20	ENG*	[0x0000 to 0xFFFF / 0x0000 / 1/step]
7-979-021	ENG Reset Log	Data21	ENG*	[0x0000 to 0xFFFF / 0x0000 / 1/step]
7-980-001	Current for Torque Calculation	OPCTransferMotor	ENG*	[0.000 to 9.999 / 0.000 / 0.001A/step]
7-980-002	Current for Torque Calculation	BkDevMotor	ENG*	[0.000 to 9.999 / 0.000 / 0.001A/step]
7-980-003	Current for Torque Calculation	ColorOpcMotor	ENG*	[0.000 to 9.999 / 0.000 / 0.001A/step]
7-980-004	Current for Torque Calculation	ColorDevMotor	ENG*	[0.000 to 9.999 / 0.000 / 0.001A/step]
7-980-005	Current for Torque Calculation	FusingMotor	ENG*	[0.000 to 9.999 / 0.000 / 0.001A/step]
7-981-001	Edict:OffsetValueForTorqCalcu	ManualExe	ENG	[0 to 1 / 0 / 1/step]
7-982-001	OffsetValueForTorqCalculation	OPCTransferMotor	ENG*	[0.00 to 655.35 / 0.00 / 0.01-/step]
7-982-002	OffsetValueForTorqCalculation	BkDevMotor	ENG*	[0.00 to 655.35 / 0.00 / 0.01-/step]

3.SP Mode Tables

SP No.	Large Category	Small Category	ENG or CTL	[Min to Max/Init./Step]
7-982-003	OffsetValueForTorqCalculation	ColorOpcMotor	ENG*	[0.00 to 655.35 / 0.00 / 0.01-/step]
7-982-004	OffsetValueForTorqCalculation	ColorDevMotor	ENG*	[0.00 to 655.35 / 0.00 / 0.01-/step]
7-982-005	OffsetValueForTorqCalculation	FusingMotor	ENG*	[0.00 to 655.35 / 0.00 / 0.01-/step]
7-983-001	OutputLevel1CountNo.	OPCTransferMotor	ENG*	[0 to 65535 / 0 / 1Count/step]
7-983-002	OutputLevel1CountNo.	BkDevMotor	ENG*	[0 to 65535 / 0 / 1Count/step]
7-983-003	OutputLevel1CountNo.	ColorOpcMotor	ENG*	[0 to 65535 / 0 / 1Count/step]
7-983-004	OutputLevel1CountNo.	ColorDevMotor	ENG*	[0 to 65535 / 0 / 1Count/step]
7-983-005	OutputLevel1CountNo.	FusingMotor	ENG*	[0 to 65535 / 0 / 1Count/step]
7-984-001	OutputLevel2CountNo.	OPCTransferMotor	ENG*	[0 to 65535 / 0 / 1Count/step]
7-984-002	OutputLevel2CountNo.	BkDevMotor	ENG*	[0 to 65535 / 0 / 1Count/step]
7-984-003	OutputLevel2CountNo.	ColorOpcMotor	ENG*	[0 to 65535 / 0 / 1Count/step]
7-984-004	OutputLevel2CountNo.	ColorDevMotor	ENG*	[0 to 65535 / 0 / 1Count/step]

3.SP Mode Tables

SP No.	Large Category	Small Category	ENG or CTL	[Min to Max/Init./Step]
7-984-005	OutputLevel2CountNo.	FusingMotor	ENG*	[0 to 65535 / 0 / 1Count/step]
7-985-001	OutputLevel3CountNo.	OPCTransferMotor	ENG*	[0 to 65535 / 0 / 1Count/step]
7-985-002	OutputLevel3CountNo.	BkDevMotor	ENG*	[0 to 65535 / 0 / 1Count/step]
7-985-003	OutputLevel3CountNo.	ColorOpcMotor	ENG*	[0 to 65535 / 0 / 1Count/step]
7-985-004	OutputLevel3CountNo.	ColorDevMotor	ENG*	[0 to 65535 / 0 / 1Count/step]
7-985-005	OutputLevel3CountNo.	FusingMotor	ENG*	[0 to 65535 / 0 / 1Count/step]
7-986-001	VelocityErr.CountNo.	OPCTransferMotor	ENG*	[0 to 65535 / 0 / 1Count/step]
7-986-002	VelocityErr.CountNo.	BkDevMotor	ENG*	[0 to 65535 / 0 / 1Count/step]
7-986-003	VelocityErr.CountNo.	ColorOpcMotor	ENG*	[0 to 65535 / 0 / 1Count/step]
7-986-004	VelocityErr.CountNo.	ColorDevMotor	ENG*	[0 to 65535 / 0 / 1Count/step]
7-986-005	VelocityErr.CountNo.	FusingMotor	ENG*	[0 to 65535 / 0 / 1Count/step]

Engine SP Mode Tables for IM C6000 / C5500 / C4500

Engine SP Tables-1

SP1-XXX (Feed)

SP No.	Large Category	Small Category	ENG or CTL	[Min to Max/Init./Step]
1-001-001	Leading Edge Registration	Tray1: Thin	ENG*	[-9.0 to 9.0 / 0.0 / 0.1mm/step]
1-001-002	Leading Edge Registration	Tray1: Plain	ENG*	[-9.0 to 9.0 / 0.0 / 0.1mm/step]
1-001-003	Leading Edge Registration	Tray1: Mid-thick	ENG*	[-9.0 to 9.0 / 0.0 / 0.1mm/step]
1-001-004	Leading Edge Registration	Tray1: Thick 1	ENG*	[-9.0 to 9.0 / 0.0 / 0.1mm/step]
1-001-005	Leading Edge Registration	Tray1: Thick 2	ENG*	[-9.0 to 9.0 / 0.0 / 0.1mm/step]
1-001-006	Leading Edge Registration	Tray1: Thick 3	ENG*	[-9.0 to 9.0 / 0.0 / 0.1mm/step]
1-001-007	Leading Edge Registration	Tray1: Thick 4	ENG*	[-9.0 to 9.0 / 0.0 / 0.1mm/step]
1-001-008	Leading Edge Registration	Tray2/3/4/5/LCT: Thin	ENG*	[-9.0 to 9.0 / 0.0 / 0.1mm/step]
1-001-009	Leading Edge Registration	Tray2/3/4/5/LCT: Plain	ENG*	[-9.0 to 9.0 / 0.0 / 0.1mm/step]
1-001-010	Leading Edge Registration	Tray2/3/4/5/LCT: Mid-thick	ENG*	[-9.0 to 9.0 / 0.0 / 0.1mm/step]
1-001-	Leading Edge Registration	Tray2/3/4/5/LCT: Thick 1	ENG*	[-9.0 to 9.0 / 0.0 / 0.1mm/step]

3.SP Mode Tables

SP No.	Large Category	Small Category	ENG or CTL	[Min to Max/Init./Step]
011				
1-001-012	Leading Edge Registration	Tray2/3/4/5/LCT: Thick 2	ENG*	[-9.0 to 9.0 / 0.0 / 0.1mm/step]
1-001-013	Leading Edge Registration	Tray2/3/4/5/LCT: Thick 3	ENG*	[-9.0 to 9.0 / 0.0 / 0.1mm/step]
1-001-014	Leading Edge Registration	Tray2/3/4/5/LCT: Thick 4	ENG*	[-9.0 to 9.0 / 0.0 / 0.1mm/step]
1-001-015	Leading Edge Registration	By-pass: Thin	ENG*	[-9.0 to 9.0 / 0.0 / 0.1mm/step]
1-001-016	Leading Edge Registration	By-pass: Plain	ENG*	[-9.0 to 9.0 / 0.0 / 0.1mm/step]
1-001-017	Leading Edge Registration	By-pass: Mid-thick	ENG*	[-9.0 to 9.0 / 0.0 / 0.1mm/step]
1-001-018	Leading Edge Registration	By-pass: Thick 1	ENG*	[-9.0 to 9.0 / 0.0 / 0.1mm/step]
1-001-019	Leading Edge Registration	By-pass: Thick 2	ENG*	[-9.0 to 9.0 / 0.0 / 0.1mm/step]
1-001-020	Leading Edge Registration	By-pass: Thick 3	ENG*	[-9.0 to 9.0 / 0.0 / 0.1mm/step]
1-001-021	Leading Edge Registration	By-pass: Thick 4	ENG*	[-9.0 to 9.0 / 0.0 / 0.1mm/step]
1-001-022	Leading Edge Registration	Duplex: Thin	ENG*	[-9.0 to 9.0 / 0.0 / 0.1mm/step]
1-001-	Leading Edge Registration	Duplex: Plain	ENG*	[-9.0 to 9.0 / 0.0 / 0.1mm/step]

3.SP Mode Tables

SP No.	Large Category	Small Category	ENG or CTL	[Min to Max/Init./Step]
023				
1-001-024	Leading Edge Registration	Duplex: Mid-thick	ENG*	[-9.0 to 9.0 / 0.0 / 0.1mm/step]
1-001-025	Leading Edge Registration	Duplex: Thick 1	ENG*	[-9.0 to 9.0 / 0.0 / 0.1mm/step]
1-001-026	Leading Edge Registration	Duplex: Thick 2	ENG*	[-9.0 to 9.0 / 0.0 / 0.1mm/step]
1-001-027	Leading Edge Registration	Duplex: Thick 3	ENG*	[-9.0 to 9.0 / 0.0 / 0.1mm/step]
1-001-028	Leading Edge Registration	Tray1: Thin:1200	ENG*	[-9.0 to 9.0 / 0.0 / 0.1mm/step]
1-001-029	Leading Edge Registration	Tray1: Plain:1200	ENG*	[-9.0 to 9.0 / 0.0 / 0.1mm/step]
1-001-030	Leading Edge Registration	Tray1: Mid-thick:1200	ENG*	[-9.0 to 9.0 / 0.0 / 0.1mm/step]
1-001-031	Leading Edge Registration	Tray1: Thick 1:1200	ENG*	[-9.0 to 9.0 / 0.0 / 0.1mm/step]
1-001-032	Leading Edge Registration	Tray1: Thick 2:1200	ENG*	[-9.0 to 9.0 / 0.0 / 0.1mm/step]
1-001-033	Leading Edge Registration	Tray1: Thick 3:1200	ENG*	[-9.0 to 9.0 / 0.0 / 0.1mm/step]
1-001-034	Leading Edge Registration	Tray1: Thick 4:1200	ENG*	[-9.0 to 9.0 / 0.0 / 0.1mm/step]
1-001-	Leading Edge Registration	Tray2/3/4/5/LCT: Thin:1200	ENG*	[-9.0 to 9.0 / 0.0 / 0.1mm/step]

3.SP Mode Tables

SP No.	Large Category	Small Category	ENG or CTL	[Min to Max/Init./Step]
035				
1-001-036	Leading Edge Registration	Tray2/3/4/5/LCT: Plain:1200	ENG*	[-9.0 to 9.0 / 0.0 / 0.1mm/step]
1-001-037	Leading Edge Registration	Tray2/3/4/5/LCT: Mid-thick:1200	ENG*	[-9.0 to 9.0 / 0.0 / 0.1mm/step]
1-001-038	Leading Edge Registration	Tray2/3/4/5/LCT: Thick 1:1200	ENG*	[-9.0 to 9.0 / 0.0 / 0.1mm/step]
1-001-039	Leading Edge Registration	Tray2/3/4/5/LCT: Thick 2:1200	ENG*	[-9.0 to 9.0 / 0.0 / 0.1mm/step]
1-001-040	Leading Edge Registration	Tray2/3/4/5/LCT: Thick 3:1200	ENG*	[-9.0 to 9.0 / 0.0 / 0.1mm/step]
1-001-041	Leading Edge Registration	Tray2/3/4/5/LCT: Thick 4:1200	ENG*	[-9.0 to 9.0 / 0.0 / 0.1mm/step]
1-001-042	Leading Edge Registration	By-pass: Thin:1200	ENG*	[-9.0 to 9.0 / 0.0 / 0.1mm/step]
1-001-043	Leading Edge Registration	By-pass: Plain:1200	ENG*	[-9.0 to 9.0 / 0.0 / 0.1mm/step]
1-001-044	Leading Edge Registration	By-pass: Mid-thick:1200	ENG*	[-9.0 to 9.0 / 0.0 / 0.1mm/step]
1-001-045	Leading Edge Registration	By-pass: Thick 1:1200	ENG*	[-9.0 to 9.0 / 0.0 / 0.1mm/step]
1-001-046	Leading Edge Registration	By-pass: Thick 2:1200	ENG*	[-9.0 to 9.0 / 0.0 / 0.1mm/step]
1-001-	Leading Edge Registration	By-pass: Thick 3:1200	ENG*	[-9.0 to 9.0 / 0.0 / 0.1mm/step]

3.SP Mode Tables

SP No.	Large Category	Small Category	ENG or CTL	[Min to Max/Init./Step]
047				
1-001-048	Leading Edge Registration	By-pass: Thick 4:1200	ENG*	[-9.0 to 9.0 / 0.0 / 0.1mm/step]
1-001-049	Leading Edge Registration	Duplex: Thin:1200	ENG*	[-9.0 to 9.0 / 0.0 / 0.1mm/step]
1-001-050	Leading Edge Registration	Duplex: Plain:1200	ENG*	[-9.0 to 9.0 / 0.0 / 0.1mm/step]
1-001-051	Leading Edge Registration	Duplex: Mid-thick:1200	ENG*	[-9.0 to 9.0 / 0.0 / 0.1mm/step]
1-001-052	Leading Edge Registration	Duplex: Thick 1:1200	ENG*	[-9.0 to 9.0 / 0.0 / 0.1mm/step]
1-001-053	Leading Edge Registration	Duplex: Thick 2:1200	ENG*	[-9.0 to 9.0 / 0.0 / 0.1mm/step]
1-001-054	Leading Edge Registration	Duplex: Thick 3:1200	ENG*	[-9.0 to 9.0 / 0.0 / 0.1mm/step]
1-002-001	Side-to-Side Registration	By-pass Tray	ENG*	[-4.0 to 4.0 / 0.0 / 0.1mm/step]
1-002-002	Side-to-Side Registration	Paper Tray 1	ENG*	[-4.0 to 4.0 / 0.0 / 0.1mm/step]
1-002-003	Side-to-Side Registration	Paper Tray 2	ENG*	[-4.0 to 4.0 / 0.0 / 0.1mm/step]
1-002-004	Side-to-Side Registration	Paper Tray 3	ENG*	[-4.0 to 4.0 / 0.0 / 0.1mm/step]
1-002-	Side-to-Side Registration	Paper Tray 4	ENG*	[-4.0 to 4.0 / 0.0 / 0.1mm/step]

3.SP Mode Tables

SP No.	Large Category	Small Category	ENG or CTL	[Min to Max/Init./Step]
005				
1-002-006	Side-to-Side Registration	Duplex	ENG*	[-4.0 to 4.0 / 0.0 / 0.1mm/step]
1-002-007	Side-to-Side Registration	Large Capacity Tray	ENG*	[-4.0 to 4.0 / 0.0 / 0.1mm/step]
1-003-001	Paper Buckle	Paper Tray1: Thin	ENG*	[-4.0 to 5.0 / 0.0 / 0.1mm/step]
1-003-002	Paper Buckle	Paper Tray1: Plain	ENG*	[-4.0 to 5.0 / 0.0 / 0.1mm/step]
1-003-003	Paper Buckle	Paper Tray 1: Mid-thick	ENG*	[-4.0 to 5.0 / 0.0 / 0.1mm/step]
1-003-004	Paper Buckle	Paper Tray1: Thick1	ENG*	[-4.0 to 5.0 / -3.5 / 0.1mm/step]
1-003-005	Paper Buckle	Tray2/3/4/5/LCT: Thin	ENG*	[-4.0 to 5.0 / 0.0 / 0.1mm/step]
1-003-006	Paper Buckle	Tray2/3/4/5/LCT: Plain	ENG*	[-4.0 to 5.0 / 0.0 / 0.1mm/step]
1-003-007	Paper Buckle	Tray 2/3/4/5/LCT: Mid-thick	ENG*	[-4.0 to 5.0 / 0.0 / 0.1mm/step]
1-003-008	Paper Buckle	Tray2/3/4/5/LCT: Thick 1	ENG*	[-4.0 to 5.0 / -3.5 / 0.1mm/step]
1-003-009	Paper Buckle	By-pass: Thin	ENG*	[-4.0 to 5.0 / 0.0 / 0.1mm/step]
1-003-	Paper Buckle	By-pass: Plain	ENG*	[-4.0 to 5.0 / 0.0 / 0.1mm/step]

3.SP Mode Tables

SP No.	Large Category	Small Category	ENG or CTL	[Min to Max/Init./Step]
010				
1-003-011	Paper Buckle	By-pass: Mid-thick	ENG*	[-4.0 to 5.0 / 0.0 / 0.1mm/step]
1-003-012	Paper Buckle	By-pass:Thick1	ENG*	[-4.0 to 5.0 / -3.0 / 0.1mm/step]
1-003-013	Paper Buckle	Duplex:Thin	ENG*	[-4.0 to 5.0 / -1.5 / 0.1mm/step]
1-003-014	Paper Buckle	Duplex:Plain	ENG*	[-4.0 to 5.0 / -1.5 / 0.1mm/step]
1-003-015	Paper Buckle	Duplex: Mid-thick	ENG*	[-4.0 to 5.0 / -1.5 / 0.1mm/step]
1-003-016	Paper Buckle	Duplex:Thick1	ENG*	[-4.0 to 5.0 / -3.5 / 0.1mm/step]
1-003-017	Paper Buckle	Paper Tray1: Thin:1200	ENG*	[-4.0 to 5.0 / 0.0 / 0.1mm/step]
1-003-018	Paper Buckle	Paper Tray1: Plain:1200	ENG*	[-4.0 to 5.0 / 0.0 / 0.1mm/step]
1-003-019	Paper Buckle	Paper Tray 1: Mid-thick:1200	ENG*	[-4.0 to 5.0 / 0.0 / 0.1mm/step]
1-003-020	Paper Buckle	Paper Tray1: Thick1:1200	ENG*	[-4.0 to 5.0 / -3.5 / 0.1mm/step]
1-003-021	Paper Buckle	Tray2/3/4/5/LCT: Thin:1200	ENG*	[-4.0 to 5.0 / 0.0 / 0.1mm/step]
1-003-	Paper Buckle	Tray2/3/4/5/LCT: Plain:1200	ENG*	[-4.0 to 5.0 / 0.0 / 0.1mm/step]

3.SP Mode Tables

SP No.	Large Category	Small Category	ENG or CTL	[Min to Max/Init./Step]
022				
1-003-023	Paper Buckle	Tray2/3/4/5/LCT: Mid:1200	ENG*	[-4.0 to 5.0 / 0.0 / 0.1mm/step]
1-003-024	Paper Buckle	Tray2/3/4/5/LCT: Thick 1:1200	ENG*	[-4.0 to 5.0 / -3.5 / 0.1mm/step]
1-003-025	Paper Buckle	By-pass: Thin:1200	ENG*	[-4.0 to 5.0 / 0.0 / 0.1mm/step]
1-003-026	Paper Buckle	By-pass: Plain:1200	ENG*	[-4.0 to 5.0 / 0.0 / 0.1mm/step]
1-003-027	Paper Buckle	By-pass: Mid-thick:1200	ENG*	[-4.0 to 5.0 / 0.0 / 0.1mm/step]
1-003-028	Paper Buckle	By-pass:Thick1:1200	ENG*	[-4.0 to 5.0 / -3.0 / 0.1mm/step]
1-003-029	Paper Buckle	Duplex:Thin:1200	ENG*	[-4.0 to 5.0 / -1.5 / 0.1mm/step]
1-003-030	Paper Buckle	Duplex:Plain:1200	ENG*	[-4.0 to 5.0 / -1.5 / 0.1mm/step]
1-003-031	Paper Buckle	Duplex: Mid-thick:1200	ENG*	[-4.0 to 5.0 / -1.5 / 0.1mm/step]
1-003-032	Paper Buckle	Duplex:Thick1:1200	ENG*	[-4.0 to 5.0 / -3.5 / 0.1mm/step]
1-007-001	By-Pass Size Detection	Switch LT SEF/LG SEF	ENG*	[0 to 1 / 0 / 1/step]
1-007-	By-Pass Size Detection	By-Pass Jam Detection Set	ENG*	[0 to 2 / 2 / 1/step]

3.SP Mode Tables

SP No.	Large Category	Small Category	ENG or CTL	[Min to Max/Init./Step]
002				
1-008-005	By-Pass Size Detection Adj	Standby Fence Moved Detecting Threshold	ENG*	[1.0 to 40.0 / 10.0 / 0.5mm/step]
1-008-006	By-Pass Size Detection Adj	Printing Fence Moved Detecting Threshold	ENG	[1.0 to 40.0 / 20.0 / 0.5mm/step]
1-008-032	By-Pass Size Detection Adj	Main Scan Size Adj	ENG	[0 to 1 / 0 / 1/step]
1-008-033	By-Pass Size Detection Adj	Main Scan Size Adj Result (0:Fail 1:Succeed)	ENG	[0 to 1 / 0 / 1/step]
1-008-039	By-Pass Size Detection Adj	Length Conversion:Intercept	ENG*	[0.00 to 100.00 / 86.00 / 0.01/step]
1-009-001	Initial Operation Setting	Registration Gear Backlash Cut	ENG*	[0 to 1 / 0 / 1/step]
1-009-002	Operation Setting	Paper Exit Speed	ENG*	[0 to 1 / 1 / 1/step]
1-009-003	Pickup SOL Separate Setting	Paper Tray1: Thin	ENG*	[0 to 1 / 0 / 1/step]
1-009-004	Pickup SOL Separate Setting	Paper Tray1: Plain	ENG*	[0 to 1 / 0 / 1/step]
1-009-005	Pickup SOL Separate Setting	Paper Tray1: Thick	ENG*	[0 to 1 / 0 / 1/step]
1-009-006	Pickup SOL Separate Setting	Paper Tray2: Thin	ENG*	[0 to 1 / 0 / 1/step]
1-009-	Pickup SOL Separate Setting	Paper Tray2: Plain	ENG*	[0 to 1 / 0 / 1/step]

3.SP Mode Tables

SP No.	Large Category	Small Category	ENG or CTL	[Min to Max/Init./Step]
007				
1-009-008	Pickup SOL Separate Setting	Paper Tray2: Thick	ENG*	[0 to 1 / 0 / 1/step]
1-009-009	Pickup SOL Separate Setting	Paper Tray3: Thin	ENG*	[0 to 1 / 0 / 1/step]
1-009-010	Pickup SOL Separate Setting	Paper Tray3: Plain	ENG*	[0 to 1 / 0 / 1/step]
1-009-011	Pickup SOL Separate Setting	Paper Tray3: Thick	ENG*	[0 to 1 / 0 / 1/step]
1-009-012	Pickup SOL Separate Setting	Paper Tray4: Thin	ENG*	[0 to 1 / 0 / 1/step]
1-009-013	Pickup SOL Separate Setting	Paper Tray4: Plain	ENG*	[0 to 1 / 0 / 1/step]
1-009-014	Pickup SOL Separate Setting	Paper Tray4: Thick	ENG*	[0 to 1 / 0 / 1/step]
1-009-015	Pickup SOL Separate Setting	Paper LCT: Thin	ENG*	[0 to 1 / 0 / 1/step]
1-009-016	Pickup SOL Separate Setting	Paper LCT: Plain	ENG*	[0 to 1 / 0 / 1/step]
1-009-017	Pickup SOL Separate Setting	Paper LCT: Thick	ENG*	[0 to 1 / 0 / 1/step]
1-009-018	Operation Setting	ExitLineSpdSetting: AfterSpdDown	ENG*	[0 to 3 / 1 / 1/step]
1-010-	Size Set Miss Detection Mode	Paper Length Err Detection	ENG	[0 to 1 / 1 / 1/step]

3.SP Mode Tables

SP No.	Large Category	Small Category	ENG or CTL	[Min to Max/Init./Step]
001				
1-010-002	Size Set Miss Detection Mode	Small Size Miss Set Detection	ENG	[0 to 1 / 1 / 1/step]
1-011-001	Size Set Miss Detection Count	Paper Length Detection	ENG	[0 to 65535 / 0 / 1/step]
1-011-002	Size Set Miss Detection Count	Small Size Miss Set Detection	ENG	[0 to 65535 / 0 / 1/step]
1-012-001	Size Miss Paper Ejection Count	Ejection Count	ENG	[0 to 65535 / 0 / 1/step]
1-013-001	Tray Down Erro Flag	Tray1	ENG*	[0 to 1 / 0 / 1/step]
1-013-002	Tray Down Erro Flag	Tray2	ENG*	[0 to 1 / 0 / 1/step]
1-013-003	Tray Down Erro Flag	Tray3	ENG*	[0 to 1 / 0 / 1/step]
1-013-004	Tray Down Erro Flag	Tray4	ENG*	[0 to 1 / 0 / 1/step]
1-014-001	Job End By-Pass Pick Up SOL Op	SOL Operation ON-OFF Switch	ENG	[0 to 1 / 1 / 1/step]
1-102-001	Feed Permit Setting	Temp.:Lower Delta:Center	ENG*	IM C6000: [0 to 200 / 30 / 1deg/step] IM C5500: [0 to 200 / 30 / 1deg/step] IM C4500: [0 to 200 / 30 / 1deg/step]

3.SP Mode Tables

SP No.	Large Category	Small Category	ENG or CTL	[Min to Max/Init./Step]
1-102-002	Feed Permit Setting	Temp.:Lower Delta:End	ENG*	IM C6000: [0 to 200 / 30 / 1deg/step] IM C5500: [0 to 200 / 30 / 1deg/step] IM C4500: [0 to 200 / 30 / 1deg/step]
1-102-003	Feed Permit Setting	Temp.:Upper Delta:Center	ENG*	IM C6000: [0 to 200 / 30 / 1deg/step] IM C5500: [0 to 200 / 30 / 1deg/step] IM C4500: [0 to 200 / 30 / 1deg/step]
1-102-004	Feed Permit Setting	Temp.:Upper Delta:End	ENG*	IM C6000: [0 to 200 / 30 / 1deg/step] IM C5500: [0 to 200 / 30 / 1deg/step] IM C4500: [0 to 200 / 30 / 1deg/step]
1-102-005	Feed Permit Setting	Temp.:Lower Delta:Press	ENG*	IM C6000: TWN: [0 to 200 / 95 / 1deg/step] NA: [0 to 200 / 95 / 1deg/step] KOR: [0 to 200 / 100 / 1deg/step] EU: [0 to 200 / 100 / 1deg/step] CHN: [0 to 200 /

3.SP Mode Tables

SP No.	Large Category	Small Category	ENG or CTL	[Min to Max/Init./Step]
				100 / 1deg/step] AS: [0 to 200 / 100 / 1deg/step] IM C5500: TWN: [0 to 200 / 95 / 1deg/step] NA: [0 to 200 / 95 / 1deg/step] KOR: [0 to 200 / 100 / 1deg/step] EU: [0 to 200 / 100 / 1deg/step] CHN: [0 to 200 / 100 / 1deg/step] AS: [0 to 200 / 100 / 1deg/step] IM C4500: TWN: [0 to 200 / 80 / 1deg/step] NA: [0 to 200 / 80 / 1deg/step] KOR: [0 to 200 / 83 / 1deg/step] EU: [0 to 200 / 83 / 1deg/step] CHN: [0 to 200 / 83 / 1deg/step] AS: [0 to 200 / 83 / 1deg/step]
1-102-006	Feed Permit Setting	Rotation Time	ENG*	[0.00 to 100.00 / 0.00 / 0.01sec/step]
1-102-007	Feed Permit Setting	Temp.:Lower Delta:Center:Sp.1	ENG*	IM C6000: [0 to 200 / 5 / 1deg/step] IM C5500: [0 to 200 / 5 /

3.SP Mode Tables

SP No.	Large Category	Small Category	ENG or CTL	[Min to Max/Init./Step]
				1deg/step] IM C4500: [0 to 200 / 5 / 1deg/step]
1- 102- 008	Feed Permit Setting	Temp.:Lower Delta:End:Sp.1	ENG*	IM C6000: [0 to 200 / 5 / 1deg/step] IM C5500: [0 to 200 / 5 / 1deg/step] IM C4500: [0 to 200 / 5 / 1deg/step]
1- 102- 009	Feed Permit Setting	Temp.:Upper Delta:Center:Sp.1	ENG*	IM C6000: [0 to 200 / 30 / 1deg/step] IM C5500: [0 to 200 / 30 / 1deg/step] IM C4500: [0 to 200 / 30 / 1deg/step]
1- 102- 010	Feed Permit Setting	Temp.:Upper Delta:End:Sp.1	ENG*	IM C6000: [0 to 200 / 30 / 1deg/step] IM C5500: [0 to 200 / 30 / 1deg/step] IM C4500: [0 to 200 / 30 / 1deg/step]
1- 102- 011	Feed Permit Setting	Temp.:Lower Delta:Press:Sp.1	ENG*	IM C6000: [0 to 200 / 10 / 1deg/step] IM C5500: [0 to 200 / 10 / 1deg/step]

3.SP Mode Tables

SP No.	Large Category	Small Category	ENG or CTL	[Min to Max/Init./Step]
				IM C4500: [0 to 200 / 23 / 1deg/step]
1-102-012	Feed Permit Setting	Rotation Time:Sp.1	ENG*	IM C6000: [0.00 to 100.00 / 0.00 / 0.01sec/step] IM C5500: [0.00 to 100.00 / 0.00 / 0.01sec/step] IM C4500: [0.00 to 100.00 / 0.00 / 0.01sec/step]
1-102-013	Feed Permit Setting	Temp.:Lower Delta:Center:Sp.2	ENG*	[0 to 200 / 5 / 1deg/step]
1-102-014	Feed Permit Setting	Temp.:Lower Delta:End:Sp.2	ENG*	IM C6000: [0 to 200 / 5 / 1deg/step] IM C5500: [0 to 200 / 5 / 1deg/step] IM C4500: [0 to 200 / 5 / 1deg/step]
1-102-015	Feed Permit Setting	Temp.:Upper Delta:Center:Sp.2	ENG*	[0 to 200 / 15 / 1deg/step]
1-102-016	Feed Permit Setting	Temp.:Upper Delta:End:Sp.2	ENG*	IM C6000: [0 to 200 / 15 / 1deg/step] IM C5500: [0 to 200 / 15 / 1deg/step] IM C4500:

3.SP Mode Tables

SP No.	Large Category	Small Category	ENG or CTL	[Min to Max/Init./Step]
				[0 to 200 / 15 / 1deg/step]
1-102-017	Feed Permit Setting	Temp.:Lower Delta:Press:Sp.2	ENG*	[0 to 200 / 100 / 1deg/step]
1-102-018	Feed Permit Setting	Rotation Time:Sp2	ENG*	[0.00 to 100.00 / 0.00 / 0.01sec/step]
1-102-019	Feed Permit Setting	Feed Permit Time	ENG*	IM C6000: [0 to 200 / 60 / 1sec/step] IM C5500: [0 to 200 / 60 / 1sec/step] IM C4500: [0 to 200 / 60 / 1sec/step]
1-102-020	Feed Permit Setting	Temp.:Lower Delta:Center	ENG*	IM C6000: [0 to 200 / 40 / 1deg/step] IM C5500: [0 to 200 / 40 / 1deg/step] IM C4500: [0 to 200 / 52 / 1deg/step]
1-102-021	Feed Permit Setting	Temp.:Lower Delta:End	ENG*	IM C6000: [0 to 200 / 40 / 1deg/step] IM C5500: [0 to 200 / 40 / 1deg/step] IM C4500: [0 to 200 / 52 / 1deg/step]
1-102-	Feed Permit Setting	Temp.:Upper Delta:Center	ENG*	[0 to 200 / 30 / 1deg/step]

3.SP Mode Tables

SP No.	Large Category	Small Category	ENG or CTL	[Min to Max/Init./Step]
022				
1-102-023	Feed Permit Setting	Temp.:Upper Delta:End	ENG*	[0 to 200 / 30 / 1deg/step]
1-102-024	Feed Permit Setting	Temp.:Lower Delta:Press	ENG*	IM C6000: [0 to 200 / 28 / 1deg/step] IM C5500: [0 to 200 / 28 / 1deg/step] IM C4500: [0 to 200 / 16 / 1deg/step]
1-102-025	Feed Permit Setting	Temp.:Lower Delta:Press	ENG*	IM C6000: [0 to 200 / 48 / 1deg/step] IM C5500: [0 to 200 / 48 / 1deg/step] IM C4500: [0 to 200 / 34 / 1deg/step]
1-102-026	Feed Permit Setting	Rotation Time	ENG*	[0.00 to 100.00 / 0.00 / 0.01sec/step]
1-102-027	Feed Permit Setting	Temp.:Lower Delta:Center	ENG*	[0 to 200 / 5 / 1deg/step]
1-102-028	Feed Permit Setting	Temp.:Lower Delta:End	ENG*	[0 to 200 / 5 / 1deg/step]
1-102-029	Feed Permit Setting	Temp.:Upper Delta:Center	ENG*	[0 to 200 / 30 / 1deg/step]
1-102-030	Feed Permit Setting	Temp.:Upper Delta:End	ENG*	[0 to 200 / 30 / 1deg/step]

3.SP Mode Tables

SP No.	Large Category	Small Category	ENG or CTL	[Min to Max/Init./Step]
1-102-031	Feed Permit Setting	Temp.:Lower Delta:Press	ENG*	IM C6000: [0 to 200 / 23 / 1deg/step] IM C5500: [0 to 200 / 23 / 1deg/step] IM C4500: [0 to 200 / 16 / 1deg/step]
1-102-032	Feed Permit Setting	Temp.:Lower Delta:Press	ENG*	IM C6000: [0 to 200 / 43 / 1deg/step] IM C5500: [0 to 200 / 43 / 1deg/step] IM C4500: [0 to 200 / 34 / 1deg/step]
1-102-033	Feed Permit Setting	Rotation Time	ENG*	[0.00 to 100.00 / 0.00 / 0.01sec/step]
1-102-034	Feed Permit Setting	Temp.:Lower Delta:Center	ENG*	[0 to 200 / 5 / 1deg/step]
1-102-035	Feed Permit Setting	Temp.:Lower Delta:End	ENG*	[0 to 200 / 5 / 1deg/step]
1-102-036	Feed Permit Setting	Temp.:Upper Delta:Center	ENG*	[0 to 200 / 15 / 1deg/step]
1-102-037	Feed Permit Setting	Temp.:Upper Delta:End	ENG*	[0 to 200 / 15 / 1deg/step]
1-102-038	Feed Permit Setting	Temp.:Lower Delta:Press	ENG*	[0 to 200 / 100 / 1deg/step]
1-	Feed Permit Setting	Temp.:Lower Delta:Press	ENG*	[0 to 200 / 100 /

3.SP Mode Tables

SP No.	Large Category	Small Category	ENG or CTL	[Min to Max/Init./Step]
102-039				1deg/step]
1-102-040	Feed Permit Setting	Rotation Time	ENG*	[0.00 to 100.00 / 0.00 / 0.01sec/step]
1-102-041	Feed Permit Setting	Judgment Power A	ENG*	IM C6000: TWN: [0 to 2000 / 1289 / 1W/step] NA: [0 to 2000 / 1289 / 1W/step] KOR: [0 to 2000 / 1644 / 1W/step] EU: [0 to 2000 / 1644 / 1W/step] CHN: [0 to 2000 / 1644 / 1W/step] AS: [0 to 2000 / 1644 / 1W/step] IM C5500: TWN: [0 to 2000 / 1289 / 1W/step] NA: [0 to 2000 / 1289 / 1W/step] KOR: [0 to 2000 / 1644 / 1W/step] EU: [0 to 2000 / 1644 / 1W/step] CHN: [0 to 2000 / 1644 / 1W/step] AS: [0 to 2000 / 1644 / 1W/step] IM C4500: TWN: [0 to 2000 / 1394 / 1W/step] NA: [0 to 2000 / 1394 / 1W/step] KOR: [0 to 2000 /

3.SP Mode Tables

SP No.	Large Category	Small Category	ENG or CTL	[Min to Max/Init./Step]
				1649 / 1W/step] EU: [0 to 2000 / 1649 / 1W/step] CHN: [0 to 2000 / 1649 / 1W/step] AS: [0 to 2000 / 1649 / 1W/step]
1-102-042	Feed Permit Setting	Temp.:Lower Delta:Center:Power A	ENG*	IM C6000: [0 to 200 / 39 / 1deg/step] IM C5500: [0 to 200 / 39 / 1deg/step] IM C4500: [0 to 200 / 52 / 1deg/step]
1-102-043	Feed Permit Setting	Temp.:Lower Delta:::Power A	ENG*	IM C6000: [0 to 200 / 39 / 1deg/step] IM C5500: [0 to 200 / 39 / 1deg/step] IM C4500: [0 to 200 / 52 / 1deg/step]
1-102-044	Feed Permit Setting	Temp.:Upper Delta:Center:Power A	ENG*	IM C6000: [0 to 200 / 30 / 1deg/step] IM C5500: [0 to 200 / 30 / 1deg/step] IM C4500: [0 to 200 / 30 / 1deg/step]
1-102-045	Feed Permit Setting	Temp.:Upper Delta:End:Power A	ENG*	IM C6000: [0 to 200 / 30 / 1deg/step]

3.SP Mode Tables

SP No.	Large Category	Small Category	ENG or CTL	[Min to Max/Init./Step]
				IM C5500: [0 to 200 / 30 / 1deg/step] IM C4500: [0 to 200 / 30 / 1deg/step]
1-102-046	Feed Permit Setting	Temp.:Lower Delta:Press:Power A	ENG*	IM C6000: TWN: [0 to 200 / 25 / 1deg/step] NA: [0 to 200 / 25 / 1deg/step] KOR: [0 to 200 / 100 / 1deg/step] EU: [0 to 200 / 100 / 1deg/step] CHN: [0 to 200 / 100 / 1deg/step] AS: [0 to 200 / 100 / 1deg/step] IM C5500: TWN: [0 to 200 / 37 / 1deg/step] NA: [0 to 200 / 37 / 1deg/step] KOR: [0 to 200 / 100 / 1deg/step] EU: [0 to 200 / 100 / 1deg/step] CHN: [0 to 200 / 100 / 1deg/step] AS: [0 to 200 / 100 / 1deg/step] IM C4500: TWN: [0 to 200 / 80 / 1deg/step] NA: [0 to 200 / 80 / 1deg/step]

3.SP Mode Tables

SP No.	Large Category	Small Category	ENG or CTL	[Min to Max/Init./Step]
				KOR: [0 to 200 / 83 / 1deg/step] EU: [0 to 200 / 83 / 1deg/step] CHN: [0 to 200 / 83 / 1deg/step] AS: [0 to 200 / 83 / 1deg/step]
1-102-047	Feed Permit Setting	Rotation Time:Power A	ENG*	IM C6000: [0.00 to 100.00 / 0.00 / 0.01sec/step] IM C5500: [0.00 to 100.00 / 0.00 / 0.01sec/step] IM C4500: [0.00 to 100.00 / 0.00 / 0.01sec/step]
1-102-051	Feed Permit Setting	Judgment Power B	ENG*	IM C6000: TWN: [0 to 2000 / 1239 / 1W/step] NA: [0 to 2000 / 1239 / 1W/step] KOR: [0 to 2000 / 1559 / 1W/step] EU: [0 to 2000 / 1559 / 1W/step] CHN: [0 to 2000 / 1559 / 1W/step] AS: [0 to 2000 / 1559 / 1W/step] IM C5500: TWN: [0 to 2000 / 1239 / 1W/step] NA: [0 to 2000 /

3.SP Mode Tables

SP No.	Large Category	Small Category	ENG or CTL	[Min to Max/Init./Step]
				1239 / 1W/step] KOR: [0 to 2000 / 1559 / 1W/step] EU: [0 to 2000 / 1559 / 1W/step] CHN: [0 to 2000 / 1559 / 1W/step] AS: [0 to 2000 / 1559 / 1W/step] IM C4500: TWN: [0 to 2000 / 1329 / 1W/step] NA: [0 to 2000 / 1329 / 1W/step] KOR: [0 to 2000 / 1564 / 1W/step] EU: [0 to 2000 / 1564 / 1W/step] CHN: [0 to 2000 / 1564 / 1W/step] AS: [0 to 2000 / 1564 / 1W/step]
1-102-052	Feed Permit Setting	Temp.:Lower Delta:Center:Power B	ENG*	IM C6000: [0 to 200 / 39 / 1deg/step] IM C5500: [0 to 200 / 39 / 1deg/step] IM C4500: [0 to 200 / 52 / 1deg/step]
1-102-053	Feed Permit Setting	Temp.:Lower Delta:End:Power B	ENG*	IM C6000: [0 to 200 / 39 / 1deg/step] IM C5500: [0 to 200 / 39 / 1deg/step]

3.SP Mode Tables

SP No.	Large Category	Small Category	ENG or CTL	[Min to Max/Init./Step]
				IM C4500: [0 to 200 / 52 / 1deg/step]
1-102-054	Feed Permit Setting	Temp.:Upper Delta:Center:Power B	ENG*	IM C6000: [0 to 200 / 30 / 1deg/step] IM C5500: [0 to 200 / 30 / 1deg/step] IM C4500: [0 to 200 / 30 / 1deg/step]
1-102-055	Feed Permit Setting	Temp.:Upper Delta:End:Power B	ENG*	IM C6000: [0 to 200 / 30 / 1deg/step] IM C5500: [0 to 200 / 30 / 1deg/step] IM C4500: [0 to 200 / 30 / 1deg/step]
1-102-056	Feed Permit Setting	Temp.:Lower Delta:Press:Power B	ENG*	IM C6000: TWN: [0 to 200 / 25 / 1deg/step] NA: [0 to 200 / 25 / 1deg/step] KOR: [0 to 200 / 43 / 1deg/step] EU: [0 to 200 / 43 / 1deg/step] CHN: [0 to 200 / 43 / 1deg/step] AS: [0 to 200 / 43 / 1deg/step] IM C5500: TWN: [0 to 200 / 25 / 1deg/step]

3.SP Mode Tables

SP No.	Large Category	Small Category	ENG or CTL	[Min to Max/Init./Step]
				NA: [0 to 200 / 25 / 1deg/step] KOR: [0 to 200 / 63 / 1deg/step] EU: [0 to 200 / 63 / 1deg/step] CHN: [0 to 200 / 63 / 1deg/step] AS: [0 to 200 / 63 / 1deg/step] IM C4500: [0 to 200 / 71 / 1deg/step]
1-102-057	Feed Permit Setting	Rotation Time:Power B	ENG*	IM C6000: [0.00 to 100.00 / 0.00 / 0.01sec/step] IM C5500: [0.00 to 100.00 / 0.00 / 0.01sec/step] IM C4500: [0.00 to 100.00 / 0.00 / 0.01sec/step]
1-102-060	Feed Permit Setting	Waiting Time: Stabilize Temp.	ENG*	IM C6000: [0 to 10000 / 0 / 1msec/step] IM C5500: [0 to 10000 / 0 / 1msec/step] IM C4500: [0 to 10000 / 0 / 1msec/step]
1-102-061	Feed Permit Setting	Rotation Time:Temp:Low	ENG*	IM C6000: [0.00 to 100.00 / 0.00 /

3.SP Mode Tables

SP No.	Large Category	Small Category	ENG or CTL	[Min to Max/Init./Step]
				0.01sec/step] IM C5500: [0.00 to 100.00 / 0.00 / 0.01sec/step] IM C4500: [0.00 to 100.00 / 0.00 / 0.01sec/step]
1-102-062	Feed Permit Setting	Rotation Time:Voltage:Low	ENG*	IM C6000: [0.00 to 100.00 / 0.00 / 0.01sec/step] IM C5500: [0.00 to 100.00 / 0.00 / 0.01sec/step] IM C4500: [0.00 to 100.00 / 0.00 / 0.01sec/step]
1-102-070	Feed Permit Setting	Timeout: Cold: Normal	ENG*	IM C6000: TWN: [0 to 20000 / 2100 / 1msec/step] NA: [0 to 20000 / 2100 / 1msec/step] KOR: [0 to 20000 / 3500 / 1msec/step] EU: [0 to 20000 / 3500 / 1msec/step] CHN: [0 to 20000 / 3500 / 1msec/step]

3.SP Mode Tables

SP No.	Large Category	Small Category	ENG or CTL	[Min to Max/Init./Step]
				AS: [0 to 20000 / 3500 / 1msec/step] IM C5500: TWN: [0 to 20000 / 2100 / 1msec/step] NA: [0 to 20000 / 2100 / 1msec/step] KOR: [0 to 20000 / 3500 / 1msec/step] EU: [0 to 20000 / 3500 / 1msec/step] CHN: [0 to 20000 / 3500 / 1msec/step] AS: [0 to 20000 / 3500 / 1msec/step] IM C4500: [0 to 20000 / 4000 / 1msec/step]
1-102-071	Feed Permit Setting	Timeout: Hot: Normal	ENG*	IM C6000: TWN: [0 to 20000 / 2100 / 1msec/step] NA: [0 to 20000 / 2100 / 1msec/step] KOR: [0 to 20000 / 3500 / 1msec/step] EU: [0 to 20000 / 3500 / 1msec/step]

3.SP Mode Tables

SP No.	Large Category	Small Category	ENG or CTL	[Min to Max/Init./Step]
				1msec/step] CHN: [0 to 20000 / 3500 / 1msec/step] AS: [0 to 20000 / 3500 / 1msec/step] IM C5500: TWN: [0 to 20000 / 2100 / 1msec/step] NA: [0 to 20000 / 2100 / 1msec/step] KOR: [0 to 20000 / 3500 / 1msec/step] EU: [0 to 20000 / 3500 / 1msec/step] CHN: [0 to 20000 / 3500 / 1msec/step] AS: [0 to 20000 / 3500 / 1msec/step] IM C4500: [0 to 20000 / 4000 / 1msec/step]
1-102-072	Feed Permit Setting	Timeout: Cold: Power 1	ENG*	IM C6000: TWN: [0 to 20000 / 2100 / 1msec/step] NA: [0 to 20000 / 2100 / 1msec/step] KOR: [0 to 20000 /

3.SP Mode Tables

SP No.	Large Category	Small Category	ENG or CTL	[Min to Max/Init./Step]
				3500 / 1msec/step EU: [0 to 20000 / 3500 / 1msec/step CHN: [0 to 20000 / 3500 / 1msec/step AS: [0 to 20000 / 3500 / 1msec/step IM C5500: TWN: [0 to 20000 / 2100 / 1msec/step NA: [0 to 20000 / 2100 / 1msec/step KOR: [0 to 20000 / 3500 / 1msec/step EU: [0 to 20000 / 3500 / 1msec/step CHN: [0 to 20000 / 3500 / 1msec/step AS: [0 to 20000 / 3500 / 1msec/step IM C4500: [0 to 20000 / 4000 / 1msec/step]
1-102-073	Feed Permit Setting	Timeout: Hot: Power 1	ENG*	IM C6000: TWN: [0 to 20000 / 2100 / 1msec/step]

3.SP Mode Tables

SP No.	Large Category	Small Category	ENG or CTL	[Min to Max/Init./Step]
				NA: [0 to 20000 / 2100 / 1msec/step] KOR: [0 to 20000 / 3500 / 1msec/step] EU: [0 to 20000 / 3500 / 1msec/step] CHN: [0 to 20000 / 3500 / 1msec/step] AS: [0 to 20000 / 3500 / 1msec/step] IM C5500: TWN: [0 to 20000 / 2100 / 1msec/step] NA: [0 to 20000 / 2100 / 1msec/step] KOR: [0 to 20000 / 3500 / 1msec/step] EU: [0 to 20000 / 3500 / 1msec/step] CHN: [0 to 20000 / 3500 / 1msec/step] AS: [0 to 20000 / 3500 / 1msec/step] IM C4500: [0 to 20000 / 4000 / 1msec/step]

3.SP Mode Tables

SP No.	Large Category	Small Category	ENG or CTL	[Min to Max/Init./Step]
1-102-074	Feed Permit Setting	Timeout: Cold: Power 2	ENG*	IM C6000: TWN: [0 to 20000 / 2100 / 1msec/step] NA: [0 to 20000 / 2100 / 1msec/step] KOR: [0 to 20000 / 3500 / 1msec/step] EU: [0 to 20000 / 3500 / 1msec/step] CHN: [0 to 20000 / 3500 / 1msec/step] AS: [0 to 20000 / 3500 / 1msec/step] IM C5500: TWN: [0 to 20000 / 2100 / 1msec/step] NA: [0 to 20000 / 2100 / 1msec/step] KOR: [0 to 20000 / 3500 / 1msec/step] EU: [0 to 20000 / 3500 / 1msec/step] CHN: [0 to 20000 / 3500 / 1msec/step] AS: [0 to 20000 / 3500 / 1msec/step]

3.SP Mode Tables

SP No.	Large Category	Small Category	ENG or CTL	[Min to Max/Init./Step]
				1msec/step] IM C4500: [0 to 20000 / 4000 / 1msec/step]
1-102-075	Feed Permit Setting	Timeout: Hot: Power 2	ENG*	IM C6000: TWN: [0 to 20000 / 3600 / 1msec/step] NA: [0 to 20000 / 3600 / 1msec/step] KOR: [0 to 20000 / 3500 / 1msec/step] EU: [0 to 20000 / 3500 / 1msec/step] CHN: [0 to 20000 / 3500 / 1msec/step] AS: [0 to 20000 / 3500 / 1msec/step] IM C5500: TWN: [0 to 20000 / 3600 / 1msec/step] NA: [0 to 20000 / 3600 / 1msec/step] KOR: [0 to 20000 / 3500 / 1msec/step] EU: [0 to 20000 / 3500 / 1msec/step] CHN: [0 to 20000 /

3.SP Mode Tables

SP No.	Large Category	Small Category	ENG or CTL	[Min to Max/Init./Step]
				3500 / 1msec/step AS: [0 to 20000 / 3500 / 1msec/step IM C4500: [0 to 20000 / 4000 / 1msec/step]
1- 102- 076	Feed Permit Setting	Timeout: 10sec: 11	ENG*	IM C6000: TWN: [0 to 20000 / 2100 / 1msec/step] NA: [0 to 20000 / 2100 / 1msec/step] KOR: [0 to 20000 / 3500 / 1msec/step] EU: [0 to 20000 / 3500 / 1msec/step] CHN: [0 to 20000 / 3500 / 1msec/step] AS: [0 to 20000 / 3500 / 1msec/step] IM C5500: TWN: [0 to 20000 / 2100 / 1msec/step] NA: [0 to 20000 / 2100 / 1msec/step] KOR: [0 to 20000 / 3500 / 1msec/step]

3.SP Mode Tables

SP No.	Large Category	Small Category	ENG or CTL	[Min to Max/Init./Step]
				EU: [0 to 20000 / 3500 / 1msec/step] CHN: [0 to 20000 / 3500 / 1msec/step] AS: [0 to 20000 / 3500 / 1msec/step] IM C4500: [0 to 20000 / 4000 / 1msec/step]
1-102-077	Feed Permit Setting	Timeout: 10sec: 15	ENG*	IM C6000: TWN: [0 to 20000 / 2100 / 1msec/step] NA: [0 to 20000 / 2100 / 1msec/step] KOR: [0 to 20000 / 3500 / 1msec/step] EU: [0 to 20000 / 3500 / 1msec/step] CHN: [0 to 20000 / 3500 / 1msec/step] AS: [0 to 20000 / 3500 / 1msec/step] IM C5500: TWN: [0 to 20000 / 2100 / 1msec/step] NA: [0 to 20000 / 2100 / 1msec/step]

3.SP Mode Tables

SP No.	Large Category	Small Category	ENG or CTL	[Min to Max/Init./Step]
				1msec/step] KOR: [0 to 20000 / 3500 / 1msec/step] EU: [0 to 20000 / 3500 / 1msec/step] CHN: [0 to 20000 / 3500 / 1msec/step] AS: [0 to 20000 / 3500 / 1msec/step] IM C4500: [0 to 20000 / 4000 / 1msec/step]
1-102-078	Feed Permit Setting	Timeout: 10sec: 16	ENG*	IM C6000: TWN: [0 to 20000 / 3600 / 1msec/step] NA: [0 to 20000 / 3600 / 1msec/step] KOR: [0 to 20000 / 3500 / 1msec/step] EU: [0 to 20000 / 3500 / 1msec/step] CHN: [0 to 20000 / 3500 / 1msec/step] AS: [0 to 20000 / 3500 / 1msec/step] IM C5500: TWN: [0 to 20000

3.SP Mode Tables

SP No.	Large Category	Small Category	ENG or CTL	[Min to Max/Init./Step]
				/ 3600 / 1msec/step] NA: [0 to 20000 / 3600 / 1msec/step] KOR: [0 to 20000 / 3500 / 1msec/step] EU: [0 to 20000 / 3500 / 1msec/step] CHN: [0 to 20000 / 3500 / 1msec/step] AS: [0 to 20000 / 3500 / 1msec/step] IM C4500: [0 to 20000 / 4000 / 1msec/step]
1- 102- 101	Feed Permit Setting	Temp.:Lower Delta:Press0	ENG*	IM C6000: [0 to 200 / 31 / 1deg/step] IM C5500: [0 to 200 / 31 / 1deg/step] IM C4500: [0 to 200 / 31 / 1deg/step]
1- 102- 102	Feed Permit Setting	Temp.:Lower Delta:Press10	ENG*	IM C6000: [0 to 200 / 31 / 1deg/step] IM C5500: [0 to 200 / 31 / 1deg/step] IM C4500: [0 to 200 / 31 /

3.SP Mode Tables

SP No.	Large Category	Small Category	ENG or CTL	[Min to Max/Init./Step]
				1deg/step]
1- 102- 103	Feed Permit Setting	Temp.:Lower Delta:Press1	ENG*	IM C6000: [0 to 200 / 31 / 1deg/step] IM C5500: [0 to 200 / 31 / 1deg/step] IM C4500: [0 to 200 / 31 / 1deg/step]
1- 102- 104	Feed Permit Setting	Temp.:Lower Delta:Press2	ENG*	IM C6000: [0 to 200 / 31 / 1deg/step] IM C5500: [0 to 200 / 31 / 1deg/step] IM C4500: [0 to 200 / 31 / 1deg/step]
1- 102- 105	Feed Permit Setting	Temp.:Lower Delta:Press3	ENG*	IM C6000: TWN: [0 to 200 / 95 / 1deg/step] NA: [0 to 200 / 95 / 1deg/step] KOR: [0 to 200 / 31 / 1deg/step] EU: [0 to 200 / 31 / 1deg/step] CHN: [0 to 200 / 31 / 1deg/step] AS: [0 to 200 / 31 / 1deg/step] IM C5500: TWN: [0 to 200 / 95 / 1deg/step] NA: [0 to 200 / 95 / 1deg/step]

3.SP Mode Tables

SP No.	Large Category	Small Category	ENG or CTL	[Min to Max/Init./Step]
				KOR: [0 to 200 / 31 / 1deg/step] EU: [0 to 200 / 31 / 1deg/step] CHN: [0 to 200 / 31 / 1deg/step] AS: [0 to 200 / 31 / 1deg/step] IM C4500: [0 to 200 / 31 / 1deg/step]
1-102-106	Feed Permit Setting	Temp.:Lower Delta:Press13	ENG*	IM C6000: [0 to 200 / 31 / 1deg/step] IM C5500: [0 to 200 / 31 / 1deg/step] IM C4500: [0 to 200 / 31 / 1deg/step]
1-102-107	Feed Permit Setting	Temp.:Lower Delta:Press4	ENG*	IM C6000: [0 to 200 / 31 / 1deg/step] IM C5500: TWN: [0 to 200 / 37 / 1deg/step] NA: [0 to 200 / 37 / 1deg/step] KOR: [0 to 200 / 31 / 1deg/step] EU: [0 to 200 / 31 / 1deg/step] CHN: [0 to 200 / 31 / 1deg/step] AS: [0 to 200 / 31 / 1deg/step] IM C4500:

3.SP Mode Tables

SP No.	Large Category	Small Category	ENG or CTL	[Min to Max/Init./Step]
				[0 to 200 / 31 / 1deg/step]
1-102-108	Feed Permit Setting	Temp.:Lower Delta:Press14	ENG*	IM C6000: [0 to 200 / 31 / 1deg/step] IM C5500: [0 to 200 / 31 / 1deg/step] IM C4500: [0 to 200 / 31 / 1deg/step]
1-102-109	Feed Permit Setting	Temp.:Lower Delta:Press5	ENG*	IM C6000: [0 to 200 / 14 / 1deg/step] IM C5500: [0 to 200 / 14 / 1deg/step] IM C4500: [0 to 200 / 21 / 1deg/step]
1-102-110	Feed Permit Setting	Temp.:Lower Delta:Press6	ENG*	IM C6000: [0 to 200 / 19 / 1deg/step] IM C5500: [0 to 200 / 19 / 1deg/step] IM C4500: [0 to 200 / 22 / 1deg/step]
1-102-111	Feed Permit Setting	Temp.:Lower Delta:Press7	ENG*	IM C6000: [0 to 200 / 31 / 1deg/step] IM C5500: [0 to 200 / 31 / 1deg/step] IM C4500: [0 to 200 / 31 / 1deg/step]

3.SP Mode Tables

SP No.	Large Category	Small Category	ENG or CTL	[Min to Max/Init./Step]
				1deg/step]
1- 102- 112	Feed Permit Setting	Temp.:Lower Delta:Press11	ENG*	IM C6000: [0 to 200 / 31 / 1deg/step] IM C5500: [0 to 200 / 31 / 1deg/step] IM C4500: [0 to 200 / 31 / 1deg/step]
1- 102- 113	Feed Permit Setting	Temp.:Lower Delta:Press15	ENG*	IM C6000: [0 to 200 / 31 / 1deg/step] IM C5500: [0 to 200 / 31 / 1deg/step] IM C4500: [0 to 200 / 31 / 1deg/step]
1- 102- 114	Feed Permit Setting	Temp.:Lower Delta:Press16	ENG*	IM C6000: [0 to 200 / 31 / 1deg/step] IM C5500: [0 to 200 / 31 / 1deg/step] IM C4500: [0 to 200 / 31 / 1deg/step]
1- 102- 121	Feed Permit Setting	Timeout:Press0	ENG*	IM C6000: [0 to 60000 / 9000 / 1msec/step] IM C5500: [0 to 60000 / 9000 / 1msec/step] IM C4500: [0 to 60000 / 9000 / 1msec/step]

3.SP Mode Tables

SP No.	Large Category	Small Category	ENG or CTL	[Min to Max/Init./Step]
1-102-122	Feed Permit Setting	Timeout:Press10	ENG*	IM C6000: [0 to 60000 / 9000 / 1msec/step] IM C5500: [0 to 60000 / 9000 / 1msec/step] IM C4500: [0 to 60000 / 9000 / 1msec/step]
1-102-123	Feed Permit Setting	Timeout:Press1	ENG*	IM C6000: [0 to 60000 / 9000 / 1msec/step] IM C5500: [0 to 60000 / 9000 / 1msec/step] IM C4500: [0 to 60000 / 9000 / 1msec/step]
1-102-124	Feed Permit Setting	Timeout:Press2	ENG*	IM C6000: [0 to 60000 / 9000 / 1msec/step] IM C5500: [0 to 60000 / 9000 / 1msec/step] IM C4500: [0 to 60000 / 9000 / 1msec/step]
1-102-125	Feed Permit Setting	Timeout:Press3	ENG*	IM C6000: TWN: [0 to 60000 / 0 / 1msec/step] NA: [0 to 60000 / 0 / 1msec/step] KOR: [0 to 60000 / 9000 / 1msec/step] EU: [0 to 60000 / 9000 /

3.SP Mode Tables

SP No.	Large Category	Small Category	ENG or CTL	[Min to Max/Init./Step]
				1msec/step] CHN: [0 to 60000 / 9000 / 1msec/step] AS: [0 to 60000 / 9000 / 1msec/step] IM C5500: TWN: [0 to 60000 / 0 / 1msec/step] NA: [0 to 60000 / 0 / 1msec/step] KOR: [0 to 60000 / 9000 / 1msec/step] EU: [0 to 60000 / 9000 / 1msec/step] CHN: [0 to 60000 / 9000 / 1msec/step] AS: [0 to 60000 / 9000 / 1msec/step] IM C4500: [0 to 60000 / 9000 / 1msec/step]
1-102-126	Feed Permit Setting	Timeout:Press13	ENG*	IM C6000: [0 to 60000 / 9000 / 1msec/step] IM C5500: [0 to 60000 / 9000 / 1msec/step] IM C4500: [0 to 60000 / 9000 / 1msec/step]
1-	Feed Permit Setting	Timeout:Press4	ENG*	IM C6000:

3.SP Mode Tables

SP No.	Large Category	Small Category	ENG or CTL	[Min to Max/Init./Step]
102-127				[0 to 60000 / 9000 / 1msec/step] IM C5500: TWN: [0 to 60000 / 0 / 1msec/step] NA: [0 to 60000 / 0 / 1msec/step] KOR: [0 to 60000 / 9000 / 1msec/step] EU: [0 to 60000 / 9000 / 1msec/step] CHN: [0 to 60000 / 9000 / 1msec/step] AS: [0 to 60000 / 9000 / 1msec/step] IM C4500: [0 to 60000 / 9000 / 1msec/step]
1-102-128	Feed Permit Setting	Timeout:Press14	ENG*	IM C6000: [0 to 60000 / 9000 / 1msec/step] IM C5500: [0 to 60000 / 9000 / 1msec/step] IM C4500: [0 to 60000 / 9000 / 1msec/step]
1-102-129	Feed Permit Setting	Timeout:Press5	ENG*	IM C6000: [0 to 60000 / 5000 / 1msec/step] IM C5500: [0 to 60000 / 5000 / 1msec/step]

3.SP Mode Tables

SP No.	Large Category	Small Category	ENG or CTL	[Min to Max/Init./Step]
				IM C4500: [0 to 60000 / 5500 / 1msec/step]
1- 102- 130	Feed Permit Setting	Timeout:Press6	ENG*	IM C6000: [0 to 60000 / 6000 / 1msec/step] IM C5500: [0 to 60000 / 6000 / 1msec/step] IM C4500: [0 to 60000 / 5500 / 1msec/step]
1- 102- 131	Feed Permit Setting	Timeout:Press7	ENG*	IM C6000: [0 to 60000 / 12000 / 1msec/step] IM C5500: [0 to 60000 / 12000 / 1msec/step] IM C4500: [0 to 60000 / 12000 / 1msec/step]
1- 102- 132	Feed Permit Setting	Timeout: Press: 11	ENG*	IM C6000: [0 to 60000 / 9000 / 1msec/step] IM C5500: [0 to 60000 / 9000 / 1msec/step] IM C4500: [0 to 60000 / 9000 / 1msec/step]
1- 102- 133	Feed Permit Setting	Timeout: Press: 15	ENG*	IM C6000: [0 to 60000 / 9000 / 1msec/step] IM C5500:

3.SP Mode Tables

SP No.	Large Category	Small Category	ENG or CTL	[Min to Max/Init./Step]
				[0 to 60000 / 9000 / 1msec/step] IM C4500: [0 to 60000 / 9000 / 1msec/step]
1-102-134	Feed Permit Setting	Timeout: Press: 16	ENG*	IM C6000: [0 to 60000 / 9000 / 1msec/step] IM C5500: [0 to 60000 / 9000 / 1msec/step] IM C4500: [0 to 60000 / 9000 / 1msec/step]
1-102-151	Feed Permit Setting	Temp:Judge:Middle:High Power	ENG*	IM C6000: TWN: [0 to 200 / 61 / 1deg/step] NA: [0 to 200 / 61 / 1deg/step] KOR: [0 to 200 / 198 / 1deg/step] EU: [0 to 200 / 198 / 1deg/step] CHN: [0 to 200 / 198 / 1deg/step] AS: [0 to 200 / 198 / 1deg/step] IM C5500: TWN: [0 to 200 / 61 / 1deg/step] NA: [0 to 200 / 61 / 1deg/step] KOR: [0 to 200 / 198 / 1deg/step] EU: [0 to 200 / 198 / 1deg/step] CHN: [0 to 200 /

3.SP Mode Tables

SP No.	Large Category	Small Category	ENG or CTL	[Min to Max/Init./Step]
				198 / 1deg/step] AS: [0 to 200 / 198 / 1deg/step] IM C4500: [0 to 200 / 198 / 1deg/step]
1- 102- 152	Feed Permit Setting	Temp:Judge:low:Middle Power	ENG*	IM C6000: TWN: [0 to 200 / 64 / 1deg/step] NA: [0 to 200 / 64 / 1deg/step] KOR: [0 to 200 / 199 / 1deg/step] EU: [0 to 200 / 199 / 1deg/step] CHN: [0 to 200 / 199 / 1deg/step] AS: [0 to 200 / 199 / 1deg/step] IM C5500: TWN: [0 to 200 / 64 / 1deg/step] NA: [0 to 200 / 64 / 1deg/step] KOR: [0 to 200 / 199 / 1deg/step] EU: [0 to 200 / 199 / 1deg/step] CHN: [0 to 200 / 199 / 1deg/step] AS: [0 to 200 / 199 / 1deg/step] IM C4500: [0 to 200 / 199 / 1deg/step]
1- 102-	Feed Permit Setting	Temp:Judge:low:High Power	ENG*	IM C6000: TWN: [0 to 200 /

3.SP Mode Tables

SP No.	Large Category	Small Category	ENG or CTL	[Min to Max/Init./Step]
153				73 / 1deg/step] NA: [0 to 200 / 73 / 1deg/step] KOR: [0 to 200 / 200 / 1deg/step] EU: [0 to 200 / 200 / 1deg/step] CHN: [0 to 200 / 200 / 1deg/step] AS: [0 to 200 / 200 / 1deg/step] IM C5500: TWN: [0 to 200 / 73 / 1deg/step] NA: [0 to 200 / 73 / 1deg/step] KOR: [0 to 200 / 200 / 1deg/step] EU: [0 to 200 / 200 / 1deg/step] CHN: [0 to 200 / 200 / 1deg/step] AS: [0 to 200 / 200 / 1deg/step] IM C4500: [0 to 200 / 200 / 1deg/step]
1-105-001	Print Target Temp.	Plain1:FC:Center	ENG*	IM C6000: [100 to 180 / 149 / 1deg/step] IM C5500: [100 to 180 / 149 / 1deg/step] IM C4500: [100 to 180 / 133 / 1deg/step]
1-	Print Target Temp.	Plain1:FC:Press	ENG*	IM C6000:

3.SP Mode Tables

SP No.	Large Category	Small Category	ENG or CTL	[Min to Max/Init./Step]
105-002				[0 to 200 / 140 / 1deg/step] IM C5500: [0 to 200 / 140 / 1deg/step] IM C4500: [0 to 200 / 118 / 1deg/step]
1-105-003	Print Target Temp.	Plain1:BW:Center	ENG*	IM C6000: [100 to 180 / 144 / 1deg/step] IM C5500: [100 to 180 / 144 / 1deg/step] IM C4500: [100 to 180 / 128 / 1deg/step]
1-105-004	Print Target Temp.	Plain1:BW:Press	ENG*	IM C6000: [0 to 200 / 114 / 1deg/step] IM C5500: [0 to 200 / 114 / 1deg/step] IM C4500: [0 to 200 / 120 / 1deg/step]
1-105-005	Print Target Temp.	Plain2:FC:Center	ENG*	IM C6000: [100 to 180 / 159 / 1deg/step] IM C5500: [100 to 180 / 159 / 1deg/step] IM C4500: [100 to 180 / 141 / 1deg/step]
1-105-	Print Target Temp.	Plain2:FC:Press	ENG*	IM C6000: [0 to 200 / 145 /

3.SP Mode Tables

SP No.	Large Category	Small Category	ENG or CTL	[Min to Max/Init./Step]
006				1deg/step] IM C5500: [0 to 200 / 145 / 1deg/step] IM C4500: [0 to 200 / 118 / 1deg/step]
1-105-007	Print Target Temp.	Plain2:BW:Center	ENG*	IM C6000: [100 to 180 / 154 / 1deg/step] IM C5500: [100 to 180 / 154 / 1deg/step] IM C4500: [100 to 180 / 136 / 1deg/step]
1-105-008	Print Target Temp.	Plain2:BW:Press	ENG*	IM C6000: [0 to 200 / 122 / 1deg/step] IM C5500: [0 to 200 / 122 / 1deg/step] IM C4500: [0 to 200 / 118 / 1deg/step]
1-105-009	Print Target Temp.	Thin:FC:Center	ENG*	IM C6000: [100 to 180 / 144 / 1deg/step] IM C5500: [100 to 180 / 144 / 1deg/step] IM C4500: [100 to 180 / 128 / 1deg/step]
1-105-010	Print Target Temp.	Thin:FC:Press	ENG*	[0 to 200 / 121 / 1deg/step]

3.SP Mode Tables

SP No.	Large Category	Small Category	ENG or CTL	[Min to Max/Init./Step]
1-105-011	Print Target Temp.	Thin:BW:Center	ENG*	IM C6000: [100 to 180 / 144 / 1deg/step] IM C5500: [100 to 180 / 144 / 1deg/step] IM C4500: [100 to 180 / 128 / 1deg/step]
1-105-012	Print Target Temp.	Thin:BW:Press	ENG*	[0 to 200 / 121 / 1deg/step]
1-105-013	Print Target Temp.	M-thick:FC:Center	ENG*	IM C6000: [100 to 180 / 159 / 1deg/step] IM C5500: [100 to 180 / 159 / 1deg/step] IM C4500: [100 to 180 / 141 / 1deg/step]
1-105-014	Print Target Temp.	M-thick:FC:Press	ENG*	IM C6000: [0 to 200 / 142 / 1deg/step] IM C5500: [0 to 200 / 142 / 1deg/step] IM C4500: [0 to 200 / 118 / 1deg/step]
1-105-015	Print Target Temp.	M-thick:BW:Center	ENG*	IM C6000: [100 to 180 / 159 / 1deg/step] IM C5500: [100 to 180 / 159 / 1deg/step] IM C4500:

3.SP Mode Tables

SP No.	Large Category	Small Category	ENG or CTL	[Min to Max/Init./Step]
				[100 to 180 / 141 / 1deg/step]
1-105-016	Print Target Temp.	M-thick:BW:Press	ENG*	IM C6000: [0 to 200 / 142 / 1deg/step] IM C5500: [0 to 200 / 142 / 1deg/step] IM C4500: [0 to 200 / 118 / 1deg/step]
1-105-017	Print Target Temp.	Thick1:FC:Center	ENG*	IM C6000: [100 to 180 / 141 / 1deg/step] IM C5500: [100 to 180 / 141 / 1deg/step] IM C4500: [100 to 180 / 141 / 1deg/step]
1-105-018	Print Target Temp.	Thick1:FC:Press	ENG*	IM C6000: [0 to 200 / 101 / 1deg/step] IM C5500: [0 to 200 / 101 / 1deg/step] IM C4500: [0 to 200 / 119 / 1deg/step]
1-105-019	Print Target Temp.	Thick1:BW:Center	ENG*	IM C6000: [100 to 180 / 141 / 1deg/step] IM C5500: [100 to 180 / 141 / 1deg/step] IM C4500: [100 to 180 / 141 /

3.SP Mode Tables

SP No.	Large Category	Small Category	ENG or CTL	[Min to Max/Init./Step]
				1deg/step]
1-105-020	Print Target Temp.	Thick1:BW:Press	ENG*	IM C6000: TWN: [0 to 200 / 110 / 1deg/step] NA: [0 to 200 / 110 / 1deg/step] KOR: [0 to 200 / 101 / 1deg/step] EU: [0 to 200 / 101 / 1deg/step] CHN: [0 to 200 / 101 / 1deg/step] AS: [0 to 200 / 101 / 1deg/step] IM C5500: TWN: [0 to 200 / 110 / 1deg/step] NA: [0 to 200 / 110 / 1deg/step] KOR: [0 to 200 / 101 / 1deg/step] EU: [0 to 200 / 101 / 1deg/step] CHN: [0 to 200 / 101 / 1deg/step] AS: [0 to 200 / 101 / 1deg/step] IM C4500: [0 to 200 / 119 / 1deg/step]
1-105-021	Print Target Temp.	Thick2:FC:Center	ENG*	IM C6000: [100 to 180 / 132 / 1deg/step] IM C5500: [100 to 180 / 132 / 1deg/step] IM C4500:

3.SP Mode Tables

SP No.	Large Category	Small Category	ENG or CTL	[Min to Max/Init./Step]
				[100 to 180 / 132 / 1deg/step]
1-105-022	Print Target Temp.	Thick2:FC:Press	ENG*	IM C6000: [0 to 200 / 80 / 1deg/step] IM C5500: [0 to 200 / 80 / 1deg/step] IM C4500: [0 to 200 / 98 / 1deg/step]
1-105-023	Print Target Temp.	Thick2:BW:Center	ENG*	IM C6000: [100 to 180 / 132 / 1deg/step] IM C5500: [100 to 180 / 132 / 1deg/step] IM C4500: [100 to 180 / 132 / 1deg/step]
1-105-024	Print Target Temp.	Thick2:BW:Press	ENG*	IM C6000: [0 to 200 / 80 / 1deg/step] IM C5500: [0 to 200 / 80 / 1deg/step] IM C4500: [0 to 200 / 98 / 1deg/step]
1-105-025	Print Target Temp.	Thick3:FC:Center	ENG*	IM C6000: [100 to 180 / 137 / 1deg/step] IM C5500: [100 to 180 / 137 / 1deg/step] IM C4500: [100 to 180 / 137 /

3.SP Mode Tables

SP No.	Large Category	Small Category	ENG or CTL	[Min to Max/Init./Step]
				1deg/step]
1-105-026	Print Target Temp.	Thick3:FC:Press	ENG*	IM C6000: [0 to 200 / 80 / 1deg/step] IM C5500: [0 to 200 / 80 / 1deg/step] IM C4500: [0 to 200 / 98 / 1deg/step]
1-105-027	Print Target Temp.	Thick3:BW:Center	ENG*	IM C6000: [100 to 180 / 137 / 1deg/step] IM C5500: [100 to 180 / 137 / 1deg/step] IM C4500: [100 to 180 / 137 / 1deg/step]
1-105-028	Print Target Temp.	Thick3:BW:Press	ENG*	IM C6000: [0 to 200 / 80 / 1deg/step] IM C5500: [0 to 200 / 80 / 1deg/step] IM C4500: [0 to 200 / 98 / 1deg/step]
1-105-029	Print Target Temp.	Special1:FC:Center	ENG*	IM C6000: [100 to 180 / 149 / 1deg/step] IM C5500: [100 to 180 / 149 / 1deg/step] IM C4500: [100 to 180 / 133 / 1deg/step]

3.SP Mode Tables

SP No.	Large Category	Small Category	ENG or CTL	[Min to Max/Init./Step]
1-105-030	Print Target Temp.	Special1:FC:Press	ENG*	IM C6000: [0 to 200 / 135 / 1deg/step] IM C5500: [0 to 200 / 135 / 1deg/step] IM C4500: [0 to 200 / 110 / 1deg/step]
1-105-031	Print Target Temp.	Special1:BW:Center	ENG*	IM C6000: [100 to 180 / 144 / 1deg/step] IM C5500: [100 to 180 / 144 / 1deg/step] IM C4500: [100 to 180 / 128 / 1deg/step]
1-105-032	Print Target Temp.	Special1:BW:Press	ENG*	IM C6000: [0 to 200 / 112 / 1deg/step] IM C5500: [0 to 200 / 112 / 1deg/step] IM C4500: [0 to 200 / 110 / 1deg/step]
1-105-033	Print Target Temp.	Special2:FC:Center	ENG*	IM C6000: [100 to 180 / 159 / 1deg/step] IM C5500: [100 to 180 / 159 / 1deg/step] IM C4500: [100 to 180 / 141 / 1deg/step]
1-	Print Target Temp.	Special2:FC:Press	ENG*	IM C6000:

3.SP Mode Tables

SP No.	Large Category	Small Category	ENG or CTL	[Min to Max/Init./Step]
105-034				[0 to 200 / 145 / 1deg/step] IM C5500: [0 to 200 / 145 / 1deg/step] IM C4500: [0 to 200 / 118 / 1deg/step]
1-105-035	Print Target Temp.	Special2:BW:Center	ENG*	IM C6000: [100 to 180 / 154 / 1deg/step] IM C5500: [100 to 180 / 154 / 1deg/step] IM C4500: [100 to 180 / 136 / 1deg/step]
1-105-036	Print Target Temp.	Special2:BW:Press	ENG*	IM C6000: [0 to 200 / 122 / 1deg/step] IM C5500: [0 to 200 / 122 / 1deg/step] IM C4500: [0 to 200 / 118 / 1deg/step]
1-105-037	Print Target Temp.	Special3:FC:Center	ENG*	IM C6000: [100 to 180 / 159 / 1deg/step] IM C5500: [100 to 180 / 159 / 1deg/step] IM C4500: [100 to 180 / 141 / 1deg/step]
1-105-	Print Target Temp.	Special3:FC:Press	ENG*	IM C6000: [0 to 200 / 142 /

3.SP Mode Tables

SP No.	Large Category	Small Category	ENG or CTL	[Min to Max/Init./Step]
038				1deg/step] IM C5500: [0 to 200 / 142 / 1deg/step] IM C4500: [0 to 200 / 118 / 1deg/step]
1- 105- 039	Print Target Temp.	Special3:BW:Center	ENG*	IM C6000: [100 to 180 / 159 / 1deg/step] IM C5500: [100 to 180 / 159 / 1deg/step] IM C4500: [100 to 180 / 141 / 1deg/step]
1- 105- 040	Print Target Temp.	Special3:BW:Press	ENG*	IM C6000: [0 to 200 / 142 / 1deg/step] IM C5500: [0 to 200 / 142 / 1deg/step] IM C4500: [0 to 200 / 118 / 1deg/step]
1- 105- 041	Print Target Temp.	Envelop:Center	ENG*	[100 to 180 / 142 / 1deg/step]
1- 105- 042	Print Target Temp.	Envelop:Press	ENG*	[0 to 200 / 118 / 1deg/step]
1- 105- 051	Print Target Temp.	Special1:FC:Center:Middle Speed	ENG*	IM C6000: [100 to 180 / 136 / 1deg/step] IM C5500: [100 to 180 / 136 / 1deg/step]

3.SP Mode Tables

SP No.	Large Category	Small Category	ENG or CTL	[Min to Max/Init./Step]
				IM C4500: [100 to 180 / 136 / 1deg/step]
1-105-052	Print Target Temp.	Special1:FC:Press:Middle Speed	ENG*	IM C6000: [0 to 200 / 101 / 1deg/step] IM C5500: [0 to 200 / 101 / 1deg/step] IM C4500: [0 to 200 / 119 / 1deg/step]
1-105-053	Print Target Temp.	Special1:BW:Center:Middle Speed	ENG*	IM C6000: [100 to 180 / 136 / 1deg/step] IM C5500: [100 to 180 / 136 / 1deg/step] IM C4500: [100 to 180 / 136 / 1deg/step]
1-105-054	Print Target Temp.	Special1:BW:Press:Middle Speed	ENG*	IM C6000: [0 to 200 / 101 / 1deg/step] IM C5500: [0 to 200 / 101 / 1deg/step] IM C4500: [0 to 200 / 119 / 1deg/step]
1-105-055	Print Target Temp.	Special2:FC:Center:Middle Speed	ENG*	IM C6000: [100 to 180 / 141 / 1deg/step] IM C5500: [100 to 180 / 141 / 1deg/step] IM C4500:

3.SP Mode Tables

SP No.	Large Category	Small Category	ENG or CTL	[Min to Max/Init./Step]
				[100 to 180 / 141 / 1deg/step]
1-105-056	Print Target Temp.	Special2:FC:Press:Middle Speed	ENG*	IM C6000: [0 to 200 / 101 / 1deg/step] IM C5500: [0 to 200 / 101 / 1deg/step] IM C4500: [0 to 200 / 119 / 1deg/step]
1-105-057	Print Target Temp.	Special2:BW:Center:Middle Speed	ENG*	IM C6000: [100 to 180 / 141 / 1deg/step] IM C5500: [100 to 180 / 141 / 1deg/step] IM C4500: [100 to 180 / 141 / 1deg/step]
1-105-058	Print Target Temp.	Special2:BW:Press:Middle Speed	ENG*	IM C6000: [0 to 200 / 101 / 1deg/step] IM C5500: [0 to 200 / 101 / 1deg/step] IM C4500: [0 to 200 / 119 / 1deg/step]
1-105-059	Print Target Temp.	Special3:FC:Center:Middle Speed	ENG*	IM C6000: [100 to 180 / 146 / 1deg/step] IM C5500: [100 to 180 / 146 / 1deg/step] IM C4500: [100 to 180 / 146 /

3.SP Mode Tables

SP No.	Large Category	Small Category	ENG or CTL	[Min to Max/Init./Step]
				1deg/step]
1-105-060	Print Target Temp.	Special3:FC:Press:Middle Speed	ENG*	IM C6000: [0 to 200 / 101 / 1deg/step] IM C5500: [0 to 200 / 101 / 1deg/step] IM C4500: [0 to 200 / 119 / 1deg/step]
1-105-061	Print Target Temp.	Special3:BW:Center:Middle Speed	ENG*	IM C6000: [100 to 180 / 146 / 1deg/step] IM C5500: [100 to 180 / 146 / 1deg/step] IM C4500: [100 to 180 / 146 / 1deg/step]
1-105-062	Print Target Temp.	Special3:BW:Press:Middle Speed	ENG*	IM C6000: [0 to 200 / 101 / 1deg/step] IM C5500: [0 to 200 / 101 / 1deg/step] IM C4500: [0 to 200 / 119 / 1deg/step]
1-105-101	Print Target Temp.	Plain1:FC:Center:Low Speed	ENG*	IM C6000: [100 to 180 / 115 / 1deg/step] IM C5500: [100 to 180 / 115 / 1deg/step] IM C4500: [100 to 180 / 115 / 1deg/step]

3.SP Mode Tables

SP No.	Large Category	Small Category	ENG or CTL	[Min to Max/Init./Step]
1-105-102	Print Target Temp.	Plain1:FC:Press:Low Speed	ENG*	[0 to 200 / 118 / 1deg/step]
1-105-103	Print Target Temp.	Plain1:BW:Center:Low Speed	ENG*	IM C6000: [100 to 180 / 115 / 1deg/step] IM C5500: [100 to 180 / 115 / 1deg/step] IM C4500: [100 to 180 / 115 / 1deg/step]
1-105-104	Print Target Temp.	Plain1:BW:Press:Low Speed	ENG*	[0 to 200 / 118 / 1deg/step]
1-105-105	Print Target Temp.	Plain2:FC:Center:Low Speed	ENG*	IM C6000: [100 to 180 / 120 / 1deg/step] IM C5500: [100 to 180 / 120 / 1deg/step] IM C4500: [100 to 180 / 120 / 1deg/step]
1-105-106	Print Target Temp.	Plain2:FC:Press:Low Speed	ENG*	[0 to 200 / 118 / 1deg/step]
1-105-107	Print Target Temp.	Plain2:BW:Center:Low Speed	ENG*	IM C6000: [100 to 180 / 120 / 1deg/step] IM C5500: [100 to 180 / 120 / 1deg/step] IM C4500: [100 to 180 / 120 / 1deg/step]
1-	Print Target Temp.	Plain2:BW:Press:Low Speed	ENG*	[0 to 200 / 118 /

3.SP Mode Tables

SP No.	Large Category	Small Category	ENG or CTL	[Min to Max/Init./Step]
105-108				1deg/step]
1-105-109	Print Target Temp.	M-thick:FC:Center:Low Speed	ENG*	IM C6000: [100 to 180 / 122 / 1deg/step] IM C5500: [100 to 180 / 122 / 1deg/step] IM C4500: [100 to 180 / 122 / 1deg/step]
1-105-110	Print Target Temp.	M-thick:FC:Press:Low Speed	ENG*	[0 to 200 / 118 / 1deg/step]
1-105-111	Print Target Temp.	M-thick:BW:Center:Low Speed	ENG*	IM C6000: [100 to 180 / 122 / 1deg/step] IM C5500: [100 to 180 / 122 / 1deg/step] IM C4500: [100 to 180 / 122 / 1deg/step]
1-105-112	Print Target Temp.	M-thick:BW:Press:Low Speed	ENG*	[0 to 200 / 118 / 1deg/step]
1-105-113	Print Target Temp.	Thick1:FC:Center:Low Speed	ENG*	IM C6000: [100 to 180 / 127 / 1deg/step] IM C5500: [100 to 180 / 127 / 1deg/step] IM C4500: [100 to 180 / 127 / 1deg/step]
1-105-	Print Target Temp.	Thick1:FC:Press:Low Speed	ENG*	[0 to 200 / 118 / 1deg/step]

3.SP Mode Tables

SP No.	Large Category	Small Category	ENG or CTL	[Min to Max/Init./Step]
114				
1-105-115	Print Target Temp.	Thick1:BW:Center:Low Speed	ENG*	IM C6000: [100 to 180 / 127 / 1deg/step] IM C5500: [100 to 180 / 127 / 1deg/step] IM C4500: [100 to 180 / 127 / 1deg/step]
1-105-116	Print Target Temp.	Thick1:BW:Press:Low Speed	ENG*	[0 to 200 / 118 / 1deg/step]
1-105-117	Print Target Temp.	Special1:FC:Center:Low Speed	ENG*	IM C6000: [100 to 180 / 122 / 1deg/step] IM C5500: [100 to 180 / 122 / 1deg/step] IM C4500: [100 to 180 / 122 / 1deg/step]
1-105-118	Print Target Temp.	Special1:FC:Press:Low Speed	ENG*	[0 to 200 / 118 / 1deg/step]
1-105-119	Print Target Temp.	Special1:BW:Center:Low Speed	ENG*	IM C6000: [100 to 180 / 122 / 1deg/step] IM C5500: [100 to 180 / 122 / 1deg/step] IM C4500: [100 to 180 / 122 / 1deg/step]
1-105-120	Print Target Temp.	Special1:BW:Press:Low Speed	ENG*	[0 to 200 / 118 / 1deg/step]

3.SP Mode Tables

SP No.	Large Category	Small Category	ENG or CTL	[Min to Max/Init./Step]
1-105-121	Print Target Temp.	Special2:FC:Center:Low Speed	ENG*	IM C6000: [100 to 180 / 132 / 1deg/step] IM C5500: [100 to 180 / 132 / 1deg/step] IM C4500: [100 to 180 / 132 / 1deg/step]
1-105-122	Print Target Temp.	Special2:FC:Press:Low Speed	ENG*	IM C6000: [0 to 200 / 80 / 1deg/step] IM C5500: [0 to 200 / 80 / 1deg/step] IM C4500: [0 to 200 / 98 / 1deg/step]
1-105-123	Print Target Temp.	Special2:BW:Center:Low Speed	ENG*	IM C6000: [100 to 180 / 132 / 1deg/step] IM C5500: [100 to 180 / 132 / 1deg/step] IM C4500: [100 to 180 / 132 / 1deg/step]
1-105-124	Print Target Temp.	Special2:BW:Press:Low Speed	ENG*	IM C6000: [0 to 200 / 80 / 1deg/step] IM C5500: [0 to 200 / 80 / 1deg/step] IM C4500: [0 to 200 / 98 / 1deg/step]
1-	Print Target Temp.	Plain1:Glossy:Center	ENG*	[100 to 180 / 132 /

3.SP Mode Tables

SP No.	Large Category	Small Category	ENG or CTL	[Min to Max/Init./Step]
105-125				1deg/step]
1-105-126	Print Target Temp.	Plain1:Glossy:Press	ENG*	[0 to 200 / 118 / 1deg/step]
1-105-127	Print Target Temp.	Plain2:Glossy:Center	ENG*	[100 to 180 / 137 / 1deg/step]
1-105-128	Print Target Temp.	Plain2:Glossy:Press	ENG*	[0 to 200 / 118 / 1deg/step]
1-105-129	Print Target Temp.	M-thick:Glossy:Center	ENG*	[100 to 180 / 142 / 1deg/step]
1-105-130	Print Target Temp.	M-thick:Glossy:Press	ENG*	[0 to 200 / 118 / 1deg/step]
1-105-131	Print Target Temp.	OHP:Center	ENG*	IM C6000: [100 to 180 / 160 / 1deg/step] IM C5500: [100 to 180 / 160 / 1deg/step] IM C4500: [100 to 180 / 160 / 1deg/step]
1-105-132	Print Target Temp.	OHP:Press	ENG*	IM C6000: [0 to 200 / 78 / 1deg/step] IM C5500: [0 to 200 / 78 / 1deg/step] IM C4500: [0 to 200 / 96 / 1deg/step]
1-105-	Print Target Temp.	Envelop:Center:Low Speed	ENG*	[100 to 180 / 135 / 1deg/step]

3.SP Mode Tables

SP No.	Large Category	Small Category	ENG or CTL	[Min to Max/Init./Step]
133				
1- 105- 134	Print Target Temp.	Envelop:Press:Low Speed	ENG*	IM C6000: [0 to 200 / 78 / 1deg/step] IM C5500: [0 to 200 / 78 / 1deg/step] IM C4500: [0 to 200 / 96 / 1deg/step]
1- 105- 135	Print Target Temp.	Thin:FC:Center:Low Speed	ENG*	[100 to 180 / 110 / 1deg/step]
1- 105- 136	Print Target Temp.	Thin:FC:Press:Low Speed	ENG*	[0 to 200 / 118 / 1deg/step]
1- 105- 137	Print Target Temp.	Thin:BW:Center:Low Speed	ENG*	[100 to 180 / 110 / 1deg/step]
1- 105- 138	Print Target Temp.	Thin:BW:Press:Low Speed	ENG*	[0 to 200 / 118 / 1deg/step]
1- 105- 139	Print Target Temp.	Thick4:FC:Center	ENG*	[100 to 180 / 142 / 1deg/step]
1- 105- 140	Print Target Temp.	Thick4:FC:Press	ENG*	IM C6000: [0 to 200 / 78 / 1deg/step] IM C5500: [0 to 200 / 78 / 1deg/step] IM C4500: [0 to 200 / 96 / 1deg/step]
1- 105- 141	Print Target Temp.	Thick4:BW:Center	ENG*	[100 to 180 / 142 / 1deg/step]

3.SP Mode Tables

SP No.	Large Category	Small Category	ENG or CTL	[Min to Max/Init./Step]
1-105-142	Print Target Temp.	Thick4:BW:Press	ENG*	IM C6000: [0 to 200 / 78 / 1deg/step] IM C5500: [0 to 200 / 78 / 1deg/step] IM C4500: [0 to 200 / 96 / 1deg/step]
1-105-143	Print Target Temp.	Postcard:Center	ENG*	[100 to 180 / 124 / 1deg/step]
1-105-144	Print Target Temp.	Postcard:Press	ENG*	IM C6000: [0 to 200 / 78 / 1deg/step] IM C5500: [0 to 200 / 78 / 1deg/step] IM C4500: [0 to 200 / 96 / 1deg/step]
1-105-145	Print Target Temp.	Special3:FC:Center:Middle Speed	ENG*	IM C6000: [100 to 180 / 142 / 1deg/step] IM C5500: [100 to 180 / 142 / 1deg/step] IM C4500: [100 to 180 / 142 / 1deg/step]
1-105-146	Print Target Temp.	Special3:FC:Press:Middle Speed	ENG*	IM C6000: [0 to 200 / 78 / 1deg/step] IM C5500: [0 to 200 / 78 / 1deg/step] IM C4500:

3.SP Mode Tables

SP No.	Large Category	Small Category	ENG or CTL	[Min to Max/Init./Step]
				[0 to 200 / 96 / 1deg/step]
1-105-147	Print Target Temp.	Special3:BW:Center:Middle Speed	ENG*	IM C6000: [100 to 180 / 142 / 1deg/step] IM C5500: [100 to 180 / 142 / 1deg/step] IM C4500: [100 to 180 / 142 / 1deg/step]
1-105-148	Print Target Temp.	Special3:BW:Press:Middle Speed	ENG*	IM C6000: [0 to 200 / 78 / 1deg/step] IM C5500: [0 to 200 / 78 / 1deg/step] IM C4500: [0 to 200 / 96 / 1deg/step]
1-105-149	Print Target Temp.	Mid Thick:Matte:Center	ENG*	IM C6000: [100 to 180 / 159 / 1deg/step] IM C5500: [100 to 180 / 159 / 1deg/step] IM C4500: [100 to 180 / 141 / 1deg/step]
1-105-150	Print Target Temp.	Mid Thick:Matte:Press	ENG*	IM C6000: [0 to 200 / 142 / 1deg/step] IM C5500: [0 to 200 / 142 / 1deg/step] IM C4500: [0 to 200 / 118 /

3.SP Mode Tables

SP No.	Large Category	Small Category	ENG or CTL	[Min to Max/Init./Step]
				1deg/step]
1-105-151	Print Target Temp.	Thick1:Matte:Center	ENG*	IM C6000: [100 to 180 / 141 / 1deg/step] IM C5500: [100 to 180 / 141 / 1deg/step] IM C4500: [100 to 180 / 141 / 1deg/step]
1-105-152	Print Target Temp.	Thick1:Matte:Press	ENG*	IM C6000: [0 to 200 / 101 / 1deg/step] IM C5500: [0 to 200 / 101 / 1deg/step] IM C4500: [0 to 200 / 119 / 1deg/step]
1-105-153	Print Target Temp.	Thick2:Matte:Center	ENG*	IM C6000: [100 to 180 / 132 / 1deg/step] IM C5500: [100 to 180 / 132 / 1deg/step] IM C4500: [100 to 180 / 132 / 1deg/step]
1-105-154	Print Target Temp.	Thick2:Matte:Press	ENG*	IM C6000: [0 to 200 / 80 / 1deg/step] IM C5500: [0 to 200 / 80 / 1deg/step] IM C4500: [0 to 200 / 98 / 1deg/step]

3.SP Mode Tables

SP No.	Large Category	Small Category	ENG or CTL	[Min to Max/Init./Step]
1-105-155	Print Target Temp.	Thick3:Matte:Center	ENG*	IM C6000: [100 to 180 / 137 / 1deg/step] IM C5500: [100 to 180 / 137 / 1deg/step] IM C4500: [100 to 180 / 137 / 1deg/step]
1-105-156	Print Target Temp.	Thick3:Matte:Press	ENG*	IM C6000: [0 to 200 / 80 / 1deg/step] IM C5500: [0 to 200 / 80 / 1deg/step] IM C4500: [0 to 200 / 98 / 1deg/step]
1-105-157	Print Target Temp.	Thick4:Matte:Center	ENG*	[100 to 180 / 142 / 1deg/step]
1-105-158	Print Target Temp.	Thick4:Matte:Press	ENG*	IM C6000: [0 to 200 / 78 / 1deg/step] IM C5500: [0 to 200 / 78 / 1deg/step] IM C4500: [0 to 200 / 96 / 1deg/step]
1-105-159	Print Target Temp.	Mid Thick:Matte:Center:Low Speed	ENG*	IM C6000: [100 to 180 / 122 / 1deg/step] IM C5500: [100 to 180 / 122 / 1deg/step] IM C4500:

3.SP Mode Tables

SP No.	Large Category	Small Category	ENG or CTL	[Min to Max/Init./Step]
				[100 to 180 / 122 / 1deg/step]
1-105-160	Print Target Temp.	Mid Thick:Matte:Press:Low Speed	ENG*	[0 to 200 / 118 / 1deg/step]
1-105-161	Print Target Temp.	Thick1:Matte:Center:Low Speed	ENG*	IM C6000: [100 to 180 / 127 / 1deg/step] IM C5500: [100 to 180 / 127 / 1deg/step] IM C4500: [100 to 180 / 127 / 1deg/step]
1-105-162	Print Target Temp.	Thick1:Matte:Press:Low Speed	ENG*	[0 to 200 / 118 / 1deg/step]
1-105-163	Print Target Temp.	Mid Thick:Glossy:Center	ENG*	IM C6000: [100 to 180 / 159 / 1deg/step] IM C5500: [100 to 180 / 159 / 1deg/step] IM C4500: [100 to 180 / 141 / 1deg/step]
1-105-164	Print Target Temp.	Mid Thick:Glossy:Press	ENG*	IM C6000: [0 to 200 / 142 / 1deg/step] IM C5500: [0 to 200 / 142 / 1deg/step] IM C4500: [0 to 200 / 118 / 1deg/step]
1-105-	Print Target Temp.	Thick1:Glossy:Center	ENG*	IM C6000: [100 to 180 / 141 /

3.SP Mode Tables

SP No.	Large Category	Small Category	ENG or CTL	[Min to Max/Init./Step]
165				1deg/step] IM C5500: [100 to 180 / 141 / 1deg/step] IM C4500: [100 to 180 / 141 / 1deg/step]
1- 105- 166	Print Target Temp.	Thick1:Glossy:Press	ENG*	IM C6000: [0 to 200 / 101 / 1deg/step] IM C5500: [0 to 200 / 101 / 1deg/step] IM C4500: [0 to 200 / 119 / 1deg/step]
1- 105- 167	Print Target Temp.	Thick2:Glossy:Center	ENG*	IM C6000: [100 to 180 / 132 / 1deg/step] IM C5500: [100 to 180 / 132 / 1deg/step] IM C4500: [100 to 180 / 132 / 1deg/step]
1- 105- 168	Print Target Temp.	Thick2:Glossy:Press	ENG*	IM C6000: [0 to 200 / 80 / 1deg/step] IM C5500: [0 to 200 / 80 / 1deg/step] IM C4500: [0 to 200 / 98 / 1deg/step]
1- 105- 169	Print Target Temp.	Thick3:Glossy:Center	ENG*	IM C6000: [100 to 180 / 137 / 1deg/step]

3.SP Mode Tables

SP No.	Large Category	Small Category	ENG or CTL	[Min to Max/Init./Step]
				IM C5500: [100 to 180 / 137 / 1deg/step] IM C4500: [100 to 180 / 137 / 1deg/step]
1-105-170	Print Target Temp.	Thick3:Glossy:Press	ENG*	IM C6000: [0 to 200 / 80 / 1deg/step] IM C5500: [0 to 200 / 80 / 1deg/step] IM C4500: [0 to 200 / 98 / 1deg/step]
1-105-171	Print Target Temp.	Thick4:Glossy:Center	ENG*	[100 to 180 / 142 / 1deg/step]
1-105-172	Print Target Temp.	Thick4:Glossy:Press	ENG*	IM C6000: [0 to 200 / 78 / 1deg/step] IM C5500: [0 to 200 / 78 / 1deg/step] IM C4500: [0 to 200 / 96 / 1deg/step]
1-105-173	Print Target Temp.	Mid Thick:Glossy:Center:Low Speed	ENG*	IM C6000: [100 to 180 / 122 / 1deg/step] IM C5500: [100 to 180 / 122 / 1deg/step] IM C4500: [100 to 180 / 122 / 1deg/step]
1-	Print Target Temp.	Mid Thick:Glossy:Press:Low Speed	ENG*	[0 to 200 / 118 /

3.SP Mode Tables

SP No.	Large Category	Small Category	ENG or CTL	[Min to Max/Init./Step]
105-174				1deg/step]
1-105-175	Print Target Temp.	Thick1:Glossy:Center:Low Speed	ENG*	IM C6000: [100 to 180 / 127 / 1deg/step] IM C5500: [100 to 180 / 127 / 1deg/step] IM C4500: [100 to 180 / 127 / 1deg/step]
1-105-176	Print Target Temp.	Thick1:Glossy:Press:Low Speed	ENG*	[0 to 200 / 118 / 1deg/step]
1-106-001	Fusing Temp. Display	Heat Center	ENG	[-10 to 250 / 0 / 1deg/step]
1-106-002	Fusing Temp. Display	Heat End	ENG	[-10 to 250 / 0 / 1deg/step]
1-106-003	Fusing Temp. Display	Press Center	ENG	[-10 to 250 / 0 / 1deg/step]
1-106-004	Fusing Temp. Display	Press End	ENG	[-10 to 250 / 0 / 1deg/step]
1-106-005	Fusing Temp. Display	Press End	ENG	[-10 to 250 / 0 / 1deg/step]
1-107-001	Standby Target Temp. Setting	Stanby/Preheat1:Center	ENG*	[0 to 125 / 90 / 1deg/step]
1-107-003	Standby Target Temp. Setting	Preheat2:Center	ENG*	[0 to 200 / 90 / 1deg/step]
1-107-	Standby Target Temp. Setting	Low Power:Center	ENG*	[0 to 125 / 60 / 1deg/step]

3.SP Mode Tables

SP No.	Large Category	Small Category	ENG or CTL	[Min to Max/Init./Step]
005				
1-107-007	Standby Target Temp. Setting	Print Ready:Center	ENG*	IM C6000: [85 to 180 / 159 / 1deg/step] IM C5500: [85 to 180 / 159 / 1deg/step] IM C4500: [85 to 180 / 141 / 1deg/step]
1-107-008	Standby Target Temp. Setting	Print Ready:Press	ENG*	[0 to 200 / 120 / 1deg/step]
1-107-011	Standby Target Temp. Setting	Standby Heater Off Time	ENG*	[0 to 100 / 0 / 1sec/step]
1-108-001	After Reload/Job Target Temp.	Center	ENG*	IM C6000: [85 to 200 / 159 / 1deg/step] IM C5500: [85 to 200 / 159 / 1deg/step] IM C4500: [85 to 200 / 141 / 1deg/step]
1-108-002	After Reload/Job Target Temp.	Press	ENG*	[0 to 200 / 120 / 1deg/step]
1-108-011	After Reload/Job Target Temp.	Center:Energy Saving	ENG*	IM C6000: TWN: [85 to 200 / 140 / 1deg/step] NA: [85 to 200 / 140 / 1deg/step] KOR: [85 to 200 / 138 / 1deg/step] EU: [85 to 200 / 138 / 1deg/step]

3.SP Mode Tables

SP No.	Large Category	Small Category	ENG or CTL	[Min to Max/Init./Step]
				CHN: [85 to 200 / 138 / 1deg/step] AS: [85 to 200 / 138 / 1deg/step] IM C5500: TWN: [85 to 200 / 140 / 1deg/step] NA: [85 to 200 / 140 / 1deg/step] KOR: [85 to 200 / 138 / 1deg/step] EU: [85 to 200 / 138 / 1deg/step] CHN: [85 to 200 / 138 / 1deg/step] AS: [85 to 200 / 138 / 1deg/step] IM C4500: TWN: [85 to 200 / 124 / 1deg/step] NA: [85 to 200 / 124 / 1deg/step] KOR: [85 to 200 / 125 / 1deg/step] EU: [85 to 200 / 125 / 1deg/step] CHN: [85 to 200 / 125 / 1deg/step] AS: [85 to 200 / 125 / 1deg/step]
1-108-012	After Reload/Job Target Temp.	Press:Energy Saving	ENG*	[0 to 200 / 120 / 1deg/step]
1-111-001	Environment Correction:Fusing	Temp.: Threshold: Low	ENG*	[0 to 100 / 15 / 1deg/step]
1-	Environment	Temp.: Threshold: High	ENG*	[0 to 100 / 30 /

3.SP Mode Tables

SP No.	Large Category	Small Category	ENG or CTL	[Min to Max/Init./Step]
111-002	Correction:Fusing			1deg/step]
1-111-003	Environment Correction:Fusing	Low Temp. Correction	ENG*	IM C6000: [0 to 15 / 15 / 1deg/step] IM C5500: [0 to 15 / 15 / 1deg/step] IM C4500: [0 to 15 / 15 / 1deg/step]
1-111-004	Environment Correction:Fusing	High Temp. Correction	ENG*	[0 to 15 / 0 / 1deg/step]
1-111-005	Environment Correction:Fusing	Job Low Temp. Correction	ENG*	IM C6000: [0.0 to 100.0 / 15.0 / 0.1deg/step] IM C5500: [0.0 to 100.0 / 15.0 / 0.1deg/step] IM C4500: [0.0 to 100.0 / 15.0 / 0.1deg/step]
1-111-006	Environment Correction:Fusing	Job High Temp. Correction	ENG*	[0.0 to 100.0 / 0.0 / 0.1deg/step]
1-111-007	Environment Correction:Fusing	Job Low Temp. Correction:Sp.	ENG*	IM C6000: [0.0 to 100.0 / 15.0 / 0.1deg/step] IM C5500: [0.0 to 100.0 / 15.0 / 0.1deg/step] IM C4500: [0.0 to 100.0 / 15.0 / 0.1deg/step]
1-111-	Environment Correction:Fusing	Job High Temp. Correction:Sp.	ENG*	[0.0 to 100.0 / 0.0 / 0.1deg/step]

3.SP Mode Tables

SP No.	Large Category	Small Category	ENG or CTL	[Min to Max/Init./Step]
008				
1-111-011	Environment Correction:Fusing	Standard Environment Temp.	ENG*	[10 to 30 / 23 / 1deg/step]
1-112-001	Image Processing Temp. Correct	Temp.:Plain:Center:Level1/2	ENG*	IM C6000: [-20 to 20 / 0 / 1deg/step] IM C5500: [-20 to 20 / 0 / 1deg/step] IM C4500: [-20 to 20 / 0 / 1deg/step]
1-112-002	Image Processing Temp. Correct	Temp.:Plain:Center:Energy Saving	ENG*	IM C6000: TWN: [-30 to 20 / -14 / 1deg/step] NA: [-30 to 20 / -14 / 1deg/step] KOR: [-30 to 20 / -16 / 1deg/step] EU: [-30 to 20 / -16 / 1deg/step] CHN: [-30 to 20 / -16 / 1deg/step] AS: [-30 to 20 / -16 / 1deg/step] IM C5500: TWN: [-30 to 20 / -14 / 1deg/step] NA: [-30 to 20 / -14 / 1deg/step] KOR: [-30 to 20 / -16 / 1deg/step] EU: [-30 to 20 / -16 / 1deg/step] CHN: [-30 to 20 / -16 / 1deg/step]

3.SP Mode Tables

SP No.	Large Category	Small Category	ENG or CTL	[Min to Max/Init./Step]
				AS: [-30 to 20 / -16 / 1deg/step] IM C4500: TWN: [-30 to 20 / -12 / 1deg/step] NA: [-30 to 20 / -12 / 1deg/step] KOR: [-30 to 20 / -11 / 1deg/step] EU: [-30 to 20 / -11 / 1deg/step] CHN: [-30 to 20 / -11 / 1deg/step] AS: [-30 to 20 / -11 / 1deg/step]
1-113-001	Curl Correction	Execute Pattern	ENG*	[0 to 2 / 0 / 1/step]
1-113-002	Curl Correction	Humidity:Threshold:M-humid	ENG*	[0 to 100 / 1 / 1%/step]
1-113-003	Curl Correction	Humidity:Threshold:H-humid	ENG*	[0 to 100 / 65 / 1%/step]
1-113-004	Curl Correction	Permit Temp.:Delta:Press:M-humid	ENG*	IM C6000: [0 to 200 / 40 / 1deg/step] IM C5500: [0 to 200 / 40 / 1deg/step] IM C4500: [0 to 200 / 40 / 1deg/step]
1-113-005	Curl Correction	Permit Temp.:Delta:Press:H-humid	ENG*	IM C6000: [0 to 200 / 30 / 1deg/step] IM C5500:

3.SP Mode Tables

SP No.	Large Category	Small Category	ENG or CTL	[Min to Max/Init./Step]
				[0 to 200 / 30 / 1deg/step] IM C4500: [0 to 200 / 30 / 1deg/step]
1-113-006	Curl Correction	Permit Temp.:Delta:Press:M-humid:No Decurl	ENG*	IM C6000: [0 to 200 / 30 / 1deg/step] IM C5500: [0 to 200 / 30 / 1deg/step] IM C4500: [0 to 200 / 30 / 1deg/step]
1-113-007	Curl Correction	Permit Temp.:Delta:Press:H-humid:No Decurl	ENG*	IM C6000: [0 to 200 / 20 / 1deg/step] IM C5500: [0 to 200 / 20 / 1deg/step] IM C4500: [0 to 200 / 20 / 1deg/step]
1-113-008	Curl Correction	CPM:M-humid	ENG*	[0 to 100 / 80 / 1%/step]
1-113-009	Curl Correction	CPM:H-humid	ENG*	[0 to 100 / 65 / 1%/step]
1-113-010	Curl Correction	CPM:M-humid:No Decurl	ENG*	[0 to 100 / 80 / 1%/step]
1-113-011	Curl Correction	CPM:H-humid:No Decurl	ENG*	[0 to 100 / 65 / 1%/step]
1-115-	Target Temp. Correction	Temp.:Delta:End	ENG*	[-100 to 100 / 0 / 1deg/step]

3.SP Mode Tables

SP No.	Large Category	Small Category	ENG or CTL	[Min to Max/Init./Step]
001				
1-120-001			ENG*	[0 to 255 / 0 / 1/step]
1-120-002			ENG*	[0 to 255 / 0 / 1deg/step]
1-120-003			ENG*	[0 to 255 / 0 / 1deg/step]
1-120-004			ENG*	[0 to 255 / 0 / 1deg/step]
1-120-005			ENG*	[0 to 255 / 0 / 1deg/step]
1-120-006			ENG*	[0 to 255 / 0 / 1deg/step]
1-120-007			ENG*	[0 to 255 / 0 / 1deg/step]
1-120-008			ENG*	[0 to 255 / 0 / 1deg/step]
1-120-009			ENG*	[0 to 255 / 0 / 1deg/step]
1-120-010			ENG*	[0 to 255 / 0 / 1deg/step]
1-120-011			ENG*	[0 to 60000 / 0 / 1msec/step]
1-120-			ENG*	[0 to 60000 / 0 / 1msec/step]

3.SP Mode Tables

SP No.	Large Category	Small Category	ENG or CTL	[Min to Max/Init./Step]
012				
1-120-013			ENG*	[0 to 60000 / 0 / 1msec/step]
1-120-014			ENG*	[0 to 60000 / 0 / 1msec/step]
1-120-015			ENG*	[0 to 60000 / 0 / 1msec/step]
1-120-016			ENG*	[0 to 60000 / 0 / 1msec/step]
1-120-017			ENG*	[0 to 60000 / 0 / 1msec/step]
1-120-018			ENG*	[0 to 60000 / 0 / 1msec/step]
1-120-019			ENG*	[0 to 60000 / 0 / 1msec/step]
1-120-020			ENG*	[0 to 60000 / 0 / 1msec/step]
1-120-021			ENG*	[-120 to 120 / 0 / 1deg/step]
1-120-022			ENG*	[-120 to 120 / 0 / 1deg/step]
1-120-023			ENG*	[-120 to 120 / 0 / 1deg/step]
1-120-			ENG*	[-120 to 120 / 0 / 1deg/step]

3.SP Mode Tables

SP No.	Large Category	Small Category	ENG or CTL	[Min to Max/Init./Step]
024				
1-120-025			ENG*	[-120 to 120 / 0 / 1deg/step]
1-120-026			ENG*	[-120 to 120 / 0 / 1deg/step]
1-120-027			ENG*	[-120 to 120 / 0 / 1deg/step]
1-120-028			ENG*	[-120 to 120 / 0 / 1deg/step]
1-120-029			ENG*	[-120 to 120 / 0 / 1deg/step]
1-120-030			ENG*	[-120 to 120 / 0 / 1deg/step]
1-122-001	Standby Rotation Setting	Rotation Interval	ENG*	[0 to 240 / 60 / 1min/step]
1-122-002	Standby Rotation Setting	Rotation Time	ENG*	IM C6000: [0.0 to 60.0 / 0.8 / 0.1sec/step] IM C5500: [0.0 to 60.0 / 0.8 / 0.1sec/step] IM C4500: [0.0 to 60.0 / 0.8 / 0.1sec/step]
1-131-001	Continuous Print Mode Switch	Feed Permit Condition	ENG*	[0 to 2 / 1 / 1/step]
1-133-001	Voltage Detection	Heater ON	ENG*	IM C6000: TWN: [0.0 to 350.0 / 107.0 /

3.SP Mode Tables

SP No.	Large Category	Small Category	ENG or CTL	[Min to Max/Init./Step]
				0.1V/step] NA: [0.0 to 350.0 / 116.0 / 0.1V/step] KOR: [0.0 to 350.0 / 223.0 / 0.1V/step] EU: [0.0 to 350.0 / 223.0 / 0.1V/step] CHN: [0.0 to 350.0 / 223.0 / 0.1V/step] AS: [0.0 to 350.0 / 223.0 / 0.1V/step] IM C5500: TWN: [0.0 to 350.0 / 107.0 / 0.1V/step] NA: [0.0 to 350.0 / 116.0 / 0.1V/step] KOR: [0.0 to 350.0 / 223.0 / 0.1V/step] EU: [0.0 to 350.0 / 223.0 / 0.1V/step] CHN: [0.0 to 350.0 / 223.0 / 0.1V/step] AS: [0.0 to 350.0 / 223.0 / 0.1V/step] IM C4500: TWN: [0.0 to 350.0 / 107.0 / 0.1V/step] NA: [0.0 to 350.0 / 116.0 / 0.1V/step] KOR: [0.0 to 350.0 / 223.0 /

3.SP Mode Tables

SP No.	Large Category	Small Category	ENG or CTL	[Min to Max/Init./Step]
				0.1V/step] EU: [0.0 to 350.0 / 223.0 / 0.1V/step] CHN: [0.0 to 350.0 / 223.0 / 0.1V/step] AS: [0.0 to 350.0 / 223.0 / 0.1V/step]
1-133-002	Voltage Detection	Max	ENG*	[0.0 to 350.0 / 0.0 / 0.1V/step]
1-133-003	Voltage Detection	Min	ENG*	[0.0 to 350.0 / 350.0 / 0.1V/step]
1-133-004	Voltage Detection	Last	ENG*	[0.0 to 350.0 / 0.0 / 0.1V/step]
1-133-005	Voltage Detection	SC	ENG*	[0.0 to 350.0 / 0.0 / 0.1V/step]
1-133-006	Voltage Detection	Threshold Voltage	ENG*	IM C6000: TWN: [0 to 255 / 88 / 1V/step] NA: [0 to 255 / 96 / 1V/step] KOR: [0 to 255 / 178 / 1V/step] EU: [0 to 255 / 178 / 1V/step] CHN: [0 to 255 / 178 / 1V/step] AS: [0 to 255 / 178 / 1V/step] IM C5500: TWN: [0 to 255 / 88 / 1V/step] NA: [0 to 255 / 96 /

3.SP Mode Tables

SP No.	Large Category	Small Category	ENG or CTL	[Min to Max/Init./Step]
				1V/step] KOR: [0 to 255 / 178 / 1V/step] EU: [0 to 255 / 178 / 1V/step] CHN: [0 to 255 / 178 / 1V/step] AS: [0 to 255 / 178 / 1V/step] IM C4500: TWN: [0 to 255 / 88 / 1V/step] NA: [0 to 255 / 96 / 1V/step] KOR: [0 to 255 / 178 / 1V/step] EU: [0 to 255 / 178 / 1V/step] CHN: [0 to 255 / 178 / 1V/step] AS: [0 to 255 / 178 / 1V/step]
1-135-001	Inrush Control	Inrush Control	ENG*	[0 to 1 / 0 / 1/step]
1-135-002	Flicker Control	Flicker Control	ENG*	[0 to 1 / 0 / 1/step]
1-136-001	Recovery mode	Recovery mode SW:Low Temp	ENG*	IM C6000: [0 to 1 / 0 / 1deg/step] IM C5500: [0 to 1 / 0 / 1deg/step] IM C4500: [0 to 1 / 0 / 1deg/step]

3.SP Mode Tables

SP No.	Large Category	Small Category	ENG or CTL	[Min to Max/Init./Step]
1-136-002	Recovery mode	Recovery mode SW:Voltage:Low	ENG*	IM C6000: [0 to 1 / 0 / 1deg/step] IM C5500: [0 to 1 / 0 / 1deg/step] IM C4500: [0 to 1 / 0 / 1deg/step]
1-141-001	Fusing SC Error Time Info	SC Number	ENG*	[0 to 99999 / 0 / 1/step]
1-141-101	Fusing SC Error Time Info	Htg Roller:Ctr Det1	ENG*	[-100 to 300 / 0 / 1deg/step]
1-141-102	Fusing SC Error Time Info	Htg Roller:End Det1	ENG*	[-100 to 300 / 0 / 1deg/step]
1-141-103	Fusing SC Error Time Info	Press Roller:Ctr Det1	ENG*	[-100 to 300 / 0 / 1deg/step]
1-141-104	Fusing SC Error Time Info	Press Roller:End Det1	ENG*	[-100 to 300 / 0 / 1deg/step]
1-141-105	Fusing SC Error Time Info	NC Sensor: Center Atmosphere Temp 1	ENG*	[-100 to 300 / 0 / 1deg/step]
1-141-106	Fusing SC Error Time Info	NC Sensor: End Atmosphere Temp 1	ENG*	[-100 to 300 / 0 / 1deg/step]
1-141-107	Fusing SC Error Time Info	Press Roller:End Det 1	ENG*	[-100 to 300 / 0 / 1deg/step]
1-141-108	Fusing SC Error Time Info	Fuser State Det 1	ENG*	[0 to 100 / 0 / 1/step]
1-	Fusing SC Error	Heater1 Duty Det 1	ENG*	[0 to 100 / 0 /

3.SP Mode Tables

SP No.	Large Category	Small Category	ENG or CTL	[Min to Max/Init./Step]
141-109	Time Info			1%/step]
1-141-110	Fusing SC Error Time Info	Heater2 Duty Det 1	ENG*	[0 to 100 / 0 / 1%/step]
1-141-111	Fusing SC Error Time Info	NC Sensor: Center Det Temp AD 1	ENG*	[0 to 2000 / 0 / 1/step]
1-141-112	Fusing SC Error Time Info	NC Sensor: Center Atmosphere Temp AD 1	ENG*	[0 to 2000 / 0 / 1/step]
1-141-113	Fusing SC Error Time Info	NC Sensor: End Det Temp AD 1	ENG*	[0 to 2000 / 0 / 1/step]
1-141-114	Fusing SC Error Time Info	NC Sensor: End Atmosphere Temp AD 1	ENG*	[0 to 2000 / 0 / 1/step]
1-141-151	Fusing SC Error Time Info	Htg Roller: Ctr Det2	ENG*	[-100 to 300 / 0 / 1deg/step]
1-141-152	Fusing SC Error Time Info	Htg Roller: End Det2	ENG*	[-100 to 300 / 0 / 1deg/step]
1-141-153	Fusing SC Error Time Info	Press Roller: Ctr Det2	ENG*	[-100 to 300 / 0 / 1deg/step]
1-141-154	Fusing SC Error Time Info	Press Roller: End Det2	ENG*	[-100 to 300 / 0 / 1deg/step]
1-141-155	Fusing SC Error Time Info	NC Sensor: Center Atmosphere Temp 2	ENG*	[-100 to 300 / 0 / 1deg/step]
1-141-156	Fusing SC Error Time Info	NC Sensor: End Atmosphere Temp 2	ENG*	[-100 to 300 / 0 / 1deg/step]
1-	Fusing SC Error	Press Roller: End Det 2	ENG*	[-100 to 300 / 0 /

3.SP Mode Tables

SP No.	Large Category	Small Category	ENG or CTL	[Min to Max/Init./Step]
141-157	Time Info			1deg/step]
1-141-158	Fusing SC Error Time Info	Fuser State Det 2	ENG*	[0 to 100 / 0 / 1/step]
1-141-159	Fusing SC Error Time Info	Heater1 Duty Det 2	ENG*	[0 to 100 / 0 / 1%/step]
1-141-160	Fusing SC Error Time Info	Heater2 Duty Det 2	ENG*	[0 to 100 / 0 / 1%/step]
1-141-161	Fusing SC Error Time Info	NC Sensor: Center Det Temp AD 2	ENG*	[0 to 2000 / 0 / 1/step]
1-141-162	Fusing SC Error Time Info	NC Sensor: Center Atmosphere Temp AD 2	ENG*	[0 to 2000 / 0 / 1/step]
1-141-163	Fusing SC Error Time Info	NC Sensor: End Det Temp AD 2	ENG*	[0 to 2000 / 0 / 1/step]
1-141-164	Fusing SC Error Time Info	NC Sensor: End Atmosphere Temp AD 2	ENG*	[0 to 2000 / 0 / 1/step]
1-141-201	Fusing SC Error Time Info	Htg Roller: Ctr Det3	ENG*	[-100 to 300 / 0 / 1deg/step]
1-141-202	Fusing SC Error Time Info	Htg Roller: End Det3	ENG*	[-100 to 300 / 0 / 1deg/step]
1-141-203	Fusing SC Error Time Info	Press Roller: Ctr Det3	ENG*	[-100 to 300 / 0 / 1deg/step]
1-141-204	Fusing SC Error Time Info	Press Roller: End Det3	ENG*	[-100 to 300 / 0 / 1deg/step]
1-	Fusing SC Error	NC Sensor: Center Atmosphere Temp	ENG*	[-100 to 300 / 0 /

3.SP Mode Tables

SP No.	Large Category	Small Category	ENG or CTL	[Min to Max/Init./Step]
141-205	Time Info	3		1deg/step]
1-141-206	Fusing SC Error Time Info	NC Sensor: End Atmosphere Temp 3	ENG*	[-100 to 300 / 0 / 1deg/step]
1-141-207	Fusing SC Error Time Info	Press Roller:End Det 3	ENG*	[-100 to 300 / 0 / 1deg/step]
1-141-208	Fusing SC Error Time Info	Fuser State Det 3	ENG*	[0 to 100 / 0 / 1/step]
1-141-209	Fusing SC Error Time Info	Heater1 Duty Det 3	ENG*	[0 to 100 / 0 / 1%/step]
1-141-210	Fusing SC Error Time Info	Heater2 Duty Det 3	ENG*	[0 to 100 / 0 / 1%/step]
1-141-211	Fusing SC Error Time Info	NC Sensor: Center Det Temp AD 3	ENG*	[0 to 2000 / 0 / 1/step]
1-141-212	Fusing SC Error Time Info	NC Sensor: Center Atmosphere Temp AD 3	ENG*	[0 to 2000 / 0 / 1/step]
1-141-213	Fusing SC Error Time Info	NC Sensor: End Det Temp AD 3	ENG*	[0 to 2000 / 0 / 1/step]
1-141-214	Fusing SC Error Time Info	NC Sensor: End Atmosphere Temp AD 3	ENG*	[0 to 2000 / 0 / 1/step]
1-142-001	Fusing Jam Detection	SC Display	ENG*	[0 to 1 / 0 / 1/step]
1-152-001	Fusing Nip Band Check	Execute	ENG	[0 to 1 / 0 / 1/step]
1-	Fusing Nip Band	Pre-idling Time	ENG*	[0 to 999 / 300 /

3.SP Mode Tables

SP No.	Large Category	Small Category	ENG or CTL	[Min to Max/Init./Step]
152-002	Check			1sec/step]
1-152-003	Fusing Nip Band Check	Stop Time	ENG*	[0 to 100 / 20 / 1sec/step]
1-152-004	Fusing Nip Band Check	Pressure Position	ENG*	[1 to 2 / 2 / 1/step]
1-153-001	Abnormal Noise Confirmation	Unit: Execute	ENG	[0 to 1 / 0 / 1/step]
1-153-002	Abnormal Noise Confirmation	No Unit: Execute	ENG	[0 to 1 / 0 / 1/step]
1-153-003	Abnormal Noise Confirmation	Operation Line Speed	ENG	[0 to 2 / 0 / 1/step]
1-153-004	Abnormal Noise Confirmation	Operation Time	ENG	[0 to 240 / 60 / 1sec/step]
1-153-005	Abnormal Noise Confirmation	Heat Center Target Temp	ENG	[100 to 180 / 130 / 1deg/step]
1-153-006	Abnormal Noise Confirmation	Heat End Target Temp	ENG	[100 to 180 / 130 / 1deg/step]
1-153-007	Abnormal Noise Confirmation	Press Target Temp	ENG	[0 to 200 / 0 / 1deg/step]
1-165-001	Shading Plate Control	Execution Judgement	ENG*	[0 to 1 / 0 / 1/step]
1-165-101	Shading Plate Control	Continuous Error Times	ENG*	[0 to 10 / 0 / 1/step]
1-	Shading Plate	Fusing Shading Plate Operation:Result	ENG*	[0 to 10 / 0 /

3.SP Mode Tables

SP No.	Large Category	Small Category	ENG or CTL	[Min to Max/Init./Step]
165-151	Control			1/step]
1-801-001	Moter Speed Adjust	Feed CCW:Plain:Low	ENG*	[-2.0 to 2.0 / 0.9 / 0.1%/step]
1-801-002	Moter Speed Adjust	Feed CCW:Plain:Std	ENG*	[-2.0 to 2.0 / 0.9 / 0.1%/step]
1-801-003	Moter Speed Adjust	Feed CCW:Mid-thick:Low	ENG*	[-2.0 to 2.0 / 1.1 / 0.1%/step]
1-801-004	Moter Speed Adjust	Feed CCW:Mid-thick:Std	ENG*	[-2.0 to 2.0 / 1.1 / 0.1%/step]
1-801-005	Moter Speed Adjust	Feed CCW:Thick 1:Low	ENG*	[-2.0 to 2.0 / 1.2 / 0.1%/step]
1-801-006	Moter Speed Adjust	Feed CCW:Thick 1:Mid	ENG*	[-2.0 to 2.0 / 1.2 / 0.1%/step]
1-801-007	Moter Speed Adjust	Feed CCW:Thick 2:Low	ENG*	[-2.0 to 2.0 / 1.2 / 0.1%/step]
1-801-008	Moter Speed Adjust	Feed CCW:Thick 3:Low	ENG*	[-2.0 to 2.0 / 0.9 / 0.1%/step]
1-801-009	Moter Speed Adjust	Feed CCW:Thick 4:Low	ENG*	[-2.0 to 2.0 / 0.9 / 0.1%/step]
1-801-010	Moter Speed Adjust	Feed CW:Plain:Low	ENG*	[-2.0 to 2.0 / 0.9 / 0.1%/step]
1-801-011	Moter Speed Adjust	Feed CW:Plain:Std	ENG*	[-2.0 to 2.0 / 0.9 / 0.1%/step]
1-	Moter Speed Adjust	Feed CW:Mid-thick:Low	ENG*	[-2.0 to 2.0 / 1.1 /

3.SP Mode Tables

SP No.	Large Category	Small Category	ENG or CTL	[Min to Max/Init./Step]
801-012				0.1%/step]
1-801-013	Moter Speed Adjust	Feed CW:Mid-thick:Std	ENG*	[-2.0 to 2.0 / 1.1 / 0.1%/step]
1-801-014	Moter Speed Adjust	Feed CW:Thick 1:Low	ENG*	[-2.0 to 2.0 / 1.2 / 0.1%/step]
1-801-015	Moter Speed Adjust	Feed CW:Thick 1:Mid	ENG*	[-2.0 to 2.0 / 1.2 / 0.1%/step]
1-801-016	Moter Speed Adjust	Feed CW:Thick 2:Low	ENG*	[-2.0 to 2.0 / 1.2 / 0.1%/step]
1-801-017	Moter Speed Adjust	Feed CW:Thick 3:Low	ENG*	[-2.0 to 2.0 / 0.9 / 0.1%/step]
1-801-018	Moter Speed Adjust	Feed CW:Thick 4:Low	ENG*	[-2.0 to 2.0 / 0.9 / 0.1%/step]
1-801-019	Moter Speed Adjust	Vertical Feed:Plain:Low	ENG*	[-2.0 to 2.0 / 0.9 / 0.1%/step]
1-801-020	Moter Speed Adjust	Vertical Feed:Plain:Std	ENG*	[-2.0 to 2.0 / 0.9 / 0.1%/step]
1-801-021	Moter Speed Adjust	Vertical Feed:Mid-thick:Low	ENG*	[-2.0 to 2.0 / 1.1 / 0.1%/step]
1-801-022	Moter Speed Adjust	Vertical Feed:Mid-thick:Std	ENG*	[-2.0 to 2.0 / 1.1 / 0.1%/step]
1-801-023	Moter Speed Adjust	Vertical Feed:Thick 1:Low	ENG*	[-2.0 to 2.0 / 1.2 / 0.1%/step]
1-	Moter Speed Adjust	Vertical Feed:Thick 1:Mid	ENG*	[-2.0 to 2.0 / 1.2 /

3.SP Mode Tables

SP No.	Large Category	Small Category	ENG or CTL	[Min to Max/Init./Step]
801-024				0.1%/step]
1-801-025	Moter Speed Adjust	Vertical Feed:Thick 2:Low	ENG*	[-2.0 to 2.0 / 1.2 / 0.1%/step]
1-801-026	Moter Speed Adjust	Vertical Feed:Thick 3:Low	ENG*	[-2.0 to 2.0 / 0.9 / 0.1%/step]
1-801-027	Moter Speed Adjust	Vertical Feed:Thick 4:Low	ENG*	[-2.0 to 2.0 / 0.9 / 0.1%/step]
1-801-028	Moter Speed Adjust	Registration:Plain:Low	ENG*	[-2.0 to 2.0 / 0.3 / 0.1%/step]
1-801-029	Moter Speed Adjust	Registration:Plain:Std	ENG*	[-2.0 to 2.0 / 0.3 / 0.1%/step]
1-801-030	Moter Speed Adjust	Registration:Mid-thick:Low	ENG*	[-2.0 to 2.0 / 0.3 / 0.1%/step]
1-801-031	Moter Speed Adjust	Registration:Mid-thick:Std	ENG*	[-2.0 to 2.0 / 0.3 / 0.1%/step]
1-801-032	Moter Speed Adjust	Registration:Thick 1:Low	ENG*	[-2.0 to 2.0 / 0.4 / 0.1%/step]
1-801-033	Moter Speed Adjust	Registration:Thick1:Mid	ENG*	[-2.0 to 2.0 / 0.4 / 0.1%/step]
1-801-034	Moter Speed Adjust	Registration:Thick 2:Low	ENG*	[-2.0 to 2.0 / 0.4 / 0.1%/step]
1-801-035	Moter Speed Adjust	Registration:Thick 3:Low	ENG*	[-2.0 to 2.0 / 0.3 / 0.1%/step]
1-	Moter Speed Adjust	Registration:Thick 4:Low	ENG*	[-2.0 to 2.0 / 0.3 /

3.SP Mode Tables

SP No.	Large Category	Small Category	ENG or CTL	[Min to Max/Init./Step]
801-036				0.1%/step]
1-801-037	Moter Speed Adjust	Exit CCW:Plain:Low	ENG*	[-4.0 to 4.0 / -0.8 / 0.1%/step]
1-801-038	Moter Speed Adjust	Exit CCW:Plain:Std	ENG*	[-4.0 to 4.0 / -0.8 / 0.1%/step]
1-801-039	Moter Speed Adjust	Exit CCW:Mid-thick:Low	ENG*	[-4.0 to 4.0 / -0.8 / 0.1%/step]
1-801-040	Moter Speed Adjust	Exit CCW:Mid-thick:Std	ENG*	[-4.0 to 4.0 / -0.8 / 0.1%/step]
1-801-041	Moter Speed Adjust	Exit CCW:Thick1:Low	ENG*	[-4.0 to 4.0 / -0.8 / 0.1%/step]
1-801-042	Moter Speed Adjust	Exit CCW:Thick1:Mid	ENG*	[-4.0 to 4.0 / -0.6 / 0.1%/step]
1-801-043	Moter Speed Adjust	Exit CCW:Thick2:Low	ENG*	[-4.0 to 4.0 / -0.9 / 0.1%/step]
1-801-044	Moter Speed Adjust	Exit CCW:Thick3:Low	ENG*	[-4.0 to 4.0 / -0.9 / 0.1%/step]
1-801-045	Moter Speed Adjust	Exit CCW:Thick4:Low	ENG*	[-4.0 to 4.0 / -0.4 / 0.1%/step]
1-801-046	Moter Speed Adjust	Reverse CW:Plain:Low	ENG*	[-4.0 to 4.0 / 0.7 / 0.1%/step]
1-801-047	Moter Speed Adjust	Reverse CW:Plain:Std	ENG*	[-4.0 to 4.0 / 0.7 / 0.1%/step]
1-	Moter Speed Adjust	Reverse CW:Mid-thick:Low	ENG*	[-4.0 to 4.0 / 0.5 /

3.SP Mode Tables

SP No.	Large Category	Small Category	ENG or CTL	[Min to Max/Init./Step]
801-048				0.1%/step]
1-801-049	Moter Speed Adjust	Reverse CW:Mid-thick:Std	ENG*	[-4.0 to 4.0 / 0.5 / 0.1%/step]
1-801-050	Moter Speed Adjust	Reverse CW:Thick1:Low	ENG*	[-4.0 to 4.0 / 0.7 / 0.1%/step]
1-801-051	Moter Speed Adjust	Reverse CW:Thick1:Mid	ENG*	[-4.0 to 4.0 / 0.7 / 0.1%/step]
1-801-052	Moter Speed Adjust	Reverse CW:Thick2:Low	ENG*	[-4.0 to 4.0 / 0.8 / 0.1%/step]
1-801-053	Moter Speed Adjust	Reverse CW:Thick3:Low	ENG*	[-4.0 to 4.0 / 0.7 / 0.1%/step]
1-801-054	Moter Speed Adjust	Reverse CW:Thick4:Low	ENG*	[-4.0 to 4.0 / 0.7 / 0.1%/step]
1-801-055	Moter Speed Adjust	Reverse CCW:Plain:Low	ENG*	[-4.0 to 4.0 / -0.8 / 0.1%/step]
1-801-056	Moter Speed Adjust	Reverse CCW:Plain:Std	ENG*	[-4.0 to 4.0 / -0.8 / 0.1%/step]
1-801-057	Moter Speed Adjust	Reverse CCW:Mid-thick:Low	ENG*	[-4.0 to 4.0 / -0.8 / 0.1%/step]
1-801-058	Moter Speed Adjust	Reverse CCW:Mid-thick:Std	ENG*	[-4.0 to 4.0 / -0.8 / 0.1%/step]
1-801-059	Moter Speed Adjust	Reverse CCW:Thick1:Low	ENG*	[-4.0 to 4.0 / -0.8 / 0.1%/step]
1-	Moter Speed Adjust	Reverse CCW:Thick1:Mid	ENG*	[-4.0 to 4.0 / -0.6 /

3.SP Mode Tables

SP No.	Large Category	Small Category	ENG or CTL	[Min to Max/Init./Step]
801-060				0.1%/step]
1-801-061	Moter Speed Adjust	Reverse CCW:Thick2:Low	ENG*	[-4.0 to 4.0 / -0.9 / 0.1%/step]
1-801-062	Moter Speed Adjust	Reverse CCW:Thick3:Low	ENG*	[-4.0 to 4.0 / -0.9 / 0.1%/step]
1-801-063	Moter Speed Adjust	Reverse CCW:Thick4:Low	ENG*	[-4.0 to 4.0 / -0.4 / 0.1%/step]
1-801-064	Moter Speed Adjust	Duplex Enter CW:Plain:Low	ENG*	[-4.0 to 4.0 / 1.4 / 0.1%/step]
1-801-065	Moter Speed Adjust	Duplex Enter CW:Plain:Std	ENG*	[-4.0 to 4.0 / 1.4 / 0.1%/step]
1-801-066	Moter Speed Adjust	Duplex Enter CW:Mid-thick:Low	ENG*	[-4.0 to 4.0 / 1.2 / 0.1%/step]
1-801-067	Moter Speed Adjust	Duplex Enter CW:Mid-thick:Std	ENG*	[-4.0 to 4.0 / 1.2 / 0.1%/step]
1-801-068	Moter Speed Adjust	Duplex Enter CW:Thick1:Low	ENG*	[-4.0 to 4.0 / 1.5 / 0.1%/step]
1-801-069	Moter Speed Adjust	Duplex Enter CW:Thick1:Mid	ENG*	[-4.0 to 4.0 / 1.5 / 0.1%/step]
1-801-070	Moter Speed Adjust	Duplex Enter CW:Thick2:Low	ENG*	[-4.0 to 4.0 / 1.5 / 0.1%/step]
1-801-071	Moter Speed Adjust	Duplex Enter CW:Thick3:Low	ENG*	[-4.0 to 4.0 / 1.4 / 0.1%/step]
1-	Moter Speed Adjust	Duplex CW:Plain:Low	ENG*	[-4.0 to 4.0 / 0.7 /

3.SP Mode Tables

SP No.	Large Category	Small Category	ENG or CTL	[Min to Max/Init./Step]
801-072				0.1%/step]
1-801-073	Moter Speed Adjust	Duplex CW:Plain:Std	ENG*	[-4.0 to 4.0 / 0.7 / 0.1%/step]
1-801-074	Moter Speed Adjust	Duplex CW:Mid-thick:Low	ENG*	[-4.0 to 4.0 / 0.5 / 0.1%/step]
1-801-075	Moter Speed Adjust	Duplex CW:Mid-thick:Std	ENG*	[-4.0 to 4.0 / 0.5 / 0.1%/step]
1-801-076	Moter Speed Adjust	Duplex CW:Thick1:Low	ENG*	[-4.0 to 4.0 / 0.8 / 0.1%/step]
1-801-077	Moter Speed Adjust	Duplex CW:Thick1:Mid	ENG*	[-4.0 to 4.0 / 0.8 / 0.1%/step]
1-801-078	Moter Speed Adjust	Duplex CW:Thick2:Low	ENG*	[-4.0 to 4.0 / 0.8 / 0.1%/step]
1-801-079	Moter Speed Adjust	Duplex CW:Thick3:Low	ENG*	[-4.0 to 4.0 / 0.7 / 0.1%/step]
1-801-080	Moter Speed Adjust	Duplex CCW:Plain:Low	ENG*	[-4.0 to 4.0 / 0.9 / 0.1%/step]
1-801-081	Moter Speed Adjust	Duplex CCW:Plain:Std	ENG*	[-4.0 to 4.0 / 0.9 / 0.1%/step]
1-801-082	Moter Speed Adjust	Duplex CCW:Mid-thick:Low	ENG*	[-4.0 to 4.0 / 1.1 / 0.1%/step]
1-801-083	Moter Speed Adjust	Duplex CCW:Mid-thick:Std	ENG*	[-4.0 to 4.0 / 1.1 / 0.1%/step]
1-	Moter Speed Adjust	Duplex CCW:Thick1:Low	ENG*	[-4.0 to 4.0 / 1.2 /

3.SP Mode Tables

SP No.	Large Category	Small Category	ENG or CTL	[Min to Max/Init./Step]
801-084				0.1%/step]
1-801-085	Motor Speed Adjust	Duplex CCW:Thick1:Mid	ENG*	[-4.0 to 4.0 / 1.2 / 0.1%/step]
1-801-086	Motor Speed Adjust	Duplex CCW:Thick2:Low	ENG*	[-4.0 to 4.0 / 1.2 / 0.1%/step]
1-801-087	Motor Speed Adjust	Duplex CCW:Thick3:Low	ENG*	[-4.0 to 4.0 / 0.9 / 0.1%/step]
1-801-088	Motor Speed Adjust	Duplex CCW:Thick4:Low	ENG*	[-4.0 to 4.0 / 0.9 / 0.1%/step]
1-801-089	Motor Speed Adjust	Relay Motor Speed Adjust:Low	ENG*	[-4.0 to 4.0 / 0.0 / 0.1%/step]
1-801-090	Motor Speed Adjust	Relay Motor Speed Adjust:Mid	ENG*	[-4.0 to 4.0 / 0.0 / 0.1%/step]
1-801-091	Motor Speed Adjust	Relay Motor Speed Adjust:Standard	ENG*	[-4.0 to 4.0 / 0.0 / 0.1%/step]
1-801-100	Motor Speed Adj.	Drum Adjust	ENG*	[0 to 1 / 1 / 1/step]
1-801-101	Motor Speed Adj.	Offset:ColorOpcMot:Standard	ENG*	[-10.00 to 10.00 / 0.00 / 0.01Hz/step]
1-801-102	Motor Speed Adj.	Offset:ColorOpcMot:Mid	ENG*	[-10.00 to 10.00 / 0.00 / 0.01Hz/step]
1-801-103	Motor Speed Adj.	Offset:ColorOpcMot:Low	ENG*	[-10.00 to 10.00 / 0.00 / 0.01Hz/step]
1-	Motor Speed Adj.	ColorOpcMot:Standard	ENG*	[-10.00 to 10.00 /

3.SP Mode Tables

SP No.	Large Category	Small Category	ENG or CTL	[Min to Max/Init./Step]
801-106				0.00 / 0.01Hz/step]
1-801-107	Motor Speed Adj.	ColorOpcMot:Mid	ENG*	[-10.00 to 10.00 / 0.00 / 0.01Hz/step]
1-801-108	Motor Speed Adj.	ColorOpcMot:Low	ENG*	[-10.00 to 10.00 / 0.00 / 0.01Hz/step]
1-801-109	Motor Speed Adj.	BkDevMot:Standard	ENG*	[-20.0 to 20.0 / 0.0 / 0.1%/step]
1-801-110	Motor Speed Adj.	BkDevMot:Mid	ENG*	[-20.0 to 20.0 / 0.0 / 0.1%/step]
1-801-111	Motor Speed Adj.	BkDevMot:Low	ENG*	[-20.0 to 20.0 / 0.0 / 0.1%/step]
1-801-115	Motor Speed Adj.	ColorDevMot:Standard	ENG*	[-20.0 to 20.0 / 0.0 / 0.1%/step]
1-801-116	Motor Speed Adj.	ColorDevMot:Mid	ENG*	[-20.0 to 20.0 / 0.0 / 0.1%/step]
1-801-117	Motor Speed Adj.	ColorDevMot:Low	ENG*	[-20.0 to 20.0 / 0.0 / 0.1%/step]
1-801-118	Motor Speed Adj.	Fusing:Standard	ENG*	[-10.00 to 10.00 / -1.40 / 0.01%/step]
1-801-119	Motor Speed Adj.	Fusing:Mid	ENG*	[-10.00 to 10.00 / -1.00 / 0.01%/step]
1-801-120	Motor Speed Adj.	Fusing:Low	ENG*	[-10.00 to 10.00 / -1.00 / 0.01%/step]
1-	Motor Speed Adj.	Fusing:Low:1200:Plain	ENG*	[-10.00 to 10.00 / -

3.SP Mode Tables

SP No.	Large Category	Small Category	ENG or CTL	[Min to Max/Init./Step]
801-121				1.40 / 0.01%/step]
1-801-122	Motor Speed Adj.	OPCTransferMot:Standard	ENG*	[-10.00 to 10.00 / 0.20 / 0.01%/step]
1-801-123	Motor Speed Adj.	OPCTransferMot:Mid	ENG*	[-10.00 to 10.00 / 0.20 / 0.01%/step]
1-801-124	Motor Speed Adj.	OPCTransferMot:Low	ENG*	[-10.00 to 10.00 / 0.20 / 0.01%/step]
1-801-125	Motor Speed Adj.	Fusing:Low:Thick 4	ENG*	[-10.00 to 10.00 / -0.50 / 0.01%/step]
1-801-133	Motor Speed Adj.	ColorOpcMot:Standard:independence	ENG*	[-10.00 to 10.00 / -0.20 / 0.01%/step]
1-801-134	Motor Speed Adj.	ColorOpcMot:Mid:independence	ENG*	[-10.00 to 10.00 / -0.20 / 0.01%/step]
1-801-135	Motor Speed Adj.	ColorOpcMot:Low:independence	ENG*	[-10.00 to 10.00 / -0.20 / 0.01%/step]
1-801-140	Motor Speed Adjust	Long:Registration:Plain:Low	ENG*	[-2.0 to 2.0 / 0.3 / 0.1%/step]
1-801-141	Motor Speed Adjust	Long:Registration:Plain:High	ENG*	[-2.0 to 2.0 / 0.3 / 0.1%/step]
1-801-142	Motor Speed Adjust	Long:Registration:Middle Thick:Low	ENG*	[-2.0 to 2.0 / 0.3 / 0.1%/step]
1-801-143	Motor Speed Adjust	Long:Registration:Middle Thick:High	ENG*	[-2.0 to 2.0 / 0.3 / 0.1%/step]
1-	Motor Speed Adjust	Long:Registration:Thick 1:Low	ENG*	[-2.0 to 2.0 / 0.4 /

3.SP Mode Tables

SP No.	Large Category	Small Category	ENG or CTL	[Min to Max/Init./Step]
801-144				0.1%/step]
1-801-145	Motor Speed Adjust	Long:Registration:Thick 1:Middle	ENG*	[-2.0 to 2.0 / 0.4 / 0.1%/step]
1-801-146	Motor Speed Adjust	Long:Registration:Thick 2:Low	ENG*	[-2.0 to 2.0 / 0.4 / 0.1%/step]
1-801-147	Motor Speed Adjust	Long:Registration:Thick 3:Low	ENG*	[-2.0 to 2.0 / 0.3 / 0.1%/step]
1-801-148	Motor Speed Adjust	Long:Registration:Thick 4:Low	ENG*	[-2.0 to 2.0 / 0.3 / 0.1%/step]
1-801-160	Motor Speed Adjust	Long:Fusing:Plain:Low	ENG*	[-10.00 to 10.00 / -1.20 / 0.01%/step]
1-801-161	Motor Speed Adjust	Long:Fusing:Plain:High	ENG*	[-10.00 to 10.00 / -1.40 / 0.01%/step]
1-801-162	Motor Speed Adjust	Long:Fusing:Middle Thick:Low	ENG*	[-10.00 to 10.00 / -0.80 / 0.01%/step]
1-801-163	Motor Speed Adjust	Long:Fusing:Middle Thick:High	ENG*	[-10.00 to 10.00 / -1.40 / 0.01%/step]
1-801-164	Motor Speed Adjust	Long:Fusing:Thick 1:Low	ENG*	[-10.00 to 10.00 / -0.80 / 0.01%/step]
1-801-165	Motor Speed Adjust	Long:Fusing:Thick 1:Middle	ENG*	[-10.00 to 10.00 / -0.80 / 0.01%/step]
1-801-166	Motor Speed Adjust	Long:Fusing:Thick 2:Low	ENG*	[-10.00 to 10.00 / -0.80 / 0.01%/step]
1-	Motor Speed Adjust	Long:Fusing:Thick 3:Low	ENG*	[-10.00 to 10.00 / -

3.SP Mode Tables

SP No.	Large Category	Small Category	ENG or CTL	[Min to Max/Init./Step]
801-167				0.80 / 0.01%/step]
1-801-168	Motor Speed Adjust	Long:Fusing:Thick 4:Low	ENG*	[-10.00 to 10.00 / -0.80 / 0.01%/step]
1-801-180	Motor Speed Adjust	Long:Exit CCW:Plain:Low	ENG*	[-4.0 to 4.0 / -0.8 / 0.1%/step]
1-801-181	Motor Speed Adjust	Long:Exit CCW:Plain:High	ENG*	[-4.0 to 4.0 / -0.8 / 0.1%/step]
1-801-182	Motor Speed Adjust	Long:Exit CCW:Middle Thick:Low	ENG*	[-4.0 to 4.0 / -0.8 / 0.1%/step]
1-801-183	Motor Speed Adjust	Long:Exit CCW:Middle Thick:High	ENG*	[-4.0 to 4.0 / -0.8 / 0.1%/step]
1-801-184	Motor Speed Adjust	Long:Exit CCW:Thick 1:Low	ENG*	[-4.0 to 4.0 / -0.8 / 0.1%/step]
1-801-185	Motor Speed Adjust	Long:Exit CCW:Thick 1:Middle	ENG*	[-4.0 to 4.0 / -0.6 / 0.1%/step]
1-801-186	Motor Speed Adjust	Long:Exit CCW:Thick 2:Low	ENG*	[-4.0 to 4.0 / -0.9 / 0.1%/step]
1-801-187	Motor Speed Adjust	Long:Exit CCW:Thick 3:Low	ENG*	[-4.0 to 4.0 / -0.9 / 0.1%/step]
1-801-188	Motor Speed Adjust	Long:Exit CCW:Thick 4:Low	ENG*	[-4.0 to 4.0 / -0.9 / 0.1%/step]
1-805-050	Motor Gain Adj.	DuplexInM:Speed Detective Gain	ENG*	[0.00 to 200.00 / 100.00 / 0.01%/step]
1-	Motor Gain Adj.	DuplexInM:Position Loop Gain	ENG*	[0.00 to 200.00 /

3.SP Mode Tables

SP No.	Large Category	Small Category	ENG or CTL	[Min to Max/Init./Step]
805-051				50.00 / 0.01%/step]
1-805-052	Motor Gain Adj.	DuplexInM:Proportional Gain:PID	ENG*	[0.00 to 200.00 / 50.00 / 0.01%/step]
1-805-053	Motor Gain Adj.	DuplexInM:Integral Gain:PID	ENG*	[0.00 to 200.00 / 50.00 / 0.01%/step]
1-805-054	Motor Gain Adj.	DuplexInM:Derivative Gain:PID	ENG*	[0.00 to 200.00 / 50.00 / 0.01%/step]
1-805-055	Motor Gain Adj.	DuplexInM:Derivative Gain:FF	ENG*	[0.00 to 200.00 / 100.00 / 0.01%/step]
1-805-056	Motor Gain Adj.	DuplexInM:Proportional Gain:FF	ENG*	[0.00 to 200.00 / 100.00 / 0.01%/step]
1-805-057	Motor Gain Adj.	DuplexInM:Offset:FF	ENG*	[0.00 to 200.00 / 100.00 / 0.01%/step]
1-805-058	Motor Gain Adj.	DuplexInM:Numerator Coefficient:LPF:B0	ENG*	[0.00 to 200.00 / 100.00 / 0.01%/step]
1-805-059	Motor Gain Adj.	DuplexInM:Denominator Coefficient:LPF:A1	ENG*	[0.00 to 200.00 / 100.00 / 0.01%/step]
1-805-060	Motor Gain Adj.	DuplexInM:Denominator Coefficient:LPF:A2	ENG*	[0.00 to 200.00 / 100.00 / 0.01%/step]
1-805-061	Motor Gain Adj.	DuplexM:Speed Detective Gain	ENG*	[0.00 to 200.00 / 100.00 / 0.01%/step]
1-805-062	Motor Gain Adj.	DuplexM:Position Loop Gain	ENG*	[0.00 to 200.00 / 50.00 / 0.01%/step]
1-	Motor Gain Adj.	DuplexM:Proportional Gain:PID	ENG*	[0.00 to 200.00 /

3.SP Mode Tables

SP No.	Large Category	Small Category	ENG or CTL	[Min to Max/Init./Step]
805-063				50.00 / 0.01%/step]
1-805-064	Motor Gain Adj.	DuplexM:Integral Gain:PID	ENG*	[0.00 to 200.00 / 50.00 / 0.01%/step]
1-805-065	Motor Gain Adj.	DuplexM:Derivative Gain:PID	ENG*	[0.00 to 200.00 / 50.00 / 0.01%/step]
1-805-066	Motor Gain Adj.	DuplexM:Derivative Gain:FF	ENG*	[0.00 to 200.00 / 100.00 / 0.01%/step]
1-805-067	Motor Gain Adj.	DuplexM:Proportional Gain:FF	ENG*	[0.00 to 200.00 / 100.00 / 0.01%/step]
1-805-068	Motor Gain Adj.	DuplexM:Offset:FF	ENG*	[0.00 to 200.00 / 100.00 / 0.01%/step]
1-805-069	Motor Gain Adj.	DuplexM:Numerator Coefficient:LPF:B0	ENG*	[0.00 to 200.00 / 100.00 / 0.01%/step]
1-805-070	Motor Gain Adj.	DuplexM:Denominator Coefficient:LPF:A1	ENG*	[0.00 to 200.00 / 100.00 / 0.01%/step]
1-805-071	Motor Gain Adj.	DuplexM:Denominator Coefficient:LPF:A2	ENG*	[0.00 to 200.00 / 100.00 / 0.01%/step]
1-805-072	Motor Gain Adj.	DuplexM:Speed Detective Gain	ENG*	[0.00 to 200.00 / 100.00 / 0.01%/step]
1-805-073	Motor Gain Adj.	DuplexM:Position Loop Gain	ENG*	[0.00 to 200.00 / 50.00 / 0.01%/step]
1-805-074	Motor Gain Adj.	DuplexM:Proportional Gain:PID	ENG*	[0.00 to 200.00 / 50.00 / 0.01%/step]
1-	Motor Gain Adj.	DuplexM:Integral Gain:PID	ENG*	[0.00 to 200.00 /

3.SP Mode Tables

SP No.	Large Category	Small Category	ENG or CTL	[Min to Max/Init./Step]
805-075				50.00 / 0.01%/step]
1-805-076	Motor Gain Adj.	DuplexM:Derivative Gain:PID	ENG*	[0.00 to 200.00 / 50.00 / 0.01%/step]
1-805-077	Motor Gain Adj.	DuplexM:Derivative Gain:FF	ENG*	[0.00 to 200.00 / 100.00 / 0.01%/step]
1-805-078	Motor Gain Adj.	DuplexM:Proportional Gain:FF	ENG*	[0.00 to 200.00 / 100.00 / 0.01%/step]
1-805-079	Motor Gain Adj.	DuplexM:Offset:FF	ENG*	[0.00 to 200.00 / 100.00 / 0.01%/step]
1-805-080	Motor Gain Adj.	DuplexM:Numerator Coefficient:LPF:B0	ENG*	[0.00 to 200.00 / 100.00 / 0.01%/step]
1-805-081	Motor Gain Adj.	DuplexM:Denominator Coefficient:LPF:A1	ENG*	[0.00 to 200.00 / 100.00 / 0.01%/step]
1-805-082	Motor Gain Adj.	DuplexM:Denominator Coefficient:LPF:A2	ENG*	[0.00 to 200.00 / 100.00 / 0.01%/step]
1-805-115	Motor Gain Adj.	DuplexInM:Proportional Gain:PID	ENG*	[0.00 to 200.00 / 100.00 / 0.01%/step]
1-805-116	Motor Gain Adj.	DuplexInM:Integral Gain:PID	ENG*	[0.00 to 200.00 / 100.00 / 0.01%/step]
1-805-117	Motor Gain Adj.	DuplexInM:Derivative Gain:PID	ENG*	[0.00 to 200.00 / 100.00 / 0.01%/step]
1-805-118	Motor Gain Adj.	DuplexM:Proportional Gain:PID	ENG*	[0.00 to 200.00 / 100.00 / 0.01%/step]
1-	Motor Gain Adj.	DuplexM:Integral Gain:PID	ENG*	[0.00 to 200.00 /

3.SP Mode Tables

SP No.	Large Category	Small Category	ENG or CTL	[Min to Max/Init./Step]
805-119				100.00 / 0.01%/step]
1-805-120	Motor Gain Adj.	DuplexM:Derivative Gain:PID	ENG*	[0.00 to 200.00 / 100.00 / 0.01%/step]
1-805-121	Motor Gain Adj.	DuplexM:Proportional Gain:PID	ENG*	[0.00 to 200.00 / 100.00 / 0.01%/step]
1-805-122	Motor Gain Adj.	DuplexM:Integral Gain:PID	ENG*	[0.00 to 200.00 / 100.00 / 0.01%/step]
1-805-123	Motor Gain Adj.	DuplexM:Derivative Gain:PID	ENG*	[0.00 to 200.00 / 100.00 / 0.01%/step]
1-805-136	Inner M Status	Paper Feed M	ENG*	[0 to 65535 / 0 / 1/step]
1-805-137	Inner M Status	Paper Grip M	ENG*	[0 to 65535 / 0 / 1/step]
1-805-138	Inner M Status	Registration M	ENG*	[0 to 65535 / 0 / 1/step]
1-805-139	Inner M Status	Paper Exit M	ENG*	[0 to 65535 / 0 / 1/step]
1-805-140	Inner M Status	Duplex Entrance M	ENG*	[0 to 65535 / 0 / 1/step]
1-805-141	Inner M Status	Duplex Bypass M	ENG*	[0 to 65535 / 0 / 1/step]
1-806-020	Motor Speed Profile	DuplexInM:Acceleration1	ENG*	[0.00 to 200.00 / 100.00 / 0.01%/step]
1-	Motor Speed Profile	DuplexInM:Deceleration1	ENG*	[0.00 to 200.00 /

3.SP Mode Tables

SP No.	Large Category	Small Category	ENG or CTL	[Min to Max/Init./Step]
806-021				100.00 / 0.01%/step]
1-806-022	Motor Speed Profile	DuplexInM:Acceleration2	ENG*	[0.00 to 200.00 / 100.00 / 0.01%/step]
1-806-023	Motor Speed Profile	DuplexInM:Deceleration2	ENG*	[0.00 to 200.00 / 100.00 / 0.01%/step]
1-806-024	Motor Speed Profile	DuplexM:Acceleration1	ENG*	[0.00 to 200.00 / 100.00 / 0.01%/step]
1-806-025	Motor Speed Profile	DuplexM:Deceleration1	ENG*	[0.00 to 200.00 / 100.00 / 0.01%/step]
1-806-026	Motor Speed Profile	DuplexM:Acceleration2	ENG*	[0.00 to 200.00 / 100.00 / 0.01%/step]
1-806-027	Motor Speed Profile	DuplexM:Deceleration2	ENG*	[0.00 to 200.00 / 100.00 / 0.01%/step]
1-806-028	Motor Speed Profile	DuplexM:Acceleration1	ENG*	[0.00 to 200.00 / 100.00 / 0.01%/step]
1-806-029	Motor Speed Profile	DuplexM:Deceleration1	ENG*	[0.00 to 200.00 / 100.00 / 0.01%/step]
1-806-030	Motor Speed Profile	DuplexM:Acceleration2	ENG*	[0.00 to 200.00 / 100.00 / 0.01%/step]
1-806-031	Motor Speed Profile	DuplexM:Deceleration2	ENG*	[0.00 to 200.00 / 100.00 / 0.01%/step]
1-902-001	Drum Phase Adj.	Execute	ENG	[0 to 1 / 0 / 1/step]
1-	Paper Feed Timing	Feed Solenoid ON:Tray1:Plain	ENG*	[-20 to 20 / 0 /

3.SP Mode Tables

SP No.	Large Category	Small Category	ENG or CTL	[Min to Max/Init./Step]
907-001	Adj.			1mm/step]
1-907-002	Paper Feed Timing Adj.	Feed Solenoid ON:Tray1:Thick	ENG*	[-20 to 20 / 0 / 1mm/step]
1-907-003	Paper Feed Timing Adj.	Feed Solenoid ON:Tray2:Plain	ENG*	[-20 to 20 / 0 / 1mm/step]
1-907-004	Paper Feed Timing Adj.	Feed Solenoid ON:Tray2:Thick	ENG*	[-20 to 20 / 0 / 1mm/step]
1-907-005	Paper Feed Timing Adj.	Feed DCM OFF:Tray1:Plain	ENG*	[-20 to 20 / 0 / 1mm/step]
1-907-006	Paper Feed Timing Adj.	Feed DCM OFF:Tray1:Thick	ENG*	[-20 to 20 / 0 / 1mm/step]
1-907-007	Paper Feed Timing Adj.	Feed DCM OFF:Tray2:Plain	ENG*	[-20 to 20 / 0 / 1mm/step]
1-907-008	Paper Feed Timing Adj.	Feed DCM OFF:Tray2:Thick	ENG*	[-20 to 20 / 0 / 1mm/step]
1-907-009	Paper Feed Timing Adj.	Feed Solenoid OFF:Tray1:Plain	ENG*	[-20 to 20 / 0 / 1mm/step]
1-907-010	Paper Feed Timing Adj.	Feed Solenoid OFF:Tray1:Thick	ENG*	[-20 to 20 / 0 / 1mm/step]
1-907-011	Paper Feed Timing Adj.	Feed Solenoid OFF:Tray2:Plain	ENG*	[-20 to 20 / 0 / 1mm/step]
1-907-012	Paper Feed Timing Adj.	Feed Solenoid OFF:Tray2:Thick	ENG*	[-20 to 20 / 0 / 1mm/step]
1-	Paper Feed Timing	Feed Start:Tray1:Plain	ENG*	[-20 to 20 / 0 /

3.SP Mode Tables

SP No.	Large Category	Small Category	ENG or CTL	[Min to Max/Init./Step]
907-013	Adj.			1mm/step]
1-907-014	Paper Feed Timing Adj.	Feed Start:Tray1:Thick	ENG*	[-20 to 20 / 0 / 1mm/step]
1-907-015	Paper Feed Timing Adj.	Feed Start:Tray2:Plain	ENG*	[-20 to 20 / 0 / 1mm/step]
1-907-016	Paper Feed Timing Adj.	Feed Start:Tray2:Thick	ENG*	[-20 to 20 / 0 / 1mm/step]
1-907-017	Paper Feed Timing Adj.	Feed Re-Start:Tray1:Plain	ENG*	[-20 to 20 / 0 / 1mm/step]
1-907-018	Paper Feed Timing Adj.	Feed Re-Start:Tray1:Thick	ENG*	[-20 to 20 / 0 / 1mm/step]
1-907-019	Paper Feed Timing Adj.	Feed Re-Start:Tray2:Plain	ENG*	[-20 to 20 / 0 / 1mm/step]
1-907-020	Paper Feed Timing Adj.	Feed Re-Start:Tray2:Thick	ENG*	[-20 to 20 / 0 / 1mm/step]
1-907-021	Paper Feed Timing Adj.	Feed Re2-Start:Tray2:Plain	ENG*	[-20 to 20 / 0 / 1mm/step]
1-907-022	Paper Feed Timing Adj.	Feed Re2-Start:Tray2:Thick	ENG*	[-20 to 20 / 0 / 1mm/step]
1-907-023	Paper Feed Timing Adj.	Registration DCM OFF:Plain	ENG*	[-5.0 to 5.0 / 0.0 / 0.1mm/step]
1-907-024	Paper Feed Timing Adj.	Registration DCM OFF:Thick	ENG*	[-5.0 to 5.0 / 0.0 / 0.1mm/step]
1-	Paper Feed Timing	By-pass Solenoid ON:Low	ENG*	[0 to 40 / 0 /

3.SP Mode Tables

SP No.	Large Category	Small Category	ENG or CTL	[Min to Max/Init./Step]
907-025	Adj.			1mm/step]
1-907-026	Paper Feed Timing Adj.	By-pass Solenoid ON:Mid	ENG*	[0 to 40 / 0 / 1mm/step]
1-907-027	Paper Feed Timing Adj.	By-pass Solenoid ON:Std	ENG	[0 to 40 / 0 / 1mm/step]
1-907-028	Paper Feed Timing Adj.	By-pass Solenoid OFF	ENG*	[0 to 40 / 0 / 1mm/step]
1-907-029	Paper Feed Timing Adj.	By-pass Size Decision Timing	ENG*	[1 to 3 / 3 / 1/step]
1-907-030	Paper Feed Timing Adj.	Duplex DCM OFF:Low	ENG*	[-10 to 10 / 0 / 1mm/step]
1-907-031	Paper Feed Timing Adj.	Duplex DCM OFF:Mid	ENG*	[-10 to 10 / 0 / 1mm/step]
1-907-032	Paper Feed Timing Adj.	Duplex DCM OFF:Std	ENG	[-10 to 10 / 0 / 1mm/step]
1-907-033	Paper Feed Timing Adj.	ExitPaperJunction SOL ON:Low	ENG*	[-10 to 10 / 0 / 1mm/step]
1-907-034	Paper Feed Timing Adj.	ExitPaperJunction SOL ON:Mid	ENG*	[-10 to 10 / 0 / 1mm/step]
1-907-035	Paper Feed Timing Adj.	ExitPaperJunction SOL ON:Std	ENG	[-10 to 10 / 0 / 1mm/step]
1-907-036	Paper Feed Timing Adj.	ExitPaperJunction SOL OFF:Low	ENG*	[-10 to 10 / 0 / 1mm/step]
1-	Paper Feed Timing	ExitPaperJunction SOL OFF:Mid	ENG*	[-10 to 10 / 0 /

3.SP Mode Tables

SP No.	Large Category	Small Category	ENG or CTL	[Min to Max/Init./Step]
907-037	Adj.			1mm/step]
1-907-038	Paper Feed Timing Adj.	ExitPaperJunction SOL OFF:Std	ENG	[-10 to 10 / 0 / 1mm/step]
1-907-039	Paper Feed Timing Adj.	Reverse Position:Plain	ENG*	[-10 to 10 / 0 / 1mm/step]
1-907-040	Paper Feed Timing Adj.	Reverse Position:Thick	ENG*	[-10 to 10 / 0 / 1mm/step]
1-907-041	Paper Feed Timing Adj.	Duplex Enter Position:Plain	ENG	[-10 to 10 / 0 / 1mm/step]
1-907-042	Paper Feed Timing Adj.	Duplex Enter Position:Thick	ENG	[-10 to 10 / 0 / 1mm/step]
1-907-043	Paper Feed Timing Adj.	Duplex Re-Feed Position:Plain	ENG*	[-10 to 10 / 0 / 1mm/step]
1-907-044	Paper Feed Timing Adj.	Duplex Re-Feed Position:Thick	ENG*	[-10 to 10 / 0 / 1mm/step]
1-907-045	Paper Feed Timing Adj.	ExitM:Accelerate Position:Normal Speed	ENG	[-5 to 15 / 0 / 1mm/step]
1-907-046	Paper Feed Timing Adj.	ExitM:Accelerate Position:Middle Speed	ENG	[-5 to 15 / 0 / 1mm/step]
1-907-047	Paper Feed Timing Adj.	ExitM:Accelerate Position:Low Speed	ENG	[-5 to 15 / 0 / 1mm/step]
1-907-048	Paper Feed Timing Adj.	ExitM:Accelerate Position:Low:1200:Plain	ENG	[-5 to 15 / 0 / 1mm/step]
1-	Paper Feed Timing	Feed Solenoid ON:Tray3:Plain	ENG	[-20 to 20 / 0 /

3.SP Mode Tables

SP No.	Large Category	Small Category	ENG or CTL	[Min to Max/Init./Step]
907-061	Adj.			1mm/step]
1-907-062	Paper Feed Timing Adj.	Feed Solenoid ON:Tray3:Thick	ENG	[-20 to 20 / 0 / 1mm/step]
1-907-063	Paper Feed Timing Adj.	Feed Solenoid ON:Tray4:Plain	ENG	[-20 to 20 / 0 / 1mm/step]
1-907-064	Paper Feed Timing Adj.	Feed Solenoid ON:Tray4:Thick	ENG	[-20 to 20 / 0 / 1mm/step]
1-907-065	Paper Feed Timing Adj.	Feed Solenoid ON:Tray5(LCT):Plain	ENG	[-20 to 20 / 0 / 1mm/step]
1-907-066	Paper Feed Timing Adj.	Feed Solenoid ON:Tray5(LCT):Thick	ENG	[-20 to 20 / 0 / 1mm/step]
1-907-067	Paper Feed Timing Adj.	Feed DCM OFF:Tray3:Plain	ENG	[-20 to 20 / 0 / 1mm/step]
1-907-068	Paper Feed Timing Adj.	Feed DCM OFF:Tray3:Thick	ENG	[-20 to 20 / 0 / 1mm/step]
1-907-069	Paper Feed Timing Adj.	Feed DCM OFF:Tray4:Plain	ENG	[-20 to 20 / 0 / 1mm/step]
1-907-070	Paper Feed Timing Adj.	Feed DCM OFF:Tray4:Thick	ENG	[-20 to 20 / 0 / 1mm/step]
1-907-071	Paper Feed Timing Adj.	Feed DCM OFF:Tray5(LCT):Plain	ENG	[-20 to 20 / 0 / 1mm/step]
1-907-072	Paper Feed Timing Adj.	Feed DCM OFF:Tray5(LCT):Thick	ENG	[-20 to 20 / 0 / 1mm/step]
1-	Paper Feed Timing	Feed Solenoid OFF:Tray3:Plain	ENG	[-20 to 20 / 0 /

3.SP Mode Tables

SP No.	Large Category	Small Category	ENG or CTL	[Min to Max/Init./Step]
907-073	Adj.			1mm/step]
1-907-074	Paper Feed Timing Adj.	Feed Solenoid OFF:Tray3:Thick	ENG	[-20 to 20 / 0 / 1mm/step]
1-907-075	Paper Feed Timing Adj.	Feed Solenoid OFF:Tray4:Plain	ENG	[-20 to 20 / 0 / 1mm/step]
1-907-076	Paper Feed Timing Adj.	Feed Solenoid OFF:Tray4:Thick	ENG	[-20 to 20 / 0 / 1mm/step]
1-907-077	Paper Feed Timing Adj.	Feed Solenoid OFF:Tray5(LCT):Plain	ENG	[-20 to 20 / 0 / 1mm/step]
1-907-078	Paper Feed Timing Adj.	Feed Solenoid OFF:Tray5(LCT):Thick	ENG	[-20 to 20 / 0 / 1mm/step]
1-907-079	Paper Feed Timing Adj.	Feed Start:Tray3:Plain	ENG	[-20 to 20 / 0 / 1mm/step]
1-907-080	Paper Feed Timing Adj.	Feed Start:Tray3:Thick	ENG	[-20 to 20 / 0 / 1mm/step]
1-907-081	Paper Feed Timing Adj.	Feed Start:Tray4:Plain	ENG	[-20 to 20 / 0 / 1mm/step]
1-907-082	Paper Feed Timing Adj.	Feed Start:Tray4:Thick	ENG	[-20 to 20 / 0 / 1mm/step]
1-907-083	Paper Feed Timing Adj.	Feed Start:Tray5(LCT):Plain	ENG	[-20 to 20 / 0 / 1mm/step]
1-907-084	Paper Feed Timing Adj.	Feed Start:Tray5(LCT):Thick	ENG	[-20 to 20 / 0 / 1mm/step]
1-	Paper Feed Timing	ExitLineSpdUp EndPos:StdSpd	ENG*	[-30 to 15 / 0 /

3.SP Mode Tables

SP No.	Large Category	Small Category	ENG or CTL	[Min to Max/Init./Step]
907-085	Adj.			1mm/step]
1-907-086	Paper Feed Timing Adj.	ExitLineSpdUp EndPos:MidSpd	ENG*	[-30 to 15 / 0 / 1mm/step]
1-907-087	Paper Feed Timing Adj.	ExitLineSpdUp EndPos:LowSpd	ENG*	[-30 to 15 / 0 / 1mm/step]
1-907-088	Paper Feed Timing Adj.	ExitLineSpdUp EndPos:LowSpd:1200:Plain	ENG*	[-30 to 15 / 0 / 1mm/step]
1-907-090	Paper Feed Timing Adj.	Fusing Exit SOL ON: LowSpd	ENG*	[-15 to 15 / 0 / 1mm/step]
1-907-091	Paper Feed Timing Adj.	Fusing Exit SOL ON: MidSpd	ENG*	[-15 to 15 / 0 / 1mm/step]
1-907-092	Paper Feed Timing Adj.	Fusing Exit SOL ON: StdSpd	ENG*	[-15 to 15 / 0 / 1mm/step]
1-907-093	Paper Feed Timing Adj.	Fusing Exit SOL OFF: LowSpd	ENG*	[-15 to 15 / 0 / 1mm/step]
1-907-094	Paper Feed Timing Adj.	Fusing Exit SOL OFF: MidSpd	ENG*	[-15 to 15 / 0 / 1mm/step]
1-907-095	Paper Feed Timing Adj.	Fusing Exit SOL OFF: StdSpd	ENG*	[-15 to 15 / 0 / 1mm/step]
1-907-096	Operation Setting	Fusing Exit SOL Setting	ENG*	[0 to 6 / 0 / 1/step]
1-907-097	Paper Feed Timing Adj.	Feed Re-Start:Tray3:Plain	ENG*	[-20 to 20 / 0 / 1mm/step]
1-	Paper Feed Timing	Feed Re-Start:Tray3:Thick	ENG*	[-20 to 20 / 0 /

3.SP Mode Tables

SP No.	Large Category	Small Category	ENG or CTL	[Min to Max/Init./Step]
907-098	Adj.			1mm/step]
1-907-099	Paper Feed Timing Adj.	Feed Re-Start:Tray4:Plain	ENG*	[-20 to 20 / 0 / 1mm/step]
1-907-100	Paper Feed Timing Adj.	Feed Re-Start:Tray4:Thick	ENG*	[-20 to 20 / 0 / 1mm/step]
1-907-101	Paper Feed Timing Adj.	Feed Re-Start:Tray5(LCT):Plain	ENG*	[-20 to 20 / 0 / 1mm/step]
1-907-102	Paper Feed Timing Adj.	Feed Re-Start:Tray5(LCT):Thick	ENG*	[-20 to 20 / 0 / 1mm/step]
1-907-103	Paper Feed Timing Adj.	Feed Re2-Start:Tray3:Plain	ENG*	[-20 to 20 / 0 / 1mm/step]
1-907-104	Paper Feed Timing Adj.	Feed Re2-Start:Tray3:Thick	ENG*	[-20 to 20 / 0 / 1mm/step]
1-907-105	Paper Feed Timing Adj.	Feed Re2-Start:Tray4:Plain	ENG*	[-20 to 20 / 0 / 1mm/step]
1-907-106	Paper Feed Timing Adj.	Feed Re2-Start:Tray4:Thick	ENG*	[-20 to 20 / 0 / 1mm/step]
1-907-107	Paper Feed Timing Adj.	Feed Re2-Start:Tray5(LCT):Plain	ENG*	[-20 to 20 / 0 / 1mm/step]
1-907-108	Paper Feed Timing Adj.	Feed Re2-Start:Tray5(LCT):Thick	ENG*	[-20 to 20 / 0 / 1mm/step]
1-907-109	Paper Feed Timing Adj.	Manual Feed Regist. Stop Timing: Env	ENG	[0 to 40 / 0 / 1mm/step]
1-	Paper Feed Length	History:Last	ENG	[-99 to 99 / 0 /

3.SP Mode Tables

SP No.	Large Category	Small Category	ENG or CTL	[Min to Max/Init./Step]
908-001				1mm/step]
1-908-002	Paper Feed Length	History:Last 2	ENG	[-99 to 99 / 0 / 1mm/step]
1-908-003	Paper Feed Length	History:Last 3	ENG	[-99 to 99 / 0 / 1mm/step]
1-908-004	Paper Feed Length	History:Last 4	ENG	[-99 to 99 / 0 / 1mm/step]
1-908-005	Paper Feed Length	History:Last 5	ENG	[-99 to 99 / 0 / 1mm/step]
1-908-006	Paper Feed Length	History:Last 6	ENG	[-99 to 99 / 0 / 1mm/step]
1-908-007	Paper Feed Length	History:Last 7	ENG	[-99 to 99 / 0 / 1mm/step]
1-908-008	Paper Feed Length	History:Last 8	ENG	[-99 to 99 / 0 / 1mm/step]
1-908-009	Paper Feed Length	History:Last 9	ENG	[-99 to 99 / 0 / 1mm/step]
1-908-010	Paper Feed Length	History:Last 10	ENG	[-99 to 99 / 0 / 1mm/step]
1-909-001	Regist Jam Margin Adjust	Tray	ENG*	[-22 to 0 / 0 / 1mm/step]
1-909-002	Regist Jam Margin Adjust	By-Pass	ENG*	[-43 to 0 / 0 / 1mm/step]
1-	Regist Jam Margin	Duplex	ENG*	[-24 to -6 / -6 /

3.SP Mode Tables

SP No.	Large Category	Small Category	ENG or CTL	[Min to Max/Init./Step]
909-003	Adjust			1mm/step]
1-950-003	Fan Cooling Time Set	Dev Cooling Fan	ENG*	[0 to 120 / 0 / 1min/step]
1-950-005	Fan Cooling Time Set	Ozone Fan	ENG*	[0 to 120 / 0 / 1min/step]
1-950-006	Fan Cooling Time Set	Fusing Fan	ENG*	[0 to 120 / 0 / 1min/step]
1-950-007	Fan Cooling Time Set	Paper Exit Cooling Fan	ENG*	[0 to 120 / 0 / 1min/step]
1-950-011	Fan Cooling Time Set	PSU Cooling Fan	ENG*	[0 to 120 / 0 / 1min/step]
1-950-051	Fan Cooling Time Set	Dev Suction Fan: Right	ENG*	[0 to 120 / 0 / 1min/step]
1-950-061	Extra Fan Op Decision time	Fusing Fan	ENG*	[0 to 10000 / 480 / 1sec/step]
1-950-062	Extra Fan Op Decision time	Paper Exit Cooling Fan	ENG*	[0 to 10000 / 480 / 1sec/step]
1-950-071	Extra Fan Cooling Time Set	Fusing Fan	ENG*	[0 to 900 / 120 / 1sec/step]
1-950-072	Extra Fan Cooling Time Set	Paper Exit Cooling Fan	ENG*	[0 to 900 / 120 / 1sec/step]
1-951-003	Fan Start Time Set	Dev Cooling Fan	ENG*	[0 to 900 / 120 / 1sec/step]
1-	Fan Start Time Set	Ozone Fan	ENG*	[0 to 900 / 0 /

3.SP Mode Tables

SP No.	Large Category	Small Category	ENG or CTL	[Min to Max/Init./Step]
951-005				1sec/step]
1-951-006	Fan Start Time Set	Fusing Fan	ENG*	[0 to 900 / 120 / 1sec/step]
1-951-007	Fan Start Time Set	Paper Exit Cooling Fan	ENG*	[0 to 900 / 120 / 1sec/step]
1-951-011	Fan Start Time Set	PSU Cooling Fan	ENG*	[0 to 900 / 120 / 1sec/step]
1-951-051	Fan Start Time Set	Dev Suction Fan: Right	ENG*	[0 to 900 / 0 / 1sec/step]
1-952-001	Fan Control Off Mode Time Set		ENG*	[0 to 60 / 10 / 1min/step]
1-953-001	Extra Fan Control	Extra Fan Cooling State	ENG	[0 to 1 / 0 / 1/step]
1-953-002	Extra Fan Control	Execution Temp. Threshold	ENG*	[0.0 to 100.0 / 39.0 / 0.1deg/step]
1-953-003	Extra Fan Control	Cancellation Temp. Threshold	ENG*	[0.0 to 100.0 / 2.0 / 0.1deg/step]
1-953-004	Extra Fan Control	Extra Fan Operation ON/OFF Setting	ENG*	[0 to 1 / 1 / 1/step]
1-955-002	Fan Control	Fusing Fan Low Speed Op DUTY	ENG*	[40 to 75 / 64 / 1%/step]
1-955-003	Fan Control	Fusing Fan High Speed Op DUTY	ENG*	[40 to 100 / 100 / 1%/step]
1-	Fan Control	Dev Cooling Fan Op Sw Temp	ENG*	[0.0 to 100.0 / 33.0

3.SP Mode Tables

SP No.	Large Category	Small Category	ENG or CTL	[Min to Max/Init./Step]
955-004				/ 0.1deg/step]
1-955-006	Fan Control	Paper Exit Cooling Fan Op Sw Temp	ENG*	[0.0 to 100.0 / 12.0 / 0.1deg/step]
1-955-007	Fan Control	Fusing Fan Op Sw Temp	ENG*	[0.0 to 100.0 / 0.0 / 0.1deg/step]
1-955-009	Fan Control	Ozone Fan Low Speed Op Sw Temp	ENG*	[0.0 to 100.0 / 27.5 / 0.1deg/step]
1-955-010	Fan Control	Ozone Fan Middle Speed Op Sw Temp	ENG*	[0.0 to 100.0 / 33.0 / 0.1deg/step]
1-955-011	Fan Control	Ozone Fan High Speed Op Sw Temp	ENG*	[0.0 to 100.0 / 40.0 / 0.1deg/step]
1-955-012	Fan Control	Ozone Fan Low Noise Op DUTY	ENG*	[0 to 100 / 50 / 1%/step]
1-955-013	Fan Control	Ozone Fan Low Speed Op DUTY	ENG*	[0 to 100 / 75 / 1%/step]
1-955-014	Fan Control	Ozone Fan Middle Speed Op DUTY	ENG*	[0 to 100 / 100 / 1%/step]
1-955-015	Fan Control	Ozone Fan High Speed Op DUTY	ENG*	[0 to 100 / 100 / 1%/step]
1-955-016	Fan Control	Paper Exit Cooling Fan Op Start Time A	ENG*	[0 to 900 / 300 / 1sec/step]
1-955-017	Fan Control	PSU Cooling Fan Op Start Time A	ENG*	IM C6000: TWN: [0 to 900 / 120 / 1sec/step] NA: [0 to 900 / 120 / 1sec/step]

3.SP Mode Tables

SP No.	Large Category	Small Category	ENG or CTL	[Min to Max/Init./Step]
				KOR: [0 to 900 / 40 / 1sec/step] EU: [0 to 900 / 40 / 1sec/step] CHN: [0 to 900 / 40 / 1sec/step] AS: [0 to 900 / 40 / 1sec/step] IM C5500: TWN: [0 to 900 / 120 / 1sec/step] NA: [0 to 900 / 120 / 1sec/step] KOR: [0 to 900 / 40 / 1sec/step] EU: [0 to 900 / 40 / 1sec/step] CHN: [0 to 900 / 40 / 1sec/step] AS: [0 to 900 / 40 / 1sec/step] IM C4500: TWN: [0 to 900 / 120 / 1sec/step] NA: [0 to 900 / 120 / 1sec/step] KOR: [0 to 900 / 40 / 1sec/step] EU: [0 to 900 / 40 / 1sec/step] CHN: [0 to 900 / 40 / 1sec/step] AS: [0 to 900 / 40 / 1sec/step]
1-955-018	Fan Control	Fan Op Sw Temp Thers	ENG*	[0.0 to 100.0 / 2.0 / 0.1deg/step]

3.SP Mode Tables

SP No.	Large Category	Small Category	ENG or CTL	[Min to Max/Init./Step]
1-955-019	Fan Control	Paper Exit Cooling Fan Control Off Mode Time	ENG*	[0 to 3600 / 600 / 1sec/step]
1-955-020	Fan Control	PSU Cooling Fan Control Off Mode Time	ENG*	[0 to 3600 / 600 / 1sec/step]
1-955-051	Fan Control	Dev Suction Fan: Right Op Sw Temp	ENG*	[0.0 to 100.0 / 33.0 / 0.1deg/step]
1-955-052	Fan Control	Dev Suction Fan: Right Low Speed Op DUTY	ENG*	[40 to 75 / 55 / 1%/step]
1-955-053	Fan Control	Dev Suction Fan: Right High Speed Op DUTY	ENG*	[40 to 100 / 100 / 1%/step]
1-955-062	Fan Control	Dev Suction Fan: Right Op Start Time	ENG*	[0 to 900 / 300 / 1sec/step]
1-955-063	Fan Control	Paper Exit Cooling Fan Op Start Time B	ENG*	[0 to 900 / 300 / 1sec/step]
1-955-064	Fan Control	PSU Cooling Fan Op Start Time B	ENG*	IM C6000: TWN: [0 to 900 / 120 / 1sec/step] NA: [0 to 900 / 120 / 1sec/step] KOR: [0 to 900 / 40 / 1sec/step] EU: [0 to 900 / 40 / 1sec/step] CHN: [0 to 900 / 40 / 1sec/step] AS: [0 to 900 / 40 / 1sec/step] IM C5500: TWN: [0 to 900 / 120 / 1sec/step]

3.SP Mode Tables

SP No.	Large Category	Small Category	ENG or CTL	[Min to Max/Init./Step]
				NA: [0 to 900 / 120 / 1sec/step] KOR: [0 to 900 / 40 / 1sec/step] EU: [0 to 900 / 40 / 1sec/step] CHN: [0 to 900 / 40 / 1sec/step] AS: [0 to 900 / 40 / 1sec/step] IM C4500: TWN: [0 to 900 / 120 / 1sec/step] NA: [0 to 900 / 120 / 1sec/step] KOR: [0 to 900 / 40 / 1sec/step] EU: [0 to 900 / 40 / 1sec/step] CHN: [0 to 900 / 40 / 1sec/step] AS: [0 to 900 / 40 / 1sec/step]
1-955-065	Fan Control	PSU Cooling Fan Op Start Time C	ENG*	[0 to 900 / 0 / 1sec/step]
1-955-066	Fan Control	PSU Cooling Fan Op Start Time D	ENG*	[0 to 900 / 0 / 1sec/step]
1-955-071	Fan Control	Ozone Fan Extra Op DUTY	ENG*	[0 to 100 / 50 / 1%/step]
1-955-080	Fan Control	Paper Exit Cooling Fan Low Speed Op Time A	ENG*	[0 to 900 / 0 / 1sec/step]
1-955-	Fan Control	PSU Cooling Fan Low Speed Op Time A	ENG*	IM C6000: TWN: [0 to 900 /

3.SP Mode Tables

SP No.	Large Category	Small Category	ENG or CTL	[Min to Max/Init./Step]
081				180 / 1sec/step NA: [0 to 900 / 180 / 1sec/step] KOR: [0 to 900 / 260 / 1sec/step] EU: [0 to 900 / 260 / 1sec/step] CHN: [0 to 900 / 260 / 1sec/step] AS: [0 to 900 / 260 / 1sec/step] IM C5500: TWN: [0 to 900 / 180 / 1sec/step] NA: [0 to 900 / 180 / 1sec/step] KOR: [0 to 900 / 260 / 1sec/step] EU: [0 to 900 / 260 / 1sec/step] CHN: [0 to 900 / 260 / 1sec/step] AS: [0 to 900 / 260 / 1sec/step] IM C4500: TWN: [0 to 900 / 180 / 1sec/step] NA: [0 to 900 / 180 / 1sec/step] KOR: [0 to 900 / 260 / 1sec/step] EU: [0 to 900 / 260 / 1sec/step] CHN: [0 to 900 / 260 / 1sec/step] AS: [0 to 900 / 260 / 1sec/step]

3.SP Mode Tables

SP No.	Large Category	Small Category	ENG or CTL	[Min to Max/Init./Step]
1-955-082	Fan Control	Paper Exit Cooling Fan Low Speed Op Time B	ENG*	[0 to 900 / 0 / 1sec/step]
1-955-083	Fan Control	PSU Cooling Fan Low Speed Op Time B	ENG*	IM C6000: TWN: [0 to 900 / 180 / 1sec/step] NA: [0 to 900 / 180 / 1sec/step] KOR: [0 to 900 / 260 / 1sec/step] EU: [0 to 900 / 260 / 1sec/step] CHN: [0 to 900 / 260 / 1sec/step] AS: [0 to 900 / 260 / 1sec/step] IM C5500: TWN: [0 to 900 / 180 / 1sec/step] NA: [0 to 900 / 180 / 1sec/step] KOR: [0 to 900 / 260 / 1sec/step] EU: [0 to 900 / 260 / 1sec/step] CHN: [0 to 900 / 260 / 1sec/step] AS: [0 to 900 / 260 / 1sec/step] IM C4500: TWN: [0 to 900 / 180 / 1sec/step] NA: [0 to 900 / 180 / 1sec/step] KOR: [0 to 900 / 260 / 1sec/step] EU: [0 to 900 / 260 / 1sec/step]

3.SP Mode Tables

SP No.	Large Category	Small Category	ENG or CTL	[Min to Max/Init./Step]
				/ 1sec/step] CHN: [0 to 900 / 260 / 1sec/step] AS: [0 to 900 / 260 / 1sec/step]
1-955-084	Fan Control	PSU Cooling Fan Low Speed Op Time C	ENG*	[0 to 900 / 0 / 1sec/step]
1-955-085	Fan Control	PSU Cooling Fan Low Speed Op Time D	ENG*	[0 to 900 / 0 / 1sec/step]
1-955-086	Fan Control	Paper Exit Cooling Fan Low Speed Op Time E	ENG*	[0 to 900 / 0 / 1sec/step]
1-955-087	Fan Control	PSU Cooling Fan Low Speed Op Time E	ENG*	[0 to 900 / 0 / 1sec/step]
1-955-090	Fan Control	Paper Exit Cooling Fan Low Speed Op DUTY	ENG*	[40 to 75 / 46 / 1%/step]
1-955-091	Fan Control	PSU Cooling Fan Low Speed Op DUTY	ENG*	[40 to 75 / 46 / 1%/step]
1-955-092	Fan Control	Paper Exit Cooling Fan High Speed Op DUTY	ENG*	[40 to 100 / 100 / 1%/step]
1-955-093	Fan Control	PSU Cooling Fan High Speed Op DUTY	ENG*	[40 to 100 / 100 / 1%/step]

Engine SP Tables-2

SP2-XXX (Drum)-1

SP No.	Large Category	Small Category	ENG or CTL	[Min to Max/Init./Step]
2-	Charge DC Voltage: Fixed	Standard Speed: K	ENG*	[0 to 2000 / 690

3.SP Mode Tables

SP No.	Large Category	Small Category	ENG or CTL	[Min to Max/Init./Step]
005-001				/ 10-V/step]
2-005-002	Charge DC Voltage: Fixed	Standard Speed: C	ENG*	[0 to 2000 / 690 / 10-V/step]
2-005-003	Charge DC Voltage: Fixed	Standard Speed: M	ENG*	[0 to 2000 / 690 / 10-V/step]
2-005-004	Charge DC Voltage: Fixed	Standard Speed: Y	ENG*	[0 to 2000 / 690 / 10-V/step]
2-005-005	Charge DC Voltage: Fixed	Middle Speed: K	ENG*	[0 to 2000 / 690 / 10-V/step]
2-005-006	Charge DC Voltage: Fixed	Middle Speed: C	ENG*	[0 to 2000 / 690 / 10-V/step]
2-005-007	Charge DC Voltage: Fixed	Middle Speed: M	ENG*	[0 to 2000 / 690 / 10-V/step]
2-005-008	Charge DC Voltage: Fixed	Middle Speed: Y	ENG*	[0 to 2000 / 690 / 10-V/step]
2-005-009	Charge DC Voltage: Fixed	Low Speed: K	ENG*	[0 to 2000 / 690 / 10-V/step]
2-005-010	Charge DC Voltage: Fixed	Low Speed: C	ENG*	[0 to 2000 / 690 / 10-V/step]
2-005-011	Charge DC Voltage: Fixed	Low Speed: M	ENG*	[0 to 2000 / 690 / 10-V/step]
2-005-012	Charge DC Voltage: Fixed	Low Speed: Y	ENG*	[0 to 2000 / 690 / 10-V/step]

3.SP Mode Tables

SP No.	Large Category	Small Category	ENG or CTL	[Min to Max/Init./Step]
2-005-013	Charge DC Voltage: Correction	PCU: Standard Speed	ENG*	[-100 to 100 / 0 / 1-V/step]
2-005-014	Charge DC Voltage: Correction	PCU: Middle Speed	ENG*	[-100 to 100 / 0 / 1-V/step]
2-005-015	Charge DC Voltage: Correction	PCU: Low Speed	ENG*	[-100 to 100 / 0 / 1-V/step]
2-005-018	Charge DC Voltage: Correction	Correction Coefficient a: K	ENG*	[0.000 to 2.000 / 1.000 / 0.001-/step]
2-005-019	Charge DC Voltage: Correction	Correction Coefficient a: C	ENG*	[0.000 to 2.000 / 1.000 / 0.001-/step]
2-005-020	Charge DC Voltage: Correction	Correction Coefficient a: M	ENG*	[0.000 to 2.000 / 1.000 / 0.001-/step]
2-005-021	Charge DC Voltage: Correction	Correction Coefficient a: Y	ENG*	[0.000 to 2.000 / 1.000 / 0.001-/step]
2-005-022	Charge DC Voltage: Correction	Correction Coefficient b: K	ENG*	[0 to 2000 / 20 / 1-V/step]
2-005-023	Charge DC Voltage: Correction	Correction Coefficient b: C	ENG*	[0 to 2000 / 20 / 1-V/step]
2-005-024	Charge DC Voltage: Correction	Correction Coefficient b: M	ENG*	[0 to 2000 / 20 / 1-V/step]
2-005-025	Charge DC Voltage: Correction	Correction Coefficient b: Y	ENG*	[0 to 2000 / 20 / 1-V/step]
2-005-026	Charge DC Voltage: Correction	Correction Coefficient c: K	ENG*	[0 to 100 / 0 / 1-V/step]

3.SP Mode Tables

SP No.	Large Category	Small Category	ENG or CTL	[Min to Max/Init./Step]
2-005-027	Charge DC Voltage: Correction	Correction Coefficient c: C	ENG*	[0 to 100 / 0 / 1-V/step]
2-005-028	Charge DC Voltage: Correction	Correction Coefficient c: M	ENG*	[0 to 100 / 0 / 1-V/step]
2-005-029	Charge DC Voltage: Correction	Correction Coefficient c: Y	ENG*	[0 to 100 / 0 / 1-V/step]
2-005-030	Charge DC Voltage: Correction	Temperature Threshold L: K	ENG*	[0 to 99 / 15 / 1deg/step]
2-005-031	Charge DC Voltage: Correction	Temperature Threshold L: C	ENG*	[0 to 99 / 15 / 1deg/step]
2-005-032	Charge DC Voltage: Correction	Temperature Threshold L: M	ENG*	[0 to 99 / 16 / 1deg/step]
2-005-033	Charge DC Voltage: Correction	Temperature Threshold L: Y	ENG*	[0 to 99 / 16 / 1deg/step]
2-005-034	Charge DC Voltage: Correction	Temperature Threshold M: K	ENG*	[0 to 99 / 22 / 1deg/step]
2-005-035	Charge DC Voltage: Correction	Temperature Threshold M: C	ENG*	[0 to 99 / 22 / 1deg/step]
2-005-036	Charge DC Voltage: Correction	Temperature Threshold M: M	ENG*	[0 to 99 / 23 / 1deg/step]
2-005-037	Charge DC Voltage: Correction	Temperature Threshold M: Y	ENG*	[0 to 99 / 23 / 1deg/step]
2-005-038	Charge DC Voltage: Correction	Temperature Threshold H: K	ENG*	[0 to 99 / 28 / 1deg/step]

3.SP Mode Tables

SP No.	Large Category	Small Category	ENG or CTL	[Min to Max/Init./Step]
2-005-039	Charge DC Voltage: Correction	Temperature Threshold H: C	ENG*	[0 to 99 / 28 / 1deg/step]
2-005-040	Charge DC Voltage: Correction	Temperature Threshold H: M	ENG*	[0 to 99 / 29 / 1deg/step]
2-005-041	Charge DC Voltage: Correction	Temperature Threshold H: Y	ENG*	[0 to 99 / 29 / 1deg/step]
2-005-043	Charge DC Voltage: Correction	DC Bias Fixed Value Set	ENG*	[0 to 1 / 0 / 1- /step]
2-005-044	Charge DC Voltage: Correction	Correction Coefficient a: Fixed K	ENG*	[0.000 to 2.000 / 1.000 / 0.001- /step]
2-005-045	Charge DC Voltage: Correction	Correction Coefficient a: Fixed C	ENG*	[0.000 to 2.000 / 1.000 / 0.001- /step]
2-005-046	Charge DC Voltage: Correction	Correction Coefficient a: Fixed M	ENG*	[0.000 to 2.000 / 1.000 / 0.001- /step]
2-005-047	Charge DC Voltage: Correction	Correction Coefficient a: Fixed Y	ENG*	[0.000 to 2.000 / 1.000 / 0.001- /step]
2-005-048	Charge DC Voltage: Correction	Correction Coefficient b: Fixed K	ENG*	[0 to 2000 / 20 / 1-V/step]
2-005-049	Charge DC Voltage: Correction	Correction Coefficient b: Fixed C	ENG*	[0 to 2000 / 20 / 1-V/step]
2-005-050	Charge DC Voltage: Correction	Correction Coefficient b: Fixed M	ENG*	[0 to 2000 / 20 / 1-V/step]
2-005-051	Charge DC Voltage: Correction	Correction Coefficient b: Fixed Y	ENG*	[0 to 2000 / 20 / 1-V/step]

3.SP Mode Tables

SP No.	Large Category	Small Category	ENG or CTL	[Min to Max/Init./Step]
2-005-052	Charge DC Voltage: Correction	Correction Coefficient c: Fixed K	ENG*	[0 to 100 / 0 / 1-V/step]
2-005-053	Charge DC Voltage: Correction	Correction Coefficient c: Fixed C	ENG*	[0 to 100 / 0 / 1-V/step]
2-005-054	Charge DC Voltage: Correction	Correction Coefficient c: Fixed M	ENG*	[0 to 100 / 0 / 1-V/step]
2-005-055	Charge DC Voltage: Correction	Correction Coefficient c: Fixed Y	ENG*	[0 to 100 / 0 / 1-V/step]
2-005-089	Charge DC Voltage: Correction	Correction Coefficient Cd	ENG*	[-125 to 125 / 0 / 1-V/step]
2-005-090	Charge DC Voltage: Correction	Correction Coefficient Ce	ENG*	[-125 to 125 / 0 / 1-V/step]
2-005-091	Charge DC Voltage: Correction	Correction Coefficient Cf	ENG*	[-125 to 125 / 0 / 1-V/step]
2-005-092	Charge DC Voltage: Correction	Correction Coefficient Cg	ENG*	[-125 to 125 / 0 / 1-V/step]
2-005-093	Charge DC Voltage: Correction	Correction Coefficient Ch	ENG*	[-125 to 125 / 0 / 1-V/step]
2-005-094	Charge DC Voltage: Correction	Correction Coefficient Ci	ENG*	[-125 to 125 / 0 / 1-V/step]
2-005-095	Charge DC Voltage: Correction	Correction Coefficient Cj	ENG*	[-125 to 125 / 0 / 1-V/step]
2-005-096	Charge DC Voltage: Correction	Correction Coefficient Ck	ENG*	[-125 to 125 / 0 / 1-V/step]

3.SP Mode Tables

SP No.	Large Category	Small Category	ENG or CTL	[Min to Max/Init./Step]
2-005-097	Charge DC Voltage: Correction	Correction Coefficient Ci	ENG*	[-125 to 125 / 0 / 1-V/step]
2-005-098	Charge DC Voltage: Correction	Correction Coefficient Cm	ENG*	[-125 to 125 / 0 / 1-V/step]
2-005-099	Charge DC Voltage: Correction	Correction Coefficient Cn	ENG*	[-125 to 125 / 0 / 1-V/step]
2-005-100	Charge DC Voltage: Correction	Correction Coefficient Co	ENG*	[-125 to 125 / 0 / 1-V/step]
2-005-101	Charge DC Voltage: Correction	Correction Coefficient Cp	ENG*	[-125 to 125 / 0 / 1-V/step]
2-005-102	Charge DC Voltage: Correction	Correction Coefficient Cq	ENG*	[-125 to 125 / 0 / 1-V/step]
2-005-103	Charge DC Voltage: Correction	Correction Coefficient Cr	ENG*	[-125 to 125 / 0 / 1-V/step]
2-005-104	Charge DC Voltage: Correction	Correction Coefficient Cs	ENG*	[-125 to 125 / 0 / 1-V/step]
2-005-105	Charge DC Voltage: Correction	Correction Coefficient Ct	ENG*	[-125 to 125 / 0 / 1-V/step]
2-005-106	Charge DC Voltage: Correction	Correction Coefficient Cu	ENG*	[-125 to 125 / 0 / 1-V/step]
2-005-107	Charge DC Voltage: Correction	Correction Coefficient Cv	ENG*	[-125 to 125 / 0 / 1-V/step]
2-005-108	Charge DC Voltage: Correction	Correction Coefficient Cw	ENG*	[-125 to 125 / 0 / 1-V/step]

3.SP Mode Tables

SP No.	Large Category	Small Category	ENG or CTL	[Min to Max/Init./Step]
2-005-109	Charge DC Voltage: Correction	Correction Coefficient Cx	ENG*	[-125 to 125 / 0 / 1-V/step]
2-005-110	Charge DC Voltage: Correction	Correction Coefficient Cy	ENG*	[-125 to 125 / 0 / 1-V/step]
2-005-111	Charge DC Voltage: Correction	Correction Coefficient Cz	ENG*	[-125 to 125 / 0 / 1-V/step]
2-005-112	Charge DC Voltage: Correction	Correction Coefficient CAA	ENG*	[-125 to 125 / 0 / 1-V/step]
2-005-113	Charge DC Voltage: Correction	Correction Coefficient CAB	ENG*	[-125 to 125 / 0 / 1-V/step]
2-005-114	Charge DC Voltage: Correction	Correction Coefficient Md	ENG*	[-125 to 125 / 0 / 1-V/step]
2-005-115	Charge DC Voltage: Correction	Correction Coefficient Me	ENG*	[-125 to 125 / 0 / 1-V/step]
2-005-116	Charge DC Voltage: Correction	Correction Coefficient Mf	ENG*	[-125 to 125 / 0 / 1-V/step]
2-005-117	Charge DC Voltage: Correction	Correction Coefficient Mg	ENG*	[-125 to 125 / 0 / 1-V/step]
2-005-118	Charge DC Voltage: Correction	Correction Coefficient Mh	ENG*	[-125 to 125 / 0 / 1-V/step]
2-005-119	Charge DC Voltage: Correction	Correction Coefficient Mi	ENG*	[-125 to 125 / 0 / 1-V/step]
2-005-120	Charge DC Voltage: Correction	Correction Coefficient Mj	ENG*	[-125 to 125 / 0 / 1-V/step]

3.SP Mode Tables

SP No.	Large Category	Small Category	ENG or CTL	[Min to Max/Init./Step]
2-005-121	Charge DC Voltage: Correction	Correction Coefficient Mk	ENG*	[-125 to 125 / 0 / 1-V/step]
2-005-122	Charge DC Voltage: Correction	Correction Coefficient Ml	ENG*	[-125 to 125 / 0 / 1-V/step]
2-005-123	Charge DC Voltage: Correction	Correction Coefficient Mm	ENG*	[-125 to 125 / 0 / 1-V/step]
2-005-124	Charge DC Voltage: Correction	Correction Coefficient Mn	ENG*	[-125 to 125 / 0 / 1-V/step]
2-005-125	Charge DC Voltage: Correction	Correction Coefficient Mo	ENG*	[-125 to 125 / 0 / 1-V/step]
2-005-126	Charge DC Voltage: Correction	Correction Coefficient Mp	ENG*	[-125 to 125 / 0 / 1-V/step]
2-005-127	Charge DC Voltage: Correction	Correction Coefficient Mq	ENG*	[-125 to 125 / 0 / 1-V/step]
2-005-128	Charge DC Voltage: Correction	Correction Coefficient Mr	ENG*	[-125 to 125 / 0 / 1-V/step]
2-005-129	Charge DC Voltage: Correction	Correction Coefficient Ms	ENG*	[-125 to 125 / 0 / 1-V/step]
2-005-130	Charge DC Voltage: Correction	Correction Coefficient Mt	ENG*	[-125 to 125 / 0 / 1-V/step]
2-005-131	Charge DC Voltage: Correction	Correction Coefficient Mu	ENG*	[-125 to 125 / 0 / 1-V/step]
2-005-132	Charge DC Voltage: Correction	Correction Coefficient Mv	ENG*	[-125 to 125 / 0 / 1-V/step]

3.SP Mode Tables

SP No.	Large Category	Small Category	ENG or CTL	[Min to Max/Init./Step]
2-005-133	Charge DC Voltage: Correction	Correction Coefficient Mw	ENG*	[-125 to 125 / 0 / 1-V/step]
2-005-134	Charge DC Voltage: Correction	Correction Coefficient Mx	ENG*	[-125 to 125 / 0 / 1-V/step]
2-005-135	Charge DC Voltage: Correction	Correction Coefficient My	ENG*	[-125 to 125 / 0 / 1-V/step]
2-005-136	Charge DC Voltage: Correction	Correction Coefficient Mz	ENG*	[-125 to 125 / 0 / 1-V/step]
2-005-137	Charge DC Voltage: Correction	Correction Coefficient MAA	ENG*	[-125 to 125 / 0 / 1-V/step]
2-005-138	Charge DC Voltage: Correction	Correction Coefficient MAB	ENG*	[-125 to 125 / 0 / 1-V/step]
2-005-139	Charge DC Voltage: Correction	Correction Coefficient Yd	ENG*	[-125 to 125 / 0 / 1-V/step]
2-005-140	Charge DC Voltage: Correction	Correction Coefficient Ye	ENG*	[-125 to 125 / 0 / 1-V/step]
2-005-141	Charge DC Voltage: Correction	Correction Coefficient Yf	ENG*	[-125 to 125 / 0 / 1-V/step]
2-005-142	Charge DC Voltage: Correction	Correction Coefficient Yg	ENG*	[-125 to 125 / 0 / 1-V/step]
2-005-143	Charge DC Voltage: Correction	Correction Coefficient Yh	ENG*	[-125 to 125 / 0 / 1-V/step]
2-005-144	Charge DC Voltage: Correction	Correction Coefficient Yi	ENG*	[-125 to 125 / 0 / 1-V/step]

3.SP Mode Tables

SP No.	Large Category	Small Category	ENG or CTL	[Min to Max/Init./Step]
2-005-145	Charge DC Voltage: Correction	Correction Coefficient Yj	ENG*	[-125 to 125 / 0 / 1-V/step]
2-005-146	Charge DC Voltage: Correction	Correction Coefficient Yk	ENG*	[-125 to 125 / 0 / 1-V/step]
2-005-147	Charge DC Voltage: Correction	Correction Coefficient Yl	ENG*	[-125 to 125 / 0 / 1-V/step]
2-005-148	Charge DC Voltage: Correction	Correction Coefficient Ym	ENG*	[-125 to 125 / 0 / 1-V/step]
2-005-149	Charge DC Voltage: Correction	Correction Coefficient Yn	ENG*	[-125 to 125 / 0 / 1-V/step]
2-005-150	Charge DC Voltage: Correction	Correction Coefficient Yo	ENG*	[-125 to 125 / 0 / 1-V/step]
2-005-151	Charge DC Voltage: Correction	Correction Coefficient Yp	ENG*	[-125 to 125 / 0 / 1-V/step]
2-005-152	Charge DC Voltage: Correction	Correction Coefficient Yq	ENG*	[-125 to 125 / 0 / 1-V/step]
2-005-153	Charge DC Voltage: Correction	Correction Coefficient Yr	ENG*	[-125 to 125 / 0 / 1-V/step]
2-005-154	Charge DC Voltage: Correction	Correction Coefficient Ys	ENG*	[-125 to 125 / 0 / 1-V/step]
2-005-155	Charge DC Voltage: Correction	Correction Coefficient Yt	ENG*	[-125 to 125 / 0 / 1-V/step]
2-005-156	Charge DC Voltage: Correction	Correction Coefficient Yu	ENG*	[-125 to 125 / 0 / 1-V/step]

3.SP Mode Tables

SP No.	Large Category	Small Category	ENG or CTL	[Min to Max/Init./Step]
2-005-157	Charge DC Voltage: Correction	Correction Coefficient Yv	ENG*	[-125 to 125 / 0 / 1-V/step]
2-005-158	Charge DC Voltage: Correction	Correction Coefficient Yw	ENG*	[-125 to 125 / 0 / 1-V/step]
2-005-159	Charge DC Voltage: Correction	Correction Coefficient Yx	ENG*	[-125 to 125 / 0 / 1-V/step]
2-005-160	Charge DC Voltage: Correction	Correction Coefficient Yy	ENG*	[-125 to 125 / 0 / 1-V/step]
2-005-161	Charge DC Voltage: Correction	Correction Coefficient Yz	ENG*	[-125 to 125 / 0 / 1-V/step]
2-005-162	Charge DC Voltage: Correction	Correction Coefficient YAA	ENG*	[-125 to 125 / 0 / 1-V/step]
2-005-163	Charge DC Voltage: Correction	Correction Coefficient YAB	ENG*	[-125 to 125 / 0 / 1-V/step]
2-006-001	Charge AC Voltage: Fixed	Standard Speed: K	ENG*	[0.00 to 3.00 / 2.20 / 0.01kV/step]
2-006-002	Charge AC Voltage: Fixed	Standard Speed: C	ENG*	[0.00 to 3.00 / 2.20 / 0.01kV/step]
2-006-003	Charge AC Voltage: Fixed	Standard Speed: M	ENG*	[0.00 to 3.00 / 2.20 / 0.01kV/step]
2-006-004	Charge AC Voltage: Fixed	Standard Speed: Y	ENG*	[0.00 to 3.00 / 2.20 / 0.01kV/step]
2-006-005	Charge AC Voltage: Fixed	Middle Speed: K	ENG*	[0.00 to 3.00 / 2.20 / 0.01kV/step]

3.SP Mode Tables

SP No.	Large Category	Small Category	ENG or CTL	[Min to Max/Init./Step]
2-006-006	Charge AC Voltage: Fixed	Middle Speed: C	ENG*	[0.00 to 3.00 / 2.20 / 0.01kV/step]
2-006-007	Charge AC Voltage: Fixed	Middle Speed: M	ENG*	[0.00 to 3.00 / 2.20 / 0.01kV/step]
2-006-008	Charge AC Voltage: Fixed	Middle Speed: Y	ENG*	[0.00 to 3.00 / 2.20 / 0.01kV/step]
2-006-009	Charge AC Voltage: Fixed	Low Speed: K	ENG*	[0.00 to 3.00 / 2.20 / 0.01kV/step]
2-006-010	Charge AC Voltage: Fixed	Low Speed: C	ENG*	[0.00 to 3.00 / 2.20 / 0.01kV/step]
2-006-011	Charge AC Voltage: Fixed	Low Speed: M	ENG*	[0.00 to 3.00 / 2.20 / 0.01kV/step]
2-006-012	Charge AC Voltage: Fixed	Low Speed: Y	ENG*	[0.00 to 3.00 / 2.20 / 0.01kV/step]
2-007-001	Charge AC Current: LL	Environmental Target: Bk	ENG*	IM C6000: [0.00 to 3.00 / 1.40 / 0.01mA/step] IM C5500: [0.00 to 3.00 / 1.40 / 0.01mA/step] IM C4500: [0.00 to 3.00 / 1.02 / 0.01mA/step]
2-007-002	Charge AC Current: LL	Environmental Target: C	ENG*	IM C6000: [0.00 to 3.00 / 1.40 /

3.SP Mode Tables

SP No.	Large Category	Small Category	ENG or CTL	[Min to Max/Init./Step]
				0.01mA/step] IM C5500: [0.00 to 3.00 / 1.40 / 0.01mA/step] IM C4500: [0.00 to 3.00 / 1.02 / 0.01mA/step]
2-007-003	Charge AC Current: LL	Environmental Target: M	ENG*	IM C6000: [0.00 to 3.00 / 1.40 / 0.01mA/step] IM C5500: [0.00 to 3.00 / 1.40 / 0.01mA/step] IM C4500: [0.00 to 3.00 / 1.02 / 0.01mA/step]
2-007-004	Charge AC Current: LL	Environmental Target: Y	ENG*	IM C6000: [0.00 to 3.00 / 1.40 / 0.01mA/step] IM C5500: [0.00 to 3.00 / 1.40 / 0.01mA/step] IM C4500: [0.00 to 3.00 / 1.02 / 0.01mA/step]
2-008-001	Charge AC Current: ML	Environmental Target: Bk	ENG*	IM C6000: [0.00 to 3.00 / 1.41 /

3.SP Mode Tables

SP No.	Large Category	Small Category	ENG or CTL	[Min to Max/Init./Step]
				0.01mA/step] IM C5500: [0.00 to 3.00 / 1.41 / 0.01mA/step] IM C4500: [0.00 to 3.00 / 1.02 / 0.01mA/step]
2-008-002	Charge AC Current: ML	Environmental Target: C	ENG*	IM C6000: [0.00 to 3.00 / 1.41 / 0.01mA/step] IM C5500: [0.00 to 3.00 / 1.41 / 0.01mA/step] IM C4500: [0.00 to 3.00 / 1.02 / 0.01mA/step]
2-008-003	Charge AC Current: ML	Environmental Target: M	ENG*	IM C6000: [0.00 to 3.00 / 1.41 / 0.01mA/step] IM C5500: [0.00 to 3.00 / 1.41 / 0.01mA/step] IM C4500: [0.00 to 3.00 / 1.02 / 0.01mA/step]
2-008-004	Charge AC Current: ML	Environmental Target: Y	ENG*	IM C6000: [0.00 to 3.00 / 1.41 /

3.SP Mode Tables

SP No.	Large Category	Small Category	ENG or CTL	[Min to Max/Init./Step]
				0.01mA/step] IM C5500: [0.00 to 3.00 / 1.41 / 0.01mA/step] IM C4500: [0.00 to 3.00 / 1.02 / 0.01mA/step]
2-009-001	Charge AC Current: MM	Environmental Target: Bk	ENG*	IM C6000: [0.00 to 3.00 / 1.42 / 0.01mA/step] IM C5500: [0.00 to 3.00 / 1.42 / 0.01mA/step] IM C4500: [0.00 to 3.00 / 1.02 / 0.01mA/step]
2-009-002	Charge AC Current: MM	Environmental Target: C	ENG*	IM C6000: [0.00 to 3.00 / 1.42 / 0.01mA/step] IM C5500: [0.00 to 3.00 / 1.42 / 0.01mA/step] IM C4500: [0.00 to 3.00 / 1.02 / 0.01mA/step]
2-009-003	Charge AC Current: MM	Environmental Target: M	ENG*	IM C6000: [0.00 to 3.00 / 1.42 /

3.SP Mode Tables

SP No.	Large Category	Small Category	ENG or CTL	[Min to Max/Init./Step]
				0.01mA/step] IM C5500: [0.00 to 3.00 / 1.42 / 0.01mA/step] IM C4500: [0.00 to 3.00 / 1.02 / 0.01mA/step]
2-009-004	Charge AC Current: MM	Environmental Target: Y	ENG*	IM C6000: [0.00 to 3.00 / 1.42 / 0.01mA/step] IM C5500: [0.00 to 3.00 / 1.42 / 0.01mA/step] IM C4500: [0.00 to 3.00 / 1.02 / 0.01mA/step]
2-010-001	Charge AC Current: MH	Environmental Target: Bk	ENG*	IM C6000: [0.00 to 3.00 / 1.45 / 0.01mA/step] IM C5500: [0.00 to 3.00 / 1.45 / 0.01mA/step] IM C4500: [0.00 to 3.00 / 1.05 / 0.01mA/step]
2-010-002	Charge AC Current: MH	Environmental Target: C	ENG*	IM C6000: [0.00 to 3.00 / 1.45 /

3.SP Mode Tables

SP No.	Large Category	Small Category	ENG or CTL	[Min to Max/Init./Step]
				0.01mA/step] IM C5500: [0.00 to 3.00 / 1.45 / 0.01mA/step] IM C4500: [0.00 to 3.00 / 1.05 / 0.01mA/step]
2-010-003	Charge AC Current: MH	Environmental Target: M	ENG*	IM C6000: [0.00 to 3.00 / 1.45 / 0.01mA/step] IM C5500: [0.00 to 3.00 / 1.45 / 0.01mA/step] IM C4500: [0.00 to 3.00 / 1.05 / 0.01mA/step]
2-010-004	Charge AC Current: MH	Environmental Target: Y	ENG*	IM C6000: [0.00 to 3.00 / 1.45 / 0.01mA/step] IM C5500: [0.00 to 3.00 / 1.45 / 0.01mA/step] IM C4500: [0.00 to 3.00 / 1.05 / 0.01mA/step]
2-011-001	Charge AC Current: HH	Environmental Target: Bk	ENG*	IM C6000: [0.00 to 3.00 / 1.49 /

3.SP Mode Tables

SP No.	Large Category	Small Category	ENG or CTL	[Min to Max/Init./Step]
				0.01mA/step] IM C5500: [0.00 to 3.00 / 1.49 / 0.01mA/step] IM C4500: [0.00 to 3.00 / 1.08 / 0.01mA/step]
2-011-002	Charge AC Current: HH	Environmental Target: C	ENG*	IM C6000: [0.00 to 3.00 / 1.49 / 0.01mA/step] IM C5500: [0.00 to 3.00 / 1.49 / 0.01mA/step] IM C4500: [0.00 to 3.00 / 1.08 / 0.01mA/step]
2-011-003	Charge AC Current: HH	Environmental Target: M	ENG*	IM C6000: [0.00 to 3.00 / 1.49 / 0.01mA/step] IM C5500: [0.00 to 3.00 / 1.49 / 0.01mA/step] IM C4500: [0.00 to 3.00 / 1.08 / 0.01mA/step]
2-011-004	Charge AC Current: HH	Environmental Target: Y	ENG*	IM C6000: [0.00 to 3.00 / 1.49 /

3.SP Mode Tables

SP No.	Large Category	Small Category	ENG or CTL	[Min to Max/Init./Step]
				0.01mA/step] IM C5500: [0.00 to 3.00 / 1.49 / 0.01mA/step] IM C4500: [0.00 to 3.00 / 1.08 / 0.01mA/step]
2-012-001	Charge Output Control	AC Voltage	ENG*	[0 to 1 / 0 / 1- /step]
2-013-001	Environmental Correction: PCU	Current Environmental FC : Display	ENG*	[0 to 0 / 0 / 1/step]
2-013-002	Environmental Correction: PCU	Forced Setting	ENG*	[0 to 5 / 0 / 1- /step]
2-013-003	Environmental Correction: PCU	Absolute Humidity: Threshold 1	ENG*	[0.00 to 100.00 / 3.00 / 0.01g/m ³ /step]
2-013-004	Environmental Correction: PCU	Absolute Humidity: Threshold 2	ENG*	[0.00 to 100.00 / 8.00 / 0.01g/m ³ /step]
2-013-005	Environmental Correction: PCU	Absolute Humidity: Threshold 3	ENG*	[0.00 to 100.00 / 15.00 / 0.01g/m ³ /step]
2-013-006	Environmental Correction: PCU	Absolute Humidity: Threshold 4	ENG*	[0.00 to 100.00 / 22.00 / 0.01g/m ³ /step]
2-013-007	Environmental Correction: PCU	Temp FC: Display	ENG*	[0 to 100 / 0 / 1deg/step]
2-013-008	Environmental Correction: PCU	Relative Humidity FC : Display	ENG*	[0 to 100 / 0 / 1%RH/step]

3.SP Mode Tables

SP No.	Large Category	Small Category	ENG or CTL	[Min to Max/Init./Step]
2-013-009	Environmental Correction: PCU	Absolute Humidity FC : Display	ENG*	[0.00 to 100.00 / 0.00 / 0.01g/m ³ /step]
2-013-010	Environmental Correction: PCU	Environmental Bk: Display	ENG*	[0 to 0 / 0 / 1/step]
2-013-011	Environmental Correction: PCU	Temp Bk.: Display	ENG*	[0 to 100 / 0 / 1deg/step]
2-013-012	Environmental Correction: PCU	Relative Humidity Bk : Display	ENG*	[0 to 100 / 0 / 1%RH/step]
2-013-013	Environmental Correction: PCU	Absolute Humidity Bk : Display	ENG*	[0.00 to 100.00 / 0.00 / 0.01g/m ³ /step]
2-014-001	Charge AC Control: Setting	Exec Interval: Power ON	ENG*	[0 to 2000 / 500 / 1page/step]
2-014-002	Charge AC Control: Setting	Exec Interval: Print	ENG*	[0 to 2000 / 0 / 1page/step]
2-014-003	Charge AC Control: Setting	Page Interval	ENG*	[0 to 500 / 10 / 1page/step]
2-014-004	Charge AC Control: Setting	Temperature	ENG*	[0 to 99 / 35 / 1deg/step]
2-014-005	Charge AC Control: Setting	Relative Humidity	ENG*	[0 to 99 / 50 / 1%RH/step]
2-014-006	Charge AC Control: Setting	Absolute Humidity	ENG*	[0 to 99 / 12 / 1g/m ³ /step]
2-014-007	Charge AC Control: Setting	Temp Threshold M	ENG*	[0 to 99 / 10 / 1deg/step]

3.SP Mode Tables

SP No.	Large Category	Small Category	ENG or CTL	[Min to Max/Init./Step]
2-014-008	Charge AC Control: Setting	RH Threshold M	ENG*	[0 to 99 / 50 / 1%RH/step]
2-014-009	Charge AC Control: Setting	AH Threshold M	ENG*	[0 to 99 / 6 / 1g/m ³ /step]
2-014-010	Charge AC Control: Setting	Temp Threshold S	ENG*	[0.0 to 20.0 / 1.0 / 0.1deg/step]
2-014-011	Charge AC Control: Setting	RH Threshold S	ENG*	[0 to 50 / 5 / 1%RH/step]
2-014-012	Charge AC Control: Setting	AH Threshold S	ENG*	[0.0 to 20.0 / 1.0 / 0.1g/m ³ /step]
2-014-013	Charge AC Control: Setting	Non-use Time	ENG*	[0 to 1440 / 360 / 10min./step]
2-014-014	Charge AC Control: Setting	AC Current Error Detection	ENG*	[0 to 1 / 0 / 1-/step]
2-014-019	Charge AC Control: Display	Charge AC Feedback Volt K	ENG	[0 to 9999 / 0 / 1mV/step]
2-014-020	Charge AC Control: Display	Charge AC Feedback Volt C	ENG	[0 to 9999 / 0 / 1mV/step]
2-014-021	Charge AC Control: Display	Charge AC Feedback Volt M	ENG	[0 to 9999 / 0 / 1mV/step]
2-014-022	Charge AC Control: Display	Charge AC Feedback Volt Y	ENG	[0 to 9999 / 0 / 1mV/step]
2-015-001	Charge AC Adj: Result	Bk	ENG*	[0 to 9 / 0 / 1/step]

3.SP Mode Tables

SP No.	Large Category	Small Category	ENG or CTL	[Min to Max/Init./Step]
2-015-002	Charge AC Adj: Result	C	ENG*	[0 to 9 / 0 / 1/step]
2-015-003	Charge AC Adj: Result	M	ENG*	[0 to 9 / 0 / 1/step]
2-015-004	Charge AC Adj: Result	Y	ENG*	[0 to 9 / 0 / 1/step]
2-020-001	Background Pot Corr. Set	Temp. Condition	ENG*	[0 to 19 / 15 / 1deg/step]
2-020-002	Background Pot Corr. Set	Absolute Humidity	ENG*	[0 to 99 / 6 / 1g/m ³ /step]
2-020-003	Background Pot Corr. Set	Print Page Counter After Corr.	ENG*	[0 to 999 / 0 / 1page/step]
2-020-004	Background Pot Corr. Set	Print Pages Threshold After Corr.	ENG*	[0 to 999 / 10 / 1page/step]
2-020-005	Background Pot Corr. Set	Temp. Thresh	ENG*	[20 to 99 / 20 / 1deg/step]
2-020-011	Background Pot Corr. Set	Coeff. a: K	ENG*	[0.00 to 1.00 / 0.06 / 0.01- /step]
2-020-012	Background Pot Corr. Set	Coeff. a: C	ENG*	[0.00 to 1.00 / 0.06 / 0.01- /step]
2-020-013	Background Pot Corr. Set	Coeff. a: M	ENG*	[0.00 to 1.00 / 0.06 / 0.01- /step]
2-020-014	Background Pot Corr. Set	Coeff. a: Y	ENG*	[0.00 to 1.00 / 0.06 / 0.01- /step]

3.SP Mode Tables

SP No.	Large Category	Small Category	ENG or CTL	[Min to Max/Init./Step]
2-020-015	Background Pot Corr. Set	Coeff. b: K	ENG*	[0.00 to 9.00 / 0.50 / 0.01- /step]
2-020-016	Background Pot Corr. Set	Coeff. b: C	ENG*	[0.00 to 9.00 / 0.50 / 0.01- /step]
2-020-017	Background Pot Corr. Set	Coeff. b: M	ENG*	[0.00 to 9.00 / 0.50 / 0.01- /step]
2-020-018	Background Pot Corr. Set	Coeff. b: Y	ENG*	[0.00 to 9.00 / 0.50 / 0.01- /step]
2-021-001	Background Pot Corr.	Display: K	ENG*	[0 to 90 / 0 / 1- V/step]
2-021-002	Background Pot Corr.	Display: C	ENG*	[0 to 90 / 0 / 1- V/step]
2-021-003	Background Pot Corr.	Display: M	ENG*	[0 to 90 / 0 / 1- V/step]
2-021-004	Background Pot Corr.	Display: Y	ENG*	[0 to 90 / 0 / 1- V/step]
2-021-005	Background Pot Corr.	Setting 1: K	ENG*	[0 to 90 / 10 / 10-V/step]
2-021-006	Background Pot Corr.	Setting 1: C	ENG*	[0 to 90 / 10 / 10-V/step]
2-021-007	Background Pot Corr.	Setting 1: M	ENG*	[0 to 90 / 10 / 10-V/step]
2-021-008	Background Pot Corr.	Setting 1: Y	ENG*	[0 to 90 / 10 / 10-V/step]

3.SP Mode Tables

SP No.	Large Category	Small Category	ENG or CTL	[Min to Max/Init./Step]
2-021-009	Background Pot Corr.	Setting 2: K	ENG*	[0 to 90 / 20 / 10-V/step]
2-021-010	Background Pot Corr.	Setting 2: C	ENG*	[0 to 90 / 20 / 10-V/step]
2-021-011	Background Pot Corr.	Setting 2: M	ENG*	[0 to 90 / 20 / 10-V/step]
2-021-012	Background Pot Corr.	Setting 2: Y	ENG*	[0 to 90 / 20 / 10-V/step]
2-021-013	Background Pot Corr.	Setting 3: K	ENG*	[0 to 90 / 30 / 5-V/step]
2-021-014	Background Pot Corr.	Setting 3: C	ENG*	[0 to 90 / 30 / 5-V/step]
2-021-015	Background Pot Corr.	Setting 3: M	ENG*	[0 to 90 / 30 / 5-V/step]
2-021-016	Background Pot Corr.	Setting 3: Y	ENG*	[0 to 90 / 30 / 5-V/step]
2-021-017	Background Pot Corr.	Setting 4: K	ENG*	[0 to 90 / 40 / 5-V/step]
2-021-018	Background Pot Corr.	Setting 4: C	ENG*	[0 to 90 / 40 / 5-V/step]
2-021-019	Background Pot Corr.	Setting 4: M	ENG*	[0 to 90 / 40 / 5-V/step]
2-021-020	Background Pot Corr.	Setting 4: Y	ENG*	[0 to 90 / 40 / 5-V/step]

3.SP Mode Tables

SP No.	Large Category	Small Category	ENG or CTL	[Min to Max/Init./Step]
2-021-021	Background Pot Corr.	Setting 5: K	ENG*	[0 to 90 / 10 / 1-V/step]
2-021-022	Background Pot Corr.	Setting 5: C	ENG*	[0 to 90 / 10 / 1-V/step]
2-021-023	Background Pot Corr.	Setting 5: M	ENG*	[0 to 90 / 10 / 1-V/step]
2-021-024	Background Pot Corr.	Setting 5: Y	ENG*	[0 to 90 / 10 / 1-V/step]
2-021-025	Background Pot Corr.	Setting 6: K	ENG*	[-90 to 90 / 2 / 1-V/step]
2-021-026	Background Pot Corr.	Setting 6: C	ENG*	[-90 to 90 / 2 / 1-V/step]
2-021-027	Background Pot Corr.	Setting 6: M	ENG*	[-90 to 90 / 2 / 1-V/step]
2-021-028	Background Pot Corr.	Setting 6: Y	ENG*	[-90 to 90 / 2 / 1-V/step]
2-021-029	Background Pot Corr.	Display: Energized: K	ENG*	[0 to 90 / 0 / 1-V/step]
2-021-030	Background Pot Corr.	Display: Energized: C	ENG*	[0 to 90 / 0 / 1-V/step]
2-021-031	Background Pot Corr.	Display: Energized: M	ENG*	[0 to 90 / 0 / 1-V/step]
2-021-032	Background Pot Corr.	Display: Energized: Y	ENG*	[0 to 90 / 0 / 1-V/step]

3.SP Mode Tables

SP No.	Large Category	Small Category	ENG or CTL	[Min to Max/Init./Step]
2-021-033	Background Pot Corr.	Display: Total Rotation: K	ENG*	[0 to 30 / 0 / 1-V/step]
2-021-034	Background Pot Corr.	Display: Total Rotation: C	ENG*	[0 to 30 / 0 / 1-V/step]
2-021-035	Background Pot Corr.	Display: Total Rotation: M	ENG*	[0 to 30 / 0 / 1-V/step]
2-021-036	Background Pot Corr.	Display: Total Rotation: Y	ENG*	[0 to 30 / 0 / 1-V/step]
2-021-037	Background Pot Corr.	Split Number n: K	ENG*	IM C6000: [1 to 99 / 15 / 1- /step] IM C5500: [1 to 99 / 15 / 1- /step] IM C4500: [1 to 99 / 15 / 1- /step]
2-021-038	Background Pot Corr.	Split Number n: C	ENG*	IM C6000: [1 to 99 / 13 / 1- /step] IM C5500: [1 to 99 / 15 / 1- /step] IM C4500: [1 to 99 / 13 / 1- /step]
2-021-039	Background Pot Corr.	Split Number n: M	ENG*	IM C6000: [1 to 99 / 13 / 1- /step] IM C5500: [1 to 99 / 15 / 1- /step]

3.SP Mode Tables

SP No.	Large Category	Small Category	ENG or CTL	[Min to Max/Init./Step]
				IM C4500: [1 to 99 / 13 / 1- /step]
2- 021- 040	Background Pot Corr.	Split Number n: Y	ENG*	IM C6000: [1 to 99 / 13 / 1- /step] IM C5500: [1 to 99 / 15 / 1- /step] IM C4500: [1 to 99 / 13 / 1- /step]
2- 021- 041	Background Pot Corr.	Display:Energized for Target Value:K	ENG*	[0 to 90 / 0 / 1- V/step]
2- 021- 042	Background Pot Corr.	Display:Energized for Target Value:C	ENG*	[0 to 90 / 0 / 1- V/step]
2- 021- 043	Background Pot Corr.	Display:Energized for Target Value:M	ENG*	[0 to 90 / 0 / 1- V/step]
2- 021- 044	Background Pot Corr.	Display:Energized for Target Value:Y	ENG*	[0 to 90 / 0 / 1- V/step]
2- 022- 001	Charge R Running Par	Display:K	ENG*	[0 to 999999 / 0 / 1-/step]
2- 022- 002	Charge R Running Par	Display:C	ENG*	[0 to 999999 / 0 / 1-/step]
2- 022- 003	Charge R Running Par	Display:M	ENG*	[0 to 999999 / 0 / 1-/step]
2- 022- 004	Charge R Running Par	Display:Y	ENG*	[0 to 999999 / 0 / 1-/step]

3.SP Mode Tables

SP No.	Large Category	Small Category	ENG or CTL	[Min to Max/Init./Step]
2-022-005	Charge R Running Par	PCU Rotation Time After Correction: K	ENG*	[0 to 9999999 / 0 / 1-/step]
2-022-006	Charge R Running Par	PCU Rotation Time After Correction: C	ENG*	[0 to 9999999 / 0 / 1-/step]
2-022-007	Charge R Running Par	PCU Rotation Time After Correction: M	ENG*	[0 to 9999999 / 0 / 1-/step]
2-022-008	Charge R Running Par	PCU Rotation Time After Correction: Y	ENG*	[0 to 9999999 / 0 / 1-/step]
2-022-009	Charge R Running Par	Threshold1:K	ENG*	[0 to 4000 / 30 / 1-/step]
2-022-010	Charge R Running Par	Threshold1:C	ENG*	[0 to 4000 / 30 / 1-/step]
2-022-011	Charge R Running Par	Threshold1:M	ENG*	[0 to 4000 / 30 / 1-/step]
2-022-012	Charge R Running Par	Threshold1:Y	ENG*	[0 to 4000 / 30 / 1-/step]
2-022-013	Charge R Running Par	Threshold2:K	ENG*	[0 to 4000 / 70 / 1-/step]
2-022-014	Charge R Running Par	Threshold2:C	ENG*	[0 to 4000 / 70 / 1-/step]
2-022-015	Charge R Running Par	Threshold2:M	ENG*	[0 to 4000 / 70 / 1-/step]
2-022-016	Charge R Running Par	Threshold2:Y	ENG*	[0 to 4000 / 70 / 1-/step]

3.SP Mode Tables

SP No.	Large Category	Small Category	ENG or CTL	[Min to Max/Init./Step]
2-022-017	Charge R Running Par	Threshold3:K	ENG*	[0 to 4000 / 150 / 1-/step]
2-022-018	Charge R Running Par	Threshold3:C	ENG*	[0 to 4000 / 150 / 1-/step]
2-022-019	Charge R Running Par	Threshold3:M	ENG*	[0 to 4000 / 150 / 1-/step]
2-022-020	Charge R Running Par	Threshold3:Y	ENG*	[0 to 4000 / 150 / 1-/step]
2-022-021	Charge R Running Par	Threshold4:K	ENG*	[0 to 4000 / 250 / 1-/step]
2-022-022	Charge R Running Par	Threshold4:C	ENG*	[0 to 4000 / 250 / 1-/step]
2-022-023	Charge R Running Par	Threshold4:M	ENG*	[0 to 4000 / 250 / 1-/step]
2-022-024	Charge R Running Par	Threshold4:Y	ENG*	[0 to 4000 / 250 / 1-/step]
2-022-025	Charge R Running Par	Prev Correction Calculation Bk:Year	ENG*	[0 to 99 / 0 / 1year/step]
2-022-026	Charge R Running Par	Prev Correction Calculation Bk:Month	ENG*	[1 to 12 / 1 / 1month/step]
2-022-027	Charge R Running Par	Prev Correction Calculation Bk:Day	ENG*	[1 to 31 / 1 / 1day/step]
2-022-028	Charge R Running Par	Prev Correction Calculation Bk:Hour	ENG*	[0 to 23 / 0 / 1hour/step]

3.SP Mode Tables

SP No.	Large Category	Small Category	ENG or CTL	[Min to Max/Init./Step]
2-022-029	Charge R Running Par	Prev Correction Calculation Bk:Minute	ENG*	[0 to 59 / 0 / 1minute/step]
2-022-030	Charge R Running Par	Rotation At Prev Correction: PCU: Bk	ENG*	[0 to 999999999 / 0 / 1mm/step]
2-022-031	Charge R Running Par	Rotation At Prev Correction: PCU: C	ENG*	[0 to 999999999 / 0 / 1mm/step]
2-022-032	Charge R Running Par	Rotation At Prev Correction: PCU: M	ENG*	[0 to 999999999 / 0 / 1mm/step]
2-022-033	Charge R Running Par	Rotation At Prev Correction: PCU: Y	ENG*	[0 to 999999999 / 0 / 1mm/step]
2-101-001	Registration Correction	Color Main Dot: Bk	ENG*	[-512 to 511 / 0 / 1dot/step]
2-101-002	Registration Correction	Color Main Dot: Ma	ENG*	[-512 to 511 / 0 / 1dot/step]
2-101-003	Registration Correction	Color Main Dot: Cy	ENG*	[-512 to 511 / 0 / 1dot/step]
2-101-004	Registration Correction	Color Main Dot: Ye	ENG*	[-512 to 511 / 0 / 1dot/step]
2-101-005	Registration Correction	Color Sub Line: Bk	ENG*	[-16384 to 16383 / 0 / 1line/step]
2-101-006	Registration Correction	Color Sub Line: Ma	ENG*	[-16384 to 16383 / 0 / 1line/step]
2-101-007	Registration Correction	Color Sub Line: Cy	ENG*	[-16384 to 16383 / 0 / 1line/step]

3.SP Mode Tables

SP No.	Large Category	Small Category	ENG or CTL	[Min to Max/Init./Step]
2-101-008	Registration Correction	Color Sub Line: Ye	ENG*	[-16384 to 16383 / 0 / 1line/step]
2-102-001	Magnification Adjustment	Main Mag.: Standard Speed: Bk	ENG*	[-2.000 to 2.000 / 0.000 / 0.001%/step]
2-102-002	Magnification Adjustment	Main Mag.: Middle Speed: Bk	ENG*	[-2.000 to 2.000 / 0.000 / 0.001%/step]
2-102-003	Magnification Adjustment	Main Mag.: Low Speed: Bk	ENG*	[-2.000 to 2.000 / 0.000 / 0.001%/step]
2-102-004	Magnification Adjustment	Main Mag.: Standard Speed: Ma	ENG*	[-2.000 to 2.000 / 0.000 / 0.001%/step]
2-102-005	Magnification Adjustment	Main Mag.: Middle Speed: Ma	ENG*	[-2.000 to 2.000 / 0.000 / 0.001%/step]
2-102-006	Magnification Adjustment	Main Mag.: Low Speed: Ma	ENG*	[-2.000 to 2.000 / 0.000 / 0.001%/step]
2-102-007	Magnification Adjustment	Main Mag.: Standard Speed: Cy	ENG*	[-2.000 to 2.000 / 0.000 / 0.001%/step]
2-102-008	Magnification Adjustment	Main Mag.: Middle Speed: Cy	ENG*	[-2.000 to 2.000 / 0.000 / 0.001%/step]
2-102-009	Magnification Adjustment	Main Mag.: Low Speed: Cy	ENG*	[-2.000 to 2.000 / 0.000 / 0.001%/step]
2-102-010	Magnification Adjustment	Main Mag.: Standard Speed: Ye	ENG*	[-2.000 to 2.000 / 0.000 / 0.001%/step]
2-102-011	Magnification Adjustment	Main Mag.: Middle Speed: Ye	ENG*	[-2.000 to 2.000 / 0.000 / 0.001%/step]

3.SP Mode Tables

SP No.	Large Category	Small Category	ENG or CTL	[Min to Max/Init./Step]
2-102-012	Magnification Adjustment	Main Mag.: Low Speed: Ye	ENG*	[-2.000 to 2.000 / 0.000 / 0.001%/step]
2-102-028	Magnification Adjustment	Color Main Mag.: High Speed: Ma	ENG*	[-2.000 to 2.000 / 0.000 / 0.001%/step]
2-102-031	Magnification Adjustment	Color Main Mag.: High Speed: Cy	ENG*	[-2.000 to 2.000 / 0.000 / 0.001%/step]
2-102-034	Magnification Adjustment	Color Main Mag.: High Speed: Ye	ENG*	[-2.000 to 2.000 / 0.000 / 0.001%/step]
2-102-037	Main Scan Beam Pitch Adj.	Bk: 1st-2nd	ENG*	[0.00 to 100.00 / 9.61 / 0.01dot/step]
2-102-038	Main Scan Beam Pitch Adj.	Bk: 1st-3rd	ENG*	[0.00 to 100.00 / 19.22 / 0.01dot/step]
2-102-039	Main Scan Beam Pitch Adj.	Bk: 1st-4th	ENG*	[0.00 to 100.00 / 28.83 / 0.01dot/step]
2-102-040	Main Scan Beam Pitch Adj.	Ma: 1st-2nd	ENG*	[0.00 to 100.00 / 9.61 / 0.01dot/step]
2-102-041	Main Scan Beam Pitch Adj.	Ma: 1st-3rd	ENG*	[0.00 to 100.00 / 19.22 / 0.01dot/step]
2-102-042	Main Scan Beam Pitch Adj.	Ma: 1st-4th	ENG*	[0.00 to 100.00 / 28.83 / 0.01dot/step]
2-102-043	Main Scan Beam Pitch Adj.	Cy: 1st-2nd	ENG*	[0.00 to 100.00 / 9.61 / 0.01dot/step]
2-102-044	Main Scan Beam Pitch Adj.	Cy: 1st-3rd	ENG*	[0.00 to 100.00 / 19.22 / 0.01dot/step]

3.SP Mode Tables

SP No.	Large Category	Small Category	ENG or CTL	[Min to Max/Init./Step]
2-102-045	Main Scan Beam Pitch Adj.	Cy: 1st-4th	ENG*	[0.00 to 100.00 / 28.83 / 0.01dot/step]
2-102-046	Main Scan Beam Pitch Adj.	Ye: 1st-2nd	ENG*	[0.00 to 100.00 / 9.61 / 0.01dot/step]
2-102-047	Main Scan Beam Pitch Adj.	Ye: 1st-3rd	ENG*	[0.00 to 100.00 / 19.22 / 0.01dot/step]
2-102-048	Main Scan Beam Pitch Adj.	Ye: 1st-4th	ENG*	[0.00 to 100.00 / 28.83 / 0.01dot/step]
2-103-001	Erase Margin Adjustment	Lead Edge Width	ENG	[0.0 to 9.9 / 4.2 / 0.1mm/step]
2-103-002	Erase Margin Adjustment	Trail. Edge Width	ENG	[0.0 to 9.9 / 4.2 / 0.1mm/step]
2-103-003	Erase Margin Adjustment	Left	ENG	[0.0 to 9.9 / 2.0 / 0.1mm/step]
2-103-004	Erase Margin Adjustment	Right	ENG	[0.0 to 9.9 / 2.0 / 0.1mm/step]
2-103-006	Erase Margin Adjustment	Duplex Trail. L Size	ENG	[-4.0 to 4.0 / 0.8 / 0.1mm/step]
2-103-007	Erase Margin Adjustment	Duplex Trail. M Size	ENG	[-4.0 to 4.0 / 0.8 / 0.1mm/step]
2-103-008	Erase Margin Adjustment	Duplex Trail. S Size	ENG	[-4.0 to 4.0 / 0.6 / 0.1mm/step]
2-103-009	Erase Margin Adjustment	Duplex Left Edge	ENG	[0.0 to 1.5 / 0.3 / 0.1mm/step]

3.SP Mode Tables

SP No.	Large Category	Small Category	ENG or CTL	[Min to Max/Init./Step]
2-103-010	Erase Margin Adjustment	Duplex Right Edge	ENG	[0.0 to 1.5 / 0.3 / 0.1mm/step]
2-103-011	Erase Margin Adjustment	Duplex Trail. L Size:Thick	ENG	[-4.0 to 4.0 / 0.8 / 0.1mm/step]
2-103-012	Erase Margin Adjustment	Duplex Trail. M Size:Thick	ENG	[-4.0 to 4.0 / 0.8 / 0.1mm/step]
2-103-013	Erase Margin Adjustment	Duplex Trail. S Size:Thick	ENG	[-4.0 to 4.0 / 0.6 / 0.1mm/step]
2-103-014	Erase Margin Adjustment	Duplex Left Edge:Thick	ENG	[0.0 to 1.5 / 0.3 / 0.1mm/step]
2-103-015	Erase Margin Adjustment	Duplex Right Edge:Thick	ENG	[0.0 to 1.5 / 0.3 / 0.1mm/step]
2-103-016	Erase Margin Adjustment	Duplex Trail. L Size:Thin	ENG	[-4.0 to 4.0 / 0.8 / 0.1mm/step]
2-103-017	Erase Margin Adjustment	Duplex Trail. M Size:Thin	ENG	[-4.0 to 4.0 / 0.8 / 0.1mm/step]
2-103-018	Erase Margin Adjustment	Duplex Trail. S Size:Thin	ENG	[-4.0 to 4.0 / 0.6 / 0.1mm/step]
2-103-019	Erase Margin Adjustment	Lead Edge Width:Thin	ENG	[0.0 to 9.9 / 4.2 / 0.1mm/step]
2-103-020	Erase Margin Adjustment	Trail. Edge Width:Thin	ENG	[0.0 to 9.9 / 4.2 / 0.1mm/step]
2-106-001	Polygon Rotation Time	Warming-Up	ENG*	[0 to 60 / 10 / 1sec/step]

3.SP Mode Tables

SP No.	Large Category	Small Category	ENG or CTL	[Min to Max/Init./Step]
2-106-002	Polygon Rotation Time	Job End	ENG*	[0.0 to 60.0 / 0.1 / 0.1sec/step]
2-107-001	Image Parameter	Image Gamma Flag	ENG	[0 to 1 / 1 / 1/step]
2-107-002	Image Parameter	Shading Correction Flag	ENG*	[0 to 1 / 0 / 1/step]
2-109-003	Test Pattern	Pattern Selection	ENG	[0 to 23 / 0 / 1/step]
2-109-005	Test Pattern	Color Selection	ENG	[1 to 4 / 1 / 1/step]
2-109-006	Test Pattern	Density: Bk	ENG	[0 to 15 / 15 / 1/step]
2-109-007	Test Pattern	Density: Ma	ENG	[0 to 15 / 15 / 1/step]
2-109-008	Test Pattern	Density: Cy	ENG	[0 to 15 / 15 / 1/step]
2-109-009	Test Pattern	Density: Ye	ENG	[0 to 15 / 15 / 1/step]
2-110-001	LD Driver	Error Bk	ENG	[0x0000 to 0xFFFF / 0x0000 / 1/step]
2-110-002	LD Driver	Error Ma	ENG	[0x0000 to 0xFFFF / 0x0000 / 1/step]
2-110-003	LD Driver	Error Cy	ENG	[0x0000 to 0xFFFF / 0x0000 / 1/step]

3.SP Mode Tables

SP No.	Large Category	Small Category	ENG or CTL	[Min to Max/Init./Step]
2-110-004	LD Driver	Error Ye	ENG	[0x0000 to 0xFFFF / 0x0000 / 1/step]
2-110-005	LD Driver	Writing Unit Adj. Transfer	ENG	[0 to 1 / 0 / 1/step]
2-110-010	LD Driver	Power Detection result	ENG	[0 to 255 / 0 / 1/step]
2-110-011	LD Driver	Noise Count	ENG	[0 to 32768 / 0 / 1times/step]
2-111-001	Forced Line Position Adj.	Mode a	ENG	[0 to 1 / 0 / 1/step]
2-111-002	Forced Line Position Adj.	Mode b	ENG	[0 to 1 / 0 / 1/step]
2-111-003	Forced Line Position Adj.	Mode c	ENG	[0 to 1 / 0 / 1/step]
2-111-004	Forced Line Position Adj.	Mode d	ENG	[0 to 1 / 0 / 1/step]
2-112-001	TM/ID Sensor Check	Execute	ENG	[0 to 1 / 0 / 1/step]
2-112-010	TM/ID Sensor Test	General:FCR	ENG*	[0 to 999 / 0 / 1/step]
2-112-011	Music Belt Test	Belt Error:FCR	ENG*	[0 to 999 / 0 / 1/step]
2-112-020	TM/ID Sensor Test	Threshold Setting	ENG*	[0.00 to 3.50 / 1.90 / 0.01V/step]

3.SP Mode Tables

SP No.	Large Category	Small Category	ENG or CTL	[Min to Max/Init./Step]
2-112-030	Music Belt Test	Music Belt Ptn NG Th	ENG*	[0.00 to 5.50 / 5.50 / 0.01V/step]
2-112-040	Music Belt Test	Music Belt Ifsg NG Th	ENG*	[0.0 to 50.0 / 50.0 / 0.1/step]
2-117-001	Skew Adjustment	Pulse: M	ENG*	[-75 to 75 / 0 / 1pulse/step]
2-117-002	Skew Adjustment	Pulse: C	ENG*	[-75 to 75 / 0 / 1pulse/step]
2-117-003	Skew Adjustment	Pulse: Y	ENG*	[-99 to 99 / 0 / 1pulse/step]
2-118-001	Skew Adjustment	Execute: M	ENG	[0 to 1 / 0 / 0/step]
2-118-002	Skew Adjustment	Execute: C	ENG	[0 to 1 / 0 / 0/step]
2-118-003	Skew Adjustment	Execute: Y	ENG	[0 to 1 / 0 / 0/step]
2-119-001	Skew Adjustment Display	M	ENG*	[-75 to 75 / 0 / 1pulse/step]
2-119-002	Skew Adjustment Display	C	ENG*	[-75 to 75 / 0 / 1pulse/step]
2-119-003	Skew Adjustment Display	Y	ENG*	[-99 to 99 / 0 / 1pulse/step]
2-120-001	Skew Adj Changing Line Speed	On/Off	ENG*	[0 to 1 / 1 / 1/step]

3.SP Mode Tables

SP No.	Large Category	Small Category	ENG or CTL	[Min to Max/Init./Step]
2-121-001	Skew Adjust Coefficient	Coefficient	ENG*	[0 to 2 / 0 / 1/step]
2-140-005	TM/ID Sensor Check Result	PWM: Front	ENG*	[0 to 1023 / 0 / 1/step]
2-140-006	TM/ID Sensor Check Result	PWM: Center	ENG*	[0 to 1023 / 0 / 1/step]
2-140-007	TM/ID Sensor Check Result	PWM: Rear	ENG*	[0 to 1023 / 0 / 1/step]
2-141-005	TM/ID Sensor Check Result	Average: Front	ENG*	[0.00 to 5.50 / 0.00 / 0.01V/step]
2-141-006	TM/ID Sensor Check Result	Average: Center	ENG*	[0.00 to 5.50 / 0.00 / 0.01V/step]
2-141-007	TM/ID Sensor Check Result	Average: Rear	ENG*	[0.00 to 5.50 / 0.00 / 0.01V/step]
2-142-005	TM/ID Sensor Check Result	Maximum: Front	ENG*	[0.00 to 5.50 / 0.00 / 0.01V/step]
2-142-006	TM/ID Sensor Check Result	Maximum: Center	ENG*	[0.00 to 5.50 / 0.00 / 0.01V/step]
2-142-007	TM/ID Sensor Check Result	Maximum: Rear	ENG*	[0.00 to 5.50 / 0.00 / 0.01V/step]
2-143-005	TM/ID Sensor Check Result	Minimum: Front	ENG*	[0.00 to 5.50 / 0.00 / 0.01V/step]
2-143-006	TM/ID Sensor Check Result	Minimum: Center	ENG*	[0.00 to 5.50 / 0.00 / 0.01V/step]

3.SP Mode Tables

SP No.	Large Category	Small Category	ENG or CTL	[Min to Max/Init./Step]
2-143-007	TM/ID Sensor Check Result	Minimum: Rear	ENG*	[0.00 to 5.50 / 0.00 / 0.01V/step]
2-144-005	TM/ID Sensor Check Result	Maximum 2: Front	ENG*	[0.00 to 5.50 / 0.00 / 0.01V/step]
2-144-006	TM/ID Sensor Check Result	Maximum 2: Center	ENG*	[0.00 to 5.50 / 0.00 / 0.01V/step]
2-144-007	TM/ID Sensor Check Result	Maximum 2: Rear	ENG*	[0.00 to 5.50 / 0.00 / 0.01V/step]
2-145-005	TM/ID Sensor Check Result	Minimum 2: Front	ENG*	[0.00 to 5.50 / 0.00 / 0.01V/step]
2-145-006	TM/ID Sensor Check Result	Minimum 2: Center	ENG*	[0.00 to 5.50 / 0.00 / 0.01V/step]
2-145-007	TM/ID Sensor Check Result	Minimum 2: Rear	ENG*	[0.00 to 5.50 / 0.00 / 0.01V/step]
2-146-005	TM-Sensor Test	Number of Edge Detection:Front	ENG*	[0 to 16 / 0 / 1/step]
2-146-006	TM-Sensor Test	Number of Edge Detection:Center	ENG*	[0 to 16 / 0 / 1/step]
2-146-007	TM-Sensor Test	Number of Edge Detection:Rear	ENG*	[0 to 16 / 0 / 1/step]
2-150-027	Area Mag. Correction	Area 0: Bk	ENG*	[-16.00 to 16.00 / 0.00 / 0.01dot/step]
2-150-028	Area Mag. Correction	Area 1: Bk	ENG*	[-16.00 to 16.00 / 0.00 / 0.01dot/step]

3.SP Mode Tables

SP No.	Large Category	Small Category	ENG or CTL	[Min to Max/Init./Step]
2-150-029	Area Mag. Correction	Area 2: Bk	ENG*	[-16.00 to 16.00 / 0.00 / 0.01dot/step]
2-150-030	Area Mag. Correction	Area 3: Bk	ENG*	[-16.00 to 16.00 / 0.00 / 0.01dot/step]
2-150-031	Area Mag. Correction	Area 4: Bk	ENG*	[-16.00 to 16.00 / 0.00 / 0.01dot/step]
2-150-032	Area Mag. Correction	Area 5: Bk	ENG*	[-16.00 to 16.00 / 0.00 / 0.01dot/step]
2-150-033	Area Mag. Correction	Area 6: Bk	ENG*	[-16.00 to 16.00 / 0.00 / 0.01dot/step]
2-150-034	Area Mag. Correction	Area 7: Bk	ENG*	[-16.00 to 16.00 / 0.00 / 0.01dot/step]
2-150-035	Area Mag. Correction	Area 8: Bk	ENG*	[-16.00 to 16.00 / 0.00 / 0.01dot/step]
2-150-036	Area Mag. Correction	Area 9: Bk	ENG*	[-16.00 to 16.00 / 0.00 / 0.01dot/step]
2-150-037	Area Mag. Correction	Area 10: Bk	ENG*	[-16.00 to 16.00 / 0.00 / 0.01dot/step]
2-150-038	Area Mag. Correction	Area 11: Bk	ENG*	[-16.00 to 16.00 / 0.00 / 0.01dot/step]
2-150-039	Area Mag. Correction	Area 12: Bk	ENG*	[-16.00 to 16.00 / 0.00 / 0.01dot/step]
2-150-079	Area Mag. Correction	Area 0: Ma	ENG*	[-16.00 to 16.00 / 0.00 / 0.01dot/step]

3.SP Mode Tables

SP No.	Large Category	Small Category	ENG or CTL	[Min to Max/Init./Step]
2-150-080	Area Mag. Correction	Area 1: Ma	ENG*	[-16.00 to 16.00 / 0.00 / 0.01dot/step]
2-150-081	Area Mag. Correction	Area 2: Ma	ENG*	[-16.00 to 16.00 / 0.00 / 0.01dot/step]
2-150-082	Area Mag. Correction	Area 3: Ma	ENG*	[-16.00 to 16.00 / 0.00 / 0.01dot/step]
2-150-083	Area Mag. Correction	Area 4: Ma	ENG*	[-16.00 to 16.00 / 0.00 / 0.01dot/step]
2-150-084	Area Mag. Correction	Area 5: Ma	ENG*	[-16.00 to 16.00 / 0.00 / 0.01dot/step]
2-150-085	Area Mag. Correction	Area 6: Ma	ENG*	[-16.00 to 16.00 / 0.00 / 0.01dot/step]
2-150-086	Area Mag. Correction	Area 7: Ma	ENG*	[-16.00 to 16.00 / 0.00 / 0.01dot/step]
2-150-087	Area Mag. Correction	Area 8: Ma	ENG*	[-16.00 to 16.00 / 0.00 / 0.01dot/step]
2-150-088	Area Mag. Correction	Area 9: Ma	ENG*	[-16.00 to 16.00 / 0.00 / 0.01dot/step]
2-150-089	Area Mag. Correction	Area 10: Ma	ENG*	[-16.00 to 16.00 / 0.00 / 0.01dot/step]
2-150-090	Area Mag. Correction	Area 11: Ma	ENG*	[-16.00 to 16.00 / 0.00 / 0.01dot/step]
2-150-091	Area Mag. Correction	Area 12: Ma	ENG*	[-16.00 to 16.00 / 0.00 / 0.01dot/step]

3.SP Mode Tables

SP No.	Large Category	Small Category	ENG or CTL	[Min to Max/Init./Step]
2-150-131	Area Mag. Correction	Area 0: Cy	ENG*	[-16.00 to 16.00 / 0.00 / 0.01dot/step]
2-150-132	Area Mag. Correction	Area 1: Cy	ENG*	[-16.00 to 16.00 / 0.00 / 0.01dot/step]
2-150-133	Area Mag. Correction	Area 2: Cy	ENG*	[-16.00 to 16.00 / 0.00 / 0.01dot/step]
2-150-134	Area Mag. Correction	Area 3: Cy	ENG*	[-16.00 to 16.00 / 0.00 / 0.01dot/step]
2-150-135	Area Mag. Correction	Area 4: Cy	ENG*	[-16.00 to 16.00 / 0.00 / 0.01dot/step]
2-150-136	Area Mag. Correction	Area 5: Cy	ENG*	[-16.00 to 16.00 / 0.00 / 0.01dot/step]
2-150-137	Area Mag. Correction	Area 6: Cy	ENG*	[-16.00 to 16.00 / 0.00 / 0.01dot/step]
2-150-138	Area Mag. Correction	Area 7: Cy	ENG*	[-16.00 to 16.00 / 0.00 / 0.01dot/step]
2-150-139	Area Mag. Correction	Area 8: Cy	ENG*	[-16.00 to 16.00 / 0.00 / 0.01dot/step]
2-150-140	Area Mag. Correction	Area 9: Cy	ENG*	[-16.00 to 16.00 / 0.00 / 0.01dot/step]
2-150-141	Area Mag. Correction	Area 10: Cy	ENG*	[-16.00 to 16.00 / 0.00 / 0.01dot/step]
2-150-142	Area Mag. Correction	Area 11: Cy	ENG*	[-16.00 to 16.00 / 0.00 / 0.01dot/step]

3.SP Mode Tables

SP No.	Large Category	Small Category	ENG or CTL	[Min to Max/Init./Step]
2-150-143	Area Mag. Correction	Area 12: Cy	ENG*	[-16.00 to 16.00 / 0.00 / 0.01dot/step]
2-150-183	Area Mag. Correction	Area 0: Ye	ENG*	[-16.00 to 16.00 / 0.00 / 0.01dot/step]
2-150-184	Area Mag. Correction	Area 1: Ye	ENG*	[-16.00 to 16.00 / 0.00 / 0.01dot/step]
2-150-185	Area Mag. Correction	Area 2: Ye	ENG*	[-16.00 to 16.00 / 0.00 / 0.01dot/step]
2-150-186	Area Mag. Correction	Area 3: Ye	ENG*	[-16.00 to 16.00 / 0.00 / 0.01dot/step]
2-150-187	Area Mag. Correction	Area 4: Ye	ENG*	[-16.00 to 16.00 / 0.00 / 0.01dot/step]
2-150-188	Area Mag. Correction	Area 5: Ye	ENG*	[-16.00 to 16.00 / 0.00 / 0.01dot/step]
2-150-189	Area Mag. Correction	Area 6: Ye	ENG*	[-16.00 to 16.00 / 0.00 / 0.01dot/step]
2-150-190	Area Mag. Correction	Area 7: Ye	ENG*	[-16.00 to 16.00 / 0.00 / 0.01dot/step]
2-150-191	Area Mag. Correction	Area 8: Ye	ENG*	[-16.00 to 16.00 / 0.00 / 0.01dot/step]
2-150-192	Area Mag. Correction	Area 9: Ye	ENG*	[-16.00 to 16.00 / 0.00 / 0.01dot/step]
2-150-193	Area Mag. Correction	Area 10: Ye	ENG*	[-16.00 to 16.00 / 0.00 / 0.01dot/step]

3.SP Mode Tables

SP No.	Large Category	Small Category	ENG or CTL	[Min to Max/Init./Step]
2-150-194	Area Mag. Correction	Area 11: Ye	ENG*	[-16.00 to 16.00 / 0.00 / 0.01dot/step]
2-150-195	Area Mag. Correction	Area 12: Ye	ENG*	[-16.00 to 16.00 / 0.00 / 0.01dot/step]
2-152-001	Shad. Correct Setting	Standard Speed: Bk	ENG*	[50.0 to 120.0 / 100.0 / 0.1%/step]
2-152-002	Shad. Correct Setting	Standard Speed: Ma	ENG*	[50.0 to 120.0 / 100.0 / 0.1%/step]
2-152-003	Shad. Correct Setting	Standard Speed: Cy	ENG*	[50.0 to 120.0 / 100.0 / 0.1%/step]
2-152-004	Shad. Correct Setting	Standard Speed: Ye	ENG*	[50.0 to 120.0 / 100.0 / 0.1%/step]
2-152-005	Shad. Correct Setting	Middle Speed: Bk	ENG*	[50.0 to 120.0 / 100.0 / 0.1%/step]
2-152-006	Shad. Correct Setting	Middle Speed: Ma	ENG*	[50.0 to 120.0 / 100.0 / 0.1%/step]
2-152-007	Shad. Correct Setting	Middle Speed: Cy	ENG*	[50.0 to 120.0 / 100.0 / 0.1%/step]
2-152-008	Shad. Correct Setting	Middle Speed: Ye	ENG*	[50.0 to 120.0 / 100.0 / 0.1%/step]
2-152-009	Shad. Correct Setting	Low Speed: Bk	ENG*	[50.0 to 120.0 / 100.0 / 0.1%/step]
2-152-010	Shad. Correct Setting	Low Speed: Ma	ENG*	[50.0 to 120.0 / 100.0 / 0.1%/step]

3.SP Mode Tables

SP No.	Large Category	Small Category	ENG or CTL	[Min to Max/Init./Step]
2-152-011	Shad. Correct Setting	Low Speed: Cy	ENG*	[50.0 to 120.0 / 100.0 / 0.1%/step]
2-152-012	Shad. Correct Setting	Low Speed: Ye	ENG*	[50.0 to 120.0 / 100.0 / 0.1%/step]
2-152-016	Shad. Correct Setting	High Limit	ENG*	[1.0 to 140.0 / 140.0 / 0.1%/step]
2-152-017	Shad. Correct Setting	Low Limit	ENG*	[1.0 to 140.0 / 60.0 / 0.1%/step]
2-154-002	Shad. Correct Setting	Front End Area: Bk: LD1	ENG*	[50.0 to 150.0 / 100.0 / 0.1%/step]
2-154-003	Shad. Correct Setting	Front End Area: Bk: LD2	ENG*	[50.0 to 150.0 / 100.0 / 0.1%/step]
2-154-004	Shad. Correct Setting	Front End Area: Bk: LD3	ENG*	[50.0 to 150.0 / 100.0 / 0.1%/step]
2-154-005	Shad. Correct Setting	Front End Area: Bk: LD4	ENG*	[50.0 to 150.0 / 100.0 / 0.1%/step]
2-154-007	Shad. Correct Setting	Front End Area: Ma: LD1	ENG*	[50.0 to 150.0 / 100.0 / 0.1%/step]
2-154-008	Shad. Correct Setting	Front End Area: Ma: LD2	ENG*	[50.0 to 150.0 / 100.0 / 0.1%/step]
2-154-009	Shad. Correct Setting	Front End Area: Ma: LD3	ENG*	[50.0 to 150.0 / 100.0 / 0.1%/step]
2-154-010	Shad. Correct Setting	Front End Area: Ma: LD4	ENG*	[50.0 to 150.0 / 100.0 / 0.1%/step]

3.SP Mode Tables

SP No.	Large Category	Small Category	ENG or CTL	[Min to Max/Init./Step]
2-154-012	Shad. Correct Setting	Front End Area: Cy: LD1	ENG*	[50.0 to 150.0 / 100.0 / 0.1%/step]
2-154-013	Shad. Correct Setting	Front End Area: Cy: LD2	ENG*	[50.0 to 150.0 / 100.0 / 0.1%/step]
2-154-014	Shad. Correct Setting	Front End Area: Cy: LD3	ENG*	[50.0 to 150.0 / 100.0 / 0.1%/step]
2-154-015	Shad. Correct Setting	Front End Area: Cy: LD4	ENG*	[50.0 to 150.0 / 100.0 / 0.1%/step]
2-154-017	Shad. Correct Setting	Front End Area: Ye: LD1	ENG*	[50.0 to 150.0 / 100.0 / 0.1%/step]
2-154-018	Shad. Correct Setting	Front End Area: Ye: LD2	ENG*	[50.0 to 150.0 / 100.0 / 0.1%/step]
2-154-019	Shad. Correct Setting	Front End Area: Ye: LD3	ENG*	[50.0 to 150.0 / 100.0 / 0.1%/step]
2-154-020	Shad. Correct Setting	Front End Area: Ye: LD4	ENG*	[50.0 to 150.0 / 100.0 / 0.1%/step]
2-160-001	Vertical Line Width	600dpi:Bk	ENG*	[10 to 15 / 15 / 1/step]
2-160-002	Vertical Line Width	600dpi:Ma	ENG*	[10 to 15 / 15 / 1/step]
2-160-003	Vertical Line Width	600dpi:Cy	ENG*	[10 to 15 / 15 / 1/step]
2-160-004	Vertical Line Width	600dpi:Ye	ENG*	[10 to 15 / 15 / 1/step]

3.SP Mode Tables

SP No.	Large Category	Small Category	ENG or CTL	[Min to Max/Init./Step]
2-160-005	Vertical Line Width	1200dpi:Bk	ENG*	[10 to 15 / 15 / 1/step]
2-160-006	Vertical Line Width	1200dpi:Ma	ENG*	[10 to 15 / 15 / 1/step]
2-160-007	Vertical Line Width	1200dpi:Cy	ENG*	[10 to 15 / 15 / 1/step]
2-160-008	Vertical Line Width	1200dpi:Ye	ENG*	[10 to 15 / 15 / 1/step]
2-160-009	Vertical Line Width	600dpi:Indet.:Bk	ENG*	[10 to 15 / 14 / 1/step]
2-160-010	Vertical Line Width	1200dpi:Indet.:Bk	ENG*	[10 to 15 / 15 / 1/step]
2-180-001	Line Pos. Adj. Clear	Color Regist.	ENG	[0 to 1 / 0 / 1/step]
2-180-002	Line Pos. Adj. Clear	Main Scan Length Detection	ENG	[0 to 1 / 0 / 1/step]
2-180-003	Line Pos. Adj. Clear	MUSIC Result	ENG	[0 to 1 / 0 / 1/step]
2-181-003	Line Position Adj. Result	Skew: M	ENG*	[-5000.000 to 5000.000 / 0.000 / 0.001um/step]
2-181-011	Line Position Adj. Result	M. Cor.: Dot: M	ENG*	[-512 to 511 / 0 / 1dot/step]
2-181-	Line Position Adj. Result	M. Cor.: Subdot: M	ENG*	[-1.00 to 1.00 / 0.00 /

3.SP Mode Tables

SP No.	Large Category	Small Category	ENG or CTL	[Min to Max/Init./Step]
012				0.01dot/step]
2-181-013	Line Position Adj. Result	S. Cor.: 1200 Line: Middle: M	ENG*	[-16384 to 16383 / 0 / 1line/step]
2-181-014	Line Position Adj. Result	S. Cor.: 1200 Sub: Middle: M	ENG*	[-2.000 to 2.000 / 0.000 / 0.001line/step]
2-181-015	Line Position Adj. Result	M. Left Mag.: Subdot: M	ENG*	[-32.00 to 32.00 / 0.00 / 0.01dot/step]
2-181-016	Line Position Adj. Result	M. Right Mag.: Subdot: M	ENG*	[-32.00 to 32.00 / 0.00 / 0.01dot/step]
2-181-017	Line Position Adj. Result	S. Cor.: 1200 Line: Standard: M	ENG*	[-16384 to 16383 / 0 / 1line/step]
2-181-018	Line Position Adj. Result	S. Cor.: 1200 Sub: Standard: M	ENG*	[-2.000 to 2.000 / 0.000 / 0.001line/step]
2-181-019	Line Position Adj. Result	S. Cor.: 1200 Line: Low: M	ENG*	[-16384 to 16383 / 0 / 1line/step]
2-181-020	Line Position Adj. Result	S. Cor.: 1200 Sub: Low: M	ENG*	[-2.000 to 2.000 / 0.000 / 0.001line/step]
2-181-021	Line Position Adj. Result	Skew: C	ENG*	[-5000.000 to 5000.000 / 0.000 / 0.001um/step]
2-181-029	Line Position Adj. Result	M. Cor.: Dot: C	ENG*	[-512 to 511 / 0 / 1dot/step]
2-181-030	Line Position Adj. Result	M. Cor.: Subdot: C	ENG*	[-1.00 to 1.00 / 0.00 / 0.01dot/step]

3.SP Mode Tables

SP No.	Large Category	Small Category	ENG or CTL	[Min to Max/Init./Step]
2-181-031	Line Position Adj. Result	S. Cor.: 1200 Line: Middle: C	ENG*	[-16384 to 16383 / 0 / 1line/step]
2-181-032	Line Position Adj. Result	S. Cor.: 1200 Sub: Middle: C	ENG*	[-2.000 to 2.000 / 0.000 / 0.001line/step]
2-181-033	Line Position Adj. Result	C. Left Mag.: Subdot: M	ENG*	[-32.00 to 32.00 / 0.00 / 0.01dot/step]
2-181-034	Line Position Adj. Result	C. Right Mag.: Subdot: M	ENG*	[-32.00 to 32.00 / 0.00 / 0.01dot/step]
2-181-035	Line Position Adj. Result	S. Cor.: 1200 Line: Standard: C	ENG*	[-16384 to 16383 / 0 / 1line/step]
2-181-036	Line Position Adj. Result	S. Cor.: 1200 Sub: Standard: C	ENG*	[-2.000 to 2.000 / 0.000 / 0.001line/step]
2-181-037	Line Position Adj. Result	S. Cor.: 1200 Line: Low: C	ENG*	[-16384 to 16383 / 0 / 1line/step]
2-181-038	Line Position Adj. Result	S. Cor.: 1200 Sub: Low: C	ENG*	[-2.000 to 2.000 / 0.000 / 0.001line/step]
2-181-039	Line Position Adj. Result	Skew: Y	ENG*	[-5000.000 to 5000.000 / 0.000 / 0.001um/step]
2-181-047	Line Position Adj. Result	M. Cor.: Dot: Y	ENG*	[-512 to 511 / 0 / 1dot/step]
2-181-048	Line Position Adj. Result	M. Cor.: Subdot: Y	ENG*	[-1.00 to 1.00 / 0.00 / 0.01dot/step]
2-181-	Line Position Adj. Result	S. Cor.: 1200 Line: Middle: Y	ENG*	[-16384 to 16383 / 0 /

3.SP Mode Tables

SP No.	Large Category	Small Category	ENG or CTL	[Min to Max/Init./Step]
049				1line/step]
2-181-050	Line Position Adj. Result	S. Cor.: 1200 Sub: Middle: Y	ENG*	[-2.000 to 2.000 / 0.000 / 0.001line/step]
2-181-051	Line Position Adj. Result	Y. Left Mag.: Subdot: M	ENG*	[-32.00 to 32.00 / 0.00 / 0.01dot/step]
2-181-052	Line Position Adj. Result	Y. Right Mag.: Subdot: M	ENG*	[-32.00 to 32.00 / 0.00 / 0.01dot/step]
2-181-053	Line Position Adj. Result	S. Cor.: 1200 Line: Standard: Y	ENG*	[-16384 to 16383 / 0 / 1line/step]
2-181-054	Line Position Adj. Result	S. Cor.: 1200 Sub: Standard: Y	ENG*	[-2.000 to 2.000 / 0.000 / 0.001line/step]
2-181-055	Line Position Adj. Result	S. Cor.: 1200 Line: Low: Y	ENG*	[-16384 to 16383 / 0 / 1line/step]
2-181-056	Line Position Adj. Result	S. Cor.: 1200 Sub: Low: Y	ENG*	[-2.000 to 2.000 / 0.000 / 0.001line/step]
2-181-057	Line Position Adj. Result	S. Cor.: 600 Sub	ENG*	[-1.000 to 1.000 / 0.000 / 0.001line/step]
2-181-059	Line Position Adj. Result	S. Cor.: 1200 Sub :High	ENG*	[-2.000 to 2.000 / 0.000 / 0.001line/step]
2-181-060	Line Position Adj. Result	S. Cor.: 1200 Sub :Low	ENG*	[-2.000 to 2.000 / 0.000 / 0.001line/step]
2-181-061	Line Position Adj. Result	S. Cor.: 1200 Sub :Middle	ENG*	[-2.000 to 2.000 / 0.000 / 0.001line/step]
2-	Line Position Adj. Result	M. Cor.: Dot: K	ENG*	[-512 to 511 / 0 /

3.SP Mode Tables

SP No.	Large Category	Small Category	ENG or CTL	[Min to Max/Init./Step]
181-064				1dot/step]
2-181-072	Line Position Adj. Result	LineSift: StandardSpeed: M	ENG*	[0 to 3 / 0 / 1line/step]
2-181-073	Line Position Adj. Result	LineSift: MidSpeed: M	ENG*	[0 to 1 / 0 / 1line/step]
2-181-074	Line Position Adj. Result	LineSift: StandardSpeed: C	ENG*	[0 to 3 / 0 / 1line/step]
2-181-075	Line Position Adj. Result	LineSift: MidSpeed: C	ENG*	[0 to 1 / 0 / 1line/step]
2-181-076	Line Position Adj. Result	LineSift: StandardSpeed: Y	ENG*	[0 to 3 / 0 / 1line/step]
2-181-077	Line Position Adj. Result	LineSift: MidSpeed: Y	ENG*	[0 to 1 / 0 / 1line/step]
2-181-080	Line Position Adj. Result	Detect Diff.: M	ENG*	[-1000.0 to 1000.0 / 0.0 / 0.1/step]
2-181-081	Line Position Adj. Result	Detect Diff.: C	ENG*	[-1000.0 to 1000.0 / 0.0 / 0.1/step]
2-181-082	Line Position Adj. Result	Detect Diff.: Y	ENG*	[-1000.0 to 1000.0 / 0.0 / 0.1/step]
2-182-004	Line Position Adj. Offset	M. Scan: Standard: Dot: M	ENG*	[-512 to 511 / 0 / 1dot/step]
2-182-005	Line Position Adj. Offset	M. Scan: Standard: Subdot: M	ENG*	[-1.00 to 1.00 / 0.00 / 0.01dot/step]

3.SP Mode Tables

SP No.	Large Category	Small Category	ENG or CTL	[Min to Max/Init./Step]
2-182-006	Line Position Adj. Offset	M. Scan: Middle: Dot: M	ENG*	[-512 to 511 / 0 / 1dot/step]
2-182-007	Line Position Adj. Offset	M. Scan: Middle: Subdot: M	ENG*	[-1.00 to 1.00 / 0.00 / 0.01dot/step]
2-182-008	Line Position Adj. Offset	M. Scan: Low: Dot: M	ENG*	[-512 to 511 / 0 / 1dot/step]
2-182-009	Line Position Adj. Offset	M. Scan: Low: Subdot: M	ENG*	[-1.00 to 1.00 / 0.00 / 0.01dot/step]
2-182-010	Line Position Adj. Offset	M. Scan: Standard: Dot: C	ENG*	[-512 to 511 / 0 / 1dot/step]
2-182-011	Line Position Adj. Offset	M. Scan: Standard: Subdot: C	ENG*	[-1.00 to 1.00 / 0.00 / 0.01dot/step]
2-182-012	Line Position Adj. Offset	M. Scan: Middle: Dot: C	ENG*	[-512 to 511 / 0 / 1dot/step]
2-182-013	Line Position Adj. Offset	M. Scan: Middle: Subdot: C	ENG*	[-1.00 to 1.00 / 0.00 / 0.01dot/step]
2-182-014	Line Position Adj. Offset	M. Scan: Low: Dot: C	ENG*	[-512 to 511 / 0 / 1dot/step]
2-182-015	Line Position Adj. Offset	M. Scan: Low: Subdot: C	ENG*	[-1.00 to 1.00 / 0.00 / 0.01dot/step]
2-182-016	Line Position Adj. Offset	M. Scan: Standard: Dot: Y	ENG*	[-512 to 511 / 0 / 1dot/step]
2-182-017	Line Position Adj. Offset	M. Scan: Standard: Subdot: Y	ENG*	[-1.00 to 1.00 / 0.00 / 0.01dot/step]

3.SP Mode Tables

SP No.	Large Category	Small Category	ENG or CTL	[Min to Max/Init./Step]
2-182-018	Line Position Adj. Offset	M. Scan: Middle: Dot: Y	ENG*	[-512 to 511 / 0 / 1dot/step]
2-182-019	Line Position Adj. Offset	M. Scan: Middle: Subdot: Y	ENG*	[-1.00 to 1.00 / 0.00 / 0.01dot/step]
2-182-020	Line Position Adj. Offset	M. Scan: Low: Dot: Y	ENG*	[-512 to 511 / 0 / 1dot/step]
2-182-021	Line Position Adj. Offset	M. Scan: Low: Subdot: Y	ENG*	[-1.00 to 1.00 / 0.00 / 0.01dot/step]
2-182-022	Line Position Adj. Offset	S. Scan: Standard: Line: M	ENG*	[-16384 to 16383 / 0 / 1line/step]
2-182-023	Line Position Adj. Offset	S. Scan: Standard: Subline: M	ENG*	[-1.00 to 1.00 / 0.00 / 0.01line/step]
2-182-024	Line Position Adj. Offset	S. Scan: Middle: Line: M	ENG*	[-16384 to 16383 / 0 / 1line/step]
2-182-025	Line Position Adj. Offset	S. Scan: Middle: Subline: M	ENG*	[-1.00 to 1.00 / 0.00 / 0.01line/step]
2-182-026	Line Position Adj. Offset	S. Scan: Low: Line: M	ENG*	[-16384 to 16383 / 0 / 1line/step]
2-182-027	Line Position Adj. Offset	S. Scan: Low: Subline: M	ENG*	[-1.00 to 1.00 / 0.00 / 0.01line/step]
2-182-028	Line Position Adj. Offset	S. Scan: Standard: Line: C	ENG*	[-16384 to 16383 / 0 / 1line/step]
2-182-029	Line Position Adj. Offset	S. Scan: Standard: Subline: C	ENG*	[-1.00 to 1.00 / 0.00 / 0.01line/step]

3.SP Mode Tables

SP No.	Large Category	Small Category	ENG or CTL	[Min to Max/Init./Step]
2-182-030	Line Position Adj. Offset	S. Scan: Middle: Line: C	ENG*	[-16384 to 16383 / 0 / 1line/step]
2-182-031	Line Position Adj. Offset	S. Scan: Middle: Subline: C	ENG*	[-1.00 to 1.00 / 0.00 / 0.01line/step]
2-182-032	Line Position Adj. Offset	S. Scan: Low: Line: C	ENG*	[-16384 to 16383 / 0 / 1line/step]
2-182-033	Line Position Adj. Offset	S. Scan: Low: Subline: C	ENG*	[-1.00 to 1.00 / 0.00 / 0.01line/step]
2-182-034	Line Position Adj. Offset	S. Scan: Standard: Line: Y	ENG*	[-16384 to 16383 / 0 / 1line/step]
2-182-035	Line Position Adj. Offset	S. Scan: Standard: Subline: Y	ENG*	[-1.00 to 1.00 / 0.00 / 0.01line/step]
2-182-036	Line Position Adj. Offset	S. Scan: Middle: Line: Y	ENG*	[-16384 to 16383 / 0 / 1line/step]
2-182-037	Line Position Adj. Offset	S. Scan: Middle: Subline: Y	ENG*	[-1.00 to 1.00 / 0.00 / 0.01line/step]
2-182-038	Line Position Adj. Offset	S. Scan: Low: Line: Y	ENG*	[-16384 to 16383 / 0 / 1line/step]
2-182-039	Line Position Adj. Offset	S. Scan: Low: Subline: Y	ENG*	[-1.00 to 1.00 / 0.00 / 0.01line/step]
2-182-040	Line Position Adj. Offset	M. Scan: Dot: K	ENG*	[-512 to 511 / 0 / 1dot/step]
2-187-002	Method Select	MUSIC Pattern Length Adj.	ENG*	[-300 to 300 / 0 / 1dot/step]

3.SP Mode Tables

SP No.	Large Category	Small Category	ENG or CTL	[Min to Max/Init./Step]
2-187-003	Method Select	Pattern Width Adj.	ENG*	[-512 to 511 / 0 / 1dot/step]
2-187-004	Method Select	Pattern Interval Adj.	ENG*	[-512 to 511 / 0 / 1dot/step]
2-187-006	Method Select	Unit SHD Adjust	ENG*	[0 to 1 / 0 / 1/step]
2-190-012	Line Position Adj.	SnSErr Range	ENG*	[0 to 3500 / 200 / 1um/step]
2-193-002	MUSIC Condition Set	Page: Job End: BW+FC	ENG*	[0 to 999 / 500 / 1page/step]
2-193-003	MUSIC Condition Set	Page: Job End: FC	ENG*	[0 to 999 / 200 / 1page/step]
2-193-004	MUSIC Condition Set	Page: Interrupt: BW+FC	ENG*	[0 to 999 / 0 / 1page/step]
2-193-005	MUSIC Condition Set	Page: Interrupt: FC	ENG*	[0 to 999 / 0 / 1page/step]
2-193-006	MUSIC Condition Set	Page: Stand-By: BW	ENG*	[0 to 999 / 100 / 1page/step]
2-193-007	MUSIC Condition Set	Page: Stand-By: FC	ENG*	[0 to 999 / 100 / 1page/step]
2-193-008	MUSIC Condition Set	Temp.	ENG*	[0 to 100 / 5 / 1deg/step]
2-193-011	MUSIC Condition Set	Temp. 2	ENG*	[0 to 100 / 5 / 1deg/step]

3.SP Mode Tables

SP No.	Large Category	Small Category	ENG or CTL	[Min to Max/Init./Step]
2-193-013	MUSIC Condition Set	Temp. 3	ENG*	[0 to 100 / 10 / 1deg/step]
2-193-017	MUSIC Condition Set	Skew	ENG*	[0 to 999 / 50 / 1um/step]
2-193-018	MUSIC Condition Set	Page: Low Speed: BW+FC	ENG*	[0 to 999 / 0 / 1page/step]
2-193-019	MUSIC Condition Set	Page: Low Speed: FC	ENG*	[0 to 999 / 0 / 1page/step]
2-193-020	MUSIC Condition Set	Page: Distance: BW+FC	ENG*	[0 to 219 / 51 / 1page/step]
2-193-021	MUSIC Condition Set	Page: Distance: FC	ENG*	[0 to 219 / 51 / 1page/step]
2-193-022	MUSIC Condition Set	Page: Mode i	ENG*	[0 to 999 / 200 / 1page/step]
2-194-001	MUSIC Execution Result	Year	ENG*	[0 to 99 / 0 / 1year/step]
2-194-002	MUSIC Execution Result	Month	ENG*	[1 to 12 / 1 / 1month/step]
2-194-003	MUSIC Execution Result	Day	ENG*	[1 to 31 / 1 / 1day/step]
2-194-004	MUSIC Execution Result	Hour	ENG*	[0 to 23 / 0 / 1hour/step]
2-194-005	MUSIC Execution Result	Minute	ENG*	[0 to 59 / 0 / 1minute/step]

3.SP Mode Tables

SP No.	Large Category	Small Category	ENG or CTL	[Min to Max/Init./Step]
2-194-006	MUSIC Execution Result	Temperature	ENG*	[0 to 100 / 0 / 1deg/step]
2-194-007	MUSIC Execution Result	Execution Result	ENG*	[0 to 1 / 0 / 1/step]
2-194-008	MUSIC Execution Result	Number of Execution	ENG*	[0 to 999999 / 0 / 1times/step]
2-194-009	MUSIC Execution Result	Number of Failure	ENG*	[0 to 999999 / 0 / 1times/step]
2-194-010	MUSIC Execution Result	Error Result: C	ENG*	[0 to 9 / 0 / 1/step]
2-194-011	MUSIC Execution Result	Error Result: M	ENG*	[0 to 9 / 0 / 1/step]
2-194-012	MUSIC Execution Result	Error Result: Y	ENG*	[0 to 9 / 0 / 1/step]
2-194-013	MUSIC Execution Result	Error Result: K	ENG*	[0 to 9 / 0 / 1/step]
2-194-014	MUSIC Execution Result	Temperature 2	ENG*	[-10 to 100 / 0 / 1deg/step]
2-194-020	MUSIC Execution Result	Success:Year	ENG*	[0 to 99 / 0 / 1year/step]
2-194-021	MUSIC Execution Result	Success:Month	ENG*	[1 to 12 / 1 / 1month/step]
2-194-022	MUSIC Execution Result	Success:Day	ENG*	[1 to 31 / 1 / 1day/step]

3.SP Mode Tables

SP No.	Large Category	Small Category	ENG or CTL	[Min to Max/Init./Step]
2-194-023	MUSIC Execution Result	Success:Hour	ENG*	[0 to 23 / 0 / 1hour/step]
2-194-024	MUSIC Execution Result	Success:Minute	ENG*	[0 to 59 / 0 / 1minute/step]
2-194-025	MUSIC Execution Result	MUSIC Mode	ENG*	[0 to 1 / 0 / 1/step]
2-195-001	Realtime MUSIC Condition Set	ON/OFF	ENG*	[0 to 1 / 1 / 1/step]
2-195-002	Realtime MUSIC Condition Set	Page: Interrupt: BW+FC	ENG*	[0 to 999 / 50 / 1page/step]
2-195-004	Realtime MUSIC Condition Set	Temperature 4	ENG*	[0 to 100 / 1 / 1deg/step]
2-220-001	Skew Origin Set	M: Skew Motor	ENG	[0 to 1 / 0 / 0/step]
2-220-002	Skew Origin Set	C: Skew Motor	ENG	[0 to 1 / 0 / 0/step]
2-220-003	Skew Origin Set	Y: Skew Motor	ENG	[0 to 1 / 0 / 0/step]
2-221-001	LD Power: Fixed	K	ENG*	[0 to 217 / 100 / 1%/step]
2-221-002	LD Power: Fixed	C	ENG*	[0 to 217 / 100 / 1%/step]
2-221-003	LD Power: Fixed	M	ENG*	[0 to 217 / 100 / 1%/step]

3.SP Mode Tables

SP No.	Large Category	Small Category	ENG or CTL	[Min to Max/Init./Step]
2-221-004	LD Power: Fixed	Y	ENG*	[0 to 217 / 100 / 1%/step]
2-229-001	Develop DC Vias	Standard Speed: Bk	ENG*	[0 to 800 / 550 / 1-V/step]
2-229-002	Develop DC Vias	Standard Speed: C	ENG*	[0 to 800 / 550 / 1-V/step]
2-229-003	Develop DC Vias	Standard Speed: M	ENG*	[0 to 800 / 550 / 1-V/step]
2-229-004	Develop DC Vias	Standard Speed: Y	ENG*	[0 to 800 / 550 / 1-V/step]
2-229-005	Develop DC Bias	Middle Speed Bk	ENG*	[0 to 800 / 550 / 1-V/step]
2-229-006	Develop DC Bias	Middle Speed C	ENG*	[0 to 800 / 550 / 1-V/step]
2-229-007	Develop DC Bias	Middle Speed M	ENG*	[0 to 800 / 550 / 1-V/step]
2-229-008	Develop DC Bias	Middle Speed Y	ENG*	[0 to 800 / 550 / 1-V/step]
2-229-009	Develop DC Vias	Low Speed: Bk	ENG*	[0 to 800 / 550 / 1-V/step]
2-229-010	Develop DC Vias	Low Speed: C	ENG*	[0 to 800 / 550 / 1-V/step]
2-229-011	Develop DC Vias	Low Speed: M	ENG*	[0 to 800 / 550 / 1-V/step]

3.SP Mode Tables

SP No.	Large Category	Small Category	ENG or CTL	[Min to Max/Init./Step]
2-229-012	Develop DC Vias	Low Speed: Y	ENG*	[0 to 800 / 550 / 1-V/step]
2-241-003	Temperature/Humidity: Display	Exec Interval: Extra Fan Control	ENG*	[1 to 3600 / 10 / 1sec/step]
2-241-004	AIT Temperature	AIT Temperature	ENG	[0.0 to 70.0 / 0.0 / 0.1deg/step]
2-242-001	TS Operation Env. Log	TS<=A-3	ENG	[0 to 99999999 / 0 / 1mm/step]
2-242-002	TS Operation Env. Log	A-3<TS<=A	ENG	[0 to 99999999 / 0 / 1mm/step]
2-242-003	TS Operation Env. Log	A<TS<=A+3	ENG	[0 to 99999999 / 0 / 1mm/step]
2-242-004	TS Operation Env. Log	A+3<TS	ENG	[0 to 99999999 / 0 / 1mm/step]
2-242-100	TS Operation Env. Log	Log Clear	ENG	[0 to 1 / 0 / 1/step]
2-250-001	Interval Downmode	ON/OFF Setting	ENG	[0 to 1 / 1 / 1/step]
2-302-001	Environmental Correction:Trans	Current Environmental Display	ENG	[0 to 0 / 0 / 0/step]
2-302-002	Environmental Correction:Trans	Forced Setting	ENG*	[0 to 6 / 0 / 1/step]
2-302-003	Environmental Correction:Trans	Absolute Humidity:Threshold 1	ENG*	[0.00 to 100.00 / 4.00 / 0.01g/m3/step]

3.SP Mode Tables

SP No.	Large Category	Small Category	ENG or CTL	[Min to Max/Init./Step]
2-302-004	Environmental Correction:Trans	Absolute Humidity:Threshold 2	ENG*	[0.00 to 100.00 / 8.00 / 0.01g/m3/step]
2-302-005	Environmental Correction:Trans	Absolute Humidity:Threshold 3	ENG*	[0.00 to 100.00 / 16.00 / 0.01g/m3/step]
2-302-006	Environmental Correction:Trans	Absolute Humidity:Threshold 4	ENG*	[0.00 to 100.00 / 24.00 / 0.01g/m3/step]
2-302-007	Environmental Correction:Trans	Temperature:Threshold	ENG*	[-5 to 30 / 5 / 1deg/step]
2-303-001	Time-Lapse Correction	Current Div K	ENG*	[0 to 3 / 0 / 1/step]
2-303-002	Time-Lapse Correction	Current Div C	ENG*	[0 to 3 / 0 / 1/step]
2-303-003	Time-Lapse Correction	Current Div M	ENG*	[0 to 3 / 0 / 1/step]
2-303-004	Time-Lapse Correction	Current Div Y	ENG*	[0 to 3 / 0 / 1/step]
2-303-005	Time-Lapse Correction	Correction Threshold 1_Bk	ENG*	[0 to 600000 / 5000 / 10page/step]
2-303-006	Time-Lapse Correction	Correction Threshold 1_Color	ENG*	[0 to 600000 / 5000 / 10page/step]
2-303-007	Time-Lapse Correction	Correction Threshold 2_Bk	ENG*	[0 to 600000 / 20000 / 10page/step]
2-303-008	Time-Lapse Correction	Correction Threshold 2_Color	ENG*	[0 to 600000 / 20000 / 10page/step]

3.SP Mode Tables

SP No.	Large Category	Small Category	ENG or CTL	[Min to Max/Init./Step]
2-303-009	Time-Lapse Correction	Correction Threshold 3_Bk	ENG*	[0 to 600000 / 50000 / 10page/step]
2-303-010	Time-Lapse Correction	Correction Threshold 3_Color	ENG*	[0 to 600000 / 50000 / 10page/step]
2-308-001	Paper Size Correction	Threshold 1	ENG*	[0 to 350 / 297 / 1mm/step]
2-308-002	Paper Size Correction	Threshold 2	ENG*	[0 to 350 / 257 / 1mm/step]
2-308-003	Paper Size Correction	Threshold 3	ENG*	[0 to 350 / 210 / 1mm/step]
2-308-004	Paper Size Correction	Threshold 4	ENG*	[0 to 350 / 148 / 1mm/step]
2-308-005	Paper Size Correction	Threshold 1	ENG*	[0 to 350 / 297 / 1mm/step]
2-308-006	Paper Size Correction	Threshold 2	ENG*	[0 to 350 / 257 / 1mm/step]
2-308-007	Paper Size Correction	Threshold 3	ENG*	[0 to 350 / 210 / 1mm/step]
2-308-008	Paper Size Correction	Threshold 4	ENG*	[0 to 350 / 148 / 1mm/step]
2-311-001	Non Image Area:Bias	Image Transfer	ENG*	[10 to 250 / 100 / 5%/step]
2-311-002	Non Image Area:Bias	Paper Transfer	ENG*	[0 to 230 / 0 / 1-uA/step]

3.SP Mode Tables

SP No.	Large Category	Small Category	ENG or CTL	[Min to Max/Init./Step]
2-311-003	Non Image Area:Bias	Paper Transfer	ENG*	[0 to 2100 / 500 / 10V/step]
2-316-001	Power ON:Bias	Image Transfer	ENG*	[0 to 80 / 5 / 1uA/step]
2-326-001	Transfer Roller CL:Bias	Positive:befor and after JOB	ENG*	[0 to 2100 / 250 / 10V/step]
2-326-002	Transfer Roller CL:Bias	Negative:befor and after JOB	ENG*	[10 to 995 / 100 / 10%/step]
2-326-003	Transfer Roller CL:Bias	Positive:befor and afterProcon	ENG*	[0 to 2100 / 2000 / 10V/step]
2-326-004	Transfer Roller CL:Bias	Negative:befor and afterProcon	ENG*	[10 to 995 / 100 / 10%/step]
2-326-005	Transfer Roller CL:Bias	Positive:prevention	ENG*	[0 to 2100 / 500 / 10V/step]
2-326-011	Transfer Roller CL:Env	Positive:befor and after JOB	ENG*	[1 to 110 / 100 / 1/step]
2-326-013	Transfer Roller CL:Env	Positive:befor and afterProcon	ENG*	[1 to 110 / 100 / 1/step]
2-326-015	Transfer Roller CL:Env	Positive:prevention	ENG*	[1 to 110 / 100 / 1/step]
2-351-001	Common:BW:Bias	Image Transfer:standard	ENG*	IM C6000: [0 to 80 / 57 / 1uA/step] IM C5500: [0 to 80 / 57 / 1uA/step]

3.SP Mode Tables

SP No.	Large Category	Small Category	ENG or CTL	[Min to Max/Init./Step]
				IM C4500: [0 to 80 / 41 / 1uA/step]
2-351-002	Common:BW:Bias	Image Transfer:Middle	ENG	IM C6000: [0 to 80 / 24 / 1uA/step] IM C5500: [0 to 80 / 24 / 1uA/step] IM C4500: [0 to 80 / 24 / 1uA/step]
2-351-003	Common:BW:Bias	Image Transfer:low	ENG	IM C6000: [0 to 80 / 16 / 1uA/step] IM C5500: [0 to 80 / 16 / 1uA/step] IM C4500: [0 to 80 / 16 / 1uA/step]
2-357-001	Common:FC:Bias	ImageTransfer:standard:Bk	ENG*	IM C6000: [0 to 80 / 57 / 1uA/step] IM C5500: [0 to 80 / 57 / 1uA/step] IM C4500: [0 to 80 / 41 / 1uA/step]
2-357-002	Common:FC:Bias	ImageTransfer:standard:C	ENG*	IM C6000: [0 to 80 / 57 / 1uA/step] IM C5500: [0 to 80 / 57 / 1uA/step]

3.SP Mode Tables

SP No.	Large Category	Small Category	ENG or CTL	[Min to Max/Init./Step]
				IM C4500: [0 to 80 / 41 / 1uA/step]
2-357-003	Common:FC:Bias	ImageTransfer:standard:M	ENG*	IM C6000: [0 to 80 / 62 / 1uA/step] IM C5500: [0 to 80 / 62 / 1uA/step] IM C4500: [0 to 80 / 45 / 1uA/step]
2-357-004	Common:FC:Bias	ImageTransfer:standard:Y	ENG*	IM C6000: [0 to 80 / 67 / 1uA/step] IM C5500: [0 to 80 / 67 / 1uA/step] IM C4500: [0 to 80 / 49 / 1uA/step]
2-357-005	Common:FC:Bias	ImageTransfer:Middle:Bk	ENG	IM C6000: [0 to 80 / 24 / 1uA/step] IM C5500: [0 to 80 / 24 / 1uA/step] IM C4500: [0 to 80 / 24 / 1uA/step]
2-357-006	Common:FC:Bias	ImageTransfer:Middle:C	ENG	IM C6000: [0 to 80 / 24 / 1uA/step] IM C5500: [0 to 80 / 24 / 1uA/step]

3.SP Mode Tables

SP No.	Large Category	Small Category	ENG or CTL	[Min to Max/Init./Step]
				IM C4500: [0 to 80 / 24 / 1uA/step]
2-357-007	Common:FC:Bias	ImageTransfer:Middle:M	ENG	IM C6000: [0 to 80 / 26 / 1uA/step] IM C5500: [0 to 80 / 26 / 1uA/step] IM C4500: [0 to 80 / 26 / 1uA/step]
2-357-008	Common:FC:Bias	ImageTransfer:Middle:Y	ENG	IM C6000: [0 to 80 / 28 / 1uA/step] IM C5500: [0 to 80 / 28 / 1uA/step] IM C4500: [0 to 80 / 28 / 1uA/step]
2-357-009	Common:FC:Bias	Image Transfer:low:Bk	ENG	IM C6000: [0 to 80 / 16 / 1uA/step] IM C5500: [0 to 80 / 16 / 1uA/step] IM C4500: [0 to 80 / 16 / 1uA/step]
2-357-010	Common:FC:Bias	Image Transfer:low:C	ENG	IM C6000: [0 to 80 / 16 / 1uA/step] IM C5500: [0 to 80 / 16 / 1uA/step]

3.SP Mode Tables

SP No.	Large Category	Small Category	ENG or CTL	[Min to Max/Init./Step]
				IM C4500: [0 to 80 / 16 / 1uA/step]
2-357-011	Common:FC:Bias	Image Transfer:low:M	ENG	IM C6000: [0 to 80 / 18 / 1uA/step] IM C5500: [0 to 80 / 18 / 1uA/step] IM C4500: [0 to 80 / 18 / 1uA/step]
2-357-012	Common:FC:Bias	Image Transfer:low:Y	ENG	IM C6000: [0 to 80 / 19 / 1uA/step] IM C5500: [0 to 80 / 19 / 1uA/step] IM C4500: [0 to 80 / 19 / 1uA/step]
2-358-001	TC adjust Process Control:Bias	ImageTransfer:standard:FC:Bk	ENG*	IM C6000: [0 to 80 / 57 / 1uA/step] IM C5500: [0 to 80 / 57 / 1uA/step] IM C4500: [0 to 80 / 41 / 1uA/step]
2-358-002	TC adjust Process Control:Bias	ImageTransfer:standard:FC:C	ENG*	IM C6000: [0 to 80 / 57 / 1uA/step] IM C5500: [0 to 80 / 57 / 1uA/step]

3.SP Mode Tables

SP No.	Large Category	Small Category	ENG or CTL	[Min to Max/Init./Step]
				IM C4500: [0 to 80 / 41 / 1uA/step]
2-358-003	TC adjust Process Control:Bias	ImageTransfer:standard:FC:M	ENG*	IM C6000: [0 to 80 / 62 / 1uA/step] IM C5500: [0 to 80 / 62 / 1uA/step] IM C4500: [0 to 80 / 45 / 1uA/step]
2-358-004	TC adjust Process Control:Bias	ImageTransfer:standard:FC:Y	ENG*	IM C6000: [0 to 80 / 67 / 1uA/step] IM C5500: [0 to 80 / 67 / 1uA/step] IM C4500: [0 to 80 / 49 / 1uA/step]
2-358-005	TC adjust Process Control:Bias	ImageTransfer:standard:Bk:Bk	ENG*	IM C6000: [0 to 80 / 57 / 1uA/step] IM C5500: [0 to 80 / 57 / 1uA/step] IM C4500: [0 to 80 / 41 / 1uA/step]
2-360-001	Common:BW:Env.CorrectionTable	Image Transfer:standard	ENG*	[1 to 110 / 2 / 1/step]
2-360-002	Common:BW:Env.CorrectionTable	Image Transfer:Middle	ENG	[1 to 110 / 2 / 1/step]

3.SP Mode Tables

SP No.	Large Category	Small Category	ENG or CTL	[Min to Max/Init./Step]
2-360-003	Common:BW:Env.CorrectionTable	Image Transfer:low	ENG	[1 to 110 / 2 / 1/step]
2-360-004	Common:FC:Env.CorrectionTable	ImageTransfer:standard:Bk	ENG*	[1 to 110 / 1 / 1/step]
2-360-005	Common:FC:Env.CorrectionTable	ImageTransfer:standard:C	ENG*	[1 to 110 / 2 / 1/step]
2-360-006	Common:FC:Env.CorrectionTable	ImageTransfer:standard:M	ENG*	[1 to 110 / 3 / 1/step]
2-360-007	Common:FC:Env.CorrectionTable	ImageTransfer:standard:Y	ENG*	[1 to 110 / 4 / 1/step]
2-360-008	Common:FC:Env.CorrectionTable	ImageTransfer:Middle:Bk	ENG	[1 to 110 / 1 / 1/step]
2-360-009	Common:FC:Env.CorrectionTable	ImageTransfer:Middle:C	ENG	[1 to 110 / 2 / 1/step]
2-360-010	Common:FC:Env.CorrectionTable	ImageTransfer:Middle:M	ENG	[1 to 110 / 3 / 1/step]
2-360-011	Common:FC:Env.CorrectionTable	ImageTransfer:Middle:Y	ENG	[1 to 110 / 4 / 1/step]
2-360-012	Common:FC:Env.CorrectionTable	Image Transfer:low:Bk	ENG	[1 to 110 / 1 / 1/step]
2-360-013	Common:FC:Env.CorrectionTable	Image Transfer:low:C	ENG	[1 to 110 / 2 / 1/step]
2-360-014	Common:FC:Env.CorrectionTable	Image Transfer:low:M	ENG	[1 to 110 / 3 / 1/step]

3.SP Mode Tables

SP No.	Large Category	Small Category	ENG or CTL	[Min to Max/Init./Step]
2-360-015	Common:FC:Env.CorrectionTable	Image Transfer:low:Y	ENG	[1 to 110 / 4 / 1/step]
2-361-001	Time-Lapse Correction: Div 1	Standard Speed: Bk	ENG*	[1 to 60 / 2 / 1/step]
2-361-002	Time-Lapse Correction: Div 1	Mid Speed: Bk	ENG	[1 to 60 / 2 / 1/step]
2-361-003	Time-Lapse Correction: Div 1	Low Speed: Bk	ENG	[1 to 60 / 2 / 1/step]
2-361-004	Time-Lapse Correction: Div 1	Standard Speed: FC: K	ENG*	[1 to 60 / 1 / 1/step]
2-361-005	Time-Lapse Correction: Div 1	Standard Speed: FC: C	ENG*	[1 to 60 / 1 / 1/step]
2-361-006	Time-Lapse Correction: Div 1	Standard Speed: FC: M	ENG*	[1 to 60 / 1 / 1/step]
2-361-007	Time-Lapse Correction: Div 1	Standard Speed: FC: Y	ENG*	[1 to 60 / 1 / 1/step]
2-361-008	Time-Lapse Correction: Div 1	Mid Speed: FC: K	ENG	[1 to 60 / 1 / 1/step]
2-361-009	Time-Lapse Correction: Div 1	Mid Speed: FC: C	ENG	[1 to 60 / 1 / 1/step]
2-361-010	Time-Lapse Correction: Div 1	Mid Speed: FC: M	ENG	[1 to 60 / 1 / 1/step]
2-361-011	Time-Lapse Correction: Div 1	Mid Speed: FC: Y	ENG	[1 to 60 / 1 / 1/step]

3.SP Mode Tables

SP No.	Large Category	Small Category	ENG or CTL	[Min to Max/Init./Step]
2-361-012	Time-Lapse Correction: Div 1	Low Speed: FC: K	ENG	[1 to 60 / 1 / 1/step]
2-361-013	Time-Lapse Correction: Div 1	Low Speed: FC: C	ENG	[1 to 60 / 1 / 1/step]
2-361-014	Time-Lapse Correction: Div 1	Low Speed: FC: M	ENG	[1 to 60 / 1 / 1/step]
2-361-015	Time-Lapse Correction: Div 1	Low Speed: FC: Y	ENG	[1 to 60 / 1 / 1/step]
2-362-001	Time-Lapse Correction: Div 2	Standard Speed: Bk	ENG*	[1 to 60 / 3 / 1/step]
2-362-002	Time-Lapse Correction: Div 2	Mid Speed: Bk	ENG	[1 to 60 / 3 / 1/step]
2-362-003	Time-Lapse Correction: Div 2	Low Speed: Bk	ENG	[1 to 60 / 3 / 1/step]
2-362-004	Time-Lapse Correction: Div 2	Standard Speed: FC: K	ENG*	[1 to 60 / 1 / 1/step]
2-362-005	Time-Lapse Correction: Div 2	Standard Speed: FC: C	ENG*	[1 to 60 / 1 / 1/step]
2-362-006	Time-Lapse Correction: Div 2	Standard Speed: FC: M	ENG*	[1 to 60 / 1 / 1/step]
2-362-007	Time-Lapse Correction: Div 2	Standard Speed: FC: Y	ENG*	[1 to 60 / 1 / 1/step]
2-362-008	Time-Lapse Correction: Div 2	Mid Speed: FC: K	ENG	[1 to 60 / 1 / 1/step]

3.SP Mode Tables

SP No.	Large Category	Small Category	ENG or CTL	[Min to Max/Init./Step]
2-362-009	Time-Lapse Correction: Div 2	Mid Speed: FC: C	ENG	[1 to 60 / 1 / 1/step]
2-362-010	Time-Lapse Correction: Div 2	Mid Speed: FC: M	ENG	[1 to 60 / 1 / 1/step]
2-362-011	Time-Lapse Correction: Div 2	Mid Speed: FC: Y	ENG	[1 to 60 / 1 / 1/step]
2-362-012	Time-Lapse Correction: Div 2	Low Speed: FC: K	ENG	[1 to 60 / 1 / 1/step]
2-362-013	Time-Lapse Correction: Div 2	Low Speed: FC: C	ENG	[1 to 60 / 1 / 1/step]
2-362-014	Time-Lapse Correction: Div 2	Low Speed: FC: M	ENG	[1 to 60 / 1 / 1/step]
2-362-015	Time-Lapse Correction: Div 2	Low Speed: FC: Y	ENG	[1 to 60 / 1 / 1/step]
2-363-001	Time-Lapse Correction: Div 3	Standard Speed: Bk	ENG*	[1 to 60 / 4 / 1/step]
2-363-002	Time-Lapse Correction: Div 3	Mid Speed: Bk	ENG	[1 to 60 / 4 / 1/step]
2-363-003	Time-Lapse Correction: Div 3	Low Speed: Bk	ENG	[1 to 60 / 4 / 1/step]
2-363-004	Time-Lapse Correction: Div 3	Standard Speed: FC: K	ENG*	[1 to 60 / 1 / 1/step]
2-363-005	Time-Lapse Correction: Div 3	Standard Speed: FC: C	ENG*	[1 to 60 / 1 / 1/step]

3.SP Mode Tables

SP No.	Large Category	Small Category	ENG or CTL	[Min to Max/Init./Step]
2-363-006	Time-Lapse Correction: Div 3	Standard Speed: FC: M	ENG*	[1 to 60 / 1 / 1/step]
2-363-007	Time-Lapse Correction: Div 3	Standard Speed: FC: Y	ENG*	[1 to 60 / 1 / 1/step]
2-363-008	Time-Lapse Correction: Div 3	Mid Speed: FC: K	ENG	[1 to 60 / 1 / 1/step]
2-363-009	Time-Lapse Correction: Div 3	Mid Speed: FC: C	ENG	[1 to 60 / 1 / 1/step]
2-363-010	Time-Lapse Correction: Div 3	Mid Speed: FC: M	ENG	[1 to 60 / 1 / 1/step]
2-363-011	Time-Lapse Correction: Div 3	Mid Speed: FC: Y	ENG	[1 to 60 / 1 / 1/step]
2-363-012	Time-Lapse Correction: Div 3	Low Speed: FC: K	ENG	[1 to 60 / 1 / 1/step]
2-363-013	Time-Lapse Correction: Div 3	Low Speed: FC: C	ENG	[1 to 60 / 1 / 1/step]
2-363-014	Time-Lapse Correction: Div 3	Low Speed: FC: M	ENG	[1 to 60 / 1 / 1/step]
2-363-015	Time-Lapse Correction: Div 3	Low Speed: FC: Y	ENG	[1 to 60 / 1 / 1/step]
2-400-001	Paper Transfer Roller Settings	Width of Paper Transfer Roller	ENG*	[0 to 1 / 0 / 1/step]
2-400-002	Paper Transfer Roller Settings	Detatch timing in waiting	ENG*	[0 to 600 / 240 / 1min/step]

3.SP Mode Tables

SP No.	Large Category	Small Category	ENG or CTL	[Min to Max/Init./Step]
2-403-001	Plain1:Bias:BW	PaperTransfer:standard:1side	ENG	IM C6000: [0 to 250 / 38 / 1-uA/step] IM C5500: [0 to 250 / 38 / 1-uA/step] IM C4500: [0 to 250 / 28 / 1-uA/step]
2-403-002	Plain1:Bias:BW	PaperTransfer:standard:2side	ENG	IM C6000: [0 to 250 / 38 / 1-uA/step] IM C5500: [0 to 250 / 38 / 1-uA/step] IM C4500: [0 to 250 / 28 / 1-uA/step]
2-403-003	Plain1:Bias:BW	PaperTransfer:low:1side	ENG	IM C6000: [0 to 250 / 11 / 1-uA/step] IM C5500: [0 to 250 / 11 / 1-uA/step] IM C4500: [0 to 250 / 11 / 1-uA/step]
2-403-004	Plain1:Bias:BW	PaperTransfer:low:2side	ENG	IM C6000: [0 to 250 / 11 / 1-uA/step] IM C5500: [0 to 250 / 11 / 1-uA/step] IM C4500: [0 to 250 / 11 / 1-uA/step]

3.SP Mode Tables

SP No.	Large Category	Small Category	ENG or CTL	[Min to Max/Init./Step]
2-407-001	Plain1:Bias:FC	PaperTransfer:standard:1side	ENG*	IM C6000: [0 to 250 / 50 / 1-uA/step] IM C5500: [0 to 250 / 50 / 1-uA/step] IM C4500: [0 to 250 / 36 / 1-uA/step]
2-407-002	Plain1:Bias:FC	PaperTransfer:standard:2side	ENG	IM C6000: [0 to 250 / 50 / 1-uA/step] IM C5500: [0 to 250 / 50 / 1-uA/step] IM C4500: [0 to 250 / 36 / 1-uA/step]
2-407-003	Plain1:Bias:FC	PaperTransfer:low:1side	ENG	IM C6000: [0 to 250 / 14 / 1-uA/step] IM C5500: [0 to 250 / 14 / 1-uA/step] IM C4500: [0 to 250 / 14 / 1-uA/step]
2-407-004	Plain1:Bias:FC	PaperTransfer:low:2side	ENG	IM C6000: [0 to 250 / 14 / 1-uA/step] IM C5500: [0 to 250 / 14 / 1-uA/step] IM C4500: [0 to 250 / 14 / 1-uA/step]

SP2-XXX (Drum)-2

SP No.	Large Category	Small Category	ENG or CTL	[Min to Max/Init./Step]
2-411-001	Plain1:SizeCorrection:BW	PaperTransfer:Standard:1Sid:S1	ENG	[100 to 995 / 100 / 1%/step]
2-411-002	Plain1:SizeCorrection:BW	PaperTransfer:Standard:2Sid:S1	ENG	[100 to 995 / 100 / 1%/step]
2-411-003	Plain1:SizeCorrection:BW	PaperTransfer:Low:1Side:S1	ENG	[100 to 995 / 100 / 1%/step]
2-411-004	Plain1:SizeCorrection:BW	PaperTransfer:Low:2Side:S1	ENG	[100 to 995 / 100 / 1%/step]
2-411-005	Plain1:SizeCorrection:BW	PaperTransfer:Standard:1Sid:S2	ENG	[100 to 995 / 100 / 1%/step]
2-411-006	Plain1:SizeCorrection:BW	PaperTransfer:Standard:2Sid:S2	ENG	[100 to 995 / 105 / 1%/step]
2-411-007	Plain1:SizeCorrection:BW	PaperTransfer:Low:1Side:S2	ENG	[100 to 995 / 100 / 1%/step]
2-411-008	Plain1:SizeCorrection:BW	PaperTransfer:Low:2Side:S2	ENG	[100 to 995 / 105 / 1%/step]
2-411-009	Plain1:SizeCorrection:BW	PaperTransfer:Standard:1Sid:S3	ENG	[100 to 995 / 105 / 1%/step]
2-411-010	Plain1:SizeCorrection:BW	PaperTransfer:Standard:2Sid:S3	ENG	[100 to 995 / 118 / 1%/step]
2-411-011	Plain1:SizeCorrection:BW	PaperTransfer:Low:1Side:S3	ENG	[100 to 995 / 105 / 1%/step]
2-	Plain1:SizeCorrection:BW	PaperTransfer:Low:2Side:S3	ENG	[100 to 995 /

3.SP Mode Tables

SP No.	Large Category	Small Category	ENG or CTL	[Min to Max/Init./Step]
411-012				118 / 1%/step]
2-411-013	Plain1:SizeCorrection:BW	PaperTransfer:Standard:1Sid:S4	ENG	[100 to 995 / 118 / 1%/step]
2-411-014	Plain1:SizeCorrection:BW	PaperTransfer:Standard:2Sid:S4	ENG	[100 to 995 / 131 / 1%/step]
2-411-015	Plain1:SizeCorrection:BW	PaperTransfer:Low:1Side:S4	ENG	[100 to 995 / 118 / 1%/step]
2-411-016	Plain1:SizeCorrection:BW	PaperTransfer:Low:2Side:S4	ENG	[100 to 995 / 131 / 1%/step]
2-411-017	Plain1:SizeCorrection:BW	PaperTransfer:Standard:1Sid:S5	ENG	[100 to 995 / 132 / 1%/step]
2-411-018	Plain1:SizeCorrection:BW	PaperTransfer:Standard:2Sid:S5	ENG	[100 to 995 / 184 / 1%/step]
2-411-019	Plain1:SizeCorrection:BW	PaperTransfer:Low:1Side:S5	ENG	[100 to 995 / 132 / 1%/step]
2-411-020	Plain1:SizeCorrection:BW	PaperTransfer:Low:2Side:S5	ENG	[100 to 995 / 184 / 1%/step]
2-411-021	Plain1:SizeCorrection:BW	Wide Roller:PaperTransfer:Standard:1Sid:S1	ENG	[100 to 995 / 100 / 1%/step]
2-411-022	Plain1:SizeCorrection:BW	Wide Roller:PaperTransfer:Standard:2Sid:S1	ENG	[100 to 995 / 100 / 1%/step]
2-411-023	Plain1:SizeCorrection:BW	Wide Roller:PaperTransfer:Low:1Side:S1	ENG	[100 to 995 / 100 / 1%/step]

3.SP Mode Tables

SP No.	Large Category	Small Category	ENG or CTL	[Min to Max/Init./Step]
2-411-024	Plain1:SizeCorrection:BW	Wide Roller:PaperTransfer:Low:2Side:S1	ENG	[100 to 995 / 100 / 1%/step]
2-411-025	Plain1:SizeCorrection:BW	Wide Roller:PaperTransfer:Standard:1Sid:S2	ENG	[100 to 995 / 100 / 1%/step]
2-411-026	Plain1:SizeCorrection:BW	Wide Roller:PaperTransfer:Standard:2Sid:S2	ENG	[100 to 995 / 105 / 1%/step]
2-411-027	Plain1:SizeCorrection:BW	Wide Roller:PaperTransfer:Low:1Side:S2	ENG	[100 to 995 / 100 / 1%/step]
2-411-028	Plain1:SizeCorrection:BW	Wide Roller:PaperTransfer:Low:2Side:S2	ENG	[100 to 995 / 105 / 1%/step]
2-411-029	Plain1:SizeCorrection:BW	Wide Roller:PaperTransfer:Standard:1Sid:S3	ENG	[100 to 995 / 105 / 1%/step]
2-411-030	Plain1:SizeCorrection:BW	Wide Roller:PaperTransfer:Standard:2Sid:S3	ENG	[100 to 995 / 118 / 1%/step]
2-411-031	Plain1:SizeCorrection:BW	Wide Roller:PaperTransfer:Low:1Side:S3	ENG	[100 to 995 / 105 / 1%/step]
2-411-032	Plain1:SizeCorrection:BW	Wide Roller:PaperTransfer:Low:2Side:S3	ENG	[100 to 995 / 118 / 1%/step]
2-411-033	Plain1:SizeCorrection:BW	Wide Roller:PaperTransfer:Standard:1Sid:S4	ENG	[100 to 995 / 118 / 1%/step]
2-411-034	Plain1:SizeCorrection:BW	Wide Roller:PaperTransfer:Standard:2Sid:S4	ENG	[100 to 995 / 131 / 1%/step]
2-411-035	Plain1:SizeCorrection:BW	Wide Roller:PaperTransfer:Low:1Side:S4	ENG	[100 to 995 / 118 / 1%/step]

3.SP Mode Tables

SP No.	Large Category	Small Category	ENG or CTL	[Min to Max/Init./Step]
2-411-036	Plain1:SizeCorrection:BW	Wide Roller:PaperTransfer:Low:2Side:S4	ENG	[100 to 995 / 131 / 1%/step]
2-411-037	Plain1:SizeCorrection:BW	Wide Roller:PaperTransfer:Standard:1Sid:S5	ENG	[100 to 995 / 132 / 1%/step]
2-411-038	Plain1:SizeCorrection:BW	Wide Roller:PaperTransfer:Standard:2Sid:S5	ENG	[100 to 995 / 184 / 1%/step]
2-411-039	Plain1:SizeCorrection:BW	Wide Roller:PaperTransfer:Low:1Side:S5	ENG	[100 to 995 / 132 / 1%/step]
2-411-040	Plain1:SizeCorrection:BW	Wide Roller:PaperTransfer:Low:2Side:S5	ENG	[100 to 995 / 184 / 1%/step]
2-412-001	Plain1:SizeCorrection:FC	PaperTransfer:Standard:1Sid:S1	ENG	[100 to 995 / 100 / 1%/step]
2-412-002	Plain1:SizeCorrection:FC	PaperTransfer:Standard:2Sid:S1	ENG	[100 to 995 / 100 / 1%/step]
2-412-003	Plain1:SizeCorrection:FC	PaperTransfer:Low:1Side:S1	ENG	[100 to 995 / 100 / 1%/step]
2-412-004	Plain1:SizeCorrection:FC	PaperTransfer:Low:2Side:S1	ENG	[100 to 995 / 100 / 1%/step]
2-412-005	Plain1:SizeCorrection:FC	PaperTransfer:Standard:1Sid:S2	ENG	[100 to 995 / 120 / 1%/step]
2-	Plain1:SizeCorrection:FC	PaperTransfer:Standard:2Sid:S2	ENG	[100 to 995 /

3.SP Mode Tables

SP No.	Large Category	Small Category	ENG or CTL	[Min to Max/Init./Step]
412 - 006				140 / 1%/step]
2- 412 - 007	Plain1:SizeCorrection:FC	PaperTransfer:Low:1Side:S2	ENG	[100 to 995 / 120 / 1%/step]
2- 412 - 008	Plain1:SizeCorrection:FC	PaperTransfer:Low:2Side:S2	ENG	[100 to 995 / 140 / 1%/step]
2- 412 - 009	Plain1:SizeCorrection:FC	PaperTransfer:Standard:1Sid:S3	ENG	[100 to 995 / 118 / 1%/step]
2- 412 - 010	Plain1:SizeCorrection:FC	PaperTransfer:Standard:2Sid:S3	ENG	[100 to 995 / 180 / 1%/step]
2- 412 -011	Plain1:SizeCorrection:FC	PaperTransfer:Low:1Side:S3	ENG	[100 to 995 / 118 / 1%/step]
2- 412 - 012	Plain1:SizeCorrection:FC	PaperTransfer:Low:2Side:S3	ENG	[100 to 995 / 180 / 1%/step]
2- 412 - 013	Plain1:SizeCorrection:FC	PaperTransfer:Standard:1Sid:S4	ENG	[100 to 995 / 130 / 1%/step]
2- 412 - 014	Plain1:SizeCorrection:FC	PaperTransfer:Standard:2Sid:S4	ENG	[100 to 995 / 200 / 1%/step]
2- 412	Plain1:SizeCorrection:FC	PaperTransfer:Low:1Side:S4	ENG	[100 to 995 / 130 /

3.SP Mode Tables

SP No.	Large Category	Small Category	ENG or CTL	[Min to Max/Init./Step]
- 015				1%/step]
2- 412 - 016	Plain1:SizeCorrection:FC	PaperTransfer:Low:2Side:S4	ENG	[100 to 995 / 200 / 1%/step]
2- 412 - 017	Plain1:SizeCorrection:FC	PaperTransfer:Standard:1Sid:S5	ENG	[100 to 995 / 140 / 1%/step]
2- 412 - 018	Plain1:SizeCorrection:FC	PaperTransfer:Standard:2Sid:S5	ENG	[100 to 995 / 240 / 1%/step]
2- 412 - 019	Plain1:SizeCorrection:FC	PaperTransfer:Low:1Side:S5	ENG	[100 to 995 / 140 / 1%/step]
2- 412 - 020	Plain1:SizeCorrection:FC	PaperTransfer:Low:2Side:S5	ENG	[100 to 995 / 240 / 1%/step]
2- 412 - 021	Plain1:SizeCorrection:FC	Wide Roller:PaperTransfer:Standard:1Sid:S 1	ENG	[100 to 995 / 100 / 1%/step]
2- 412 - 022	Plain1:SizeCorrection:FC	Wide Roller:PaperTransfer:Standard:2Sid:S 1	ENG	[100 to 995 / 100 / 1%/step]
2- 412 - 023	Plain1:SizeCorrection:FC	Wide Roller:PaperTransfer:Low:1Side:S1	ENG	[100 to 995 / 100 / 1%/step]
2- 412	Plain1:SizeCorrection:FC	Wide Roller:PaperTransfer:Low:2Side:S1	ENG	[100 to 995 / 100 /

3.SP Mode Tables

SP No.	Large Category	Small Category	ENG or CTL	[Min to Max/Init./Step]
- 024				1%/step]
2- 412 - 025	Plain1:SizeCorrection:FC	Wide Roller:PaperTransfer:Standard:1Sid:S 2	ENG	[100 to 995 / 120 / 1%/step]
2- 412 - 026	Plain1:SizeCorrection:FC	Wide Roller:PaperTransfer:Standard:2Sid:S 2	ENG	[100 to 995 / 140 / 1%/step]
2- 412 - 027	Plain1:SizeCorrection:FC	Wide Roller:PaperTransfer:Low:1Side:S2	ENG	[100 to 995 / 120 / 1%/step]
2- 412 - 028	Plain1:SizeCorrection:FC	Wide Roller:PaperTransfer:Low:2Side:S2	ENG	[100 to 995 / 140 / 1%/step]
2- 412 - 029	Plain1:SizeCorrection:FC	Wide Roller:PaperTransfer:Standard:1Sid:S 3	ENG	[100 to 995 / 118 / 1%/step]
2- 412 - 030	Plain1:SizeCorrection:FC	Wide Roller:PaperTransfer:Standard:2Sid:S 3	ENG	[100 to 995 / 180 / 1%/step]
2- 412 - 031	Plain1:SizeCorrection:FC	Wide Roller:PaperTransfer:Low:1Side:S3	ENG	[100 to 995 / 118 / 1%/step]
2- 412 - 032	Plain1:SizeCorrection:FC	Wide Roller:PaperTransfer:Low:2Side:S3	ENG	[100 to 995 / 180 / 1%/step]
2- 412	Plain1:SizeCorrection:FC	Wide Roller:PaperTransfer:Standard:1Sid:S	ENG	[100 to 995 / 130 /

3.SP Mode Tables

SP No.	Large Category	Small Category	ENG or CTL	[Min to Max/Init./Step]
- 033		4		1%/step]
2- 412 - 034	Plain1:SizeCorrection:FC	Wide Roller:PaperTransfer:Standard:2Sid:S 4	ENG	[100 to 995 / 200 / 1%/step]
2- 412 - 035	Plain1:SizeCorrection:FC	Wide Roller:PaperTransfer:Low:1Side:S4	ENG	[100 to 995 / 130 / 1%/step]
2- 412 - 036	Plain1:SizeCorrection:FC	Wide Roller:PaperTransfer:Low:2Side:S4	ENG	[100 to 995 / 200 / 1%/step]
2- 412 - 037	Plain1:SizeCorrection:FC	Wide Roller:PaperTransfer:Standard:1Sid:S 5	ENG	[100 to 995 / 140 / 1%/step]
2- 412 - 038	Plain1:SizeCorrection:FC	Wide Roller:PaperTransfer:Standard:2Sid:S 5	ENG	[100 to 995 / 240 / 1%/step]
2- 412 - 039	Plain1:SizeCorrection:FC	Wide Roller:PaperTransfer:Low:1Side:S5	ENG	[100 to 995 / 140 / 1%/step]
2- 412 - 040	Plain1:SizeCorrection:FC	Wide Roller:PaperTransfer:Low:2Side:S5	ENG	[100 to 995 / 240 / 1%/step]
2- 413 - 001	Plain1:Size-Env.Correct:BW	PaperTransfer:Standard:1Sid:S1	ENG	[1 to 110 / 10 / 1/step]
2- 413	Plain1:Size-Env.Correct:BW	PaperTransfer:Standard:2Sid:S1	ENG	[1 to 110 / 15 / 1/step]

3.SP Mode Tables

SP No.	Large Category	Small Category	ENG or CTL	[Min to Max/Init./Step]
-002				
2-413-003	Plain1:Size-Env.Correct:BW	PaperTransfer:Low:1Side:S1	ENG	[1 to 110 / 10 / 1/step]
2-413-004	Plain1:Size-Env.Correct:BW	PaperTransfer:Low:2Side:S1	ENG	[1 to 110 / 15 / 1/step]
2-413-005	Plain1:Size-Env.Correct:BW	PaperTransfer:Standard:1Sid:S2	ENG	[1 to 110 / 11 / 1/step]
2-413-006	Plain1:Size-Env.Correct:BW	PaperTransfer:Standard:2Sid:S2	ENG	[1 to 110 / 16 / 1/step]
2-413-007	Plain1:Size-Env.Correct:BW	PaperTransfer:Low:1Side:S2	ENG	[1 to 110 / 11 / 1/step]
2-413-008	Plain1:Size-Env.Correct:BW	PaperTransfer:Low:2Side:S2	ENG	[1 to 110 / 16 / 1/step]
2-413-009	Plain1:Size-Env.Correct:BW	PaperTransfer:Standard:1Sid:S3	ENG	[1 to 110 / 12 / 1/step]
2-413-010	Plain1:Size-Env.Correct:BW	PaperTransfer:Standard:2Sid:S3	ENG	[1 to 110 / 17 / 1/step]
2-413	Plain1:Size-Env.Correct:BW	PaperTransfer:Low:1Side:S3	ENG	[1 to 110 / 12 / 1/step]

3.SP Mode Tables

SP No.	Large Category	Small Category	ENG or CTL	[Min to Max/Init./Step]
-011				
2-413-012	Plain1:Size-Env.Correct:BW	PaperTransfer:Low:2Side:S3	ENG	[1 to 110 / 17 / 1/step]
2-413-013	Plain1:Size-Env.Correct:BW	PaperTransfer:Standard:1Sid:S4	ENG	[1 to 110 / 13 / 1/step]
2-413-014	Plain1:Size-Env.Correct:BW	PaperTransfer:Standard:2Sid:S4	ENG	[1 to 110 / 18 / 1/step]
2-413-015	Plain1:Size-Env.Correct:BW	PaperTransfer:Low:1Side:S4	ENG	[1 to 110 / 13 / 1/step]
2-413-016	Plain1:Size-Env.Correct:BW	PaperTransfer:Low:2Side:S4	ENG	[1 to 110 / 18 / 1/step]
2-413-017	Plain1:Size-Env.Correct:BW	PaperTransfer:Standard:1Sid:S5	ENG	[1 to 110 / 14 / 1/step]
2-413-018	Plain1:Size-Env.Correct:BW	PaperTransfer:Standard:2Sid:S5	ENG	[1 to 110 / 19 / 1/step]
2-413-019	Plain1:Size-Env.Correct:BW	PaperTransfer:Low:1Side:S5	ENG	[1 to 110 / 14 / 1/step]
2-413-	Plain1:Size-Env.Correct:BW	PaperTransfer:Low:2Side:S5	ENG	[1 to 110 / 19 / 1/step]

3.SP Mode Tables

SP No.	Large Category	Small Category	ENG or CTL	[Min to Max/Init./Step]
020				
2-413-021	Plain1:Size-Env.Correct:BW	Wide Roller:PaperTransfer:Standard:1Sid:S1	ENG	[1 to 110 / 10 / 1/step]
2-413-022	Plain1:Size-Env.Correct:BW	Wide Roller:PaperTransfer:Standard:2Sid:S1	ENG	[1 to 110 / 15 / 1/step]
2-413-023	Plain1:Size-Env.Correct:BW	Wide Roller:PaperTransfer:Low:1Side:S1	ENG	[1 to 110 / 10 / 1/step]
2-413-024	Plain1:Size-Env.Correct:BW	Wide Roller:PaperTransfer:Low:2Side:S1	ENG	[1 to 110 / 15 / 1/step]
2-413-025	Plain1:Size-Env.Correct:BW	Wide Roller:PaperTransfer:Standard:1Sid:S2	ENG	[1 to 110 / 11 / 1/step]
2-413-026	Plain1:Size-Env.Correct:BW	Wide Roller:PaperTransfer:Standard:2Sid:S2	ENG	[1 to 110 / 16 / 1/step]
2-413-027	Plain1:Size-Env.Correct:BW	Wide Roller:PaperTransfer:Low:1Side:S2	ENG	[1 to 110 / 11 / 1/step]
2-413-028	Plain1:Size-Env.Correct:BW	Wide Roller:PaperTransfer:Low:2Side:S2	ENG	[1 to 110 / 16 / 1/step]
2-413-	Plain1:Size-Env.Correct:BW	Wide Roller:PaperTransfer:Standard:1Sid:S3	ENG	[1 to 110 / 12 / 1/step]

3.SP Mode Tables

SP No.	Large Category	Small Category	ENG or CTL	[Min to Max/Init./Step]
029				
2-413-030	Plain1:Size-Env.Correct:BW	Wide Roller:PaperTransfer:Standard:2Sid:S3	ENG	[1 to 110 / 17 / 1/step]
2-413-031	Plain1:Size-Env.Correct:BW	Wide Roller:PaperTransfer:Low:1Side:S3	ENG	[1 to 110 / 12 / 1/step]
2-413-032	Plain1:Size-Env.Correct:BW	Wide Roller:PaperTransfer:Low:2Side:S3	ENG	[1 to 110 / 17 / 1/step]
2-413-033	Plain1:Size-Env.Correct:BW	Wide Roller:PaperTransfer:Standard:1Sid:S4	ENG	[1 to 110 / 13 / 1/step]
2-413-034	Plain1:Size-Env.Correct:BW	Wide Roller:PaperTransfer:Standard:2Sid:S4	ENG	[1 to 110 / 18 / 1/step]
2-413-035	Plain1:Size-Env.Correct:BW	Wide Roller:PaperTransfer:Low:1Side:S4	ENG	[1 to 110 / 13 / 1/step]
2-413-036	Plain1:Size-Env.Correct:BW	Wide Roller:PaperTransfer:Low:2Side:S4	ENG	[1 to 110 / 18 / 1/step]
2-413-037	Plain1:Size-Env.Correct:BW	Wide Roller:PaperTransfer:Standard:1Sid:S5	ENG	[1 to 110 / 14 / 1/step]
2-413-	Plain1:Size-Env.Correct:BW	Wide Roller:PaperTransfer:Standard:2Sid:S5	ENG	[1 to 110 / 19 / 1/step]

3.SP Mode Tables

SP No.	Large Category	Small Category	ENG or CTL	[Min to Max/Init./Step]
038				
2-413-039	Plain1:Size-Env.Correct:BW	Wide Roller:PaperTransfer:Low:1Side:S5	ENG	[1 to 110 / 14 / 1/step]
2-413-040	Plain1:Size-Env.Correct:BW	Wide Roller:PaperTransfer:Low:2Side:S5	ENG	[1 to 110 / 19 / 1/step]
2-414-001	Plain1:Size-Env.Correct:FC	PaperTransfer:Standard:1Sid:S1	ENG *	[1 to 110 / 20 / 1/step]
2-414-002	Plain1:Size-Env.Correct:FC	PaperTransfer:Standard:2Sid:S1	ENG	[1 to 110 / 25 / 1/step]
2-414-003	Plain1:Size-Env.Correct:FC	PaperTransfer:Low:1Side:S1	ENG	[1 to 110 / 20 / 1/step]
2-414-004	Plain1:Size-Env.Correct:FC	PaperTransfer:Low:2Side:S1	ENG	[1 to 110 / 25 / 1/step]
2-414-005	Plain1:Size-Env.Correct:FC	PaperTransfer:Standard:1Sid:S2	ENG	[1 to 110 / 21 / 1/step]
2-414-006	Plain1:Size-Env.Correct:FC	PaperTransfer:Standard:2Sid:S2	ENG	[1 to 110 / 26 / 1/step]
2-414-	Plain1:Size-Env.Correct:FC	PaperTransfer:Low:1Side:S2	ENG	[1 to 110 / 21 / 1/step]

3.SP Mode Tables

SP No.	Large Category	Small Category	ENG or CTL	[Min to Max/Init./Step]
007				
2-414-008	Plain1:Size-Env.Correct:FC	PaperTransfer:Low:2Side:S2	ENG	[1 to 110 / 26 / 1/step]
2-414-009	Plain1:Size-Env.Correct:FC	PaperTransfer:Standard:1Sid:S3	ENG	[1 to 110 / 22 / 1/step]
2-414-010	Plain1:Size-Env.Correct:FC	PaperTransfer:Standard:2Sid:S3	ENG	[1 to 110 / 27 / 1/step]
2-414-011	Plain1:Size-Env.Correct:FC	PaperTransfer:Low:1Side:S3	ENG	[1 to 110 / 22 / 1/step]
2-414-012	Plain1:Size-Env.Correct:FC	PaperTransfer:Low:2Side:S3	ENG	[1 to 110 / 27 / 1/step]
2-414-013	Plain1:Size-Env.Correct:FC	PaperTransfer:Standard:1Sid:S4	ENG	[1 to 110 / 23 / 1/step]
2-414-014	Plain1:Size-Env.Correct:FC	PaperTransfer:Standard:2Sid:S4	ENG	[1 to 110 / 28 / 1/step]
2-414-015	Plain1:Size-Env.Correct:FC	PaperTransfer:Low:1Side:S4	ENG	[1 to 110 / 23 / 1/step]
2-414-016	Plain1:Size-Env.Correct:FC	PaperTransfer:Low:2Side:S4	ENG	[1 to 110 / 28 / 1/step]

3.SP Mode Tables

SP No.	Large Category	Small Category	ENG or CTL	[Min to Max/Init./Step]
2-414-017	Plain1:Size-Env.Correct:FC	PaperTransfer:Standard:1Sid:S5	ENG	[1 to 110 / 24 / 1/step]
2-414-018	Plain1:Size-Env.Correct:FC	PaperTransfer:Standard:2Sid:S5	ENG	[1 to 110 / 29 / 1/step]
2-414-019	Plain1:Size-Env.Correct:FC	PaperTransfer:Low:1Side:S5	ENG	[1 to 110 / 24 / 1/step]
2-414-020	Plain1:Size-Env.Correct:FC	PaperTransfer:Low:2Side:S5	ENG	[1 to 110 / 29 / 1/step]
2-414-021	Plain1:Size-Env.Correct:FC	Wide Roller:PaperTransfer:Standard:1Sid:S1	ENG *	[1 to 110 / 20 / 1/step]
2-414-022	Plain1:Size-Env.Correct:FC	Wide Roller:PaperTransfer:Standard:2Sid:S1	ENG	[1 to 110 / 25 / 1/step]
2-414-023	Plain1:Size-Env.Correct:FC	Wide Roller:PaperTransfer:Low:1Side:S1	ENG	[1 to 110 / 20 / 1/step]
2-414-024	Plain1:Size-Env.Correct:FC	Wide Roller:PaperTransfer:Low:2Side:S1	ENG	[1 to 110 / 25 / 1/step]
2-414-025	Plain1:Size-Env.Correct:FC	Wide Roller:PaperTransfer:Standard:1Sid:S2	ENG	[1 to 110 / 21 / 1/step]

3.SP Mode Tables

SP No.	Large Category	Small Category	ENG or CTL	[Min to Max/Init./Step]
2-414-026	Plain1:Size-Env.Correct:FC	Wide Roller:PaperTransfer:Standard:2Sid:S2	ENG	[1 to 110 / 26 / 1/step]
2-414-027	Plain1:Size-Env.Correct:FC	Wide Roller:PaperTransfer:Low:1Side:S2	ENG	[1 to 110 / 21 / 1/step]
2-414-028	Plain1:Size-Env.Correct:FC	Wide Roller:PaperTransfer:Low:2Side:S2	ENG	[1 to 110 / 26 / 1/step]
2-414-029	Plain1:Size-Env.Correct:FC	Wide Roller:PaperTransfer:Standard:1Sid:S3	ENG	[1 to 110 / 22 / 1/step]
2-414-030	Plain1:Size-Env.Correct:FC	Wide Roller:PaperTransfer:Standard:2Sid:S3	ENG	[1 to 110 / 27 / 1/step]
2-414-031	Plain1:Size-Env.Correct:FC	Wide Roller:PaperTransfer:Low:1Side:S3	ENG	[1 to 110 / 22 / 1/step]
2-414-032	Plain1:Size-Env.Correct:FC	Wide Roller:PaperTransfer:Low:2Side:S3	ENG	[1 to 110 / 27 / 1/step]
2-414-033	Plain1:Size-Env.Correct:FC	Wide Roller:PaperTransfer:Standard:1Sid:S4	ENG	[1 to 110 / 23 / 1/step]
2-414-034	Plain1:Size-Env.Correct:FC	Wide Roller:PaperTransfer:Standard:2Sid:S4	ENG	[1 to 110 / 28 / 1/step]

3.SP Mode Tables

SP No.	Large Category	Small Category	ENG or CTL	[Min to Max/Init./Step]
2-414-035	Plain1:Size-Env.Correct:FC	Wide Roller:PaperTransfer:Low:1Side:S4	ENG	[1 to 110 / 23 / 1/step]
2-414-036	Plain1:Size-Env.Correct:FC	Wide Roller:PaperTransfer:Low:2Side:S4	ENG	[1 to 110 / 28 / 1/step]
2-414-037	Plain1:Size-Env.Correct:FC	Wide Roller:PaperTransfer:Standard:1Sid:S5	ENG	[1 to 110 / 24 / 1/step]
2-414-038	Plain1:Size-Env.Correct:FC	Wide Roller:PaperTransfer:Standard:2Sid:S5	ENG	[1 to 110 / 29 / 1/step]
2-414-039	Plain1:Size-Env.Correct:FC	Wide Roller:PaperTransfer:Low:1Side:S5	ENG	[1 to 110 / 24 / 1/step]
2-414-040	Plain1:Size-Env.Correct:FC	Wide Roller:PaperTransfer:Low:2Side:S5	ENG	[1 to 110 / 29 / 1/step]
2-415-001	Plain1:LeadingEdgeCorrection	PaperTransfer:Standard:1Side	ENG	[0 to 995 / 100 / 5%/step]
2-415-002	Plain1:LeadingEdgeCorrection	PaperTransfer:Standard:2Side	ENG	[0 to 995 / 100 / 5%/step]
2-415-003	Plain1:LeadingEdgeCorrection	Paper Transfer:Low:1side	ENG	[0 to 995 / 100 / 5%/step]

3.SP Mode Tables

SP No.	Large Category	Small Category	ENG or CTL	[Min to Max/Init./Step]
2-415-004	Plain1:LeadingEdgeCorrection	Paper Transfer:Low:2side	ENG	[0 to 995 / 100 / 5%/step]
2-416-001	Plain1:SwitchTimingLeadEdge	PaperTransfer:Standard:1side	ENG	[0 to 50 / 0 / 2mm/step]
2-416-002	Plain1:SwitchTimingLeadEdge	PaperTransfer:Standard:2side	ENG	[0 to 50 / 0 / 2mm/step]
2-416-003	Plain1:SwitchTimingLeadEdge	Paper Transfer:Low:1side	ENG	[0 to 50 / 0 / 2mm/step]
2-416-004	Plain1:SwitchTimingLeadEdge	Paper Transfer:Low:2side	ENG	[0 to 50 / 0 / 2mm/step]
2-417-001	Plain1:TrailEdgeCorrection	PaperTransfer:Standard:1Side	ENG	[0 to 995 / 100 / 5%/step]
2-417-002	Plain1:TrailEdgeCorrection	PaperTransfer:Standard:2Side	ENG	[0 to 995 / 100 / 5%/step]
2-417-003	Plain1:TrailEdgeCorrection	Paper Transfer:Low:1side	ENG	[0 to 995 / 100 / 5%/step]
2-417-004	Plain1:TrailEdgeCorrection	Paper Transfer:Low:2side	ENG	[0 to 995 / 100 / 5%/step]

3.SP Mode Tables

SP No.	Large Category	Small Category	ENG or CTL	[Min to Max/Init./Step]
2-418-001	Plain1:SwitchTimingTrailEdge	PaperTransfer:Standard:1side	ENG	[0 to 50 / 0 / 2mm/step]
2-418-002	Plain1:SwitchTimingTrailEdge	PaperTransfer:Standard:2side	ENG	[0 to 50 / 0 / 2mm/step]
2-418-003	Plain1:SwitchTimingTrailEdge	Paper Transfer:Low:1side	ENG	[0 to 50 / 0 / 2mm/step]
2-418-004	Plain1:SwitchTimingTrailEdge	Paper Transfer:Low:2side	ENG	[0 to 50 / 0 / 2mm/step]
2-423-001	Plain2:Bias:BW	PaperTransfer:standard:1side	ENG	IM C6000: [0 to 250 / 38 / 1-uA/step] IM C5500: [0 to 250 / 38 / 1-uA/step] IM C4500: [0 to 250 / 28 / 1-uA/step]
2-423-002	Plain2:Bias:BW	PaperTransfer:standard:2side	ENG	IM C6000: [0 to 250 / 38 / 1-uA/step] IM C5500: [0 to 250 / 38 / 1-uA/step] IM C4500: [0 to 250 / 28 / 1-uA/step]
2-423	Plain2:Bias:BW	PaperTransfer:low:1side	ENG	IM C6000: [0 to 250 / 11

3.SP Mode Tables

SP No.	Large Category	Small Category	ENG or CTL	[Min to Max/Init./Step]
- 003				/ 1-uA/step] IM C5500: [0 to 250 / 11 / 1-uA/step] IM C4500: [0 to 250 / 11 / 1-uA/step]
2- 423 - 004	Plain2:Bias:BW	PaperTransfer:low:2side	ENG	IM C6000: [0 to 250 / 11 / 1-uA/step] IM C5500: [0 to 250 / 11 / 1-uA/step] IM C4500: [0 to 250 / 11 / 1-uA/step]
2- 425 - 001	HHsmall:LeadEdgeCorrection	PaperTransfer:1side	ENG	[0 to 995 / 100 / 5%/step]
2- 425 - 002	HHsmall:LeadEdgeCorrection	PaperTransfer:2stSide	ENG	[0 to 995 / 100 / 5%/step]
2- 427 - 001	Plain2:Bias:FC	PaperTransfer:standard:1side	ENG	IM C6000: [0 to 250 / 50 / 1-uA/step] IM C5500: [0 to 250 / 50 / 1-uA/step] IM C4500: [0 to 250 / 36 / 1-uA/step]
2- 427 -	Plain2:Bias:FC	PaperTransfer:standard:2side	ENG	IM C6000: [0 to 250 / 50 / 1-uA/step]

3.SP Mode Tables

SP No.	Large Category	Small Category	ENG or CTL	[Min to Max/Init./Step]
002				IM C5500: [0 to 250 / 50 / 1-uA/step] IM C4500: [0 to 250 / 36 / 1-uA/step]
2-427-003	Plain2:Bias:FC	PaperTransfer:low:1side	ENG	IM C6000: [0 to 250 / 14 / 1-uA/step] IM C5500: [0 to 250 / 14 / 1-uA/step] IM C4500: [0 to 250 / 14 / 1-uA/step]
2-427-004	Plain2:Bias:FC	PaperTransfer:low:2side	ENG	IM C6000: [0 to 250 / 14 / 1-uA/step] IM C5500: [0 to 250 / 14 / 1-uA/step] IM C4500: [0 to 250 / 14 / 1-uA/step]
2-431-001	Plain2:SizeCorrection:BW	PaperTransfer:Standard:1Sid:S1	ENG	[100 to 995 / 100 / 1%/step]
2-431-002	Plain2:SizeCorrection:BW	PaperTransfer:Standard:2Sid:S1	ENG	[100 to 995 / 100 / 1%/step]
2-431-003	Plain2:SizeCorrection:BW	PaperTransfer:Low:1Side:S1	ENG	[100 to 995 / 100 / 1%/step]

3.SP Mode Tables

SP No.	Large Category	Small Category	ENG or CTL	[Min to Max/Init./Step]
2-431-004	Plain2:SizeCorrection:BW	PaperTransfer:Low:2Side:S1	ENG	[100 to 995 / 100 / 1%/step]
2-431-005	Plain2:SizeCorrection:BW	PaperTransfer:Standard:1Sid:S2	ENG	[100 to 995 / 100 / 1%/step]
2-431-006	Plain2:SizeCorrection:BW	PaperTransfer:Standard:2Sid:S2	ENG	[100 to 995 / 105 / 1%/step]
2-431-007	Plain2:SizeCorrection:BW	PaperTransfer:Low:1Side:S2	ENG	[100 to 995 / 100 / 1%/step]
2-431-008	Plain2:SizeCorrection:BW	PaperTransfer:Low:2Side:S2	ENG	[100 to 995 / 105 / 1%/step]
2-431-009	Plain2:SizeCorrection:BW	PaperTransfer:Standard:1Sid:S3	ENG	[100 to 995 / 105 / 1%/step]
2-431-010	Plain2:SizeCorrection:BW	PaperTransfer:Standard:2Sid:S3	ENG	[100 to 995 / 118 / 1%/step]
2-431-011	Plain2:SizeCorrection:BW	PaperTransfer:Low:1Side:S3	ENG	[100 to 995 / 105 / 1%/step]
2-431-012	Plain2:SizeCorrection:BW	PaperTransfer:Low:2Side:S3	ENG	[100 to 995 / 118 / 1%/step]
2-	Plain2:SizeCorrection:BW	PaperTransfer:Standard:1Sid:S4	ENG	[100 to 995 /

3.SP Mode Tables

SP No.	Large Category	Small Category	ENG or CTL	[Min to Max/Init./Step]
431 - 013				118 / 1%/step]
2- 431 - 014	Plain2:SizeCorrection:BW	PaperTransfer:Standard:2Sid:S4	ENG	[100 to 995 / 131 / 1%/step]
2- 431 - 015	Plain2:SizeCorrection:BW	PaperTransfer:Low:1Side:S4	ENG	[100 to 995 / 118 / 1%/step]
2- 431 - 016	Plain2:SizeCorrection:BW	PaperTransfer:Low:2Side:S4	ENG	[100 to 995 / 131 / 1%/step]
2- 431 - 017	Plain2:SizeCorrection:BW	PaperTransfer:Standard:1Sid:S5	ENG	[100 to 995 / 132 / 1%/step]
2- 431 - 018	Plain2:SizeCorrection:BW	PaperTransfer:Standard:2Sid:S5	ENG	[100 to 995 / 184 / 1%/step]
2- 431 - 019	Plain2:SizeCorrection:BW	PaperTransfer:Low:1Side:S5	ENG	[100 to 995 / 132 / 1%/step]
2- 431 - 020	Plain2:SizeCorrection:BW	PaperTransfer:Low:2Side:S5	ENG	[100 to 995 / 184 / 1%/step]
2- 431 - 021	Plain2:SizeCorrection:BW	Wide Roller:PaperTransfer:Standard:1Sid:S 1	ENG	[100 to 995 / 100 / 1%/step]
2-	Plain2:SizeCorrection:BW	Wide	ENG	[100 to 995 /

3.SP Mode Tables

SP No.	Large Category	Small Category	ENG or CTL	[Min to Max/Init./Step]
431-022		Roller:PaperTransfer:Standard:2Sid:S1		100 / 1%/step]
2-431-023	Plain2:SizeCorrection:BW	Wide Roller:PaperTransfer:Low:1Side:S1	ENG	[100 to 995 / 100 / 1%/step]
2-431-024	Plain2:SizeCorrection:BW	Wide Roller:PaperTransfer:Low:2Side:S1	ENG	[100 to 995 / 100 / 1%/step]
2-431-025	Plain2:SizeCorrection:BW	Wide Roller:PaperTransfer:Standard:1Sid:S2	ENG	[100 to 995 / 100 / 1%/step]
2-431-026	Plain2:SizeCorrection:BW	Wide Roller:PaperTransfer:Standard:2Sid:S2	ENG	[100 to 995 / 105 / 1%/step]
2-431-027	Plain2:SizeCorrection:BW	Wide Roller:PaperTransfer:Low:1Side:S2	ENG	[100 to 995 / 100 / 1%/step]
2-431-028	Plain2:SizeCorrection:BW	Wide Roller:PaperTransfer:Low:2Side:S2	ENG	[100 to 995 / 105 / 1%/step]
2-431-029	Plain2:SizeCorrection:BW	Wide Roller:PaperTransfer:Standard:1Sid:S3	ENG	[100 to 995 / 105 / 1%/step]
2-431-030	Plain2:SizeCorrection:BW	Wide Roller:PaperTransfer:Standard:2Sid:S3	ENG	[100 to 995 / 118 / 1%/step]
2-	Plain2:SizeCorrection:BW	Wide	ENG	[100 to 995 /

3.SP Mode Tables

SP No.	Large Category	Small Category	ENG or CTL	[Min to Max/Init./Step]
431 - 031		Roller:PaperTransfer:Low:1Side:S3		105 / 1%/step]
2- 431 - 032	Plain2:SizeCorrection:BW	Wide Roller:PaperTransfer:Low:2Side:S3	ENG	[100 to 995 / 118 / 1%/step]
2- 431 - 033	Plain2:SizeCorrection:BW	Wide Roller:PaperTransfer:Standard:1Sid:S4	ENG	[100 to 995 / 118 / 1%/step]
2- 431 - 034	Plain2:SizeCorrection:BW	Wide Roller:PaperTransfer:Standard:2Sid:S4	ENG	[100 to 995 / 131 / 1%/step]
2- 431 - 035	Plain2:SizeCorrection:BW	Wide Roller:PaperTransfer:Low:1Side:S4	ENG	[100 to 995 / 118 / 1%/step]
2- 431 - 036	Plain2:SizeCorrection:BW	Wide Roller:PaperTransfer:Low:2Side:S4	ENG	[100 to 995 / 131 / 1%/step]
2- 431 - 037	Plain2:SizeCorrection:BW	Wide Roller:PaperTransfer:Standard:1Sid:S5	ENG	[100 to 995 / 132 / 1%/step]
2- 431 - 038	Plain2:SizeCorrection:BW	Wide Roller:PaperTransfer:Standard:2Sid:S5	ENG	[100 to 995 / 184 / 1%/step]
2- 431 - 039	Plain2:SizeCorrection:BW	Wide Roller:PaperTransfer:Low:1Side:S5	ENG	[100 to 995 / 132 / 1%/step]
2-	Plain2:SizeCorrection:BW	Wide	ENG	[100 to 995 /

3.SP Mode Tables

SP No.	Large Category	Small Category	ENG or CTL	[Min to Max/Init./Step]
431 - 040		Roller:PaperTransfer:Low:2Side:S5		184 / 1%/step]
2- 432 - 001	Plain2:SizeCorrection:FC	PaperTransfer:Standard:1Sid:S1	ENG	[100 to 995 / 100 / 1%/step]
2- 432 - 002	Plain2:SizeCorrection:FC	PaperTransfer:Standard:2Sid:S1	ENG	[100 to 995 / 100 / 1%/step]
2- 432 - 003	Plain2:SizeCorrection:FC	PaperTransfer:Low:1Side:S1	ENG	[100 to 995 / 100 / 1%/step]
2- 432 - 004	Plain2:SizeCorrection:FC	PaperTransfer:Low:2Side:S1	ENG	[100 to 995 / 100 / 1%/step]
2- 432 - 005	Plain2:SizeCorrection:FC	PaperTransfer:Standard:1Sid:S2	ENG	[100 to 995 / 120 / 1%/step]
2- 432 - 006	Plain2:SizeCorrection:FC	PaperTransfer:Standard:2Sid:S2	ENG	[100 to 995 / 140 / 1%/step]
2- 432 - 007	Plain2:SizeCorrection:FC	PaperTransfer:Low:1Side:S2	ENG	[100 to 995 / 120 / 1%/step]
2- 432 - 008	Plain2:SizeCorrection:FC	PaperTransfer:Low:2Side:S2	ENG	[100 to 995 / 140 / 1%/step]
2-	Plain2:SizeCorrection:FC	PaperTransfer:Standard:1Sid:S3	ENG	[100 to 995 /

3.SP Mode Tables

SP No.	Large Category	Small Category	ENG or CTL	[Min to Max/Init./Step]
432 - 009				118 / 1%/step]
2- 432 - 010	Plain2:SizeCorrection:FC	PaperTransfer:Standard:2Sid:S3	ENG	[100 to 995 / 180 / 1%/step]
2- 432 -011	Plain2:SizeCorrection:FC	PaperTransfer:Low:1Side:S3	ENG	[100 to 995 / 118 / 1%/step]
2- 432 - 012	Plain2:SizeCorrection:FC	PaperTransfer:Low:2Side:S3	ENG	[100 to 995 / 180 / 1%/step]
2- 432 - 013	Plain2:SizeCorrection:FC	PaperTransfer:Standard:1Sid:S4	ENG	[100 to 995 / 130 / 1%/step]
2- 432 - 014	Plain2:SizeCorrection:FC	PaperTransfer:Standard:2Sid:S4	ENG	[100 to 995 / 200 / 1%/step]
2- 432 - 015	Plain2:SizeCorrection:FC	PaperTransfer:Low:1Side:S4	ENG	[100 to 995 / 130 / 1%/step]
2- 432 - 016	Plain2:SizeCorrection:FC	PaperTransfer:Low:2Side:S4	ENG	[100 to 995 / 200 / 1%/step]
2- 432 - 017	Plain2:SizeCorrection:FC	PaperTransfer:Standard:1Sid:S5	ENG	[100 to 995 / 140 / 1%/step]
2- 432	Plain2:SizeCorrection:FC	PaperTransfer:Standard:2Sid:S5	ENG	[100 to 995 / 240 /

3.SP Mode Tables

SP No.	Large Category	Small Category	ENG or CTL	[Min to Max/Init./Step]
- 018				1%/step]
2- 432 - 019	Plain2:SizeCorrection:FC	PaperTransfer:Low:1Side:S5	ENG	[100 to 995 / 140 / 1%/step]
2- 432 - 020	Plain2:SizeCorrection:FC	PaperTransfer:Low:2Side:S5	ENG	[100 to 995 / 240 / 1%/step]
2- 432 - 021	Plain2:SizeCorrection:FC	Wide Roller:PaperTransfer:Standard:1Sid:S 1	ENG	[100 to 995 / 100 / 1%/step]
2- 432 - 022	Plain2:SizeCorrection:FC	Wide Roller:PaperTransfer:Standard:2Sid:S 1	ENG	[100 to 995 / 100 / 1%/step]
2- 432 - 023	Plain2:SizeCorrection:FC	Wide Roller:PaperTransfer:Low:1Side:S1	ENG	[100 to 995 / 100 / 1%/step]
2- 432 - 024	Plain2:SizeCorrection:FC	Wide Roller:PaperTransfer:Low:2Side:S1	ENG	[100 to 995 / 100 / 1%/step]
2- 432 - 025	Plain2:SizeCorrection:FC	Wide Roller:PaperTransfer:Standard:1Sid:S 2	ENG	[100 to 995 / 120 / 1%/step]
2- 432 - 026	Plain2:SizeCorrection:FC	Wide Roller:PaperTransfer:Standard:2Sid:S 2	ENG	[100 to 995 / 140 / 1%/step]
2- 432	Plain2:SizeCorrection:FC	Wide Roller:PaperTransfer:Low:1Side:S2	ENG	[100 to 995 / 120 /

3.SP Mode Tables

SP No.	Large Category	Small Category	ENG or CTL	[Min to Max/Init./Step]
- 027				1%/step]
2- 432 - 028	Plain2:SizeCorrection:FC	Wide Roller:PaperTransfer:Low:2Side:S2	ENG	[100 to 995 / 140 / 1%/step]
2- 432 - 029	Plain2:SizeCorrection:FC	Wide Roller:PaperTransfer:Standard:1Sid:S 3	ENG	[100 to 995 / 118 / 1%/step]
2- 432 - 030	Plain2:SizeCorrection:FC	Wide Roller:PaperTransfer:Standard:2Sid:S 3	ENG	[100 to 995 / 180 / 1%/step]
2- 432 - 031	Plain2:SizeCorrection:FC	Wide Roller:PaperTransfer:Low:1Side:S3	ENG	[100 to 995 / 118 / 1%/step]
2- 432 - 032	Plain2:SizeCorrection:FC	Wide Roller:PaperTransfer:Low:2Side:S3	ENG	[100 to 995 / 180 / 1%/step]
2- 432 - 033	Plain2:SizeCorrection:FC	Wide Roller:PaperTransfer:Standard:1Sid:S 4	ENG	[100 to 995 / 130 / 1%/step]
2- 432 - 034	Plain2:SizeCorrection:FC	Wide Roller:PaperTransfer:Standard:2Sid:S 4	ENG	[100 to 995 / 200 / 1%/step]
2- 432 - 035	Plain2:SizeCorrection:FC	Wide Roller:PaperTransfer:Low:1Side:S4	ENG	[100 to 995 / 130 / 1%/step]
2- 432	Plain2:SizeCorrection:FC	Wide Roller:PaperTransfer:Low:2Side:S4	ENG	[100 to 995 / 200 /

3.SP Mode Tables

SP No.	Large Category	Small Category	ENG or CTL	[Min to Max/Init./Step]
- 036				1%/step]
2- 432 - 037	Plain2:SizeCorrection:FC	Wide Roller:PaperTransfer:Standard:1Sid:S5	ENG	[100 to 995 / 140 / 1%/step]
2- 432 - 038	Plain2:SizeCorrection:FC	Wide Roller:PaperTransfer:Standard:2Sid:S5	ENG	[100 to 995 / 240 / 1%/step]
2- 432 - 039	Plain2:SizeCorrection:FC	Wide Roller:PaperTransfer:Low:1Side:S5	ENG	[100 to 995 / 140 / 1%/step]
2- 432 - 040	Plain2:SizeCorrection:FC	Wide Roller:PaperTransfer:Low:2Side:S5	ENG	[100 to 995 / 240 / 1%/step]
2- 433 - 001	Plain2:Size-Env.Correct:BW	PaperTransfer:Standard:1Sid:S1	ENG	[1 to 110 / 10 / 1/step]
2- 433 - 002	Plain2:Size-Env.Correct:BW	PaperTransfer:Standard:2Sid:S1	ENG	[1 to 110 / 15 / 1/step]
2- 433 - 003	Plain2:Size-Env.Correct:BW	PaperTransfer:Low:1Side:S1	ENG	[1 to 110 / 10 / 1/step]
2- 433 - 004	Plain2:Size-Env.Correct:BW	PaperTransfer:Low:2Side:S1	ENG	[1 to 110 / 15 / 1/step]
2- 433	Plain2:Size-Env.Correct:BW	PaperTransfer:Standard:1Sid:S2	ENG	[1 to 110 / 11 / 1/step]

3.SP Mode Tables

SP No.	Large Category	Small Category	ENG or CTL	[Min to Max/Init./Step]
-005				
2-433-006	Plain2:Size-Env.Correct:BW	PaperTransfer:Standard:2Sid:S2	ENG	[1 to 110 / 16 / 1/step]
2-433-007	Plain2:Size-Env.Correct:BW	PaperTransfer:Low:1Side:S2	ENG	[1 to 110 / 11 / 1/step]
2-433-008	Plain2:Size-Env.Correct:BW	PaperTransfer:Low:2Side:S2	ENG	[1 to 110 / 16 / 1/step]
2-433-009	Plain2:Size-Env.Correct:BW	PaperTransfer:Standard:1Sid:S3	ENG	[1 to 110 / 12 / 1/step]
2-433-010	Plain2:Size-Env.Correct:BW	PaperTransfer:Standard:2Sid:S3	ENG	[1 to 110 / 17 / 1/step]
2-433-011	Plain2:Size-Env.Correct:BW	PaperTransfer:Low:1Side:S3	ENG	[1 to 110 / 12 / 1/step]
2-433-012	Plain2:Size-Env.Correct:BW	PaperTransfer:Low:2Side:S3	ENG	[1 to 110 / 17 / 1/step]
2-433-013	Plain2:Size-Env.Correct:BW	PaperTransfer:Standard:1Sid:S4	ENG	[1 to 110 / 13 / 1/step]
2-433-	Plain2:Size-Env.Correct:BW	PaperTransfer:Standard:2Sid:S4	ENG	[1 to 110 / 18 / 1/step]

3.SP Mode Tables

SP No.	Large Category	Small Category	ENG or CTL	[Min to Max/Init./Step]
014				
2-433-015	Plain2:Size-Env.Correct:BW	PaperTransfer:Low:1Side:S4	ENG	[1 to 110 / 13 / 1/step]
2-433-016	Plain2:Size-Env.Correct:BW	PaperTransfer:Low:2Side:S4	ENG	[1 to 110 / 18 / 1/step]
2-433-017	Plain2:Size-Env.Correct:BW	PaperTransfer:Standard:1Sid:S5	ENG	[1 to 110 / 14 / 1/step]
2-433-018	Plain2:Size-Env.Correct:BW	PaperTransfer:Standard:2Sid:S5	ENG	[1 to 110 / 19 / 1/step]
2-433-019	Plain2:Size-Env.Correct:BW	PaperTransfer:Low:1Side:S5	ENG	[1 to 110 / 14 / 1/step]
2-433-020	Plain2:Size-Env.Correct:BW	PaperTransfer:Low:2Side:S5	ENG	[1 to 110 / 19 / 1/step]
2-433-021	Plain2:Size-Env.Correct:BW	Wide Roller:PaperTransfer:Standard:1Sid:S1	ENG	[1 to 110 / 10 / 1/step]
2-433-022	Plain2:Size-Env.Correct:BW	Wide Roller:PaperTransfer:Standard:2Sid:S1	ENG	[1 to 110 / 15 / 1/step]
2-433-	Plain2:Size-Env.Correct:BW	Wide Roller:PaperTransfer:Low:1Side:S1	ENG	[1 to 110 / 10 / 1/step]

3.SP Mode Tables

SP No.	Large Category	Small Category	ENG or CTL	[Min to Max/Init./Step]
023				
2-433-024	Plain2:Size-Env.Correct:BW	Wide Roller:PaperTransfer:Low:2Side:S1	ENG	[1 to 110 / 15 / 1/step]
2-433-025	Plain2:Size-Env.Correct:BW	Wide Roller:PaperTransfer:Standard:1Sid:S2	ENG	[1 to 110 / 11 / 1/step]
2-433-026	Plain2:Size-Env.Correct:BW	Wide Roller:PaperTransfer:Standard:2Sid:S2	ENG	[1 to 110 / 16 / 1/step]
2-433-027	Plain2:Size-Env.Correct:BW	Wide Roller:PaperTransfer:Low:1Side:S2	ENG	[1 to 110 / 11 / 1/step]
2-433-028	Plain2:Size-Env.Correct:BW	Wide Roller:PaperTransfer:Low:2Side:S2	ENG	[1 to 110 / 16 / 1/step]
2-433-029	Plain2:Size-Env.Correct:BW	Wide Roller:PaperTransfer:Standard:1Sid:S3	ENG	[1 to 110 / 12 / 1/step]
2-433-030	Plain2:Size-Env.Correct:BW	Wide Roller:PaperTransfer:Standard:2Sid:S3	ENG	[1 to 110 / 17 / 1/step]
2-433-031	Plain2:Size-Env.Correct:BW	Wide Roller:PaperTransfer:Low:1Side:S3	ENG	[1 to 110 / 12 / 1/step]
2-433-	Plain2:Size-Env.Correct:BW	Wide Roller:PaperTransfer:Low:2Side:S3	ENG	[1 to 110 / 17 / 1/step]

3.SP Mode Tables

SP No.	Large Category	Small Category	ENG or CTL	[Min to Max/Init./Step]
032				
2-433-033	Plain2:Size-Env.Correct:BW	Wide Roller:PaperTransfer:Standard:1Sid:S4	ENG	[1 to 110 / 13 / 1/step]
2-433-034	Plain2:Size-Env.Correct:BW	Wide Roller:PaperTransfer:Standard:2Sid:S4	ENG	[1 to 110 / 18 / 1/step]
2-433-035	Plain2:Size-Env.Correct:BW	Wide Roller:PaperTransfer:Low:1Side:S4	ENG	[1 to 110 / 13 / 1/step]
2-433-036	Plain2:Size-Env.Correct:BW	Wide Roller:PaperTransfer:Low:2Side:S4	ENG	[1 to 110 / 18 / 1/step]
2-433-037	Plain2:Size-Env.Correct:BW	Wide Roller:PaperTransfer:Standard:1Sid:S5	ENG	[1 to 110 / 14 / 1/step]
2-433-038	Plain2:Size-Env.Correct:BW	Wide Roller:PaperTransfer:Standard:2Sid:S5	ENG	[1 to 110 / 19 / 1/step]
2-433-039	Plain2:Size-Env.Correct:BW	Wide Roller:PaperTransfer:Low:1Side:S5	ENG	[1 to 110 / 14 / 1/step]
2-433-040	Plain2:Size-Env.Correct:BW	Wide Roller:PaperTransfer:Low:2Side:S5	ENG	[1 to 110 / 19 / 1/step]
2-434-	Plain2:Size-Env.Correct:FC	PaperTransfer:Standard:1Sid:S1	ENG	[1 to 110 / 20 / 1/step]

3.SP Mode Tables

SP No.	Large Category	Small Category	ENG or CTL	[Min to Max/Init./Step]
001				
2-434-002	Plain2:Size-Env.Correct:FC	PaperTransfer:Standard:2Sid:S1	ENG	[1 to 110 / 25 / 1/step]
2-434-003	Plain2:Size-Env.Correct:FC	PaperTransfer:Low:1Side:S1	ENG	[1 to 110 / 20 / 1/step]
2-434-004	Plain2:Size-Env.Correct:FC	PaperTransfer:Low:2Side:S1	ENG	[1 to 110 / 25 / 1/step]
2-434-005	Plain2:Size-Env.Correct:FC	PaperTransfer:Standard:1Sid:S2	ENG	[1 to 110 / 21 / 1/step]
2-434-006	Plain2:Size-Env.Correct:FC	PaperTransfer:Standard:2Sid:S2	ENG	[1 to 110 / 26 / 1/step]
2-434-007	Plain2:Size-Env.Correct:FC	PaperTransfer:Low:1Side:S2	ENG	[1 to 110 / 21 / 1/step]
2-434-008	Plain2:Size-Env.Correct:FC	PaperTransfer:Low:2Side:S2	ENG	[1 to 110 / 26 / 1/step]
2-434-009	Plain2:Size-Env.Correct:FC	PaperTransfer:Standard:1Sid:S3	ENG	[1 to 110 / 22 / 1/step]
2-434-	Plain2:Size-Env.Correct:FC	PaperTransfer:Standard:2Sid:S3	ENG	[1 to 110 / 27 / 1/step]

3.SP Mode Tables

SP No.	Large Category	Small Category	ENG or CTL	[Min to Max/Init./Step]
010				
2-434-011	Plain2:Size-Env.Correct:FC	PaperTransfer:Low:1Side:S3	ENG	[1 to 110 / 22 / 1/step]
2-434-012	Plain2:Size-Env.Correct:FC	PaperTransfer:Low:2Side:S3	ENG	[1 to 110 / 27 / 1/step]
2-434-013	Plain2:Size-Env.Correct:FC	PaperTransfer:Standard:1Sid:S4	ENG	[1 to 110 / 23 / 1/step]
2-434-014	Plain2:Size-Env.Correct:FC	PaperTransfer:Standard:2Sid:S4	ENG	[1 to 110 / 28 / 1/step]
2-434-015	Plain2:Size-Env.Correct:FC	PaperTransfer:Low:1Side:S4	ENG	[1 to 110 / 23 / 1/step]
2-434-016	Plain2:Size-Env.Correct:FC	PaperTransfer:Low:2Side:S4	ENG	[1 to 110 / 28 / 1/step]
2-434-017	Plain2:Size-Env.Correct:FC	PaperTransfer:Standard:1Sid:S5	ENG	[1 to 110 / 24 / 1/step]
2-434-018	Plain2:Size-Env.Correct:FC	PaperTransfer:Standard:2Sid:S5	ENG	[1 to 110 / 29 / 1/step]
2-434-019	Plain2:Size-Env.Correct:FC	PaperTransfer:Low:1Side:S5	ENG	[1 to 110 / 24 / 1/step]

3.SP Mode Tables

SP No.	Large Category	Small Category	ENG or CTL	[Min to Max/Init./Step]
2-434-020	Plain2:Size-Env.Correct:FC	PaperTransfer:Low:2Side:S5	ENG	[1 to 110 / 29 / 1/step]
2-434-021	Plain2:Size-Env.Correct:FC	Wide Roller:PaperTransfer:Standard:1Sid:S1	ENG	[1 to 110 / 20 / 1/step]
2-434-022	Plain2:Size-Env.Correct:FC	Wide Roller:PaperTransfer:Standard:2Sid:S1	ENG	[1 to 110 / 25 / 1/step]
2-434-023	Plain2:Size-Env.Correct:FC	Wide Roller:PaperTransfer:Low:1Side:S1	ENG	[1 to 110 / 20 / 1/step]
2-434-024	Plain2:Size-Env.Correct:FC	Wide Roller:PaperTransfer:Low:2Side:S1	ENG	[1 to 110 / 25 / 1/step]
2-434-025	Plain2:Size-Env.Correct:FC	Wide Roller:PaperTransfer:Standard:1Sid:S2	ENG	[1 to 110 / 21 / 1/step]
2-434-026	Plain2:Size-Env.Correct:FC	Wide Roller:PaperTransfer:Standard:2Sid:S2	ENG	[1 to 110 / 26 / 1/step]
2-434-027	Plain2:Size-Env.Correct:FC	Wide Roller:PaperTransfer:Low:1Side:S2	ENG	[1 to 110 / 21 / 1/step]
2-434-028	Plain2:Size-Env.Correct:FC	Wide Roller:PaperTransfer:Low:2Side:S2	ENG	[1 to 110 / 26 / 1/step]

3.SP Mode Tables

SP No.	Large Category	Small Category	ENG or CTL	[Min to Max/Init./Step]
2-434-029	Plain2:Size-Env.Correct:FC	Wide Roller:PaperTransfer:Standard:1Sid:S3	ENG	[1 to 110 / 22 / 1/step]
2-434-030	Plain2:Size-Env.Correct:FC	Wide Roller:PaperTransfer:Standard:2Sid:S3	ENG	[1 to 110 / 27 / 1/step]
2-434-031	Plain2:Size-Env.Correct:FC	Wide Roller:PaperTransfer:Low:1Side:S3	ENG	[1 to 110 / 22 / 1/step]
2-434-032	Plain2:Size-Env.Correct:FC	Wide Roller:PaperTransfer:Low:2Side:S3	ENG	[1 to 110 / 27 / 1/step]
2-434-033	Plain2:Size-Env.Correct:FC	Wide Roller:PaperTransfer:Standard:1Sid:S4	ENG	[1 to 110 / 23 / 1/step]
2-434-034	Plain2:Size-Env.Correct:FC	Wide Roller:PaperTransfer:Standard:2Sid:S4	ENG	[1 to 110 / 28 / 1/step]
2-434-035	Plain2:Size-Env.Correct:FC	Wide Roller:PaperTransfer:Low:1Side:S4	ENG	[1 to 110 / 23 / 1/step]
2-434-036	Plain2:Size-Env.Correct:FC	Wide Roller:PaperTransfer:Low:2Side:S4	ENG	[1 to 110 / 28 / 1/step]
2-434-037	Plain2:Size-Env.Correct:FC	Wide Roller:PaperTransfer:Standard:1Sid:S5	ENG	[1 to 110 / 24 / 1/step]

3.SP Mode Tables

SP No.	Large Category	Small Category	ENG or CTL	[Min to Max/Init./Step]
2-434-038	Plain2:Size-Env.Correct:FC	Wide Roller:PaperTransfer:Standard:2Sid:S5	ENG	[1 to 110 / 29 / 1/step]
2-434-039	Plain2:Size-Env.Correct:FC	Wide Roller:PaperTransfer:Low:1Side:S5	ENG	[1 to 110 / 24 / 1/step]
2-434-040	Plain2:Size-Env.Correct:FC	Wide Roller:PaperTransfer:Low:2Side:S5	ENG	[1 to 110 / 29 / 1/step]
2-435-001	Plain2:LeadingEdgeCorrection	PaperTransfer:Standard:1Side	ENG	[0 to 995 / 100 / 5%/step]
2-435-002	Plain2:LeadingEdgeCorrection	PaperTransfer:Standard:2Side	ENG	[0 to 995 / 100 / 5%/step]
2-435-003	Plain2:LeadingEdgeCorrection	Paper Transfer:Low:1side	ENG	[0 to 995 / 100 / 5%/step]
2-435-004	Plain2:LeadingEdgeCorrection	Paper Transfer:Low:2side	ENG	[0 to 995 / 100 / 5%/step]
2-436-001	Plain2:SwitchTimingLeadEdge	PaperTransfer:Standard:1side	ENG	[0 to 50 / 0 / 2mm/step]
2-436-002	Plain2:SwitchTimingLeadEdge	PaperTransfer:Standard:2side	ENG	[0 to 50 / 0 / 2mm/step]

3.SP Mode Tables

SP No.	Large Category	Small Category	ENG or CTL	[Min to Max/Init./Step]
2-436-003	Plain2:SwitchTimingLeadEdge	Paper Transfer:Low:1side	ENG	[0 to 50 / 0 / 2mm/step]
2-436-004	Plain2:SwitchTimingLeadEdge	Paper Transfer:Low:2side	ENG	[0 to 50 / 0 / 2mm/step]
2-437-001	Plain2:TrailEdgeCorrection	PaperTransfer:Standard:1Side	ENG	[0 to 995 / 100 / 5%/step]
2-437-002	Plain2:TrailEdgeCorrection	PaperTransfer:Standard:2Side	ENG	[0 to 995 / 100 / 5%/step]
2-437-003	Plain2:TrailEdgeCorrection	Paper Transfer:Low:1side	ENG	[0 to 995 / 100 / 5%/step]
2-437-004	Plain2:TrailEdgeCorrection	Paper Transfer:Low:2side	ENG	[0 to 995 / 100 / 5%/step]
2-438-001	Plain2:SwitchTimingTrailEdge	PaperTransfer:Standard:1side	ENG	[0 to 50 / 0 / 2mm/step]
2-438-002	Plain2:SwitchTimingTrailEdge	PaperTransfer:Standard:2side	ENG	[0 to 50 / 0 / 2mm/step]
2-438-003	Plain2:SwitchTimingTrailEdge	Paper Transfer:Low:1side	ENG	[0 to 50 / 0 / 2mm/step]

3.SP Mode Tables

SP No.	Large Category	Small Category	ENG or CTL	[Min to Max/Init./Step]
2-438-004	Plain2:SwitchTimingTrailEdge	Paper Transfer:Low:2side	ENG	[0 to 50 / 0 / 2mm/step]
2-443-001	Middle:Bias:BW	PaperTransfer:standard:1side	ENG	IM C6000: [0 to 250 / 38 / 1-uA/step] IM C5500: [0 to 250 / 38 / 1-uA/step] IM C4500: [0 to 250 / 28 / 1-uA/step]
2-443-002	Middle:Bias:BW	PaperTransfer:standard:2side	ENG	IM C6000: [0 to 250 / 38 / 1-uA/step] IM C5500: [0 to 250 / 38 / 1-uA/step] IM C4500: [0 to 250 / 28 / 1-uA/step]
2-443-003	Middle:Bias:BW	PaperTransfer:low:1side	ENG	IM C6000: [0 to 250 / 11 / 1-uA/step] IM C5500: [0 to 250 / 11 / 1-uA/step] IM C4500: [0 to 250 / 11 / 1-uA/step]
2-443-004	Middle:Bias:BW	PaperTransfer:low:2side	ENG	IM C6000: [0 to 250 / 11 / 1-uA/step] IM C5500: [0 to 250 / 11

3.SP Mode Tables

SP No.	Large Category	Small Category	ENG or CTL	[Min to Max/Init./Step]
				/ 1-uA/step] IM C4500: [0 to 250 / 11 / 1-uA/step]
2-447-001	Middle:Bias:FC	PaperTransfer:standard:1side	ENG	IM C6000: [0 to 250 / 50 / 1-uA/step] IM C5500: [0 to 250 / 50 / 1-uA/step] IM C4500: [0 to 250 / 36 / 1-uA/step]
2-447-002	Middle:Bias:FC	PaperTransfer:standard:2side	ENG	IM C6000: [0 to 250 / 53 / 1-uA/step] IM C5500: [0 to 250 / 53 / 1-uA/step] IM C4500: [0 to 250 / 39 / 1-uA/step]
2-447-003	Middle:Bias:FC	PaperTransfer:low:1side	ENG	IM C6000: [0 to 250 / 14 / 1-uA/step] IM C5500: [0 to 250 / 14 / 1-uA/step] IM C4500: [0 to 250 / 14 / 1-uA/step]
2-447-004	Middle:Bias:FC	PaperTransfer:low:2side	ENG	IM C6000: [0 to 250 / 15 / 1-uA/step] IM C5500: [0 to 250 / 15

3.SP Mode Tables

SP No.	Large Category	Small Category	ENG or CTL	[Min to Max/Init./Step]
				/ 1-uA/step] IM C4500: [0 to 250 / 15 / 1-uA/step]
2-451-001	Middle:SizeCorrection:BW	PaperTransfer:Standard:1Sid:S1	ENG	[100 to 995 / 100 / 1%/step]
2-451-002	Middle:SizeCorrection:BW	PaperTransfer:Standard:2Sid:S1	ENG	[100 to 995 / 100 / 1%/step]
2-451-003	Middle:SizeCorrection:BW	PaperTransfer:Low:1Side:S1	ENG	[100 to 995 / 100 / 1%/step]
2-451-004	Middle:SizeCorrection:BW	PaperTransfer:Low:2Side:S1	ENG	[100 to 995 / 100 / 1%/step]
2-451-005	Middle:SizeCorrection:BW	PaperTransfer:Standard:1Sid:S2	ENG	[100 to 995 / 100 / 1%/step]
2-451-006	Middle:SizeCorrection:BW	PaperTransfer:Standard:2Sid:S2	ENG	[100 to 995 / 106 / 1%/step]
2-451-007	Middle:SizeCorrection:BW	PaperTransfer:Low:1Side:S2	ENG	[100 to 995 / 100 / 1%/step]
2-451-008	Middle:SizeCorrection:BW	PaperTransfer:Low:2Side:S2	ENG	[100 to 995 / 106 / 1%/step]

3.SP Mode Tables

SP No.	Large Category	Small Category	ENG or CTL	[Min to Max/Init./Step]
2-451-009	Middle:SizeCorrection:BW	PaperTransfer:Standard:1Sid:S3	ENG	[100 to 995 / 105 / 1%/step]
2-451-010	Middle:SizeCorrection:BW	PaperTransfer:Standard:2Sid:S3	ENG	[100 to 995 / 110 / 1%/step]
2-451-011	Middle:SizeCorrection:BW	PaperTransfer:Low:1Side:S3	ENG	[100 to 995 / 105 / 1%/step]
2-451-012	Middle:SizeCorrection:BW	PaperTransfer:Low:2Side:S3	ENG	[100 to 995 / 110 / 1%/step]
2-451-013	Middle:SizeCorrection:BW	PaperTransfer:Standard:1Sid:S4	ENG	[100 to 995 / 113 / 1%/step]
2-451-014	Middle:SizeCorrection:BW	PaperTransfer:Standard:2Sid:S4	ENG	[100 to 995 / 120 / 1%/step]
2-451-015	Middle:SizeCorrection:BW	PaperTransfer:Low:1Side:S4	ENG	[100 to 995 / 113 / 1%/step]
2-451-016	Middle:SizeCorrection:BW	PaperTransfer:Low:2Side:S4	ENG	[100 to 995 / 120 / 1%/step]
2-451-017	Middle:SizeCorrection:BW	PaperTransfer:Standard:1Sid:S5	ENG	[100 to 995 / 118 / 1%/step]
2-	Middle:SizeCorrection:BW	PaperTransfer:Standard:2Sid:S5	ENG	[100 to 995 /

3.SP Mode Tables

SP No.	Large Category	Small Category	ENG or CTL	[Min to Max/Init./Step]
451 - 018				140 / 1%/step]
2- 451 - 019	Middle:SizeCorrection:BW	PaperTransfer:Low:1Side:S5	ENG	[100 to 995 / 118 / 1%/step]
2- 451 - 020	Middle:SizeCorrection:BW	PaperTransfer:Low:2Side:S5	ENG	[100 to 995 / 140 / 1%/step]
2- 451 - 021	Middle:SizeCorrection:BW	Wide Roller:PaperTransfer:Standard:1Sid:S 1	ENG	[100 to 995 / 100 / 1%/step]
2- 451 - 022	Middle:SizeCorrection:BW	Wide Roller:PaperTransfer:Standard:2Sid:S 1	ENG	[100 to 995 / 100 / 1%/step]
2- 451 - 023	Middle:SizeCorrection:BW	Wide Roller:PaperTransfer:Low:1Side:S1	ENG	[100 to 995 / 100 / 1%/step]
2- 451 - 024	Middle:SizeCorrection:BW	Wide Roller:PaperTransfer:Low:2Side:S1	ENG	[100 to 995 / 100 / 1%/step]
2- 451 - 025	Middle:SizeCorrection:BW	Wide Roller:PaperTransfer:Standard:1Sid:S 2	ENG	[100 to 995 / 100 / 1%/step]
2- 451 - 026	Middle:SizeCorrection:BW	Wide Roller:PaperTransfer:Standard:2Sid:S 2	ENG	[100 to 995 / 106 / 1%/step]
2-	Middle:SizeCorrection:BW	Wide	ENG	[100 to 995 /

3.SP Mode Tables

SP No.	Large Category	Small Category	ENG or CTL	[Min to Max/Init./Step]
451-027		Roller:PaperTransfer:Low:1Side:S2		100 / 1%/step]
2-451-028	Middle:SizeCorrection:BW	Wide Roller:PaperTransfer:Low:2Side:S2	ENG	[100 to 995 / 106 / 1%/step]
2-451-029	Middle:SizeCorrection:BW	Wide Roller:PaperTransfer:Standard:1Sid:S3	ENG	[100 to 995 / 105 / 1%/step]
2-451-030	Middle:SizeCorrection:BW	Wide Roller:PaperTransfer:Standard:2Sid:S3	ENG	[100 to 995 / 110 / 1%/step]
2-451-031	Middle:SizeCorrection:BW	Wide Roller:PaperTransfer:Low:1Side:S3	ENG	[100 to 995 / 105 / 1%/step]
2-451-032	Middle:SizeCorrection:BW	Wide Roller:PaperTransfer:Low:2Side:S3	ENG	[100 to 995 / 110 / 1%/step]
2-451-033	Middle:SizeCorrection:BW	Wide Roller:PaperTransfer:Standard:1Sid:S4	ENG	[100 to 995 / 113 / 1%/step]
2-451-034	Middle:SizeCorrection:BW	Wide Roller:PaperTransfer:Standard:2Sid:S4	ENG	[100 to 995 / 120 / 1%/step]
2-451-035	Middle:SizeCorrection:BW	Wide Roller:PaperTransfer:Low:1Side:S4	ENG	[100 to 995 / 113 / 1%/step]
2-	Middle:SizeCorrection:BW	Wide	ENG	[100 to 995 /

3.SP Mode Tables

SP No.	Large Category	Small Category	ENG or CTL	[Min to Max/Init./Step]
451 - 036		Roller:PaperTransfer:Low:2Side:S4		120 / 1%/step]
2- 451 - 037	Middle:SizeCorrection:BW	Wide Roller:PaperTransfer:Standard:1Sid:S5	ENG	[100 to 995 / 118 / 1%/step]
2- 451 - 038	Middle:SizeCorrection:BW	Wide Roller:PaperTransfer:Standard:2Sid:S5	ENG	[100 to 995 / 140 / 1%/step]
2- 451 - 039	Middle:SizeCorrection:BW	Wide Roller:PaperTransfer:Low:1Side:S5	ENG	[100 to 995 / 118 / 1%/step]
2- 451 - 040	Middle:SizeCorrection:BW	Wide Roller:PaperTransfer:Low:2Side:S5	ENG	[100 to 995 / 140 / 1%/step]
2- 452 - 001	Middle:SizeCorrection:FC	PaperTransfer:Standard:1Sid:S1	ENG	[100 to 995 / 100 / 1%/step]
2- 452 - 002	Middle:SizeCorrection:FC	PaperTransfer:Standard:2Sid:S1	ENG	[100 to 995 / 100 / 1%/step]
2- 452 - 003	Middle:SizeCorrection:FC	PaperTransfer:Low:1Side:S1	ENG	[100 to 995 / 100 / 1%/step]
2- 452 - 004	Middle:SizeCorrection:FC	PaperTransfer:Low:2Side:S1	ENG	[100 to 995 / 100 / 1%/step]
2-	Middle:SizeCorrection:FC	PaperTransfer:Standard:1Sid:S2	ENG	[100 to 995 /

3.SP Mode Tables

SP No.	Large Category	Small Category	ENG or CTL	[Min to Max/Init./Step]
452 - 005				106 / 1%/step]
2- 452 - 006	Middle:SizeCorrection:FC	PaperTransfer:Standard:2Sid:S2	ENG	[100 to 995 / 132 / 1%/step]
2- 452 - 007	Middle:SizeCorrection:FC	PaperTransfer:Low:1Side:S2	ENG	[100 to 995 / 106 / 1%/step]
2- 452 - 008	Middle:SizeCorrection:FC	PaperTransfer:Low:2Side:S2	ENG	[100 to 995 / 132 / 1%/step]
2- 452 - 009	Middle:SizeCorrection:FC	PaperTransfer:Standard:1Sid:S3	ENG	[100 to 995 / 110 / 1%/step]
2- 452 - 010	Middle:SizeCorrection:FC	PaperTransfer:Standard:2Sid:S3	ENG	[100 to 995 / 170 / 1%/step]
2- 452 -011	Middle:SizeCorrection:FC	PaperTransfer:Low:1Side:S3	ENG	[100 to 995 / 110 / 1%/step]
2- 452 - 012	Middle:SizeCorrection:FC	PaperTransfer:Low:2Side:S3	ENG	[100 to 995 / 170 / 1%/step]
2- 452 - 013	Middle:SizeCorrection:FC	PaperTransfer:Standard:1Sid:S4	ENG	[100 to 995 / 120 / 1%/step]
2- 452	Middle:SizeCorrection:FC	PaperTransfer:Standard:2Sid:S4	ENG	[100 to 995 / 189 /

3.SP Mode Tables

SP No.	Large Category	Small Category	ENG or CTL	[Min to Max/Init./Step]
- 014				1%/step]
2- 452 - 015	Middle:SizeCorrection:FC	PaperTransfer:Low:1Side:S4	ENG	[100 to 995 / 120 / 1%/step]
2- 452 - 016	Middle:SizeCorrection:FC	PaperTransfer:Low:2Side:S4	ENG	[100 to 995 / 189 / 1%/step]
2- 452 - 017	Middle:SizeCorrection:FC	PaperTransfer:Standard:1Sid:S5	ENG	[100 to 995 / 140 / 1%/step]
2- 452 - 018	Middle:SizeCorrection:FC	PaperTransfer:Standard:2Sid:S5	ENG	[100 to 995 / 245 / 1%/step]
2- 452 - 019	Middle:SizeCorrection:FC	PaperTransfer:Low:1Side:S5	ENG	[100 to 995 / 140 / 1%/step]
2- 452 - 020	Middle:SizeCorrection:FC	PaperTransfer:Low:2Side:S5	ENG	[100 to 995 / 245 / 1%/step]
2- 452 - 021	Middle:SizeCorrection:FC	Wide Roller:PaperTransfer:Standard:1Sid:S 1	ENG	[100 to 995 / 100 / 1%/step]
2- 452 - 022	Middle:SizeCorrection:FC	Wide Roller:PaperTransfer:Standard:2Sid:S 1	ENG	[100 to 995 / 100 / 1%/step]
2- 452	Middle:SizeCorrection:FC	Wide Roller:PaperTransfer:Low:1Side:S1	ENG	[100 to 995 / 100 /

3.SP Mode Tables

SP No.	Large Category	Small Category	ENG or CTL	[Min to Max/Init./Step]
- 023				1%/step]
2- 452 - 024	Middle:SizeCorrection:FC	Wide Roller:PaperTransfer:Low:2Side:S1	ENG	[100 to 995 / 100 / 1%/step]
2- 452 - 025	Middle:SizeCorrection:FC	Wide Roller:PaperTransfer:Standard:1Sid:S 2	ENG	[100 to 995 / 106 / 1%/step]
2- 452 - 026	Middle:SizeCorrection:FC	Wide Roller:PaperTransfer:Standard:2Sid:S 2	ENG	[100 to 995 / 132 / 1%/step]
2- 452 - 027	Middle:SizeCorrection:FC	Wide Roller:PaperTransfer:Low:1Side:S2	ENG	[100 to 995 / 106 / 1%/step]
2- 452 - 028	Middle:SizeCorrection:FC	Wide Roller:PaperTransfer:Low:2Side:S2	ENG	[100 to 995 / 132 / 1%/step]
2- 452 - 029	Middle:SizeCorrection:FC	Wide Roller:PaperTransfer:Standard:1Sid:S 3	ENG	[100 to 995 / 110 / 1%/step]
2- 452 - 030	Middle:SizeCorrection:FC	Wide Roller:PaperTransfer:Standard:2Sid:S 3	ENG	[100 to 995 / 170 / 1%/step]
2- 452 - 031	Middle:SizeCorrection:FC	Wide Roller:PaperTransfer:Low:1Side:S3	ENG	[100 to 995 / 110 / 1%/step]
2- 452	Middle:SizeCorrection:FC	Wide Roller:PaperTransfer:Low:2Side:S3	ENG	[100 to 995 / 170 /

3.SP Mode Tables

SP No.	Large Category	Small Category	ENG or CTL	[Min to Max/Init./Step]
- 032				1%/step]
2- 452 - 033	Middle:SizeCorrection:FC	Wide Roller:PaperTransfer:Standard:1Sid:S4	ENG	[100 to 995 / 120 / 1%/step]
2- 452 - 034	Middle:SizeCorrection:FC	Wide Roller:PaperTransfer:Standard:2Sid:S4	ENG	[100 to 995 / 189 / 1%/step]
2- 452 - 035	Middle:SizeCorrection:FC	Wide Roller:PaperTransfer:Low:1Side:S4	ENG	[100 to 995 / 120 / 1%/step]
2- 452 - 036	Middle:SizeCorrection:FC	Wide Roller:PaperTransfer:Low:2Side:S4	ENG	[100 to 995 / 189 / 1%/step]
2- 452 - 037	Middle:SizeCorrection:FC	Wide Roller:PaperTransfer:Standard:1Sid:S5	ENG	[100 to 995 / 140 / 1%/step]
2- 452 - 038	Middle:SizeCorrection:FC	Wide Roller:PaperTransfer:Standard:2Sid:S5	ENG	[100 to 995 / 245 / 1%/step]
2- 452 - 039	Middle:SizeCorrection:FC	Wide Roller:PaperTransfer:Low:1Side:S5	ENG	[100 to 995 / 140 / 1%/step]
2- 452 - 040	Middle:SizeCorrection:FC	Wide Roller:PaperTransfer:Low:2Side:S5	ENG	[100 to 995 / 245 / 1%/step]
2- 453	Middle:Size-Env.Correct:BW	PaperTransfer:Standard:1Sid:S1	ENG	[1 to 110 / 10 / 1/step]

3.SP Mode Tables

SP No.	Large Category	Small Category	ENG or CTL	[Min to Max/Init./Step]
-001				
2-453-002	Middle:Size-Env.Correct:BW	PaperTransfer:Standard:2Sid:S1	ENG	[1 to 110 / 41 / 1/step]
2-453-003	Middle:Size-Env.Correct:BW	PaperTransfer:Low:1Side:S1	ENG	[1 to 110 / 10 / 1/step]
2-453-004	Middle:Size-Env.Correct:BW	PaperTransfer:Low:2Side:S1	ENG	[1 to 110 / 41 / 1/step]
2-453-005	Middle:Size-Env.Correct:BW	PaperTransfer:Standard:1Sid:S2	ENG	[1 to 110 / 39 / 1/step]
2-453-006	Middle:Size-Env.Correct:BW	PaperTransfer:Standard:2Sid:S2	ENG	[1 to 110 / 42 / 1/step]
2-453-007	Middle:Size-Env.Correct:BW	PaperTransfer:Low:1Side:S2	ENG	[1 to 110 / 39 / 1/step]
2-453-008	Middle:Size-Env.Correct:BW	PaperTransfer:Low:2Side:S2	ENG	[1 to 110 / 42 / 1/step]
2-453-009	Middle:Size-Env.Correct:BW	PaperTransfer:Standard:1Sid:S3	ENG	[1 to 110 / 40 / 1/step]
2-453	Middle:Size-Env.Correct:BW	PaperTransfer:Standard:2Sid:S3	ENG	[1 to 110 / 43 / 1/step]

3.SP Mode Tables

SP No.	Large Category	Small Category	ENG or CTL	[Min to Max/Init./Step]
-010				
2-453-011	Middle:Size-Env.Correct:BW	PaperTransfer:Low:1Side:S3	ENG	[1 to 110 / 40 / 1/step]
2-453-012	Middle:Size-Env.Correct:BW	PaperTransfer:Low:2Side:S3	ENG	[1 to 110 / 43 / 1/step]
2-453-013	Middle:Size-Env.Correct:BW	PaperTransfer:Standard:1Sid:S4	ENG	[1 to 110 / 40 / 1/step]
2-453-014	Middle:Size-Env.Correct:BW	PaperTransfer:Standard:2Sid:S4	ENG	[1 to 110 / 44 / 1/step]
2-453-015	Middle:Size-Env.Correct:BW	PaperTransfer:Low:1Side:S4	ENG	[1 to 110 / 40 / 1/step]
2-453-016	Middle:Size-Env.Correct:BW	PaperTransfer:Low:2Side:S4	ENG	[1 to 110 / 44 / 1/step]
2-453-017	Middle:Size-Env.Correct:BW	PaperTransfer:Standard:1Sid:S5	ENG	[1 to 110 / 40 / 1/step]
2-453-018	Middle:Size-Env.Correct:BW	PaperTransfer:Standard:2Sid:S5	ENG	[1 to 110 / 45 / 1/step]
2-453-	Middle:Size-Env.Correct:BW	PaperTransfer:Low:1Side:S5	ENG	[1 to 110 / 40 / 1/step]

3.SP Mode Tables

SP No.	Large Category	Small Category	ENG or CTL	[Min to Max/Init./Step]
019				
2-453-020	Middle:Size-Env.Correct:BW	PaperTransfer:Low:2Side:S5	ENG	[1 to 110 / 45 / 1/step]
2-453-021	Middle:Size-Env.Correct:BW	Wide Roller:PaperTransfer:Standard:1Sid:S1	ENG	[1 to 110 / 10 / 1/step]
2-453-022	Middle:Size-Env.Correct:BW	Wide Roller:PaperTransfer:Standard:2Sid:S1	ENG	[1 to 110 / 41 / 1/step]
2-453-023	Middle:Size-Env.Correct:BW	Wide Roller:PaperTransfer:Low:1Side:S1	ENG	[1 to 110 / 10 / 1/step]
2-453-024	Middle:Size-Env.Correct:BW	Wide Roller:PaperTransfer:Low:2Side:S1	ENG	[1 to 110 / 41 / 1/step]
2-453-025	Middle:Size-Env.Correct:BW	Wide Roller:PaperTransfer:Standard:1Sid:S2	ENG	[1 to 110 / 39 / 1/step]
2-453-026	Middle:Size-Env.Correct:BW	Wide Roller:PaperTransfer:Standard:2Sid:S2	ENG	[1 to 110 / 42 / 1/step]
2-453-027	Middle:Size-Env.Correct:BW	Wide Roller:PaperTransfer:Low:1Side:S2	ENG	[1 to 110 / 39 / 1/step]
2-453-	Middle:Size-Env.Correct:BW	Wide Roller:PaperTransfer:Low:2Side:S2	ENG	[1 to 110 / 42 / 1/step]

3.SP Mode Tables

SP No.	Large Category	Small Category	ENG or CTL	[Min to Max/Init./Step]
028				
2-453-029	Middle:Size-Env.Correct:BW	Wide Roller:PaperTransfer:Standard:1Sid:S3	ENG	[1 to 110 / 40 / 1/step]
2-453-030	Middle:Size-Env.Correct:BW	Wide Roller:PaperTransfer:Standard:2Sid:S3	ENG	[1 to 110 / 43 / 1/step]
2-453-031	Middle:Size-Env.Correct:BW	Wide Roller:PaperTransfer:Low:1Side:S3	ENG	[1 to 110 / 40 / 1/step]
2-453-032	Middle:Size-Env.Correct:BW	Wide Roller:PaperTransfer:Low:2Side:S3	ENG	[1 to 110 / 43 / 1/step]
2-453-033	Middle:Size-Env.Correct:BW	Wide Roller:PaperTransfer:Standard:1Sid:S4	ENG	[1 to 110 / 40 / 1/step]
2-453-034	Middle:Size-Env.Correct:BW	Wide Roller:PaperTransfer:Standard:2Sid:S4	ENG	[1 to 110 / 44 / 1/step]
2-453-035	Middle:Size-Env.Correct:BW	Wide Roller:PaperTransfer:Low:1Side:S4	ENG	[1 to 110 / 40 / 1/step]
2-453-036	Middle:Size-Env.Correct:BW	Wide Roller:PaperTransfer:Low:2Side:S4	ENG	[1 to 110 / 44 / 1/step]
2-453-	Middle:Size-Env.Correct:BW	Wide Roller:PaperTransfer:Standard:1Sid:S5	ENG	[1 to 110 / 40 / 1/step]

3.SP Mode Tables

SP No.	Large Category	Small Category	ENG or CTL	[Min to Max/Init./Step]
037				
2-453-038	Middle:Size-Env.Correct:BW	Wide Roller:PaperTransfer:Standard:2Sid:S5	ENG	[1 to 110 / 45 / 1/step]
2-453-039	Middle:Size-Env.Correct:BW	Wide Roller:PaperTransfer:Low:1Side:S5	ENG	[1 to 110 / 40 / 1/step]
2-453-040	Middle:Size-Env.Correct:BW	Wide Roller:PaperTransfer:Low:2Side:S5	ENG	[1 to 110 / 45 / 1/step]
2-454-001	Middle:Size-Env.Correct:FC	PaperTransfer:Standard:1Sid:S1	ENG	[1 to 110 / 20 / 1/step]
2-454-002	Middle:Size-Env.Correct:FC	PaperTransfer:Standard:2Sid:S1	ENG	[1 to 110 / 49 / 1/step]
2-454-003	Middle:Size-Env.Correct:FC	PaperTransfer:Low:1Side:S1	ENG	[1 to 110 / 20 / 1/step]
2-454-004	Middle:Size-Env.Correct:FC	PaperTransfer:Low:2Side:S1	ENG	[1 to 110 / 49 / 1/step]
2-454-005	Middle:Size-Env.Correct:FC	PaperTransfer:Standard:1Sid:S2	ENG	[1 to 110 / 46 / 1/step]
2-454-	Middle:Size-Env.Correct:FC	PaperTransfer:Standard:2Sid:S2	ENG	[1 to 110 / 50 / 1/step]

3.SP Mode Tables

SP No.	Large Category	Small Category	ENG or CTL	[Min to Max/Init./Step]
006				
2-454-007	Middle:Size-Env.Correct:FC	PaperTransfer:Low:1Side:S2	ENG	[1 to 110 / 46 / 1/step]
2-454-008	Middle:Size-Env.Correct:FC	PaperTransfer:Low:2Side:S2	ENG	[1 to 110 / 50 / 1/step]
2-454-009	Middle:Size-Env.Correct:FC	PaperTransfer:Standard:1Sid:S3	ENG	[1 to 110 / 47 / 1/step]
2-454-010	Middle:Size-Env.Correct:FC	PaperTransfer:Standard:2Sid:S3	ENG	[1 to 110 / 51 / 1/step]
2-454-011	Middle:Size-Env.Correct:FC	PaperTransfer:Low:1Side:S3	ENG	[1 to 110 / 47 / 1/step]
2-454-012	Middle:Size-Env.Correct:FC	PaperTransfer:Low:2Side:S3	ENG	[1 to 110 / 51 / 1/step]
2-454-013	Middle:Size-Env.Correct:FC	PaperTransfer:Standard:1Sid:S4	ENG	[1 to 110 / 48 / 1/step]
2-454-014	Middle:Size-Env.Correct:FC	PaperTransfer:Standard:2Sid:S4	ENG	[1 to 110 / 52 / 1/step]
2-454-015	Middle:Size-Env.Correct:FC	PaperTransfer:Low:1Side:S4	ENG	[1 to 110 / 48 / 1/step]

3.SP Mode Tables

SP No.	Large Category	Small Category	ENG or CTL	[Min to Max/Init./Step]
2-454-016	Middle:Size-Env.Correct:FC	PaperTransfer:Low:2Side:S4	ENG	[1 to 110 / 52 / 1/step]
2-454-017	Middle:Size-Env.Correct:FC	PaperTransfer:Standard:1Sid:S5	ENG	[1 to 110 / 48 / 1/step]
2-454-018	Middle:Size-Env.Correct:FC	PaperTransfer:Standard:2Sid:S5	ENG	[1 to 110 / 53 / 1/step]
2-454-019	Middle:Size-Env.Correct:FC	PaperTransfer:Low:1Side:S5	ENG	[1 to 110 / 48 / 1/step]
2-454-020	Middle:Size-Env.Correct:FC	PaperTransfer:Low:2Side:S5	ENG	[1 to 110 / 53 / 1/step]
2-454-021	Middle:Size-Env.Correct:FC	Wide Roller:PaperTransfer:Standard:1Sid:S1	ENG	[1 to 110 / 20 / 1/step]
2-454-022	Middle:Size-Env.Correct:FC	Wide Roller:PaperTransfer:Standard:2Sid:S1	ENG	[1 to 110 / 49 / 1/step]
2-454-023	Middle:Size-Env.Correct:FC	Wide Roller:PaperTransfer:Low:1Side:S1	ENG	[1 to 110 / 20 / 1/step]
2-454-024	Middle:Size-Env.Correct:FC	Wide Roller:PaperTransfer:Low:2Side:S1	ENG	[1 to 110 / 49 / 1/step]

3.SP Mode Tables

SP No.	Large Category	Small Category	ENG or CTL	[Min to Max/Init./Step]
2-454-025	Middle:Size-Env.Correct:FC	Wide Roller:PaperTransfer:Standard:1Sid:S2	ENG	[1 to 110 / 46 / 1/step]
2-454-026	Middle:Size-Env.Correct:FC	Wide Roller:PaperTransfer:Standard:2Sid:S2	ENG	[1 to 110 / 50 / 1/step]
2-454-027	Middle:Size-Env.Correct:FC	Wide Roller:PaperTransfer:Low:1Side:S2	ENG	[1 to 110 / 46 / 1/step]
2-454-028	Middle:Size-Env.Correct:FC	Wide Roller:PaperTransfer:Low:2Side:S2	ENG	[1 to 110 / 50 / 1/step]
2-454-029	Middle:Size-Env.Correct:FC	Wide Roller:PaperTransfer:Standard:1Sid:S3	ENG	[1 to 110 / 47 / 1/step]
2-454-030	Middle:Size-Env.Correct:FC	Wide Roller:PaperTransfer:Standard:2Sid:S3	ENG	[1 to 110 / 51 / 1/step]
2-454-031	Middle:Size-Env.Correct:FC	Wide Roller:PaperTransfer:Low:1Side:S3	ENG	[1 to 110 / 47 / 1/step]
2-454-032	Middle:Size-Env.Correct:FC	Wide Roller:PaperTransfer:Low:2Side:S3	ENG	[1 to 110 / 51 / 1/step]
2-454-033	Middle:Size-Env.Correct:FC	Wide Roller:PaperTransfer:Standard:1Sid:S4	ENG	[1 to 110 / 48 / 1/step]

3.SP Mode Tables

SP No.	Large Category	Small Category	ENG or CTL	[Min to Max/Init./Step]
2-454-034	Middle:Size-Env.Correct:FC	Wide Roller:PaperTransfer:Standard:2Sid:S4	ENG	[1 to 110 / 52 / 1/step]
2-454-035	Middle:Size-Env.Correct:FC	Wide Roller:PaperTransfer:Low:1Side:S4	ENG	[1 to 110 / 48 / 1/step]
2-454-036	Middle:Size-Env.Correct:FC	Wide Roller:PaperTransfer:Low:2Side:S4	ENG	[1 to 110 / 52 / 1/step]
2-454-037	Middle:Size-Env.Correct:FC	Wide Roller:PaperTransfer:Standard:1Sid:S5	ENG	[1 to 110 / 48 / 1/step]
2-454-038	Middle:Size-Env.Correct:FC	Wide Roller:PaperTransfer:Standard:2Sid:S5	ENG	[1 to 110 / 53 / 1/step]
2-454-039	Middle:Size-Env.Correct:FC	Wide Roller:PaperTransfer:Low:1Side:S5	ENG	[1 to 110 / 48 / 1/step]
2-454-040	Middle:Size-Env.Correct:FC	Wide Roller:PaperTransfer:Low:2Side:S5	ENG	[1 to 110 / 53 / 1/step]
2-455-001	Middle:LeadingEdgeCorrection	PaperTransfer:Standard:1Side	ENG	[0 to 995 / 100 / 5%/step]
2-455-002	Middle:LeadingEdgeCorrection	PaperTransfer:Standard:2Side	ENG	[0 to 995 / 100 / 5%/step]

3.SP Mode Tables

SP No.	Large Category	Small Category	ENG or CTL	[Min to Max/Init./Step]
2-455-003	Middle:LeadingEdgeCorrection	Paper Transfer:Low:1side	ENG	[0 to 995 / 100 / 5%/step]
2-455-004	Middle:LeadingEdgeCorrection	Paper Transfer:Low:2side	ENG	[0 to 995 / 100 / 5%/step]
2-456-001	Middle:SwitchTimingLeadEdge	PaperTransfer:Standard:1side	ENG	[0 to 50 / 0 / 2mm/step]
2-456-002	Middle:SwitchTimingLeadEdge	PaperTransfer:Standard:2side	ENG	[0 to 50 / 0 / 2mm/step]
2-456-003	Middle:SwitchTimingLeadEdge	Paper Transfer:Low:1side	ENG	[0 to 50 / 0 / 2mm/step]
2-456-004	Middle:SwitchTimingLeadEdge	Paper Transfer:Low:2side	ENG	[0 to 50 / 0 / 2mm/step]
2-457-001	Middle:TrailEdgeCorrection	PaperTransfer:Standard:1Side	ENG	[0 to 995 / 100 / 5%/step]
2-457-002	Middle:TrailEdgeCorrection	PaperTransfer:Standard:2Side	ENG	[0 to 995 / 100 / 5%/step]
2-457-003	Middle:TrailEdgeCorrection	Paper Transfer:Low:1side	ENG	[0 to 995 / 100 / 5%/step]

3.SP Mode Tables

SP No.	Large Category	Small Category	ENG or CTL	[Min to Max/Init./Step]
2-457-004	Middle:TrailEdgeCorrection	Paper Transfer:Low:2side	ENG	[0 to 995 / 100 / 5%/step]
2-458-001	Middle:SwitchTimingTrailEdge	PaperTransfer:Standard:1side	ENG	[0 to 50 / 0 / 2mm/step]
2-458-002	Middle:SwitchTimingTrailEdge	PaperTransfer:Standard:2side	ENG	[0 to 50 / 0 / 2mm/step]
2-458-003	Middle:SwitchTimingTrailEdge	Paper Transfer:Low:1side	ENG	[0 to 50 / 0 / 2mm/step]
2-458-004	Middle:SwitchTimingTrailEdge	Paper Transfer:Low:2side	ENG	[0 to 50 / 0 / 2mm/step]
2-463-001	Thin:Bias:BW	PaperTransfer:Standard:1Sid	ENG	IM C6000: [0 to 250 / 38 / 1-uA/step] IM C5500: [0 to 250 / 38 / 1-uA/step] IM C4500: [0 to 250 / 28 / 1-uA/step]
2-463-002	Thin:Bias:BW	PaperTransfer:Standard:2Sid	ENG	IM C6000: [0 to 250 / 38 / 1-uA/step] IM C5500: [0 to 250 / 38 / 1-uA/step] IM C4500:

3.SP Mode Tables

SP No.	Large Category	Small Category	ENG or CTL	[Min to Max/Init./Step]
				[0 to 250 / 28 / 1-uA/step]
2-463-003	Thin: Bias: BW	Paper Transfer: Low: 1side	ENG	IM C6000: [0 to 250 / 11 / 1-uA/step] IM C5500: [0 to 250 / 11 / 1-uA/step] IM C4500: [0 to 250 / 11 / 1-uA/step]
2-463-004	Thin: Bias: BW	Paper Transfer: Low: 2side	ENG	IM C6000: [0 to 250 / 11 / 1-uA/step] IM C5500: [0 to 250 / 11 / 1-uA/step] IM C4500: [0 to 250 / 11 / 1-uA/step]
2-467-001	Thin: Bias: FC	Paper Transfer: Standard: 1Sid	ENG	IM C6000: [0 to 250 / 50 / 1-uA/step] IM C5500: [0 to 250 / 50 / 1-uA/step] IM C4500: [0 to 250 / 36 / 1-uA/step]
2-467-002	Thin: Bias: FC	Paper Transfer: Standard: 2Sid	ENG	IM C6000: [0 to 250 / 50 / 1-uA/step] IM C5500: [0 to 250 / 50 / 1-uA/step] IM C4500:

3.SP Mode Tables

SP No.	Large Category	Small Category	ENG or CTL	[Min to Max/Init./Step]
				[0 to 250 / 36 / 1-uA/step]
2-467-003	Thin: Bias: FC	Paper Transfer: Low: 1side	ENG	IM C6000: [0 to 250 / 14 / 1-uA/step] IM C5500: [0 to 250 / 14 / 1-uA/step] IM C4500: [0 to 250 / 14 / 1-uA/step]
2-467-004	Thin: Bias: FC	Paper Transfer: Low: 2side	ENG	IM C6000: [0 to 250 / 14 / 1-uA/step] IM C5500: [0 to 250 / 14 / 1-uA/step] IM C4500: [0 to 250 / 14 / 1-uA/step]
2-471-001	Thin: SizeCorrection: BW	PaperTransfer: Standard: 1Sid: S1	ENG	[100 to 995 / 100 / 1%/step]
2-471-002	Thin: SizeCorrection: BW	PaperTransfer: Standard: 2Sid: S1	ENG	[100 to 995 / 100 / 1%/step]
2-471-003	Thin: SizeCorrection: BW	PaperTransfer: Low: 1Side: S1	ENG	[100 to 995 / 100 / 1%/step]
2-471-004	Thin: SizeCorrection: BW	PaperTransfer: Low: 2Side: S1	ENG	[100 to 995 / 100 / 1%/step]

3.SP Mode Tables

SP No.	Large Category	Small Category	ENG or CTL	[Min to Max/Init./Step]
2-471-005	Thin:SizeCorrection:BW	PaperTransfer:Standard:1Sid:S2	ENG	[100 to 995 / 100 / 1%/step]
2-471-006	Thin:SizeCorrection:BW	PaperTransfer:Standard:2Sid:S2	ENG	[100 to 995 / 105 / 1%/step]
2-471-007	Thin:SizeCorrection:BW	PaperTransfer:Low:1Side:S2	ENG	[100 to 995 / 100 / 1%/step]
2-471-008	Thin:SizeCorrection:BW	PaperTransfer:Low:2Side:S2	ENG	[100 to 995 / 105 / 1%/step]
2-471-009	Thin:SizeCorrection:BW	PaperTransfer:Standard:1Sid:S3	ENG	[100 to 995 / 111 / 1%/step]
2-471-010	Thin:SizeCorrection:BW	PaperTransfer:Standard:2Sid:S3	ENG	[100 to 995 / 140 / 1%/step]
2-471-011	Thin:SizeCorrection:BW	PaperTransfer:Low:1Side:S3	ENG	[100 to 995 / 111 / 1%/step]
2-471-012	Thin:SizeCorrection:BW	PaperTransfer:Low:2Side:S3	ENG	[100 to 995 / 140 / 1%/step]
2-471-013	Thin:SizeCorrection:BW	PaperTransfer:Standard:1Sid:S4	ENG	[100 to 995 / 121 / 1%/step]
2-	Thin:SizeCorrection:BW	PaperTransfer:Standard:2Sid:S4	ENG	[100 to 995 /

3.SP Mode Tables

SP No.	Large Category	Small Category	ENG or CTL	[Min to Max/Init./Step]
471 - 014				175 / 1%/step]
2- 471 - 015	Thin:SizeCorrection:BW	PaperTransfer:Low:1Side:S4	ENG	[100 to 995 / 121 / 1%/step]
2- 471 - 016	Thin:SizeCorrection:BW	PaperTransfer:Low:2Side:S4	ENG	[100 to 995 / 175 / 1%/step]
2- 471 - 017	Thin:SizeCorrection:BW	PaperTransfer:Standard:1Sid:S5	ENG	[100 to 995 / 132 / 1%/step]
2- 471 - 018	Thin:SizeCorrection:BW	PaperTransfer:Standard:2Sid:S5	ENG	[100 to 995 / 211 / 1%/step]
2- 471 - 019	Thin:SizeCorrection:BW	PaperTransfer:Low:1Side:S5	ENG	[100 to 995 / 132 / 1%/step]
2- 471 - 020	Thin:SizeCorrection:BW	PaperTransfer:Low:2Side:S5	ENG	[100 to 995 / 211 / 1%/step]
2- 471 - 021	Thin:SizeCorrection:BW	Wide Roller:PaperTransfer:Standard:1Sid:S 1	ENG	[100 to 995 / 100 / 1%/step]
2- 471 - 022	Thin:SizeCorrection:BW	Wide Roller:PaperTransfer:Standard:2Sid:S 1	ENG	[100 to 995 / 100 / 1%/step]
2-	Thin:SizeCorrection:BW	Wide	ENG	[100 to 995 /

3.SP Mode Tables

SP No.	Large Category	Small Category	ENG or CTL	[Min to Max/Init./Step]
471 - 023		Roller:PaperTransfer:Low:1Side:S1		100 / 1%/step]
2- 471 - 024	Thin:SizeCorrection:BW	Wide Roller:PaperTransfer:Low:2Side:S1	ENG	[100 to 995 / 100 / 1%/step]
2- 471 - 025	Thin:SizeCorrection:BW	Wide Roller:PaperTransfer:Standard:1Sid:S 2	ENG	[100 to 995 / 100 / 1%/step]
2- 471 - 026	Thin:SizeCorrection:BW	Wide Roller:PaperTransfer:Standard:2Sid:S 2	ENG	[100 to 995 / 105 / 1%/step]
2- 471 - 027	Thin:SizeCorrection:BW	Wide Roller:PaperTransfer:Low:1Side:S2	ENG	[100 to 995 / 100 / 1%/step]
2- 471 - 028	Thin:SizeCorrection:BW	Wide Roller:PaperTransfer:Low:2Side:S2	ENG	[100 to 995 / 105 / 1%/step]
2- 471 - 029	Thin:SizeCorrection:BW	Wide Roller:PaperTransfer:Standard:1Sid:S 3	ENG	[100 to 995 / 111 / 1%/step]
2- 471 - 030	Thin:SizeCorrection:BW	Wide Roller:PaperTransfer:Standard:2Sid:S 3	ENG	[100 to 995 / 140 / 1%/step]
2- 471 - 031	Thin:SizeCorrection:BW	Wide Roller:PaperTransfer:Low:1Side:S3	ENG	[100 to 995 / 111 / 1%/step]
2-	Thin:SizeCorrection:BW	Wide	ENG	[100 to 995 /

3.SP Mode Tables

SP No.	Large Category	Small Category	ENG or CTL	[Min to Max/Init./Step]
471-032		Roller:PaperTransfer:Low:2Side:S3		140 / 1%/step]
2-471-033	Thin:SizeCorrection:BW	Wide Roller:PaperTransfer:Standard:1Sid:S4	ENG	[100 to 995 / 121 / 1%/step]
2-471-034	Thin:SizeCorrection:BW	Wide Roller:PaperTransfer:Standard:2Sid:S4	ENG	[100 to 995 / 175 / 1%/step]
2-471-035	Thin:SizeCorrection:BW	Wide Roller:PaperTransfer:Low:1Side:S4	ENG	[100 to 995 / 121 / 1%/step]
2-471-036	Thin:SizeCorrection:BW	Wide Roller:PaperTransfer:Low:2Side:S4	ENG	[100 to 995 / 175 / 1%/step]
2-471-037	Thin:SizeCorrection:BW	Wide Roller:PaperTransfer:Standard:1Sid:S5	ENG	[100 to 995 / 132 / 1%/step]
2-471-038	Thin:SizeCorrection:BW	Wide Roller:PaperTransfer:Standard:2Sid:S5	ENG	[100 to 995 / 211 / 1%/step]
2-471-039	Thin:SizeCorrection:BW	Wide Roller:PaperTransfer:Low:1Side:S5	ENG	[100 to 995 / 132 / 1%/step]
2-471-040	Thin:SizeCorrection:BW	Wide Roller:PaperTransfer:Low:2Side:S5	ENG	[100 to 995 / 211 / 1%/step]
2-	Thin:SizeCorrection:FC	PaperTransfer:Standard:1Sid:S1	ENG	[100 to 995 /

3.SP Mode Tables

SP No.	Large Category	Small Category	ENG or CTL	[Min to Max/Init./Step]
472 - 001				100 / 1%/step]
2- 472 - 002	Thin:SizeCorrection:FC	PaperTransfer:Standard:1Sid:S1	ENG	[100 to 995 / 100 / 1%/step]
2- 472 - 003	Thin:SizeCorrection:FC	PaperTransfer:Low:1Side:S1	ENG	[100 to 995 / 100 / 1%/step]
2- 472 - 004	Thin:SizeCorrection:FC	PaperTransfer:Low:1Side:S1	ENG	[100 to 995 / 100 / 1%/step]
2- 472 - 005	Thin:SizeCorrection:FC	PaperTransfer:Standard:1Sid:S2	ENG	[100 to 995 / 106 / 1%/step]
2- 472 - 006	Thin:SizeCorrection:FC	PaperTransfer:Standard:1Sid:S2	ENG	[100 to 995 / 130 / 1%/step]
2- 472 - 007	Thin:SizeCorrection:FC	PaperTransfer:Low:1Side:S2	ENG	[100 to 995 / 106 / 1%/step]
2- 472 - 008	Thin:SizeCorrection:FC	PaperTransfer:Low:1Side:S2	ENG	[100 to 995 / 130 / 1%/step]
2- 472 - 009	Thin:SizeCorrection:FC	PaperTransfer:Standard:1Sid:S3	ENG	[100 to 995 / 117 / 1%/step]
2-	Thin:SizeCorrection:FC	PaperTransfer:Standard:1Sid:S3	ENG	[100 to 995 /

3.SP Mode Tables

SP No.	Large Category	Small Category	ENG or CTL	[Min to Max/Init./Step]
472 - 010				153 / 1%/step]
2- 472 -011	Thin:SizeCorrection:FC	PaperTransfer:Low:1Side:S3	ENG	[100 to 995 / 117 / 1%/step]
2- 472 - 012	Thin:SizeCorrection:FC	PaperTransfer:Low:1Side:S3	ENG	[100 to 995 / 153 / 1%/step]
2- 472 - 013	Thin:SizeCorrection:FC	PaperTransfer:Standard:1Sid:S4	ENG	[100 to 995 / 128 / 1%/step]
2- 472 - 014	Thin:SizeCorrection:FC	PaperTransfer:Standard:1Sid:S4	ENG	[100 to 995 / 177 / 1%/step]
2- 472 - 015	Thin:SizeCorrection:FC	PaperTransfer:Low:1Side:S4	ENG	[100 to 995 / 128 / 1%/step]
2- 472 - 016	Thin:SizeCorrection:FC	PaperTransfer:Low:1Side:S4	ENG	[100 to 995 / 177 / 1%/step]
2- 472 - 017	Thin:SizeCorrection:FC	PaperTransfer:Standard:1Sid:S5	ENG	[100 to 995 / 140 / 1%/step]
2- 472 - 018	Thin:SizeCorrection:FC	PaperTransfer:Standard:2Sid:S5	ENG	[100 to 995 / 200 / 1%/step]
2- 472	Thin:SizeCorrection:FC	PaperTransfer:Low:1Side:S5	ENG	[100 to 995 / 140 /

3.SP Mode Tables

SP No.	Large Category	Small Category	ENG or CTL	[Min to Max/Init./Step]
- 019				1%/step]
2- 472 - 020	Thin:SizeCorrection:FC	PaperTransfer:Low:2Side:S5	ENG	[100 to 995 / 200 / 1%/step]
2- 472 - 021	Thin:SizeCorrection:FC	Wide Roller:PaperTransfer:Standard:1Sid:S 1	ENG	[100 to 995 / 100 / 1%/step]
2- 472 - 022	Thin:SizeCorrection:FC	Wide Roller:PaperTransfer:Standard:2Sid:S 1	ENG	[100 to 995 / 100 / 1%/step]
2- 472 - 023	Thin:SizeCorrection:FC	Wide Roller:PaperTransfer:Low:1Side:S1	ENG	[100 to 995 / 100 / 1%/step]
2- 472 - 024	Thin:SizeCorrection:FC	Wide Roller:PaperTransfer:Low:2Side:S1	ENG	[100 to 995 / 100 / 1%/step]
2- 472 - 025	Thin:SizeCorrection:FC	Wide Roller:PaperTransfer:Standard:1Sid:S 2	ENG	[100 to 995 / 106 / 1%/step]
2- 472 - 026	Thin:SizeCorrection:FC	Wide Roller:PaperTransfer:Standard:2Sid:S 2	ENG	[100 to 995 / 130 / 1%/step]
2- 472 - 027	Thin:SizeCorrection:FC	Wide Roller:PaperTransfer:Low:1Side:S2	ENG	[100 to 995 / 106 / 1%/step]
2- 472	Thin:SizeCorrection:FC	Wide Roller:PaperTransfer:Low:2Side:S2	ENG	[100 to 995 / 130 /

3.SP Mode Tables

SP No.	Large Category	Small Category	ENG or CTL	[Min to Max/Init./Step]
- 028				1%/step]
2- 472 - 029	Thin:SizeCorrection:FC	Wide Roller:PaperTransfer:Standard:1Sid:S 3	ENG	[100 to 995 / 117 / 1%/step]
2- 472 - 030	Thin:SizeCorrection:FC	Wide Roller:PaperTransfer:Standard:2Sid:S 3	ENG	[100 to 995 / 153 / 1%/step]
2- 472 - 031	Thin:SizeCorrection:FC	Wide Roller:PaperTransfer:Low:1Side:S3	ENG	[100 to 995 / 117 / 1%/step]
2- 472 - 032	Thin:SizeCorrection:FC	Wide Roller:PaperTransfer:Low:2Side:S3	ENG	[100 to 995 / 153 / 1%/step]
2- 472 - 033	Thin:SizeCorrection:FC	Wide Roller:PaperTransfer:Standard:1Sid:S 4	ENG	[100 to 995 / 128 / 1%/step]
2- 472 - 034	Thin:SizeCorrection:FC	Wide Roller:PaperTransfer:Standard:2Sid:S 4	ENG	[100 to 995 / 177 / 1%/step]
2- 472 - 035	Thin:SizeCorrection:FC	Wide Roller:PaperTransfer:Low:1Side:S4	ENG	[100 to 995 / 128 / 1%/step]
2- 472 - 036	Thin:SizeCorrection:FC	Wide Roller:PaperTransfer:Low:2Side:S4	ENG	[100 to 995 / 177 / 1%/step]
2- 472	Thin:SizeCorrection:FC	Wide Roller:PaperTransfer:Standard:1Sid:S	ENG	[100 to 995 / 140 /

3.SP Mode Tables

SP No.	Large Category	Small Category	ENG or CTL	[Min to Max/Init./Step]
- 037		5		1%/step]
2- 472 - 038	Thin:SizeCorrection:FC	Wide Roller:PaperTransfer:Standard:2Sid:S 5	ENG	[100 to 995 / 200 / 1%/step]
2- 472 - 039	Thin:SizeCorrection:FC	Wide Roller:PaperTransfer:Low:1Side:S5	ENG	[100 to 995 / 140 / 1%/step]
2- 472 - 040	Thin:SizeCorrection:FC	Wide Roller:PaperTransfer:Low:2Side:S5	ENG	[100 to 995 / 200 / 1%/step]
2- 473 - 001	Thin:Size-Env.Correct:BW	PaperTransfer:Standard:1Sid:S1	ENG	[1 to 110 / 10 / 1/step]
2- 473 - 002	Thin:Size-Env.Correct:BW	PaperTransfer:Standard:1Sid:S1	ENG	[1 to 110 / 15 / 1/step]
2- 473 - 003	Thin:Size-Env.Correct:BW	PaperTransfer:Low:1Side:S1	ENG	[1 to 110 / 10 / 1/step]
2- 473 - 004	Thin:Size-Env.Correct:BW	PaperTransfer:Low:1Side:S1	ENG	[1 to 110 / 15 / 1/step]
2- 473 - 005	Thin:Size-Env.Correct:BW	PaperTransfer:Standard:1Sid:S2	ENG	[1 to 110 / 11 / 1/step]
2- 473	Thin:Size-Env.Correct:BW	PaperTransfer:Standard:1Sid:S2	ENG	[1 to 110 / 16 / 1/step]

3.SP Mode Tables

SP No.	Large Category	Small Category	ENG or CTL	[Min to Max/Init./Step]
-006				
2-473-007	Thin:Size-Env.Correct:BW	PaperTransfer:Low:1Side:S2	ENG	[1 to 110 / 11 / 1/step]
2-473-008	Thin:Size-Env.Correct:BW	PaperTransfer:Low:1Side:S2	ENG	[1 to 110 / 16 / 1/step]
2-473-009	Thin:Size-Env.Correct:BW	PaperTransfer:Standard:1Sid:S3	ENG	[1 to 110 / 12 / 1/step]
2-473-010	Thin:Size-Env.Correct:BW	PaperTransfer:Standard:1Sid:S3	ENG	[1 to 110 / 30 / 1/step]
2-473-011	Thin:Size-Env.Correct:BW	PaperTransfer:Low:1Side:S3	ENG	[1 to 110 / 12 / 1/step]
2-473-012	Thin:Size-Env.Correct:BW	PaperTransfer:Low:1Side:S3	ENG	[1 to 110 / 30 / 1/step]
2-473-013	Thin:Size-Env.Correct:BW	PaperTransfer:Standard:1Sid:S4	ENG	[1 to 110 / 13 / 1/step]
2-473-014	Thin:Size-Env.Correct:BW	PaperTransfer:Standard:1Sid:S4	ENG	[1 to 110 / 31 / 1/step]
2-473-	Thin:Size-Env.Correct:BW	PaperTransfer:Low:1Side:S4	ENG	[1 to 110 / 13 / 1/step]

3.SP Mode Tables

SP No.	Large Category	Small Category	ENG or CTL	[Min to Max/Init./Step]
015				
2-473-016	Thin:Size-Env.Correct:BW	PaperTransfer:Low:1Side:S4	ENG	[1 to 110 / 31 / 1/step]
2-473-017	Thin:Size-Env.Correct:BW	PaperTransfer:Standard:1Sid:S5	ENG	[1 to 110 / 14 / 1/step]
2-473-018	Thin:Size-Env.Correct:BW	PaperTransfer:Standard:2Sid:S5	ENG	[1 to 110 / 32 / 1/step]
2-473-019	Thin:Size-Env.Correct:BW	PaperTransfer:Low:1Side:S5	ENG	[1 to 110 / 14 / 1/step]
2-473-020	Thin:Size-Env.Correct:BW	PaperTransfer:Low:2Side:S5	ENG	[1 to 110 / 32 / 1/step]
2-473-021	Thin:Size-Env.Correct:BW	Wide Roller:PaperTransfer:Standard:1Sid:S1	ENG	[1 to 110 / 10 / 1/step]
2-473-022	Thin:Size-Env.Correct:BW	Wide Roller:PaperTransfer:Standard:2Sid:S1	ENG	[1 to 110 / 15 / 1/step]
2-473-023	Thin:Size-Env.Correct:BW	Wide Roller:PaperTransfer:Low:1Side:S1	ENG	[1 to 110 / 10 / 1/step]
2-473-	Thin:Size-Env.Correct:BW	Wide Roller:PaperTransfer:Low:2Side:S1	ENG	[1 to 110 / 15 / 1/step]

3.SP Mode Tables

SP No.	Large Category	Small Category	ENG or CTL	[Min to Max/Init./Step]
024				
2-473-025	Thin:Size-Env.Correct:BW	Wide Roller:PaperTransfer:Standard:1Sid:S2	ENG	[1 to 110 / 11 / 1/step]
2-473-026	Thin:Size-Env.Correct:BW	Wide Roller:PaperTransfer:Standard:2Sid:S2	ENG	[1 to 110 / 16 / 1/step]
2-473-027	Thin:Size-Env.Correct:BW	Wide Roller:PaperTransfer:Low:1Side:S2	ENG	[1 to 110 / 11 / 1/step]
2-473-028	Thin:Size-Env.Correct:BW	Wide Roller:PaperTransfer:Low:2Side:S2	ENG	[1 to 110 / 16 / 1/step]
2-473-029	Thin:Size-Env.Correct:BW	Wide Roller:PaperTransfer:Standard:1Sid:S3	ENG	[1 to 110 / 12 / 1/step]
2-473-030	Thin:Size-Env.Correct:BW	Wide Roller:PaperTransfer:Standard:2Sid:S3	ENG	[1 to 110 / 30 / 1/step]
2-473-031	Thin:Size-Env.Correct:BW	Wide Roller:PaperTransfer:Low:1Side:S3	ENG	[1 to 110 / 12 / 1/step]
2-473-032	Thin:Size-Env.Correct:BW	Wide Roller:PaperTransfer:Low:2Side:S3	ENG	[1 to 110 / 30 / 1/step]
2-473-	Thin:Size-Env.Correct:BW	Wide Roller:PaperTransfer:Standard:1Sid:S4	ENG	[1 to 110 / 13 / 1/step]

3.SP Mode Tables

SP No.	Large Category	Small Category	ENG or CTL	[Min to Max/Init./Step]
033				
2-473-034	Thin:Size-Env.Correct:BW	Wide Roller:PaperTransfer:Standard:2Sid:S4	ENG	[1 to 110 / 31 / 1/step]
2-473-035	Thin:Size-Env.Correct:BW	Wide Roller:PaperTransfer:Low:1Side:S4	ENG	[1 to 110 / 13 / 1/step]
2-473-036	Thin:Size-Env.Correct:BW	Wide Roller:PaperTransfer:Low:2Side:S4	ENG	[1 to 110 / 31 / 1/step]
2-473-037	Thin:Size-Env.Correct:BW	Wide Roller:PaperTransfer:Standard:1Sid:S5	ENG	[1 to 110 / 14 / 1/step]
2-473-038	Thin:Size-Env.Correct:BW	Wide Roller:PaperTransfer:Standard:2Sid:S5	ENG	[1 to 110 / 32 / 1/step]
2-473-039	Thin:Size-Env.Correct:BW	Wide Roller:PaperTransfer:Low:1Side:S5	ENG	[1 to 110 / 14 / 1/step]
2-473-040	Thin:Size-Env.Correct:BW	Wide Roller:PaperTransfer:Low:2Side:S5	ENG	[1 to 110 / 32 / 1/step]
2-474-001	Thin:Size-Env.Correct:FC	PaperTransfer:Standard:1Sid:S1	ENG	[1 to 110 / 20 / 1/step]
2-474-	Thin:Size-Env.Correct:FC	PaperTransfer:Standard:1Sid:S1	ENG	[1 to 110 / 25 / 1/step]

3.SP Mode Tables

SP No.	Large Category	Small Category	ENG or CTL	[Min to Max/Init./Step]
002				
2-474-003	Thin:Size-Env.Correct:FC	PaperTransfer:Low:1Side:S1	ENG	[1 to 110 / 20 / 1/step]
2-474-004	Thin:Size-Env.Correct:FC	PaperTransfer:Low:1Side:S1	ENG	[1 to 110 / 25 / 1/step]
2-474-005	Thin:Size-Env.Correct:FC	PaperTransfer:Standard:1Sid:S2	ENG	[1 to 110 / 21 / 1/step]
2-474-006	Thin:Size-Env.Correct:FC	PaperTransfer:Standard:1Sid:S2	ENG	[1 to 110 / 35 / 1/step]
2-474-007	Thin:Size-Env.Correct:FC	PaperTransfer:Low:1Side:S2	ENG	[1 to 110 / 21 / 1/step]
2-474-008	Thin:Size-Env.Correct:FC	PaperTransfer:Low:1Side:S2	ENG	[1 to 110 / 35 / 1/step]
2-474-009	Thin:Size-Env.Correct:FC	PaperTransfer:Standard:1Sid:S3	ENG	[1 to 110 / 33 / 1/step]
2-474-010	Thin:Size-Env.Correct:FC	PaperTransfer:Standard:1Sid:S3	ENG	[1 to 110 / 36 / 1/step]
2-474-011	Thin:Size-Env.Correct:FC	PaperTransfer:Low:1Side:S3	ENG	[1 to 110 / 33 / 1/step]

3.SP Mode Tables

SP No.	Large Category	Small Category	ENG or CTL	[Min to Max/Init./Step]
2-474-012	Thin:Size-Env.Correct:FC	PaperTransfer:Low:1Side:S3	ENG	[1 to 110 / 36 / 1/step]
2-474-013	Thin:Size-Env.Correct:FC	PaperTransfer:Standard:1Sid:S4	ENG	[1 to 110 / 34 / 1/step]
2-474-014	Thin:Size-Env.Correct:FC	PaperTransfer:Standard:1Sid:S4	ENG	[1 to 110 / 37 / 1/step]
2-474-015	Thin:Size-Env.Correct:FC	PaperTransfer:Low:1Side:S4	ENG	[1 to 110 / 34 / 1/step]
2-474-016	Thin:Size-Env.Correct:FC	PaperTransfer:Low:1Side:S4	ENG	[1 to 110 / 37 / 1/step]
2-474-017	Thin:Size-Env.Correct:FC	PaperTransfer:Standard:1Sid:S5	ENG	[1 to 110 / 24 / 1/step]
2-474-018	Thin:Size-Env.Correct:FC	PaperTransfer:Standard:2Sid:S5	ENG	[1 to 110 / 38 / 1/step]
2-474-019	Thin:Size-Env.Correct:FC	PaperTransfer:Low:1Side:S5	ENG	[1 to 110 / 24 / 1/step]
2-474-020	Thin:Size-Env.Correct:FC	PaperTransfer:Low:2Side:S5	ENG	[1 to 110 / 38 / 1/step]

3.SP Mode Tables

SP No.	Large Category	Small Category	ENG or CTL	[Min to Max/Init./Step]
2-474-021	Thin:Size-Env.Correct:FC	Wide Roller:PaperTransfer:Standard:1Sid:S1	ENG	[1 to 110 / 20 / 1/step]
2-474-022	Thin:Size-Env.Correct:FC	Wide Roller:PaperTransfer:Standard:2Sid:S1	ENG	[1 to 110 / 25 / 1/step]
2-474-023	Thin:Size-Env.Correct:FC	Wide Roller:PaperTransfer:Low:1Side:S1	ENG	[1 to 110 / 20 / 1/step]
2-474-024	Thin:Size-Env.Correct:FC	Wide Roller:PaperTransfer:Low:2Side:S1	ENG	[1 to 110 / 25 / 1/step]
2-474-025	Thin:Size-Env.Correct:FC	Wide Roller:PaperTransfer:Standard:1Sid:S2	ENG	[1 to 110 / 21 / 1/step]
2-474-026	Thin:Size-Env.Correct:FC	Wide Roller:PaperTransfer:Standard:2Sid:S2	ENG	[1 to 110 / 35 / 1/step]
2-474-027	Thin:Size-Env.Correct:FC	Wide Roller:PaperTransfer:Low:1Side:S2	ENG	[1 to 110 / 21 / 1/step]
2-474-028	Thin:Size-Env.Correct:FC	Wide Roller:PaperTransfer:Low:2Side:S2	ENG	[1 to 110 / 35 / 1/step]
2-474-029	Thin:Size-Env.Correct:FC	Wide Roller:PaperTransfer:Standard:1Sid:S3	ENG	[1 to 110 / 33 / 1/step]

3.SP Mode Tables

SP No.	Large Category	Small Category	ENG or CTL	[Min to Max/Init./Step]
2-474-030	Thin:Size-Env.Correct:FC	Wide Roller:PaperTransfer:Standard:2Sid:S3	ENG	[1 to 110 / 36 / 1/step]
2-474-031	Thin:Size-Env.Correct:FC	Wide Roller:PaperTransfer:Low:1Side:S3	ENG	[1 to 110 / 33 / 1/step]
2-474-032	Thin:Size-Env.Correct:FC	Wide Roller:PaperTransfer:Low:2Side:S3	ENG	[1 to 110 / 36 / 1/step]
2-474-033	Thin:Size-Env.Correct:FC	Wide Roller:PaperTransfer:Standard:1Sid:S4	ENG	[1 to 110 / 34 / 1/step]
2-474-034	Thin:Size-Env.Correct:FC	Wide Roller:PaperTransfer:Standard:2Sid:S4	ENG	[1 to 110 / 37 / 1/step]
2-474-035	Thin:Size-Env.Correct:FC	Wide Roller:PaperTransfer:Low:1Side:S4	ENG	[1 to 110 / 34 / 1/step]
2-474-036	Thin:Size-Env.Correct:FC	Wide Roller:PaperTransfer:Low:2Side:S4	ENG	[1 to 110 / 37 / 1/step]
2-474-037	Thin:Size-Env.Correct:FC	Wide Roller:PaperTransfer:Standard:1Sid:S5	ENG	[1 to 110 / 24 / 1/step]
2-474-038	Thin:Size-Env.Correct:FC	Wide Roller:PaperTransfer:Standard:2Sid:S5	ENG	[1 to 110 / 38 / 1/step]

3.SP Mode Tables

SP No.	Large Category	Small Category	ENG or CTL	[Min to Max/Init./Step]
2-474-039	Thin:Size-Env.Correct:FC	Wide Roller:PaperTransfer:Low:1Side:S5	ENG	[1 to 110 / 24 / 1/step]
2-474-040	Thin:Size-Env.Correct:FC	Wide Roller:PaperTransfer:Low:2Side:S5	ENG	[1 to 110 / 38 / 1/step]
2-475-001	Thin:LeadingEdgeCorrection	PaperTransfer:Standard:1Side	ENG	[0 to 995 / 100 / 5%/step]
2-475-002	Thin:LeadingEdgeCorrection	PaperTransfer:Standard:2Side	ENG	[0 to 995 / 100 / 5%/step]
2-475-003	Thin:LeadingEdgeCorrection	Paper Transfer:Low:1side	ENG	[0 to 995 / 100 / 5%/step]
2-475-004	Thin:LeadingEdgeCorrection	Paper Transfer:Low:2side	ENG	[0 to 995 / 100 / 5%/step]
2-476-001	Thin:SwitchTimingLeadEdge	PaperTransfer:Standard:1side	ENG	[0 to 50 / 0 / 2mm/step]
2-476-002	Thin:SwitchTimingLeadEdge	PaperTransfer:Standard:2side	ENG	[0 to 50 / 0 / 2mm/step]
2-476-003	Thin:SwitchTimingLeadEdge	Paper Transfer:Low:1side	ENG	[0 to 50 / 0 / 2mm/step]

3.SP Mode Tables

SP No.	Large Category	Small Category	ENG or CTL	[Min to Max/Init./Step]
2-476-004	Thin:SwitchTimingLeadEdge	Paper Transfer:Low:2side	ENG	[0 to 50 / 0 / 2mm/step]
2-477-001	Thin:TrailEdgeCorrection	PaperTransfer:Standard:1Side	ENG	[0 to 995 / 100 / 5%/step]
2-477-002	Thin:TrailEdgeCorrection	PaperTransfer:Standard:2Side	ENG	[0 to 995 / 100 / 5%/step]
2-477-003	Thin:TrailEdgeCorrection	Paper Transfer:Low:1side	ENG	[0 to 995 / 100 / 5%/step]
2-477-004	Thin:TrailEdgeCorrection	Paper Transfer:Low:2side	ENG	[0 to 995 / 100 / 5%/step]
2-478-001	Thin:SwitchTimingTrailEdge	PaperTransfer:Standard:1side	ENG	[0 to 50 / 0 / 2mm/step]
2-478-002	Thin:SwitchTimingTrailEdge	PaperTransfer:Standard:2side	ENG	[0 to 50 / 0 / 2mm/step]
2-478-003	Thin:SwitchTimingTrailEdge	Paper Transfer:Low:1side	ENG	[0 to 50 / 0 / 2mm/step]
2-478-004	Thin:SwitchTimingTrailEdge	Paper Transfer:Low:2side	ENG	[0 to 50 / 0 / 2mm/step]

3.SP Mode Tables

SP2-XXX (Drum)-3

SP No.	Large Category	Small Category	EN G or CTL	[Min to Max/Init./Step]
2-483-001	Thick1:Bias:BW	PaperTransfer:middle:1side	EN G	IM C6000: [0 to 250 / 16 / 1-uA/step] IM C5500: [0 to 250 / 16 / 1-uA/step] IM C4500: [0 to 250 / 16 / 1-uA/step]
2-483-002	Thick1:Bias:BW	PaperTransfer:middle:2side	EN G	IM C6000: [0 to 250 / 13 / 1-uA/step] IM C5500: [0 to 250 / 13 / 1-uA/step] IM C4500: [0 to 250 / 13 / 1-uA/step]
2-483-003	Thick1:Bias:BW	PaperTransfer:low:1side	EN G	IM C6000: [0 to 250 / 11 / 1-uA/step] IM C5500: [0 to 250 / 11 / 1-uA/step] IM C4500: [0 to 250 / 11 / 1-uA/step]
2-483-004	Thick1:Bias:BW	PaperTransfer:low:2side	EN G	IM C6000: [0 to 250 / 9 / 1-uA/step] IM C5500: [0 to 250 / 9 / 1-uA/step] IM C4500: [0 to 250 / 9 / 1-uA/step]

3.SP Mode Tables

SP No.	Large Category	Small Category	EN G or CTL	[Min to Max/Init./Step]
				1-uA/step]
2-487-001	Thick1:Bias:FC	PaperTransfer:middle:1side	EN G	IM C6000: [0 to 250 / 23 / 1-uA/step] IM C5500: [0 to 250 / 23 / 1-uA/step] IM C4500: [0 to 250 / 23 / 1-uA/step]
2-487-002	Thick1:Bias:FC	PaperTransfer:middle:2side	EN G	IM C6000: [0 to 250 / 26 / 1-uA/step] IM C5500: [0 to 250 / 26 / 1-uA/step] IM C4500: [0 to 250 / 26 / 1-uA/step]
2-487-003	Thick1:Bias:FC	PaperTransfer:low:1side	EN G	IM C6000: [0 to 250 / 16 / 1-uA/step] IM C5500: [0 to 250 / 16 / 1-uA/step] IM C4500: [0 to 250 / 16 / 1-uA/step]
2-487-004	Thick1:Bias:FC	PaperTransfer:low:2side	EN G	IM C6000: [0 to 250 / 18 / 1-uA/step] IM C5500: [0 to 250 / 18 / 1-uA/step] IM C4500: [0 to 250 / 18

3.SP Mode Tables

SP No.	Large Category	Small Category	EN G or CTL	[Min to Max/Init./Step]
				/ 1-uA/step]
2-491-001	Thick1:SizeCorrection:BW	PaperTransfer:middle:1Sid:S1	EN G	[100 to 995 / 100 / 1%/step]
2-491-002	Thick1:SizeCorrection:BW	PaperTransfer:middle:1Sid:S1	EN G	[100 to 995 / 100 / 1%/step]
2-491-003	Thick1:SizeCorrection:BW	PaperTransfer:Low:1Side:S1	EN G	[100 to 995 / 100 / 1%/step]
2-491-004	Thick1:SizeCorrection:BW	PaperTransfer:Low:1Side:S1	EN G	[100 to 995 / 100 / 1%/step]
2-491-005	Thick1:SizeCorrection:BW	PaperTransfer:middle:1Sid:S2	EN G	[100 to 995 / 100 / 1%/step]
2-491-006	Thick1:SizeCorrection:BW	PaperTransfer:middle:1Sid:S2	EN G	[100 to 995 / 177 / 1%/step]
2-491-007	Thick1:SizeCorrection:BW	PaperTransfer:Low:1Side:S2	EN G	[100 to 995 / 100 / 1%/step]
2-491-008	Thick1:SizeCorrection:BW	PaperTransfer:Low:1Side:S2	EN G	[100 to 995 / 177 / 1%/step]
2-491-	Thick1:SizeCorrection:BW	PaperTransfer:middle:1Sid:S3	EN G	[100 to 995 / 100 / 1%/step]

3.SP Mode Tables

SP No.	Large Category	Small Category	EN G or CTL	[Min to Max/Init./Step]
009				
2-491-010	Thick1:SizeCorrection:BW	PaperTransfer:middle:1Sid:S3	EN G	[100 to 995 / 231 / 1%/step]
2-491-011	Thick1:SizeCorrection:BW	PaperTransfer:Low:1Side:S3	EN G	[100 to 995 / 100 / 1%/step]
2-491-012	Thick1:SizeCorrection:BW	PaperTransfer:Low:1Side:S3	EN G	[100 to 995 / 231 / 1%/step]
2-491-013	Thick1:SizeCorrection:BW	PaperTransfer:middle:1Sid:S4	EN G	[100 to 995 / 100 / 1%/step]
2-491-014	Thick1:SizeCorrection:BW	PaperTransfer:middle:1Sid:S4	EN G	[100 to 995 / 270 / 1%/step]
2-491-015	Thick1:SizeCorrection:BW	PaperTransfer:Low:1Side:S4	EN G	[100 to 995 / 100 / 1%/step]
2-491-016	Thick1:SizeCorrection:BW	PaperTransfer:Low:1Side:S4	EN G	[100 to 995 / 270 / 1%/step]
2-491-017	Thick1:SizeCorrection:BW	PaperTransfer:middle:1Sid:S5	EN G	[100 to 995 / 100 / 1%/step]
2-491-	Thick1:SizeCorrection:BW	PaperTransfer:middle:2Sid:S5	EN G	[100 to 995 / 308 / 1%/step]

3.SP Mode Tables

SP No.	Large Category	Small Category	EN G or CTL	[Min to Max/Init./Step]
018				
2-491-019	Thick1:SizeCorrection:BW	PaperTransfer:Low:1Side:S5	EN G	[100 to 995 / 100 / 1%/step]
2-491-020	Thick1:SizeCorrection:BW	PaperTransfer:Low:2Side:S5	EN G	[100 to 995 / 308 / 1%/step]
2-491-021	Thick1:SizeCorrection:BW	Wide Roller:PaperTransfer:middle:1Sid:S1	EN G	[100 to 995 / 100 / 1%/step]
2-491-022	Thick1:SizeCorrection:BW	Wide Roller:PaperTransfer:middle:2Sid:S1	EN G	[100 to 995 / 100 / 1%/step]
2-491-023	Thick1:SizeCorrection:BW	Wide Roller:PaperTransfer:Low:1Side:S1	EN G	[100 to 995 / 100 / 1%/step]
2-491-024	Thick1:SizeCorrection:BW	Wide Roller:PaperTransfer:Low:2Side:S1	EN G	[100 to 995 / 100 / 1%/step]
2-491-025	Thick1:SizeCorrection:BW	Wide Roller:PaperTransfer:middle:1Sid:S2	EN G	[100 to 995 / 100 / 1%/step]
2-491-026	Thick1:SizeCorrection:BW	Wide Roller:PaperTransfer:middle:2Sid:S2	EN G	[100 to 995 / 177 / 1%/step]
2-491-	Thick1:SizeCorrection:BW	Wide Roller:PaperTransfer:Low:1Side:S2	EN G	[100 to 995 / 100 / 1%/step]

3.SP Mode Tables

SP No.	Large Category	Small Category	EN G or CTL	[Min to Max/Init./Step]
027				
2-491-028	Thick1:SizeCorrection:BW	Wide Roller:PaperTransfer:Low:2Side:S2	EN G	[100 to 995 / 177 / 1%/step]
2-491-029	Thick1:SizeCorrection:BW	Wide Roller:PaperTransfer:middle:1Sid:S3	EN G	[100 to 995 / 100 / 1%/step]
2-491-030	Thick1:SizeCorrection:BW	Wide Roller:PaperTransfer:middle:2Sid:S3	EN G	[100 to 995 / 231 / 1%/step]
2-491-031	Thick1:SizeCorrection:BW	Wide Roller:PaperTransfer:Low:1Side:S3	EN G	[100 to 995 / 100 / 1%/step]
2-491-032	Thick1:SizeCorrection:BW	Wide Roller:PaperTransfer:Low:2Side:S3	EN G	[100 to 995 / 231 / 1%/step]
2-491-033	Thick1:SizeCorrection:BW	Wide Roller:PaperTransfer:middle:1Sid:S4	EN G	[100 to 995 / 100 / 1%/step]
2-491-034	Thick1:SizeCorrection:BW	Wide Roller:PaperTransfer:middle:2Sid:S4	EN G	[100 to 995 / 270 / 1%/step]
2-491-035	Thick1:SizeCorrection:BW	Wide Roller:PaperTransfer:Low:1Side:S4	EN G	[100 to 995 / 100 / 1%/step]
2-491-	Thick1:SizeCorrection:BW	Wide Roller:PaperTransfer:Low:2Side:S4	EN G	[100 to 995 / 270 / 1%/step]

3.SP Mode Tables

SP No.	Large Category	Small Category	EN G or CTL	[Min to Max/Init./Step]
036				
2-491-037	Thick1:SizeCorrection:BW	Wide Roller:PaperTransfer:middle:1Sid:S5	EN G	[100 to 995 / 100 / 1%/step]
2-491-038	Thick1:SizeCorrection:BW	Wide Roller:PaperTransfer:middle:2Sid:S5	EN G	[100 to 995 / 308 / 1%/step]
2-491-039	Thick1:SizeCorrection:BW	Wide Roller:PaperTransfer:Low:1Side:S5	EN G	[100 to 995 / 100 / 1%/step]
2-491-040	Thick1:SizeCorrection:BW	Wide Roller:PaperTransfer:Low:2Side:S5	EN G	[100 to 995 / 308 / 1%/step]
2-492-001	Thick1:SizeCorrection:FC	PaperTransfer:middle:1Sid:S1	EN G	[100 to 995 / 100 / 1%/step]
2-492-002	Thick1:SizeCorrection:FC	PaperTransfer:middle:1Sid:S1	EN G	[100 to 995 / 100 / 1%/step]
2-492-003	Thick1:SizeCorrection:FC	PaperTransfer:Low:1Side:S1	EN G	[100 to 995 / 100 / 1%/step]
2-492-004	Thick1:SizeCorrection:FC	PaperTransfer:Low:1Side:S1	EN G	[100 to 995 / 100 / 1%/step]
2-492-	Thick1:SizeCorrection:FC	PaperTransfer:middle:1Sid:S2	EN G	[100 to 995 / 100 / 1%/step]

3.SP Mode Tables

SP No.	Large Category	Small Category	EN G or CTL	[Min to Max/Init./Step]
005				
2-492-006	Thick1:SizeCorrection:FC	PaperTransfer:middle:1Sid:S2	EN G	[100 to 995 / 173 / 1%/step]
2-492-007	Thick1:SizeCorrection:FC	PaperTransfer:Low:1Side:S2	EN G	[100 to 995 / 100 / 1%/step]
2-492-008	Thick1:SizeCorrection:FC	PaperTransfer:Low:1Side:S2	EN G	[100 to 995 / 173 / 1%/step]
2-492-009	Thick1:SizeCorrection:FC	PaperTransfer:middle:1Sid:S3	EN G	[100 to 995 / 100 / 1%/step]
2-492-010	Thick1:SizeCorrection:FC	PaperTransfer:middle:1Sid:S3	EN G	[100 to 995 / 250 / 1%/step]
2-492-011	Thick1:SizeCorrection:FC	PaperTransfer:Low:1Side:S3	EN G	[100 to 995 / 100 / 1%/step]
2-492-012	Thick1:SizeCorrection:FC	PaperTransfer:Low:1Side:S3	EN G	[100 to 995 / 250 / 1%/step]
2-492-013	Thick1:SizeCorrection:FC	PaperTransfer:middle:1Sid:S4	EN G	[100 to 995 / 100 / 1%/step]
2-492-	Thick1:SizeCorrection:FC	PaperTransfer:middle:1Sid:S4	EN G	[100 to 995 / 308 / 1%/step]

3.SP Mode Tables

SP No.	Large Category	Small Category	EN G or CTL	[Min to Max/Init./Step]
014				
2-492-015	Thick1:SizeCorrection:FC	PaperTransfer:Low:1Side:S4	EN G	[100 to 995 / 100 / 1%/step]
2-492-016	Thick1:SizeCorrection:FC	PaperTransfer:Low:1Side:S4	EN G	[100 to 995 / 308 / 1%/step]
2-492-017	Thick1:SizeCorrection:FC	PaperTransfer:middle:1Sid:S5	EN G	[100 to 995 / 100 / 1%/step]
2-492-018	Thick1:SizeCorrection:FC	PaperTransfer:middle:2Sid:S5	EN G	[100 to 995 / 385 / 1%/step]
2-492-019	Thick1:SizeCorrection:FC	PaperTransfer:Low:1Side:S5	EN G	[100 to 995 / 100 / 1%/step]
2-492-020	Thick1:SizeCorrection:FC	PaperTransfer:Low:2Side:S5	EN G	[100 to 995 / 385 / 1%/step]
2-492-021	Thick1:SizeCorrection:FC	Wide Roller:PaperTransfer:middle:1Sid:S1	EN G	[100 to 995 / 100 / 1%/step]
2-492-022	Thick1:SizeCorrection:FC	Wide Roller:PaperTransfer:middle:2Sid:S1	EN G	[100 to 995 / 100 / 1%/step]
2-492-	Thick1:SizeCorrection:FC	Wide Roller:PaperTransfer:Low:1Side:S1	EN G	[100 to 995 / 100 / 1%/step]

3.SP Mode Tables

SP No.	Large Category	Small Category	EN G or CTL	[Min to Max/Init./Step]
023				
2-492-024	Thick1:SizeCorrection:FC	Wide Roller:PaperTransfer:Low:2Side:S1	EN G	[100 to 995 / 100 / 1%/step]
2-492-025	Thick1:SizeCorrection:FC	Wide Roller:PaperTransfer:middle:1Sid:S2	EN G	[100 to 995 / 100 / 1%/step]
2-492-026	Thick1:SizeCorrection:FC	Wide Roller:PaperTransfer:middle:2Sid:S2	EN G	[100 to 995 / 173 / 1%/step]
2-492-027	Thick1:SizeCorrection:FC	Wide Roller:PaperTransfer:Low:1Side:S2	EN G	[100 to 995 / 100 / 1%/step]
2-492-028	Thick1:SizeCorrection:FC	Wide Roller:PaperTransfer:Low:2Side:S2	EN G	[100 to 995 / 173 / 1%/step]
2-492-029	Thick1:SizeCorrection:FC	Wide Roller:PaperTransfer:middle:1Sid:S3	EN G	[100 to 995 / 100 / 1%/step]
2-492-030	Thick1:SizeCorrection:FC	Wide Roller:PaperTransfer:middle:2Sid:S3	EN G	[100 to 995 / 250 / 1%/step]
2-492-031	Thick1:SizeCorrection:FC	Wide Roller:PaperTransfer:Low:1Side:S3	EN G	[100 to 995 / 100 / 1%/step]
2-492-	Thick1:SizeCorrection:FC	Wide Roller:PaperTransfer:Low:2Side:S3	EN G	[100 to 995 / 250 / 1%/step]

3.SP Mode Tables

SP No.	Large Category	Small Category	EN G or CTL	[Min to Max/Init./Step]
032				
2-492-033	Thick1:SizeCorrection:FC	Wide Roller:PaperTransfer:middle:1Sid:S4	EN G	[100 to 995 / 100 / 1%/step]
2-492-034	Thick1:SizeCorrection:FC	Wide Roller:PaperTransfer:middle:2Sid:S4	EN G	[100 to 995 / 308 / 1%/step]
2-492-035	Thick1:SizeCorrection:FC	Wide Roller:PaperTransfer:Low:1Side:S4	EN G	[100 to 995 / 100 / 1%/step]
2-492-036	Thick1:SizeCorrection:FC	Wide Roller:PaperTransfer:Low:2Side:S4	EN G	[100 to 995 / 308 / 1%/step]
2-492-037	Thick1:SizeCorrection:FC	Wide Roller:PaperTransfer:middle:1Sid:S5	EN G	[100 to 995 / 100 / 1%/step]
2-492-038	Thick1:SizeCorrection:FC	Wide Roller:PaperTransfer:middle:2Sid:S5	EN G	[100 to 995 / 385 / 1%/step]
2-492-039	Thick1:SizeCorrection:FC	Wide Roller:PaperTransfer:Low:1Side:S5	EN G	[100 to 995 / 100 / 1%/step]
2-492-040	Thick1:SizeCorrection:FC	Wide Roller:PaperTransfer:Low:2Side:S5	EN G	[100 to 995 / 385 / 1%/step]
2-493-	Thick1:Size-Env.Correct:BW	PaperTransfer:middle:1Sid:S1	EN G	[1 to 110 / 54 / 1/step]

3.SP Mode Tables

SP No.	Large Category	Small Category	EN G or CTL	[Min to Max/Init./Step]
001				
2-493-002	Thick1:Size-Env.Correct:BW	PaperTransfer:middle:1Sid:S1	EN G	[1 to 110 / 57 / 1/step]
2-493-003	Thick1:Size-Env.Correct:BW	PaperTransfer:Low:1Side:S1	EN G	[1 to 110 / 54 / 1/step]
2-493-004	Thick1:Size-Env.Correct:BW	PaperTransfer:Low:1Side:S1	EN G	[1 to 110 / 57 / 1/step]
2-493-005	Thick1:Size-Env.Correct:BW	PaperTransfer:middle:1Sid:S2	EN G	[1 to 110 / 55 / 1/step]
2-493-006	Thick1:Size-Env.Correct:BW	PaperTransfer:middle:1Sid:S2	EN G	[1 to 110 / 58 / 1/step]
2-493-007	Thick1:Size-Env.Correct:BW	PaperTransfer:Low:1Side:S2	EN G	[1 to 110 / 55 / 1/step]
2-493-008	Thick1:Size-Env.Correct:BW	PaperTransfer:Low:1Side:S2	EN G	[1 to 110 / 58 / 1/step]
2-493-009	Thick1:Size-Env.Correct:BW	PaperTransfer:middle:1Sid:S3	EN G	[1 to 110 / 56 / 1/step]
2-493-	Thick1:Size-Env.Correct:BW	PaperTransfer:middle:1Sid:S3	EN G	[1 to 110 / 59 / 1/step]

3.SP Mode Tables

SP No.	Large Category	Small Category	EN G or CTL	[Min to Max/Init./Step]
010				
2-493-011	Thick1:Size-Env.Correct:BW	PaperTransfer:Low:1Side:S3	EN G	[1 to 110 / 56 / 1/step]
2-493-012	Thick1:Size-Env.Correct:BW	PaperTransfer:Low:1Side:S3	EN G	[1 to 110 / 59 / 1/step]
2-493-013	Thick1:Size-Env.Correct:BW	PaperTransfer:middle:1Sid:S4	EN G	[1 to 110 / 56 / 1/step]
2-493-014	Thick1:Size-Env.Correct:BW	PaperTransfer:middle:1Sid:S4	EN G	[1 to 110 / 60 / 1/step]
2-493-015	Thick1:Size-Env.Correct:BW	PaperTransfer:Low:1Side:S4	EN G	[1 to 110 / 56 / 1/step]
2-493-016	Thick1:Size-Env.Correct:BW	PaperTransfer:Low:1Side:S4	EN G	[1 to 110 / 60 / 1/step]
2-493-017	Thick1:Size-Env.Correct:BW	PaperTransfer:middle:1Sid:S5	EN G	[1 to 110 / 56 / 1/step]
2-493-018	Thick1:Size-Env.Correct:BW	PaperTransfer:middle:2Sid:S5	EN G	[1 to 110 / 61 / 1/step]
2-493-	Thick1:Size-Env.Correct:BW	PaperTransfer:Low:1Side:S5	EN G	[1 to 110 / 56 / 1/step]

3.SP Mode Tables

SP No.	Large Category	Small Category	EN G or CTL	[Min to Max/Init./Step]
019				
2-493-020	Thick1:Size-Env.Correct:BW	PaperTransfer:Low:2Side:S5	EN G	[1 to 110 / 61 / 1/step]
2-493-021	Thick1:Size-Env.Correct:BW	Wide Roller:PaperTransfer:middle:1Sid:S1	EN G	[1 to 110 / 54 / 1/step]
2-493-022	Thick1:Size-Env.Correct:BW	Wide Roller:PaperTransfer:middle:2Sid:S1	EN G	[1 to 110 / 57 / 1/step]
2-493-023	Thick1:Size-Env.Correct:BW	Wide Roller:PaperTransfer:Low:1Side:S1	EN G	[1 to 110 / 54 / 1/step]
2-493-024	Thick1:Size-Env.Correct:BW	Wide Roller:PaperTransfer:Low:2Side:S1	EN G	[1 to 110 / 57 / 1/step]
2-493-025	Thick1:Size-Env.Correct:BW	Wide Roller:PaperTransfer:middle:1Sid:S2	EN G	[1 to 110 / 55 / 1/step]
2-493-026	Thick1:Size-Env.Correct:BW	Wide Roller:PaperTransfer:middle:2Sid:S2	EN G	[1 to 110 / 58 / 1/step]
2-493-027	Thick1:Size-Env.Correct:BW	Wide Roller:PaperTransfer:Low:1Side:S2	EN G	[1 to 110 / 55 / 1/step]
2-493-	Thick1:Size-Env.Correct:BW	Wide Roller:PaperTransfer:Low:2Side:S2	EN G	[1 to 110 / 58 / 1/step]

3.SP Mode Tables

SP No.	Large Category	Small Category	EN G or CTL	[Min to Max/Init./Step]
028				
2-493-029	Thick1:Size-Env.Correct:BW	Wide Roller:PaperTransfer:middle:1Sid:S3	EN G	[1 to 110 / 56 / 1/step]
2-493-030	Thick1:Size-Env.Correct:BW	Wide Roller:PaperTransfer:middle:2Sid:S3	EN G	[1 to 110 / 59 / 1/step]
2-493-031	Thick1:Size-Env.Correct:BW	Wide Roller:PaperTransfer:Low:1Side:S3	EN G	[1 to 110 / 56 / 1/step]
2-493-032	Thick1:Size-Env.Correct:BW	Wide Roller:PaperTransfer:Low:2Side:S3	EN G	[1 to 110 / 59 / 1/step]
2-493-033	Thick1:Size-Env.Correct:BW	Wide Roller:PaperTransfer:middle:1Sid:S4	EN G	[1 to 110 / 56 / 1/step]
2-493-034	Thick1:Size-Env.Correct:BW	Wide Roller:PaperTransfer:middle:2Sid:S4	EN G	[1 to 110 / 60 / 1/step]
2-493-035	Thick1:Size-Env.Correct:BW	Wide Roller:PaperTransfer:Low:1Side:S4	EN G	[1 to 110 / 56 / 1/step]
2-493-036	Thick1:Size-Env.Correct:BW	Wide Roller:PaperTransfer:Low:2Side:S4	EN G	[1 to 110 / 60 / 1/step]
2-493-	Thick1:Size-Env.Correct:BW	Wide Roller:PaperTransfer:middle:1Sid:S5	EN G	[1 to 110 / 56 / 1/step]

3.SP Mode Tables

SP No.	Large Category	Small Category	EN G or CTL	[Min to Max/Init./Step]
037				
2-493-038	Thick1:Size-Env.Correct:BW	Wide Roller:PaperTransfer:middle:2Sid:S5	EN G	[1 to 110 / 61 / 1/step]
2-493-039	Thick1:Size-Env.Correct:BW	Wide Roller:PaperTransfer:Low:1Side:S5	EN G	[1 to 110 / 56 / 1/step]
2-493-040	Thick1:Size-Env.Correct:BW	Wide Roller:PaperTransfer:Low:2Side:S5	EN G	[1 to 110 / 61 / 1/step]
2-494-001	Thick1:Size-Env.Correct:FC	PaperTransfer:middle:1Sid:S1	EN G	IM C6000: [1 to 110 / 13 / 1/step] IM C5500: [1 to 110 / 13 / 1/step] IM C4500: [1 to 110 / 13 / 1/step]
2-494-002	Thick1:Size-Env.Correct:FC	PaperTransfer:middle:1Sid:S1	EN G	[1 to 110 / 65 / 1/step]
2-494-003	Thick1:Size-Env.Correct:FC	PaperTransfer:Low:1Side:S1	EN G	IM C6000: [1 to 110 / 13 / 1/step] IM C5500: [1 to 110 / 13 / 1/step] IM C4500: [1 to 110 / 13 / 1/step]
2-	Thick1:Size-Env.Correct:FC	PaperTransfer:Low:1Side:S1	EN	[1 to 110 / 65

3.SP Mode Tables

SP No.	Large Category	Small Category	EN G or CTL	[Min to Max/Init./Step]
494-004			G	/ 1/step]
2-494-005	Thick1:Size-Env.Correct:FC	PaperTransfer:middle:1Sid:S2	EN G	[1 to 110 / 63 / 1/step]
2-494-006	Thick1:Size-Env.Correct:FC	PaperTransfer:middle:1Sid:S2	EN G	[1 to 110 / 66 / 1/step]
2-494-007	Thick1:Size-Env.Correct:FC	PaperTransfer:Low:1Side:S2	EN G	[1 to 110 / 63 / 1/step]
2-494-008	Thick1:Size-Env.Correct:FC	PaperTransfer:Low:1Side:S2	EN G	[1 to 110 / 66 / 1/step]
2-494-009	Thick1:Size-Env.Correct:FC	PaperTransfer:middle:1Sid:S3	EN G	[1 to 110 / 63 / 1/step]
2-494-010	Thick1:Size-Env.Correct:FC	PaperTransfer:middle:1Sid:S3	EN G	[1 to 110 / 67 / 1/step]
2-494-011	Thick1:Size-Env.Correct:FC	PaperTransfer:Low:1Side:S3	EN G	[1 to 110 / 63 / 1/step]
2-494-012	Thick1:Size-Env.Correct:FC	PaperTransfer:Low:1Side:S3	EN G	[1 to 110 / 67 / 1/step]
2-	Thick1:Size-Env.Correct:FC	PaperTransfer:middle:1Sid:S4	EN	[1 to 110 / 64

3.SP Mode Tables

SP No.	Large Category	Small Category	EN G or CTL	[Min to Max/Init./Step]
494 - 013			G	/ 1/step]
2- 494 - 014	Thick1:Size-Env.Correct:FC	PaperTransfer:middle:1Sid:S4	EN G	[1 to 110 / 68 / 1/step]
2- 494 - 015	Thick1:Size-Env.Correct:FC	PaperTransfer:Low:1Side:S4	EN G	[1 to 110 / 64 / 1/step]
2- 494 - 016	Thick1:Size-Env.Correct:FC	PaperTransfer:Low:1Side:S4	EN G	[1 to 110 / 68 / 1/step]
2- 494 - 017	Thick1:Size-Env.Correct:FC	PaperTransfer:middle:1Sid:S5	EN G	[1 to 110 / 64 / 1/step]
2- 494 - 018	Thick1:Size-Env.Correct:FC	PaperTransfer:middle:2Sid:S5	EN G	[1 to 110 / 69 / 1/step]
2- 494 - 019	Thick1:Size-Env.Correct:FC	PaperTransfer:Low:1Side:S5	EN G	[1 to 110 / 64 / 1/step]
2- 494 - 020	Thick1:Size-Env.Correct:FC	PaperTransfer:Low:2Side:S5	EN G	[1 to 110 / 69 / 1/step]
2- 494 - 021	Thick1:Size-Env.Correct:FC	Wide Roller:PaperTransfer:middle:1Sid:S1	EN G	IM C6000: [1 to 110 / 13 / 1/step] IM C5500: [1 to 110 / 13

3.SP Mode Tables

SP No.	Large Category	Small Category	EN G or CTL	[Min to Max/Init./Step]
				/ 1/step] IM C4500: [1 to 110 / 13 / 1/step]
2-494-022	Thick1:Size-Env.Correct:FC	Wide Roller:PaperTransfer:middle:2Sid:S1	EN G	[1 to 110 / 65 / 1/step]
2-494-023	Thick1:Size-Env.Correct:FC	Wide Roller:PaperTransfer:Low:1Side:S1	EN G	IM C6000: [1 to 110 / 13 / 1/step] IM C5500: [1 to 110 / 13 / 1/step] IM C4500: [1 to 110 / 13 / 1/step]
2-494-024	Thick1:Size-Env.Correct:FC	Wide Roller:PaperTransfer:Low:2Side:S1	EN G	[1 to 110 / 65 / 1/step]
2-494-025	Thick1:Size-Env.Correct:FC	Wide Roller:PaperTransfer:middle:1Sid:S2	EN G	[1 to 110 / 63 / 1/step]
2-494-026	Thick1:Size-Env.Correct:FC	Wide Roller:PaperTransfer:middle:2Sid:S2	EN G	[1 to 110 / 66 / 1/step]
2-494-027	Thick1:Size-Env.Correct:FC	Wide Roller:PaperTransfer:Low:1Side:S2	EN G	[1 to 110 / 63 / 1/step]
2-494-	Thick1:Size-Env.Correct:FC	Wide Roller:PaperTransfer:Low:2Side:S2	EN G	[1 to 110 / 66 / 1/step]

3.SP Mode Tables

SP No.	Large Category	Small Category	EN G or CTL	[Min to Max/Init./Step]
028				
2-494-029	Thick1:Size-Env.Correct:FC	Wide Roller:PaperTransfer:middle:1Sid:S3	EN G	[1 to 110 / 63 / 1/step]
2-494-030	Thick1:Size-Env.Correct:FC	Wide Roller:PaperTransfer:middle:2Sid:S3	EN G	[1 to 110 / 67 / 1/step]
2-494-031	Thick1:Size-Env.Correct:FC	Wide Roller:PaperTransfer:Low:1Side:S3	EN G	[1 to 110 / 63 / 1/step]
2-494-032	Thick1:Size-Env.Correct:FC	Wide Roller:PaperTransfer:Low:2Side:S3	EN G	[1 to 110 / 67 / 1/step]
2-494-033	Thick1:Size-Env.Correct:FC	Wide Roller:PaperTransfer:middle:1Sid:S4	EN G	[1 to 110 / 64 / 1/step]
2-494-034	Thick1:Size-Env.Correct:FC	Wide Roller:PaperTransfer:middle:2Sid:S4	EN G	[1 to 110 / 68 / 1/step]
2-494-035	Thick1:Size-Env.Correct:FC	Wide Roller:PaperTransfer:Low:1Side:S4	EN G	[1 to 110 / 64 / 1/step]
2-494-036	Thick1:Size-Env.Correct:FC	Wide Roller:PaperTransfer:Low:2Side:S4	EN G	[1 to 110 / 68 / 1/step]
2-494-	Thick1:Size-Env.Correct:FC	Wide Roller:PaperTransfer:middle:1Sid:S5	EN G	[1 to 110 / 64 / 1/step]

3.SP Mode Tables

SP No.	Large Category	Small Category	EN G or CTL	[Min to Max/Init./Step]
037				
2-494-038	Thick1:Size-Env.Correct:FC	Wide Roller:PaperTransfer:middle:2Sid:S5	EN G	[1 to 110 / 69 / 1/step]
2-494-039	Thick1:Size-Env.Correct:FC	Wide Roller:PaperTransfer:Low:1Side:S5	EN G	[1 to 110 / 64 / 1/step]
2-494-040	Thick1:Size-Env.Correct:FC	Wide Roller:PaperTransfer:Low:2Side:S5	EN G	[1 to 110 / 69 / 1/step]
2-495-001	Thick1:LeadingEdgeCorrection	PaperTransfer:middle:1Side	EN G	[0 to 995 / 100 / 5%/step]
2-495-002	Thick1:LeadingEdgeCorrection	PaperTransfer:middle:2Side	EN G	[0 to 995 / 100 / 5%/step]
2-495-003	Thick1:LeadingEdgeCorrection	Paper Transfer:Low:1side	EN G	[0 to 995 / 100 / 5%/step]
2-495-004	Thick1:LeadingEdgeCorrection	Paper Transfer:Low:2side	EN G	[0 to 995 / 100 / 5%/step]
2-496-001	Thick1:SwitchTimingLeadEdge	PaperTransfer:middle:1side	EN G	[0 to 50 / 0 / 2mm/step]
2-496-	Thick1:SwitchTimingLeadEdge	PaperTransfer:middle:2side	EN G	[0 to 50 / 0 / 2mm/step]

3.SP Mode Tables

SP No.	Large Category	Small Category	EN G or CTL	[Min to Max/Init./Step]
002				
2-496-003	Thick1:SwitchTimingLeadEdge	Paper Transfer:Low:1side	EN G	[0 to 50 / 0 / 2mm/step]
2-496-004	Thick1:SwitchTimingLeadEdge	Paper Transfer:Low:2side	EN G	[0 to 50 / 0 / 2mm/step]
2-497-001	Thick1:TrailEdgeCorrection	PaperTransfer:middle:1Side	EN G	[0 to 995 / 100 / 5%/step]
2-497-002	Thick1:TrailEdgeCorrection	PaperTransfer:middle:2Side	EN G	[0 to 995 / 100 / 5%/step]
2-497-003	Thick1:TrailEdgeCorrection	Paper Transfer:Low:1side	EN G	[0 to 995 / 100 / 5%/step]
2-497-004	Thick1:TrailEdgeCorrection	Paper Transfer:Low:2side	EN G	[0 to 995 / 100 / 5%/step]
2-498-001	Thick1:SwitchTimingTrailEdge	PaperTransfer:middle:1Side	EN G	[0 to 50 / 0 / 2mm/step]
2-498-002	Thick1:SwitchTimingTrailEdge	PaperTransfer:middle:2Side	EN G	[0 to 50 / 0 / 2mm/step]
2-498-	Thick1:SwitchTimingTrailEdge	Paper Transfer:Low:1side	EN G	[0 to 50 / 0 / 2mm/step]

3.SP Mode Tables

SP No.	Large Category	Small Category	EN G or CTL	[Min to Max/Init./Step]
003				
2-498-004	Thick1:SwitchTimingTrailEdge	Paper Transfer:Low:2side	EN G	[0 to 50 / 0 / 2mm/step]
2-503-003	Thick2:Bias:BW	PaperTransfer:1side	EN G	IM C6000: [0 to 250 / 11 / 1-uA/step] IM C5500: [0 to 250 / 11 / 1-uA/step] IM C4500: [0 to 250 / 11 / 1-uA/step]
2-503-004	Thick2:Bias:BW	PaperTransfer:2side	EN G	IM C6000: [0 to 250 / 15 / 1-uA/step] IM C5500: [0 to 250 / 15 / 1-uA/step] IM C4500: [0 to 250 / 15 / 1-uA/step]
2-507-003	Thick2:Bias:FC	PaperTransfer:1side	EN G	IM C6000: [0 to 250 / 19 / 1-uA/step] IM C5500: [0 to 250 / 19 / 1-uA/step] IM C4500: [0 to 250 / 19 / 1-uA/step]
2-507-004	Thick2:Bias:FC	PaperTransfer:2side	EN G	IM C6000: [0 to 250 / 21 / 1-uA/step] IM C5500:

3.SP Mode Tables

SP No.	Large Category	Small Category	EN G or CTL	[Min to Max/Init./Step]
				[0 to 250 / 21 / 1-uA/step] IM C4500: [0 to 250 / 21 / 1-uA/step]
2-511-003	Thick2:SizeCorrection:BW	PaperTransfer:1Side:S1	EN G	[100 to 995 / 100 / 1%/step]
2-511-004	Thick2:SizeCorrection:BW	PaperTransfer:2Side:S1	EN G	[100 to 995 / 100 / 1%/step]
2-511-007	Thick2:SizeCorrection:BW	PaperTransfer:1Side:S2	EN G	[100 to 995 / 100 / 1%/step]
2-511-008	Thick2:SizeCorrection:BW	PaperTransfer:2Side:S2	EN G	[100 to 995 / 133 / 1%/step]
2-511-011	Thick2:SizeCorrection:BW	PaperTransfer:1Side:S3	EN G	[100 to 995 / 100 / 1%/step]
2-511-012	Thick2:SizeCorrection:BW	PaperTransfer:2Side:S3	EN G	[100 to 995 / 167 / 1%/step]
2-511-015	Thick2:SizeCorrection:BW	PaperTransfer:1Side:S4	EN G	[100 to 995 / 100 / 1%/step]
2-511-	Thick2:SizeCorrection:BW	PaperTransfer:2Side:S4	EN G	[100 to 995 / 233 / 1%/step]

3.SP Mode Tables

SP No.	Large Category	Small Category	EN G or CTL	[Min to Max/Init./Step]
016				
2-511-019	Thick2:SizeCorrection:BW	PaperTransfer:1Side:S5	EN G	[100 to 995 / 100 / 1%/step]
2-511-020	Thick2:SizeCorrection:BW	PaperTransfer:2Side:S5	EN G	[100 to 995 / 267 / 1%/step]
2-511-023	Thick2:SizeCorrection:BW	Wide Roller:PaperTransfer:1Side:S1	EN G	[100 to 995 / 100 / 1%/step]
2-511-024	Thick2:SizeCorrection:BW	Wide Roller:PaperTransfer:2Side:S1	EN G	[100 to 995 / 100 / 1%/step]
2-511-027	Thick2:SizeCorrection:BW	Wide Roller:PaperTransfer:1Side:S2	EN G	[100 to 995 / 100 / 1%/step]
2-511-028	Thick2:SizeCorrection:BW	Wide Roller:PaperTransfer:2Side:S2	EN G	[100 to 995 / 133 / 1%/step]
2-511-031	Thick2:SizeCorrection:BW	Wide Roller:PaperTransfer:1Side:S3	EN G	[100 to 995 / 100 / 1%/step]
2-511-032	Thick2:SizeCorrection:BW	Wide Roller:PaperTransfer:2Side:S3	EN G	[100 to 995 / 167 / 1%/step]
2-511-	Thick2:SizeCorrection:BW	Wide Roller:PaperTransfer:1Side:S4	EN G	[100 to 995 / 100 / 1%/step]

3.SP Mode Tables

SP No.	Large Category	Small Category	EN G or CTL	[Min to Max/Init./Step]
035				
2-511-036	Thick2:SizeCorrection:BW	Wide Roller:PaperTransfer:2Side:S4	EN G	[100 to 995 / 233 / 1%/step]
2-511-039	Thick2:SizeCorrection:BW	Wide Roller:PaperTransfer:1Side:S5	EN G	[100 to 995 / 100 / 1%/step]
2-511-040	Thick2:SizeCorrection:BW	Wide Roller:PaperTransfer:2Side:S5	EN G	[100 to 995 / 267 / 1%/step]
2-512-003	Thick2:SizeCorrection:FC	PaperTransfer:1Side:S1	EN G	[100 to 995 / 100 / 1%/step]
2-512-004	Thick2:SizeCorrection:FC	PaperTransfer:2Side:S1	EN G	[100 to 995 / 100 / 1%/step]
2-512-007	Thick2:SizeCorrection:FC	PaperTransfer:1Side:S2	EN G	[100 to 995 / 100 / 1%/step]
2-512-008	Thick2:SizeCorrection:FC	PaperTransfer:2Side:S2	EN G	[100 to 995 / 181 / 1%/step]
2-512-011	Thick2:SizeCorrection:FC	PaperTransfer:1Side:S3	EN G	[100 to 995 / 100 / 1%/step]
2-512-	Thick2:SizeCorrection:FC	PaperTransfer:2Side:S3	EN G	[100 to 995 / 229 / 1%/step]

3.SP Mode Tables

SP No.	Large Category	Small Category	EN G or CTL	[Min to Max/Init./Step]
012				
2-512-015	Thick2:SizeCorrection:FC	PaperTransfer:1Side:S4	EN G	[100 to 995 / 100 / 1%/step]
2-512-016	Thick2:SizeCorrection:FC	PaperTransfer:2Side:S4	EN G	[100 to 995 / 286 / 1%/step]
2-512-019	Thick2:SizeCorrection:FC	PaperTransfer:1Side:S5	EN G	[100 to 995 / 100 / 1%/step]
2-512-020	Thick2:SizeCorrection:FC	PaperTransfer:2Side:S5	EN G	[100 to 995 / 381 / 1%/step]
2-512-023	Thick2:SizeCorrection:FC	Wide Roller:PaperTransfer:1Side:S1	EN G	[100 to 995 / 100 / 1%/step]
2-512-024	Thick2:SizeCorrection:FC	Wide Roller:PaperTransfer:2Side:S1	EN G	[100 to 995 / 100 / 1%/step]
2-512-027	Thick2:SizeCorrection:FC	Wide Roller:PaperTransfer:1Side:S2	EN G	[100 to 995 / 100 / 1%/step]
2-512-028	Thick2:SizeCorrection:FC	Wide Roller:PaperTransfer:2Side:S2	EN G	[100 to 995 / 181 / 1%/step]
2-512-	Thick2:SizeCorrection:FC	Wide Roller:PaperTransfer:1Side:S3	EN G	[100 to 995 / 100 / 1%/step]

3.SP Mode Tables

SP No.	Large Category	Small Category	EN G or CTL	[Min to Max/Init./Step]
031				
2-512-032	Thick2:SizeCorrection:FC	Wide Roller:PaperTransfer:2Side:S3	EN G	[100 to 995 / 229 / 1%/step]
2-512-035	Thick2:SizeCorrection:FC	Wide Roller:PaperTransfer:1Side:S4	EN G	[100 to 995 / 100 / 1%/step]
2-512-036	Thick2:SizeCorrection:FC	Wide Roller:PaperTransfer:2Side:S4	EN G	[100 to 995 / 286 / 1%/step]
2-512-039	Thick2:SizeCorrection:FC	Wide Roller:PaperTransfer:1Side:S5	EN G	[100 to 995 / 100 / 1%/step]
2-512-040	Thick2:SizeCorrection:FC	Wide Roller:PaperTransfer:2Side:S5	EN G	[100 to 995 / 381 / 1%/step]
2-513-003	Thick2:Size-Env.Correct:BW	PaperTransfer:1Side:S1	EN G	[1 to 110 / 70 / 1/step]
2-513-004	Thick2:Size-Env.Correct:BW	PaperTransfer:2Side:S1	EN G	[1 to 110 / 72 / 1/step]
2-513-007	Thick2:Size-Env.Correct:BW	PaperTransfer:1Side:S2	EN G	[1 to 110 / 71 / 1/step]
2-513-	Thick2:Size-Env.Correct:BW	PaperTransfer:2Side:S2	EN G	[1 to 110 / 73 / 1/step]

3.SP Mode Tables

SP No.	Large Category	Small Category	EN G or CTL	[Min to Max/Init./Step]
008				
2-513-011	Thick2:Size-Env.Correct:BW	PaperTransfer:1Side:S3	EN G	[1 to 110 / 71 / 1/step]
2-513-012	Thick2:Size-Env.Correct:BW	PaperTransfer:2Side:S3	EN G	[1 to 110 / 74 / 1/step]
2-513-015	Thick2:Size-Env.Correct:BW	PaperTransfer:1Side:S4	EN G	[1 to 110 / 71 / 1/step]
2-513-016	Thick2:Size-Env.Correct:BW	PaperTransfer:2Side:S4	EN G	[1 to 110 / 75 / 1/step]
2-513-019	Thick2:Size-Env.Correct:BW	PaperTransfer:1Side:S5	EN G	[1 to 110 / 71 / 1/step]
2-513-020	Thick2:Size-Env.Correct:BW	PaperTransfer:2Side:S5	EN G	[1 to 110 / 76 / 1/step]
2-513-023	Thick2:Size-Env.Correct:BW	Wide Roller:PaperTransfer:1Side:S1	EN G	[1 to 110 / 70 / 1/step]
2-513-024	Thick2:Size-Env.Correct:BW	Wide Roller:PaperTransfer:2Side:S1	EN G	[1 to 110 / 72 / 1/step]
2-513-	Thick2:Size-Env.Correct:BW	Wide Roller:PaperTransfer:1Side:S2	EN G	[1 to 110 / 71 / 1/step]

3.SP Mode Tables

SP No.	Large Category	Small Category	EN G or CTL	[Min to Max/Init./Step]
027				
2-513-028	Thick2:Size-Env.Correct:BW	Wide Roller:PaperTransfer:2Side:S2	EN G	[1 to 110 / 73 / 1/step]
2-513-031	Thick2:Size-Env.Correct:BW	Wide Roller:PaperTransfer:1Side:S3	EN G	[1 to 110 / 71 / 1/step]
2-513-032	Thick2:Size-Env.Correct:BW	Wide Roller:PaperTransfer:2Side:S3	EN G	[1 to 110 / 74 / 1/step]
2-513-035	Thick2:Size-Env.Correct:BW	Wide Roller:PaperTransfer:1Side:S4	EN G	[1 to 110 / 71 / 1/step]
2-513-036	Thick2:Size-Env.Correct:BW	Wide Roller:PaperTransfer:2Side:S4	EN G	[1 to 110 / 75 / 1/step]
2-513-039	Thick2:Size-Env.Correct:BW	Wide Roller:PaperTransfer:1Side:S5	EN G	[1 to 110 / 71 / 1/step]
2-513-040	Thick2:Size-Env.Correct:BW	Wide Roller:PaperTransfer:2Side:S5	EN G	[1 to 110 / 76 / 1/step]
2-514-003	Thick2:Size-Env.Correct:FC	PaperTransfer:1Side:S1	EN G	[1 to 110 / 77 / 1/step]
2-514-	Thick2:Size-Env.Correct:FC	PaperTransfer:2Side:S1	EN G	[1 to 110 / 80 / 1/step]

3.SP Mode Tables

SP No.	Large Category	Small Category	EN G or CTL	[Min to Max/Init./Step]
004				
2-514-007	Thick2:Size-Env.Correct:FC	PaperTransfer:1Side:S2	EN G	[1 to 110 / 78 / 1/step]
2-514-008	Thick2:Size-Env.Correct:FC	PaperTransfer:2Side:S2	EN G	[1 to 110 / 81 / 1/step]
2-514-011	Thick2:Size-Env.Correct:FC	PaperTransfer:1Side:S3	EN G	[1 to 110 / 79 / 1/step]
2-514-012	Thick2:Size-Env.Correct:FC	PaperTransfer:2Side:S3	EN G	[1 to 110 / 82 / 1/step]
2-514-015	Thick2:Size-Env.Correct:FC	PaperTransfer:1Side:S4	EN G	[1 to 110 / 79 / 1/step]
2-514-016	Thick2:Size-Env.Correct:FC	PaperTransfer:2Side:S4	EN G	[1 to 110 / 83 / 1/step]
2-514-019	Thick2:Size-Env.Correct:FC	PaperTransfer:1Side:S5	EN G	[1 to 110 / 79 / 1/step]
2-514-020	Thick2:Size-Env.Correct:FC	PaperTransfer:2Side:S5	EN G	[1 to 110 / 84 / 1/step]
2-514-	Thick2:Size-Env.Correct:FC	Wide Roller:PaperTransfer:1Side:S1	EN G	[1 to 110 / 77 / 1/step]

3.SP Mode Tables

SP No.	Large Category	Small Category	EN G or CTL	[Min to Max/Init./Step]
023				
2-514-024	Thick2:Size-Env.Correct:FC	Wide Roller:PaperTransfer:2Side:S1	EN G	[1 to 110 / 80 / 1/step]
2-514-027	Thick2:Size-Env.Correct:FC	Wide Roller:PaperTransfer:1Side:S2	EN G	[1 to 110 / 78 / 1/step]
2-514-028	Thick2:Size-Env.Correct:FC	Wide Roller:PaperTransfer:2Side:S2	EN G	[1 to 110 / 81 / 1/step]
2-514-031	Thick2:Size-Env.Correct:FC	Wide Roller:PaperTransfer:1Side:S3	EN G	[1 to 110 / 79 / 1/step]
2-514-032	Thick2:Size-Env.Correct:FC	Wide Roller:PaperTransfer:2Side:S3	EN G	[1 to 110 / 82 / 1/step]
2-514-035	Thick2:Size-Env.Correct:FC	Wide Roller:PaperTransfer:1Side:S4	EN G	[1 to 110 / 79 / 1/step]
2-514-036	Thick2:Size-Env.Correct:FC	Wide Roller:PaperTransfer:2Side:S4	EN G	[1 to 110 / 83 / 1/step]
2-514-039	Thick2:Size-Env.Correct:FC	Wide Roller:PaperTransfer:1Side:S5	EN G	[1 to 110 / 79 / 1/step]
2-514-	Thick2:Size-Env.Correct:FC	Wide Roller:PaperTransfer:2Side:S5	EN G	[1 to 110 / 84 / 1/step]

3.SP Mode Tables

SP No.	Large Category	Small Category	EN G or CTL	[Min to Max/Init./Step]
040				
2-515-003	Thick2:LeadingEdgeCorrection	Paper Transfer:1side	EN G	[0 to 995 / 100 / 5%/step]
2-515-004	Thick2:LeadingEdgeCorrection	Paper Transfer:2side	EN G	[0 to 995 / 100 / 5%/step]
2-516-003	Thick2:SwitchTimingLeadEdge	Paper Transfer:1side	EN G	[0 to 50 / 0 / 2mm/step]
2-516-004	Thick2:SwitchTimingLeadEdge	Paper Transfer:2side	EN G	[0 to 50 / 0 / 2mm/step]
2-517-003	Thick2:TrailEdgeCorrection	Paper Transfer:1side	EN G	[0 to 995 / 100 / 5%/step]
2-517-004	Thick2:TrailEdgeCorrection	Paper Transfer:2side	EN G	[0 to 995 / 100 / 5%/step]
2-518-003	Thick2:SwitchTimingTrailEdge	Paper Transfer:1side	EN G	[0 to 50 / 0 / 2mm/step]
2-518-004	Thick2:SwitchTimingTrailEdge	Paper Transfer:2side	EN G	[0 to 50 / 0 / 2mm/step]
2-523-	Thick3:Bias:BW	PaperTransfer:1side	EN G	IM C6000: [0 to 250 / 11 / 1-uA/step]

3.SP Mode Tables

SP No.	Large Category	Small Category	EN G or CTL	[Min to Max/Init./Step]
003				IM C5500: [0 to 250 / 11 / 1-uA/step] IM C4500: [0 to 250 / 11 / 1-uA/step]
2-523-004	Thick3:Bias:BW	PaperTransfer:2side	EN G	IM C6000: [0 to 250 / 15 / 1-uA/step] IM C5500: [0 to 250 / 15 / 1-uA/step] IM C4500: [0 to 250 / 15 / 1-uA/step]
2-527-003	Thick3:Bias:FC	PaperTransfer:1side	EN G	IM C6000: [0 to 250 / 19 / 1-uA/step] IM C5500: [0 to 250 / 19 / 1-uA/step] IM C4500: [0 to 250 / 19 / 1-uA/step]
2-527-004	Thick3:Bias:FC	PaperTransfer:2side	EN G	IM C6000: [0 to 250 / 21 / 1-uA/step] IM C5500: [0 to 250 / 21 / 1-uA/step] IM C4500: [0 to 250 / 21 / 1-uA/step]
2-531-	Thick3:SizeCorrection:BW	PaperTransfer:1Side:S1	EN G	[100 to 995 / 100 / 1%/step]

3.SP Mode Tables

SP No.	Large Category	Small Category	EN G or CTL	[Min to Max/Init./Step]
003				
2-531-004	Thick3:SizeCorrection:BW	PaperTransfer:2Side:S1	EN G	[100 to 995 / 100 / 1%/step]
2-531-007	Thick3:SizeCorrection:BW	PaperTransfer:1Side:S2	EN G	[100 to 995 / 100 / 1%/step]
2-531-008	Thick3:SizeCorrection:BW	PaperTransfer:2Side:S2	EN G	[100 to 995 / 133 / 1%/step]
2-531-011	Thick3:SizeCorrection:BW	PaperTransfer:1Side:S3	EN G	[100 to 995 / 100 / 1%/step]
2-531-012	Thick3:SizeCorrection:BW	PaperTransfer:2Side:S3	EN G	[100 to 995 / 167 / 1%/step]
2-531-015	Thick3:SizeCorrection:BW	PaperTransfer:1Side:S4	EN G	[100 to 995 / 100 / 1%/step]
2-531-016	Thick3:SizeCorrection:BW	PaperTransfer:2Side:S4	EN G	[100 to 995 / 233 / 1%/step]
2-531-019	Thick3:SizeCorrection:BW	PaperTransfer:1Side:S5	EN G	[100 to 995 / 100 / 1%/step]
2-531-	Thick3:SizeCorrection:BW	PaperTransfer:2Side:S5	EN G	[100 to 995 / 267 / 1%/step]

3.SP Mode Tables

SP No.	Large Category	Small Category	EN G or CTL	[Min to Max/Init./Step]
020				
2-531-023	Thick3:SizeCorrection:BW	Wide Roller:PaperTransfer:1Side:S1	EN G	[100 to 995 / 100 / 1%/step]
2-531-024	Thick3:SizeCorrection:BW	Wide Roller:PaperTransfer:2Side:S1	EN G	[100 to 995 / 100 / 1%/step]
2-531-027	Thick3:SizeCorrection:BW	Wide Roller:PaperTransfer:1Side:S2	EN G	[100 to 995 / 100 / 1%/step]
2-531-028	Thick3:SizeCorrection:BW	Wide Roller:PaperTransfer:2Side:S2	EN G	[100 to 995 / 133 / 1%/step]
2-531-031	Thick3:SizeCorrection:BW	Wide Roller:PaperTransfer:1Side:S3	EN G	[100 to 995 / 100 / 1%/step]
2-531-032	Thick3:SizeCorrection:BW	Wide Roller:PaperTransfer:2Side:S3	EN G	[100 to 995 / 167 / 1%/step]
2-531-035	Thick3:SizeCorrection:BW	Wide Roller:PaperTransfer:1Side:S4	EN G	[100 to 995 / 100 / 1%/step]
2-531-036	Thick3:SizeCorrection:BW	Wide Roller:PaperTransfer:2Side:S4	EN G	[100 to 995 / 233 / 1%/step]
2-531-	Thick3:SizeCorrection:BW	Wide Roller:PaperTransfer:1Side:S5	EN G	[100 to 995 / 100 / 1%/step]

3.SP Mode Tables

SP No.	Large Category	Small Category	EN G or CTL	[Min to Max/Init./Step]
039				
2-531-040	Thick3:SizeCorrection:BW	Wide Roller:PaperTransfer:2Side:S5	EN G	[100 to 995 / 267 / 1%/step]
2-532-003	Thick3:SizeCorrection:FC	PaperTransfer:1Side:S1	EN G	[100 to 995 / 100 / 1%/step]
2-532-004	Thick3:SizeCorrection:FC	PaperTransfer:2Side:S1	EN G	[100 to 995 / 100 / 1%/step]
2-532-007	Thick3:SizeCorrection:FC	PaperTransfer:1Side:S2	EN G	[100 to 995 / 100 / 1%/step]
2-532-008	Thick3:SizeCorrection:FC	PaperTransfer:2Side:S2	EN G	[100 to 995 / 181 / 1%/step]
2-532-011	Thick3:SizeCorrection:FC	PaperTransfer:1Side:S3	EN G	[100 to 995 / 100 / 1%/step]
2-532-012	Thick3:SizeCorrection:FC	PaperTransfer:2Side:S3	EN G	[100 to 995 / 229 / 1%/step]
2-532-015	Thick3:SizeCorrection:FC	PaperTransfer:1Side:S4	EN G	[100 to 995 / 100 / 1%/step]
2-532-	Thick3:SizeCorrection:FC	PaperTransfer:2Side:S4	EN G	[100 to 995 / 286 / 1%/step]

3.SP Mode Tables

SP No.	Large Category	Small Category	EN G or CTL	[Min to Max/Init./Step]
016				
2-532-019	Thick3:SizeCorrection:FC	PaperTransfer:1Side:S5	EN G	[100 to 995 / 100 / 1%/step]
2-532-020	Thick3:SizeCorrection:FC	PaperTransfer:2Side:S5	EN G	[100 to 995 / 381 / 1%/step]
2-532-023	Thick3:SizeCorrection:FC	Wide Roller:PaperTransfer:1Side:S1	EN G	[100 to 995 / 100 / 1%/step]
2-532-024	Thick3:SizeCorrection:FC	Wide Roller:PaperTransfer:2Side:S1	EN G	[100 to 995 / 100 / 1%/step]
2-532-027	Thick3:SizeCorrection:FC	Wide Roller:PaperTransfer:1Side:S2	EN G	[100 to 995 / 100 / 1%/step]
2-532-028	Thick3:SizeCorrection:FC	Wide Roller:PaperTransfer:2Side:S2	EN G	[100 to 995 / 181 / 1%/step]
2-532-031	Thick3:SizeCorrection:FC	Wide Roller:PaperTransfer:1Side:S3	EN G	[100 to 995 / 100 / 1%/step]
2-532-032	Thick3:SizeCorrection:FC	Wide Roller:PaperTransfer:2Side:S3	EN G	[100 to 995 / 229 / 1%/step]
2-532-	Thick3:SizeCorrection:FC	Wide Roller:PaperTransfer:1Side:S4	EN G	[100 to 995 / 100 / 1%/step]

3.SP Mode Tables

SP No.	Large Category	Small Category	EN G or CTL	[Min to Max/Init./Step]
035				
2-532-036	Thick3:SizeCorrection:FC	Wide Roller:PaperTransfer:2Side:S4	EN G	[100 to 995 / 286 / 1%/step]
2-532-039	Thick3:SizeCorrection:FC	Wide Roller:PaperTransfer:1Side:S5	EN G	[100 to 995 / 100 / 1%/step]
2-532-040	Thick3:SizeCorrection:FC	Wide Roller:PaperTransfer:2Side:S5	EN G	[100 to 995 / 381 / 1%/step]
2-533-003	Thick3:Size-Env.Correct:BW	PaperTransfer:1Side:S1	EN G	[1 to 110 / 85 / 1/step]
2-533-004	Thick3:Size-Env.Correct:BW	PaperTransfer:2Side:S1	EN G	[1 to 110 / 87 / 1/step]
2-533-007	Thick3:Size-Env.Correct:BW	PaperTransfer:1Side:S2	EN G	[1 to 110 / 86 / 1/step]
2-533-008	Thick3:Size-Env.Correct:BW	PaperTransfer:2Side:S2	EN G	[1 to 110 / 88 / 1/step]
2-533-011	Thick3:Size-Env.Correct:BW	PaperTransfer:1Side:S3	EN G	[1 to 110 / 86 / 1/step]
2-533-	Thick3:Size-Env.Correct:BW	PaperTransfer:2Side:S3	EN G	[1 to 110 / 89 / 1/step]

3.SP Mode Tables

SP No.	Large Category	Small Category	EN G or CTL	[Min to Max/Init./Step]
012				
2-533-015	Thick3:Size-Env.Correct:BW	PaperTransfer:1Side:S4	EN G	[1 to 110 / 86 / 1/step]
2-533-016	Thick3:Size-Env.Correct:BW	PaperTransfer:2Side:S4	EN G	[1 to 110 / 90 / 1/step]
2-533-019	Thick3:Size-Env.Correct:BW	PaperTransfer:1Side:S5	EN G	[1 to 110 / 86 / 1/step]
2-533-020	Thick3:Size-Env.Correct:BW	PaperTransfer:2Side:S5	EN G	[1 to 110 / 91 / 1/step]
2-533-023	Thick3:Size-Env.Correct:BW	Wide Roller:PaperTransfer:1Side:S1	EN G	[1 to 110 / 85 / 1/step]
2-533-024	Thick3:Size-Env.Correct:BW	Wide Roller:PaperTransfer:2Side:S1	EN G	[1 to 110 / 87 / 1/step]
2-533-027	Thick3:Size-Env.Correct:BW	Wide Roller:PaperTransfer:1Side:S2	EN G	[1 to 110 / 86 / 1/step]
2-533-028	Thick3:Size-Env.Correct:BW	Wide Roller:PaperTransfer:2Side:S2	EN G	[1 to 110 / 88 / 1/step]
2-533-	Thick3:Size-Env.Correct:BW	Wide Roller:PaperTransfer:1Side:S3	EN G	[1 to 110 / 86 / 1/step]

3.SP Mode Tables

SP No.	Large Category	Small Category	EN G or CTL	[Min to Max/Init./Step]
031				
2-533-032	Thick3:Size-Env.Correct:BW	Wide Roller:PaperTransfer:2Side:S3	EN G	[1 to 110 / 89 / 1/step]
2-533-035	Thick3:Size-Env.Correct:BW	Wide Roller:PaperTransfer:1Side:S4	EN G	[1 to 110 / 86 / 1/step]
2-533-036	Thick3:Size-Env.Correct:BW	Wide Roller:PaperTransfer:2Side:S4	EN G	[1 to 110 / 90 / 1/step]
2-533-039	Thick3:Size-Env.Correct:BW	Wide Roller:PaperTransfer:1Side:S5	EN G	[1 to 110 / 86 / 1/step]
2-533-040	Thick3:Size-Env.Correct:BW	Wide Roller:PaperTransfer:2Side:S5	EN G	[1 to 110 / 91 / 1/step]
2-534-003	Thick3:Size-Env.Correct:FC	PaperTransfer:1Side:S1	EN G	[1 to 110 / 77 / 1/step]
2-534-004	Thick3:Size-Env.Correct:FC	PaperTransfer:2Side:S1	EN G	[1 to 110 / 92 / 1/step]
2-534-007	Thick3:Size-Env.Correct:FC	PaperTransfer:1Side:S2	EN G	[1 to 110 / 78 / 1/step]
2-534-	Thick3:Size-Env.Correct:FC	PaperTransfer:2Side:S2	EN G	[1 to 110 / 93 / 1/step]

3.SP Mode Tables

SP No.	Large Category	Small Category	EN G or CTL	[Min to Max/Init./Step]
008				
2-534-011	Thick3:Size-Env.Correct:FC	PaperTransfer:1Side:S3	EN G	[1 to 110 / 79 / 1/step]
2-534-012	Thick3:Size-Env.Correct:FC	PaperTransfer:2Side:S3	EN G	[1 to 110 / 94 / 1/step]
2-534-015	Thick3:Size-Env.Correct:FC	PaperTransfer:1Side:S4	EN G	[1 to 110 / 79 / 1/step]
2-534-016	Thick3:Size-Env.Correct:FC	PaperTransfer:2Side:S4	EN G	[1 to 110 / 95 / 1/step]
2-534-019	Thick3:Size-Env.Correct:FC	PaperTransfer:1Side:S5	EN G	[1 to 110 / 79 / 1/step]
2-534-020	Thick3:Size-Env.Correct:FC	PaperTransfer:2Side:S5	EN G	[1 to 110 / 96 / 1/step]
2-534-023	Thick3:Size-Env.Correct:FC	Wide Roller:PaperTransfer:1Side:S1	EN G	[1 to 110 / 77 / 1/step]
2-534-024	Thick3:Size-Env.Correct:FC	Wide Roller:PaperTransfer:2Side:S1	EN G	[1 to 110 / 92 / 1/step]
2-534-	Thick3:Size-Env.Correct:FC	Wide Roller:PaperTransfer:1Side:S2	EN G	[1 to 110 / 78 / 1/step]

3.SP Mode Tables

SP No.	Large Category	Small Category	EN G or CTL	[Min to Max/Init./Step]
027				
2-534-028	Thick3:Size-Env.Correct:FC	Wide Roller:PaperTransfer:2Side:S2	EN G	[1 to 110 / 93 / 1/step]
2-534-031	Thick3:Size-Env.Correct:FC	Wide Roller:PaperTransfer:1Side:S3	EN G	[1 to 110 / 79 / 1/step]
2-534-032	Thick3:Size-Env.Correct:FC	Wide Roller:PaperTransfer:2Side:S3	EN G	[1 to 110 / 94 / 1/step]
2-534-035	Thick3:Size-Env.Correct:FC	Wide Roller:PaperTransfer:1Side:S4	EN G	[1 to 110 / 79 / 1/step]
2-534-036	Thick3:Size-Env.Correct:FC	Wide Roller:PaperTransfer:2Side:S4	EN G	[1 to 110 / 95 / 1/step]
2-534-039	Thick3:Size-Env.Correct:FC	Wide Roller:PaperTransfer:1Side:S5	EN G	[1 to 110 / 79 / 1/step]
2-534-040	Thick3:Size-Env.Correct:FC	Wide Roller:PaperTransfer:2Side:S5	EN G	[1 to 110 / 96 / 1/step]
2-535-003	Thick3:LeadingEdgeCorrection	Paper Transfer:1side	EN G	[0 to 995 / 100 / 5%/step]
2-535-	Thick3:LeadingEdgeCorrection	Paper Transfer:2side	EN G	[0 to 995 / 100 / 5%/step]

3.SP Mode Tables

SP No.	Large Category	Small Category	EN G or CTL	[Min to Max/Init./Step]
004				
2-536-003	Thick3:SwitchTimingLeadEdge	Paper Transfer:1side	EN G	[0 to 50 / 0 / 2mm/step]
2-536-004	Thick3:SwitchTimingLeadEdge	Paper Transfer:2side	EN G	[0 to 50 / 0 / 2mm/step]
2-537-003	Thick3:TrailEdgeCorrection	Paper Transfer:1side	EN G	[0 to 995 / 100 / 5%/step]
2-537-004	Thick3:TrailEdgeCorrection	Paper Transfer:2side	EN G	[0 to 995 / 100 / 5%/step]
2-538-003	Thick3:SwitchTimingTrailEdge	Paper Transfer:1side	EN G	[0 to 50 / 0 / 2mm/step]
2-538-004	Thick3:SwitchTimingTrailEdge	Paper Transfer:2side	EN G	[0 to 50 / 0 / 2mm/step]
2-543-003	OHP:Bias:BW	PaperTransfer	EN G	IM C6000: [0 to 250 / 11 / 1-uA/step] IM C5500: [0 to 250 / 11 / 1-uA/step] IM C4500: [0 to 250 / 11 / 1-uA/step]
2-547	OHP:Bias:FC	PaperTransfer	EN G	IM C6000: [0 to 250 / 19

3.SP Mode Tables

SP No.	Large Category	Small Category	EN G or CTL	[Min to Max/Init./Step]
-003				/ 1-uA/step] IM C5500: [0 to 250 / 19 / 1-uA/step] IM C4500: [0 to 250 / 19 / 1-uA/step]
2-551-003	OHP:SizeCorrection:BW	PaperTransfer:S1	EN G	[100 to 995 / 100 / 1%/step]
2-551-007	OHP:SizeCorrection:BW	PaperTransfer:S2	EN G	[100 to 995 / 100 / 1%/step]
2-551-011	OHP:SizeCorrection:BW	PaperTransfer:S3	EN G	[100 to 995 / 100 / 1%/step]
2-551-015	OHP:SizeCorrection:BW	PaperTransfer:S4	EN G	[100 to 995 / 100 / 1%/step]
2-551-019	OHP:SizeCorrection:BW	PaperTransfer:S5	EN G	[100 to 995 / 100 / 1%/step]
2-551-023	OHP:SizeCorrection:BW	Wide Roller:PaperTransfer:S1	EN G	[100 to 995 / 100 / 1%/step]
2-551-027	OHP:SizeCorrection:BW	Wide Roller:PaperTransfer:S2	EN G	[100 to 995 / 100 / 1%/step]
2-	OHP:SizeCorrection:BW	Wide Roller:PaperTransfer:S3	EN	[100 to 995 /

3.SP Mode Tables

SP No.	Large Category	Small Category	EN G or CTL	[Min to Max/Init./Step]
551 - 031			G	100 / 1%/step]
2- 551 - 035	OHP:SizeCorrection:BW	Wide Roller:PaperTransfer:S4	EN G	[100 to 995 / 100 / 1%/step]
2- 551 - 039	OHP:SizeCorrection:BW	Wide Roller:PaperTransfer:S5	EN G	[100 to 995 / 100 / 1%/step]
2- 552 - 003	OHP:SizeCorrection:FC	PaperTransfer:S1	EN G	[100 to 995 / 100 / 1%/step]
2- 552 - 007	OHP:SizeCorrection:FC	PaperTransfer:S2	EN G	[100 to 995 / 181 / 1%/step]
2- 552 - 011	OHP:SizeCorrection:FC	PaperTransfer:S3	EN G	[100 to 995 / 229 / 1%/step]
2- 552 - 015	OHP:SizeCorrection:FC	PaperTransfer:S4	EN G	[100 to 995 / 286 / 1%/step]
2- 552 - 019	OHP:SizeCorrection:FC	PaperTransfer:S5	EN G	[100 to 995 / 381 / 1%/step]
2- 552 - 023	OHP:SizeCorrection:FC	Wide Roller:PaperTransfer:S1	EN G	[100 to 995 / 100 / 1%/step]
2-	OHP:SizeCorrection:FC	Wide Roller:PaperTransfer:S2	EN	[100 to 995 /

3.SP Mode Tables

SP No.	Large Category	Small Category	EN G or CTL	[Min to Max/Init./Step]
552 - 027			G	181 / 1%/step]
2- 552 - 031	OHP:SizeCorrection:FC	Wide Roller:PaperTransfer:S3	EN G	[100 to 995 / 229 / 1%/step]
2- 552 - 035	OHP:SizeCorrection:FC	Wide Roller:PaperTransfer:S4	EN G	[100 to 995 / 286 / 1%/step]
2- 552 - 039	OHP:SizeCorrection:FC	Wide Roller:PaperTransfer:S5	EN G	[100 to 995 / 381 / 1%/step]
2- 553 - 003	OHP:Size-Env.Correct:BW	PaperTransfer:S1	EN G	[1 to 110 / 70 / 1/step]
2- 553 - 007	OHP:Size-Env.Correct:BW	PaperTransfer:S2	EN G	[1 to 110 / 71 / 1/step]
2- 553 - 011	OHP:Size-Env.Correct:BW	PaperTransfer:S3	EN G	[1 to 110 / 72 / 1/step]
2- 553 - 015	OHP:Size-Env.Correct:BW	PaperTransfer:S4	EN G	[1 to 110 / 72 / 1/step]
2- 553 - 019	OHP:Size-Env.Correct:BW	PaperTransfer:S5	EN G	[1 to 110 / 72 / 1/step]
2-	OHP:Size-Env.Correct:BW	Wide Roller:PaperTransfer:S1	EN	[1 to 110 / 70

3.SP Mode Tables

SP No.	Large Category	Small Category	EN G or CTL	[Min to Max/Init./Step]
553 - 023			G	/ 1/step]
2- 553 - 027	OHP:Size-Env.Correct:BW	Wide Roller:PaperTransfer:S2	EN G	[1 to 110 / 71 / 1/step]
2- 553 - 031	OHP:Size-Env.Correct:BW	Wide Roller:PaperTransfer:S3	EN G	[1 to 110 / 72 / 1/step]
2- 553 - 035	OHP:Size-Env.Correct:BW	Wide Roller:PaperTransfer:S4	EN G	[1 to 110 / 72 / 1/step]
2- 553 - 039	OHP:Size-Env.Correct:BW	Wide Roller:PaperTransfer:S5	EN G	[1 to 110 / 72 / 1/step]
2- 554 - 003	OHP:Size-Env.Correct:FC	PaperTransfer:S1	EN G	[1 to 110 / 77 / 1/step]
2- 554 - 007	OHP:Size-Env.Correct:FC	PaperTransfer:S2	EN G	[1 to 110 / 78 / 1/step]
2- 554 - 011	OHP:Size-Env.Correct:FC	PaperTransfer:S3	EN G	[1 to 110 / 79 / 1/step]
2- 554 - 015	OHP:Size-Env.Correct:FC	PaperTransfer:S4	EN G	[1 to 110 / 79 / 1/step]
2-	OHP:Size-Env.Correct:FC	PaperTransfer:S5	EN	[1 to 110 / 79

3.SP Mode Tables

SP No.	Large Category	Small Category	EN G or CTL	[Min to Max/Init./Step]
554 - 019			G	/ 1/step]
2- 554 - 023	OHP:Size-Env.Correct:FC	Wide Roller:PaperTransfer:S1	EN G	[1 to 110 / 77 / 1/step]
2- 554 - 027	OHP:Size-Env.Correct:FC	Wide Roller:PaperTransfer:S2	EN G	[1 to 110 / 78 / 1/step]
2- 554 - 031	OHP:Size-Env.Correct:FC	Wide Roller:PaperTransfer:S3	EN G	[1 to 110 / 79 / 1/step]
2- 554 - 035	OHP:Size-Env.Correct:FC	Wide Roller:PaperTransfer:S4	EN G	[1 to 110 / 79 / 1/step]
2- 554 - 039	OHP:Size-Env.Correct:FC	Wide Roller:PaperTransfer:S5	EN G	[1 to 110 / 79 / 1/step]
2- 555 - 003	OHP:LeadingEdgeCorrection	Paper Transfer	EN G	[0 to 995 / 100 / 5%/step]
2- 556 - 003	OHP:SwitchTimingLeadEdge	Paper Transfer	EN G	[0 to 50 / 0 / 2mm/step]
2- 557 - 003	OHP:TrailEdgeCorrection	Paper Transfer	EN G	[0 to 995 / 100 / 5%/step]
2-	OHP:SwitchTimingTrailEdge	Paper Transfer	EN	[0 to 50 / 0 /

3.SP Mode Tables

SP No.	Large Category	Small Category	EN G or CTL	[Min to Max/Init./Step]
558 - 003			G	2mm/step]
2- 563 - 001	Special1:Bias:BW	PaperTransfer:standard:1side	EN G	IM C6000: [0 to 250 / 38 / 1-uA/step] IM C5500: [0 to 250 / 38 / 1-uA/step] IM C4500: [0 to 250 / 28 / 1-uA/step]
2- 563 - 002	Special1:Bias:BW	PaperTransfer:standard:2side	EN G	IM C6000: [0 to 250 / 38 / 1-uA/step] IM C5500: [0 to 250 / 38 / 1-uA/step] IM C4500: [0 to 250 / 28 / 1-uA/step]
2- 563 - 003	Special1:Bias:BW	PaperTransfer:low:1side	EN G	IM C6000: [0 to 250 / 11 / 1-uA/step] IM C5500: [0 to 250 / 11 / 1-uA/step] IM C4500: [0 to 250 / 11 / 1-uA/step]
2- 563 - 004	Special1:Bias:BW	PaperTransfer:low:2side	EN G	IM C6000: [0 to 250 / 11 / 1-uA/step] IM C5500: [0 to 250 / 11 / 1-uA/step]

3.SP Mode Tables

SP No.	Large Category	Small Category	EN G or CTL	[Min to Max/Init./Step]
				IM C4500: [0 to 250 / 11 / 1-uA/step]
2-567-001	Special1:Bias:FC	PaperTransfer:standard:1side	EN G	IM C6000: [0 to 250 / 50 / 1-uA/step] IM C5500: [0 to 250 / 50 / 1-uA/step] IM C4500: [0 to 250 / 36 / 1-uA/step]
2-567-002	Special1:Bias:FC	PaperTransfer:standard:2side	EN G	IM C6000: [0 to 250 / 50 / 1-uA/step] IM C5500: [0 to 250 / 50 / 1-uA/step] IM C4500: [0 to 250 / 36 / 1-uA/step]
2-567-003	Special1:Bias:FC	PaperTransfer:low:1side	EN G	IM C6000: [0 to 250 / 14 / 1-uA/step] IM C5500: [0 to 250 / 14 / 1-uA/step] IM C4500: [0 to 250 / 14 / 1-uA/step]
2-567-004	Special1:Bias:FC	PaperTransfer:low:2side	EN G	IM C6000: [0 to 250 / 14 / 1-uA/step] IM C5500: [0 to 250 / 14 / 1-uA/step]

3.SP Mode Tables

SP No.	Large Category	Small Category	EN G or CTL	[Min to Max/Init./Step]
				IM C4500: [0 to 250 / 14 / 1-uA/step]
2-571-001	Special1:SizeCorrection:BW	PaperTransfer:Standard:1Sid:S1	EN G	[100 to 995 / 100 / 1%/step]
2-571-002	Special1:SizeCorrection:BW	PaperTransfer:Standard:2Sid:S1	EN G	[100 to 995 / 100 / 1%/step]
2-571-003	Special1:SizeCorrection:BW	PaperTransfer:Low:1Side:S1	EN G	[100 to 995 / 100 / 1%/step]
2-571-004	Special1:SizeCorrection:BW	PaperTransfer:Low:2Side:S1	EN G	[100 to 995 / 100 / 1%/step]
2-571-005	Special1:SizeCorrection:BW	PaperTransfer:Standard:1Sid:S2	EN G	[100 to 995 / 100 / 1%/step]
2-571-006	Special1:SizeCorrection:BW	PaperTransfer:Standard:2Sid:S2	EN G	[100 to 995 / 105 / 1%/step]
2-571-007	Special1:SizeCorrection:BW	PaperTransfer:Low:1Side:S2	EN G	[100 to 995 / 100 / 1%/step]
2-571-008	Special1:SizeCorrection:BW	PaperTransfer:Low:2Side:S2	EN G	[100 to 995 / 105 / 1%/step]
2-	Special1:SizeCorrection:BW	PaperTransfer:Standard:1Sid:S3	EN	[100 to 995 /

3.SP Mode Tables

SP No.	Large Category	Small Category	EN G or CTL	[Min to Max/Init./Step]
571 - 009			G	105 / 1%/step]
2- 571 - 010	Special1:SizeCorrection:BW	PaperTransfer:Standard:2Sid:S3	EN G	[100 to 995 / 118 / 1%/step]
2- 571 - 011	Special1:SizeCorrection:BW	PaperTransfer:Low:1Side:S3	EN G	[100 to 995 / 105 / 1%/step]
2- 571 - 012	Special1:SizeCorrection:BW	PaperTransfer:Low:2Side:S3	EN G	[100 to 995 / 118 / 1%/step]
2- 571 - 013	Special1:SizeCorrection:BW	PaperTransfer:Standard:1Sid:S4	EN G	[100 to 995 / 118 / 1%/step]
2- 571 - 014	Special1:SizeCorrection:BW	PaperTransfer:Standard:2Sid:S4	EN G	[100 to 995 / 131 / 1%/step]
2- 571 - 015	Special1:SizeCorrection:BW	PaperTransfer:Low:1Side:S4	EN G	[100 to 995 / 118 / 1%/step]
2- 571 - 016	Special1:SizeCorrection:BW	PaperTransfer:Low:2Side:S4	EN G	[100 to 995 / 131 / 1%/step]
2- 571 - 017	Special1:SizeCorrection:BW	PaperTransfer:Standard:1Sid:S5	EN G	[100 to 995 / 132 / 1%/step]
2-	Special1:SizeCorrection:BW	PaperTransfer:Standard:2Sid:S5	EN	[100 to 995 /

3.SP Mode Tables

SP No.	Large Category	Small Category	EN G or CTL	[Min to Max/Init./Step]
571 - 018			G	184 / 1%/step]
2- 571 - 019	Special1:SizeCorrection:BW	PaperTransfer:Low:1Side:S5	EN G	[100 to 995 / 132 / 1%/step]
2- 571 - 020	Special1:SizeCorrection:BW	PaperTransfer:Low:2Side:S5	EN G	[100 to 995 / 184 / 1%/step]
2- 571 - 021	Special1:SizeCorrection:BW	Wide Roller:PaperTransfer:Standard:1Sid: S1	EN G	[100 to 995 / 100 / 1%/step]
2- 571 - 022	Special1:SizeCorrection:BW	Wide Roller:PaperTransfer:Standard:2Sid: S1	EN G	[100 to 995 / 100 / 1%/step]
2- 571 - 023	Special1:SizeCorrection:BW	Wide Roller:PaperTransfer:Low:1Side:S1	EN G	[100 to 995 / 100 / 1%/step]
2- 571 - 024	Special1:SizeCorrection:BW	Wide Roller:PaperTransfer:Low:2Side:S1	EN G	[100 to 995 / 100 / 1%/step]
2- 571 - 025	Special1:SizeCorrection:BW	Wide Roller:PaperTransfer:Standard:1Sid: S2	EN G	[100 to 995 / 100 / 1%/step]
2- 571 - 026	Special1:SizeCorrection:BW	Wide Roller:PaperTransfer:Standard:2Sid: S2	EN G	[100 to 995 / 105 / 1%/step]
2-	Special1:SizeCorrection:BW	Wide	EN	[100 to 995 /

3.SP Mode Tables

SP No.	Large Category	Small Category	EN G or CTL	[Min to Max/Init./Step]
571-027		Roller:PaperTransfer:Low:1Side:S2	G	100 / 1%/step]
2-571-028	Special1:SizeCorrection:BW	Wide Roller:PaperTransfer:Low:2Side:S2	EN G	[100 to 995 / 105 / 1%/step]
2-571-029	Special1:SizeCorrection:BW	Wide Roller:PaperTransfer:Standard:1Side:S3	EN G	[100 to 995 / 105 / 1%/step]
2-571-030	Special1:SizeCorrection:BW	Wide Roller:PaperTransfer:Standard:2Side:S3	EN G	[100 to 995 / 118 / 1%/step]
2-571-031	Special1:SizeCorrection:BW	Wide Roller:PaperTransfer:Low:1Side:S3	EN G	[100 to 995 / 105 / 1%/step]
2-571-032	Special1:SizeCorrection:BW	Wide Roller:PaperTransfer:Low:2Side:S3	EN G	[100 to 995 / 118 / 1%/step]
2-571-033	Special1:SizeCorrection:BW	Wide Roller:PaperTransfer:Standard:1Side:S4	EN G	[100 to 995 / 118 / 1%/step]
2-571-034	Special1:SizeCorrection:BW	Wide Roller:PaperTransfer:Standard:2Side:S4	EN G	[100 to 995 / 131 / 1%/step]
2-571-035	Special1:SizeCorrection:BW	Wide Roller:PaperTransfer:Low:1Side:S4	EN G	[100 to 995 / 118 / 1%/step]
2-	Special1:SizeCorrection:BW	Wide	EN	[100 to 995 /

3.SP Mode Tables

SP No.	Large Category	Small Category	EN G or CTL	[Min to Max/Init./Step]
571 - 036		Roller:PaperTransfer:Low:2Side:S4	G	131 / 1%/step]
2- 571 - 037	Special1:SizeCorrection:BW	Wide Roller:PaperTransfer:Standard:1Sid: S5	EN G	[100 to 995 / 132 / 1%/step]
2- 571 - 038	Special1:SizeCorrection:BW	Wide Roller:PaperTransfer:Standard:2Sid: S5	EN G	[100 to 995 / 184 / 1%/step]
2- 571 - 039	Special1:SizeCorrection:BW	Wide Roller:PaperTransfer:Low:1Side:S5	EN G	[100 to 995 / 132 / 1%/step]
2- 571 - 040	Special1:SizeCorrection:BW	Wide Roller:PaperTransfer:Low:2Side:S5	EN G	[100 to 995 / 184 / 1%/step]
2- 572 - 001	Special1:SizeCorrection:FC	PaperTransfer:Standard:1Sid:S1	EN G	[100 to 995 / 100 / 1%/step]
2- 572 - 002	Special1:SizeCorrection:FC	PaperTransfer:Standard:2Sid:S1	EN G	[100 to 995 / 100 / 1%/step]
2- 572 - 003	Special1:SizeCorrection:FC	PaperTransfer:Low:1Side:S1	EN G	[100 to 995 / 100 / 1%/step]
2- 572 - 004	Special1:SizeCorrection:FC	PaperTransfer:Low:2Side:S1	EN G	[100 to 995 / 100 / 1%/step]
2-	Special1:SizeCorrection:FC	PaperTransfer:Standard:1Sid:S2	EN	[100 to 995 /

3.SP Mode Tables

SP No.	Large Category	Small Category	EN G or CTL	[Min to Max/Init./Step]
572 - 005			G	120 / 1%/step]
2- 572 - 006	Special1:SizeCorrection:FC	PaperTransfer:Standard:2Sid:S2	EN G	[100 to 995 / 140 / 1%/step]
2- 572 - 007	Special1:SizeCorrection:FC	PaperTransfer:Low:1Side:S2	EN G	[100 to 995 / 120 / 1%/step]
2- 572 - 008	Special1:SizeCorrection:FC	PaperTransfer:Low:2Side:S2	EN G	[100 to 995 / 140 / 1%/step]
2- 572 - 009	Special1:SizeCorrection:FC	PaperTransfer:Standard:1Sid:S3	EN G	[100 to 995 / 118 / 1%/step]
2- 572 - 010	Special1:SizeCorrection:FC	PaperTransfer:Standard:2Sid:S3	EN G	[100 to 995 / 180 / 1%/step]
2- 572 - 011	Special1:SizeCorrection:FC	PaperTransfer:Low:1Side:S3	EN G	[100 to 995 / 118 / 1%/step]
2- 572 - 012	Special1:SizeCorrection:FC	PaperTransfer:Low:2Side:S3	EN G	[100 to 995 / 180 / 1%/step]
2- 572 - 013	Special1:SizeCorrection:FC	PaperTransfer:Standard:1Sid:S4	EN G	[100 to 995 / 130 / 1%/step]
2-	Special1:SizeCorrection:FC	PaperTransfer:Standard:2Sid:S4	EN	[100 to 995 /

3.SP Mode Tables

SP No.	Large Category	Small Category	EN G or CTL	[Min to Max/Init./Step]
572 - 014			G	200 / 1%/step]
2- 572 - 015	Special1:SizeCorrection:FC	PaperTransfer:Low:1Side:S4	EN G	[100 to 995 / 130 / 1%/step]
2- 572 - 016	Special1:SizeCorrection:FC	PaperTransfer:Low:2Side:S4	EN G	[100 to 995 / 200 / 1%/step]
2- 572 - 017	Special1:SizeCorrection:FC	PaperTransfer:Standard:1Sid:S5	EN G	[100 to 995 / 140 / 1%/step]
2- 572 - 018	Special1:SizeCorrection:FC	PaperTransfer:Standard:2Sid:S5	EN G	[100 to 995 / 240 / 1%/step]
2- 572 - 019	Special1:SizeCorrection:FC	PaperTransfer:Low:1Side:S5	EN G	[100 to 995 / 140 / 1%/step]
2- 572 - 020	Special1:SizeCorrection:FC	PaperTransfer:Low:2Side:S5	EN G	[100 to 995 / 240 / 1%/step]
2- 572 - 021	Special1:SizeCorrection:FC	Wide Roller:PaperTransfer:Standard:1Sid: S1	EN G	[100 to 995 / 100 / 1%/step]
2- 572 - 022	Special1:SizeCorrection:FC	Wide Roller:PaperTransfer:Standard:2Sid: S1	EN G	[100 to 995 / 100 / 1%/step]
2-	Special1:SizeCorrection:FC	Wide	EN	[100 to 995 /

3.SP Mode Tables

SP No.	Large Category	Small Category	EN G or CTL	[Min to Max/Init./Step]
572-023		Roller:PaperTransfer:Low:1Side:S1	G	100 / 1%/step]
2-572-024	Special1:SizeCorrection:FC	Wide Roller:PaperTransfer:Low:2Side:S1	EN G	[100 to 995 / 100 / 1%/step]
2-572-025	Special1:SizeCorrection:FC	Wide Roller:PaperTransfer:Standard:1Sid:S2	EN G	[100 to 995 / 120 / 1%/step]
2-572-026	Special1:SizeCorrection:FC	Wide Roller:PaperTransfer:Standard:2Sid:S2	EN G	[100 to 995 / 140 / 1%/step]
2-572-027	Special1:SizeCorrection:FC	Wide Roller:PaperTransfer:Low:1Side:S2	EN G	[100 to 995 / 120 / 1%/step]
2-572-028	Special1:SizeCorrection:FC	Wide Roller:PaperTransfer:Low:2Side:S2	EN G	[100 to 995 / 140 / 1%/step]
2-572-029	Special1:SizeCorrection:FC	Wide Roller:PaperTransfer:Standard:1Sid:S3	EN G	[100 to 995 / 118 / 1%/step]
2-572-030	Special1:SizeCorrection:FC	Wide Roller:PaperTransfer:Standard:2Sid:S3	EN G	[100 to 995 / 180 / 1%/step]
2-572-031	Special1:SizeCorrection:FC	Wide Roller:PaperTransfer:Low:1Side:S3	EN G	[100 to 995 / 118 / 1%/step]
2-	Special1:SizeCorrection:FC	Wide	EN	[100 to 995 /

3.SP Mode Tables

SP No.	Large Category	Small Category	EN G or CTL	[Min to Max/Init./Step]
572 - 032		Roller:PaperTransfer:Low:2Side:S3	G	180 / 1%/step]
2- 572 - 033	Special1:SizeCorrection:FC	Wide Roller:PaperTransfer:Standard:1Sid: S4	EN G	[100 to 995 / 130 / 1%/step]
2- 572 - 034	Special1:SizeCorrection:FC	Wide Roller:PaperTransfer:Standard:2Sid: S4	EN G	[100 to 995 / 200 / 1%/step]
2- 572 - 035	Special1:SizeCorrection:FC	Wide Roller:PaperTransfer:Low:1Side:S4	EN G	[100 to 995 / 130 / 1%/step]
2- 572 - 036	Special1:SizeCorrection:FC	Wide Roller:PaperTransfer:Low:2Side:S4	EN G	[100 to 995 / 200 / 1%/step]
2- 572 - 037	Special1:SizeCorrection:FC	Wide Roller:PaperTransfer:Standard:1Sid: S5	EN G	[100 to 995 / 140 / 1%/step]
2- 572 - 038	Special1:SizeCorrection:FC	Wide Roller:PaperTransfer:Standard:2Sid: S5	EN G	[100 to 995 / 240 / 1%/step]
2- 572 - 039	Special1:SizeCorrection:FC	Wide Roller:PaperTransfer:Low:1Side:S5	EN G	[100 to 995 / 140 / 1%/step]
2- 572 - 040	Special1:SizeCorrection:FC	Wide Roller:PaperTransfer:Low:2Side:S5	EN G	[100 to 995 / 240 / 1%/step]
2-	Special1:Size-Env.Correct:BW	PaperTransfer:Standard:1Sid:S1	EN	[1 to 110 / 10

3.SP Mode Tables

SP No.	Large Category	Small Category	EN G or CTL	[Min to Max/Init./Step]
573 - 001			G	/ 1/step]
2- 573 - 002	Special1:Size-Env.Correct:BW	PaperTransfer:Standard:2Sid:S1	EN G	[1 to 110 / 15 / 1/step]
2- 573 - 003	Special1:Size-Env.Correct:BW	PaperTransfer:Low:1Side:S1	EN G	[1 to 110 / 10 / 1/step]
2- 573 - 004	Special1:Size-Env.Correct:BW	PaperTransfer:Low:2Side:S1	EN G	[1 to 110 / 15 / 1/step]
2- 573 - 005	Special1:Size-Env.Correct:BW	PaperTransfer:Standard:1Sid:S2	EN G	[1 to 110 / 11 / 1/step]
2- 573 - 006	Special1:Size-Env.Correct:BW	PaperTransfer:Standard:2Sid:S2	EN G	[1 to 110 / 16 / 1/step]
2- 573 - 007	Special1:Size-Env.Correct:BW	PaperTransfer:Low:1Side:S2	EN G	[1 to 110 / 11 / 1/step]
2- 573 - 008	Special1:Size-Env.Correct:BW	PaperTransfer:Low:2Side:S2	EN G	[1 to 110 / 16 / 1/step]
2- 573 - 009	Special1:Size-Env.Correct:BW	PaperTransfer:Standard:1Sid:S3	EN G	[1 to 110 / 12 / 1/step]
2-	Special1:Size-Env.Correct:BW	PaperTransfer:Standard:2Sid:S3	EN	[1 to 110 / 17

3.SP Mode Tables

SP No.	Large Category	Small Category	EN G or CTL	[Min to Max/Init./Step]
573 - 010			G	/ 1/step]
2- 573 - 011	Special1:Size-Env.Correct:BW	PaperTransfer:Low:1Side:S3	EN G	[1 to 110 / 12 / 1/step]
2- 573 - 012	Special1:Size-Env.Correct:BW	PaperTransfer:Low:2Side:S3	EN G	[1 to 110 / 17 / 1/step]
2- 573 - 013	Special1:Size-Env.Correct:BW	PaperTransfer:Standard:1Sid:S4	EN G	[1 to 110 / 13 / 1/step]
2- 573 - 014	Special1:Size-Env.Correct:BW	PaperTransfer:Standard:2Sid:S4	EN G	[1 to 110 / 18 / 1/step]
2- 573 - 015	Special1:Size-Env.Correct:BW	PaperTransfer:Low:1Side:S4	EN G	[1 to 110 / 13 / 1/step]
2- 573 - 016	Special1:Size-Env.Correct:BW	PaperTransfer:Low:2Side:S4	EN G	[1 to 110 / 18 / 1/step]
2- 573 - 017	Special1:Size-Env.Correct:BW	PaperTransfer:Standard:1Sid:S5	EN G	[1 to 110 / 14 / 1/step]
2- 573 - 018	Special1:Size-Env.Correct:BW	PaperTransfer:Standard:2Sid:S5	EN G	[1 to 110 / 19 / 1/step]
2-	Special1:Size-Env.Correct:BW	PaperTransfer:Low:1Side:S5	EN	[1 to 110 / 14

3.SP Mode Tables

SP No.	Large Category	Small Category	EN G or CTL	[Min to Max/Init./Step]
573 - 019			G	/ 1/step]
2- 573 - 020	Special1:Size-Env.Correct:BW	PaperTransfer:Low:2Side:S5	EN G	[1 to 110 / 19 / 1/step]
2- 573 - 021	Special1:Size-Env.Correct:BW	Wide Roller:PaperTransfer:Standard:1Sid: S1	EN G	[1 to 110 / 10 / 1/step]
2- 573 - 022	Special1:Size-Env.Correct:BW	Wide Roller:PaperTransfer:Standard:2Sid: S1	EN G	[1 to 110 / 15 / 1/step]
2- 573 - 023	Special1:Size-Env.Correct:BW	Wide Roller:PaperTransfer:Low:1Side:S1	EN G	[1 to 110 / 10 / 1/step]
2- 573 - 024	Special1:Size-Env.Correct:BW	Wide Roller:PaperTransfer:Low:2Side:S1	EN G	[1 to 110 / 15 / 1/step]
2- 573 - 025	Special1:Size-Env.Correct:BW	Wide Roller:PaperTransfer:Standard:1Sid: S2	EN G	[1 to 110 / 11 / 1/step]
2- 573 - 026	Special1:Size-Env.Correct:BW	Wide Roller:PaperTransfer:Standard:2Sid: S2	EN G	[1 to 110 / 16 / 1/step]
2- 573 - 027	Special1:Size-Env.Correct:BW	Wide Roller:PaperTransfer:Low:1Side:S2	EN G	[1 to 110 / 11 / 1/step]
2-	Special1:Size-Env.Correct:BW	Wide	EN	[1 to 110 / 16

3.SP Mode Tables

SP No.	Large Category	Small Category	EN G or CTL	[Min to Max/Init./Step]
573 - 028		Roller:PaperTransfer:Low:2Side:S2	G	/ 1/step]
2- 573 - 029	Special1:Size-Env.Correct:BW	Wide Roller:PaperTransfer:Standard:1Sid: S3	EN G	[1 to 110 / 12 / 1/step]
2- 573 - 030	Special1:Size-Env.Correct:BW	Wide Roller:PaperTransfer:Standard:2Sid: S3	EN G	[1 to 110 / 17 / 1/step]
2- 573 - 031	Special1:Size-Env.Correct:BW	Wide Roller:PaperTransfer:Low:1Side:S3	EN G	[1 to 110 / 12 / 1/step]
2- 573 - 032	Special1:Size-Env.Correct:BW	Wide Roller:PaperTransfer:Low:2Side:S3	EN G	[1 to 110 / 17 / 1/step]
2- 573 - 033	Special1:Size-Env.Correct:BW	Wide Roller:PaperTransfer:Standard:1Sid: S4	EN G	[1 to 110 / 13 / 1/step]
2- 573 - 034	Special1:Size-Env.Correct:BW	Wide Roller:PaperTransfer:Standard:2Sid: S4	EN G	[1 to 110 / 18 / 1/step]
2- 573 - 035	Special1:Size-Env.Correct:BW	Wide Roller:PaperTransfer:Low:1Side:S4	EN G	[1 to 110 / 13 / 1/step]
2- 573 - 036	Special1:Size-Env.Correct:BW	Wide Roller:PaperTransfer:Low:2Side:S4	EN G	[1 to 110 / 18 / 1/step]
2-	Special1:Size-Env.Correct:BW	Wide	EN	[1 to 110 / 14

3.SP Mode Tables

SP No.	Large Category	Small Category	EN G or CTL	[Min to Max/Init./Step]
573 - 037		Roller:PaperTransfer:Standard:1Sid:S5	G	/ 1/step]
2- 573 - 038	Special1:Size-Env.Correct:BW	Wide Roller:PaperTransfer:Standard:2Sid:S5	EN G	[1 to 110 / 19 / 1/step]
2- 573 - 039	Special1:Size-Env.Correct:BW	Wide Roller:PaperTransfer:Low:1Side:S5	EN G	[1 to 110 / 14 / 1/step]
2- 573 - 040	Special1:Size-Env.Correct:BW	Wide Roller:PaperTransfer:Low:2Side:S5	EN G	[1 to 110 / 19 / 1/step]
2- 574 - 001	Special1:Size-Env.Correct:FC	PaperTransfer:Standard:1Sid:S1	EN G	[1 to 110 / 20 / 1/step]
2- 574 - 002	Special1:Size-Env.Correct:FC	PaperTransfer:Standard:2Sid:S1	EN G	[1 to 110 / 25 / 1/step]
2- 574 - 003	Special1:Size-Env.Correct:FC	PaperTransfer:Low:1Side:S1	EN G	[1 to 110 / 20 / 1/step]
2- 574 - 004	Special1:Size-Env.Correct:FC	PaperTransfer:Low:2Side:S1	EN G	[1 to 110 / 25 / 1/step]
2- 574 - 005	Special1:Size-Env.Correct:FC	PaperTransfer:Standard:1Sid:S2	EN G	[1 to 110 / 21 / 1/step]
2-	Special1:Size-Env.Correct:FC	PaperTransfer:Standard:2Sid:S2	EN	[1 to 110 / 26

3.SP Mode Tables

SP No.	Large Category	Small Category	EN G or CTL	[Min to Max/Init./Step]
574 - 006			G	/ 1/step]
2- 574 - 007	Special1:Size-Env.Correct:FC	PaperTransfer:Low:1Side:S2	EN G	[1 to 110 / 21 / 1/step]
2- 574 - 008	Special1:Size-Env.Correct:FC	PaperTransfer:Low:2Side:S2	EN G	[1 to 110 / 26 / 1/step]
2- 574 - 009	Special1:Size-Env.Correct:FC	PaperTransfer:Standard:1Sid:S3	EN G	[1 to 110 / 22 / 1/step]
2- 574 - 010	Special1:Size-Env.Correct:FC	PaperTransfer:Standard:2Sid:S3	EN G	[1 to 110 / 27 / 1/step]
2- 574 - 011	Special1:Size-Env.Correct:FC	PaperTransfer:Low:1Side:S3	EN G	[1 to 110 / 22 / 1/step]
2- 574 - 012	Special1:Size-Env.Correct:FC	PaperTransfer:Low:2Side:S3	EN G	[1 to 110 / 27 / 1/step]
2- 574 - 013	Special1:Size-Env.Correct:FC	PaperTransfer:Standard:1Sid:S4	EN G	[1 to 110 / 23 / 1/step]
2- 574 - 014	Special1:Size-Env.Correct:FC	PaperTransfer:Standard:2Sid:S4	EN G	[1 to 110 / 28 / 1/step]
2-	Special1:Size-Env.Correct:FC	PaperTransfer:Low:1Side:S4	EN	[1 to 110 / 23

3.SP Mode Tables

SP No.	Large Category	Small Category	EN G or CTL	[Min to Max/Init./Step]
574 - 015			G	/ 1/step]
2- 574 - 016	Special1:Size-Env.Correct:FC	PaperTransfer:Low:2Side:S4	EN G	[1 to 110 / 28 / 1/step]
2- 574 - 017	Special1:Size-Env.Correct:FC	PaperTransfer:Standard:1Sid:S5	EN G	[1 to 110 / 24 / 1/step]
2- 574 - 018	Special1:Size-Env.Correct:FC	PaperTransfer:Standard:2Sid:S5	EN G	[1 to 110 / 29 / 1/step]
2- 574 - 019	Special1:Size-Env.Correct:FC	PaperTransfer:Low:1Side:S5	EN G	[1 to 110 / 24 / 1/step]
2- 574 - 020	Special1:Size-Env.Correct:FC	PaperTransfer:Low:2Side:S5	EN G	[1 to 110 / 29 / 1/step]
2- 574 - 021	Special1:Size-Env.Correct:FC	Wide Roller:PaperTransfer:Standard:1Sid: S1	EN G	[1 to 110 / 20 / 1/step]
2- 574 - 022	Special1:Size-Env.Correct:FC	Wide Roller:PaperTransfer:Standard:2Sid: S1	EN G	[1 to 110 / 25 / 1/step]
2- 574 - 023	Special1:Size-Env.Correct:FC	Wide Roller:PaperTransfer:Low:1Side:S1	EN G	[1 to 110 / 20 / 1/step]
2-	Special1:Size-Env.Correct:FC	Wide	EN	[1 to 110 / 25

3.SP Mode Tables

SP No.	Large Category	Small Category	EN G or CTL	[Min to Max/Init./Step]
574 - 024		Roller:PaperTransfer:Low:2Side:S1	G	/ 1/step]
2- 574 - 025	Special1:Size-Env.Correct:FC	Wide Roller:PaperTransfer:Standard:1Sid: S2	EN G	[1 to 110 / 21 / 1/step]
2- 574 - 026	Special1:Size-Env.Correct:FC	Wide Roller:PaperTransfer:Standard:2Sid: S2	EN G	[1 to 110 / 26 / 1/step]
2- 574 - 027	Special1:Size-Env.Correct:FC	Wide Roller:PaperTransfer:Low:1Side:S2	EN G	[1 to 110 / 21 / 1/step]
2- 574 - 028	Special1:Size-Env.Correct:FC	Wide Roller:PaperTransfer:Low:2Side:S2	EN G	[1 to 110 / 26 / 1/step]
2- 574 - 029	Special1:Size-Env.Correct:FC	Wide Roller:PaperTransfer:Standard:1Sid: S3	EN G	[1 to 110 / 22 / 1/step]
2- 574 - 030	Special1:Size-Env.Correct:FC	Wide Roller:PaperTransfer:Standard:2Sid: S3	EN G	[1 to 110 / 27 / 1/step]
2- 574 - 031	Special1:Size-Env.Correct:FC	Wide Roller:PaperTransfer:Low:1Side:S3	EN G	[1 to 110 / 22 / 1/step]
2- 574 - 032	Special1:Size-Env.Correct:FC	Wide Roller:PaperTransfer:Low:2Side:S3	EN G	[1 to 110 / 27 / 1/step]
2-	Special1:Size-Env.Correct:FC	Wide	EN	[1 to 110 / 23

3.SP Mode Tables

SP No.	Large Category	Small Category	EN G or CTL	[Min to Max/Init./Step]
574 - 033		Roller:PaperTransfer:Standard:1Sid: S4	G	/ 1/step]
2- 574 - 034	Special1:Size-Env.Correct:FC	Wide Roller:PaperTransfer:Standard:2Sid: S4	EN G	[1 to 110 / 28 / 1/step]
2- 574 - 035	Special1:Size-Env.Correct:FC	Wide Roller:PaperTransfer:Low:1Side:S4	EN G	[1 to 110 / 23 / 1/step]
2- 574 - 036	Special1:Size-Env.Correct:FC	Wide Roller:PaperTransfer:Low:2Side:S4	EN G	[1 to 110 / 28 / 1/step]
2- 574 - 037	Special1:Size-Env.Correct:FC	Wide Roller:PaperTransfer:Standard:1Sid: S5	EN G	[1 to 110 / 24 / 1/step]
2- 574 - 038	Special1:Size-Env.Correct:FC	Wide Roller:PaperTransfer:Standard:2Sid: S5	EN G	[1 to 110 / 29 / 1/step]
2- 574 - 039	Special1:Size-Env.Correct:FC	Wide Roller:PaperTransfer:Low:1Side:S5	EN G	[1 to 110 / 24 / 1/step]
2- 574 - 040	Special1:Size-Env.Correct:FC	Wide Roller:PaperTransfer:Low:2Side:S5	EN G	[1 to 110 / 29 / 1/step]
2- 575 - 001	Special1:LeadingEdgeCorrecti on	PaperTransfer:Standard:1Side	EN G	[0 to 995 / 100 / 5%/step]
2-	Special1:LeadingEdgeCorrecti	PaperTransfer:Standard:2Side	EN	[0 to 995 /

3.SP Mode Tables

SP No.	Large Category	Small Category	EN G or CTL	[Min to Max/Init./Step]
575 - 002	on		G	100 / 5%/step]
2- 575 - 003	Special1:LeadingEdgeCorrecti on	Paper Transfer:Low:1side	EN G	[0 to 995 / 100 / 5%/step]
2- 575 - 004	Special1:LeadingEdgeCorrecti on	Paper Transfer:Low:2side	EN G	[0 to 995 / 100 / 5%/step]
2- 576 - 001	Special1:SwitchTimingLeadEd ge	PaperTransfer:Standard:1side	EN G	[0 to 50 / 0 / 2mm/step]
2- 576 - 002	Special1:SwitchTimingLeadEd ge	PaperTransfer:Standard:2side	EN G	[0 to 50 / 0 / 2mm/step]
2- 576 - 003	Special1:SwitchTimingLeadEd ge	Paper Transfer:Low:1side	EN G	[0 to 50 / 0 / 2mm/step]
2- 576 - 004	Special1:SwitchTimingLeadEd ge	Paper Transfer:Low:2side	EN G	[0 to 50 / 0 / 2mm/step]
2- 577 - 001	Special1:TrailEdgeCorrection	PaperTransfer:Standard:1Side	EN G	[0 to 995 / 100 / 5%/step]
2- 577 - 002	Special1:TrailEdgeCorrection	PaperTransfer:Standard:2Side	EN G	[0 to 995 / 100 / 5%/step]
2-	Special1:TrailEdgeCorrection	Paper Transfer:Low:1side	EN	[0 to 995 /

3.SP Mode Tables

SP No.	Large Category	Small Category	EN G or CTL	[Min to Max/Init./Step]
577 - 003			G	100 / 5%/step]
2- 577 - 004	Special1:TrailEdgeCorrection	Paper Transfer:Low:2side	EN G	[0 to 995 / 100 / 5%/step]
2- 578 - 001	Special1:SwitchTimingTrailEdge	PaperTransfer:Standard:1side	EN G	[0 to 50 / 0 / 2mm/step]
2- 578 - 002	Special1:SwitchTimingTrailEdge	PaperTransfer:Standard:2side	EN G	[0 to 50 / 0 / 2mm/step]
2- 578 - 003	Special1:SwitchTimingTrailEdge	Paper Transfer:Low:1side	EN G	[0 to 50 / 0 / 2mm/step]
2- 578 - 004	Special1:SwitchTimingTrailEdge	Paper Transfer:Low:2side	EN G	[0 to 50 / 0 / 2mm/step]
2- 583 - 001	Special2:Bias:BW	PaperTransfer:standard:1side	EN G	IM C6000: [0 to 250 / 38 / 1-uA/step] IM C5500: [0 to 250 / 38 / 1-uA/step] IM C4500: [0 to 250 / 28 / 1-uA/step]
2- 583 - 002	Special2:Bias:BW	PaperTransfer:standard:2side	EN G	IM C6000: [0 to 250 / 38 / 1-uA/step] IM C5500:

3.SP Mode Tables

SP No.	Large Category	Small Category	EN G or CTL	[Min to Max/Init./Step]
				[0 to 250 / 38 / 1-uA/step] IM C4500: [0 to 250 / 28 / 1-uA/step]
2-583-003	Special2:Bias:BW	PaperTransfer:low:1side	EN G	IM C6000: [0 to 250 / 11 / 1-uA/step] IM C5500: [0 to 250 / 11 / 1-uA/step] IM C4500: [0 to 250 / 11 / 1-uA/step]
2-583-004	Special2:Bias:BW	PaperTransfer:low:2side	EN G	IM C6000: [0 to 250 / 11 / 1-uA/step] IM C5500: [0 to 250 / 11 / 1-uA/step] IM C4500: [0 to 250 / 11 / 1-uA/step]
2-587-001	Special2:Bias:FC	PaperTransfer:standard:1side	EN G	IM C6000: [0 to 250 / 50 / 1-uA/step] IM C5500: [0 to 250 / 50 / 1-uA/step] IM C4500: [0 to 250 / 36 / 1-uA/step]
2-587-002	Special2:Bias:FC	PaperTransfer:standard:2side	EN G	IM C6000: [0 to 250 / 50 / 1-uA/step] IM C5500:

3.SP Mode Tables

SP No.	Large Category	Small Category	EN G or CTL	[Min to Max/Init./Step]
				[0 to 250 / 50 / 1-uA/step] IM C4500: [0 to 250 / 36 / 1-uA/step]
2-587-003	Special2:Bias:FC	PaperTransfer:low:1side	EN G	IM C6000: [0 to 250 / 14 / 1-uA/step] IM C5500: [0 to 250 / 14 / 1-uA/step] IM C4500: [0 to 250 / 14 / 1-uA/step]
2-587-004	Special2:Bias:FC	PaperTransfer:low:2side	EN G	IM C6000: [0 to 250 / 14 / 1-uA/step] IM C5500: [0 to 250 / 14 / 1-uA/step] IM C4500: [0 to 250 / 14 / 1-uA/step]
2-591-001	Special2:SizeCorrection:BW	PaperTransfer:standard:1Sid:S1	EN G	[100 to 995 / 100 / 1%/step]
2-591-002	Special2:SizeCorrection:BW	PaperTransfer:standard:2Sid:S1	EN G	[100 to 995 / 100 / 1%/step]
2-591-003	Special2:SizeCorrection:BW	PaperTransfer:Low:1Side:S1	EN G	[100 to 995 / 100 / 1%/step]
2-	Special2:SizeCorrection:BW	PaperTransfer:Low:2Side:S1	EN	[100 to 995 /

3.SP Mode Tables

SP No.	Large Category	Small Category	EN G or CTL	[Min to Max/Init./Step]
591 - 004			G	100 / 1%/step]
2- 591 - 005	Special2:SizeCorrection:BW	PaperTransfer:standard:1Sid:S2	EN G	[100 to 995 / 100 / 1%/step]
2- 591 - 006	Special2:SizeCorrection:BW	PaperTransfer:standard:2Sid:S2	EN G	[100 to 995 / 105 / 1%/step]
2- 591 - 007	Special2:SizeCorrection:BW	PaperTransfer:Low:1Side:S2	EN G	[100 to 995 / 100 / 1%/step]
2- 591 - 008	Special2:SizeCorrection:BW	PaperTransfer:Low:2Side:S2	EN G	[100 to 995 / 105 / 1%/step]
2- 591 - 009	Special2:SizeCorrection:BW	PaperTransfer:standard:1Sid:S3	EN G	[100 to 995 / 105 / 1%/step]
2- 591 - 010	Special2:SizeCorrection:BW	PaperTransfer:standard:2Sid:S3	EN G	[100 to 995 / 118 / 1%/step]
2- 591 - 011	Special2:SizeCorrection:BW	PaperTransfer:Low:1Side:S3	EN G	[100 to 995 / 105 / 1%/step]
2- 591 - 012	Special2:SizeCorrection:BW	PaperTransfer:Low:2Side:S3	EN G	[100 to 995 / 118 / 1%/step]
2-	Special2:SizeCorrection:BW	PaperTransfer:standard:1Sid:S4	EN	[100 to 995 /

3.SP Mode Tables

SP No.	Large Category	Small Category	EN G or CTL	[Min to Max/Init./Step]
591 - 013			G	118 / 1%/step]
2-591 - 014	Special2:SizeCorrection:BW	PaperTransfer:standard:2Sid:S4	EN G	[100 to 995 / 131 / 1%/step]
2-591 - 015	Special2:SizeCorrection:BW	PaperTransfer:Low:1Side:S4	EN G	[100 to 995 / 118 / 1%/step]
2-591 - 016	Special2:SizeCorrection:BW	PaperTransfer:Low:2Side:S4	EN G	[100 to 995 / 131 / 1%/step]
2-591 - 017	Special2:SizeCorrection:BW	PaperTransfer:Standard:1Sid:S5	EN G	[100 to 995 / 132 / 1%/step]
2-591 - 018	Special2:SizeCorrection:BW	PaperTransfer:Standard:2Sid:S5	EN G	[100 to 995 / 184 / 1%/step]
2-591 - 019	Special2:SizeCorrection:BW	PaperTransfer:Low:1Side:S5	EN G	[100 to 995 / 132 / 1%/step]
2-591 - 020	Special2:SizeCorrection:BW	PaperTransfer:Low:2Side:S5	EN G	[100 to 995 / 184 / 1%/step]
2-591 - 021	Special2:SizeCorrection:BW	Wide Roller:PaperTransfer:Standard:1Sid:S1	EN G	[100 to 995 / 100 / 1%/step]
2-	Special2:SizeCorrection:BW	Wide	EN	[100 to 995 /

3.SP Mode Tables

SP No.	Large Category	Small Category	EN G or CTL	[Min to Max/Init./Step]
591-022		Roller:PaperTransfer:Standard:2Sid:S1	G	100 / 1%/step]
2-591-023	Special2:SizeCorrection:BW	Wide Roller:PaperTransfer:Low:1Side:S1	EN G	[100 to 995 / 100 / 1%/step]
2-591-024	Special2:SizeCorrection:BW	Wide Roller:PaperTransfer:Low:2Side:S1	EN G	[100 to 995 / 100 / 1%/step]
2-591-025	Special2:SizeCorrection:BW	Wide Roller:PaperTransfer:Standard:1Sid:S2	EN G	[100 to 995 / 100 / 1%/step]
2-591-026	Special2:SizeCorrection:BW	Wide Roller:PaperTransfer:Standard:2Sid:S2	EN G	[100 to 995 / 105 / 1%/step]
2-591-027	Special2:SizeCorrection:BW	Wide Roller:PaperTransfer:Low:1Side:S2	EN G	[100 to 995 / 100 / 1%/step]
2-591-028	Special2:SizeCorrection:BW	Wide Roller:PaperTransfer:Low:2Side:S2	EN G	[100 to 995 / 105 / 1%/step]
2-591-029	Special2:SizeCorrection:BW	Wide Roller:PaperTransfer:Standard:1Sid:S3	EN G	[100 to 995 / 105 / 1%/step]
2-591-030	Special2:SizeCorrection:BW	Wide Roller:PaperTransfer:Standard:2Sid:S3	EN G	[100 to 995 / 118 / 1%/step]
2-	Special2:SizeCorrection:BW	Wide	EN	[100 to 995 /

3.SP Mode Tables

SP No.	Large Category	Small Category	EN G or CTL	[Min to Max/Init./Step]
591-031		Roller:PaperTransfer:Low:1Side:S3	G	105 / 1%/step]
2-591-032	Special2:SizeCorrection:BW	Wide Roller:PaperTransfer:Low:2Side:S3	EN G	[100 to 995 / 118 / 1%/step]
2-591-033	Special2:SizeCorrection:BW	Wide Roller:PaperTransfer:Standard:1Side:S4	EN G	[100 to 995 / 118 / 1%/step]
2-591-034	Special2:SizeCorrection:BW	Wide Roller:PaperTransfer:Standard:2Side:S4	EN G	[100 to 995 / 131 / 1%/step]
2-591-035	Special2:SizeCorrection:BW	Wide Roller:PaperTransfer:Low:1Side:S4	EN G	[100 to 995 / 118 / 1%/step]
2-591-036	Special2:SizeCorrection:BW	Wide Roller:PaperTransfer:Low:2Side:S4	EN G	[100 to 995 / 131 / 1%/step]
2-591-037	Special2:SizeCorrection:BW	Wide Roller:PaperTransfer:Standard:1Side:S5	EN G	[100 to 995 / 132 / 1%/step]
2-591-038	Special2:SizeCorrection:BW	Wide Roller:PaperTransfer:Standard:2Side:S5	EN G	[100 to 995 / 184 / 1%/step]
2-591-039	Special2:SizeCorrection:BW	Wide Roller:PaperTransfer:Low:1Side:S5	EN G	[100 to 995 / 132 / 1%/step]
2-	Special2:SizeCorrection:BW	Wide	EN	[100 to 995 /

3.SP Mode Tables

SP No.	Large Category	Small Category	EN G or CTL	[Min to Max/Init./Step]
591 - 040		Roller:PaperTransfer:Low:2Side:S5	G	184 / 1%/step]
2- 592 - 001	Special2:SizeCorrection:FC	PaperTransfer:standard:1Sid:S1	EN G	[100 to 995 / 100 / 1%/step]
2- 592 - 002	Special2:SizeCorrection:FC	PaperTransfer:standard:2Sid:S1	EN G	[100 to 995 / 100 / 1%/step]
2- 592 - 003	Special2:SizeCorrection:FC	PaperTransfer:Low:1Side:S1	EN G	[100 to 995 / 100 / 1%/step]
2- 592 - 004	Special2:SizeCorrection:FC	PaperTransfer:Low:2Side:S1	EN G	[100 to 995 / 100 / 1%/step]
2- 592 - 005	Special2:SizeCorrection:FC	PaperTransfer:standard:1Sid:S2	EN G	[100 to 995 / 120 / 1%/step]
2- 592 - 006	Special2:SizeCorrection:FC	PaperTransfer:standard:2Sid:S2	EN G	[100 to 995 / 140 / 1%/step]
2- 592 - 007	Special2:SizeCorrection:FC	PaperTransfer:Low:1Side:S2	EN G	[100 to 995 / 120 / 1%/step]
2- 592 - 008	Special2:SizeCorrection:FC	PaperTransfer:Low:2Side:S2	EN G	[100 to 995 / 140 / 1%/step]
2-	Special2:SizeCorrection:FC	PaperTransfer:standard:1Sid:S3	EN	[100 to 995 /

3.SP Mode Tables

SP No.	Large Category	Small Category	EN G or CTL	[Min to Max/Init./Step]
592 - 009			G	118 / 1%/step]
2-592 - 010	Special2:SizeCorrection:FC	PaperTransfer:standard:2Sid:S3	EN G	[100 to 995 / 180 / 1%/step]
2-592 - 011	Special2:SizeCorrection:FC	PaperTransfer:Low:1Side:S3	EN G	[100 to 995 / 118 / 1%/step]
2-592 - 012	Special2:SizeCorrection:FC	PaperTransfer:Low:2Side:S3	EN G	[100 to 995 / 180 / 1%/step]
2-592 - 013	Special2:SizeCorrection:FC	PaperTransfer:standard:1Sid:S4	EN G	[100 to 995 / 130 / 1%/step]
2-592 - 014	Special2:SizeCorrection:FC	PaperTransfer:standard:2Sid:S4	EN G	[100 to 995 / 200 / 1%/step]
2-592 - 015	Special2:SizeCorrection:FC	PaperTransfer:Low:1Side:S4	EN G	[100 to 995 / 130 / 1%/step]
2-592 - 016	Special2:SizeCorrection:FC	PaperTransfer:Low:2Side:S4	EN G	[100 to 995 / 200 / 1%/step]
2-592 - 017	Special2:SizeCorrection:FC	PaperTransfer:Standard:1Sid:S5	EN G	[100 to 995 / 140 / 1%/step]
2-	Special2:SizeCorrection:FC	PaperTransfer:Standard:2Sid:S5	EN	[100 to 995 /

3.SP Mode Tables

SP No.	Large Category	Small Category	EN G or CTL	[Min to Max/Init./Step]
592 - 018			G	240 / 1%/step]
2- 592 - 019	Special2:SizeCorrection:FC	PaperTransfer:Low:1Side:S5	EN G	[100 to 995 / 140 / 1%/step]
2- 592 - 020	Special2:SizeCorrection:FC	PaperTransfer:Low:2Side:S5	EN G	[100 to 995 / 240 / 1%/step]
2- 592 - 021	Special2:SizeCorrection:FC	Wide Roller:PaperTransfer:Standard:1Sid: S1	EN G	[100 to 995 / 100 / 1%/step]
2- 592 - 022	Special2:SizeCorrection:FC	Wide Roller:PaperTransfer:Standard:2Sid: S1	EN G	[100 to 995 / 100 / 1%/step]
2- 592 - 023	Special2:SizeCorrection:FC	Wide Roller:PaperTransfer:Low:1Side:S1	EN G	[100 to 995 / 100 / 1%/step]
2- 592 - 024	Special2:SizeCorrection:FC	Wide Roller:PaperTransfer:Low:2Side:S1	EN G	[100 to 995 / 100 / 1%/step]
2- 592 - 025	Special2:SizeCorrection:FC	Wide Roller:PaperTransfer:Standard:1Sid: S2	EN G	[100 to 995 / 120 / 1%/step]
2- 592 - 026	Special2:SizeCorrection:FC	Wide Roller:PaperTransfer:Standard:2Sid: S2	EN G	[100 to 995 / 140 / 1%/step]
2-	Special2:SizeCorrection:FC	Wide	EN	[100 to 995 /

3.SP Mode Tables

SP No.	Large Category	Small Category	EN G or CTL	[Min to Max/Init./Step]
592 - 027		Roller:PaperTransfer:Low:1Side:S2	G	120 / 1%/step]
2- 592 - 028	Special2:SizeCorrection:FC	Wide Roller:PaperTransfer:Low:2Side:S2	EN G	[100 to 995 / 140 / 1%/step]
2- 592 - 029	Special2:SizeCorrection:FC	Wide Roller:PaperTransfer:Standard:1Sid: S3	EN G	[100 to 995 / 118 / 1%/step]
2- 592 - 030	Special2:SizeCorrection:FC	Wide Roller:PaperTransfer:Standard:2Sid: S3	EN G	[100 to 995 / 180 / 1%/step]
2- 592 - 031	Special2:SizeCorrection:FC	Wide Roller:PaperTransfer:Low:1Side:S3	EN G	[100 to 995 / 118 / 1%/step]
2- 592 - 032	Special2:SizeCorrection:FC	Wide Roller:PaperTransfer:Low:2Side:S3	EN G	[100 to 995 / 180 / 1%/step]
2- 592 - 033	Special2:SizeCorrection:FC	Wide Roller:PaperTransfer:Standard:1Sid: S4	EN G	[100 to 995 / 130 / 1%/step]
2- 592 - 034	Special2:SizeCorrection:FC	Wide Roller:PaperTransfer:Standard:2Sid: S4	EN G	[100 to 995 / 200 / 1%/step]
2- 592 - 035	Special2:SizeCorrection:FC	Wide Roller:PaperTransfer:Low:1Side:S4	EN G	[100 to 995 / 130 / 1%/step]
2-	Special2:SizeCorrection:FC	Wide	EN	[100 to 995 /

3.SP Mode Tables

SP No.	Large Category	Small Category	EN G or CTL	[Min to Max/Init./Step]
592 - 036		Roller:PaperTransfer:Low:2Side:S4	G	200 / 1%/step]
2- 592 - 037	Special2:SizeCorrection:FC	Wide Roller:PaperTransfer:Standard:1Sid: S5	EN G	[100 to 995 / 140 / 1%/step]
2- 592 - 038	Special2:SizeCorrection:FC	Wide Roller:PaperTransfer:Standard:2Sid: S5	EN G	[100 to 995 / 240 / 1%/step]
2- 592 - 039	Special2:SizeCorrection:FC	Wide Roller:PaperTransfer:Low:1Side:S5	EN G	[100 to 995 / 140 / 1%/step]
2- 592 - 040	Special2:SizeCorrection:FC	Wide Roller:PaperTransfer:Low:2Side:S5	EN G	[100 to 995 / 240 / 1%/step]
2- 593 - 001	Special2:Size-Env.Correct:BW	PaperTransfer:standard:1Sid:S1	EN G	[1 to 110 / 10 / 1/step]
2- 593 - 002	Special2:Size-Env.Correct:BW	PaperTransfer:standard:2Sid:S1	EN G	[1 to 110 / 15 / 1/step]
2- 593 - 003	Special2:Size-Env.Correct:BW	PaperTransfer:Low:1Side:S1	EN G	[1 to 110 / 10 / 1/step]
2- 593 - 004	Special2:Size-Env.Correct:BW	PaperTransfer:Low:2Side:S1	EN G	[1 to 110 / 15 / 1/step]
2-	Special2:Size-Env.Correct:BW	PaperTransfer:standard:1Sid:S2	EN	[1 to 110 / 11

3.SP Mode Tables

SP No.	Large Category	Small Category	EN G or CTL	[Min to Max/Init./Step]
593 - 005			G	/ 1/step]
2- 593 - 006	Special2:Size-Env.Correct:BW	PaperTransfer:standard:2Sid:S2	EN G	[1 to 110 / 16 / 1/step]
2- 593 - 007	Special2:Size-Env.Correct:BW	PaperTransfer:Low:1Side:S2	EN G	[1 to 110 / 11 / 1/step]
2- 593 - 008	Special2:Size-Env.Correct:BW	PaperTransfer:Low:2Side:S2	EN G	[1 to 110 / 16 / 1/step]
2- 593 - 009	Special2:Size-Env.Correct:BW	PaperTransfer:standard:1Sid:S3	EN G	[1 to 110 / 12 / 1/step]
2- 593 - 010	Special2:Size-Env.Correct:BW	PaperTransfer:standard:2Sid:S3	EN G	[1 to 110 / 17 / 1/step]
2- 593 - 011	Special2:Size-Env.Correct:BW	PaperTransfer:Low:1Side:S3	EN G	[1 to 110 / 12 / 1/step]
2- 593 - 012	Special2:Size-Env.Correct:BW	PaperTransfer:Low:2Side:S3	EN G	[1 to 110 / 17 / 1/step]
2- 593 - 013	Special2:Size-Env.Correct:BW	PaperTransfer:standard:1Sid:S4	EN G	[1 to 110 / 13 / 1/step]
2-	Special2:Size-Env.Correct:BW	PaperTransfer:standard:2Sid:S4	EN	[1 to 110 / 18

3.SP Mode Tables

SP No.	Large Category	Small Category	EN G or CTL	[Min to Max/Init./Step]
593 - 014			G	/ 1/step]
2- 593 - 015	Special2:Size-Env.Correct:BW	PaperTransfer:Low:1Side:S4	EN G	[1 to 110 / 13 / 1/step]
2- 593 - 016	Special2:Size-Env.Correct:BW	PaperTransfer:Low:2Side:S4	EN G	[1 to 110 / 18 / 1/step]
2- 593 - 017	Special2:Size-Env.Correct:BW	PaperTransfer:Standard:1Sid:S5	EN G	[1 to 110 / 14 / 1/step]
2- 593 - 018	Special2:Size-Env.Correct:BW	PaperTransfer:Standard:2Sid:S5	EN G	[1 to 110 / 19 / 1/step]
2- 593 - 019	Special2:Size-Env.Correct:BW	PaperTransfer:Low:1Side:S5	EN G	[1 to 110 / 14 / 1/step]
2- 593 - 020	Special2:Size-Env.Correct:BW	PaperTransfer:Low:2Side:S5	EN G	[1 to 110 / 19 / 1/step]
2- 593 - 021	Special2:Size-Env.Correct:BW	Wide Roller:PaperTransfer:Standard:1Sid: S1	EN G	[1 to 110 / 10 / 1/step]
2- 593 - 022	Special2:Size-Env.Correct:BW	Wide Roller:PaperTransfer:Standard:2Sid: S1	EN G	[1 to 110 / 15 / 1/step]
2-	Special2:Size-Env.Correct:BW	Wide	EN	[1 to 110 / 10

3.SP Mode Tables

SP No.	Large Category	Small Category	EN G or CTL	[Min to Max/Init./Step]
593 - 023		Roller:PaperTransfer:Low:1Side:S1	G	/ 1/step]
2- 593 - 024	Special2:Size-Env.Correct:BW	Wide Roller:PaperTransfer:Low:2Side:S1	EN G	[1 to 110 / 15 / 1/step]
2- 593 - 025	Special2:Size-Env.Correct:BW	Wide Roller:PaperTransfer:Standard:1Sid: S2	EN G	[1 to 110 / 11 / 1/step]
2- 593 - 026	Special2:Size-Env.Correct:BW	Wide Roller:PaperTransfer:Standard:2Sid: S2	EN G	[1 to 110 / 16 / 1/step]
2- 593 - 027	Special2:Size-Env.Correct:BW	Wide Roller:PaperTransfer:Low:1Side:S2	EN G	[1 to 110 / 11 / 1/step]
2- 593 - 028	Special2:Size-Env.Correct:BW	Wide Roller:PaperTransfer:Low:2Side:S2	EN G	[1 to 110 / 16 / 1/step]
2- 593 - 029	Special2:Size-Env.Correct:BW	Wide Roller:PaperTransfer:Standard:1Sid: S3	EN G	[1 to 110 / 12 / 1/step]
2- 593 - 030	Special2:Size-Env.Correct:BW	Wide Roller:PaperTransfer:Standard:2Sid: S3	EN G	[1 to 110 / 17 / 1/step]
2- 593 - 031	Special2:Size-Env.Correct:BW	Wide Roller:PaperTransfer:Low:1Side:S3	EN G	[1 to 110 / 12 / 1/step]
2-	Special2:Size-Env.Correct:BW	Wide	EN	[1 to 110 / 17

3.SP Mode Tables

SP No.	Large Category	Small Category	EN G or CTL	[Min to Max/Init./Step]
593 - 032		Roller:PaperTransfer:Low:2Side:S3	G	/ 1/step]
2- 593 - 033	Special2:Size-Env.Correct:BW	Wide Roller:PaperTransfer:Standard:1Sid: S4	EN G	[1 to 110 / 13 / 1/step]
2- 593 - 034	Special2:Size-Env.Correct:BW	Wide Roller:PaperTransfer:Standard:2Sid: S4	EN G	[1 to 110 / 18 / 1/step]
2- 593 - 035	Special2:Size-Env.Correct:BW	Wide Roller:PaperTransfer:Low:1Side:S4	EN G	[1 to 110 / 13 / 1/step]
2- 593 - 036	Special2:Size-Env.Correct:BW	Wide Roller:PaperTransfer:Low:2Side:S4	EN G	[1 to 110 / 18 / 1/step]
2- 593 - 037	Special2:Size-Env.Correct:BW	Wide Roller:PaperTransfer:Standard:1Sid: S5	EN G	[1 to 110 / 14 / 1/step]
2- 593 - 038	Special2:Size-Env.Correct:BW	Wide Roller:PaperTransfer:Standard:2Sid: S5	EN G	[1 to 110 / 19 / 1/step]
2- 593 - 039	Special2:Size-Env.Correct:BW	Wide Roller:PaperTransfer:Low:1Side:S5	EN G	[1 to 110 / 14 / 1/step]
2- 593 - 040	Special2:Size-Env.Correct:BW	Wide Roller:PaperTransfer:Low:2Side:S5	EN G	[1 to 110 / 19 / 1/step]
2-	Special2:Size-Env.Correct:FC	PaperTransfer:standard:1Sid:S1	EN	[1 to 110 / 20

3.SP Mode Tables

SP No.	Large Category	Small Category	EN G or CTL	[Min to Max/Init./Step]
594 - 001			G	/ 1/step]
2- 594 - 002	Special2:Size-Env.Correct:FC	PaperTransfer:standard:2Sid:S1	EN G	[1 to 110 / 25 / 1/step]
2- 594 - 003	Special2:Size-Env.Correct:FC	PaperTransfer:Low:1Side:S1	EN G	[1 to 110 / 20 / 1/step]
2- 594 - 004	Special2:Size-Env.Correct:FC	PaperTransfer:Low:2Side:S1	EN G	[1 to 110 / 25 / 1/step]
2- 594 - 005	Special2:Size-Env.Correct:FC	PaperTransfer:standard:1Sid:S2	EN G	[1 to 110 / 21 / 1/step]
2- 594 - 006	Special2:Size-Env.Correct:FC	PaperTransfer:standard:2Sid:S2	EN G	[1 to 110 / 26 / 1/step]
2- 594 - 007	Special2:Size-Env.Correct:FC	PaperTransfer:Low:1Side:S2	EN G	[1 to 110 / 21 / 1/step]
2- 594 - 008	Special2:Size-Env.Correct:FC	PaperTransfer:Low:2Side:S2	EN G	[1 to 110 / 26 / 1/step]
2- 594 - 009	Special2:Size-Env.Correct:FC	PaperTransfer:standard:1Sid:S3	EN G	[1 to 110 / 22 / 1/step]
2-	Special2:Size-Env.Correct:FC	PaperTransfer:standard:2Sid:S3	EN	[1 to 110 / 27

3.SP Mode Tables

SP No.	Large Category	Small Category	EN G or CTL	[Min to Max/Init./Step]
594 - 010			G	/ 1/step]
2- 594 - 011	Special2:Size-Env.Correct:FC	PaperTransfer:Low:1Side:S3	EN G	[1 to 110 / 22 / 1/step]
2- 594 - 012	Special2:Size-Env.Correct:FC	PaperTransfer:Low:2Side:S3	EN G	[1 to 110 / 27 / 1/step]
2- 594 - 013	Special2:Size-Env.Correct:FC	PaperTransfer:standard:1Sid:S4	EN G	[1 to 110 / 23 / 1/step]
2- 594 - 014	Special2:Size-Env.Correct:FC	PaperTransfer:standard:2Sid:S4	EN G	[1 to 110 / 28 / 1/step]
2- 594 - 015	Special2:Size-Env.Correct:FC	PaperTransfer:Low:1Side:S4	EN G	[1 to 110 / 23 / 1/step]
2- 594 - 016	Special2:Size-Env.Correct:FC	PaperTransfer:Low:2Side:S4	EN G	[1 to 110 / 28 / 1/step]
2- 594 - 017	Special2:Size-Env.Correct:FC	PaperTransfer:Standard:1Sid:S5	EN G	[1 to 110 / 24 / 1/step]
2- 594 - 018	Special2:Size-Env.Correct:FC	PaperTransfer:Standard:2Sid:S5	EN G	[1 to 110 / 29 / 1/step]
2-	Special2:Size-Env.Correct:FC	PaperTransfer:Low:1Side:S5	EN	[1 to 110 / 24

3.SP Mode Tables

SP No.	Large Category	Small Category	EN G or CTL	[Min to Max/Init./Step]
594 - 019			G	/ 1/step]
2-594 - 020	Special2:Size-Env.Correct:FC	PaperTransfer:Low:2Side:S5	EN G	[1 to 110 / 29 / 1/step]
2-594 - 021	Special2:Size-Env.Correct:FC	Wide Roller:PaperTransfer:Standard:1Side:S1	EN G	[1 to 110 / 20 / 1/step]
2-594 - 022	Special2:Size-Env.Correct:FC	Wide Roller:PaperTransfer:Standard:2Side:S1	EN G	[1 to 110 / 25 / 1/step]
2-594 - 023	Special2:Size-Env.Correct:FC	Wide Roller:PaperTransfer:Low:1Side:S1	EN G	[1 to 110 / 20 / 1/step]
2-594 - 024	Special2:Size-Env.Correct:FC	Wide Roller:PaperTransfer:Low:2Side:S1	EN G	[1 to 110 / 25 / 1/step]
2-594 - 025	Special2:Size-Env.Correct:FC	Wide Roller:PaperTransfer:Standard:1Side:S2	EN G	[1 to 110 / 21 / 1/step]
2-594 - 026	Special2:Size-Env.Correct:FC	Wide Roller:PaperTransfer:Standard:2Side:S2	EN G	[1 to 110 / 26 / 1/step]
2-594 - 027	Special2:Size-Env.Correct:FC	Wide Roller:PaperTransfer:Low:1Side:S2	EN G	[1 to 110 / 21 / 1/step]
2-	Special2:Size-Env.Correct:FC	Wide	EN	[1 to 110 / 26

3.SP Mode Tables

SP No.	Large Category	Small Category	EN G or CTL	[Min to Max/Init./Step]
594 - 028		Roller:PaperTransfer:Low:2Side:S2	G	/ 1/step]
2- 594 - 029	Special2:Size-Env.Correct:FC	Wide Roller:PaperTransfer:Standard:1Sid: S3	EN G	[1 to 110 / 22 / 1/step]
2- 594 - 030	Special2:Size-Env.Correct:FC	Wide Roller:PaperTransfer:Standard:2Sid: S3	EN G	[1 to 110 / 27 / 1/step]
2- 594 - 031	Special2:Size-Env.Correct:FC	Wide Roller:PaperTransfer:Low:1Side:S3	EN G	[1 to 110 / 22 / 1/step]
2- 594 - 032	Special2:Size-Env.Correct:FC	Wide Roller:PaperTransfer:Low:2Side:S3	EN G	[1 to 110 / 27 / 1/step]
2- 594 - 033	Special2:Size-Env.Correct:FC	Wide Roller:PaperTransfer:Standard:1Sid: S4	EN G	[1 to 110 / 23 / 1/step]
2- 594 - 034	Special2:Size-Env.Correct:FC	Wide Roller:PaperTransfer:Standard:2Sid: S4	EN G	[1 to 110 / 28 / 1/step]
2- 594 - 035	Special2:Size-Env.Correct:FC	Wide Roller:PaperTransfer:Low:1Side:S4	EN G	[1 to 110 / 23 / 1/step]
2- 594 - 036	Special2:Size-Env.Correct:FC	Wide Roller:PaperTransfer:Low:2Side:S4	EN G	[1 to 110 / 28 / 1/step]
2-	Special2:Size-Env.Correct:FC	Wide	EN	[1 to 110 / 24

3.SP Mode Tables

SP No.	Large Category	Small Category	EN G or CTL	[Min to Max/Init./Step]
594 - 037		Roller:PaperTransfer:Standard:1Sid:S5	G	/ 1/step]
2-594 - 038	Special2:Size-Env.Correct:FC	Wide Roller:PaperTransfer:Standard:2Sid:S5	EN G	[1 to 110 / 29 / 1/step]
2-594 - 039	Special2:Size-Env.Correct:FC	Wide Roller:PaperTransfer:Low:1Side:S5	EN G	[1 to 110 / 24 / 1/step]
2-594 - 040	Special2:Size-Env.Correct:FC	Wide Roller:PaperTransfer:Low:2Side:S5	EN G	[1 to 110 / 29 / 1/step]
2-595 - 001	Special2:LeadingEdgeCorrection	PaperTransfer:standard:1Side	EN G	[0 to 995 / 100 / 5%/step]
2-595 - 002	Special2:LeadingEdgeCorrection	PaperTransfer:standard:2Side	EN G	[0 to 995 / 100 / 5%/step]
2-595 - 003	Special2:LeadingEdgeCorrection	Paper Transfer:Low:1side	EN G	[0 to 995 / 100 / 5%/step]
2-595 - 004	Special2:LeadingEdgeCorrection	Paper Transfer:Low:2side	EN G	[0 to 995 / 100 / 5%/step]
2-596 - 001	Special2:SwitchTimingLeadEdge	PaperTransfer:standard:1side	EN G	[0 to 50 / 0 / 2mm/step]
2-	Special2:SwitchTimingLeadEd	PaperTransfer:standard:2side	EN	[0 to 50 / 0 /

3.SP Mode Tables

SP No.	Large Category	Small Category	EN G or CTL	[Min to Max/Init./Step]
596-002	ge		G	2mm/step]
2-596-003	Special2:SwitchTimingLeadEdge	Paper Transfer:Low:1side	EN G	[0 to 50 / 0 / 2mm/step]
2-596-004	Special2:SwitchTimingLeadEdge	Paper Transfer:Low:2side	EN G	[0 to 50 / 0 / 2mm/step]
2-597-001	Special2:TrailEdgeCorrection	PaperTransfer:standard:1Side	EN G	[0 to 995 / 100 / 5%/step]
2-597-002	Special2:TrailEdgeCorrection	PaperTransfer:standard:2Side	EN G	[0 to 995 / 100 / 5%/step]
2-597-003	Special2:TrailEdgeCorrection	Paper Transfer:Low:1side	EN G	[0 to 995 / 100 / 5%/step]
2-597-004	Special2:TrailEdgeCorrection	Paper Transfer:Low:2side	EN G	[0 to 995 / 100 / 5%/step]
2-598-001	Special2:SwitchTimingTrailEdge	PaperTransfer:standard:1side	EN G	[0 to 50 / 0 / 2mm/step]
2-598-002	Special2:SwitchTimingTrailEdge	PaperTransfer:standard:2side	EN G	[0 to 50 / 0 / 2mm/step]
2-	Special2:SwitchTimingTrailEdge	Paper Transfer:Low:1side	EN	[0 to 50 / 0 /

3.SP Mode Tables

SP No.	Large Category	Small Category	EN G or CTL	[Min to Max/Init./Step]
598 - 003	e		G	2mm/step]
2-598 - 004	Special2:SwitchTimingTrailEdge	Paper Transfer:Low:2side	EN G	[0 to 50 / 0 / 2mm/step]

SP2-XXX (Drum)-4

SP No.	Large Category	Small Category	ENG or CTL	[Min to Max/Init./Step]
2-603 - 001	Special3:Bias:BW	PaperTransfer:standard:1side	ENG	IM C6000: [0 to 250 / 38 / 1-uA/step] IM C5500: [0 to 250 / 38 / 1-uA/step] IM C4500: [0 to 250 / 28 / 1-uA/step]
2-603 - 002	Special3:Bias:BW	PaperTransfer:standard:2side	ENG	IM C6000: [0 to 250 / 38 / 1-uA/step] IM C5500: [0 to 250 / 38 / 1-uA/step] IM C4500: [0 to 250 / 28 / 1-uA/step]
2-603 - 003	Special3:Bias:BW	PaperTransfer:low:1side	ENG	IM C6000: [0 to 250 / 11 / 1-uA/step] IM C5500: [0 to 250 / 11 / 1-uA/step]

3.SP Mode Tables

SP No.	Large Category	Small Category	ENG or CTL	[Min to Max/Init./Step]
				IM C4500: [0 to 250 / 11 / 1-uA/step]
2-603-004	Special3:Bias:BW	PaperTransfer:low:2side	ENG	IM C6000: [0 to 250 / 11 / 1-uA/step] IM C5500: [0 to 250 / 11 / 1-uA/step] IM C4500: [0 to 250 / 11 / 1-uA/step]
2-607-001	Special3:Bias:FC	PaperTransfer:standard:1side	ENG	IM C6000: [0 to 250 / 50 / 1-uA/step] IM C5500: [0 to 250 / 50 / 1-uA/step] IM C4500: [0 to 250 / 36 / 1-uA/step]
2-607-002	Special3:Bias:FC	PaperTransfer:standard:2side	ENG	IM C6000: [0 to 250 / 50 / 1-uA/step] IM C5500: [0 to 250 / 50 / 1-uA/step] IM C4500: [0 to 250 / 36 / 1-uA/step]
2-607-003	Special3:Bias:FC	PaperTransfer:low:1side	ENG	IM C6000: [0 to 250 / 14 / 1-uA/step] IM C5500: [0 to 250 / 14 / 1-uA/step]

3.SP Mode Tables

SP No.	Large Category	Small Category	ENG or CTL	[Min to Max/Init./Step]
				IM C4500: [0 to 250 / 14 / 1-uA/step]
2-607-004	Special3:Bias:FC	PaperTransfer:low:2side	ENG	IM C6000: [0 to 250 / 14 / 1-uA/step] IM C5500: [0 to 250 / 14 / 1-uA/step] IM C4500: [0 to 250 / 14 / 1-uA/step]
2-611-001	Special3:SizeCorrection:BW	PaperTransfer:standard:1Sid:S1	ENG	[100 to 995 / 100 / 1%/step]
2-611-002	Special3:SizeCorrection:BW	PaperTransfer:standard:2Sid:S1	ENG	[100 to 995 / 100 / 1%/step]
2-611-003	Special3:SizeCorrection:BW	PaperTransfer:Low:1Side:S1	ENG	[100 to 995 / 100 / 1%/step]
2-611-004	Special3:SizeCorrection:BW	PaperTransfer:Low:2Side:S1	ENG	[100 to 995 / 100 / 1%/step]
2-611-005	Special3:SizeCorrection:BW	PaperTransfer:standard:1Sid:S2	ENG	[100 to 995 / 100 / 1%/step]
2-611-006	Special3:SizeCorrection:BW	PaperTransfer:standard:2Sid:S2	ENG	[100 to 995 / 105 / 1%/step]

3.SP Mode Tables

SP No.	Large Category	Small Category	ENG or CTL	[Min to Max/Init./Step]
2-611-007	Special3:SizeCorrection:BW	PaperTransfer:Low:1Side:S2	ENG	[100 to 995 / 100 / 1%/step]
2-611-008	Special3:SizeCorrection:BW	PaperTransfer:Low:2Side:S2	ENG	[100 to 995 / 105 / 1%/step]
2-611-009	Special3:SizeCorrection:BW	PaperTransfer:standard:1Sid:S3	ENG	[100 to 995 / 105 / 1%/step]
2-611-010	Special3:SizeCorrection:BW	PaperTransfer:standard:2Sid:S3	ENG	[100 to 995 / 118 / 1%/step]
2-611-011	Special3:SizeCorrection:BW	PaperTransfer:Low:1Side:S3	ENG	[100 to 995 / 105 / 1%/step]
2-611-012	Special3:SizeCorrection:BW	PaperTransfer:Low:2Side:S3	ENG	[100 to 995 / 118 / 1%/step]
2-611-013	Special3:SizeCorrection:BW	PaperTransfer:standard:1Sid:S4	ENG	[100 to 995 / 118 / 1%/step]
2-611-014	Special3:SizeCorrection:BW	PaperTransfer:standard:2Sid:S4	ENG	[100 to 995 / 131 / 1%/step]
2-611-015	Special3:SizeCorrection:BW	PaperTransfer:Low:1Side:S4	ENG	[100 to 995 / 118 / 1%/step]

3.SP Mode Tables

SP No.	Large Category	Small Category	ENG or CTL	[Min to Max/Init./Step]
2-611-016	Special3:SizeCorrection:BW	PaperTransfer:Low:2Side:S4	ENG	[100 to 995 / 131 / 1%/step]
2-611-017	Special3:SizeCorrection:BW	PaperTransfer:Standard:1Sid:S5	ENG	[100 to 995 / 132 / 1%/step]
2-611-018	Special3:SizeCorrection:BW	PaperTransfer:Standard:2Sid:S5	ENG	[100 to 995 / 184 / 1%/step]
2-611-019	Special3:SizeCorrection:BW	PaperTransfer:Low:1Side:S5	ENG	[100 to 995 / 132 / 1%/step]
2-611-020	Special3:SizeCorrection:BW	PaperTransfer:Low:2Side:S5	ENG	[100 to 995 / 184 / 1%/step]
2-611-021	Special3:SizeCorrection:BW	Wide Roller:PaperTransfer:Standard:1Sid:S1	ENG	[100 to 995 / 100 / 1%/step]
2-611-022	Special3:SizeCorrection:BW	Wide Roller:PaperTransfer:Standard:2Sid:S1	ENG	[100 to 995 / 100 / 1%/step]
2-611-023	Special3:SizeCorrection:BW	Wide Roller:PaperTransfer:Low:1Side:S1	ENG	[100 to 995 / 100 / 1%/step]
2-611-024	Special3:SizeCorrection:BW	Wide Roller:PaperTransfer:Low:2Side:S1	ENG	[100 to 995 / 100 / 1%/step]

3.SP Mode Tables

SP No.	Large Category	Small Category	ENG or CTL	[Min to Max/Init./Step]
2-611-025	Special3:SizeCorrection:BW	Wide Roller:PaperTransfer:Standard:1Sid:S2	ENG	[100 to 995 / 100 / 1%/step]
2-611-026	Special3:SizeCorrection:BW	Wide Roller:PaperTransfer:Standard:2Sid:S2	ENG	[100 to 995 / 105 / 1%/step]
2-611-027	Special3:SizeCorrection:BW	Wide Roller:PaperTransfer:Low:1Side:S2	ENG	[100 to 995 / 100 / 1%/step]
2-611-028	Special3:SizeCorrection:BW	Wide Roller:PaperTransfer:Low:2Side:S2	ENG	[100 to 995 / 105 / 1%/step]
2-611-029	Special3:SizeCorrection:BW	Wide Roller:PaperTransfer:Standard:1Sid:S3	ENG	[100 to 995 / 105 / 1%/step]
2-611-030	Special3:SizeCorrection:BW	Wide Roller:PaperTransfer:Standard:2Sid:S3	ENG	[100 to 995 / 118 / 1%/step]
2-611-031	Special3:SizeCorrection:BW	Wide Roller:PaperTransfer:Low:1Side:S3	ENG	[100 to 995 / 105 / 1%/step]
2-611-032	Special3:SizeCorrection:BW	Wide Roller:PaperTransfer:Low:2Side:S3	ENG	[100 to 995 / 118 / 1%/step]
2-611-033	Special3:SizeCorrection:BW	Wide Roller:PaperTransfer:Standard:1Sid:S4	ENG	[100 to 995 / 118 / 1%/step]

3.SP Mode Tables

SP No.	Large Category	Small Category	ENG or CTL	[Min to Max/Init./Step]
2-611-034	Special3:SizeCorrection:BW	Wide Roller:PaperTransfer:Standard:2Sid:S4	ENG	[100 to 995 / 131 / 1%/step]
2-611-035	Special3:SizeCorrection:BW	Wide Roller:PaperTransfer:Low:1Side:S4	ENG	[100 to 995 / 118 / 1%/step]
2-611-036	Special3:SizeCorrection:BW	Wide Roller:PaperTransfer:Low:2Side:S4	ENG	[100 to 995 / 131 / 1%/step]
2-611-037	Special3:SizeCorrection:BW	Wide Roller:PaperTransfer:Standard:1Sid:S5	ENG	[100 to 995 / 132 / 1%/step]
2-611-038	Special3:SizeCorrection:BW	Wide Roller:PaperTransfer:Standard:2Sid:S5	ENG	[100 to 995 / 184 / 1%/step]
2-611-039	Special3:SizeCorrection:BW	Wide Roller:PaperTransfer:Low:1Side:S5	ENG	[100 to 995 / 132 / 1%/step]
2-611-040	Special3:SizeCorrection:BW	Wide Roller:PaperTransfer:Low:2Side:S5	ENG	[100 to 995 / 184 / 1%/step]
2-612-001	Special3:SizeCorrection:FC	PaperTransfer:standard:1Sid:S1	ENG	[100 to 995 / 100 / 1%/step]
2-612-002	Special3:SizeCorrection:FC	PaperTransfer:standard:2Sid:S1	ENG	[100 to 995 / 100 / 1%/step]

3.SP Mode Tables

SP No.	Large Category	Small Category	ENG or CTL	[Min to Max/Init./Step]
2-612-003	Special3:SizeCorrection:FC	PaperTransfer:Low:1Side:S1	ENG	[100 to 995 / 100 / 1%/step]
2-612-004	Special3:SizeCorrection:FC	PaperTransfer:Low:2Side:S1	ENG	[100 to 995 / 100 / 1%/step]
2-612-005	Special3:SizeCorrection:FC	PaperTransfer:standard:1Sid:S2	ENG	[100 to 995 / 120 / 1%/step]
2-612-006	Special3:SizeCorrection:FC	PaperTransfer:standard:2Sid:S2	ENG	[100 to 995 / 140 / 1%/step]
2-612-007	Special3:SizeCorrection:FC	PaperTransfer:Low:1Side:S2	ENG	[100 to 995 / 120 / 1%/step]
2-612-008	Special3:SizeCorrection:FC	PaperTransfer:Low:2Side:S2	ENG	[100 to 995 / 140 / 1%/step]
2-612-009	Special3:SizeCorrection:FC	PaperTransfer:standard:1Sid:S3	ENG	[100 to 995 / 118 / 1%/step]
2-612-010	Special3:SizeCorrection:FC	PaperTransfer:standard:2Sid:S3	ENG	[100 to 995 / 180 / 1%/step]
2-612-011	Special3:SizeCorrection:FC	PaperTransfer:Low:1Side:S3	ENG	[100 to 995 / 118 / 1%/step]

3.SP Mode Tables

SP No.	Large Category	Small Category	ENG or CTL	[Min to Max/Init./Step]
2-612-012	Special3:SizeCorrection:FC	PaperTransfer:Low:2Side:S3	ENG	[100 to 995 / 180 / 1%/step]
2-612-013	Special3:SizeCorrection:FC	PaperTransfer:standard:1Sid:S4	ENG	[100 to 995 / 130 / 1%/step]
2-612-014	Special3:SizeCorrection:FC	PaperTransfer:standard:2Sid:S4	ENG	[100 to 995 / 200 / 1%/step]
2-612-015	Special3:SizeCorrection:FC	PaperTransfer:Low:1Side:S4	ENG	[100 to 995 / 130 / 1%/step]
2-612-016	Special3:SizeCorrection:FC	PaperTransfer:Low:2Side:S4	ENG	[100 to 995 / 200 / 1%/step]
2-612-017	Special3:SizeCorrection:FC	PaperTransfer:Standard:1Sid:S5	ENG	[100 to 995 / 140 / 1%/step]
2-612-018	Special3:SizeCorrection:FC	PaperTransfer:Standard:2Sid:S5	ENG	[100 to 995 / 240 / 1%/step]
2-612-019	Special3:SizeCorrection:FC	PaperTransfer:Low:1Side:S5	ENG	[100 to 995 / 140 / 1%/step]
2-612-020	Special3:SizeCorrection:FC	PaperTransfer:Low:2Side:S5	ENG	[100 to 995 / 240 / 1%/step]

3.SP Mode Tables

SP No.	Large Category	Small Category	ENG or CTL	[Min to Max/Init./Step]
2-612-021	Special3:SizeCorrection:FC	Wide Roller:PaperTransfer:Standard:1Sid:S1	ENG	[100 to 995 / 100 / 1%/step]
2-612-022	Special3:SizeCorrection:FC	Wide Roller:PaperTransfer:Standard:2Sid:S1	ENG	[100 to 995 / 100 / 1%/step]
2-612-023	Special3:SizeCorrection:FC	Wide Roller:PaperTransfer:Low:1Side:S1	ENG	[100 to 995 / 100 / 1%/step]
2-612-024	Special3:SizeCorrection:FC	Wide Roller:PaperTransfer:Low:2Side:S1	ENG	[100 to 995 / 100 / 1%/step]
2-612-025	Special3:SizeCorrection:FC	Wide Roller:PaperTransfer:Standard:1Sid:S2	ENG	[100 to 995 / 120 / 1%/step]
2-612-026	Special3:SizeCorrection:FC	Wide Roller:PaperTransfer:Standard:2Sid:S2	ENG	[100 to 995 / 140 / 1%/step]
2-612-027	Special3:SizeCorrection:FC	Wide Roller:PaperTransfer:Low:1Side:S2	ENG	[100 to 995 / 120 / 1%/step]
2-612-028	Special3:SizeCorrection:FC	Wide Roller:PaperTransfer:Low:2Side:S2	ENG	[100 to 995 / 140 / 1%/step]
2-612-029	Special3:SizeCorrection:FC	Wide Roller:PaperTransfer:Standard:1Sid:S3	ENG	[100 to 995 / 118 / 1%/step]

3.SP Mode Tables

SP No.	Large Category	Small Category	ENG or CTL	[Min to Max/Init./Step]
2-612-030	Special3:SizeCorrection:FC	Wide Roller:PaperTransfer:Standard:2Sid:S3	ENG	[100 to 995 / 180 / 1%/step]
2-612-031	Special3:SizeCorrection:FC	Wide Roller:PaperTransfer:Low:1Side:S3	ENG	[100 to 995 / 118 / 1%/step]
2-612-032	Special3:SizeCorrection:FC	Wide Roller:PaperTransfer:Low:2Side:S3	ENG	[100 to 995 / 180 / 1%/step]
2-612-033	Special3:SizeCorrection:FC	Wide Roller:PaperTransfer:Standard:1Sid:S4	ENG	[100 to 995 / 130 / 1%/step]
2-612-034	Special3:SizeCorrection:FC	Wide Roller:PaperTransfer:Standard:2Sid:S4	ENG	[100 to 995 / 200 / 1%/step]
2-612-035	Special3:SizeCorrection:FC	Wide Roller:PaperTransfer:Low:1Side:S4	ENG	[100 to 995 / 130 / 1%/step]
2-612-036	Special3:SizeCorrection:FC	Wide Roller:PaperTransfer:Low:2Side:S4	ENG	[100 to 995 / 200 / 1%/step]
2-612-037	Special3:SizeCorrection:FC	Wide Roller:PaperTransfer:Standard:1Sid:S5	ENG	[100 to 995 / 140 / 1%/step]
2-612-038	Special3:SizeCorrection:FC	Wide Roller:PaperTransfer:Standard:2Sid:S5	ENG	[100 to 995 / 240 / 1%/step]

3.SP Mode Tables

SP No.	Large Category	Small Category	ENG or CTL	[Min to Max/Init./Step]
2-612-039	Special3:SizeCorrection:FC	Wide Roller:PaperTransfer:Low:1Side:S5	ENG	[100 to 995 / 140 / 1%/step]
2-612-040	Special3:SizeCorrection:FC	Wide Roller:PaperTransfer:Low:2Side:S5	ENG	[100 to 995 / 240 / 1%/step]
2-613-001	Special3:Size-Env.Correct:BW	PaperTransfer:standard:1Sid:S1	ENG	[1 to 110 / 10 / 1/step]
2-613-002	Special3:Size-Env.Correct:BW	PaperTransfer:standard:2Sid:S1	ENG	[1 to 110 / 15 / 1/step]
2-613-003	Special3:Size-Env.Correct:BW	PaperTransfer:Low:1Side:S1	ENG	[1 to 110 / 10 / 1/step]
2-613-004	Special3:Size-Env.Correct:BW	PaperTransfer:Low:2Side:S1	ENG	[1 to 110 / 15 / 1/step]
2-613-005	Special3:Size-Env.Correct:BW	PaperTransfer:standard:1Sid:S2	ENG	[1 to 110 / 11 / 1/step]
2-613-006	Special3:Size-Env.Correct:BW	PaperTransfer:standard:2Sid:S2	ENG	[1 to 110 / 16 / 1/step]
2-613-007	Special3:Size-Env.Correct:BW	PaperTransfer:Low:1Side:S2	ENG	[1 to 110 / 11 / 1/step]

3.SP Mode Tables

SP No.	Large Category	Small Category	ENG or CTL	[Min to Max/Init./Step]
2-613-008	Special3:Size-Env.Correct:BW	PaperTransfer:Low:2Side:S2	ENG	[1 to 110 / 16 / 1/step]
2-613-009	Special3:Size-Env.Correct:BW	PaperTransfer:standard:1Sid:S3	ENG	[1 to 110 / 12 / 1/step]
2-613-010	Special3:Size-Env.Correct:BW	PaperTransfer:standard:2Sid:S3	ENG	[1 to 110 / 17 / 1/step]
2-613-011	Special3:Size-Env.Correct:BW	PaperTransfer:Low:1Side:S3	ENG	[1 to 110 / 12 / 1/step]
2-613-012	Special3:Size-Env.Correct:BW	PaperTransfer:Low:2Side:S3	ENG	[1 to 110 / 17 / 1/step]
2-613-013	Special3:Size-Env.Correct:BW	PaperTransfer:standard:1Sid:S4	ENG	[1 to 110 / 13 / 1/step]
2-613-014	Special3:Size-Env.Correct:BW	PaperTransfer:standard:2Sid:S4	ENG	[1 to 110 / 18 / 1/step]
2-613-015	Special3:Size-Env.Correct:BW	PaperTransfer:Low:1Side:S4	ENG	[1 to 110 / 13 / 1/step]
2-613-016	Special3:Size-Env.Correct:BW	PaperTransfer:Low:2Side:S4	ENG	[1 to 110 / 18 / 1/step]

3.SP Mode Tables

SP No.	Large Category	Small Category	ENG or CTL	[Min to Max/Init./Step]
2-613-017	Special3:Size-Env.Correct:BW	PaperTransfer:Standard:1Sid:S5	ENG	[1 to 110 / 14 / 1/step]
2-613-018	Special3:Size-Env.Correct:BW	PaperTransfer:Standard:2Sid:S5	ENG	[1 to 110 / 19 / 1/step]
2-613-019	Special3:Size-Env.Correct:BW	PaperTransfer:Low:1Side:S5	ENG	[1 to 110 / 14 / 1/step]
2-613-020	Special3:Size-Env.Correct:BW	PaperTransfer:Low:2Side:S5	ENG	[1 to 110 / 19 / 1/step]
2-613-021	Special3:Size-Env.Correct:BW	Wide Roller:PaperTransfer:Standard:1Sid:S1	ENG	[1 to 110 / 10 / 1/step]
2-613-022	Special3:Size-Env.Correct:BW	Wide Roller:PaperTransfer:Standard:2Sid:S1	ENG	[1 to 110 / 15 / 1/step]
2-613-023	Special3:Size-Env.Correct:BW	Wide Roller:PaperTransfer:Low:1Side:S1	ENG	[1 to 110 / 10 / 1/step]
2-613-024	Special3:Size-Env.Correct:BW	Wide Roller:PaperTransfer:Low:2Side:S1	ENG	[1 to 110 / 15 / 1/step]
2-613-025	Special3:Size-Env.Correct:BW	Wide Roller:PaperTransfer:Standard:1Sid:S2	ENG	[1 to 110 / 11 / 1/step]

3.SP Mode Tables

SP No.	Large Category	Small Category	ENG or CTL	[Min to Max/Init./Step]
2-613-026	Special3:Size-Env.Correct:BW	Wide Roller:PaperTransfer:Standard:2Sid:S2	ENG	[1 to 110 / 16 / 1/step]
2-613-027	Special3:Size-Env.Correct:BW	Wide Roller:PaperTransfer:Low:1Side:S2	ENG	[1 to 110 / 11 / 1/step]
2-613-028	Special3:Size-Env.Correct:BW	Wide Roller:PaperTransfer:Low:2Side:S2	ENG	[1 to 110 / 16 / 1/step]
2-613-029	Special3:Size-Env.Correct:BW	Wide Roller:PaperTransfer:Standard:1Sid:S3	ENG	[1 to 110 / 12 / 1/step]
2-613-030	Special3:Size-Env.Correct:BW	Wide Roller:PaperTransfer:Standard:2Sid:S3	ENG	[1 to 110 / 17 / 1/step]
2-613-031	Special3:Size-Env.Correct:BW	Wide Roller:PaperTransfer:Low:1Side:S3	ENG	[1 to 110 / 12 / 1/step]
2-613-032	Special3:Size-Env.Correct:BW	Wide Roller:PaperTransfer:Low:2Side:S3	ENG	[1 to 110 / 17 / 1/step]
2-613-033	Special3:Size-Env.Correct:BW	Wide Roller:PaperTransfer:Standard:1Sid:S4	ENG	[1 to 110 / 13 / 1/step]
2-613-034	Special3:Size-Env.Correct:BW	Wide Roller:PaperTransfer:Standard:2Sid:S4	ENG	[1 to 110 / 18 / 1/step]

3.SP Mode Tables

SP No.	Large Category	Small Category	ENG or CTL	[Min to Max/Init./Step]
2-613-035	Special3:Size-Env.Correct:BW	Wide Roller:PaperTransfer:Low:1Side:S4	ENG	[1 to 110 / 13 / 1/step]
2-613-036	Special3:Size-Env.Correct:BW	Wide Roller:PaperTransfer:Low:2Side:S4	ENG	[1 to 110 / 18 / 1/step]
2-613-037	Special3:Size-Env.Correct:BW	Wide Roller:PaperTransfer:Standard:1Side:S5	ENG	[1 to 110 / 14 / 1/step]
2-613-038	Special3:Size-Env.Correct:BW	Wide Roller:PaperTransfer:Standard:2Side:S5	ENG	[1 to 110 / 19 / 1/step]
2-613-039	Special3:Size-Env.Correct:BW	Wide Roller:PaperTransfer:Low:1Side:S5	ENG	[1 to 110 / 14 / 1/step]
2-613-040	Special3:Size-Env.Correct:BW	Wide Roller:PaperTransfer:Low:2Side:S5	ENG	[1 to 110 / 19 / 1/step]
2-614-001	Special3:Size-Env.Correct:FC	PaperTransfer:standard:1Side:S1	ENG	[1 to 110 / 20 / 1/step]
2-614-002	Special3:Size-Env.Correct:FC	PaperTransfer:standard:2Side:S1	ENG	[1 to 110 / 25 / 1/step]
2-614-003	Special3:Size-Env.Correct:FC	PaperTransfer:Low:1Side:S1	ENG	[1 to 110 / 20 / 1/step]

3.SP Mode Tables

SP No.	Large Category	Small Category	ENG or CTL	[Min to Max/Init./Step]
2-614-004	Special3:Size-Env.Correct:FC	PaperTransfer:Low:2Side:S1	ENG	[1 to 110 / 25 / 1/step]
2-614-005	Special3:Size-Env.Correct:FC	PaperTransfer:standard:1Sid:S2	ENG	[1 to 110 / 21 / 1/step]
2-614-006	Special3:Size-Env.Correct:FC	PaperTransfer:standard:2Sid:S2	ENG	[1 to 110 / 26 / 1/step]
2-614-007	Special3:Size-Env.Correct:FC	PaperTransfer:Low:1Side:S2	ENG	[1 to 110 / 21 / 1/step]
2-614-008	Special3:Size-Env.Correct:FC	PaperTransfer:Low:2Side:S2	ENG	[1 to 110 / 26 / 1/step]
2-614-009	Special3:Size-Env.Correct:FC	PaperTransfer:standard:1Sid:S3	ENG	[1 to 110 / 22 / 1/step]
2-614-010	Special3:Size-Env.Correct:FC	PaperTransfer:standard:2Sid:S3	ENG	[1 to 110 / 27 / 1/step]
2-614-011	Special3:Size-Env.Correct:FC	PaperTransfer:Low:1Side:S3	ENG	[1 to 110 / 22 / 1/step]
2-614-012	Special3:Size-Env.Correct:FC	PaperTransfer:Low:2Side:S3	ENG	[1 to 110 / 27 / 1/step]

3.SP Mode Tables

SP No.	Large Category	Small Category	ENG or CTL	[Min to Max/Init./Step]
2-614-013	Special3:Size-Env.Correct:FC	PaperTransfer:standard:1Sid:S4	ENG	[1 to 110 / 23 / 1/step]
2-614-014	Special3:Size-Env.Correct:FC	PaperTransfer:standard:2Sid:S4	ENG	[1 to 110 / 28 / 1/step]
2-614-015	Special3:Size-Env.Correct:FC	PaperTransfer:Low:1Side:S4	ENG	[1 to 110 / 23 / 1/step]
2-614-016	Special3:Size-Env.Correct:FC	PaperTransfer:Low:2Side:S4	ENG	[1 to 110 / 28 / 1/step]
2-614-017	Special3:Size-Env.Correct:FC	PaperTransfer:Standard:1Sid:S5	ENG	[1 to 110 / 24 / 1/step]
2-614-018	Special3:Size-Env.Correct:FC	PaperTransfer:Standard:2Sid:S5	ENG	[1 to 110 / 29 / 1/step]
2-614-019	Special3:Size-Env.Correct:FC	PaperTransfer:Low:1Side:S5	ENG	[1 to 110 / 24 / 1/step]
2-614-020	Special3:Size-Env.Correct:FC	PaperTransfer:Low:2Side:S5	ENG	[1 to 110 / 29 / 1/step]
2-614-021	Special3:Size-Env.Correct:FC	Wide Roller:PaperTransfer:Standard:1Sid:S1	ENG	[1 to 110 / 20 / 1/step]

3.SP Mode Tables

SP No.	Large Category	Small Category	ENG or CTL	[Min to Max/Init./Step]
2-614-022	Special3:Size-Env.Correct:FC	Wide Roller:PaperTransfer:Standard:2Sid:S1	ENG	[1 to 110 / 25 / 1/step]
2-614-023	Special3:Size-Env.Correct:FC	Wide Roller:PaperTransfer:Low:1Side:S1	ENG	[1 to 110 / 20 / 1/step]
2-614-024	Special3:Size-Env.Correct:FC	Wide Roller:PaperTransfer:Low:2Side:S1	ENG	[1 to 110 / 25 / 1/step]
2-614-025	Special3:Size-Env.Correct:FC	Wide Roller:PaperTransfer:Standard:1Sid:S2	ENG	[1 to 110 / 21 / 1/step]
2-614-026	Special3:Size-Env.Correct:FC	Wide Roller:PaperTransfer:Standard:2Sid:S2	ENG	[1 to 110 / 26 / 1/step]
2-614-027	Special3:Size-Env.Correct:FC	Wide Roller:PaperTransfer:Low:1Side:S2	ENG	[1 to 110 / 21 / 1/step]
2-614-028	Special3:Size-Env.Correct:FC	Wide Roller:PaperTransfer:Low:2Side:S2	ENG	[1 to 110 / 26 / 1/step]
2-614-029	Special3:Size-Env.Correct:FC	Wide Roller:PaperTransfer:Standard:1Sid:S3	ENG	[1 to 110 / 22 / 1/step]
2-614-030	Special3:Size-Env.Correct:FC	Wide Roller:PaperTransfer:Standard:2Sid:S3	ENG	[1 to 110 / 27 / 1/step]

3.SP Mode Tables

SP No.	Large Category	Small Category	ENG or CTL	[Min to Max/Init./Step]
2-614-031	Special3:Size-Env.Correct:FC	Wide Roller:PaperTransfer:Low:1Side:S3	ENG	[1 to 110 / 22 / 1/step]
2-614-032	Special3:Size-Env.Correct:FC	Wide Roller:PaperTransfer:Low:2Side:S3	ENG	[1 to 110 / 27 / 1/step]
2-614-033	Special3:Size-Env.Correct:FC	Wide Roller:PaperTransfer:Standard:1Side:S4	ENG	[1 to 110 / 23 / 1/step]
2-614-034	Special3:Size-Env.Correct:FC	Wide Roller:PaperTransfer:Standard:2Side:S4	ENG	[1 to 110 / 28 / 1/step]
2-614-035	Special3:Size-Env.Correct:FC	Wide Roller:PaperTransfer:Low:1Side:S4	ENG	[1 to 110 / 23 / 1/step]
2-614-036	Special3:Size-Env.Correct:FC	Wide Roller:PaperTransfer:Low:2Side:S4	ENG	[1 to 110 / 28 / 1/step]
2-614-037	Special3:Size-Env.Correct:FC	Wide Roller:PaperTransfer:Standard:1Side:S5	ENG	[1 to 110 / 24 / 1/step]
2-614-038	Special3:Size-Env.Correct:FC	Wide Roller:PaperTransfer:Standard:2Side:S5	ENG	[1 to 110 / 29 / 1/step]
2-614-039	Special3:Size-Env.Correct:FC	Wide Roller:PaperTransfer:Low:1Side:S5	ENG	[1 to 110 / 24 / 1/step]

3.SP Mode Tables

SP No.	Large Category	Small Category	ENG or CTL	[Min to Max/Init./Step]
2-614-040	Special3:Size-Env.Correct:FC	Wide Roller:PaperTransfer:Low:2Side:S5	ENG	[1 to 110 / 29 / 1/step]
2-615-001	Special3:LeadingEdgeCorrection	Paper Transfer:standard:1side	ENG	[0 to 995 / 100 / 5%/step]
2-615-002	Special3:LeadingEdgeCorrection	Paper Transfer:standard:2side	ENG	[0 to 995 / 100 / 5%/step]
2-615-003	Special3:LeadingEdgeCorrection	Paper Transfer:Low:1side	ENG	[0 to 995 / 100 / 5%/step]
2-615-004	Special3:LeadingEdgeCorrection	Paper Transfer:Low:2side	ENG	[0 to 995 / 100 / 5%/step]
2-616-001	Special3:SwitchTimingLeadEdge	Paper Transfer:standard:1side	ENG	[0 to 50 / 0 / 2mm/step]
2-616-002	Special3:SwitchTimingLeadEdge	Paper Transfer:standard:2side	ENG	[0 to 50 / 0 / 2mm/step]
2-616-003	Special3:SwitchTimingLeadEdge	Paper Transfer:Low:1side	ENG	[0 to 50 / 0 / 2mm/step]
2-616-004	Special3:SwitchTimingLeadEdge	Paper Transfer:Low:2side	ENG	[0 to 50 / 0 / 2mm/step]

3.SP Mode Tables

SP No.	Large Category	Small Category	ENG or CTL	[Min to Max/Init./Step]
2-617-001	Special3:TrailEdgeCorrection	Paper Transfer:standard:1side	ENG	[0 to 995 / 100 / 5%/step]
2-617-002	Special3:TrailEdgeCorrection	Paper Transfer:standard:2side	ENG	[0 to 995 / 100 / 5%/step]
2-617-003	Special3:TrailEdgeCorrection	Paper Transfer:Low:1side	ENG	[0 to 995 / 100 / 5%/step]
2-617-004	Special3:TrailEdgeCorrection	Paper Transfer:Low:2side	ENG	[0 to 995 / 100 / 5%/step]
2-618-001	Special3:SwitchTimingTrailEdge	Paper Transfer:standard:1side	ENG	[0 to 50 / 0 / 2mm/step]
2-618-002	Special3:SwitchTimingTrailEdge	Paper Transfer:standard:2side	ENG	[0 to 50 / 0 / 2mm/step]
2-618-003	Special3:SwitchTimingTrailEdge	Paper Transfer:Low:1side	ENG	[0 to 50 / 0 / 2mm/step]
2-618-004	Special3:SwitchTimingTrailEdge	Paper Transfer:Low:2side	ENG	[0 to 50 / 0 / 2mm/step]
2-623-003	Special1 Thick:Bias:BW	PaperTransfer:1side	ENG	IM C6000: [0 to 250 / 11 / 1-uA/step] IM C5500:

3.SP Mode Tables

SP No.	Large Category	Small Category	ENG or CTL	[Min to Max/Init./Step]
				[0 to 250 / 11 / 1-uA/step] IM C4500: [0 to 250 / 11 / 1-uA/step]
2-623-004	Special1 Thick:Bias:BW	PaperTransfer:2side	ENG	IM C6000: [0 to 250 / 15 / 1-uA/step] IM C5500: [0 to 250 / 15 / 1-uA/step] IM C4500: [0 to 250 / 15 / 1-uA/step]
2-627-003	Special1 Thick:Bias:FC	PaperTransfer:1side	ENG	IM C6000: [0 to 250 / 19 / 1-uA/step] IM C5500: [0 to 250 / 19 / 1-uA/step] IM C4500: [0 to 250 / 19 / 1-uA/step]
2-627-004	Special1 Thick:Bias:FC	PaperTransfer:2side	ENG	IM C6000: [0 to 250 / 21 / 1-uA/step] IM C5500: [0 to 250 / 21 / 1-uA/step] IM C4500: [0 to 250 / 21 / 1-uA/step]
2-631-003	Special1Thick:PaperSizeCorr:BW	PaperTransfer:1Side:S1	ENG	[100 to 995 / 100 / 1%/step]

3.SP Mode Tables

SP No.	Large Category	Small Category	ENG or CTL	[Min to Max/Init./Step]
2-631-004	Special1Thick:PaperSizeCorr:BW	PaperTransfer:2Side:S1	ENG	[100 to 995 / 100 / 1%/step]
2-631-007	Special1Thick:PaperSizeCorr:BW	PaperTransfer:1Side:S2	ENG	[100 to 995 / 100 / 1%/step]
2-631-008	Special1Thick:PaperSizeCorr:BW	PaperTransfer:2Side:S2	ENG	[100 to 995 / 133 / 1%/step]
2-631-011	Special1Thick:PaperSizeCorr:BW	PaperTransfer:1Side:S3	ENG	[100 to 995 / 100 / 1%/step]
2-631-012	Special1Thick:PaperSizeCorr:BW	PaperTransfer:2Side:S3	ENG	[100 to 995 / 167 / 1%/step]
2-631-015	Special1Thick:PaperSizeCorr:BW	PaperTransfer:1Side:S4	ENG	[100 to 995 / 100 / 1%/step]
2-631-016	Special1Thick:PaperSizeCorr:BW	PaperTransfer:2Side:S4	ENG	[100 to 995 / 233 / 1%/step]
2-631-019	Special1Thick:PaperSizeCorr:BW	PaperTransfer:1Side:S5	ENG	[100 to 995 / 100 / 1%/step]
2-631-020	Special1Thick:PaperSizeCorr:BW	PaperTransfer:2Side:S5	ENG	[100 to 995 / 267 / 1%/step]

3.SP Mode Tables

SP No.	Large Category	Small Category	ENG or CTL	[Min to Max/Init./Step]
2-631-023	Special1Thick:PaperSizeCorr:BW	Wide Roller:PaperTransfer:1Side:S1	ENG	[100 to 995 / 100 / 1%/step]
2-631-024	Special1Thick:PaperSizeCorr:BW	Wide Roller:PaperTransfer:2Side:S1	ENG	[100 to 995 / 100 / 1%/step]
2-631-027	Special1Thick:PaperSizeCorr:BW	Wide Roller:PaperTransfer:1Side:S2	ENG	[100 to 995 / 100 / 1%/step]
2-631-028	Special1Thick:PaperSizeCorr:BW	Wide Roller:PaperTransfer:2Side:S2	ENG	[100 to 995 / 133 / 1%/step]
2-631-031	Special1Thick:PaperSizeCorr:BW	Wide Roller:PaperTransfer:1Side:S3	ENG	[100 to 995 / 100 / 1%/step]
2-631-032	Special1Thick:PaperSizeCorr:BW	Wide Roller:PaperTransfer:2Side:S3	ENG	[100 to 995 / 167 / 1%/step]
2-631-035	Special1Thick:PaperSizeCorr:BW	Wide Roller:PaperTransfer:1Side:S4	ENG	[100 to 995 / 100 / 1%/step]
2-631-036	Special1Thick:PaperSizeCorr:BW	Wide Roller:PaperTransfer:2Side:S4	ENG	[100 to 995 / 233 / 1%/step]
2-631-039	Special1Thick:PaperSizeCorr:BW	Wide Roller:PaperTransfer:1Side:S5	ENG	[100 to 995 / 100 / 1%/step]

3.SP Mode Tables

SP No.	Large Category	Small Category	ENG or CTL	[Min to Max/Init./Step]
2-631-040	Special1Thick:PaperSizeCorr:BW	Wide Roller:PaperTransfer:2Side:S5	ENG	[100 to 995 / 267 / 1%/step]
2-632-003	Special1Thick:PaperSizeCorr:FC	PaperTransfer:1Side:S1	ENG	[100 to 995 / 100 / 1%/step]
2-632-004	Special1Thick:PaperSizeCorr:FC	PaperTransfer:2Side:S1	ENG	[100 to 995 / 100 / 1%/step]
2-632-007	Special1Thick:PaperSizeCorr:FC	PaperTransfer:1Side:S2	ENG	[100 to 995 / 100 / 1%/step]
2-632-008	Special1Thick:PaperSizeCorr:FC	PaperTransfer:2Side:S2	ENG	[100 to 995 / 181 / 1%/step]
2-632-011	Special1Thick:PaperSizeCorr:FC	PaperTransfer:1Side:S3	ENG	[100 to 995 / 100 / 1%/step]
2-632-012	Special1Thick:PaperSizeCorr:FC	PaperTransfer:2Side:S3	ENG	[100 to 995 / 229 / 1%/step]
2-632-015	Special1Thick:PaperSizeCorr:FC	PaperTransfer:1Side:S4	ENG	[100 to 995 / 100 / 1%/step]
2-632-016	Special1Thick:PaperSizeCorr:FC	PaperTransfer:2Side:S4	ENG	[100 to 995 / 286 / 1%/step]

3.SP Mode Tables

SP No.	Large Category	Small Category	ENG or CTL	[Min to Max/Init./Step]
2-632-019	Special1Thick:PaperSizeCorr:F C	PaperTransfer:1Side:S5	ENG	[100 to 995 / 100 / 1%/step]
2-632-020	Special1Thick:PaperSizeCorr:F C	PaperTransfer:2Side:S5	ENG	[100 to 995 / 381 / 1%/step]
2-632-023	Special1Thick:PaperSizeCorr:F C	Wide Roller:PaperTransfer:1Side:S1	ENG	[100 to 995 / 100 / 1%/step]
2-632-024	Special1Thick:PaperSizeCorr:F C	Wide Roller:PaperTransfer:2Side:S1	ENG	[100 to 995 / 100 / 1%/step]
2-632-027	Special1Thick:PaperSizeCorr:F C	Wide Roller:PaperTransfer:1Side:S2	ENG	[100 to 995 / 100 / 1%/step]
2-632-028	Special1Thick:PaperSizeCorr:F C	Wide Roller:PaperTransfer:2Side:S2	ENG	[100 to 995 / 181 / 1%/step]
2-632-031	Special1Thick:PaperSizeCorr:F C	Wide Roller:PaperTransfer:1Side:S3	ENG	[100 to 995 / 100 / 1%/step]
2-632-032	Special1Thick:PaperSizeCorr:F C	Wide Roller:PaperTransfer:2Side:S3	ENG	[100 to 995 / 229 / 1%/step]
2-632-035	Special1Thick:PaperSizeCorr:F C	Wide Roller:PaperTransfer:1Side:S4	ENG	[100 to 995 / 100 / 1%/step]

3.SP Mode Tables

SP No.	Large Category	Small Category	ENG or CTL	[Min to Max/Init./Step]
2-632-036	Special1Thick:PaperSizeCorr:FC	Wide Roller:PaperTransfer:2Side:S4	ENG	[100 to 995 / 286 / 1%/step]
2-632-039	Special1Thick:PaperSizeCorr:FC	Wide Roller:PaperTransfer:1Side:S5	ENG	[100 to 995 / 100 / 1%/step]
2-632-040	Special1Thick:PaperSizeCorr:FC	Wide Roller:PaperTransfer:2Side:S5	ENG	[100 to 995 / 381 / 1%/step]
2-633-003	Sp1Thick:PaperSizeEnvCorr:BW	PaperTransfer:1Side:S1	ENG	[1 to 110 / 85 / 1/step]
2-633-004	Sp1Thick:PaperSizeEnvCorr:BW	PaperTransfer:2Side:S1	ENG	[1 to 110 / 87 / 1/step]
2-633-007	Sp1Thick:PaperSizeEnvCorr:BW	PaperTransfer:1Side:S2	ENG	[1 to 110 / 86 / 1/step]
2-633-008	Sp1Thick:PaperSizeEnvCorr:BW	PaperTransfer:2Side:S2	ENG	[1 to 110 / 88 / 1/step]
2-633-011	Sp1Thick:PaperSizeEnvCorr:BW	PaperTransfer:1Side:S3	ENG	[1 to 110 / 86 / 1/step]
2-633-012	Sp1Thick:PaperSizeEnvCorr:BW	PaperTransfer:2Side:S3	ENG	[1 to 110 / 89 / 1/step]

3.SP Mode Tables

SP No.	Large Category	Small Category	ENG or CTL	[Min to Max/Init./Step]
2-633-015	Sp1Thick:PaperSizeEnvCorr:BW	PaperTransfer:1Side:S4	ENG	[1 to 110 / 86 / 1/step]
2-633-016	Sp1Thick:PaperSizeEnvCorr:BW	PaperTransfer:2Side:S4	ENG	[1 to 110 / 90 / 1/step]
2-633-019	Sp1Thick:PaperSizeEnvCorr:BW	PaperTransfer:1Side:S5	ENG	[1 to 110 / 86 / 1/step]
2-633-020	Sp1Thick:PaperSizeEnvCorr:BW	PaperTransfer:2Side:S5	ENG	[1 to 110 / 91 / 1/step]
2-633-023	Sp1Thick:PaperSizeEnvCorr:BW	Wide Roller:PaperTransfer:1Side:S1	ENG	[1 to 110 / 85 / 1/step]
2-633-024	Sp1Thick:PaperSizeEnvCorr:BW	Wide Roller:PaperTransfer:2Side:S1	ENG	[1 to 110 / 87 / 1/step]
2-633-027	Sp1Thick:PaperSizeEnvCorr:BW	Wide Roller:PaperTransfer:1Side:S2	ENG	[1 to 110 / 86 / 1/step]
2-633-028	Sp1Thick:PaperSizeEnvCorr:BW	Wide Roller:PaperTransfer:2Side:S2	ENG	[1 to 110 / 88 / 1/step]
2-633-031	Sp1Thick:PaperSizeEnvCorr:BW	Wide Roller:PaperTransfer:1Side:S3	ENG	[1 to 110 / 86 / 1/step]

3.SP Mode Tables

SP No.	Large Category	Small Category	ENG or CTL	[Min to Max/Init./Step]
2-633-032	Sp1Thick:PaperSizeEnvCorr:BW	Wide Roller:PaperTransfer:2Side:S3	ENG	[1 to 110 / 89 / 1/step]
2-633-035	Sp1Thick:PaperSizeEnvCorr:BW	Wide Roller:PaperTransfer:1Side:S4	ENG	[1 to 110 / 86 / 1/step]
2-633-036	Sp1Thick:PaperSizeEnvCorr:BW	Wide Roller:PaperTransfer:2Side:S4	ENG	[1 to 110 / 90 / 1/step]
2-633-039	Sp1Thick:PaperSizeEnvCorr:BW	Wide Roller:PaperTransfer:1Side:S5	ENG	[1 to 110 / 86 / 1/step]
2-633-040	Sp1Thick:PaperSizeEnvCorr:BW	Wide Roller:PaperTransfer:2Side:S5	ENG	[1 to 110 / 91 / 1/step]
2-634-003	Sp1Thick:PaperSizeEnvCorr:FC	PaperTransfer:1Side:S1	ENG	[1 to 110 / 77 / 1/step]
2-634-004	Sp1Thick:PaperSizeEnvCorr:FC	PaperTransfer:2Side:S1	ENG	[1 to 110 / 92 / 1/step]
2-634-007	Sp1Thick:PaperSizeEnvCorr:FC	PaperTransfer:1Side:S2	ENG	[1 to 110 / 78 / 1/step]
2-634-008	Sp1Thick:PaperSizeEnvCorr:FC	PaperTransfer:2Side:S2	ENG	[1 to 110 / 93 / 1/step]

3.SP Mode Tables

SP No.	Large Category	Small Category	ENG or CTL	[Min to Max/Init./Step]
2-634-011	Sp1Thick:PaperSizeEnvCorr:F C	PaperTransfer:1Side:S3	ENG	[1 to 110 / 79 / 1/step]
2-634-012	Sp1Thick:PaperSizeEnvCorr:F C	PaperTransfer:2Side:S3	ENG	[1 to 110 / 94 / 1/step]
2-634-015	Sp1Thick:PaperSizeEnvCorr:F C	PaperTransfer:1Side:S4	ENG	[1 to 110 / 79 / 1/step]
2-634-016	Sp1Thick:PaperSizeEnvCorr:F C	PaperTransfer:2Side:S4	ENG	[1 to 110 / 95 / 1/step]
2-634-019	Sp1Thick:PaperSizeEnvCorr:F C	PaperTransfer:1Side:S5	ENG	[1 to 110 / 79 / 1/step]
2-634-020	Sp1Thick:PaperSizeEnvCorr:F C	PaperTransfer:2Side:S5	ENG	[1 to 110 / 96 / 1/step]
2-634-023	Sp1Thick:PaperSizeEnvCorr:F C	Wide Roller:PaperTransfer:1Side:S1	ENG	[1 to 110 / 77 / 1/step]
2-634-024	Sp1Thick:PaperSizeEnvCorr:F C	Wide Roller:PaperTransfer:2Side:S1	ENG	[1 to 110 / 92 / 1/step]
2-634-027	Sp1Thick:PaperSizeEnvCorr:F C	Wide Roller:PaperTransfer:1Side:S2	ENG	[1 to 110 / 78 / 1/step]

3.SP Mode Tables

SP No.	Large Category	Small Category	ENG or CTL	[Min to Max/Init./Step]
2-634-028	Sp1Thick:PaperSizeEnvCorr:F C	Wide Roller:PaperTransfer:2Side:S2	ENG	[1 to 110 / 93 / 1/step]
2-634-031	Sp1Thick:PaperSizeEnvCorr:F C	Wide Roller:PaperTransfer:1Side:S3	ENG	[1 to 110 / 79 / 1/step]
2-634-032	Sp1Thick:PaperSizeEnvCorr:F C	Wide Roller:PaperTransfer:2Side:S3	ENG	[1 to 110 / 94 / 1/step]
2-634-035	Sp1Thick:PaperSizeEnvCorr:F C	Wide Roller:PaperTransfer:1Side:S4	ENG	[1 to 110 / 79 / 1/step]
2-634-036	Sp1Thick:PaperSizeEnvCorr:F C	Wide Roller:PaperTransfer:2Side:S4	ENG	[1 to 110 / 95 / 1/step]
2-634-039	Sp1Thick:PaperSizeEnvCorr:F C	Wide Roller:PaperTransfer:1Side:S5	ENG	[1 to 110 / 79 / 1/step]
2-634-040	Sp1Thick:PaperSizeEnvCorr:F C	Wide Roller:PaperTransfer:2Side:S5	ENG	[1 to 110 / 96 / 1/step]
2-635-003	Sp1Thick:LeadingEdgeCorrecti on	Paper Transfer:1side	ENG	[0 to 995 / 100 / 5%/step]
2-635-004	Sp1Thick:LeadingEdgeCorrecti on	Paper Transfer:2side	ENG	[0 to 995 / 100 / 5%/step]

3.SP Mode Tables

SP No.	Large Category	Small Category	ENG or CTL	[Min to Max/Init./Step]
2-636-003	Sp1Thick:SwitchTimingLeadEdge	Paper Transfer:1side	ENG	[0 to 50 / 0 / 2mm/step]
2-636-004	Sp1Thick:SwitchTimingLeadEdge	Paper Transfer:2side	ENG	[0 to 50 / 0 / 2mm/step]
2-637-003	Sp1Thick:TrailEdgeCorrection	Paper Transfer:1side	ENG	[0 to 995 / 100 / 5%/step]
2-637-004	Sp1Thick:TrailEdgeCorrection	Paper Transfer:2side	ENG	[0 to 995 / 100 / 5%/step]
2-638-003	Sp1Thick:SwitchTimingTrailEdge	Paper Transfer:1side	ENG	[0 to 50 / 0 / 2mm/step]
2-638-004	Sp1Thick:SwitchTimingTrailEdge	Paper Transfer:2side	ENG	[0 to 50 / 0 / 2mm/step]
2-643-003	Special2 Thick:Bias:BW	PaperTransfer:1side	ENG	IM C6000: [0 to 250 / 11 / 1-uA/step] IM C5500: [0 to 250 / 11 / 1-uA/step] IM C4500: [0 to 250 / 11 / 1-uA/step]
2-643-	Special2 Thick:Bias:BW	PaperTransfer:2side	ENG	IM C6000: [0 to 250 / 15 / 1-uA/step]

3.SP Mode Tables

SP No.	Large Category	Small Category	ENG or CTL	[Min to Max/Init./Step]
004				IM C5500: [0 to 250 / 15 / 1-uA/step] IM C4500: [0 to 250 / 15 / 1-uA/step]
2-647-003	Special2 Thick:Bias:FC	PaperTransfer:1side	ENG	IM C6000: [0 to 250 / 19 / 1-uA/step] IM C5500: [0 to 250 / 19 / 1-uA/step] IM C4500: [0 to 250 / 19 / 1-uA/step]
2-647-004	Special2 Thick:Bias:FC	PaperTransfer:2side	ENG	IM C6000: [0 to 250 / 21 / 1-uA/step] IM C5500: [0 to 250 / 21 / 1-uA/step] IM C4500: [0 to 250 / 21 / 1-uA/step]
2-651-003	Special2Thick:PaperSizeCorr:BW	PaperTransfer:1Side:S1	ENG	[100 to 995 / 100 / 1%/step]
2-651-004	Special2Thick:PaperSizeCorr:BW	PaperTransfer:2Side:S1	ENG	[100 to 995 / 100 / 1%/step]
2-651-007	Special2Thick:PaperSizeCorr:BW	PaperTransfer:1Side:S2	ENG	[100 to 995 / 100 / 1%/step]

3.SP Mode Tables

SP No.	Large Category	Small Category	ENG or CTL	[Min to Max/Init./Step]
2-651-008	Special2Thick:PaperSizeCorr:BW	PaperTransfer:2Side:S2	ENG	[100 to 995 / 133 / 1%/step]
2-651-011	Special2Thick:PaperSizeCorr:BW	PaperTransfer:1Side:S3	ENG	[100 to 995 / 100 / 1%/step]
2-651-012	Special2Thick:PaperSizeCorr:BW	PaperTransfer:2Side:S3	ENG	[100 to 995 / 167 / 1%/step]
2-651-015	Special2Thick:PaperSizeCorr:BW	PaperTransfer:1Side:S4	ENG	[100 to 995 / 100 / 1%/step]
2-651-016	Special2Thick:PaperSizeCorr:BW	PaperTransfer:2Side:S4	ENG	[100 to 995 / 233 / 1%/step]
2-651-019	Special2Thick:PaperSizeCorr:BW	PaperTransfer:1Side:S5	ENG	[100 to 995 / 100 / 1%/step]
2-651-020	Special2Thick:PaperSizeCorr:BW	PaperTransfer:2Side:S5	ENG	[100 to 995 / 267 / 1%/step]
2-651-023	Special2Thick:PaperSizeCorr:BW	Wide Roller:PaperTransfer:1Side:S1	ENG	[100 to 995 / 100 / 1%/step]
2-651-024	Special2Thick:PaperSizeCorr:BW	Wide Roller:PaperTransfer:2Side:S1	ENG	[100 to 995 / 100 / 1%/step]

3.SP Mode Tables

SP No.	Large Category	Small Category	ENG or CTL	[Min to Max/Init./Step]
2-651-027	Special2Thick:PaperSizeCorr:BW	Wide Roller:PaperTransfer:1Side:S2	ENG	[100 to 995 / 100 / 1%/step]
2-651-028	Special2Thick:PaperSizeCorr:BW	Wide Roller:PaperTransfer:2Side:S2	ENG	[100 to 995 / 133 / 1%/step]
2-651-031	Special2Thick:PaperSizeCorr:BW	Wide Roller:PaperTransfer:1Side:S3	ENG	[100 to 995 / 100 / 1%/step]
2-651-032	Special2Thick:PaperSizeCorr:BW	Wide Roller:PaperTransfer:2Side:S3	ENG	[100 to 995 / 167 / 1%/step]
2-651-035	Special2Thick:PaperSizeCorr:BW	Wide Roller:PaperTransfer:1Side:S4	ENG	[100 to 995 / 100 / 1%/step]
2-651-036	Special2Thick:PaperSizeCorr:BW	Wide Roller:PaperTransfer:2Side:S4	ENG	[100 to 995 / 233 / 1%/step]
2-651-039	Special2Thick:PaperSizeCorr:BW	Wide Roller:PaperTransfer:1Side:S5	ENG	[100 to 995 / 100 / 1%/step]
2-651-040	Special2Thick:PaperSizeCorr:BW	Wide Roller:PaperTransfer:2Side:S5	ENG	[100 to 995 / 267 / 1%/step]
2-652-003	Special2Thick:PaperSizeCorr:FC	PaperTransfer:1Side:S1	ENG	[100 to 995 / 100 / 1%/step]

3.SP Mode Tables

SP No.	Large Category	Small Category	ENG or CTL	[Min to Max/Init./Step]
2-652-004	Special2Thick:PaperSizeCorr:F C	PaperTransfer:2Side:S1	ENG	[100 to 995 / 100 / 1%/step]
2-652-007	Special2Thick:PaperSizeCorr:F C	PaperTransfer:1Side:S2	ENG	[100 to 995 / 100 / 1%/step]
2-652-008	Special2Thick:PaperSizeCorr:F C	PaperTransfer:2Side:S2	ENG	[100 to 995 / 181 / 1%/step]
2-652-011	Special2Thick:PaperSizeCorr:F C	PaperTransfer:1Side:S3	ENG	[100 to 995 / 100 / 1%/step]
2-652-012	Special2Thick:PaperSizeCorr:F C	PaperTransfer:2Side:S3	ENG	[100 to 995 / 229 / 1%/step]
2-652-015	Special2Thick:PaperSizeCorr:F C	PaperTransfer:1Side:S4	ENG	[100 to 995 / 100 / 1%/step]
2-652-016	Special2Thick:PaperSizeCorr:F C	PaperTransfer:2Side:S4	ENG	[100 to 995 / 286 / 1%/step]
2-652-019	Special2Thick:PaperSizeCorr:F C	PaperTransfer:1Side:S5	ENG	[100 to 995 / 100 / 1%/step]
2-652-020	Special2Thick:PaperSizeCorr:F C	PaperTransfer:2Side:S5	ENG	[100 to 995 / 381 / 1%/step]

3.SP Mode Tables

SP No.	Large Category	Small Category	ENG or CTL	[Min to Max/Init./Step]
2-652-023	Special2Thick:PaperSizeCorr:F C	Wide Roller:PaperTransfer:1Side:S1	ENG	[100 to 995 / 100 / 1%/step]
2-652-024	Special2Thick:PaperSizeCorr:F C	Wide Roller:PaperTransfer:2Side:S1	ENG	[100 to 995 / 100 / 1%/step]
2-652-027	Special2Thick:PaperSizeCorr:F C	Wide Roller:PaperTransfer:1Side:S2	ENG	[100 to 995 / 100 / 1%/step]
2-652-028	Special2Thick:PaperSizeCorr:F C	Wide Roller:PaperTransfer:2Side:S2	ENG	[100 to 995 / 181 / 1%/step]
2-652-031	Special2Thick:PaperSizeCorr:F C	Wide Roller:PaperTransfer:1Side:S3	ENG	[100 to 995 / 100 / 1%/step]
2-652-032	Special2Thick:PaperSizeCorr:F C	Wide Roller:PaperTransfer:2Side:S3	ENG	[100 to 995 / 229 / 1%/step]
2-652-035	Special2Thick:PaperSizeCorr:F C	Wide Roller:PaperTransfer:1Side:S4	ENG	[100 to 995 / 100 / 1%/step]
2-652-036	Special2Thick:PaperSizeCorr:F C	Wide Roller:PaperTransfer:2Side:S4	ENG	[100 to 995 / 286 / 1%/step]
2-652-039	Special2Thick:PaperSizeCorr:F C	Wide Roller:PaperTransfer:1Side:S5	ENG	[100 to 995 / 100 / 1%/step]

3.SP Mode Tables

SP No.	Large Category	Small Category	ENG or CTL	[Min to Max/Init./Step]
2-652-040	Special2Thick:PaperSizeCorr:FC	Wide Roller:PaperTransfer:2Side:S5	ENG	[100 to 995 / 381 / 1%/step]
2-653-003	Sp2Thick:PaperSizeEnvCorr:BW	PaperTransfer:1Side:S1	ENG	[1 to 110 / 70 / 1/step]
2-653-004	Sp2Thick:PaperSizeEnvCorr:BW	PaperTransfer:2Side:S1	ENG	[1 to 110 / 72 / 1/step]
2-653-007	Sp2Thick:PaperSizeEnvCorr:BW	PaperTransfer:1Side:S2	ENG	[1 to 110 / 71 / 1/step]
2-653-008	Sp2Thick:PaperSizeEnvCorr:BW	PaperTransfer:2Side:S2	ENG	[1 to 110 / 73 / 1/step]
2-653-011	Sp2Thick:PaperSizeEnvCorr:BW	PaperTransfer:1Side:S3	ENG	[1 to 110 / 72 / 1/step]
2-653-012	Sp2Thick:PaperSizeEnvCorr:BW	PaperTransfer:2Side:S3	ENG	[1 to 110 / 74 / 1/step]
2-653-015	Sp2Thick:PaperSizeEnvCorr:BW	PaperTransfer:1Side:S4	ENG	[1 to 110 / 72 / 1/step]
2-653-016	Sp2Thick:PaperSizeEnvCorr:BW	PaperTransfer:2Side:S4	ENG	[1 to 110 / 75 / 1/step]

3.SP Mode Tables

SP No.	Large Category	Small Category	ENG or CTL	[Min to Max/Init./Step]
2-653-019	Sp2Thick:PaperSizeEnvCorr:BW	PaperTransfer:1Side:S5	ENG	[1 to 110 / 72 / 1/step]
2-653-020	Sp2Thick:PaperSizeEnvCorr:BW	PaperTransfer:2Side:S5	ENG	[1 to 110 / 76 / 1/step]
2-653-023	Sp2Thick:PaperSizeEnvCorr:BW	Wide Roller:PaperTransfer:1Side:S1	ENG	[1 to 110 / 70 / 1/step]
2-653-024	Sp2Thick:PaperSizeEnvCorr:BW	Wide Roller:PaperTransfer:2Side:S1	ENG	[1 to 110 / 72 / 1/step]
2-653-027	Sp2Thick:PaperSizeEnvCorr:BW	Wide Roller:PaperTransfer:1Side:S2	ENG	[1 to 110 / 71 / 1/step]
2-653-028	Sp2Thick:PaperSizeEnvCorr:BW	Wide Roller:PaperTransfer:2Side:S2	ENG	[1 to 110 / 73 / 1/step]
2-653-031	Sp2Thick:PaperSizeEnvCorr:BW	Wide Roller:PaperTransfer:1Side:S3	ENG	[1 to 110 / 72 / 1/step]
2-653-032	Sp2Thick:PaperSizeEnvCorr:BW	Wide Roller:PaperTransfer:2Side:S3	ENG	[1 to 110 / 74 / 1/step]
2-653-035	Sp2Thick:PaperSizeEnvCorr:BW	Wide Roller:PaperTransfer:1Side:S4	ENG	[1 to 110 / 72 / 1/step]

3.SP Mode Tables

SP No.	Large Category	Small Category	ENG or CTL	[Min to Max/Init./Step]
2-653-036	Sp2Thick:PaperSizeEnvCorr:BW	Wide Roller:PaperTransfer:2Side:S4	ENG	[1 to 110 / 75 / 1/step]
2-653-039	Sp2Thick:PaperSizeEnvCorr:BW	Wide Roller:PaperTransfer:1Side:S5	ENG	[1 to 110 / 72 / 1/step]
2-653-040	Sp2Thick:PaperSizeEnvCorr:BW	Wide Roller:PaperTransfer:2Side:S5	ENG	[1 to 110 / 76 / 1/step]
2-654-003	Sp2Thick:PaperSizeEnvCorr:FC	PaperTransfer:1Side:S1	ENG	[1 to 110 / 77 / 1/step]
2-654-004	Sp2Thick:PaperSizeEnvCorr:FC	PaperTransfer:2Side:S1	ENG	[1 to 110 / 80 / 1/step]
2-654-007	Sp2Thick:PaperSizeEnvCorr:FC	PaperTransfer:1Side:S2	ENG	[1 to 110 / 78 / 1/step]
2-654-008	Sp2Thick:PaperSizeEnvCorr:FC	PaperTransfer:2Side:S2	ENG	[1 to 110 / 81 / 1/step]
2-654-011	Sp2Thick:PaperSizeEnvCorr:FC	PaperTransfer:1Side:S3	ENG	[1 to 110 / 79 / 1/step]
2-654-012	Sp2Thick:PaperSizeEnvCorr:FC	PaperTransfer:2Side:S3	ENG	[1 to 110 / 82 / 1/step]

3.SP Mode Tables

SP No.	Large Category	Small Category	ENG or CTL	[Min to Max/Init./Step]
2-654-015	Sp2Thick:PaperSizeEnvCorr:F C	PaperTransfer:1Side:S4	ENG	[1 to 110 / 79 / 1/step]
2-654-016	Sp2Thick:PaperSizeEnvCorr:F C	PaperTransfer:2Side:S4	ENG	[1 to 110 / 83 / 1/step]
2-654-019	Sp2Thick:PaperSizeEnvCorr:F C	PaperTransfer:1Side:S5	ENG	[1 to 110 / 79 / 1/step]
2-654-020	Sp2Thick:PaperSizeEnvCorr:F C	PaperTransfer:2Side:S5	ENG	[1 to 110 / 84 / 1/step]
2-654-023	Sp2Thick:PaperSizeEnvCorr:F C	Wide Roller:PaperTransfer:1Side:S1	ENG	[1 to 110 / 77 / 1/step]
2-654-024	Sp2Thick:PaperSizeEnvCorr:F C	Wide Roller:PaperTransfer:2Side:S1	ENG	[1 to 110 / 80 / 1/step]
2-654-027	Sp2Thick:PaperSizeEnvCorr:F C	Wide Roller:PaperTransfer:1Side:S2	ENG	[1 to 110 / 78 / 1/step]
2-654-028	Sp2Thick:PaperSizeEnvCorr:F C	Wide Roller:PaperTransfer:2Side:S2	ENG	[1 to 110 / 81 / 1/step]
2-654-031	Sp2Thick:PaperSizeEnvCorr:F C	Wide Roller:PaperTransfer:1Side:S3	ENG	[1 to 110 / 79 / 1/step]

3.SP Mode Tables

SP No.	Large Category	Small Category	ENG or CTL	[Min to Max/Init./Step]
2-654-032	Sp2Thick:PaperSizeEnvCorr:FC	Wide Roller:PaperTransfer:2Side:S3	ENG	[1 to 110 / 82 / 1/step]
2-654-035	Sp2Thick:PaperSizeEnvCorr:FC	Wide Roller:PaperTransfer:1Side:S4	ENG	[1 to 110 / 79 / 1/step]
2-654-036	Sp2Thick:PaperSizeEnvCorr:FC	Wide Roller:PaperTransfer:2Side:S4	ENG	[1 to 110 / 83 / 1/step]
2-654-039	Sp2Thick:PaperSizeEnvCorr:FC	Wide Roller:PaperTransfer:1Side:S5	ENG	[1 to 110 / 79 / 1/step]
2-654-040	Sp2Thick:PaperSizeEnvCorr:FC	Wide Roller:PaperTransfer:2Side:S5	ENG	[1 to 110 / 84 / 1/step]
2-655-003	Sp2Thick:LeadingEdgeCorrection	Paper Transfer:1side	ENG	[0 to 995 / 100 / 5%/step]
2-655-004	Sp2Thick:LeadingEdgeCorrection	Paper Transfer:2side	ENG	[0 to 995 / 100 / 5%/step]
2-656-003	Sp2Thick:SwitchTimingLeadEdge	Paper Transfer:1side	ENG	[0 to 50 / 0 / 2mm/step]
2-656-004	Sp2Thick:SwitchTimingLeadEdge	Paper Transfer:2side	ENG	[0 to 50 / 0 / 2mm/step]

3.SP Mode Tables

SP No.	Large Category	Small Category	ENG or CTL	[Min to Max/Init./Step]
2-657-003	Sp2Thick:TrailEdgeCorrection	Paper Transfer:1side	ENG	[0 to 995 / 100 / 5%/step]
2-657-004	Sp2Thick:TrailEdgeCorrection	Paper Transfer:2side	ENG	[0 to 995 / 100 / 5%/step]
2-658-003	Sp2Thick:SwitchTimingTrailEdge	Paper Transfer:1side	ENG	[0 to 50 / 0 / 2mm/step]
2-658-004	Sp2Thick:SwitchTimingTrailEdge	Paper Transfer:2side	ENG	[0 to 50 / 0 / 2mm/step]
2-663-003	Special3 Thick:Bias:BW	PaperTransfer:1side	ENG	IM C6000: [0 to 250 / 11 / 1-uA/step] IM C5500: [0 to 250 / 11 / 1-uA/step] IM C4500: [0 to 250 / 11 / 1-uA/step]
2-663-004	Special3 Thick:Bias:BW	PaperTransfer:2side	ENG	IM C6000: [0 to 250 / 15 / 1-uA/step] IM C5500: [0 to 250 / 15 / 1-uA/step] IM C4500: [0 to 250 / 15 / 1-uA/step]
2-667	Special3 Thick:Bias:FC	PaperTransfer:1side	ENG	IM C6000: [0 to 250 / 19

3.SP Mode Tables

SP No.	Large Category	Small Category	ENG or CTL	[Min to Max/Init./Step]
-003				/ 1-uA/step] IM C5500: [0 to 250 / 19 / 1-uA/step] IM C4500: [0 to 250 / 19 / 1-uA/step]
2-667-004	Special3 Thick:Bias:FC	PaperTransfer:2side	ENG	IM C6000: [0 to 250 / 21 / 1-uA/step] IM C5500: [0 to 250 / 21 / 1-uA/step] IM C4500: [0 to 250 / 21 / 1-uA/step]
2-671-003	Special3Thick:PaperSizeCorr:BW	PaperTransfer:1Side:S1	ENG	[100 to 995 / 100 / 5%/step]
2-671-004	Special3Thick:PaperSizeCorr:BW	PaperTransfer:2Side:S1	ENG	[100 to 995 / 100 / 5%/step]
2-671-007	Special3Thick:PaperSizeCorr:BW	PaperTransfer:1Side:S2	ENG	[100 to 995 / 100 / 5%/step]
2-671-008	Special3Thick:PaperSizeCorr:BW	PaperTransfer:2Side:S2	ENG	[100 to 995 / 133 / 5%/step]
2-671-011	Special3Thick:PaperSizeCorr:BW	PaperTransfer:1Side:S3	ENG	[100 to 995 / 100 / 5%/step]

3.SP Mode Tables

SP No.	Large Category	Small Category	ENG or CTL	[Min to Max/Init./Step]
2-671-012	Special3Thick:PaperSizeCorr:BW	PaperTransfer:2Side:S3	ENG	[100 to 995 / 167 / 5%/step]
2-671-015	Special3Thick:PaperSizeCorr:BW	PaperTransfer:1Side:S4	ENG	[100 to 995 / 100 / 5%/step]
2-671-016	Special3Thick:PaperSizeCorr:BW	PaperTransfer:2Side:S4	ENG	[100 to 995 / 233 / 5%/step]
2-671-019	Special3Thick:PaperSizeCorr:BW	PaperTransfer:1Side:S5	ENG	[100 to 995 / 100 / 5%/step]
2-671-020	Special3Thick:PaperSizeCorr:BW	PaperTransfer:2Side:S5	ENG	[100 to 995 / 267 / 5%/step]
2-671-023	Special3Thick:PaperSizeCorr:BW	Wide Roller:PaperTransfer:1Side:S1	ENG	[100 to 995 / 100 / 5%/step]
2-671-024	Special3Thick:PaperSizeCorr:BW	Wide Roller:PaperTransfer:2Side:S1	ENG	[100 to 995 / 100 / 5%/step]
2-671-027	Special3Thick:PaperSizeCorr:BW	Wide Roller:PaperTransfer:1Side:S2	ENG	[100 to 995 / 100 / 5%/step]
2-671-028	Special3Thick:PaperSizeCorr:BW	Wide Roller:PaperTransfer:2Side:S2	ENG	[100 to 995 / 133 / 5%/step]

3.SP Mode Tables

SP No.	Large Category	Small Category	ENG or CTL	[Min to Max/Init./Step]
2-671-031	Special3Thick:PaperSizeCorr:BW	Wide Roller:PaperTransfer:1Side:S3	ENG	[100 to 995 / 100 / 5%/step]
2-671-032	Special3Thick:PaperSizeCorr:BW	Wide Roller:PaperTransfer:2Side:S3	ENG	[100 to 995 / 167 / 5%/step]
2-671-035	Special3Thick:PaperSizeCorr:BW	Wide Roller:PaperTransfer:1Side:S4	ENG	[100 to 995 / 100 / 5%/step]
2-671-036	Special3Thick:PaperSizeCorr:BW	Wide Roller:PaperTransfer:2Side:S4	ENG	[100 to 995 / 233 / 5%/step]
2-671-039	Special3Thick:PaperSizeCorr:BW	Wide Roller:PaperTransfer:1Side:S5	ENG	[100 to 995 / 100 / 5%/step]
2-671-040	Special3Thick:PaperSizeCorr:BW	Wide Roller:PaperTransfer:2Side:S5	ENG	[100 to 995 / 267 / 5%/step]
2-672-003	Special3Thick:PaperSizeCorr:FC	PaperTransfer:1Side:S1	ENG	[100 to 995 / 100 / 5%/step]
2-672-004	Special3Thick:PaperSizeCorr:FC	PaperTransfer:2Side:S1	ENG	[100 to 995 / 100 / 5%/step]
2-672-007	Special3Thick:PaperSizeCorr:FC	PaperTransfer:1Side:S2	ENG	[100 to 995 / 100 / 5%/step]

3.SP Mode Tables

SP No.	Large Category	Small Category	ENG or CTL	[Min to Max/Init./Step]
2-672-008	Special3Thick:PaperSizeCorr:F C	PaperTransfer:2Side:S2	ENG	[100 to 995 / 181 / 5%/step]
2-672-011	Special3Thick:PaperSizeCorr:F C	PaperTransfer:1Side:S3	ENG	[100 to 995 / 100 / 5%/step]
2-672-012	Special3Thick:PaperSizeCorr:F C	PaperTransfer:2Side:S3	ENG	[100 to 995 / 229 / 5%/step]
2-672-015	Special3Thick:PaperSizeCorr:F C	PaperTransfer:1Side:S4	ENG	[100 to 995 / 100 / 5%/step]
2-672-016	Special3Thick:PaperSizeCorr:F C	PaperTransfer:2Side:S4	ENG	[100 to 995 / 286 / 5%/step]
2-672-019	Special3Thick:PaperSizeCorr:F C	PaperTransfer:1Side:S5	ENG	[100 to 995 / 100 / 5%/step]
2-672-020	Special3Thick:PaperSizeCorr:F C	PaperTransfer:2Side:S5	ENG	[100 to 995 / 381 / 5%/step]
2-672-023	Special3Thick:PaperSizeCorr:F C	Wide Roller:PaperTransfer:1Side:S1	ENG	[100 to 995 / 100 / 5%/step]
2-672-024	Special3Thick:PaperSizeCorr:F C	Wide Roller:PaperTransfer:2Side:S1	ENG	[100 to 995 / 100 / 5%/step]

3.SP Mode Tables

SP No.	Large Category	Small Category	ENG or CTL	[Min to Max/Init./Step]
2-672-027	Special3Thick:PaperSizeCorr:F C	Wide Roller:PaperTransfer:1Side:S2	ENG	[100 to 995 / 100 / 5%/step]
2-672-028	Special3Thick:PaperSizeCorr:F C	Wide Roller:PaperTransfer:2Side:S2	ENG	[100 to 995 / 181 / 5%/step]
2-672-031	Special3Thick:PaperSizeCorr:F C	Wide Roller:PaperTransfer:1Side:S3	ENG	[100 to 995 / 100 / 5%/step]
2-672-032	Special3Thick:PaperSizeCorr:F C	Wide Roller:PaperTransfer:2Side:S3	ENG	[100 to 995 / 229 / 5%/step]
2-672-035	Special3Thick:PaperSizeCorr:F C	Wide Roller:PaperTransfer:1Side:S4	ENG	[100 to 995 / 100 / 5%/step]
2-672-036	Special3Thick:PaperSizeCorr:F C	Wide Roller:PaperTransfer:2Side:S4	ENG	[100 to 995 / 286 / 5%/step]
2-672-039	Special3Thick:PaperSizeCorr:F C	Wide Roller:PaperTransfer:1Side:S5	ENG	[100 to 995 / 100 / 5%/step]
2-672-040	Special3Thick:PaperSizeCorr:F C	Wide Roller:PaperTransfer:2Side:S5	ENG	[100 to 995 / 381 / 5%/step]
2-673-003	Sp3Thick:PaperSizeEnvCorr:B W	PaperTransfer:1Side:S1	ENG	[1 to 110 / 70 / 1/step]

3.SP Mode Tables

SP No.	Large Category	Small Category	ENG or CTL	[Min to Max/Init./Step]
2-673-004	Sp3Thick:PaperSizeEnvCorr:BW	PaperTransfer:2Side:S1	ENG	[1 to 110 / 72 / 1/step]
2-673-007	Sp3Thick:PaperSizeEnvCorr:BW	PaperTransfer:1Side:S2	ENG	[1 to 110 / 71 / 1/step]
2-673-008	Sp3Thick:PaperSizeEnvCorr:BW	PaperTransfer:2Side:S2	ENG	[1 to 110 / 73 / 1/step]
2-673-011	Sp3Thick:PaperSizeEnvCorr:BW	PaperTransfer:1Side:S3	ENG	[1 to 110 / 72 / 1/step]
2-673-012	Sp3Thick:PaperSizeEnvCorr:BW	PaperTransfer:2Side:S3	ENG	[1 to 110 / 74 / 1/step]
2-673-015	Sp3Thick:PaperSizeEnvCorr:BW	PaperTransfer:1Side:S4	ENG	[1 to 110 / 72 / 1/step]
2-673-016	Sp3Thick:PaperSizeEnvCorr:BW	PaperTransfer:2Side:S4	ENG	[1 to 110 / 75 / 1/step]
2-673-019	Sp3Thick:PaperSizeEnvCorr:BW	PaperTransfer:1Side:S5	ENG	[1 to 110 / 72 / 1/step]
2-673-020	Sp3Thick:PaperSizeEnvCorr:BW	PaperTransfer:2Side:S5	ENG	[1 to 110 / 76 / 1/step]

3.SP Mode Tables

SP No.	Large Category	Small Category	ENG or CTL	[Min to Max/Init./Step]
2-673-023	Sp3Thick:PaperSizeEnvCorr:BW	Wide Roller:PaperTransfer:1Side:S1	ENG	[1 to 110 / 70 / 1/step]
2-673-024	Sp3Thick:PaperSizeEnvCorr:BW	Wide Roller:PaperTransfer:2Side:S1	ENG	[1 to 110 / 72 / 1/step]
2-673-027	Sp3Thick:PaperSizeEnvCorr:BW	Wide Roller:PaperTransfer:1Side:S2	ENG	[1 to 110 / 71 / 1/step]
2-673-028	Sp3Thick:PaperSizeEnvCorr:BW	Wide Roller:PaperTransfer:2Side:S2	ENG	[1 to 110 / 73 / 1/step]
2-673-031	Sp3Thick:PaperSizeEnvCorr:BW	Wide Roller:PaperTransfer:1Side:S3	ENG	[1 to 110 / 72 / 1/step]
2-673-032	Sp3Thick:PaperSizeEnvCorr:BW	Wide Roller:PaperTransfer:2Side:S3	ENG	[1 to 110 / 74 / 1/step]
2-673-035	Sp3Thick:PaperSizeEnvCorr:BW	Wide Roller:PaperTransfer:1Side:S4	ENG	[1 to 110 / 72 / 1/step]
2-673-036	Sp3Thick:PaperSizeEnvCorr:BW	Wide Roller:PaperTransfer:2Side:S4	ENG	[1 to 110 / 75 / 1/step]
2-673-039	Sp3Thick:PaperSizeEnvCorr:BW	Wide Roller:PaperTransfer:1Side:S5	ENG	[1 to 110 / 72 / 1/step]

3.SP Mode Tables

SP No.	Large Category	Small Category	ENG or CTL	[Min to Max/Init./Step]
2-673-040	Sp3Thick:PaperSizeEnvCorr:BW	Wide Roller:PaperTransfer:2Side:S5	ENG	[1 to 110 / 76 / 1/step]
2-674-003	Sp3Thick:PaperSizeEnvCorr:FC	PaperTransfer:1Side:S1	ENG	[1 to 110 / 77 / 1/step]
2-674-004	Sp3Thick:PaperSizeEnvCorr:FC	PaperTransfer:2Side:S1	ENG	[1 to 110 / 80 / 1/step]
2-674-007	Sp3Thick:PaperSizeEnvCorr:FC	PaperTransfer:1Side:S2	ENG	[1 to 110 / 78 / 1/step]
2-674-008	Sp3Thick:PaperSizeEnvCorr:FC	PaperTransfer:2Side:S2	ENG	[1 to 110 / 81 / 1/step]
2-674-011	Sp3Thick:PaperSizeEnvCorr:FC	PaperTransfer:1Side:S3	ENG	[1 to 110 / 79 / 1/step]
2-674-012	Sp3Thick:PaperSizeEnvCorr:FC	PaperTransfer:2Side:S3	ENG	[1 to 110 / 82 / 1/step]
2-674-015	Sp3Thick:PaperSizeEnvCorr:FC	PaperTransfer:1Side:S4	ENG	[1 to 110 / 79 / 1/step]
2-674-016	Sp3Thick:PaperSizeEnvCorr:FC	PaperTransfer:2Side:S4	ENG	[1 to 110 / 83 / 1/step]

3.SP Mode Tables

SP No.	Large Category	Small Category	ENG or CTL	[Min to Max/Init./Step]
2-674-019	Sp3Thick:PaperSizeEnvCorr:F C	PaperTransfer:1Side:S5	ENG	[1 to 110 / 79 / 1/step]
2-674-020	Sp3Thick:PaperSizeEnvCorr:F C	PaperTransfer:2Side:S5	ENG	[1 to 110 / 84 / 1/step]
2-674-023	Sp3Thick:PaperSizeEnvCorr:F C	Wide Roller:PaperTransfer:1Side:S1	ENG	[1 to 110 / 77 / 1/step]
2-674-024	Sp3Thick:PaperSizeEnvCorr:F C	Wide Roller:PaperTransfer:2Side:S1	ENG	[1 to 110 / 80 / 1/step]
2-674-027	Sp3Thick:PaperSizeEnvCorr:F C	Wide Roller:PaperTransfer:1Side:S2	ENG	[1 to 110 / 78 / 1/step]
2-674-028	Sp3Thick:PaperSizeEnvCorr:F C	Wide Roller:PaperTransfer:2Side:S2	ENG	[1 to 110 / 81 / 1/step]
2-674-031	Sp3Thick:PaperSizeEnvCorr:F C	Wide Roller:PaperTransfer:1Side:S3	ENG	[1 to 110 / 79 / 1/step]
2-674-032	Sp3Thick:PaperSizeEnvCorr:F C	Wide Roller:PaperTransfer:2Side:S3	ENG	[1 to 110 / 82 / 1/step]
2-674-035	Sp3Thick:PaperSizeEnvCorr:F C	Wide Roller:PaperTransfer:1Side:S4	ENG	[1 to 110 / 79 / 1/step]

3.SP Mode Tables

SP No.	Large Category	Small Category	ENG or CTL	[Min to Max/Init./Step]
2-674-036	Sp3Thick:PaperSizeEnvCorr:FC	Wide Roller:PaperTransfer:2Side:S4	ENG	[1 to 110 / 83 / 1/step]
2-674-039	Sp3Thick:PaperSizeEnvCorr:FC	Wide Roller:PaperTransfer:1Side:S5	ENG	[1 to 110 / 79 / 1/step]
2-674-040	Sp3Thick:PaperSizeEnvCorr:FC	Wide Roller:PaperTransfer:2Side:S5	ENG	[1 to 110 / 84 / 1/step]
2-675-003	Sp3Thick:LeadingEdgeCorrection	Paper Transfer:1side	ENG	[0 to 995 / 100 / 5%/step]
2-675-004	Sp3Thick:LeadingEdgeCorrection	Paper Transfer:2side	ENG	[0 to 995 / 100 / 5%/step]
2-676-003	Sp3Thick:SwitchTimingLeadEdge	Paper Transfer:1side	ENG	[0 to 50 / 0 / 2mm/step]
2-676-004	Sp3Thick:SwitchTimingLeadEdge	Paper Transfer:2side	ENG	[0 to 50 / 0 / 2mm/step]
2-677-003	Sp3Thick:TrailEdgeCorrection	Paper Transfer:1side	ENG	[0 to 995 / 100 / 5%/step]
2-677-004	Sp3Thick:TrailEdgeCorrection	Paper Transfer:2side	ENG	[0 to 995 / 100 / 5%/step]

3.SP Mode Tables

SP No.	Large Category	Small Category	ENG or CTL	[Min to Max/Init./Step]
2-678-003	Sp3Thick:SwitchTimingTrailEdge	Paper Transfer:1side	ENG	[0 to 50 / 0 / 2mm/step]
2-678-004	Sp3Thick:SwitchTimingTrailEdge	Paper Transfer:2side	ENG	[0 to 50 / 0 / 2mm/step]
2-690-001	ITB Contact Setting	Thick1	ENG	[0 to 1 / 0 / 1/step]
2-690-002	ITB Contact Setting	Thick2	ENG	[0 to 1 / 0 / 1/step]
2-690-003	ITB Contact Setting	Thick3	ENG	[0 to 1 / 0 / 1/step]
2-690-004	ITB Contact Setting	Thick4	ENG	[0 to 1 / 0 / 1/step]
2-690-014	ITB Contact Setting	Special1Thick1234	ENG	[0 to 1 / 0 / 1/step]
2-690-015	ITB Contact Setting	Special2Thick1234	ENG	[0 to 1 / 0 / 1/step]
2-690-016	ITB Contact Setting	Special3Thick1234	ENG	[0 to 1 / 0 / 1/step]

3.SP Mode Tables

SP No.	Large Category	Small Category	ENG or CTL	[Min to Max/Init./Step]
2-703-003	Thick4:Bias:BW	PaperTransfer:1side	ENG	IM C6000: [0 to 250 / 11 / 1-uA/step] IM C5500: [0 to 250 / 11 / 1-uA/step] IM C4500: [0 to 250 / 11 / 1-uA/step]
2-703-004	Thick4:Bias:BW	PaperTransfer:2side	ENG	IM C6000: [0 to 250 / 15 / 1-uA/step] IM C5500: [0 to 250 / 15 / 1-uA/step] IM C4500: [0 to 250 / 15 / 1-uA/step]
2-707-003	Thick4:Bias:FC	PaperTransfer:1side	ENG	IM C6000: [0 to 250 / 19 / 1-uA/step] IM C5500: [0 to 250 / 19 / 1-uA/step] IM C4500: [0 to 250 / 19 / 1-uA/step]
2-707-004	Thick4:Bias:FC	PaperTransfer:2side	ENG	IM C6000: [0 to 250 / 21 / 1-uA/step] IM C5500: [0 to 250 / 21 / 1-uA/step] IM C4500: [0 to 250 / 21 / 1-uA/step]

3.SP Mode Tables

SP No.	Large Category	Small Category	ENG or CTL	[Min to Max/Init./Step]
2-711-003	Thick4:SizeCorrection:BW	PaperTransfer:1Side:S1	ENG	[100 to 995 / 100 / 1%/step]
2-711-004	Thick4:SizeCorrection:BW	PaperTransfer:2Side:S1	ENG	[100 to 995 / 100 / 1%/step]
2-711-007	Thick4:SizeCorrection:BW	PaperTransfer:1Side:S2	ENG	[100 to 995 / 100 / 1%/step]
2-711-008	Thick4:SizeCorrection:BW	PaperTransfer:2Side:S2	ENG	[100 to 995 / 133 / 1%/step]
2-711-011	Thick4:SizeCorrection:BW	PaperTransfer:1Side:S3	ENG	[100 to 995 / 100 / 1%/step]
2-711-012	Thick4:SizeCorrection:BW	PaperTransfer:2Side:S3	ENG	[100 to 995 / 167 / 1%/step]
2-711-015	Thick4:SizeCorrection:BW	PaperTransfer:1Side:S4	ENG	[100 to 995 / 100 / 1%/step]
2-711-016	Thick4:SizeCorrection:BW	PaperTransfer:2Side:S4	ENG	[100 to 995 / 233 / 1%/step]
2-711-019	Thick4:SizeCorrection:BW	PaperTransfer:1Side:S5	ENG	[100 to 995 / 100 / 1%/step]

3.SP Mode Tables

SP No.	Large Category	Small Category	ENG or CTL	[Min to Max/Init./Step]
2-711-020	Thick4:SizeCorrection:BW	PaperTransfer:2Side:S5	ENG	[100 to 995 / 267 / 1%/step]
2-711-023	Thick4:SizeCorrection:BW	Wide Roller:PaperTransfer:1Side:S1	ENG	[100 to 995 / 100 / 1%/step]
2-711-024	Thick4:SizeCorrection:BW	Wide Roller:PaperTransfer:2Side:S1	ENG	[100 to 995 / 100 / 1%/step]
2-711-027	Thick4:SizeCorrection:BW	Wide Roller:PaperTransfer:1Side:S2	ENG	[100 to 995 / 100 / 1%/step]
2-711-028	Thick4:SizeCorrection:BW	Wide Roller:PaperTransfer:2Side:S2	ENG	[100 to 995 / 133 / 1%/step]
2-711-031	Thick4:SizeCorrection:BW	Wide Roller:PaperTransfer:1Side:S3	ENG	[100 to 995 / 100 / 1%/step]
2-711-032	Thick4:SizeCorrection:BW	Wide Roller:PaperTransfer:2Side:S3	ENG	[100 to 995 / 167 / 1%/step]
2-711-035	Thick4:SizeCorrection:BW	Wide Roller:PaperTransfer:1Side:S4	ENG	[100 to 995 / 100 / 1%/step]
2-711-036	Thick4:SizeCorrection:BW	Wide Roller:PaperTransfer:2Side:S4	ENG	[100 to 995 / 233 / 1%/step]

3.SP Mode Tables

SP No.	Large Category	Small Category	ENG or CTL	[Min to Max/Init./Step]
2-711-039	Thick4:SizeCorrection:BW	Wide Roller:PaperTransfer:1Side:S5	ENG	[100 to 995 / 100 / 1%/step]
2-711-040	Thick4:SizeCorrection:BW	Wide Roller:PaperTransfer:2Side:S5	ENG	[100 to 995 / 267 / 1%/step]
2-712-003	Thick4:SizeCorrection:FC	PaperTransfer:1Side:S1	ENG	[100 to 995 / 100 / 1%/step]
2-712-004	Thick4:SizeCorrection:FC	PaperTransfer:2Side:S1	ENG	[100 to 995 / 100 / 1%/step]
2-712-007	Thick4:SizeCorrection:FC	PaperTransfer:1Side:S2	ENG	[100 to 995 / 100 / 1%/step]
2-712-008	Thick4:SizeCorrection:FC	PaperTransfer:2Side:S2	ENG	[100 to 995 / 181 / 1%/step]
2-712-011	Thick4:SizeCorrection:FC	PaperTransfer:1Side:S3	ENG	[100 to 995 / 100 / 1%/step]
2-712-012	Thick4:SizeCorrection:FC	PaperTransfer:2Side:S3	ENG	[100 to 995 / 229 / 1%/step]
2-712-015	Thick4:SizeCorrection:FC	PaperTransfer:1Side:S4	ENG	[100 to 995 / 100 / 1%/step]

3.SP Mode Tables

SP No.	Large Category	Small Category	ENG or CTL	[Min to Max/Init./Step]
2-712-016	Thick4:SizeCorrection:FC	PaperTransfer:2Side:S4	ENG	[100 to 995 / 286 / 1%/step]
2-712-019	Thick4:SizeCorrection:FC	PaperTransfer:1Side:S5	ENG	[100 to 995 / 100 / 1%/step]
2-712-020	Thick4:SizeCorrection:FC	PaperTransfer:2Side:S5	ENG	[100 to 995 / 381 / 1%/step]
2-712-023	Thick4:SizeCorrection:FC	Wide Roller:PaperTransfer:1Side:S1	ENG	[100 to 995 / 100 / 1%/step]
2-712-024	Thick4:SizeCorrection:FC	Wide Roller:PaperTransfer:2Side:S1	ENG	[100 to 995 / 100 / 1%/step]
2-712-027	Thick4:SizeCorrection:FC	Wide Roller:PaperTransfer:1Side:S2	ENG	[100 to 995 / 100 / 1%/step]
2-712-028	Thick4:SizeCorrection:FC	Wide Roller:PaperTransfer:2Side:S2	ENG	[100 to 995 / 181 / 1%/step]
2-712-031	Thick4:SizeCorrection:FC	Wide Roller:PaperTransfer:1Side:S3	ENG	[100 to 995 / 100 / 1%/step]
2-712-032	Thick4:SizeCorrection:FC	Wide Roller:PaperTransfer:2Side:S3	ENG	[100 to 995 / 229 / 1%/step]

3.SP Mode Tables

SP No.	Large Category	Small Category	ENG or CTL	[Min to Max/Init./Step]
2-712-035	Thick4:SizeCorrection:FC	Wide Roller:PaperTransfer:1Side:S4	ENG	[100 to 995 / 100 / 1%/step]
2-712-036	Thick4:SizeCorrection:FC	Wide Roller:PaperTransfer:2Side:S4	ENG	[100 to 995 / 286 / 1%/step]
2-712-039	Thick4:SizeCorrection:FC	Wide Roller:PaperTransfer:1Side:S5	ENG	[100 to 995 / 100 / 1%/step]
2-712-040	Thick4:SizeCorrection:FC	Wide Roller:PaperTransfer:2Side:S5	ENG	[100 to 995 / 381 / 1%/step]
2-713-003	Thick4:Size-Env.Correct:BW	PaperTransfer:1Side:S1	ENG	[1 to 110 / 70 / 1/step]
2-713-004	Thick4:Size-Env.Correct:BW	PaperTransfer:2Side:S1	ENG	[1 to 110 / 72 / 1/step]
2-713-007	Thick4:Size-Env.Correct:BW	PaperTransfer:1Side:S2	ENG	[1 to 110 / 71 / 1/step]
2-713-008	Thick4:Size-Env.Correct:BW	PaperTransfer:2Side:S2	ENG	[1 to 110 / 73 / 1/step]
2-713-011	Thick4:Size-Env.Correct:BW	PaperTransfer:1Side:S3	ENG	[1 to 110 / 72 / 1/step]

3.SP Mode Tables

SP No.	Large Category	Small Category	ENG or CTL	[Min to Max/Init./Step]
2-713-012	Thick4:Size-Env.Correct:BW	PaperTransfer:2Side:S3	ENG	[1 to 110 / 74 / 1/step]
2-713-015	Thick4:Size-Env.Correct:BW	PaperTransfer:1Side:S4	ENG	[1 to 110 / 72 / 1/step]
2-713-016	Thick4:Size-Env.Correct:BW	PaperTransfer:2Side:S4	ENG	[1 to 110 / 75 / 1/step]
2-713-019	Thick4:Size-Env.Correct:BW	PaperTransfer:1Side:S5	ENG	[1 to 110 / 72 / 1/step]
2-713-020	Thick4:Size-Env.Correct:BW	PaperTransfer:2Side:S5	ENG	[1 to 110 / 76 / 1/step]
2-713-023	Thick4:Size-Env.Correct:BW	Wide Roller:PaperTransfer:1Side:S1	ENG	[1 to 110 / 70 / 1/step]
2-713-024	Thick4:Size-Env.Correct:BW	Wide Roller:PaperTransfer:2Side:S1	ENG	[1 to 110 / 72 / 1/step]
2-713-027	Thick4:Size-Env.Correct:BW	Wide Roller:PaperTransfer:1Side:S2	ENG	[1 to 110 / 71 / 1/step]
2-713-028	Thick4:Size-Env.Correct:BW	Wide Roller:PaperTransfer:2Side:S2	ENG	[1 to 110 / 73 / 1/step]

3.SP Mode Tables

SP No.	Large Category	Small Category	ENG or CTL	[Min to Max/Init./Step]
2-713-031	Thick4:Size-Env.Correct:BW	Wide Roller:PaperTransfer:1Side:S3	ENG	[1 to 110 / 72 / 1/step]
2-713-032	Thick4:Size-Env.Correct:BW	Wide Roller:PaperTransfer:2Side:S3	ENG	[1 to 110 / 74 / 1/step]
2-713-035	Thick4:Size-Env.Correct:BW	Wide Roller:PaperTransfer:1Side:S4	ENG	[1 to 110 / 72 / 1/step]
2-713-036	Thick4:Size-Env.Correct:BW	Wide Roller:PaperTransfer:2Side:S4	ENG	[1 to 110 / 75 / 1/step]
2-713-039	Thick4:Size-Env.Correct:BW	Wide Roller:PaperTransfer:1Side:S5	ENG	[1 to 110 / 72 / 1/step]
2-713-040	Thick4:Size-Env.Correct:BW	Wide Roller:PaperTransfer:2Side:S5	ENG	[1 to 110 / 76 / 1/step]
2-714-003	Thick4:Size-Env.Correct:FC	PaperTransfer:1Side:S1	ENG	[1 to 110 / 77 / 1/step]
2-714-004	Thick4:Size-Env.Correct:FC	PaperTransfer:2Side:S1	ENG	[1 to 110 / 80 / 1/step]
2-714-007	Thick4:Size-Env.Correct:FC	PaperTransfer:1Side:S2	ENG	[1 to 110 / 78 / 1/step]

3.SP Mode Tables

SP No.	Large Category	Small Category	ENG or CTL	[Min to Max/Init./Step]
2-714-008	Thick4:Size-Env.Correct:FC	PaperTransfer:2Side:S2	ENG	[1 to 110 / 81 / 1/step]
2-714-011	Thick4:Size-Env.Correct:FC	PaperTransfer:1Side:S3	ENG	[1 to 110 / 79 / 1/step]
2-714-012	Thick4:Size-Env.Correct:FC	PaperTransfer:2Side:S3	ENG	[1 to 110 / 82 / 1/step]
2-714-015	Thick4:Size-Env.Correct:FC	PaperTransfer:1Side:S4	ENG	[1 to 110 / 79 / 1/step]
2-714-016	Thick4:Size-Env.Correct:FC	PaperTransfer:2Side:S4	ENG	[1 to 110 / 83 / 1/step]
2-714-019	Thick4:Size-Env.Correct:FC	PaperTransfer:1Side:S5	ENG	[1 to 110 / 79 / 1/step]
2-714-020	Thick4:Size-Env.Correct:FC	PaperTransfer:2Side:S5	ENG	[1 to 110 / 84 / 1/step]
2-714-023	Thick4:Size-Env.Correct:FC	Wide Roller:PaperTransfer:1Side:S1	ENG	[1 to 110 / 77 / 1/step]
2-714-024	Thick4:Size-Env.Correct:FC	Wide Roller:PaperTransfer:2Side:S1	ENG	[1 to 110 / 80 / 1/step]

3.SP Mode Tables

SP No.	Large Category	Small Category	ENG or CTL	[Min to Max/Init./Step]
2-714-027	Thick4:Size-Env.Correct:FC	Wide Roller:PaperTransfer:1Side:S2	ENG	[1 to 110 / 78 / 1/step]
2-714-028	Thick4:Size-Env.Correct:FC	Wide Roller:PaperTransfer:2Side:S2	ENG	[1 to 110 / 81 / 1/step]
2-714-031	Thick4:Size-Env.Correct:FC	Wide Roller:PaperTransfer:1Side:S3	ENG	[1 to 110 / 79 / 1/step]
2-714-032	Thick4:Size-Env.Correct:FC	Wide Roller:PaperTransfer:2Side:S3	ENG	[1 to 110 / 82 / 1/step]
2-714-035	Thick4:Size-Env.Correct:FC	Wide Roller:PaperTransfer:1Side:S4	ENG	[1 to 110 / 79 / 1/step]
2-714-036	Thick4:Size-Env.Correct:FC	Wide Roller:PaperTransfer:2Side:S4	ENG	[1 to 110 / 83 / 1/step]
2-714-039	Thick4:Size-Env.Correct:FC	Wide Roller:PaperTransfer:1Side:S5	ENG	[1 to 110 / 79 / 1/step]
2-714-040	Thick4:Size-Env.Correct:FC	Wide Roller:PaperTransfer:2Side:S5	ENG	[1 to 110 / 84 / 1/step]
2-715-003	Thick4:LeadingEdgeCorrection	Paper Transfer:1side	ENG	[0 to 995 / 100 / 5%/step]

3.SP Mode Tables

SP No.	Large Category	Small Category	ENG or CTL	[Min to Max/Init./Step]
2-715-004	Thick4:LeadingEdgeCorrection	Paper Transfer:2side	ENG	[0 to 995 / 100 / 5%/step]
2-716-003	Thick4:SwitchTimingLeadEdge	Paper Transfer:1side	ENG	[0 to 50 / 0 / 2mm/step]
2-716-004	Thick4:SwitchTimingLeadEdge	Paper Transfer:2side	ENG	[0 to 50 / 0 / 2mm/step]
2-717-003	Thick4:TrailEdgeCorrection	Paper Transfer:1side	ENG	[0 to 995 / 100 / 5%/step]
2-717-004	Thick4:TrailEdgeCorrection	Paper Transfer:2side	ENG	[0 to 995 / 100 / 5%/step]
2-718-003	Thick4:SwitchTimingTrailEdge	Paper Transfer:1side	ENG	[0 to 50 / 0 / 2mm/step]
2-718-004	Thick4:SwitchTimingTrailEdge	Paper Transfer:2side	ENG	[0 to 50 / 0 / 2mm/step]
2-901-001	OPC Drum Brake Time	All	ENG *	[50 to 240000 / 50 / 10msec/step]
2-902-001	OPC Drum Reverse Time	All: BW	ENG *	[0 to 200 / 40 / 10msec/step]

3.SP Mode Tables

SP No.	Large Category	Small Category	ENG or CTL	[Min to Max/Init./Step]
2-902-002	OPC Drum Reverse Time	All: FC	ENG *	[0 to 200 / 40 / 10msec/step]
2-903-003	Image Transfer Brake Time	All	ENG *	[50 to 240000 / 50 / 10msec/step]
2-905-003	Dev Rvs Time	K	ENG *	[0 to 200 / 80 / 10msec/step]
2-905-004	Dev Rvs Time	CI	ENG *	[0 to 200 / 100 / 10msec/step]
2-905-005	Dev Rvs Threshold Counter	ALL	ENG *	[0 to 400000 / 4000 / 10mm/step]
2-905-006	Dev Rvs Counter	K	ENG *	[0 to 4294967295 / 0 / 1mm/step]
2-905-007	Dev Rvs Counter	CI	ENG *	[0 to 4294967295 / 0 / 1mm/step]
2-907-001	ACS Setting (FC to Bk)	Continuous Bk Pages	ENG *	[0 to 10 / 0 / 1sheet/step]
2-908-156	Outer Motor Load	OPC Transfer M	ENG *	[0 to 65535 / 0 / 1/step]

3.SP Mode Tables

SP No.	Large Category	Small Category	ENG or CTL	[Min to Max/Init./Step]
2-908-157	Outer Motor Load	Color Opc M	ENG *	[0 to 65535 / 0 / 1/step]
2-908-158	Outer Motor Load	Bk Dev M	ENG *	[0 to 65535 / 0 / 1/step]
2-908-159	Outer Motor Load	Color Dev M	ENG *	[0 to 65535 / 0 / 1/step]
2-908-160	Outer Motor Load	Fusing M	ENG *	[0 to 65535 / 0 / 1/step]
2-908-161	Out M Signal Line	OPC Transfer M	ENG *	[0 to 65535 / 0 / 1/step]
2-908-162	Out M Signal Line	Color Opc M	ENG *	[0 to 65535 / 0 / 1/step]
2-908-163	Out M Signal Line	Bk Dev M	ENG *	[0 to 65535 / 0 / 1/step]
2-908-164	Out M Signal Line	Color Dev M	ENG *	[0 to 65535 / 0 / 1/step]
2-908-165	Out M Signal Line	Fusing M	ENG *	[0 to 65535 / 0 / 1/step]

3.SP Mode Tables

SP No.	Large Category	Small Category	ENG or CTL	[Min to Max/Init./Step]
2-930-001	Transfer: Bias Limiter	Bias	ENG*	[0 to 7000 / 6000 / 10-V/step]
2-960-001	Process Interval	Additional Time	ENG*	[0 to 10 / 0 / 1sec/step]
2-972-001	B/W Image Request Timing	T14: standard speed	ENG*	IM C6000: [0 to 4000 / 70 / 10msec/step] IM C5500: [0 to 4000 / 70 / 10msec/step] IM C4500: [0 to 4000 / 60 / 10msec/step]
2-972-002	B/W Image Request Timing	T14: middle Speed	ENG*	[0 to 4000 / 0 / 10msec/step]
2-972-003	B/W Image Request Timing	T14: low speed	ENG*	[0 to 4000 / 0 / 10msec/step]
2-974-001	Trans. Contact Fgate Timing: Y	Fwait: Y std	ENG*	[0 to 3000 / 0 / 10msec/step]
2-974-002	Trans. Contact Fgate Timing: Y	Fwait: Y mid	ENG*	[0 to 3000 / 0 / 10msec/step]

3.SP Mode Tables

SP No.	Large Category	Small Category	ENG or CTL	[Min to Max/Init./Step]
2-974-003	Trans. Contact Fgate Timing: Y	Fwait:Y low	ENG*	[0 to 3000 / 0 / 10msec/step]
2-980-001	LubricantApplication Operation	Lubricant Application Setting	ENG*	[0 to 300 / 100 / 10page/step]
2-980-002	LubricantApplication Operation	Idle Time: BK	ENG*	[0 to 600 / 30 / 1sec/step]
2-980-003	LubricantApplication Operation	Idle Time: FC	ENG*	[0 to 600 / 30 / 1sec/step]
2-990-001	Print Duty Control	Duty Control State	ENG*	[0 to 2 / 0 / 1/step]
2-990-002	Print Duty Control	Exec Interval: Duty Control	ENG*	[60 to 3600 / 60 / 10sec/step]
2-990-004	Print Duty Control	Forced CPM Down Thresh: No Duty Control	ENG*	[0 to 5000 / 0 / 1page/step]
2-990-005	Print Duty Control	Down-time_BW: No Duty Control	ENG*	[0 to 20000 / 0 / 10msec/step]
2-990-006	Print Duty Control	Down-time_FC: No Duty Control	ENG*	[0 to 20000 / 0 / 10msec/step]

3.SP Mode Tables

SP No.	Large Category	Small Category	ENG or CTL	[Min to Max/Init./Step]
2-990-007	Print Duty Control	Forced CPM Down Thresh: Duty Control	ENG *	[0 to 5000 / 20 / 1page/step]
2-990-008	Print Duty Control	Down-time_BW: Duty Control	ENG *	[0 to 240000 / 25000 / 10msec/step]
2-990-009	Print Duty Control	Down-time_FC: Duty Control	ENG *	[0 to 240000 / 25000 / 10msec/step]
2-990-010	Print Duty Control	Ambient Temp Correction Coeff	ENG *	[-1.0 to 1.0 / 0.0 / 0.1/step]
2-990-011	Print Duty Control	Execution Temp. Threshold	ENG *	[20.0 to 70.0 / 39.0 / 0.1deg/step]
2-990-012	Print Duty Control	Cancellation Temp. Threshold	ENG *	[0.1 to 20.0 / 0.1 / 0.1deg/step]
2-990-013	Print Duty Control	ON/OFF Setting	ENG *	[0 to 1 / 1 / 1/step]
2-990-014	Print Duty Control	Duty Control_Down-time_BW	ENG *	[0 to 240000 / 0 / 10msec/step]
2-990-015	Print Duty Control	Duty Control_Down-time_FC	ENG *	[0 to 240000 / 0 / 10msec/step]

3.SP Mode Tables

SP No.	Large Category	Small Category	ENG or CTL	[Min to Max/Init./Step]
2-990-041	Print Duty Control	ON/OFF Setting: BL Protection	ENG *	IM C6000: [0 to 1 / 0 / 1/step] IM C5500: [0 to 1 / 0 / 1/step] IM C4500: [0 to 1 / 0 / 1/step]
2-990-051	Print Duty Control	Execution Temp. Threshold: BL Protection	ENG *	IM C6000: [20.0 to 70.0 / 35.0 / 0.1deg/step] IM C5500: [20.0 to 70.0 / 35.0 / 0.1deg/step] IM C4500: [20.0 to 70.0 / 35.0 / 0.1deg/step]
2-990-052	Print Duty Control	Cancellation Temp. Threshold: BL Protection	ENG *	[0.1 to 20.0 / 0.1 / 0.1deg/step]
2-990-057	Print Duty Control	Forced CPM Down Thresh: BL Protection	ENG *	IM C6000: [0 to 5000 / 50 / 1page/step] IM C5500: [0 to 5000 / 50 / 1page/step] IM C4500: [0 to 5000 / 50 / 1page/step]

3.SP Mode Tables

SP No.	Large Category	Small Category	ENG or CTL	[Min to Max/Init./Step]
				1page/step]
2-990-058	Print Duty Control	Down-time_BW: Duty Control: BL Protection	ENG *	[0 to 240000 / 0 / 10msec/step]
2-990-059	Print Duty Control	Down-time_FC: Duty Control: BL Protection	ENG *	[0 to 240000 / 0 / 10msec/step]
2-998-002	Engine Design Area UL	UL02	ENG *	[0 to 0xFFFFFFFF / 1 / 1/step]
2-998-003	Engine Design Area UL	UL03	ENG *	[0 to 0xFFFFFFFF / 1 / 1/step]
2-998-004	Engine Design Area UL	UL04	ENG *	[0 to 0xFFFFFFFF / 1 / 1/step]
2-998-005	Engine Design Area UL	UL05	ENG *	[0 to 0xFFFFFFFF / 1 / 1/step]
2-998-006	Engine Design Area UL	UL06	ENG *	[0 to 0xFFFFFFFF / 1 / 1/step]
2-998-007	Engine Design Area UL	UL07	ENG *	[0 to 0xFFFFFFFF / 1 / 1/step]
2-998-	Engine Design Area UL	UL08	ENG *	[0 to 0xFFFFFFFF / 1 / 1/step]

SP No.	Large Category	Small Category	ENG or CTL	[Min to Max/Init./Step]
008				
2-998-009	Engine Design Area UL	UL09	ENG*	[0 to 0xFFFFFFFF / 1 / 1/step]
2-998-010	Engine Design Area UL	UL10	ENG*	[0 to 0xFFFFFFFF / 1 / 1/step]
2-998-011	Engine Design Area UL	UL11	ENG*	[0 to 0xFFFFFFFF / 1 / 1/step]

Engine SP Tables-3

SP3-XXX (Process)

SP No.	Large Category	Small Category	ENG or CTL	[Min to Max/Init./Step]
3-011-001	Manual ProCon :Exe	Normal ProCon	ENG	[0 to 1 / 0 / 1/step]
3-011-002	Manual ProCon :Exe	Density Adjustment	ENG	[0 to 1 / 0 / 1/step]
3-011-003	Manual ProCon :Exe	ACC RunTime ProCon	ENG	[0 to 1 / 0 / 1/step]
3-011-004	Manual ProCon :Exe	Full MUSIC	ENG	[0 to 1 / 0 / 1/step]
3-011-005	Manual ProCon :Exe	Normal MUSIC	ENG	[0 to 1 / 0 / 1/step]
3-	ProCon OK?	History:Last(Front)	ENG*	[0 to 99999999 / 0 /

3.SP Mode Tables

SP No.	Large Category	Small Category	ENG or CTL	[Min to Max/Init./Step]
012-001				1/step]
3-012-002	ProCon OK?	History:Last 2(Front)	ENG*	[0 to 99999999 / 0 / 1/step]
3-012-003	ProCon OK?	History:Last 3(Front)	ENG*	[0 to 99999999 / 0 / 1/step]
3-012-004	ProCon OK?	History:Last 4(Front)	ENG*	[0 to 99999999 / 0 / 1/step]
3-012-005	ProCon OK?	History:Last 5(Front)	ENG*	[0 to 99999999 / 0 / 1/step]
3-012-006	ProCon OK?	History:Last 6(Front)	ENG*	[0 to 99999999 / 0 / 1/step]
3-012-007	ProCon OK?	History:Last 7(Front)	ENG*	[0 to 99999999 / 0 / 1/step]
3-012-008	ProCon OK?	History:Last 8(Front)	ENG*	[0 to 99999999 / 0 / 1/step]
3-012-009	ProCon OK?	History:Last 9(Front)	ENG*	[0 to 99999999 / 0 / 1/step]
3-012-010	ProCon OK?	History:Last 10(Front)	ENG*	[0 to 99999999 / 0 / 1/step]
3-012-011	ProCon OK?	History:Last(Center)	ENG*	[0 to 99999999 / 0 / 1/step]
3-012-012	ProCon OK?	History:Last 2(Center)	ENG*	[0 to 99999999 / 0 / 1/step]

3.SP Mode Tables

SP No.	Large Category	Small Category	ENG or CTL	[Min to Max/Init./Step]
3-012-013	ProCon OK?	History:Last 3(Center)	ENG*	[0 to 99999999 / 0 / 1/step]
3-012-014	ProCon OK?	History:Last 4(Center)	ENG*	[0 to 99999999 / 0 / 1/step]
3-012-015	ProCon OK?	History:Last 5(Center)	ENG*	[0 to 99999999 / 0 / 1/step]
3-012-016	ProCon OK?	History:Last 6(Center)	ENG*	[0 to 99999999 / 0 / 1/step]
3-012-017	ProCon OK?	History:Last 7(Center)	ENG*	[0 to 99999999 / 0 / 1/step]
3-012-018	ProCon OK?	History:Last 8(Center)	ENG*	[0 to 99999999 / 0 / 1/step]
3-012-019	ProCon OK?	History:Last 9(Center)	ENG*	[0 to 99999999 / 0 / 1/step]
3-012-020	ProCon OK?	History:Last 10(Center)	ENG*	[0 to 99999999 / 0 / 1/step]
3-012-021	ProCon OK?	History:Last(Rear)	ENG*	[0 to 99999999 / 0 / 1/step]
3-012-022	ProCon OK?	History:Last 2(Rear)	ENG*	[0 to 99999999 / 0 / 1/step]
3-012-023	ProCon OK?	History:Last 3(Rear)	ENG*	[0 to 99999999 / 0 / 1/step]
3-012-024	ProCon OK?	History:Last 4(Rear)	ENG*	[0 to 99999999 / 0 / 1/step]

3.SP Mode Tables

SP No.	Large Category	Small Category	ENG or CTL	[Min to Max/Init./Step]
3-012-025	ProCon OK?	History:Last 5(Rear)	ENG*	[0 to 99999999 / 0 / 1/step]
3-012-026	ProCon OK?	History:Last 6(Rear)	ENG*	[0 to 99999999 / 0 / 1/step]
3-012-027	ProCon OK?	History:Last 7(Rear)	ENG*	[0 to 99999999 / 0 / 1/step]
3-012-028	ProCon OK?	History:Last 8(Rear)	ENG*	[0 to 99999999 / 0 / 1/step]
3-012-029	ProCon OK?	History:Last 9(Rear)	ENG*	[0 to 99999999 / 0 / 1/step]
3-012-030	ProCon OK?	History:Last 10(Rear)	ENG*	[0 to 99999999 / 0 / 1/step]
3-014-001	IBACC OK?	History:Last	ENG*	[0 to 9999 / 0 / 1/step]
3-014-002	IBACC OK?	History:Last 2	ENG*	[0 to 9999 / 0 / 1/step]
3-014-003	IBACC OK?	History:Last 3	ENG*	[0 to 9999 / 0 / 1/step]
3-014-004	IBACC OK?	History:Last 4	ENG*	[0 to 9999 / 0 / 1/step]
3-014-005	IBACC OK?	History:Last 5	ENG*	[0 to 9999 / 0 / 1/step]
3-014-006	IBACC OK?	History:Last 6	ENG*	[0 to 9999 / 0 / 1/step]

3.SP Mode Tables

SP No.	Large Category	Small Category	ENG or CTL	[Min to Max/Init./Step]
3-014-007	IBACC OK?	History:Last 7	ENG*	[0 to 9999 / 0 / 1/step]
3-014-008	IBACC OK?	History:Last 8	ENG*	[0 to 9999 / 0 / 1/step]
3-014-009	IBACC OK?	History:Last 9	ENG*	[0 to 9999 / 0 / 1/step]
3-014-010	IBACC OK?	History:Last 10	ENG*	[0 to 9999 / 0 / 1/step]
3-030-001	Init TD Sensor :Exe	Execute: ALL	ENG	[0 to 1 / 0 / 1/step]
3-030-002	Init TD Sensor :Exe	Execute: Col	ENG	[0 to 1 / 0 / 1/step]
3-030-003	Init TD Sensor :Exe	Execute: K	ENG	[0 to 1 / 0 / 1/step]
3-030-004	Init TD Sensor :Exe	Execute: C	ENG	[0 to 1 / 0 / 1/step]
3-030-005	Init TD Sensor :Exe	Execute: M	ENG	[0 to 1 / 0 / 1/step]
3-030-006	Init TD Sensor :Exe	Execute: Y	ENG	[0 to 1 / 0 / 1/step]
3-030-071	Init TD Sensor :Exe	Init Temp: K	ENG*	[-100.0 to 100.0 / 23.0 / 0.1deg/step]
3-030-072	Init TD Sensor :Exe	Init Temp: C	ENG*	[-100.0 to 100.0 / 23.0 / 0.1deg/step]

3.SP Mode Tables

SP No.	Large Category	Small Category	ENG or CTL	[Min to Max/Init./Step]
3-030-073	Init TD Sensor :Exe	Init Temp: M	ENG*	[-100.0 to 100.0 / 23.0 / 0.1deg/step]
3-030-074	Init TD Sensor :Exe	Init Temp: Y	ENG*	[-100.0 to 100.0 / 23.0 / 0.1deg/step]
3-030-081	Init TD Sensor :Exe	Init Rel Hum: K	ENG*	[0.0 to 100.0 / 50.0 / 0.1%RH/step]
3-030-082	Init TD Sensor :Exe	Init Rel Hum: C	ENG*	[0.0 to 100.0 / 50.0 / 0.1%RH/step]
3-030-083	Init TD Sensor :Exe	Init Rel Hum: M	ENG*	[0.0 to 100.0 / 50.0 / 0.1%RH/step]
3-030-084	Init TD Sensor :Exe	Init Rel Hum: Y	ENG*	[0.0 to 100.0 / 50.0 / 0.1%RH/step]
3-030-091	Init TD Sensor :Exe	Init Abs Hum: K	ENG*	[0.00 to 100.00 / 10.30 / 0.01g/m3/step]
3-030-092	Init TD Sensor :Exe	Init Abs Hum: C	ENG*	[0.00 to 100.00 / 10.30 / 0.01g/m3/step]
3-030-093	Init TD Sensor :Exe	Init Abs Hum: M	ENG*	[0.00 to 100.00 / 10.30 / 0.01g/m3/step]
3-030-094	Init TD Sensor :Exe	Init Abs Hum: Y	ENG*	[0.00 to 100.00 / 10.30 / 0.01g/m3/step]
3-031-001	TD Sens Init OK?	From Left:YMCK	ENG*	[0 to 9999 / 0 / 1/step]
3-050-001	Force Tnr Supply :Exe	Execute: ALL	ENG	[0 to 1 / 0 / 1/step]

3.SP Mode Tables

SP No.	Large Category	Small Category	ENG or CTL	[Min to Max/Init./Step]
3-050-002	Force Tnr Supply :Exe	Execute: Col	ENG	[0 to 1 / 0 / 1/step]
3-050-003	Force Tnr Supply :Exe	Execute: K	ENG	[0 to 1 / 0 / 1/step]
3-050-004	Force Tnr Supply :Exe	Execute: C	ENG	[0 to 1 / 0 / 1/step]
3-050-005	Force Tnr Supply :Exe	Execute: M	ENG	[0 to 1 / 0 / 1/step]
3-050-006	Force Tnr Supply :Exe	Execute: Y	ENG	[0 to 1 / 0 / 1/step]
3-050-021	Force Tnr Supply :Exe	Supply Quantity:K	ENG*	[0.0 to 5.0 / 0.5 / 0.1wt%/step]
3-050-022	Force Tnr Supply :Exe	Supply Quantity:C	ENG*	[0.0 to 5.0 / 0.5 / 0.1wt%/step]
3-050-023	Force Tnr Supply :Exe	Supply Quantity:M	ENG*	[0.0 to 5.0 / 0.5 / 0.1wt%/step]
3-050-024	Force Tnr Supply :Exe	Supply Quantity:Y	ENG*	[0.0 to 5.0 / 0.5 / 0.1wt%/step]
3-050-033	Force Tnr Supply :Exe	RepeatCount	ENG*	[0 to 255 / 8 / 1times/step]
3-072-001	T Sensor: Check	Execute Check	ENG	[0 to 1 / 0 / 1/step]
3-073-001	T Sensor Measurement Value:	mu count:K	ENG*	[0 to 65535 / 0 / 1/step]

3.SP Mode Tables

SP No.	Large Category	Small Category	ENG or CTL	[Min to Max/Init./Step]
3-073-002	T Sensor Measurement Value:	mu count:C	ENG*	[0 to 65535 / 0 / 1/step]
3-073-003	T Sensor Measurement Value:	mu count:M	ENG*	[0 to 65535 / 0 / 1/step]
3-073-004	T Sensor Measurement Value:	mu count:Y	ENG*	[0 to 65535 / 0 / 1/step]
3-100-001	Tonner End Detection: Set	ON/OFF	ENG*	[0 to 1 / 0 / 1/step]
3-100-002	Tonner End Detection: Set	NE Detection	ENG*	[0 to 1 / 0 / 1/step]
3-100-003	Toner End Detection: Set	Estimated NE Detection	ENG*	[0 to 3 / 1 / 1/step]
3-101-001	Toner Status :Disp	K	ENG*	[0 to 10 / 10 / 1/step]
3-101-002	Toner Status :Disp	C	ENG*	[0 to 10 / 10 / 1/step]
3-101-003	Toner Status :Disp	M	ENG*	[0 to 10 / 10 / 1/step]
3-101-004	Toner Status :Disp	Y	ENG*	[0 to 10 / 10 / 1/step]
3-102-001	Toner Remain:Disp	Bottle Motor: Bk	ENG*	[0.000 to 700.000 / 560.000 / 0.001g/step]
3-102-002	Toner Remain:Disp	Bottle Motor: C	ENG*	[0.000 to 700.000 / 440.000 / 0.001g/step]

3.SP Mode Tables

SP No.	Large Category	Small Category	ENG or CTL	[Min to Max/Init./Step]
3-102-003	Toner Remain:Disp	Bottle Motor: M	ENG*	[0.000 to 700.000 / 440.000 / 0.001g/step]
3-102-004	Toner Remain:Disp	Bottle Motor: Y	ENG*	[0.000 to 700.000 / 440.000 / 0.001g/step]
3-102-011	Toner Remain:Disp	Pixel: Bk	ENG*	[0.000 to 700.000 / 560.000 / 0.001g/step]
3-102-012	Toner Remain:Disp	Pixel: C	ENG*	[0.000 to 700.000 / 440.000 / 0.001g/step]
3-102-013	Toner Remain:Disp	Pixel: M	ENG*	[0.000 to 700.000 / 440.000 / 0.001g/step]
3-102-014	Toner Remain:Disp	Pixel: Y	ENG*	[0.000 to 700.000 / 440.000 / 0.001g/step]
3-102-021	Toner Remaining: Display	Fill Amount: Bk	ENG*	[0 to 600 / 560 / 1g/step]
3-102-022	Toner Remaining: Display	Fill Amount: C	ENG*	[0 to 600 / 440 / 1g/step]
3-102-023	Toner Remaining: Display	Fill Amount: M	ENG*	[0 to 600 / 440 / 1g/step]
3-102-024	Toner Remaining: Display	Fill Amount: Y	ENG*	[0 to 600 / 440 / 1g/step]
3-102-031	Toner Remain:Disp	Pixel: Toner Consumption x 2: Bk	ENG*	[0.000 to 1000.000 / 0.000 / 0.001g/step]
3-102-032	Toner Remain:Disp	Pixel: Toner Consumption x 2: C	ENG*	[0.000 to 1000.000 / 0.000 / 0.001g/step]

3.SP Mode Tables

SP No.	Large Category	Small Category	ENG or CTL	[Min to Max/Init./Step]
3-102-033	Toner Remain:Disp	Pixel: Toner Consumption x 2: M	ENG*	[0.000 to 1000.000 / 0.000 / 0.001g/step]
3-102-034	Toner Remain:Disp	Pixel: Toner Consumption x 2: Y	ENG*	[0.000 to 1000.000 / 0.000 / 0.001g/step]
3-102-041	Toner Remain:Disp	Drive Motor: Toner Consumption x 1: Bk	ENG*	[0.000 to 1000.000 / 0.000 / 0.001g/step]
3-102-042	Toner Remain:Disp	Drive Motor: Toner Consumption x 1: C	ENG*	[0.000 to 1000.000 / 0.000 / 0.001g/step]
3-102-043	Toner Remain:Disp	Drive Motor: Toner Consumption x 1: M	ENG*	[0.000 to 1000.000 / 0.000 / 0.001g/step]
3-102-044	Toner Remain:Disp	Drive Motor: Toner Consumption x 1: Y	ENG*	[0.000 to 1000.000 / 0.000 / 0.001g/step]
3-102-051	Toner Remain:Disp	Calculated Toner Consumption: Bk	ENG*	[0.000 to 1000.000 / 0.000 / 0.001g/step]
3-102-052	Toner Remain:Disp	Calculated Toner Consumption: C	ENG*	[0.000 to 1000.000 / 0.000 / 0.001g/step]
3-102-053	Toner Remain:Disp	Calculated Toner Consumption: M	ENG*	[0.000 to 1000.000 / 0.000 / 0.001g/step]
3-102-054	Toner Remain:Disp	Calculated Toner Consumption: Y	ENG*	[0.000 to 1000.000 / 0.000 / 0.001g/step]
3-104-001	Flag: Display	NE Toner: Bk	ENG*	[0 to 1 / 0 / 1/step]
3-104-002	Flag: Display	NE Toner: C	ENG*	[0 to 1 / 0 / 1/step]

3.SP Mode Tables

SP No.	Large Category	Small Category	ENG or CTL	[Min to Max/Init./Step]
3-104-003	Flag: Display	NE Toner: M	ENG*	[0 to 1 / 0 / 1/step]
3-104-004	Flag: Display	NE Toner: Y	ENG*	[0 to 1 / 0 / 1/step]
3-104-011	Flag: Display	Vt end:Bk	ENG*	[0 to 1 / 0 / 1/step]
3-104-012	Flag: Display	Vt end:C	ENG*	[0 to 1 / 0 / 1/step]
3-104-013	Flag: Display	Vt end:M	ENG*	[0 to 1 / 0 / 1/step]
3-104-014	Flag: Display	Vt end:Y	ENG*	[0 to 1 / 0 / 1/step]
3-110-001	Near End Thresh 1	Bk	ENG*	IM C6000: [0 to 500 / 65 / 1g/step] IM C5500: [0 to 500 / 65 / 1g/step] IM C4500: [0 to 500 / 65 / 1g/step]
3-110-002	Near End Thresh 1	C	ENG*	IM C6000: [0 to 500 / 55 / 1g/step] IM C5500: [0 to 500 / 55 / 1g/step] IM C4500: [0 to 500 / 55 / 1g/step]
3-110-003	Near End Thresh 1	M	ENG*	IM C6000: [0 to 500 / 55 / 1g/step] IM C5500: [0 to 500 / 55 / 1g/step] IM C4500: [0 to 500 / 55 / 1g/step]

3.SP Mode Tables

SP No.	Large Category	Small Category	ENG or CTL	[Min to Max/Init./Step]
3-110-004	Near End Thresh 1	Y	ENG*	IM C6000: [0 to 500 / 55 / 1g/step] IM C5500: [0 to 500 / 55 / 1g/step] IM C4500: [0 to 500 / 55 / 1g/step]
3-110-011	Near End Thresh 2	Bk	ENG*	[0 to 500 / 65 / 1g/step]
3-110-012	Near End Thresh 2	C	ENG*	[0 to 500 / 65 / 1g/step]
3-110-013	Near End Thresh 2	M	ENG*	[0 to 500 / 65 / 1g/step]
3-110-014	Near End Thresh 2	Y	ENG*	[0 to 500 / 65 / 1g/step]
3-110-021	NE Thresh 2 Upper Limit :Set	Bk	ENG*	[0 to 600 / 600 / 1g/step]
3-110-022	NE Thresh 2 Upper Limit :Set	C	ENG*	[0 to 600 / 600 / 1g/step]
3-110-023	NE Thresh 2 Upper Limit :Set	M	ENG*	[0 to 600 / 600 / 1g/step]
3-110-024	NE Thresh 2 Upper Limit :Set	Y	ENG*	[0 to 600 / 600 / 1g/step]
3-110-031	NE Thresh 2 Lower Limit :Set	Bk	ENG*	[0 to 600 / 20 / 1g/step]
3-110-032	NE Thresh 2 Lower Limit :Set	C	ENG*	[0 to 600 / 20 / 1g/step]

3.SP Mode Tables

SP No.	Large Category	Small Category	ENG or CTL	[Min to Max/Init./Step]
3-110-033	NE Thresh 2 Lower Limit :Set	M	ENG*	[0 to 600 / 20 / 1g/step]
3-110-034	NE Thresh 2 Lower Limit :Set	Y	ENG*	[0 to 600 / 20 / 1g/step]
3-112-001	Near End Thresh 2 (Day)	Bk	ENG*	[0 to 2000 / 15 / 1day/step]
3-112-002	Near End Thresh 2 (Day)	C	ENG*	[0 to 2000 / 15 / 1day/step]
3-112-003	Near End Thresh 2 (Day)	M	ENG*	[0 to 2000 / 15 / 1day/step]
3-112-004	Near End Thresh 2 (Day)	Y	ENG*	[0 to 2000 / 15 / 1day/step]
3-113-001	Correction Factor Ave.	Bk	ENG*	IM C6000: [0.000 to 2.000 / 0.824 / 0.001/step] IM C5500: [0.000 to 2.000 / 0.824 / 0.001/step] IM C4500: [0.000 to 2.000 / 0.824 / 0.001/step]
3-113-002	Correction Factor Ave.	C	ENG*	IM C6000: [0.000 to 2.000 / 0.850 / 0.001/step] IM C5500: [0.000 to 2.000 / 0.850 / 0.001/step] IM C4500: [0.000 to 2.000 / 0.850 / 0.001/step]

3.SP Mode Tables

SP No.	Large Category	Small Category	ENG or CTL	[Min to Max/Init./Step]
3-113-003	Correction Factor Ave.	M	ENG*	IM C6000: [0.000 to 2.000 / 0.875 / 0.001/step] IM C5500: [0.000 to 2.000 / 0.875 / 0.001/step] IM C4500: [0.000 to 2.000 / 0.875 / 0.001/step]
3-113-004	Correction Factor Ave.	Y	ENG*	IM C6000: [0.000 to 2.000 / 0.858 / 0.001/step] IM C5500: [0.000 to 2.000 / 0.858 / 0.001/step] IM C4500: [0.000 to 2.000 / 0.858 / 0.001/step]
3-114-001	Correction Factor Dispersion	Bk	ENG*	IM C6000: [0.000 to 1.000 / 0.036 / 0.001/step] IM C5500: [0.000 to 1.000 / 0.036 / 0.001/step] IM C4500: [0.000 to 1.000 / 0.036 / 0.001/step]
3-114-002	Correction Factor Dispersion	C	ENG*	IM C6000: [0.000 to 1.000 / 0.038 / 0.001/step] IM C5500: [0.000 to 1.000 / 0.038 / 0.001/step] IM C4500: [0.000 to 1.000 / 0.038 / 0.001/step]

3.SP Mode Tables

SP No.	Large Category	Small Category	ENG or CTL	[Min to Max/Init./Step]
3-114-003	Correction Factor Dispersion	M	ENG*	IM C6000: [0.000 to 1.000 / 0.044 / 0.001/step] IM C5500: [0.000 to 1.000 / 0.044 / 0.001/step] IM C4500: [0.000 to 1.000 / 0.044 / 0.001/step]
3-114-004	Correction Factor Dispersion	Y	ENG*	IM C6000: [0.000 to 1.000 / 0.041 / 0.001/step] IM C5500: [0.000 to 1.000 / 0.041 / 0.001/step] IM C4500: [0.000 to 1.000 / 0.041 / 0.001/step]
3-115-001	Ordered Flag	Bk	ENG*	[0 to 2000 / 0 / 1/step]
3-115-002	Ordered Flag	C	ENG*	[0 to 2000 / 0 / 1/step]
3-115-003	Ordered Flag	M	ENG*	[0 to 2000 / 0 / 1/step]
3-115-004	Ordered Flag	Y	ENG*	[0 to 2000 / 0 / 1/step]
3-116-001	Dates of Thresh	Bk	ENG*	[0 to 2000 / 14 / 1day/step]
3-116-002	Dates of Thresh	C	ENG*	[0 to 2000 / 14 / 1day/step]

3.SP Mode Tables

SP No.	Large Category	Small Category	ENG or CTL	[Min to Max/Init./Step]
3-116-003	Dates of Thresh	M	ENG*	[0 to 2000 / 14 / 1day/step]
3-116-004	Dates of Thresh	Y	ENG*	[0 to 2000 / 14 / 1day/step]
3-121-001	TE Counter: Disp	Bk	ENG*	[0 to 99 / 0 / 1times/step]
3-121-002	TE Counter: Disp	C	ENG*	[0 to 99 / 0 / 1times/step]
3-121-003	TE Counter: Disp	M	ENG*	[0 to 99 / 0 / 1times/step]
3-121-004	TE Counter: Disp	Y	ENG*	[0 to 99 / 0 / 1times/step]
3-121-011	TE Counter: Clearcount	Bk	ENG*	[0 to 10 / 0 / 1times/step]
3-121-012	TE Counter: Clearcount	C	ENG*	[0 to 10 / 0 / 1times/step]
3-121-013	TE Counter: Clearcount	M	ENG*	[0 to 10 / 0 / 1times/step]
3-121-014	TE Counter: Clearcount	Y	ENG*	[0 to 10 / 0 / 1times/step]
3-131-001	Vt TE Thresh	Delta Vt Thresh	ENG*	[0.00 to 5.00 / 0.50 / 0.01V/step]
3-131-002	Vt TE Thresh	Delta Vt Sum Thresh	ENG*	[0 to 99 / 10 / 1V/step]

3.SP Mode Tables

SP No.	Large Category	Small Category	ENG or CTL	[Min to Max/Init./Step]
3-131-011	Vt TE Thresh	Delta Vt Thresh BF NE	ENG*	[0.00 to 5.00 / 0.50 / 0.01V/step]
3-131-012	Vt TE Thresh	Delta Vt Sum Thresh BF NE	ENG*	[0 to 99 / 10 / 1V/step]
3-132-001	Delta Vt Sum	Bk	ENG*	[0.00 to 99.00 / 0.00 / 0.01V/step]
3-132-002	Delta Vt Sum	C	ENG*	[0.00 to 99.00 / 0.00 / 0.01V/step]
3-132-003	Delta Vt Sum	M	ENG*	[0.00 to 99.00 / 0.00 / 0.01V/step]
3-132-004	Delta Vt Sum	Y	ENG*	[0.00 to 99.00 / 0.00 / 0.01V/step]
3-133-001	TE Detect :Set	Set Sheets(Min)	ENG*	[0 to 50 / 10 / 1sheets/step]
3-133-002	TE Detect :Set	Set Sheets(Max)	ENG*	[0 to 5000 / 1000 / 1sheets/step]
3-133-011	TE Detect :Set	Page Cnt:K	ENG*	[0 to 5000 / 0 / 1sheets/step]
3-133-012	TE Detect :Set	Page Cnt:C	ENG*	[0 to 5000 / 0 / 1sheets/step]
3-133-013	TE Detect :Set	Page Cnt:M	ENG*	[0 to 5000 / 0 / 1sheets/step]
3-133-014	TE Detect :Set	Page Cnt:Y	ENG*	[0 to 5000 / 0 / 1sheets/step]

3.SP Mode Tables

SP No.	Large Category	Small Category	ENG or CTL	[Min to Max/Init./Step]
3-133-021	TE Detect :Set	Set Pxl Cnt	ENG*	[0 to 1000000 / 3900 / 1cm2/step]
3-133-031	TE Detect :Set	Pxl Cnt:K	ENG*	[0 to 1000000 / 0 / 1cm2/step]
3-133-032	TE Detect :Set	Pxl Cnt:C	ENG*	[0 to 1000000 / 0 / 1cm2/step]
3-133-033	TE Detect :Set	Pxl Cnt:M	ENG*	[0 to 1000000 / 0 / 1cm2/step]
3-133-034	TE Detect :Set	Pxl Cnt:Y	ENG*	[0 to 1000000 / 0 / 1cm2/step]
3-134-001	Toner End Toner Remain	Bk	ENG*	[0.000 to 1000.000 / 20.000 / 0.001g/step]
3-134-002	Toner End Toner Remain	C	ENG*	[0.000 to 1000.000 / 20.000 / 0.001g/step]
3-134-003	Toner End Toner Remain	M	ENG*	[0.000 to 1000.000 / 20.000 / 0.001g/step]
3-134-004	Toner End Toner Remain	Y	ENG*	[0.000 to 1000.000 / 20.000 / 0.001g/step]
3-150-001	TE Sensor :Set	SamplingCount	ENG*	[4 to 20 / 10 / 1counts/step]
3-150-002	TE Sensor :Set	Judge:p	ENG*	[0.2 to 1.0 / 0.8 / 0.1/step]
3-150-003	TE Sensor :Set	result:K	ENG*	[0.0 to 1.0 / 0.5 / 0.1/step]

SP No.	Large Category	Small Category	ENG or CTL	[Min to Max/Init./Step]
3-150-004	TE Sensor :Set	result:C	ENG*	[0.0 to 1.0 / 0.5 / 0.1/step]
3-150-005	TE Sensor :Set	result:M	ENG*	[0.0 to 1.0 / 0.5 / 0.1/step]
3-150-006	TE Sensor :Set	result:Y	ENG*	[0.0 to 1.0 / 0.5 / 0.1/step]
3-160-001	Bottle Drive :Set	Bottle Drive System	ENG*	[0 to 1 / 0 / 1/step]
3-200-001	TnrDensity	K	ENG*	[0.0 to 25.5 / 0.0 / 0.1wt%/step]
3-200-002	TnrDensity	C	ENG*	[0.0 to 25.5 / 0.0 / 0.1wt%/step]
3-200-003	TnrDensity	M	ENG*	[0.0 to 25.5 / 0.0 / 0.1wt%/step]
3-200-004	TnrDensity	Y	ENG*	[0.0 to 25.5 / 0.0 / 0.1wt%/step]
3-201-001	TnrDensity	Upper TC_K	ENG*	[1.0 to 15.0 / 9.0 / 0.1wt%/step]
3-201-002	TnrDensity	Upper TC_C	ENG*	[1.0 to 15.0 / 9.0 / 0.1wt%/step]
3-201-003	TnrDensity	Upper TC_M	ENG*	[1.0 to 15.0 / 9.0 / 0.1wt%/step]
3-201-004	TnrDensity	Upper TC_Y	ENG*	[1.0 to 15.0 / 9.0 / 0.1wt%/step]

3.SP Mode Tables

SP No.	Large Category	Small Category	ENG or CTL	[Min to Max/Init./Step]
3-201-011	TnrDensity	Lower TC_K	ENG*	IM C6000: [-1.0 to 15.0 / -1.0 / 0.1wt%/step] IM C5500: [-1.0 to 15.0 / -1.0 / 0.1wt%/step] IM C4500: [-1.0 to 15.0 / 0.0 / 0.1wt%/step]
3-201-012	TnrDensity	Lower TC_C	ENG*	IM C6000: [-1.0 to 15.0 / -1.0 / 0.1wt%/step] IM C5500: [-1.0 to 15.0 / -1.0 / 0.1wt%/step] IM C4500: [-1.0 to 15.0 / 0.0 / 0.1wt%/step]
3-201-013	TnrDensity	Lower TC_M	ENG*	IM C6000: [-1.0 to 15.0 / -1.0 / 0.1wt%/step] IM C5500: [-1.0 to 15.0 / -1.0 / 0.1wt%/step] IM C4500: [-1.0 to 15.0 / 0.0 / 0.1wt%/step]
3-201-014	TnrDensity	Lower TC_Y	ENG*	IM C6000: [-1.0 to 15.0 / -1.0 / 0.1wt%/step] IM C5500: [-1.0 to 15.0 / -1.0 / 0.1wt%/step] IM C4500: [-1.0 to 15.0 / 0.0 / 0.1wt%/step]

SP No.	Large Category	Small Category	ENG or CTL	[Min to Max/Init./Step]
3-205-051	TD.Sens Sensitivity	Mu Cnv Coef:K	ENG*	IM C6000: [0.001 to 0.100 / 0.019 / 0.001V/count/step] IM C5500: [0.001 to 0.100 / 0.019 / 0.001V/count/step] IM C4500: [0.001 to 0.100 / 0.018 / 0.001V/count/step]
3-205-052	TD.Sens Sensitivity	Mu Cnv Coef:C	ENG*	IM C6000: [0.001 to 0.100 / 0.018 / 0.001V/count/step] IM C5500: [0.001 to 0.100 / 0.018 / 0.001V/count/step] IM C4500: [0.001 to 0.100 / 0.017 / 0.001V/count/step]
3-205-053	TD.Sens Sensitivity	Mu Cnv Coef:M	ENG*	IM C6000: [0.001 to 0.100 / 0.018 / 0.001V/count/step] IM C5500: [0.001 to 0.100 / 0.018 / 0.001V/count/step] IM C4500: [0.001 to 0.100 / 0.017 / 0.001V/count/step]
3-205-054	TD.Sens Sensitivity	Mu Cnv Coef:Y	ENG*	IM C6000: [0.001 to 0.100 / 0.018 / 0.001V/count/step] IM C5500: [0.001 to 0.100 / 0.018 / 0.001V/count/step] IM C4500: [0.001 to 0.100 / 0.017 / 0.001V/count/step]

3.SP Mode Tables

SP No.	Large Category	Small Category	ENG or CTL	[Min to Max/Init./Step]
3-205-101	TD.Sens Sensitivity	Bulk Density: K	ENG*	[-5.00 to 5.00 / 0.00 / 0.01V/step]
3-205-102	TD.Sens Sensitivity	Bulk Density: C	ENG*	[-5.00 to 5.00 / 0.00 / 0.01V/step]
3-205-103	TD.Sens Sensitivity	Bulk Density: M	ENG*	[-5.00 to 5.00 / 0.00 / 0.01V/step]
3-205-104	TD.Sens Sensitivity	Bulk Density: Y	ENG*	[-5.00 to 5.00 / 0.00 / 0.01V/step]
3-210-001	TD.Sens:Vt :Disp	Current: K	ENG*	[0.00 to 5.50 / 0.00 / 0.01V/step]
3-210-002	TD.Sens:Vt :Disp	Current: C	ENG*	[0.00 to 5.50 / 0.00 / 0.01V/step]
3-210-003	TD.Sens:Vt :Disp	Current: M	ENG*	[0.00 to 5.50 / 0.00 / 0.01V/step]
3-210-004	TD.Sens:Vt :Disp	Current: Y	ENG*	[0.00 to 5.50 / 0.00 / 0.01V/step]
3-212-101	Vt Shift :Set	TC Cor.(ON/OFF)	ENG*	[0 to 1 / 0 / 1/step]
3-212-111	Vt Shift :Set	TC Mid Spd:K	ENG*	[-0.50 to 0.50 / 0.00 / 0.01V/step]
3-212-112	Vt Shift :Set	TC Mid Spd:C	ENG*	[-0.50 to 0.50 / 0.00 / 0.01V/step]
3-212-113	Vt Shift :Set	TC Mid Spd:M	ENG*	[-0.50 to 0.50 / 0.00 / 0.01V/step]

3.SP Mode Tables

SP No.	Large Category	Small Category	ENG or CTL	[Min to Max/Init./Step]
3-212-114	Vt Shift :Set	TC Mid Spd:Y	ENG*	[-0.50 to 0.50 / 0.00 / 0.01V/step]
3-212-121	Vt Shift :Set	TC Low Spd:K	ENG*	[-0.50 to 0.50 / 0.00 / 0.01V/step]
3-212-122	Vt Shift :Set	TC Low Spd:C	ENG*	[-0.50 to 0.50 / 0.00 / 0.01V/step]
3-212-123	Vt Shift :Set	TC Low Spd:M	ENG*	[-0.50 to 0.50 / 0.00 / 0.01V/step]
3-212-124	Vt Shift :Set	TC Low Spd:Y	ENG*	[-0.50 to 0.50 / 0.00 / 0.01V/step]
3-214-001	Vt Save :Set	Coverage Thresh	ENG*	[0 to 100 / 20 / 1%/step]
3-230-001	Vtref :Disp/Set	Current: K	ENG*	[0.00 to 5.00 / 1.80 / 0.01V/step]
3-230-002	Vtref :Disp/Set	Current: C	ENG*	[0.00 to 5.00 / 1.80 / 0.01V/step]
3-230-003	Vtref :Disp/Set	Current: M	ENG*	[0.00 to 5.00 / 1.80 / 0.01V/step]
3-230-004	Vtref :Disp/Set	Current: Y	ENG*	[0.00 to 5.00 / 1.80 / 0.01V/step]
3-232-001	Vtref Correct:Pixel	ON/OFF	ENG*	[0 to 1 / 1 / 1/step]
3-232-011	Vtref Correct:Pixel	Low Coverage Coef:K	ENG*	IM C6000: [0.0 to 5.0 / 1.0 / 0.1/step]

3.SP Mode Tables

SP No.	Large Category	Small Category	ENG or CTL	[Min to Max/Init./Step]
				IM C5500: [0.0 to 5.0 / 1.0 / 0.1/step] IM C4500: [0.0 to 5.0 / 1.0 / 0.1/step]
3-232-012	Vtref Correct:Pixel	Low Coverage Coef:C	ENG*	IM C6000: [0.0 to 5.0 / 1.0 / 0.1/step] IM C5500: [0.0 to 5.0 / 1.0 / 0.1/step] IM C4500: [0.0 to 5.0 / 1.0 / 0.1/step]
3-232-013	Vtref Correct:Pixel	Low Coverage Coef:M	ENG*	IM C6000: [0.0 to 5.0 / 1.0 / 0.1/step] IM C5500: [0.0 to 5.0 / 1.0 / 0.1/step] IM C4500: [0.0 to 5.0 / 1.0 / 0.1/step]
3-232-014	Vtref Correct:Pixel	Low Coverage Coef:Y	ENG*	IM C6000: [0.0 to 5.0 / 1.0 / 0.1/step] IM C5500: [0.0 to 5.0 / 1.0 / 0.1/step] IM C4500: [0.0 to 5.0 / 1.0 / 0.1/step]
3-232-021	Vtref Correct:Pixel	High Coverage Coef:K	ENG*	IM C6000: [0.0 to 5.0 / 0.5 / 0.1/step]

SP No.	Large Category	Small Category	ENG or CTL	[Min to Max/Init./Step]
				IM C5500: [0.0 to 5.0 / 0.5 / 0.1/step] IM C4500: [0.0 to 5.0 / 0.5 / 0.1/step]
3-232-022	Vtref Correct:Pixel	High Coverage Coeff:C	ENG*	IM C6000: [0.0 to 5.0 / 0.5 / 0.1/step] IM C5500: [0.0 to 5.0 / 0.5 / 0.1/step] IM C4500: [0.0 to 5.0 / 0.5 / 0.1/step]
3-232-023	Vtref Correct:Pixel	High Coverage Coeff:M	ENG*	IM C6000: [0.0 to 5.0 / 0.5 / 0.1/step] IM C5500: [0.0 to 5.0 / 0.5 / 0.1/step] IM C4500: [0.0 to 5.0 / 0.5 / 0.1/step]
3-232-024	Vtref Correct:Pixel	High Coverage Coeff:Y	ENG*	IM C6000: [0.0 to 5.0 / 0.5 / 0.1/step] IM C5500: [0.0 to 5.0 / 0.5 / 0.1/step] IM C4500: [0.0 to 5.0 / 0.5 / 0.1/step]
3-232-040	Vtref Correct:Pixel	Initial ProCon Thresh	ENG*	[0 to 255 / 100 / 1times/step]

3.SP Mode Tables

SP No.	Large Category	Small Category	ENG or CTL	[Min to Max/Init./Step]
3-232-041	Vtref Correct:Pixel	High Coverage Thresh:H	ENG*	[0 to 100 / 100 / 1%/step]
3-232-050	Vtref Correct:Pixel	ProCon Thresh	ENG*	[0 to 255 / 100 / 1times/step]
3-232-060	Vtref Correct:Pixel	Low Coverage Thresh	ENG*	[0.0 to 20.0 / 3.0 / 0.1%/step]
3-232-071	Vtref Correct:Pixel	TC Upper Limit:Display:Bk	ENG*	[1.0 to 15.0 / 9.0 / 0.1wt%/step]
3-232-072	Vtref Correct:Pixel	TC Upper Limit:Display:C	ENG*	[1.0 to 15.0 / 9.0 / 0.1wt%/step]
3-232-073	Vtref Correct:Pixel	TC Upper Limit:Display:M	ENG*	[1.0 to 15.0 / 9.0 / 0.1wt%/step]
3-232-074	Vtref Correct:Pixel	TC Upper Limit:Display:Y	ENG*	[1.0 to 15.0 / 9.0 / 0.1wt%/step]
3-232-081	Vtref Correct:Pixel	TC Upper Limit Correction:K	ENG*	[0.0 to 5.0 / 0.5 / 0.1wt%/step]
3-232-082	Vtref Correct:Pixel	TC Upper Limit Correction:C	ENG*	[0.0 to 5.0 / 0.5 / 0.1wt%/step]
3-232-083	Vtref Correct:Pixel	TC Upper Limit Correction:M	ENG*	[0.0 to 5.0 / 0.5 / 0.1wt%/step]
3-232-084	Vtref Correct:Pixel	TC Upper Limit Correction:Y	ENG*	[0.0 to 5.0 / 0.5 / 0.1wt%/step]
3-233-001	RTP Vtref Corr :Disp/Set	ON/OFF	ENG*	[0 to 1 / 1 / 1/step]

SP No.	Large Category	Small Category	ENG or CTL	[Min to Max/Init./Step]
3-233-011	RTP Vtref Corr :Disp/Set	Corr Amt(+):K	ENG*	[0.00 to 1.00 / 0.03 / 0.01V/step]
3-233-012	RTP Vtref Corr :Disp/Set	Corr Amt(+):C	ENG*	[0.00 to 1.00 / 0.03 / 0.01V/step]
3-233-013	RTP Vtref Corr :Disp/Set	Corr Amt(+):M	ENG*	[0.00 to 1.00 / 0.03 / 0.01V/step]
3-233-014	RTP Vtref Corr :Disp/Set	Corr Amt(+):Y	ENG*	[0.00 to 1.00 / 0.03 / 0.01V/step]
3-233-021	RTP Vtref Corr :Disp/Set	Corr Amt(-):K	ENG*	[0.00 to 1.00 / 0.03 / 0.01V/step]
3-233-022	RTP Vtref Corr :Disp/Set	Corr Amt(-):C	ENG*	[0.00 to 1.00 / 0.03 / 0.01V/step]
3-233-023	RTP Vtref Corr :Disp/Set	Corr Amt(-):M	ENG*	[0.00 to 1.00 / 0.03 / 0.01V/step]
3-233-024	RTP Vtref Corr :Disp/Set	Corr Amt(-):Y	ENG*	[0.00 to 1.00 / 0.03 / 0.01V/step]
3-233-031	RTP Vtref Corr :Disp/Set	Corr Thresh:K	ENG*	[0.000 to 0.100 / 0.005 / 0.001mg/cm2/step]
3-233-032	RTP Vtref Corr :Disp/Set	Corr Thresh:C	ENG*	[0.000 to 0.100 / 0.010 / 0.001mg/cm2/step]
3-233-033	RTP Vtref Corr :Disp/Set	Corr Thresh:M	ENG*	[0.000 to 0.100 / 0.010 / 0.001mg/cm2/step]
3-233-034	RTP Vtref Corr :Disp/Set	Corr Thresh:Y	ENG*	[0.000 to 0.100 / 0.010 / 0.001mg/cm2/step]

3.SP Mode Tables

SP No.	Large Category	Small Category	ENG or CTL	[Min to Max/Init./Step]
3-233-041	RTP Vtref Corr :Disp/Set	Vtavg Weight Coeff (H)	ENG*	[0 to 100 / 30 / 1%/step]
3-233-051	RTP Vtref Corr :Disp/Set	Vtavg Weight Coeff (M)	ENG*	[0 to 100 / 0 / 1%/step]
3-233-061	RTP Vtref Corr :Disp/Set	Vtavg Weight Coeff (L)	ENG*	[0 to 100 / 5 / 1%/step]
3-234-001	Vtref Corr :Disp/Set	ON/OFF	ENG*	[0 to 1 / 1 / 1/step]
3-234-011	Vtref Corr :Disp/Set	Corr Amt(+):K	ENG*	[0.00 to 1.00 / 0.01 / 0.01V/step]
3-234-012	Vtref Corr :Disp/Set	Corr Amt(+):C	ENG*	[0.00 to 1.00 / 0.01 / 0.01V/step]
3-234-013	Vtref Corr :Disp/Set	Corr Amt(+):M	ENG*	[0.00 to 1.00 / 0.01 / 0.01V/step]
3-234-014	Vtref Corr :Disp/Set	Corr Amt(+):Y	ENG*	[0.00 to 1.00 / 0.01 / 0.01V/step]
3-234-021	Vtref Corr :Disp/Set	Corr Amt(-):K	ENG*	[0.00 to 1.00 / 0.01 / 0.01V/step]
3-234-022	Vtref Corr :Disp/Set	Corr Amt(-):C	ENG*	[0.00 to 1.00 / 0.01 / 0.01V/step]
3-234-023	Vtref Corr :Disp/Set	Corr Amt(-):M	ENG*	[0.00 to 1.00 / 0.01 / 0.01V/step]
3-234-024	Vtref Corr :Disp/Set	Corr Amt(-):Y	ENG*	[0.00 to 1.00 / 0.01 / 0.01V/step]

3.SP Mode Tables

SP No.	Large Category	Small Category	ENG or CTL	[Min to Max/Init./Step]
3-234-031	Vtref Corr :Disp/Set	P Rank 1 Threshold	ENG*	[0.00 to 2.00 / 0.15 / 0.01/step]
3-234-032	Vtref Corr :Disp/Set	P Rank 2 Threshold	ENG*	[0.00 to 2.00 / 0.05 / 0.01/step]
3-234-033	Vtref Corr :Disp/Set	P Rank 3 Threshold	ENG*	[-2.00 to 0.00 / -0.05 / 0.01/step]
3-234-034	Vtref Corr :Disp/Set	P Rank 4 Threshold	ENG*	[-2.00 to 0.00 / -0.25 / 0.01/step]
3-234-041	Vtref Corr :Disp/Set	T Rank 1 Threshold	ENG*	[-1.00 to 0.00 / -0.20 / 0.01V/step]
3-234-042	Vtref Corr :Disp/Set	T Rank 2 Threshold	ENG*	[0.00 to 1.00 / 0.20 / 0.01V/step]
3-234-050	Vtref Corr :Disp/Set	Correction Coefficient	ENG*	[1.0 to 10.0 / 10.0 / 0.1/step]
3-250-001	ImgArea :Disp	ImgArea:K	ENG*	[0 to 9999 / 0 / 1cm2/step]
3-250-002	ImgArea :Disp	ImgArea:C	ENG*	[0 to 9999 / 0 / 1cm2/step]
3-250-003	ImgArea :Disp	ImgArea:M	ENG*	[0 to 9999 / 0 / 1cm2/step]
3-250-004	ImgArea :Disp	ImgArea:Y	ENG*	[0 to 9999 / 0 / 1cm2/step]
3-251-001	DotCoverage :Disp	DotCoverage:K	ENG*	[0.00 to 100.00 / 0.00 / 0.01%/step]

3.SP Mode Tables

SP No.	Large Category	Small Category	ENG or CTL	[Min to Max/Init./Step]
3-251-002	DotCoverage :Disp	DotCoverage:C	ENG*	[0.00 to 100.00 / 0.00 / 0.01%/step]
3-251-003	DotCoverage :Disp	DotCoverage:M	ENG*	[0.00 to 100.00 / 0.00 / 0.01%/step]
3-251-004	DotCoverage :Disp	DotCoverage:Y	ENG*	[0.00 to 100.00 / 0.00 / 0.01%/step]
3-251-011	DotCoverage :Disp	DC Avg.:S:K	ENG*	[0.00 to 100.00 / 5.00 / 0.01%/step]
3-251-012	DotCoverage :Disp	DC Avg.:S:C	ENG*	[0.00 to 100.00 / 5.00 / 0.01%/step]
3-251-013	DotCoverage :Disp	DC Avg.:S:M	ENG*	[0.00 to 100.00 / 5.00 / 0.01%/step]
3-251-014	DotCoverage :Disp	DC Avg.:S:Y	ENG*	[0.00 to 100.00 / 5.00 / 0.01%/step]
3-251-021	DotCoverage :Disp	DC Avg.:M:K	ENG*	[0.00 to 100.00 / 5.00 / 0.01%/step]
3-251-022	DotCoverage :Disp	DC Avg.:M:C	ENG*	[0.00 to 100.00 / 5.00 / 0.01%/step]
3-251-023	DotCoverage :Disp	DC Avg.:M:M	ENG*	[0.00 to 100.00 / 5.00 / 0.01%/step]
3-251-024	DotCoverage :Disp	DC Avg.:M:Y	ENG*	[0.00 to 100.00 / 5.00 / 0.01%/step]
3-251-031	DotCoverage :Disp	DC Avg.:L:K	ENG*	[0.00 to 100.00 / 5.00 / 0.01%/step]

3.SP Mode Tables

SP No.	Large Category	Small Category	ENG or CTL	[Min to Max/Init./Step]
3-251-032	DotCoverage :Disp	DC Avg.:L:C	ENG*	[0.00 to 100.00 / 5.00 / 0.01%/step]
3-251-033	DotCoverage :Disp	DC Avg.:L:M	ENG*	[0.00 to 100.00 / 5.00 / 0.01%/step]
3-251-034	DotCoverage :Disp	DC Avg.:L:Y	ENG*	[0.00 to 100.00 / 5.00 / 0.01%/step]
3-251-041	DotCoverage :Disp	TotalPage:S:Set	ENG*	[1 to 255 / 50 / 1counts/step]
3-251-042	DotCoverage :Disp	TotalPage:S:Set	ENG*	[1 to 500 / 50 / 1counts/step]
3-251-043	DotCoverage :Disp	TotalPage:S:Set	ENG*	[1 to 999 / 250 / 1counts/step]
3-251-051	DotCoverage :Disp	TotalPage:S:Set	ENG*	[1 to 255 / 100 / 1counts/step]
3-251-052	DotCoverage :Disp	TotalPage:S:Set	ENG*	[1 to 500 / 50 / 1counts/step]
3-251-053	DotCoverage :Disp	TotalPage:S:Set	ENG*	[1 to 999 / 250 / 1counts/step]
3-251-151	DotCoverage :Disp	Total DC: Dev: K	ENG*	[0.00 to 100.00 / 0.00 / 0.01%/step]
3-251-152	DotCoverage :Disp	Total DC: Dev: C	ENG*	[0.00 to 100.00 / 0.00 / 0.01%/step]
3-251-153	DotCoverage :Disp	Total DC: Dev: M	ENG*	[0.00 to 100.00 / 0.00 / 0.01%/step]

3.SP Mode Tables

SP No.	Large Category	Small Category	ENG or CTL	[Min to Max/Init./Step]
3-251-154	DotCoverage :Disp	Total DC: Dev: Y	ENG*	[0.00 to 100.00 / 0.00 / 0.01%/step]
3-252-001	AccumImgArea :Disp	ImgArea:K	ENG*	[0 to 65535 / 0 / 1cm ² /step]
3-252-002	AccumImgArea :Disp	ImgArea:C	ENG*	[0 to 65535 / 0 / 1cm ² /step]
3-252-003	AccumImgArea :Disp	ImgArea:M	ENG*	[0 to 65535 / 0 / 1cm ² /step]
3-252-004	AccumImgArea :Disp	ImgArea:Y	ENG*	[0 to 65535 / 0 / 1cm ² /step]
3-252-011	AccumImgArea :Disp	Tatal dev:K	ENG*	[0 to 4294967295 / 0 / 1cm ² /step]
3-252-012	AccumImgArea :Disp	Tatal dev:C	ENG*	[0 to 4294967295 / 0 / 1cm ² /step]
3-252-013	AccumImgArea :Disp	Tatal dev:M	ENG*	[0 to 4294967295 / 0 / 1cm ² /step]
3-252-014	AccumImgArea :Disp	Tatal dev:Y	ENG*	[0 to 4294967295 / 0 / 1cm ² /step]
3-260-001	Temperature/Humidity: Display	Temperature	ENG	[-5.0 to 45.0 / 0.0 / 0.1deg/step]
3-260-002	Temperature/Humidity: Display	Relative Humidity	ENG	[0.0 to 100.0 / 0.0 / 0.1%RH/step]
3-260-003	Temperature/Humidity: Display	Absolute Humidity	ENG	[0.00 to 100.00 / 0.00 / 0.01g/m ³ /step]

3.SP Mode Tables

SP No.	Large Category	Small Category	ENG or CTL	[Min to Max/Init./Step]
3-300-001	RTP Pattern :Disp	M/A(Latest):K	ENG*	[0.000 to 1.000 / 0.000 / 0.001mg/cm2/step]
3-300-002	RTP Pattern :Disp	M/A(Latest):C	ENG*	[0.000 to 2.000 / 0.000 / 0.001mg/cm2/step]
3-300-003	RTP Pattern :Disp	M/A(Latest):M	ENG*	[0.000 to 2.000 / 0.000 / 0.001mg/cm2/step]
3-300-004	RTP Pattern :Disp	M/A(Latest):Y	ENG*	[0.000 to 2.000 / 0.000 / 0.001mg/cm2/step]
3-300-011	RTP Pattern :Disp	M/A(Target):K	ENG*	[0.000 to 1.000 / 0.248 / 0.001mg/cm2/step]
3-300-012	RTP Pattern :Disp	M/A(Target):C	ENG*	[0.000 to 1.000 / 0.400 / 0.001mg/cm2/step]
3-300-013	RTP Pattern :Disp	M/A(Target):M	ENG*	[0.000 to 1.000 / 0.450 / 0.001mg/cm2/step]
3-300-014	RTP Pattern :Disp	M/A(Target):Y	ENG*	[0.000 to 1.000 / 0.400 / 0.001mg/cm2/step]
3-301-001	RTP Pattern :Set	Create Intrvl:BW	ENG	[0 to 200 / 10 / 1pages/step]
3-301-002	RTP Pattern :Set	Create Intrvl:FC	ENG	[0 to 200 / 10 / 1pages/step]
3-301-011	RTP Pattern :Set	Page Cnt:BW	ENG*	[0 to 200 / 0 / 1pages/step]
3-301-012	RTP Pattern :Set	Page Cnt:FC	ENG*	[0 to 200 / 0 / 1pages/step]

3.SP Mode Tables

SP No.	Large Category	Small Category	ENG or CTL	[Min to Max/Init./Step]
3-301-021	RTP Pattern :Set	M/A UppErr:K	ENG	[0.000 to 1.000 / 0.600 / 0.001mg/cm2/step]
3-301-022	RTP Pattern :Set	M/A UppErr:Col	ENG	[0.000 to 2.000 / 1.200 / 0.001mg/cm2/step]
3-301-023	RTP Pattern :Set	M/A LowErr:K	ENG	[0.000 to 1.000 / 0.100 / 0.001mg/cm2/step]
3-301-024	RTP Pattern :Set	M/A LowErr:Col	ENG	[0.000 to 1.000 / 0.200 / 0.001mg/cm2/step]
3-301-031	RTP Pattern :Set	Feed Cnt :Set	ENG*	[0 to 99999999 / 50000 / 1ms/step]
3-301-041	RTP Pattern :Set	Feed Cnt :K	ENG*	[0 to 99999999 / 0 / 1ms/step]
3-301-042	RTP Pattern :Set	Feed Cnt :C	ENG*	[0 to 99999999 / 0 / 1ms/step]
3-301-043	RTP Pattern :Set	Feed Cnt :M	ENG*	[0 to 99999999 / 0 / 1ms/step]
3-301-044	RTP Pattern :Set	Feed Cnt :Y	ENG*	[0 to 99999999 / 0 / 1ms/step]
3-301-081	RTP Pattern :Set	M/A(RTP)_Std	ENG*	[0.000 to 1.000 / 0.248 / 0.001mg/cm2/step]
3-301-091	RTP Pattern :Set	M/A Thresh_Upp:K	ENG*	[0.000 to 1.000 / 0.095 / 0.001mg/cm2/step]
3-301-092	RTP Pattern :Set	M/A Thresh_Upp:C	ENG*	[0.000 to 1.000 / 0.050 / 0.001mg/cm2/step]

3.SP Mode Tables

SP No.	Large Category	Small Category	ENG or CTL	[Min to Max/Init./Step]
3-301-093	RTP Pattern :Set	M/A Thresh_Upp:M	ENG*	[0.000 to 1.000 / 0.050 / 0.001mg/cm2/step]
3-301-094	RTP Pattern :Set	M/A Thresh_Upp:Y	ENG*	[0.000 to 1.000 / 0.050 / 0.001mg/cm2/step]
3-301-101	RTP Pattern :Set	M/A Thresh_Low:K	ENG*	[0.000 to 1.000 / 0.095 / 0.001mg/cm2/step]
3-301-102	RTP Pattern :Set	M/A Thresh_Low:C	ENG*	[0.000 to 1.000 / 0.100 / 0.001mg/cm2/step]
3-301-103	RTP Pattern :Set	M/A Thresh_Low:M	ENG*	[0.000 to 1.000 / 0.100 / 0.001mg/cm2/step]
3-301-104	RTP Pattern :Set	M/A Thresh_Low:Y	ENG*	[0.000 to 1.000 / 0.100 / 0.001mg/cm2/step]
3-301-111	RTP Pattern :Set	Weight Coeff:K	ENG*	[1 to 10 / 1 / 1/step]
3-301-112	RTP Pattern :Set	Weight Coeff:Col	ENG*	[1 to 10 / 1 / 1/step]
3-310-001	ID.Sens :Voffset	Voffset reg (Front)	ENG*	[0.00 to 5.50 / 0.00 / 0.01V/step]
3-310-002	ID.Sens :Voffset	Voffset reg (Center)	ENG*	[0.00 to 5.50 / 0.00 / 0.01V/step]
3-310-003	ID.Sens :Voffset	Voffset reg (Rear)	ENG*	[0.00 to 5.50 / 0.00 / 0.01V/step]
3-310-011	ID.Sens :Voffset	Voffset dif (Front)	ENG*	[0.00 to 5.50 / 0.00 / 0.01V/step]

3.SP Mode Tables

SP No.	Large Category	Small Category	ENG or CTL	[Min to Max/Init./Step]
3-310-012	ID.Sens :Voffset	Voffset dif (Center)	ENG*	[0.00 to 5.50 / 0.00 / 0.01V/step]
3-310-013	ID.Sens :Voffset	Voffset dif (Rear)	ENG*	[0.00 to 5.50 / 0.00 / 0.01V/step]
3-310-021	ID.Sens :Voffset	Voffset TM(Front)	ENG*	[0.00 to 5.50 / 0.00 / 0.01V/step]
3-310-022	ID.Sens :Voffset	Voffset TM(Center)	ENG*	[0.00 to 5.50 / 0.00 / 0.01V/step]
3-310-023	ID.Sens :Voffset	Voffset TM(Rear)	ENG*	[0.00 to 5.50 / 0.00 / 0.01V/step]
3-311-001	ID.Sens :Vmin	Vmin_K(Front)	ENG*	[0.000 to 5.000 / 0.000 / 0.001V/step]
3-311-002	ID.Sens :Vmin	Vmin_K(Center)	ENG*	[0.000 to 5.000 / 0.000 / 0.001V/step]
3-311-003	ID.Sens :Vmin	Vmin_K(Rear)	ENG*	[0.000 to 5.000 / 0.000 / 0.001V/step]
3-312-001	ID.Sens :Vct	Vct_reg(Front)	ENG*	[0.000 to 5.000 / 0.000 / 0.001V/step]
3-312-002	ID.Sens :Vct	Vct_reg(Center)	ENG*	[0.000 to 5.000 / 0.000 / 0.001V/step]
3-312-003	ID.Sens :Vct	Vct_reg(Rear)	ENG*	[0.000 to 5.000 / 0.000 / 0.001V/step]
3-312-011	ID.Sens :Vct	Vct_dif(Front)	ENG*	[0.000 to 5.000 / 0.000 / 0.001V/step]

3.SP Mode Tables

SP No.	Large Category	Small Category	ENG or CTL	[Min to Max/Init./Step]
3-312-012	ID.Sens :Vct	Vct_dif(Center)	ENG*	[0.000 to 5.000 / 0.000 / 0.001V/step]
3-312-013	ID.Sens :Vct	Vct_dif(Rear)	ENG*	[0.000 to 5.000 / 0.000 / 0.001V/step]
3-320-001	Vsg Adj: Execute	P Sensor	ENG	[0 to 1 / 0 / 1/step]
3-320-031	Vsg Adj: Execute	Vsg Error Counter (Front)	ENG*	[0 to 99 / 0 / 1times/step]
3-320-032	Vsg Adj: Execute	Vsg Error Counter (Center)	ENG*	[0 to 99 / 0 / 1times/step]
3-320-033	Vsg Adj: Execute	Vsg Error Counter (Rear)	ENG*	[0 to 99 / 0 / 1times/step]
3-321-001	Adjusted Vsg	Vsg reg (Front)	ENG*	[0.00 to 5.50 / 4.00 / 0.01V/step]
3-321-002	Adjusted Vsg	Vsg reg (Center)	ENG*	[0.00 to 5.50 / 4.00 / 0.01V/step]
3-321-003	Adjusted Vsg	Vsg reg (Rear)	ENG*	[0.00 to 5.50 / 4.00 / 0.01V/step]
3-321-011	Adjusted Vsg	Vsg dif (Front)	ENG*	[0.00 to 5.50 / 0.00 / 0.01V/step]
3-321-012	Adjusted Vsg	Vsg dif (Center)	ENG*	[0.00 to 5.50 / 0.00 / 0.01V/step]
3-321-013	Adjusted Vsg	Vsg dif (Rear)	ENG*	[0.00 to 5.50 / 0.00 / 0.01V/step]

3.SP Mode Tables

SP No.	Large Category	Small Category	ENG or CTL	[Min to Max/Init./Step]
3-321-041	Adjusted Vsg	Vsg TM(Front)	ENG*	[0.00 to 5.50 / 4.00 / 0.01V/step]
3-321-042	Adjusted Vsg	Vsg TM(Center)	ENG*	[0.00 to 5.50 / 4.00 / 0.01V/step]
3-321-043	Adjusted Vsg	Vsg TM(Rear)	ENG*	[0.00 to 5.50 / 4.00 / 0.01V/step]
3-321-071	Adjusted Vsg	Vsg reg sd(Front) Avg.	ENG*	[0.00 to 5.50 / 0.00 / 0.01V/step]
3-321-072	Adjusted Vsg	Vsg reg sd(Center) Avg.	ENG*	[0.00 to 5.50 / 0.00 / 0.01V/step]
3-321-073	Adjusted Vsg	Vsg reg sd(Rear) Avg.	ENG*	[0.00 to 5.50 / 0.00 / 0.01V/step]
3-321-081	Adjusted Vsg	Vsg reg sd(BW Front) Avg.	ENG*	[0.00 to 5.50 / 0.00 / 0.01V/step]
3-321-082	Adjusted Vsg	Vsg reg sd(BW Center) Avg.	ENG*	[0.00 to 5.50 / 0.00 / 0.01V/step]
3-321-083	Adjusted Vsg	Vsg reg sd(BW Rear) Avg.	ENG*	[0.00 to 5.50 / 0.00 / 0.01V/step]
3-321-091	Adjusted Vsg	Vsg reg sd_Avg. Count:Set	ENG*	[1 to 255 / 5 / 1/step]
3-322-001	Adjusted Ifsg	Ifsg RTP (Front)	ENG*	[0.000 to 50.000 / 10.000 / 0.001mA/step]
3-322-002	Adjusted Ifsg	Ifsg RTP (Center)	ENG*	[0.000 to 50.000 / 10.000 / 0.001mA/step]

3.SP Mode Tables

SP No.	Large Category	Small Category	ENG or CTL	[Min to Max/Init./Step]
3-322-003	Adjusted Ifsg	Ifsg RTP (Rear)	ENG*	[0.000 to 50.000 / 10.000 / 0.001mA/step]
3-322-011	Adjusted Ifsg	Ifsg Min (Front)	ENG*	[0.000 to 50.000 / 27.000 / 0.001mA/step]
3-322-012	Adjusted Ifsg	Ifsg Min (Center)	ENG*	[0.000 to 50.000 / 27.000 / 0.001mA/step]
3-322-013	Adjusted Ifsg	Ifsg Min (Rear)	ENG*	[0.000 to 50.000 / 27.000 / 0.001mA/step]
3-322-021	Adjusted Ifsg	Ifsg: TM(Front)	ENG*	[0.000 to 50.000 / 10.000 / 0.001mA/step]
3-322-022	Adjusted Ifsg	Ifsg: TM(Center)	ENG*	[0.000 to 50.000 / 10.000 / 0.001mA/step]
3-322-023	Adjusted Ifsg	Ifsg: TM(Rear)	ENG*	[0.000 to 50.000 / 10.000 / 0.001mA/step]
3-323-001	Vsg Adj OK?	Latest	ENG*	[0 to 999 / 0 / 1/step]
3-323-002	Vsg Adj OK?	Latest 2	ENG*	[0 to 999 / 0 / 1/step]
3-323-003	Vsg Adj OK?	Latest 3	ENG*	[0 to 999 / 0 / 1/step]
3-323-004	Vsg Adj OK?	Latest 4	ENG*	[0 to 999 / 0 / 1/step]
3-323-005	Vsg Adj OK?	Latest 5	ENG*	[0 to 999 / 0 / 1/step]

3.SP Mode Tables

SP No.	Large Category	Small Category	ENG or CTL	[Min to Max/Init./Step]
3-323-006	Vsg Adj OK?	Latest 6	ENG*	[0 to 999 / 0 / 1/step]
3-323-007	Vsg Adj OK?	Latest 7	ENG*	[0 to 999 / 0 / 1/step]
3-323-008	Vsg Adj OK?	Latest 8	ENG*	[0 to 999 / 0 / 1/step]
3-323-009	Vsg Adj OK?	Latest 9	ENG*	[0 to 999 / 0 / 1/step]
3-323-010	Vsg Adj OK?	Latest 10	ENG*	[0 to 999 / 0 / 1/step]
3-330-001	ID.Sens Coef :Disp	K2(Latest) (Front)	ENG*	[0.0000 to 5.0000 / 0.0000 / 0.0001/step]
3-330-002	ID.Sens Coef :Disp	K2(Latest) (Center)	ENG*	[0.0000 to 5.0000 / 0.0000 / 0.0001/step]
3-330-003	ID.Sens Coef :Disp	K2(Latest) (Rear)	ENG*	[0.0000 to 5.0000 / 0.0000 / 0.0001/step]
3-330-011	ID.Sens Coef :Disp	K5(Latest) (Front)	ENG*	[0.0000 to 10.0000 / 5.0000 / 0.0001/step]
3-330-012	ID.Sens Coef :Disp	K5(Latest) (Center)	ENG*	[0.0000 to 10.0000 / 5.0000 / 0.0001/step]
3-330-013	ID.Sens Coef :Disp	K5(Latest) (Rear)	ENG*	[0.0000 to 10.0000 / 5.0000 / 0.0001/step]
3-333-001	ID.Sens TestVal:F	K2: Check	ENG*	[0.000 to 1.000 / 0.516 / 0.001/step]

3.SP Mode Tables

SP No.	Large Category	Small Category	ENG or CTL	[Min to Max/Init./Step]
3-333-002	ID.Sens TestVal:F	Diffuse Corr	ENG*	[0.75 to 1.35 / 1.00 / 0.01/step]
3-333-003	ID.Sens TestVal:F	Vct_reg Check:Slope	ENG*	[0.0 to 200.0 / 0.0 / 0.1mV/mA/step]
3-333-004	ID.Sens TestVal:F	Vct_reg Check:Xint	ENG*	[0.0 to 25.5 / 0.0 / 0.1mA/step]
3-333-005	ID.Sens TestVal:F	Vct_dif Check:Slope	ENG*	[0.0 to 200.0 / 0.0 / 0.1mV/mA/step]
3-333-006	ID.Sens TestVal:F	Vct_dif Check:Xint	ENG*	[0.0 to 25.5 / 0.0 / 0.1mA/step]
3-334-001	ID.Sens TestVal:C	K2: Check	ENG*	[0.000 to 1.000 / 0.516 / 0.001/step]
3-334-002	ID.Sens TestVal:C	Diffuse Corr	ENG*	[0.75 to 1.35 / 1.00 / 0.01/step]
3-334-003	ID.Sens TestVal:C	Vct_reg Check:Slope	ENG*	[0.0 to 200.0 / 0.0 / 0.1mV/mA/step]
3-334-004	ID.Sens TestVal:C	Vct_reg Check:Xint	ENG*	[0.0 to 25.5 / 0.0 / 0.1mA/step]
3-334-005	ID.Sens TestVal:C	Vct_dif Check:Slope	ENG*	[0.0 to 200.0 / 0.0 / 0.1mV/mA/step]
3-334-006	ID.Sens TestVal:C	Vct_dif Check:Xint	ENG*	[0.0 to 25.5 / 0.0 / 0.1mA/step]
3-335-001	ID.Sens TestVal:R	K2: Check	ENG*	[0.000 to 1.000 / 0.516 / 0.001/step]

3.SP Mode Tables

SP No.	Large Category	Small Category	ENG or CTL	[Min to Max/Init./Step]
3-335-002	ID.Sens TestVal:R	Diffuse Corr	ENG*	[0.75 to 1.35 / 1.00 / 0.01/step]
3-335-003	ID.Sens TestVal:R	Vct_reg Check:Slope	ENG*	[0.0 to 200.0 / 0.0 / 0.1mV/mA/step]
3-335-004	ID.Sens TestVal:R	Vct_reg Check:Xint	ENG*	[0.0 to 25.5 / 0.0 / 0.1mA/step]
3-335-005	ID.Sens TestVal:R	Vct_dif Check:Slope	ENG*	[0.0 to 200.0 / 0.0 / 0.1mV/mA/step]
3-335-006	ID.Sens TestVal:R	Vct_dif Check:Xint	ENG*	[0.0 to 25.5 / 0.0 / 0.1mA/step]
3-400-001	Toner Supply Type	K	ENG*	[0 to 4 / 4 / 1/step]
3-400-002	Toner Supply Type	C	ENG*	[0 to 4 / 4 / 1/step]
3-400-003	Toner Supply Type	M	ENG*	[0 to 4 / 4 / 1/step]
3-400-004	Toner Supply Type	Y	ENG*	[0 to 4 / 4 / 1/step]
3-411-001	Toner Supply Qty	K	ENG	[0.0 to 40000.0 / 0.0 / 0.1mg/step]
3-411-002	Toner Supply Qty	C	ENG	[0.0 to 40000.0 / 0.0 / 0.1mg/step]
3-411-003	Toner Supply Qty	M	ENG	[0.0 to 40000.0 / 0.0 / 0.1mg/step]

3.SP Mode Tables

SP No.	Large Category	Small Category	ENG or CTL	[Min to Max/Init./Step]
3-411-004	Toner Supply Qty	Y	ENG	[0.0 to 40000.0 / 0.0 / 0.1mg/step]
3-420-001	DeveloperWeight :Set	DeveloperWeight:K	ENG*	[50 to 2000 / 380 / 1g/step]
3-420-002	DeveloperWeight :Set	DeveloperWeight:C	ENG*	[50 to 2000 / 380 / 1g/step]
3-420-003	DeveloperWeight :Set	DeveloperWeight:M	ENG*	[50 to 2000 / 380 / 1g/step]
3-420-004	DeveloperWeight :Set	DeveloperWeight:Y	ENG*	[50 to 2000 / 380 / 1g/step]
3-421-001	TnrSplyAbility	K	ENG*	[0.001 to 2.000 / 0.710 / 0.001mg/msec/step]
3-421-002	TnrSplyAbility	C	ENG*	[0.001 to 2.000 / 0.710 / 0.001mg/msec/step]
3-421-003	TnrSplyAbility	M	ENG*	[0.001 to 2.000 / 0.710 / 0.001mg/msec/step]
3-421-004	TnrSplyAbility	Y	ENG*	[0.001 to 2.000 / 0.710 / 0.001mg/msec/step]
3-421-011	TnrSplyAbility	TnrSplyAbilityCoef1	ENG*	[0.50 to 2.00 / 1.12 / 0.01/step]
3-421-012	TnrSplyAbility	TnrSplyAbilityCoef2	ENG*	[0.50 to 2.00 / 1.12 / 0.01/step]
3-421-013	TnrSplyAbility	TnrSplyAbilityCoef3	ENG*	[0.50 to 2.00 / 1.10 / 0.01/step]

3.SP Mode Tables

SP No.	Large Category	Small Category	ENG or CTL	[Min to Max/Init./Step]
3-421-014	TnrSplyAbility	TnrSplyAbilityCoef4	ENG*	[0.50 to 2.00 / 1.06 / 0.01/step]
3-421-015	TnrSplyAbility	TnrSplyAbilityCoef5	ENG*	[0.50 to 2.00 / 1.00 / 0.01/step]
3-421-016	TnrSplyAbility	TnrSplyAbilityCoef6	ENG*	[0.50 to 2.00 / 0.99 / 0.01/step]
3-421-017	TnrSplyAbility	TnrSplyAbilityCoef7	ENG*	[0.50 to 2.00 / 0.98 / 0.01/step]
3-421-018	TnrSplyAbility	TnrSplyAbilityCoef8	ENG*	[0.50 to 2.00 / 0.95 / 0.01/step]
3-421-019	TnrSplyAbility	TnrSplyAbilityCoef9	ENG*	[0.50 to 2.00 / 0.95 / 0.01/step]
3-421-020	TnrSplyAbility	TnrSplyAbilityCoef10	ENG*	[0.50 to 2.00 / 0.95 / 0.01/step]
3-421-031	TnrSplyAbility	AbsHum Threshold:1	ENG*	[0.0 to 65.0 / 6.0 / 0.1g/m3/step]
3-421-032	TnrSplyAbility	AbsHum Threshold:2	ENG*	[0.0 to 65.0 / 12.0 / 0.1g/m3/step]
3-421-033	TnrSplyAbility	AbsHum Threshold:3	ENG*	[0.0 to 65.0 / 24.0 / 0.1g/m3/step]
3-421-041	TnrSplyAbility	Environ Coef1	ENG*	[0.50 to 2.00 / 1.00 / 0.01/step]
3-421-042	TnrSplyAbility	Environ Coef2	ENG*	[0.50 to 2.00 / 1.00 / 0.01/step]

SP No.	Large Category	Small Category	ENG or CTL	[Min to Max/Init./Step]
3-421-043	TnrSplyAbility	Environ Coef3	ENG*	[0.50 to 2.00 / 1.00 / 0.01/step]
3-421-044	TnrSplyAbility	Environ Coef4	ENG*	[0.50 to 2.00 / 1.00 / 0.01/step]
3-422-001	Tnr Supply Limits :Set	Max Supply Rate:K	ENG*	[0 to 255 / 87 / 1%/step]
3-422-002	Tnr Supply Limits :Set	Max Supply Rate:C	ENG*	[0 to 255 / 87 / 1%/step]
3-422-003	Tnr Supply Limits :Set	Max Supply Rate:M	ENG*	[0 to 255 / 87 / 1%/step]
3-422-004	Tnr Supply Limits :Set	Max Supply Rate:Y	ENG*	[0 to 255 / 87 / 1%/step]
3-422-011	Tnr Supply Limits :Set	Min Supply Time: K	ENG*	[0 to 255 / 100 / 1msec/step]
3-422-012	Tnr Supply Limits :Set	Min Supply Time: C	ENG*	[0 to 255 / 100 / 1msec/step]
3-422-013	Tnr Supply Limits :Set	Min Supply Time: M	ENG*	[0 to 255 / 100 / 1msec/step]
3-422-014	Tnr Supply Limits :Set	Min Supply Time: Y	ENG*	[0 to 255 / 100 / 1msec/step]
3-428-001	TnrSplyDelay : Setting	Delay	ENG*	[0 to 255 / 0 / 1msec/step]
3-440-001	Fixed Supply Mode	Fixed Rate: K	ENG*	[0 to 100 / 10 / 1%/step]

3.SP Mode Tables

SP No.	Large Category	Small Category	ENG or CTL	[Min to Max/Init./Step]
3-440-002	Fixed Supply Mode	Fixed Rate: C	ENG*	[0 to 100 / 10 / 1%/step]
3-440-003	Fixed Supply Mode	Fixed Rate: M	ENG*	[0 to 100 / 10 / 1%/step]
3-440-004	Fixed Supply Mode	Fixed Rate: Y	ENG*	[0 to 100 / 10 / 1%/step]
3-460-011	TonerSupply :DANC	Time_Min	ENG*	[0 to 250 / 0 / 1msec/step]
3-460-012	TonerSupply :DANC	Time_Max	ENG*	[0 to 1000 / 200 / 1msec/step]
3-460-022	TonerSupply :DANC	SMITH_Weight:K	ENG*	[1 to 500 / 140 / 1mg/step]
3-460-023	TonerSupply :DANC	SMITH_Weight:CMY	ENG*	[1 to 500 / 140 / 1mg/step]
3-460-111	TonerSupply :DANC	Rev_Fix:K	ENG*	[1.00 to 1.50 / 1.00 / 0.01/step]
3-460-112	TonerSupply :DANC	Rev_Fix:C	ENG*	[1.00 to 1.50 / 1.00 / 0.01/step]
3-460-113	TonerSupply :DANC	Rev_Fix:M	ENG*	[1.00 to 1.50 / 1.00 / 0.01/step]
3-460-114	TonerSupply :DANC	Rev_Fix:Y	ENG*	[1.00 to 1.50 / 1.00 / 0.01/step]
3-461-001	TonerSupply :DANC	PI:Power	ENG*	[5 to 200 / 100 / 1%/step]

3.SP Mode Tables

SP No.	Large Category	Small Category	ENG or CTL	[Min to Max/Init./Step]
3-461-011	TonerSupply :DANC	PI:P Gain:K	ENG*	[0.0000 to 1.0000 / 0.0100 / 0.0001/step]
3-461-012	TonerSupply :DANC	PI:P Limits:Up:K	ENG*	[0.00 to 1.00 / 0.10 / 0.01/step]
3-461-013	TonerSupply :DANC	PI:P Limits:Low:K	ENG*	[0.00 to 1.00 / 0.10 / 0.01/step]
3-461-021	TonerSupply :DANC	PI:I Gain:K	ENG*	[0.0000 to 0.1000 / 0.0010 / 0.0001/step]
3-461-022	TonerSupply :DANC	PI:I Limits:Up:K	ENG*	[0.00 to 1.00 / 0.10 / 0.01/step]
3-461-023	TonerSupply :DANC	PI:I Limits:Low:K	ENG*	[0.00 to 1.00 / 0.10 / 0.01/step]
3-461-031	TonerSupply :DANC	PI:P Gain:CMY	ENG*	[0.0000 to 1.0000 / 0.0100 / 0.0001/step]
3-461-032	TonerSupply :DANC	PI:P Limits:Up:CMY	ENG*	[0.00 to 1.00 / 0.10 / 0.01/step]
3-461-033	TonerSupply :DANC	PI:P Limits:Low:CMY	ENG*	[0.00 to 1.00 / 0.10 / 0.01/step]
3-461-041	TonerSupply :DANC	PI:I Gain:CMY	ENG*	[0.0000 to 0.1000 / 0.0010 / 0.0001/step]
3-461-042	TonerSupply :DANC	PI:I Limits:Up:CMY	ENG*	[0.00 to 1.00 / 0.10 / 0.01/step]
3-461-043	TonerSupply :DANC	PI:I Limits:Low:CMY	ENG*	[0.00 to 1.00 / 0.10 / 0.01/step]

3.SP Mode Tables

SP No.	Large Category	Small Category	ENG or CTL	[Min to Max/Init./Step]
3-461-052	TonerSupply :DANC	AW:AWIpn:K	ENG*	[0 to 2000 / 1000 / 1/step]
3-461-062	TonerSupply :DANC	AW:AWIpn:CMY	ENG*	[0 to 2000 / 1000 / 1/step]
3-461-102	TonerSupply :DANC	PI:LineSpdCoef:MidSpd:K	ENG*	[0.05 to 1.00 / 0.50 / 0.01/step]
3-461-103	TonerSupply :DANC	PI:LineSpdCoef:LowSpd:K	ENG*	[0.05 to 1.00 / 0.50 / 0.01/step]
3-461-112	TonerSupply :DANC	PI:LineSpdCoef:StdSpd:CMY	ENG*	[0.05 to 1.00 / 0.50 / 0.01/step]
3-461-113	TonerSupply :DANC	PI:LineSpdCoef:LowSpd:CMY	ENG*	[0.05 to 1.00 / 0.50 / 0.01/step]
3-461-121	TonerSupply :DANC	SMITH:Gain:K	ENG*	[0.00 to 2.00 / 1.00 / 0.01/step]
3-461-122	TonerSupply :DANC	SMITH:MidSpd:K	ENG*	[0.00 to 1.00 / 1.00 / 0.01/step]
3-461-123	TonerSupply :DANC	SMITH:LowSpd:K	ENG*	[0.00 to 1.00 / 1.00 / 0.01/step]
3-461-131	TonerSupply :DANC	SMITH:Gain:CMY	ENG*	[0.00 to 2.00 / 1.00 / 0.01/step]
3-461-132	TonerSupply :DANC	SMITH:MidSpd:CMY	ENG*	[0.00 to 1.00 / 1.00 / 0.01/step]
3-461-133	TonerSupply :DANC	SMITH:LowSpd:CMY	ENG*	[0.00 to 1.00 / 1.00 / 0.01/step]

3.SP Mode Tables

SP No.	Large Category	Small Category	ENG or CTL	[Min to Max/Init./Step]
3-462-001	TonerSupply :DANC	ANC:Power	ENG*	[0 to 200 / 100 / 1%/step]
3-462-101	TonerSupply :DANC	ANC:Gain:K	ENG*	[0.00 to 2.00 / 1.00 / 0.01/step]
3-462-102	TonerSupply :DANC	ANC:MidSpd:K	ENG*	[0.05 to 1.00 / 1.00 / 0.01/step]
3-462-103	TonerSupply :DANC	ANC:LowSpd:K	ENG*	[0.05 to 1.00 / 1.00 / 0.01/step]
3-462-111	TonerSupply :DANC	ANC:Gain:CMY	ENG*	[0.00 to 2.00 / 1.00 / 0.01/step]
3-462-112	TonerSupply :DANC	ANC:MidSpd:CMY	ENG*	[0.05 to 1.00 / 1.00 / 0.01/step]
3-462-113	TonerSupply :DANC	ANC:LowSpd:CMY	ENG*	[0.05 to 1.00 / 1.00 / 0.01/step]
3-463-101	TonerSupply :DANC	Int:I:K	ENG*	[-1000.0000 to 1000.0000 / 0.0000 / 0.0001/step]
3-463-102	TonerSupply :DANC	Int:I:C	ENG*	[-1000.0000 to 1000.0000 / 0.0000 / 0.0001/step]
3-463-103	TonerSupply :DANC	Int:I:M	ENG*	[-1000.0000 to 1000.0000 / 0.0000 / 0.0001/step]
3-463-104	TonerSupply :DANC	Int:I:Y	ENG*	[-1000.0000 to 1000.0000 / 0.0000 / 0.0001/step]
3-463-111	TonerSupply :DANC	ANC:ref Sum:K	ENG*	[-1000.0000 to 1000.0000 / 0.0000 / 0.0001/step]

3.SP Mode Tables

SP No.	Large Category	Small Category	ENG or CTL	[Min to Max/Init./Step]
3-463-112	TonerSupply :DANC	ANC:ref Sum:C	ENG*	[-1000.0000 to 1000.0000 / 0.0000 / 0.0001/step]
3-463-113	TonerSupply :DANC	ANC:ref Sum:M	ENG*	[-1000.0000 to 1000.0000 / 0.0000 / 0.0001/step]
3-463-114	TonerSupply :DANC	ANC:ref Sum:Y	ENG*	[-1000.0000 to 1000.0000 / 0.0000 / 0.0001/step]
3-463-201	TonerSupply :DANC	ImgArea:K	ENG	[0 to 9999 / 0 / 1cm2/step]
3-463-202	TonerSupply :DANC	ImgArea:C	ENG	[0 to 9999 / 0 / 1cm2/step]
3-463-203	TonerSupply :DANC	ImgArea:M	ENG	[0 to 9999 / 0 / 1cm2/step]
3-463-204	TonerSupply :DANC	ImgArea:Y	ENG	[0 to 9999 / 0 / 1cm2/step]
3-500-001	ImgQtyAdj :ON/OFF	ALL	ENG*	[0 to 1 / 1 / 1/step]
3-500-002	ImgQtyAdj :ON/OFF	ProCon	ENG*	[0 to 1 / 1 / 1/step]
3-500-003	ImgQtyAdj :ON/OFF	MUSIC Condition:Auto Exe	ENG*	[0 to 1 / 1 / 1/step]
3-500-004	ImgQtyAdj :ON/OFF	Init TD Sensor	ENG*	[0 to 1 / 1 / 1/step]
3-500-006	ImgQtyAdj :ON/OFF	PresetSealWindup Exe	ENG*	[0 to 1 / 1 / 1/step]

3.SP Mode Tables

SP No.	Large Category	Small Category	ENG or CTL	[Min to Max/Init./Step]
3-500-012	ImgQltyAdj :ON/OFF	PresetSeal Pre-Windup Exe	ENG*	[0 to 1 / 1 / 1/step]
3-509-011	ImgQltyAdj :ModeSelect	ImgQltyAdj Mode Setting	ENG*	[0 to 2 / 0 / 1/step]
3-510-024	ImgQltyAdj :ExeFlag	MUSIC	ENG*	[0 to 3 / 0 / 1/step]
3-520-001	ImgQltyAdj :Interval	During Job	ENG*	[0 to 100 / 30 / 1pages/step]
3-520-002	ImgQltyAdj :Interval	During Stand-by	ENG*	[0 to 100 / 5 / 1minute/step]
3-521-001	Drum Stop Time :Disp	Year	ENG*	[0 to 99 / 0 / 1year/step]
3-521-002	Drum Stop Time :Disp	Month	ENG*	[1 to 12 / 1 / 1month/step]
3-521-003	Drum Stop Time :Disp	Day	ENG*	[1 to 31 / 1 / 1day/step]
3-521-004	Drum Stop Time :Disp	Hour	ENG*	[0 to 23 / 0 / 1hour/step]
3-521-005	Drum Stop Time :Disp	Minute	ENG*	[0 to 59 / 0 / 1minute/step]
3-521-011	Drum Stop Time :Disp	Year:Col	ENG*	[0 to 99 / 0 / 1year/step]
3-521-012	Drum Stop Time :Disp	Month:Col	ENG*	[1 to 12 / 1 / 1month/step]

3.SP Mode Tables

SP No.	Large Category	Small Category	ENG or CTL	[Min to Max/Init./Step]
3-521-013	Drum Stop Time :Disp	Day:Col	ENG*	[1 to 31 / 1 / 1day/step]
3-521-014	Drum Stop Time :Disp	Hour:Col	ENG*	[0 to 23 / 0 / 1hour/step]
3-521-015	Drum Stop Time :Disp	Minute:Col	ENG*	[0 to 59 / 0 / 1minute/step]
3-522-001	Drum Stop Environ :Disp	Temperature	ENG*	[-1280.0 to 1270.0 / 0.0 / 0.1deg/step]
3-522-002	Drum Stop Environ :Disp	Rel Humidity	ENG*	[0.0 to 1000.0 / 0.0 / 0.1%RH/step]
3-522-003	Drum Stop Environ :Disp	Abs Humidity	ENG*	[0.0 to 1000.0 / 0.0 / 0.1g/m3/step]
3-522-011	Drum Stop Environ :Disp	Temperature:Col	ENG*	[-1280.0 to 1270.0 / 0.0 / 0.1deg/step]
3-522-012	Drum Stop Environ :Disp	Rel Humidity:Col	ENG*	[0.0 to 1000.0 / 0.0 / 0.1%RH/step]
3-522-013	Drum Stop Environ :Disp	Abs Humidity:Col	ENG*	[0.0 to 1000.0 / 0.0 / 0.1g/m3/step]
3-529-001	ProCon Interval Control :Set	Gamma Corr	ENG*	[0 to 1 / 1 / 1/step]
3-529-002	ProCon Interval Control :Set	Environ Corr	ENG*	[0 to 1 / 1 / 1/step]
3-529-003	ProCon Interval Control :Set	AbsHum Threshold	ENG*	[0.0 to 99.0 / 4.3 / 0.1g/m3/step]

3.SP Mode Tables

SP No.	Large Category	Small Category	ENG or CTL	[Min to Max/Init./Step]
3-529-004	ProCon Interval Control :Set	Max Cnt Threshold	ENG*	[0 to 99 / 2 / 1counts/step]
3-529-005	ProCon Interval Control :Set	Exe Cnt	ENG	[0 to 255 / 0 / 1counts/step]
3-529-006	ProCon Interval Control :Set	Page Cnt:BW	ENG*	[0 to 5000 / 0 / 1sheets/step]
3-529-007	ProCon Interval Control :Set	Page Cnt:FC	ENG*	[0 to 5000 / 0 / 1sheets/step]
3-530-001	PowerON ProCon :Set	Non-use Time Setting	ENG*	[0 to 1440 / 360 / 1minute/step]
3-530-002	PowerON ProCon :Set	Temperature Range	ENG*	[0 to 99 / 10 / 1deg/step]
3-530-003	PowerON ProCon :Set	Relative Humidity Range	ENG*	[0 to 99 / 50 / 1%RH/step]
3-530-004	PowerON ProCon :Set	Absolute Humidity Range	ENG*	[0 to 99 / 6 / 1g/m3/step]
3-530-005	PowerON ProCon :Set	Interval:BW	ENG*	[0 to 5000 / 250 / 1sheets/step]
3-530-006	PowerON ProCon :Set	Interval:FC	ENG*	[0 to 5000 / 100 / 1sheets/step]
3-530-007	PowerON ProCon :Set	Page Cnt:BW	ENG*	[0 to 5000 / 0 / 1sheets/step]
3-530-008	PowerON ProCon :Set	Page Cnt:FC	ENG*	[0 to 5000 / 0 / 1sheets/step]

3.SP Mode Tables

SP No.	Large Category	Small Category	ENG or CTL	[Min to Max/Init./Step]
3-531-001	Non-useTime Procon :Set	Non-use Time Setting	ENG*	[0 to 1440 / 360 / 1minute/step]
3-531-002	Non-useTime Procon :Set	Temperature Range	ENG*	[0 to 99 / 10 / 1deg/step]
3-531-003	Non-useTime Procon :Set	Relative Humidity Range	ENG*	[0 to 99 / 50 / 1%RH/step]
3-531-004	Non-useTime Procon :Set	Absolute Humidity Range	ENG*	[0 to 99 / 6 / 1g/m3/step]
3-531-005	Non-useTime Procon :Set	Maximum Execution Number	ENG*	[0 to 99 / 10 / 1times/step]
3-533-001	Interrupt ProCon :Set	Interval:Set:BW	ENG*	[0 to 5000 / 500 / 1sheets/step]
3-533-002	Interrupt ProCon :Set	Interval:Disp:BW	ENG*	[0 to 5000 / 500 / 1sheets/step]
3-533-003	Interrupt ProCon :Set	Corr(Short):BW	ENG*	[0.00 to 1.00 / 1.00 / 0.01/step]
3-533-004	Interrupt ProCon :Set	Corr(Mid):BW	ENG*	[0.00 to 1.00 / 1.00 / 0.01/step]
3-533-011	Interrupt ProCon :Set	Interval:Set:FC	ENG*	[0 to 5000 / 200 / 1sheets/step]
3-533-012	Interrupt ProCon :Set	Interval:Disp:FC	ENG*	[0 to 5000 / 200 / 1sheets/step]
3-533-013	Interrupt ProCon :Set	Corr(Short):FC	ENG*	[0.00 to 1.00 / 1.00 / 0.01/step]

3.SP Mode Tables

SP No.	Large Category	Small Category	ENG or CTL	[Min to Max/Init./Step]
3-533-014	Interrupt ProCon :Set	Corr(Mid):FC	ENG*	[0.00 to 1.00 / 1.00 / 0.01/step]
3-534-001	JobEnd ProCon :Set	Interval:Set:BW	ENG*	[0 to 5000 / 500 / 1sheets/step]
3-534-002	JobEnd ProCon :Set	Interval:Disp:BW	ENG*	[0 to 5000 / 500 / 1sheets/step]
3-534-003	JobEnd ProCon :Set	Corr(Short):BW	ENG*	[0.00 to 1.00 / 1.00 / 0.01/step]
3-534-004	JobEnd ProCon :Set	Corr(Mid):BW	ENG*	[0.00 to 1.00 / 1.00 / 0.01/step]
3-534-011	JobEnd ProCon :Set	Interval:Set:FC	ENG*	[0 to 1000 / 200 / 1sheets/step]
3-534-012	JobEnd ProCon :Set	Interval:Disp:FC	ENG*	[0 to 5000 / 200 / 1sheets/step]
3-534-013	JobEnd ProCon :Set	Corr(Short):FC	ENG*	[0.00 to 1.00 / 1.00 / 0.01/step]
3-534-014	JobEnd ProCon :Set	Corr(Mid):FC	ENG*	[0.00 to 1.00 / 1.00 / 0.01/step]
3-539-001	Dev Agitating Time :Set	Time	ENG*	[0 to 3000 / 10 / 1sec/step]
3-539-010	Dev Agitating Time :Set	ON/OFF(by AbsHum)	ENG*	[0 to 1 / 1 / 1/step]
3-539-011	Dev Agitating Time :Set	by AbsHum:1	ENG*	[0 to 3000 / 0 / 1sec/step]

3.SP Mode Tables

SP No.	Large Category	Small Category	ENG or CTL	[Min to Max/Init./Step]
3-539-012	Dev Agitating Time :Set	by AbsHum:2	ENG*	[0 to 3000 / 5 / 1sec/step]
3-539-013	Dev Agitating Time :Set	by AbsHum:3	ENG*	[0 to 3000 / 5 / 1sec/step]
3-539-014	Dev Agitating Time :Set	by AbsHum:4	ENG*	[0 to 3000 / 5 / 1sec/step]
3-539-015	Dev Agitating Time :Set	by AbsHum:5	ENG*	[0 to 3000 / 5 / 1sec/step]
3-539-016	Dev Agitating Time :Set	by AbsHum:6	ENG*	[0 to 3000 / 5 / 1sec/step]
3-539-021	Dev Agitating Time :Set	AbsHum Threshold:1	ENG*	[0 to 100 / 4 / 1g/cm3/step]
3-539-022	Dev Agitating Time :Set	AbsHum Threshold:2	ENG*	[0 to 100 / 8 / 1g/cm3/step]
3-539-023	Dev Agitating Time :Set	AbsHum Threshold:3	ENG*	[0 to 100 / 12 / 1g/cm3/step]
3-539-024	Dev Agitating Time :Set	AbsHum Threshold:4	ENG*	[0 to 100 / 16 / 1g/cm3/step]
3-539-025	Dev Agitating Time :Set	AbsHum Threshold:5	ENG*	[0 to 100 / 24 / 1g/cm3/step]
3-539-030	Dev Agitating Time :Set	ON/OFF(by Non-use Time)	ENG*	[0 to 1 / 1 / 1/step]
3-539-050	Dev Agitating Time :Set	ON/OFF(by Non-use Time)	ENG*	[0 to 1 / 1 / 1/step]

3.SP Mode Tables

SP No.	Large Category	Small Category	ENG or CTL	[Min to Max/Init./Step]
3-539-051	Dev Agitating Time :Set	by DotCoverage :1	ENG*	[0 to 3000 / 0 / 1sec/step]
3-539-052	Dev Agitating Time :Set	by DotCoverage :2	ENG*	[0 to 3000 / 0 / 1sec/step]
3-539-053	Dev Agitating Time :Set	by DotCoverage :3	ENG*	[0 to 3000 / 5 / 1sec/step]
3-539-054	Dev Agitating Time :Set	by DotCoverage :4	ENG*	[0 to 3000 / 5 / 1sec/step]
3-539-055	Dev Agitating Time :Set	by DotCoverage :5	ENG*	[0 to 3000 / 5 / 1sec/step]
3-539-056	Dev Agitating Time :Set	by DotCoverage :6	ENG*	[0 to 3000 / 5 / 1sec/step]
3-539-061	Dev Agitating Time :Set	DotCoverage Threshold:1	ENG*	[0 to 5000 / 10 / 1%/step]
3-539-062	Dev Agitating Time :Set	DotCoverage Threshold:2	ENG*	[0 to 5000 / 20 / 1%/step]
3-539-063	Dev Agitating Time :Set	DotCoverage Threshold:3	ENG*	[0 to 5000 / 30 / 1%/step]
3-539-064	Dev Agitating Time :Set	DotCoverage Threshold:4	ENG*	[0 to 5000 / 40 / 1%/step]
3-539-065	Dev Agitating Time :Set	DotCoverage Threshold:5	ENG*	[0 to 5000 / 50 / 1%/step]
3-539-099	Dev Agitating Time :Set	UpperLimit	ENG*	[0 to 3600 / 30 / 1sec/step]

3.SP Mode Tables

SP No.	Large Category	Small Category	ENG or CTL	[Min to Max/Init./Step]
3-541-001	Music Interval :Set	Page Cnt:BW	ENG*	[0 to 5000 / 0 / 1sheets/step]
3-541-002	Music Interval :Set	Page Cnt:FC	ENG*	[0 to 5000 / 0 / 1sheets/step]
3-541-004	Music Interval :Set	Distance Cnt:BW	ENG*	[0 to 64999 / 0 / 1mm/step]
3-541-005	Music Interval :Set	Distance Cnt:FC	ENG*	[0 to 64999 / 0 / 1mm/step]
3-550-001	Refresh Mode	Required Area: K	ENG*	[0 to 65535 / 0 / 1cm ² /step]
3-550-002	Refresh Mode	Required Area: C	ENG*	[0 to 65535 / 0 / 1cm ² /step]
3-550-003	Refresh Mode	Required Area: M	ENG*	[0 to 65535 / 0 / 1cm ² /step]
3-550-004	Refresh Mode	Required Area: Y	ENG*	[0 to 65535 / 0 / 1cm ² /step]
3-550-011	Refresh Mode	Dev. Unit Rotation: Display: Bk	ENG*	[0.0 to 1000.0 / 0.0 / 0.1m/step]
3-550-012	Refresh Mode	Dev. Unit Rotation: Display: C	ENG*	[0.0 to 1000.0 / 0.0 / 0.1m/step]
3-550-013	Refresh Mode	Dev. Unit Rotation: Display: M	ENG*	[0.0 to 1000.0 / 0.0 / 0.1m/step]
3-550-014	Refresh Mode	Dev. Unit Rotation: Display: Y	ENG*	[0.0 to 1000.0 / 0.0 / 0.1m/step]

3.SP Mode Tables

SP No.	Large Category	Small Category	ENG or CTL	[Min to Max/Init./Step]
3-550-031	Refresh Mode	Refresh Threshold: Bk	ENG*	[0 to 255 / 17 / 1cm ² /step]
3-550-032	Refresh Mode	Refresh Threshold: C	ENG*	[0 to 255 / 17 / 1cm ² /step]
3-550-033	Refresh Mode	Refresh Threshold: M	ENG*	[0 to 255 / 17 / 1cm ² /step]
3-550-034	Refresh Mode	Refresh Threshold: Y	ENG*	[0 to 255 / 17 / 1cm ² /step]
3-550-041	Refresh Mode	Job End Area Coefficient:K	ENG*	[0.1 to 25.5 / 1.0 / 0.1/step]
3-550-042	Refresh Mode	Job End Vb Coefficient:K	ENG*	[0 to 100 / 40 / 1%/step]
3-550-043	Refresh Mode	Job End Length:K	ENG*	[0 to 255 / 25 / 1mm/step]
3-550-044	Refresh Mode	Job End Supply	ENG*	[0.000 to 1.000 / 0.000 / 0.001mg/cm ² /step]
3-550-045	Refresh Mode	Job End Area Coefficient:YMC	ENG*	[0.1 to 25.5 / 1.0 / 0.1/step]
3-550-046	Refresh Mode	Job End Vb Coefficient:YMC	ENG*	[0 to 100 / 40 / 1%/step]
3-550-047	Refresh Mode	Job End Length:YMC	ENG*	[0 to 255 / 25 / 1mm/step]
3-550-050	Refresh Mode	Threshold	ENG*	IM C6000: [0 to 65535 / 3400 / 1cm ² /step]

3.SP Mode Tables

SP No.	Large Category	Small Category	ENG or CTL	[Min to Max/Init./Step]
				IM C5500: [0 to 65535 / 3400 / 1cm ² /step] IM C4500: [0 to 65535 / 3400 / 1cm ² /step]
3-550-081	Refresh Mode	TC Adj. Consume(Upp Limit)	ENG*	[0 to 255 / 0 / 1times/step]
3-553-001	Transfer belt cleaning	TransferIdleTime Temperature:H	ENG*	[0.0 to 3.0 / 0.0 / 0.1revolutions/step]
3-553-002	Transfer belt cleaning	TransferIdleTime Temperature:M	ENG*	[0.0 to 3.0 / 0.0 / 0.1revolutions/step]
3-553-003	Transfer belt cleaning	TransferIdleTime Temperature:L	ENG*	[0.0 to 3.0 / 0.0 / 0.1revolutions/step]
3-553-004	Transfer belt cleaning	TransferIdleTime Temperature:L:ON	ENG*	[0.0 to 3.0 / 0.0 / 0.1revolutions/step]
3-553-005	Transfer belt cleaning	Temperature Threshold:T2	ENG*	[20 to 30 / 25 / 1deg/step]
3-553-006	Transfer belt cleaning	Temperature Threshold:T1	ENG*	[0 to 15 / 15 / 1deg/step]
3-553-007	Transfer belt cleaning	Temperature Threshold:T3	ENG*	[0 to 30 / 5 / 1deg/step]
3-553-008	Transfer belt cleaning	TransferIdleTime Rotation :Initial	ENG*	[0.0 to 3.0 / 0.0 / 0.1revolutions/step]
3-553-009	Transfer belt cleaning	TransferIdleTime Rotation :Middle	ENG*	[0.0 to 3.0 / 0.0 / 0.1revolutions/step]

3.SP Mode Tables

SP No.	Large Category	Small Category	ENG or CTL	[Min to Max/Init./Step]
3-553-010	Transfer belt cleaning	TransferIdleTime Rotation :End	ENG*	[0.0 to 3.0 / 0.0 / 0.1revolutions/step]
3-553-011	Transfer belt cleaning	Transfer Rotation Threshold:L1	ENG*	[0 to 999999999 / 24000000 / 1mm/step]
3-553-012	Transfer belt cleaning	Transfer Rotation Threshold:L2	ENG*	[0 to 999999999 / 96000000 / 1mm/step]
3-555-001	ImageQuality Adj. Counter:Disp	Charge AC Control	ENG*	[0 to 2000 / 0 / 1page/step]
3-600-001	Select ProCon	Potential Control	ENG*	[0 to 1 / 1 / 1/step]
3-600-002	Select ProCon	LD Control	ENG*	[0 to 3 / 1 / 1/step]
3-600-003	Select ProCon	TC Adj. Mode	ENG*	[0 to 4 / 4 / 1/step]
3-600-004	Select ProCon	ACC Before ProCon	ENG*	[0 to 3 / 2 / 1/step]
3-600-010	Select ProCon	ActivePotentialControl	ENG*	[0 to 1 / 1 / 1/step]
3-600-030	Select ProCon	IBACC:ON/OFF	ENG*	[0 to 1 / 1 / 1/step]
3-600-060	Select ProCon	Vsg ITB Internal Circumference Correction	ENG*	IM C6000: [0 to 1 / 1 / 1/step] IM C5500: [0 to 1 / 1 / 1/step] IM C4500: [0 to 1 / 1 / 1/step]

3.SP Mode Tables

SP No.	Large Category	Small Category	ENG or CTL	[Min to Max/Init./Step]
3-610-001	Chrg AC Control	Std Speed: K	ENG*	[0.00 to 3.00 / 2.20 / 0.01kV/step]
3-610-002	Chrg AC Control	Std Speed: C	ENG*	[0.00 to 3.00 / 2.20 / 0.01kV/step]
3-610-003	Chrg AC Control	Std Speed: M	ENG*	[0.00 to 3.00 / 2.20 / 0.01kV/step]
3-610-004	Chrg AC Control	Std Speed: Y	ENG*	[0.00 to 3.00 / 2.20 / 0.01kV/step]
3-611-001	Chrg DC Control	Std Speed: K	ENG*	[300 to 1000 / 690 / 1-V/step]
3-611-002	Chrg DC Control	Std Speed: C	ENG*	[300 to 1000 / 690 / 1-V/step]
3-611-003	Chrg DC Control	Std Speed: M	ENG*	[300 to 1000 / 690 / 1-V/step]
3-611-004	Chrg DC Control	Std Speed: Y	ENG*	[300 to 1000 / 690 / 1-V/step]
3-611-011	Chrg DC Control	Mid Speed: K	ENG*	[300 to 1000 / 690 / 1-V/step]
3-611-012	Chrg DC Control	Mid Speed: C	ENG*	[300 to 1000 / 690 / 1-V/step]
3-611-013	Chrg DC Control	Mid Speed: M	ENG*	[300 to 1000 / 690 / 1-V/step]
3-611-014	Chrg DC Control	Mid Speed: Y	ENG*	[300 to 1000 / 690 / 1-V/step]

3.SP Mode Tables

SP No.	Large Category	Small Category	ENG or CTL	[Min to Max/Init./Step]
3-611-021	Chrg DC Control	Low Speed: K	ENG*	[300 to 1000 / 690 / 1-V/step]
3-611-022	Chrg DC Control	Low Speed: C	ENG*	[300 to 1000 / 690 / 1-V/step]
3-611-023	Chrg DC Control	Low Speed: M	ENG*	[300 to 1000 / 690 / 1-V/step]
3-611-024	Chrg DC Control	Low Speed: Y	ENG*	[300 to 1000 / 690 / 1-V/step]
3-611-201	Chrg DC Control	Now:Std Speed: K	ENG	[300 to 1000 / 690 / 1-V/step]
3-611-202	Chrg DC Control	Now:Std Speed: C	ENG	[300 to 1000 / 690 / 1-V/step]
3-611-203	Chrg DC Control	Now:Std Speed: M	ENG	[300 to 1000 / 690 / 1-V/step]
3-611-204	Chrg DC Control	Now:Std Speed: Y	ENG	[300 to 1000 / 690 / 1-V/step]
3-611-211	Chrg DC Control	Now:Mid Speed: K	ENG	[300 to 1000 / 690 / 1-V/step]
3-611-212	Chrg DC Control	Now:Mid Speed: C	ENG	[300 to 1000 / 690 / 1-V/step]
3-611-213	Chrg DC Control	Now:Mid Speed: M	ENG	[300 to 1000 / 690 / 1-V/step]
3-611-214	Chrg DC Control	Now:Mid Speed: Y	ENG	[300 to 1000 / 690 / 1-V/step]

3.SP Mode Tables

SP No.	Large Category	Small Category	ENG or CTL	[Min to Max/Init./Step]
3-611-221	Chrg DC Control	Now:Low Speed: K	ENG	[300 to 1000 / 690 / 1-V/step]
3-611-222	Chrg DC Control	Now:Low Speed: C	ENG	[300 to 1000 / 690 / 1-V/step]
3-611-223	Chrg DC Control	Now:Low Speed: M	ENG	[300 to 1000 / 690 / 1-V/step]
3-611-224	Chrg DC Control	Now:Low Speed: Y	ENG	[300 to 1000 / 690 / 1-V/step]
3-612-001	Dev DC Control	Std Speed: K	ENG*	[200 to 800 / 550 / 1-V/step]
3-612-002	Dev DC Control	Std Speed: C	ENG*	[200 to 800 / 550 / 1-V/step]
3-612-003	Dev DC Control	Std Speed: M	ENG*	[200 to 800 / 550 / 1-V/step]
3-612-004	Dev DC Control	Std Speed: Y	ENG*	[200 to 800 / 550 / 1-V/step]
3-612-011	Dev DC Control	Mid Speed: K	ENG*	[200 to 800 / 550 / 1-V/step]
3-612-012	Dev DC Control	Mid Speed: C	ENG*	[200 to 800 / 550 / 1-V/step]
3-612-013	Dev DC Control	Mid Speed: M	ENG*	[200 to 800 / 550 / 1-V/step]
3-612-014	Dev DC Control	Mid Speed: Y	ENG*	[200 to 800 / 550 / 1-V/step]

3.SP Mode Tables

SP No.	Large Category	Small Category	ENG or CTL	[Min to Max/Init./Step]
3-612-021	Dev DC Control	Low Speed: K	ENG*	[200 to 800 / 550 / 1-V/step]
3-612-022	Dev DC Control	Low Speed: C	ENG*	[200 to 800 / 550 / 1-V/step]
3-612-023	Dev DC Control	Low Speed: M	ENG*	[200 to 800 / 550 / 1-V/step]
3-612-024	Dev DC Control	Low Speed: Y	ENG*	[200 to 800 / 550 / 1-V/step]
3-612-120	Dev DC Control	Set:Vb Limit	ENG*	[0 to 500 / 50 / 1V/step]
3-612-123	Dev DC Control	Set:Page Thresh_K	ENG*	[0 to 999999 / 35000 / 1page/step]
3-612-124	Dev DC Control	Set:Page Thresh_C	ENG*	[0 to 999999 / 35000 / 1page/step]
3-612-125	Dev DC Control	Set:Page Thresh_M	ENG*	[0 to 999999 / 35000 / 1page/step]
3-612-126	Dev DC Control	Set:Page Thresh_Y	ENG*	[0 to 999999 / 35000 / 1page/step]
3-612-131	Dev DC Control	Set:Upper Vb Current:K	ENG*	[0 to 800 / 600 / 1V/step]
3-612-132	Dev DC Control	Set:Upper Vb Current:C	ENG*	[0 to 800 / 600 / 1V/step]
3-612-133	Dev DC Control	Set:Upper Vb Current:M	ENG*	[0 to 800 / 600 / 1V/step]

3.SP Mode Tables

SP No.	Large Category	Small Category	ENG or CTL	[Min to Max/Init./Step]
3-612-134	Dev DC Control	Set:Upper Vb Current:Y	ENG*	[0 to 800 / 600 / 1V/step]
3-612-141	Dev DC Control	Set:Limit TC1_K	ENG*	[1.0 to 15.0 / 6.5 / 0.1wt%/step]
3-612-142	Dev DC Control	Set:Limit TC1_C	ENG*	[1.0 to 15.0 / 6.5 / 0.1wt%/step]
3-612-143	Dev DC Control	Set:Limit TC1_M	ENG*	[1.0 to 15.0 / 6.5 / 0.1wt%/step]
3-612-144	Dev DC Control	Set:Limit TC1_Y	ENG*	[1.0 to 15.0 / 6.5 / 0.1wt%/step]
3-612-151	Dev DC Control	Set:Limit TC2_K	ENG*	[1.0 to 15.0 / 7.0 / 0.1wt%/step]
3-612-152	Dev DC Control	Set:Limit TC2_C	ENG*	[1.0 to 15.0 / 7.0 / 0.1wt%/step]
3-612-153	Dev DC Control	Set:Limit TC2_M	ENG*	[1.0 to 15.0 / 7.0 / 0.1wt%/step]
3-612-154	Dev DC Control	Set:Limit TC2_Y	ENG*	[1.0 to 15.0 / 7.0 / 0.1wt%/step]
3-612-201	Dev DC Control	Now:Std Speed: K	ENG	[200 to 800 / 690 / 1-V/step]
3-612-202	Dev DC Control	Now:Std Speed: C	ENG	[200 to 800 / 690 / 1-V/step]
3-612-203	Dev DC Control	Now:Std Speed: M	ENG	[200 to 800 / 690 / 1-V/step]

3.SP Mode Tables

SP No.	Large Category	Small Category	ENG or CTL	[Min to Max/Init./Step]
3-612-204	Dev DC Control	Now:Std Speed: Y	ENG	[200 to 800 / 690 / 1-V/step]
3-612-211	Dev DC Control	Now:Mid Speed: K	ENG	[200 to 800 / 690 / 1-V/step]
3-612-212	Dev DC Control	Now:Mid Speed: C	ENG	[200 to 800 / 690 / 1-V/step]
3-612-213	Dev DC Control	Now:Mid Speed: M	ENG	[200 to 800 / 690 / 1-V/step]
3-612-214	Dev DC Control	Now:Mid Speed: Y	ENG	[200 to 800 / 690 / 1-V/step]
3-612-221	Dev DC Control	Now:Low Speed: K	ENG	[200 to 800 / 690 / 1-V/step]
3-612-222	Dev DC Control	Now:Low Speed: C	ENG	[200 to 800 / 690 / 1-V/step]
3-612-223	Dev DC Control	Now:Low Speed: M	ENG	[200 to 800 / 690 / 1-V/step]
3-612-224	Dev DC Control	Now:Low Speed: Y	ENG	[200 to 800 / 690 / 1-V/step]
3-613-001	LD Power Control	Std Speed: K	ENG*	[0 to 200 / 100 / 1%/step]
3-613-002	LD Power Control	Std Speed: C	ENG*	[0 to 200 / 100 / 1%/step]
3-613-003	LD Power Control	Std Speed: M	ENG*	[0 to 200 / 100 / 1%/step]

3.SP Mode Tables

SP No.	Large Category	Small Category	ENG or CTL	[Min to Max/Init./Step]
3-613-004	LD Power Control	Std Speed: Y	ENG*	[0 to 200 / 100 / 1%/step]
3-613-011	LD Power Control	Mid Speed: K	ENG*	[0 to 200 / 100 / 1%/step]
3-613-012	LD Power Control	Mid Speed: C	ENG*	[0 to 200 / 100 / 1%/step]
3-613-013	LD Power Control	Mid Speed: M	ENG*	[0 to 200 / 100 / 1%/step]
3-613-014	LD Power Control	Mid Speed: Y	ENG*	[0 to 200 / 100 / 1%/step]
3-613-021	LD Power Control	Low Speed: K	ENG*	[0 to 200 / 100 / 1%/step]
3-613-022	LD Power Control	Low Speed: C	ENG*	[0 to 200 / 100 / 1%/step]
3-613-023	LD Power Control	Low Speed: M	ENG*	[0 to 200 / 100 / 1%/step]
3-613-024	LD Power Control	Low Speed: Y	ENG*	[0 to 200 / 100 / 1%/step]
3-613-101	LD Power Control	PrcsCntrlCorrect:K	ENG*	[0 to 200 / 140 / 1%/step]
3-613-102	LD Power Control	PrcsCntrlCorrect:C	ENG*	[0 to 200 / 140 / 1%/step]
3-613-103	LD Power Control	PrcsCntrlCorrect:M	ENG*	[0 to 200 / 140 / 1%/step]

3.SP Mode Tables

SP No.	Large Category	Small Category	ENG or CTL	[Min to Max/Init./Step]
3-613-104	LD Power Control	PrCsCntrlCorrect:Y	ENG*	[0 to 200 / 140 / 1%/step]
3-613-201	LD Power Control	Now:Std Speed: K	ENG	[0 to 200 / 100 / 1%/step]
3-613-202	LD Power Control	Now:Std Speed: C	ENG	[0 to 200 / 100 / 1%/step]
3-613-203	LD Power Control	Now:Std Speed: M	ENG	[0 to 200 / 100 / 1%/step]
3-613-204	LD Power Control	Now:Std Speed: Y	ENG	[0 to 200 / 100 / 1%/step]
3-613-211	LD Power Control	Now:Mid Speed: K	ENG	[0 to 200 / 100 / 1%/step]
3-613-212	LD Power Control	Now:Mid Speed: C	ENG	[0 to 200 / 100 / 1%/step]
3-613-213	LD Power Control	Now:Mid Speed: M	ENG	[0 to 200 / 100 / 1%/step]
3-613-214	LD Power Control	Now:Mid Speed: Y	ENG	[0 to 200 / 100 / 1%/step]
3-613-221	LD Power Control	Now:Low Speed: K	ENG	[0 to 200 / 100 / 1%/step]
3-613-222	LD Power Control	Now:Low Speed: C	ENG	[0 to 200 / 100 / 1%/step]
3-613-223	LD Power Control	Now:Low Speed: M	ENG	[0 to 200 / 100 / 1%/step]

3.SP Mode Tables

SP No.	Large Category	Small Category	ENG or CTL	[Min to Max/Init./Step]
3-613-224	LD Power Control	Now:Low Speed: Y	ENG	[0 to 200 / 100 / 1%/step]
3-619-011	Bias:Spd Corr	VbCoef:Mid Spd: K	ENG*	[0.50 to 1.50 / 1.00 / 0.01/step]
3-619-012	Bias:Spd Corr	VbCoef:Mid Spd: C	ENG*	[0.50 to 1.50 / 1.00 / 0.01/step]
3-619-013	Bias:Spd Corr	VbCoef:Mid Spd: M	ENG*	[0.50 to 1.50 / 1.00 / 0.01/step]
3-619-014	Bias:Spd Corr	VbCoef:Mid Spd: Y	ENG*	[0.50 to 1.50 / 1.00 / 0.01/step]
3-619-021	Bias:Spd Corr	VbCoef:Low Spd: K	ENG*	[0.50 to 1.50 / 1.00 / 0.01/step]
3-619-022	Bias:Spd Corr	VbCoef:Low Spd: C	ENG*	[0.50 to 1.50 / 1.00 / 0.01/step]
3-619-023	Bias:Spd Corr	VbCoef:Low Spd: M	ENG*	[0.50 to 1.50 / 1.00 / 0.01/step]
3-619-024	Bias:Spd Corr	VbCoef:Low Spd: Y	ENG*	[0.50 to 1.50 / 1.00 / 0.01/step]
3-619-051	Bias:Spd Corr	Offset: Std Spd: K	ENG*	[-128 to 127 / 39 / 1V/step]
3-619-052	Bias:Spd Corr	Offset: Std Spd: C	ENG*	[-128 to 127 / 39 / 1V/step]
3-619-053	Bias:Spd Corr	Offset: Std Spd: M	ENG*	[-128 to 127 / 39 / 1V/step]

3.SP Mode Tables

SP No.	Large Category	Small Category	ENG or CTL	[Min to Max/Init./Step]
3-619-054	Bias:Spd Corr	Offset: Std Spd: Y	ENG*	[-128 to 127 / 39 / 1V/step]
3-619-061	Bias:Spd Corr	Offset: Mid Spd: K	ENG*	[-128 to 127 / 39 / 1V/step]
3-619-062	Bias:Spd Corr	Offset: Mid Spd: C	ENG*	[-128 to 127 / 39 / 1V/step]
3-619-063	Bias:Spd Corr	Offset: Mid Spd: M	ENG*	[-128 to 127 / 39 / 1V/step]
3-619-064	Bias:Spd Corr	Offset: Mid Spd: Y	ENG*	[-128 to 127 / 39 / 1V/step]
3-619-071	Bias:Spd Corr	Offset: Low Spd: K	ENG*	[-128 to 127 / 39 / 1V/step]
3-619-072	Bias:Spd Corr	Offset: Low Spd: C	ENG*	[-128 to 127 / 39 / 1V/step]
3-619-073	Bias:Spd Corr	Offset: Low Spd: M	ENG*	[-128 to 127 / 39 / 1V/step]
3-619-074	Bias:Spd Corr	Offset: Low Spd: Y	ENG*	[-128 to 127 / 39 / 1V/step]
3-620-001	ProCon Target M/A	Maximum M/A:K	ENG*	[0.250 to 0.750 / 0.370 / 0.001mg/cm2/step]
3-620-002	ProCon Target M/A	Maximum M/A:C	ENG*	[0.250 to 0.750 / 0.400 / 0.001mg/cm2/step]
3-620-003	ProCon Target M/A	Maximum M/A:M	ENG*	[0.250 to 0.750 / 0.450 / 0.001mg/cm2/step]

3.SP Mode Tables

SP No.	Large Category	Small Category	ENG or CTL	[Min to Max/Init./Step]
3-620-004	ProCon Target M/A	Maximum M/A:Y	ENG*	[0.250 to 0.750 / 0.400 / 0.001mg/cm2/step]
3-622-001	Dev Pot :Set	Current:K	ENG*	[0 to 800 / 0 / 1V/step]
3-622-002	Dev Pot :Set	Current:C	ENG*	[0 to 800 / 0 / 1V/step]
3-622-003	Dev Pot :Set	Current:M	ENG*	[0 to 800 / 0 / 1V/step]
3-622-004	Dev Pot :Set	Current:Y	ENG*	[0 to 800 / 0 / 1V/step]
3-622-011	Dev Pot :Set	Current:F_K	ENG	[0 to 800 / 0 / 1V/step]
3-622-012	Dev Pot :Set	Current:F_C	ENG	[0 to 800 / 0 / 1V/step]
3-622-013	Dev Pot :Set	Current:F_M	ENG	[0 to 800 / 0 / 1V/step]
3-622-014	Dev Pot :Set	Current:F_Y	ENG	[0 to 800 / 0 / 1V/step]
3-622-021	Dev Pot :Set	Current:C_K	ENG	[0 to 800 / 0 / 1V/step]
3-622-022	Dev Pot :Set	Current:C_C	ENG	[0 to 800 / 0 / 1V/step]
3-622-023	Dev Pot :Set	Current:C_M	ENG	[0 to 800 / 0 / 1V/step]

3.SP Mode Tables

SP No.	Large Category	Small Category	ENG or CTL	[Min to Max/Init./Step]
3-622-024	Dev Pot :Set	Current:C_Y	ENG	[0 to 800 / 0 / 1V/step]
3-622-031	Dev Pot :Set	Current:R_K	ENG	[0 to 800 / 0 / 1V/step]
3-622-032	Dev Pot :Set	Current:R_C	ENG	[0 to 800 / 0 / 1V/step]
3-622-033	Dev Pot :Set	Current:R_M	ENG	[0 to 800 / 0 / 1V/step]
3-622-034	Dev Pot :Set	Current:R_Y	ENG	[0 to 800 / 0 / 1V/step]
3-622-051	Dev Pot :Set	UpperLimit	ENG*	[400 to 800 / 700 / 1V/step]
3-622-052	Dev Pot :Set	UpperLimit	ENG*	[400 to 800 / 700 / 1V/step]
3-622-053	Dev Pot :Set	UpperLimit	ENG*	[400 to 800 / 700 / 1V/step]
3-622-054	Dev Pot :Set	UpperLimit	ENG*	[400 to 800 / 700 / 1V/step]
3-622-061	Dev Pot :Set	LowerLimit	ENG*	[0 to 400 / 200 / 1V/step]
3-622-062	Dev Pot :Set	LowerLimit	ENG*	[0 to 400 / 200 / 1V/step]
3-622-063	Dev Pot :Set	LowerLimit	ENG*	[0 to 400 / 200 / 1V/step]

3.SP Mode Tables

SP No.	Large Category	Small Category	ENG or CTL	[Min to Max/Init./Step]
3-622-064	Dev Pot :Set	LowerLimit	ENG*	[0 to 400 / 200 / 1V/step]
3-622-101	Dev DC Spd Correct:Set	Target:K	ENG*	[0 to 800 / 0 / 1V/step]
3-622-102	Dev DC Spd Correct:Set	Target:C	ENG*	[0 to 800 / 0 / 1V/step]
3-622-103	Dev DC Spd Correct:Set	Target:M	ENG*	[0 to 800 / 0 / 1V/step]
3-622-104	Dev DC Spd Correct:Set	Target:Y	ENG*	[0 to 800 / 0 / 1V/step]
3-622-111	Dev DC Spd Correct:Set	Target Corr:K	ENG*	[-128 to 127 / 0 / 1/step]
3-622-112	Dev DC Spd Correct:Set	Target Corr:C	ENG*	[-128 to 127 / 0 / 1/step]
3-622-113	Dev DC Spd Correct:Set	Target Corr:M	ENG*	[-128 to 127 / 0 / 1/step]
3-622-114	Dev DC Spd Correct:Set	Target Corr:Y	ENG*	[-128 to 127 / 0 / 1/step]
3-622-121	Dev DC Spd Correct:Set	Vk:Upper_K	ENG*	[0 to 255 / 30 / 1-V/step]
3-622-122	Dev DC Spd Correct:Set	Vk:Upper_C	ENG*	[0 to 255 / 30 / 1-V/step]
3-622-123	Dev DC Spd Correct:Set	Vk:Upper_M	ENG*	[0 to 255 / 30 / 1-V/step]

3.SP Mode Tables

SP No.	Large Category	Small Category	ENG or CTL	[Min to Max/Init./Step]
3-622-124	Dev DC Spd Correct:Set	Vk:Upper_Y	ENG*	[0 to 255 / 30 / 1-V/step]
3-622-131	Dev DC Spd Correct:Set	Vk:Lower_K	ENG*	[-128 to 0 / -90 / 1-V/step]
3-622-132	Dev DC Spd Correct:Set	Vk:Lower_C	ENG*	[-128 to 0 / -60 / 1-V/step]
3-622-133	Dev DC Spd Correct:Set	Vk:Lower_M	ENG*	[-128 to 0 / -60 / 1-V/step]
3-622-134	Dev DC Spd Correct:Set	Vk:Lower_Y	ENG*	[-128 to 0 / -10 / 1-V/step]
3-623-001	LD Power :Set	Std Speed Slope:K	ENG*	IM C6000: [-1000 to 1000 / 233 / 1/step] IM C5500: [-1000 to 1000 / 233 / 1/step] IM C4500: [-1000 to 1000 / 221 / 1/step]
3-623-002	LD Power :Set	Std Speed Slope:C	ENG*	IM C6000: [-1000 to 1000 / 233 / 1/step] IM C5500: [-1000 to 1000 / 233 / 1/step] IM C4500: [-1000 to 1000 / 221 / 1/step]
3-623-003	LD Power :Set	Std Speed Slope:M	ENG*	IM C6000: [-1000 to 1000 / 233 / 1/step]

3.SP Mode Tables

SP No.	Large Category	Small Category	ENG or CTL	[Min to Max/Init./Step]
				IM C5500: [-1000 to 1000 / 233 / 1/step] IM C4500: [-1000 to 1000 / 221 / 1/step]
3-623-004	LD Power :Set	Std Speed Slope:Y	ENG*	IM C6000: [-1000 to 1000 / 233 / 1/step] IM C5500: [-1000 to 1000 / 233 / 1/step] IM C4500: [-1000 to 1000 / 221 / 1/step]
3-623-011	LD Power :Set	Std Speed intercept:K	ENG*	IM C6000: [-1000 to 1000 / -18 / 1/step] IM C5500: [-1000 to 1000 / -18 / 1/step] IM C4500: [-1000 to 1000 / -15 / 1/step]
3-623-012	LD Power :Set	Std Speed intercept:C	ENG*	IM C6000: [-1000 to 1000 / -18 / 1/step] IM C5500: [-1000 to 1000 / -18 / 1/step] IM C4500: [-1000 to 1000 / -15 / 1/step]
3-623-013	LD Power :Set	Std Speed intercept:M	ENG*	IM C6000: [-1000 to 1000 / -18 / 1/step]

SP No.	Large Category	Small Category	ENG or CTL	[Min to Max/Init./Step]
				IM C5500: [-1000 to 1000 / -18 / 1/step] IM C4500: [-1000 to 1000 / -15 / 1/step]
3-623-014	LD Power :Set	Std Speed intercept:Y	ENG*	IM C6000: [-1000 to 1000 / -18 / 1/step] IM C5500: [-1000 to 1000 / -18 / 1/step] IM C4500: [-1000 to 1000 / -15 / 1/step]
3-623-021	LD Power :Set	Mid Speed Slope:K	ENG*	[-1000 to 1000 / 213 / 1/step]
3-623-022	LD Power :Set	Mid Speed Slope:C	ENG*	[-1000 to 1000 / 213 / 1/step]
3-623-023	LD Power :Set	Mid Speed Slope:M	ENG*	[-1000 to 1000 / 213 / 1/step]
3-623-024	LD Power :Set	Mid Speed Slope:Y	ENG*	[-1000 to 1000 / 213 / 1/step]
3-623-031	LD Power :Set	Mid Speed intercept:K	ENG*	[-1000 to 1000 / -15 / 1/step]
3-623-032	LD Power :Set	Mid Speed intercept:C	ENG*	[-1000 to 1000 / -15 / 1/step]
3-623-033	LD Power :Set	Mid Speed intercept:M	ENG*	[-1000 to 1000 / -15 / 1/step]

3.SP Mode Tables

SP No.	Large Category	Small Category	ENG or CTL	[Min to Max/Init./Step]
3-623-034	LD Power :Set	Mid Speed intercept:Y	ENG*	[-1000 to 1000 / -15 / 1/step]
3-623-041	LD Power :Set	Low Speed Slope:K	ENG*	IM C6000: [-1000 to 1000 / 204 / 1/step] IM C5500: [-1000 to 1000 / 204 / 1/step] IM C4500: [-1000 to 1000 / 204 / 1/step]
3-623-042	LD Power :Set	Low Speed Slope:C	ENG*	IM C6000: [-1000 to 1000 / 204 / 1/step] IM C5500: [-1000 to 1000 / 204 / 1/step] IM C4500: [-1000 to 1000 / 204 / 1/step]
3-623-043	LD Power :Set	Low Speed Slope:M	ENG*	IM C6000: [-1000 to 1000 / 204 / 1/step] IM C5500: [-1000 to 1000 / 204 / 1/step] IM C4500: [-1000 to 1000 / 204 / 1/step]
3-623-044	LD Power :Set	Low Speed Slope:Y	ENG*	IM C6000: [-1000 to 1000 / 204 / 1/step] IM C5500: [-1000 to 1000 / 204 / 1/step]

3.SP Mode Tables

SP No.	Large Category	Small Category	ENG or CTL	[Min to Max/Init./Step]
				IM C4500: [-1000 to 1000 / 204 / 1/step]
3-623-051	LD Power :Set	Low Speed intercept:K	ENG*	IM C6000: [-1000 to 1000 / -15 / 1/step] IM C5500: [-1000 to 1000 / -15 / 1/step] IM C4500: [-1000 to 1000 / -15 / 1/step]
3-623-052	LD Power :Set	Low Speed intercept:C	ENG*	IM C6000: [-1000 to 1000 / -15 / 1/step] IM C5500: [-1000 to 1000 / -15 / 1/step] IM C4500: [-1000 to 1000 / -15 / 1/step]
3-623-053	LD Power :Set	Low Speed intercept:M	ENG*	IM C6000: [-1000 to 1000 / -15 / 1/step] IM C5500: [-1000 to 1000 / -15 / 1/step] IM C4500: [-1000 to 1000 / -15 / 1/step]
3-623-054	LD Power :Set	Low Speed intercept:Y	ENG*	IM C6000: [-1000 to 1000 / -15 / 1/step] IM C5500: [-1000 to 1000 / -15 / 1/step]

3.SP Mode Tables

SP No.	Large Category	Small Category	ENG or CTL	[Min to Max/Init./Step]
				IM C4500: [-1000 to 1000 / -15 / 1/step]
3-624-001	TC Adj. Mode	Target(Upp Limit)	ENG*	[0.00 to 1.00 / 0.15 / 0.01mg/cm2/-kV/step]
3-624-002	TC Adj. Mode	Target(Lwr Limit)	ENG*	[-1.00 to 0.00 / -0.12 / 0.01mg/cm2/-kV/step]
3-624-021	TC Adj. Mode	Consumption Pat: DUTY: K	ENG*	[0 to 15 / 15 / 1/step]
3-624-022	TC Adj. Mode	Consumption Pat: DUTY: C	ENG*	[0 to 15 / 15 / 1/step]
3-624-023	TC Adj. Mode	Consumption Pat: DUTY: M	ENG*	[0 to 15 / 15 / 1/step]
3-624-024	TC Adj. Mode	Consumption Pat: DUTY: Y	ENG*	[0 to 15 / 15 / 1/step]
3-624-031	TC Adj. Mode	Max Counts:PowerON	ENG*	[0 to 10 / 1 / 1/step]
3-624-032	TC Adj. Mode	Max Counts:Job In	ENG*	[0 to 10 / 0 / 1/step]
3-624-033	TC Adj. Mode	Max Counts:Printing	ENG*	[0 to 10 / 0 / 1/step]
3-624-034	TC Adj. Mode	Max Counts:Job End	ENG*	[0 to 10 / 1 / 1/step]
3-624-035	TC Adj. Mode	Max Counts:ACC	ENG*	[0 to 10 / 2 / 1/step]

3.SP Mode Tables

SP No.	Large Category	Small Category	ENG or CTL	[Min to Max/Init./Step]
3-624-036	TC Adj. Mode	Max Counts:Initial Setting	ENG*	[0 to 10 / 3 / 1/step]
3-624-037	TC Adj. Mode	Max Counts:Replenishment	ENG*	[0 to 10 / 3 / 1/step]
3-624-038	TC Adj. Mode	Max Counts:Recovery	ENG*	[0 to 10 / 3 / 1/step]
3-624-071	TC Adj. Mode	AbsHumThresh(Upp)	ENG*	[0.00 to 100.00 / 18.00 / 0.01g/m3/step]
3-624-072	TC Adj. Mode	AbsHumThresh(Low)	ENG*	[0.00 to 100.00 / 4.00 / 0.01g/m3/step]
3-624-073	TC Adj. Mode	AbsHumThresh(Range)	ENG*	[0.00 to 100.00 / 12.00 / 0.01g/m3/step]
3-627-001	P Pattern Extraction :Set	Edge Detection Threshold :K	ENG*	[0.0 to 5.0 / 2.0 / 0.1V/step]
3-627-002	P Pattern Extraction :Set	Edge Detection Threshold :C	ENG*	[0.0 to 5.0 / 2.5 / 0.1V/step]
3-627-003	P Pattern Extraction :Set	Edge Detection Threshold :M	ENG*	[0.0 to 5.0 / 2.5 / 0.1V/step]
3-627-004	P Pattern Extraction :Set	Edge Detection Threshold :Y	ENG*	[0.0 to 5.0 / 2.5 / 0.1V/step]
3-627-011	P Pattern Extraction :Set	Edge Upper Limit:Potential Control	ENG*	[7.0 to 10.0 / 9.0 / 0.1mm/step]
3-627-012	P Pattern Extraction :Set	Edge Upper Limit:IBACC	ENG*	[10.0 to 13.0 / 12.0 / 0.1mm/step]

3.SP Mode Tables

SP No.	Large Category	Small Category	ENG or CTL	[Min to Max/Init./Step]
3-627-013	P Pattern Extraction :Set	Edge Upper Limit:RTP	ENG*	[5.0 to 8.0 / 7.0 / 0.1mm/step]
3-627-021	P Pattern Extraction :Set	Edge Lower Limit:Potential Control	ENG*	[4.0 to 7.0 / 5.0 / 0.1mm/step]
3-627-022	P Pattern Extraction :Set	Edge Lower Limit:IBACC	ENG*	[7.0 to 10.0 / 8.0 / 0.1mm/step]
3-627-023	P Pattern Extraction :Set	Edge Lower Limit:RTP	ENG*	[2.0 to 5.0 / 3.0 / 0.1mm/step]
3-628-001	ID Pattern Timing :Set	Scan: YCMK	ENG*	[-500.0 to 500.0 / 0.0 / 0.1mm/step]
3-628-002	ID Pattern Timing :Set	Detection Delay Time	ENG*	[0 to 2500 / 0 / 1msec/step]
3-628-003	ID Pattern Timing :Set	Delay Time	ENG*	[0 to 2500 / 778 / 1msec/step]
3-628-004	ID Pattern Timing :Set	MUSIC Delay Time	ENG*	[0 to 2500 / 150 / 1msec/step]
3-630-001	Dev gamma :Disp/Set	Current:K	ENG*	[0.10 to 6.00 / 0.81 / 0.01mg/cm2/-kV/step]
3-630-002	Dev gamma :Disp/Set	Current:C	ENG*	[0.10 to 6.00 / 0.88 / 0.01mg/cm2/-kV/step]
3-630-003	Dev gamma :Disp/Set	Current:M	ENG*	[0.10 to 6.00 / 0.80 / 0.01mg/cm2/-kV/step]
3-630-004	Dev gamma :Disp/Set	Current:Y	ENG*	[0.10 to 6.00 / 0.88 / 0.01mg/cm2/-kV/step]

3.SP Mode Tables

SP No.	Large Category	Small Category	ENG or CTL	[Min to Max/Init./Step]
3-630-011	Dev gamma :Disp/Set	Target:K	ENG*	[0.50 to 2.55 / 0.81 / 0.01mg/cm2/-kV/step]
3-630-012	Dev gamma :Disp/Set	Target:C	ENG*	[0.50 to 2.55 / 0.88 / 0.01mg/cm2/-kV/step]
3-630-013	Dev gamma :Disp/Set	Target:M	ENG*	[0.50 to 2.55 / 0.80 / 0.01mg/cm2/-kV/step]
3-630-014	Dev gamma :Disp/Set	Target:Y	ENG*	[0.50 to 2.55 / 0.88 / 0.01mg/cm2/-kV/step]
3-630-061	Dev gamma :Disp/Set	TnrDensity:K	ENG*	[0.0 to 25.5 / 0.0 / 0.1wt%/step]
3-630-062	Dev gamma :Disp/Set	TnrDensity:C	ENG*	[0.0 to 25.5 / 0.0 / 0.1wt%/step]
3-630-063	Dev gamma :Disp/Set	TnrDensity:M	ENG*	[0.0 to 25.5 / 0.0 / 0.1wt%/step]
3-630-064	Dev gamma :Disp/Set	TnrDensity:Y	ENG*	[0.0 to 25.5 / 0.0 / 0.1wt%/step]
3-630-111	Dev gamma :Disp/Set	Current:F_K	ENG	[0.10 to 6.00 / 0.90 / 0.01mg/cm2/-kV/step]
3-630-112	Dev gamma :Disp/Set	Current:F_C	ENG	[0.10 to 6.00 / 0.80 / 0.01mg/cm2/-kV/step]
3-630-113	Dev gamma :Disp/Set	Current:F_M	ENG	[0.10 to 6.00 / 0.80 / 0.01mg/cm2/-kV/step]
3-630-114	Dev gamma :Disp/Set	Current:F_Y	ENG	[0.10 to 6.00 / 0.80 / 0.01mg/cm2/-kV/step]

3.SP Mode Tables

SP No.	Large Category	Small Category	ENG or CTL	[Min to Max/Init./Step]
3-630-121	Dev gamma :Disp/Set	Current:C_K	ENG	[0.10 to 6.00 / 0.90 / 0.01mg/cm2/-kV/step]
3-630-122	Dev gamma :Disp/Set	Current:C_C	ENG	[0.10 to 6.00 / 0.80 / 0.01mg/cm2/-kV/step]
3-630-123	Dev gamma :Disp/Set	Current:C_M	ENG	[0.10 to 6.00 / 0.80 / 0.01mg/cm2/-kV/step]
3-630-124	Dev gamma :Disp/Set	Current:C_Y	ENG	[0.10 to 6.00 / 0.80 / 0.01mg/cm2/-kV/step]
3-630-131	Dev gamma :Disp/Set	Current:R_K	ENG	[0.10 to 6.00 / 0.90 / 0.01mg/cm2/-kV/step]
3-630-132	Dev gamma :Disp/Set	Current:R_C	ENG	[0.10 to 6.00 / 0.80 / 0.01mg/cm2/-kV/step]
3-630-133	Dev gamma :Disp/Set	Current:R_M	ENG	[0.10 to 6.00 / 0.80 / 0.01mg/cm2/-kV/step]
3-630-134	Dev gamma :Disp/Set	Current:R_Y	ENG	[0.10 to 6.00 / 0.80 / 0.01mg/cm2/-kV/step]
3-630-141	Dev gamma :Disp/Set	Range M/A Upp:K	ENG*	[0.20 to 1.00 / 0.40 / 0.01mg/cm2/step]
3-630-142	Dev gamma :Disp/Set	Range M/A Low:K	ENG*	[0.00 to 0.20 / 0.05 / 0.01mg/cm2/step]
3-630-143	Dev gamma :Disp/Set	Range M/A Upp:Col	ENG*	[0.20 to 1.00 / 0.50 / 0.01mg/cm2/step]
3-630-144	Dev gamma :Disp/Set	Range M/A Low:Col	ENG*	[0.00 to 0.20 / 0.05 / 0.01mg/cm2/step]

3.SP Mode Tables

SP No.	Large Category	Small Category	ENG or CTL	[Min to Max/Init./Step]
3-631-001	Vk :Disp	Current:K	ENG*	[-300 to 300 / 0 / 1-V/step]
3-631-002	Vk :Disp	Current:C	ENG*	[-300 to 300 / 0 / 1-V/step]
3-631-003	Vk :Disp	Current:M	ENG*	[-300 to 300 / 0 / 1-V/step]
3-631-004	Vk :Disp	Current:Y	ENG*	[-300 to 300 / 0 / 1-V/step]
3-631-111	Vk :Disp	Current:F_K	ENG	[-300 to 300 / 0 / 1-V/step]
3-631-112	Vk :Disp	Current:F_C	ENG	[-300 to 300 / 0 / 1-V/step]
3-631-113	Vk :Disp	Current:F_M	ENG	[-300 to 300 / 0 / 1-V/step]
3-631-114	Vk :Disp	Current:F_Y	ENG	[-300 to 300 / 0 / 1-V/step]
3-631-121	Vk :Disp	Current:C_K	ENG	[-300 to 300 / 0 / 1-V/step]
3-631-122	Vk :Disp	Current:C_C	ENG	[-300 to 300 / 0 / 1-V/step]
3-631-123	Vk :Disp	Current:C_M	ENG	[-300 to 300 / 0 / 1-V/step]
3-631-124	Vk :Disp	Current:C_Y	ENG	[-300 to 300 / 0 / 1-V/step]

3.SP Mode Tables

SP No.	Large Category	Small Category	ENG or CTL	[Min to Max/Init./Step]
3-631-131	Vk :Disp	Current:R_K	ENG	[-300 to 300 / 0 / 1-V/step]
3-631-132	Vk :Disp	Current:R_C	ENG	[-300 to 300 / 0 / 1-V/step]
3-631-133	Vk :Disp	Current:R_M	ENG	[-300 to 300 / 0 / 1-V/step]
3-631-134	Vk :Disp	Current:R_Y	ENG	[-300 to 300 / 0 / 1-V/step]
3-680-001	Shading Compensation	Plus Image Quantity: K	ENG*	[-20 to 16 / 0 / 1/step]
3-680-002	Shading Compensation	Plus Image Quantity: C	ENG*	[-20 to 16 / 0 / 1/step]
3-680-003	Shading Compensation	Plus Image Quantity: M	ENG*	[-20 to 16 / 0 / 1/step]
3-680-004	Shading Compensation	Plus Image Quantity: Y	ENG*	[-20 to 16 / 0 / 1/step]
3-680-011	Shading Compensation	Minus Image Quantity: K	ENG*	[-20 to 16 / 0 / 1/step]
3-680-012	Shading Compensation	Minus Image Quantity: C	ENG*	[-20 to 16 / 0 / 1/step]
3-680-013	Shading Compensation	Minus Image Quantity: M	ENG*	[-20 to 16 / 0 / 1/step]
3-680-014	Shading Compensation	Minus Image Quantity: Y	ENG*	[-20 to 16 / 0 / 1/step]

3.SP Mode Tables

SP No.	Large Category	Small Category	ENG or CTL	[Min to Max/Init./Step]
3-700-001	New Unit Detection	ON/OFF Setting	ENG*	[0 to 1 / 1 / 1/step]
3-701-002	Manual New Unit Set	# PCU:K	ENG*	[0 to 1 / 0 / 1/step]
3-701-003	Manual New Unit Set	# Dev Unit:K	ENG*	[0 to 1 / 0 / 1/step]
3-701-025	Manual New Unit Set	# PCU:C	ENG*	[0 to 1 / 0 / 1/step]
3-701-026	Manual New Unit Set	# Dev Unit:C	ENG*	[0 to 1 / 0 / 1/step]
3-701-048	Manual New Unit Set	# PCU:M	ENG*	[0 to 1 / 0 / 1/step]
3-701-049	Manual New Unit Set	# Dev Unit:M	ENG*	[0 to 1 / 0 / 1/step]
3-701-071	Manual New Unit Set	# PCU:Y	ENG*	[0 to 1 / 0 / 1/step]
3-701-072	Manual New Unit Set	# Dev Unit:Y	ENG*	[0 to 1 / 0 / 1/step]
3-701-093	Manual New Unit Set	# ITB Unit	ENG*	[0 to 1 / 0 / 1/step]
3-701-102	Manual New Unit Set	# ITB Cleaning Unit	ENG*	[0 to 1 / 0 / 1/step]
3-701-109	Manual New Unit Set	# PTR Unit	ENG*	[0 to 1 / 0 / 1/step]

3.SP Mode Tables

SP No.	Large Category	Small Category	ENG or CTL	[Min to Max/Init./Step]
3-701-115	Manual New Unit Set	# Fusing Unit	ENG*	[0 to 1 / 0 / 1/step]
3-701-116	Manual New Unit Set	Fusing Belt	ENG*	[0 to 1 / 0 / 1/step]
3-701-118	Manual New Unit Set	Pressure Roller	ENG*	[0 to 1 / 0 / 1/step]
3-701-131	Manual New Unit Set	Dust Filter	ENG*	[0 to 1 / 0 / 1/step]
3-701-142	Manual New Unit Set	Waste Toner Bottle	ENG*	[0 to 1 / 0 / 1/step]
3-701-206	Manual New Unit Set	ADF Pick-up Roller	ENG*	[0 to 1 / 0 / 1/step]
3-701-207	Manual New Unit Set	ADF Supply Belt	ENG*	[0 to 1 / 0 / 1/step]
3-701-208	Manual New Unit Set	ADF Reverse Roller	ENG*	[0 to 1 / 0 / 1/step]
3-800-001	Waste Toner Full Detection	Condition	ENG*	[0 to 4 / 0 / 1/step]
3-800-002	Waste Toner Full Detection	Page Count 1 After Near Full	ENG*	[0 to 1000000 / 0 / 1sheet/step]
3-800-003	Waste Toner Full Detection	Volume Count 1 After Near Full	ENG*	[0.0 to 10000000.0 / 0.0 / 0.1mg/step]
3-800-004	Waste Toner Full Detection	Volume Count 1 After Replacement	ENG*	[0.0 to 10000000.0 / 0.0 / 0.1mg/step]

3.SP Mode Tables

SP No.	Large Category	Small Category	ENG or CTL	[Min to Max/Init./Step]
3-800-005	Waste Toner Full Detection	Volume Count 2 After Replacement	ENG*	[0.0 to 10000000.0 / 0.0 / 0.1mg/step]
3-800-006	Waste Toner Full Detection	Page Count 2 After Near Full	ENG*	[0 to 1000000 / 0 / 1sheet/step]
3-800-007	Waste Toner Full Detection	Volume Count 2 After Near Full	ENG*	[0.0 to 10000000.0 / 0.0 / 0.1mg/step]
3-800-014	Waste Toner Full Detection	Threshold : Remainder days	ENG*	IM C6000: [1 to 255 / 15 / 1day/step] IM C5500: [1 to 255 / 15 / 1day/step] IM C4500: [1 to 255 / 15 / 1day/step]
3-800-024	Waste Toner Full Detection	Date of detection for near full	ENG*	[0 to 1 / 0 / 1/step]
3-802-001	Waste Toner Bottle Call	Automatic Ordering Thresh	ENG*	[26.0 to 90.0 / 50.0 / 0.1%/step]
3-831-011	SFBVSC:Choice	Reflect of Correction	ENG*	[0 to 1 / 0 / 1/step]
3-905-001	Recycled Parts: New/Old Flag	OPC:K	ENG*	[0 to 1 / 0 / 1/step]
3-905-002	Recycled Parts: New/Old Flag	OPC:C	ENG*	[0 to 1 / 0 / 1/step]
3-905-003	Recycled Parts: New/Old Flag	OPC:M	ENG*	[0 to 1 / 0 / 1/step]

3.SP Mode Tables

SP No.	Large Category	Small Category	ENG or CTL	[Min to Max/Init./Step]
3-905-004	Recycled Parts: New/Old Flag	OPC:Y	ENG*	[0 to 1 / 0 / 1/step]
3-946-001	Processing Stop Times: Display	BW	ENG*	[0 to 4000000000 / 0 / 1counts/step]
3-946-002	Processing Stop Times: Display	FC	ENG*	[0 to 4000000000 / 0 / 1counts/step]
3-990-001	Abs Temp.:Get Charge Load	Temperature: Display	ENG*	[0.0 to 70.0 / 0.0 / 0.1deg/step]
3-990-002	Abs Humidity:Get Charge Load	Abs Humidity: Display	ENG*	[0.00 to 100.00 / 0.00 / 0.01g/m3/step]

Engine SP Tables-4

SP4-XXX (Scanner)

SP No.	Large Category	Small Category	ENG or CTL	[Min to Max/Init./Step]
4-008-001	Sub Scan Magnification Adj		ENG*	[-1.0 to 1.0 / 0.0 / 0.1%/step]
4-010-001	Sub Scan Registration Adj		ENG*	[-2.0 to 2.0 / 0.0 / 0.1mm/step]
4-011-001	Main Scan Reg		ENG*	[-2.5 to 2.5 / 0.0 / 0.1mm/step]
4-012-001	Set Scale Mask	Book:Sub LEdge	ENG	[0.0 to 3.0 / 1.0 / 0.1mm/step]
4-012-002	Set Scale Mask	Book:Sub TEdge	ENG	[0.0 to 3.0 / 0.0 / 0.1mm/step]
4-012-003	Set Scale Mask	Book:Main:LEdge	ENG	[0.0 to 3.0 / 1.0 / 0.1mm/step]
4-012-004	Set Scale Mask	Book:Main:TEdge	ENG	[0.0 to 3.0 / 0.0 / 0.1mm/step]
4-012-	Set Scale Mask	ADF: Leading Edge	ENG*	[0.0 to 3.0 / 0.0 /

3.SP Mode Tables

SP No.	Large Category	Small Category	ENG or CTL	[Min to Max/Init./Step]
005				0.1mm/step]
4-012-007	Set Scale Mask	ADF: Right	ENG*	[0.0 to 3.0 / 0.0 / 0.1mm/step]
4-012-008	Set Scale Mask	ADF: left	ENG*	[0.0 to 3.0 / 0.0 / 0.1mm/step]
4-013-001	Scanner Free run	Book mode :Lamp Off	ENG	[0 to 1 / 0 / 1/step]
4-013-002	Scanner Free run	Book mode :Lamp On	ENG	[0 to 1 / 0 / 1/step]
4-020-001	Dust Check	Dust Detect:On/Off	ENG	[0 to 1 / 0 / 1/step]
4-020-002	Dust Check	Dust Detect:Lvl	ENG	[0 to 8 / 4 / 1/step]
4-020-003	Dust Check Lvl	Dust Reject:Lvl	ENG	[0 to 4 / 0 / 1/step]
4-020-011	DF Dust Check	Dust Detect Level:Rear	ENG	[0 to 1 / 0 / 1/step]
4-020-012	DF Dust Check	Correction Level:Rear	ENG	[0 to 8 / 4 / 1/step]
4-201-001	LoCPP edge lv:K	600dpi 2bit edge1	ENG*	[0 to 15 / 11 / 1/step]
4-201-002	LoCPP edge lv:K	600dpi 2bit edge2	ENG*	[0 to 15 / 11 / 1/step]
4-201-003	LoCPP edge lv:K	600dpi 4bit edge1	ENG*	[0 to 15 / 11 / 1/step]
4-201-004	LoCPP edge lv:K	600dpi 4bit edge2	ENG*	[0 to 15 / 11 / 1/step]
4-201-005	LoCPP edge lv:K	600dpi 1bit edge1	ENG*	[0 to 15 / 15 / 1/step]
4-201-006	LoCPP edge lv:K	600dpi 1bit edge2	ENG*	[0 to 15 / 15 / 1/step]
4-201-011	LoCPP edge lv:K	1200dpi1bit edge12	ENG*	[0 to 15 / 12 / 1/step]
4-201-012	LoCPP edge lv:K	1200dpi1bit edge34	ENG*	[0 to 15 / 12 / 1/step]
4-201-	LoCPP edge lv:K	1200dpi2bit edge12	ENG*	[0 to 15 / 15 / 1/step]

3.SP Mode Tables

SP No.	Large Category	Small Category	ENG or CTL	[Min to Max/Init./Step]
013				
4-201-014	LoCPP edge lv:K	1200dpi2bit edge34	ENG*	[0 to 15 / 15 / 1/step]
4-202-001	LoCPP edge lv:C	600dpi 2bit edge1	ENG*	[0 to 15 / 15 / 1/step]
4-202-002	LoCPP edge lv:C	600dpi 2bit edge2	ENG*	[0 to 15 / 15 / 1/step]
4-202-003	LoCPP edge lv:C	600dpi 4bit edge1	ENG*	[0 to 15 / 15 / 1/step]
4-202-004	LoCPP edge lv:C	600dpi 4bit edge2	ENG*	[0 to 15 / 15 / 1/step]
4-202-005	LoCPP edge lv:C	600dpi 1bit edge1	ENG*	[0 to 15 / 15 / 1/step]
4-202-006	LoCPP edge lv:C	600dpi 1bit edge2	ENG*	[0 to 15 / 15 / 1/step]
4-202-011	LoCPP edge lv:C	1200dpi1bit edge12	ENG*	[0 to 15 / 15 / 1/step]
4-202-012	LoCPP edge lv:C	1200dpi1bit edge34	ENG*	[0 to 15 / 15 / 1/step]
4-202-013	LoCPP edge lv:C	1200dpi2bit edge12	ENG*	[0 to 15 / 15 / 1/step]
4-202-014	LoCPP edge lv:C	1200dpi2bit edge34	ENG*	[0 to 15 / 15 / 1/step]
4-203-001	LoCPP edge lv:M	600dpi 2bit edge1	ENG*	[0 to 15 / 15 / 1/step]
4-203-002	LoCPP edge lv:M	600dpi 2bit edge2	ENG*	[0 to 15 / 15 / 1/step]
4-203-003	LoCPP edge lv:M	600dpi 4bit edge1	ENG*	[0 to 15 / 15 / 1/step]
4-203-004	LoCPP edge lv:M	600dpi 4bit edge2	ENG*	[0 to 15 / 15 / 1/step]
4-203-005	LoCPP edge lv:M	600dpi 1bit edge1	ENG*	[0 to 15 / 15 / 1/step]
4-203-006	LoCPP edge lv:M	600dpi 1bit edge2	ENG*	[0 to 15 / 15 / 1/step]
4-203-	LoCPP edge lv:M	1200dpi 1bit edge12	ENG*	[0 to 15 / 15 / 1/step]

3.SP Mode Tables

SP No.	Large Category	Small Category	ENG or CTL	[Min to Max/Init./Step]
011				
4-203-012	LoCPP edge lv:M	1200dpi 1bit edge34	ENG*	[0 to 15 / 15 / 1/step]
4-203-013	LoCPP edge lv:M	1200dpi 2bit edge12	ENG*	[0 to 15 / 15 / 1/step]
4-203-014	LoCPP edge lv:M	1200dpi 2bit edge34	ENG*	[0 to 15 / 15 / 1/step]
4-204-001	LoCPP edge lv:Y	600dpi 2bit edge1	ENG*	[0 to 15 / 15 / 1/step]
4-204-002	LoCPP edge lv:Y	600dpi 2bit edge2	ENG*	[0 to 15 / 15 / 1/step]
4-204-003	LoCPP edge lv:Y	600dpi 4bit edge1	ENG*	[0 to 15 / 15 / 1/step]
4-204-004	LoCPP edge lv:Y	600dpi 4bit edge2	ENG*	[0 to 15 / 15 / 1/step]
4-204-005	LoCPP edge lv:Y	600dpi 1bit edge1	ENG*	[0 to 15 / 15 / 1/step]
4-204-006	LoCPP edge lv:Y	600dpi 1bit edge2	ENG*	[0 to 15 / 15 / 1/step]
4-204-011	LoCPP edge lv:Y	1200dpi 1bit edge12	ENG*	[0 to 15 / 15 / 1/step]
4-204-012	LoCPP edge lv:Y	1200dpi 1bit edge34	ENG*	[0 to 15 / 15 / 1/step]
4-204-013	LoCPP edge lv:Y	1200dpi 2bit edge12	ENG*	[0 to 15 / 15 / 1/step]
4-204-014	LoCPP edge lv:Y	1200dpi 2bit edge34	ENG*	[0 to 15 / 15 / 1/step]
4-301-001	Operation Check APS Sensor		ENG	[0 to 255 / 0 / 1/step]
4-303-001	Min Size for APS		ENG*	[0 to 1 / 0 / 1/step]
4-305-001	8K/16K Detection		ENG*	[0 to 3 / 0 / 1/step]
4-308-001	Scan Size Detection	Detection ON/OFF	ENG*	[0 to 2 / 1 / 1/step]
4-311-	Detection:Start Position	Detection:Start Position	ENG*	[0 to 2 / 0 / 1/step]

3.SP Mode Tables

SP No.	Large Category	Small Category	ENG or CTL	[Min to Max/Init./Step]
001				
4-312-001	Scan Size Detect:Setting	Original Density Thresh:S1	ENG*	[0 to 255 / 7 / 1digit/step]
4-312-002	Scan Size Detect:Setting	Original Density Thresh:S2	ENG*	[0 to 255 / 7 / 1digit/step]
4-312-003	Scan Size Detect:Setting	Original Density Thresh:S3	ENG*	[0 to 255 / 7 / 1digit/step]
4-312-004	Scan Size Detect:Setting	Detection Time	ENG*	[10 to 20 / 10 / 10msec/step]
4-312-005	Scan Size Detect:Setting	Detection:Delay Time	ENG*	[0 to 200 / 0 / 10msec/step]
4-312-006	Scan Size Detect:Setting	LED PWM Duty	ENG*	[0 to 100 / 22 / 1/step]
4-313-001	Scan Size Detect Value	S1:R:LEDOFF	ENG	[0 to 255 / 0 / 1digit/step]
4-313-002	Scan Size Detect Value	S1:G:LEDOFF	ENG	[0 to 255 / 0 / 1digit/step]
4-313-003	Scan Size Detect Value	S1:B:LEDOFF	ENG	[0 to 255 / 0 / 1digit/step]
4-313-004	Scan Size Detect Value	S2:R:LEDOFF	ENG	[0 to 255 / 0 / 1digit/step]
4-313-005	Scan Size Detect Value	S2:G:LEDOFF	ENG	[0 to 255 / 0 / 1digit/step]
4-313-006	Scan Size Detect Value	S2:B:LEDOFF	ENG	[0 to 255 / 0 / 1digit/step]
4-313-007	Scan Size Detect Value	S3:R:LEDOFF	ENG	[0 to 255 / 0 / 1digit/step]
4-313-008	Scan Size Detect Value	S3:G:LEDOFF	ENG	[0 to 255 / 0 / 1digit/step]
4-313-009	Scan Size Detect Value	S3:B:LEDOFF	ENG	[0 to 255 / 0 / 1digit/step]
4-313-010	Scan Size Detect Value	S1:R:LEDON:AREA1	ENG	[0 to 255 / 0 / 1digit/step]
4-313-011	Scan Size Detect Value	S1:G:LEDON:AREA1	ENG	[0 to 255 / 0 / 1digit/step]
4-313-	Scan Size Detect Value	S1:B:LEDON:AREA1	ENG	[0 to 255 / 0 /

3.SP Mode Tables

SP No.	Large Category	Small Category	ENG or CTL	[Min to Max/Init./Step]
012				1digit/step]
4-313-013	Scan Size Detect Value	S2:R:LEDON:AREA1	ENG	[0 to 255 / 0 / 1digit/step]
4-313-014	Scan Size Detect Value	S2:G:LEDON:AREA1	ENG	[0 to 255 / 0 / 1digit/step]
4-313-015	Scan Size Detect Value	S2:B:LEDON:AREA1	ENG	[0 to 255 / 0 / 1digit/step]
4-313-016	Scan Size Detect Value	S3:R:LEDON:AREA1	ENG	[0 to 255 / 0 / 1digit/step]
4-313-017	Scan Size Detect Value	S3:G:LEDON:AREA1	ENG	[0 to 255 / 0 / 1digit/step]
4-313-018	Scan Size Detect Value	S3:B:LEDON:AREA1	ENG	[0 to 255 / 0 / 1digit/step]
4-313-019	Scan Size Detect Value	S1:R:LEDON:AREA2	ENG	[0 to 255 / 0 / 1digit/step]
4-313-020	Scan Size Detect Value	S1:G:LEDON:AREA2	ENG	[0 to 255 / 0 / 1digit/step]
4-313-021	Scan Size Detect Value	S1:B:LEDON:AREA2	ENG	[0 to 255 / 0 / 1digit/step]
4-313-022	Scan Size Detect Value	S2:R:LEDON:AREA2	ENG	[0 to 255 / 0 / 1digit/step]
4-313-023	Scan Size Detect Value	S2:G:LEDON:AREA2	ENG	[0 to 255 / 0 / 1digit/step]
4-313-024	Scan Size Detect Value	S2:B:LEDON:AREA2	ENG	[0 to 255 / 0 / 1digit/step]
4-313-025	Scan Size Detect Value	S3:R:LEDON:AREA2	ENG	[0 to 255 / 0 / 1digit/step]
4-313-026	Scan Size Detect Value	S3:G:LEDON:AREA2	ENG	[0 to 255 / 0 / 1digit/step]
4-313-027	Scan Size Detect Value	S3:B:LEDON:AREA2	ENG	[0 to 255 / 0 / 1digit/step]
4-313-028	Scan Size Detect Value	S1:R:LEDON:AREA3	ENG	[0 to 255 / 0 / 1digit/step]
4-313-029	Scan Size Detect Value	S1:G:LEDON:AREA3	ENG	[0 to 255 / 0 / 1digit/step]
4-313-	Scan Size Detect Value	S1:B:LEDON:AREA3	ENG	[0 to 255 / 0 /

3.SP Mode Tables

SP No.	Large Category	Small Category	ENG or CTL	[Min to Max/Init./Step]
030				1digit/step]
4-313-031	Scan Size Detect Value	S2:R:LEDON:AREA3	ENG	[0 to 255 / 0 / 1digit/step]
4-313-032	Scan Size Detect Value	S2:G:LEDON:AREA3	ENG	[0 to 255 / 0 / 1digit/step]
4-313-033	Scan Size Detect Value	S2:B:LEDON:AREA3	ENG	[0 to 255 / 0 / 1digit/step]
4-313-034	Scan Size Detect Value	S3:R:LEDON:AREA3	ENG	[0 to 255 / 0 / 1digit/step]
4-313-035	Scan Size Detect Value	S3:G:LEDON:AREA3	ENG	[0 to 255 / 0 / 1digit/step]
4-313-036	Scan Size Detect Value	S3:B:LEDON:AREA3	ENG	[0 to 255 / 0 / 1digit/step]
4-400-001	Org Edge Mask	Book:Sub:LEdge(Left)	ENG	[0.0 to 3.0 / 0.0 / 0.1mm/step]
4-400-002	Org Edge Mask	Book:Sub:TEdge(Right)	ENG	[0.0 to 3.0 / 0.0 / 0.1mm/step]
4-400-003	Org Edge Mask	Book:Main:LEdge(Rear)	ENG	[0.0 to 3.0 / 0.0 / 0.1mm/step]
4-400-004	Org Edge Mask	Book:Main:Tedge(Front)	ENG	[0.0 to 3.0 / 0.0 / 0.1mm/step]
4-400-005	Org Edge Mask	ADF: Leading Edge	ENG*	[0.0 to 3.0 / 0.0 / 0.1mm/step]
4-400-007	Org Edge Mask	ADF: Right	ENG*	[0.0 to 3.0 / 0.0 / 0.1mm/step]
4-400-008	Org Edge Mask	ADF: left	ENG*	[0.0 to 3.0 / 0.0 / 0.1mm/step]
4-417-001	IPU Test Pattern	Test Pattern	ENG	[0 to 9 / 0 / 1/step]
4-429-001	Select Copy Data Security	Copying	ENG	[0 to 3 / 3 / 1/step]
4-429-002	Select Copy Data Security	Scanning	ENG	[0 to 3 / 3 / 1/step]
4-429-003	Select Copy Data Security	Fax Operation	ENG	[0 to 3 / 3 / 1/step]
4-460-	Digital AE	Low Limit Value	ENG	[0 to 1023 / 364 /

3.SP Mode Tables

SP No.	Large Category	Small Category	ENG or CTL	[Min to Max/Init./Step]
001				1/step]
4-460-002	Digital AE	Background level	ENG*	[512 to 1535 / 932 / 1/step]
4-501-001	ACC Target Den	Copy:K:Text	ENG*	[0 to 10 / 0 / 1/step]
4-501-002	ACC Target Den	Copy:C:Text	ENG*	[0 to 10 / 0 / 1/step]
4-501-003	ACC Target Den	Copy:M:Text	ENG*	[0 to 10 / 0 / 1/step]
4-501-004	ACC Target Den	Copy:Y:Text	ENG*	[0 to 10 / 0 / 1/step]
4-501-005	ACC Target Den	Copy:K:Photo	ENG*	[0 to 10 / 0 / 1/step]
4-501-006	ACC Target Den	Copy:C:Photo	ENG*	[0 to 10 / 0 / 1/step]
4-501-007	ACC Target Den	Copy:M:Photo	ENG*	[0 to 10 / 0 / 1/step]
4-501-008	ACC Target Den	Copy:Y:Photo	ENG*	[0 to 10 / 0 / 1/step]
4-505-001	ACC Cor:Bright	Master:K	ENG*	[-128 to 127 / 0 / 1/step]
4-505-002	ACC Cor:Bright	Master:C	ENG*	[-128 to 127 / 0 / 1/step]
4-505-003	ACC Cor:Bright	Master:M	ENG*	[-128 to 127 / 0 / 1/step]
4-505-004	ACC Cor:Bright	Master:Y	ENG*	[-128 to 127 / 0 / 1/step]
4-505-005	ACC Cor:Bright	Slave:K	ENG*	[-128 to 127 / 0 / 1/step]
4-505-006	ACC Cor:Bright	Slave:C	ENG*	[-128 to 127 / 0 / 1/step]
4-505-007	ACC Cor:Bright	Slave:M	ENG*	[-128 to 127 / 0 / 1/step]
4-505-008	ACC Cor:Bright	Slave:Y	ENG*	[-128 to 127 / 0 / 1/step]
4-506-	ACC Cor:Dark	Master:K	ENG*	[-128 to 127 / 0 /

3.SP Mode Tables

SP No.	Large Category	Small Category	ENG or CTL	[Min to Max/Init./Step]
001				1/step]
4-506-002	ACC Cor:Dark	Master:C	ENG*	[-128 to 127 / 0 / 1/step]
4-506-003	ACC Cor:Dark	Master:M	ENG*	[-128 to 127 / 0 / 1/step]
4-506-004	ACC Cor:Dark	Master:Y	ENG*	[-128 to 127 / 0 / 1/step]
4-506-005	ACC Cor:Dark	Slave:K	ENG*	[-128 to 127 / 0 / 1/step]
4-506-006	ACC Cor:Dark	Slave:C	ENG*	[-128 to 127 / 0 / 1/step]
4-506-007	ACC Cor:Dark	Slave:M	ENG*	[-128 to 127 / 0 / 1/step]
4-506-008	ACC Cor:Dark	Slave:Y	ENG*	[-128 to 127 / 0 / 1/step]
4-520-001	IBACC:DetectedValue	Latest:K_P1	ENG*	[0 to 1023 / 0 / 1/step]
4-520-002	IBACC:DetectedValue	Latest:K_P2	ENG*	[0 to 1023 / 0 / 1/step]
4-520-003	IBACC:DetectedValue	Latest:K_P3	ENG*	[0 to 1023 / 0 / 1/step]
4-520-004	IBACC:DetectedValue	Latest:K_P4	ENG*	[0 to 1023 / 0 / 1/step]
4-520-005	IBACC:DetectedValue	Latest:K_P5	ENG*	[0 to 1023 / 0 / 1/step]
4-520-006	IBACC:DetectedValue	Latest:K_P6	ENG*	[0 to 1023 / 0 / 1/step]
4-520-007	IBACC:DetectedValue	Latest:K_P6	ENG*	[0 to 1023 / 0 / 1/step]
4-520-008	IBACC:DetectedValue	Latest:K_P6	ENG*	[0 to 1023 / 0 / 1/step]
4-520-021	IBACC:DetectedValue	Latest:C_P1	ENG*	[0 to 1023 / 0 / 1/step]
4-520-022	IBACC:DetectedValue	Latest:C_P2	ENG*	[0 to 1023 / 0 / 1/step]
4-520-	IBACC:DetectedValue	Latest:C_P3	ENG*	[0 to 1023 / 0 / 1/step]

3.SP Mode Tables

SP No.	Large Category	Small Category	ENG or CTL	[Min to Max/Init./Step]
023				
4-520-024	IBACC:DetectedValue	Latest:C_P4	ENG*	[0 to 1023 / 0 / 1/step]
4-520-025	IBACC:DetectedValue	Latest:C_P5	ENG*	[0 to 1023 / 0 / 1/step]
4-520-026	IBACC:DetectedValue	Latest:C_P6	ENG*	[0 to 1023 / 0 / 1/step]
4-520-027	IBACC:DetectedValue	Latest:C_P6	ENG*	[0 to 1023 / 0 / 1/step]
4-520-028	IBACC:DetectedValue	Latest:C_P6	ENG*	[0 to 1023 / 0 / 1/step]
4-520-041	IBACC:DetectedValue	Latest:M_P1	ENG*	[0 to 1023 / 0 / 1/step]
4-520-042	IBACC:DetectedValue	Latest:M_P2	ENG*	[0 to 1023 / 0 / 1/step]
4-520-043	IBACC:DetectedValue	Latest:M_P3	ENG*	[0 to 1023 / 0 / 1/step]
4-520-044	IBACC:DetectedValue	Latest:M_P4	ENG*	[0 to 1023 / 0 / 1/step]
4-520-045	IBACC:DetectedValue	Latest:M_P5	ENG*	[0 to 1023 / 0 / 1/step]
4-520-046	IBACC:DetectedValue	Latest:M_P6	ENG*	[0 to 1023 / 0 / 1/step]
4-520-047	IBACC:DetectedValue	Latest:M_P6	ENG*	[0 to 1023 / 0 / 1/step]
4-520-048	IBACC:DetectedValue	Latest:M_P6	ENG*	[0 to 1023 / 0 / 1/step]
4-520-061	IBACC:DetectedValue	Latest:Y_P1	ENG*	[0 to 1023 / 0 / 1/step]
4-520-062	IBACC:DetectedValue	Latest:Y_P2	ENG*	[0 to 1023 / 0 / 1/step]
4-520-063	IBACC:DetectedValue	Latest:Y_P3	ENG*	[0 to 1023 / 0 / 1/step]
4-520-064	IBACC:DetectedValue	Latest:Y_P4	ENG*	[0 to 1023 / 0 / 1/step]
4-520-	IBACC:DetectedValue	Latest:Y_P5	ENG*	[0 to 1023 / 0 / 1/step]

3.SP Mode Tables

SP No.	Large Category	Small Category	ENG or CTL	[Min to Max/Init./Step]
065				
4-520-066	IBACC:DetectedValue	Latest:Y_P6	ENG*	[0 to 1023 / 0 / 1/step]
4-520-067	IBACC:DetectedValue	Latest:Y_P6	ENG*	[0 to 1023 / 0 / 1/step]
4-520-068	IBACC:DetectedValue	Latest:Y_P6	ENG*	[0 to 1023 / 0 / 1/step]
4-520-101	IBACC:DetectedValue	Reference:K_P1	ENG*	[0 to 1023 / 0 / 1/step]
4-520-102	IBACC:DetectedValue	Reference:K_P2	ENG*	[0 to 1023 / 0 / 1/step]
4-520-103	IBACC:DetectedValue	Reference:K_P3	ENG*	[0 to 1023 / 0 / 1/step]
4-520-104	IBACC:DetectedValue	Reference:K_P4	ENG*	[0 to 1023 / 0 / 1/step]
4-520-105	IBACC:DetectedValue	Reference:K_P5	ENG*	[0 to 1023 / 0 / 1/step]
4-520-106	IBACC:DetectedValue	Reference:K_P6	ENG*	[0 to 1023 / 0 / 1/step]
4-520-107	IBACC:DetectedValue	Reference:K_P6	ENG*	[0 to 1023 / 0 / 1/step]
4-520-108	IBACC:DetectedValue	Reference:K_P6	ENG*	[0 to 1023 / 0 / 1/step]
4-520-121	IBACC:DetectedValue	Reference:C_P1	ENG*	[0 to 1023 / 0 / 1/step]
4-520-122	IBACC:DetectedValue	Reference:C_P2	ENG*	[0 to 1023 / 0 / 1/step]
4-520-123	IBACC:DetectedValue	Reference:C_P3	ENG*	[0 to 1023 / 0 / 1/step]
4-520-124	IBACC:DetectedValue	Reference:C_P4	ENG*	[0 to 1023 / 0 / 1/step]
4-520-125	IBACC:DetectedValue	Reference:C_P5	ENG*	[0 to 1023 / 0 / 1/step]
4-520-126	IBACC:DetectedValue	Reference:C_P6	ENG*	[0 to 1023 / 0 / 1/step]
4-520-	IBACC:DetectedValue	Reference:C_P6	ENG*	[0 to 1023 / 0 / 1/step]

3.SP Mode Tables

SP No.	Large Category	Small Category	ENG or CTL	[Min to Max/Init./Step]
127				
4-520-128	IBACC:DetectedValue	Reference:C_P6	ENG*	[0 to 1023 / 0 / 1/step]
4-520-141	IBACC:DetectedValue	Reference:M_P1	ENG*	[0 to 1023 / 0 / 1/step]
4-520-142	IBACC:DetectedValue	Reference:M_P2	ENG*	[0 to 1023 / 0 / 1/step]
4-520-143	IBACC:DetectedValue	Reference:M_P3	ENG*	[0 to 1023 / 0 / 1/step]
4-520-144	IBACC:DetectedValue	Reference:M_P4	ENG*	[0 to 1023 / 0 / 1/step]
4-520-145	IBACC:DetectedValue	Reference:M_P5	ENG*	[0 to 1023 / 0 / 1/step]
4-520-146	IBACC:DetectedValue	Reference:M_P6	ENG*	[0 to 1023 / 0 / 1/step]
4-520-147	IBACC:DetectedValue	Reference:M_P6	ENG*	[0 to 1023 / 0 / 1/step]
4-520-148	IBACC:DetectedValue	Reference:M_P6	ENG*	[0 to 1023 / 0 / 1/step]
4-520-161	IBACC:DetectedValue	Reference:Y_P1	ENG*	[0 to 1023 / 0 / 1/step]
4-520-162	IBACC:DetectedValue	Reference:Y_P2	ENG*	[0 to 1023 / 0 / 1/step]
4-520-163	IBACC:DetectedValue	Reference:Y_P3	ENG*	[0 to 1023 / 0 / 1/step]
4-520-164	IBACC:DetectedValue	Reference:Y_P4	ENG*	[0 to 1023 / 0 / 1/step]
4-520-165	IBACC:DetectedValue	Reference:Y_P5	ENG*	[0 to 1023 / 0 / 1/step]
4-520-166	IBACC:DetectedValue	Reference:Y_P6	ENG*	[0 to 1023 / 0 / 1/step]
4-520-167	IBACC:DetectedValue	Reference:Y_P6	ENG*	[0 to 1023 / 0 / 1/step]
4-520-168	IBACC:DetectedValue	Reference:Y_P6	ENG*	[0 to 1023 / 0 / 1/step]
4-540-	Print Coverage	RY Phase: Option	ENG	[0 to 255 / 0 / 1/step]

3.SP Mode Tables

SP No.	Large Category	Small Category	ENG or CTL	[Min to Max/Init./Step]
001				
4-540-002	Print Coverage	RY Phase: R	ENG	[-256 to 255 / 0 / 1/step]
4-540-003	Print Coverage	RY Phase: G	ENG	[-256 to 255 / 0 / 1/step]
4-540-004	Print Coverage	RY Phase: B	ENG	[-256 to 255 / 0 / 1/step]
4-540-005	Print Coverage	YR Phase: Option	ENG	[0 to 255 / 0 / 1/step]
4-540-006	Print Coverage	YR Phase: R	ENG	[-256 to 255 / 0 / 1/step]
4-540-007	Print Coverage	YR Phase: G	ENG	[-256 to 255 / 0 / 1/step]
4-540-008	Print Coverage	YR Phase: B	ENG	[-256 to 255 / 0 / 1/step]
4-540-009	Print Coverage	YG Phase: Option	ENG	[0 to 255 / 0 / 1/step]
4-540-010	Print Coverage	YG Phase: R	ENG	[-256 to 255 / 0 / 1/step]
4-540-011	Print Coverage	YG Phase: G	ENG	[-256 to 255 / 0 / 1/step]
4-540-012	Print Coverage	YG Phase: B	ENG	[-256 to 255 / 0 / 1/step]
4-540-013	Print Coverage	GY Phase: Option	ENG	[0 to 255 / 0 / 1/step]
4-540-014	Print Coverage	GY Phase: R	ENG	[-256 to 255 / 0 / 1/step]
4-540-015	Print Coverage	GY Phase: G	ENG	[-256 to 255 / 0 / 1/step]
4-540-016	Print Coverage	GY Phase: B	ENG	[-256 to 255 / 0 / 1/step]
4-540-017	Print Coverage	GC Phase: Option	ENG	[0 to 255 / 0 / 1/step]
4-540-018	Print Coverage	GC Phase: R	ENG	[-256 to 255 / 0 / 1/step]
4-540-	Print Coverage	GC Phase: G	ENG	[-256 to 255 / 0 /

3.SP Mode Tables

SP No.	Large Category	Small Category	ENG or CTL	[Min to Max/Init./Step]
019				1/step]
4-540-020	Print Coverage	GC Phase: B	ENG	[-256 to 255 / 0 / 1/step]
4-540-021	Print Coverage	CG Phase: Option	ENG	[0 to 255 / 0 / 1/step]
4-540-022	Print Coverage	CG Phase: R	ENG	[-256 to 255 / 0 / 1/step]
4-540-023	Print Coverage	CG Phase: G	ENG	[-256 to 255 / 0 / 1/step]
4-540-024	Print Coverage	CG Phase: B	ENG	[-256 to 255 / 0 / 1/step]
4-540-025	Print Coverage	CB Phase: Option	ENG	[0 to 255 / 0 / 1/step]
4-540-026	Print Coverage	CB Phase: R	ENG	[-256 to 255 / 0 / 1/step]
4-540-027	Print Coverage	CB Phase: G	ENG	[-256 to 255 / 0 / 1/step]
4-540-028	Print Coverage	CB Phase: B	ENG	[-256 to 255 / 0 / 1/step]
4-540-029	Print Coverage	BC Phase: Option	ENG	[0 to 255 / 0 / 1/step]
4-540-030	Print Coverage	BC Phase: R	ENG	[-256 to 255 / 0 / 1/step]
4-540-031	Print Coverage	BC Phase: G	ENG	[-256 to 255 / 0 / 1/step]
4-540-032	Print Coverage	BC Phase: B	ENG	[-256 to 255 / 0 / 1/step]
4-540-033	Print Coverage	BM Phase: Option	ENG	[0 to 255 / 0 / 1/step]
4-540-034	Print Coverage	BM Phase: R	ENG	[-256 to 255 / 0 / 1/step]
4-540-035	Print Coverage	BM Phase: G	ENG	[-256 to 255 / 0 / 1/step]
4-540-036	Print Coverage	BM Phase: B	ENG	[-256 to 255 / 0 / 1/step]
4-540-	Print Coverage	MB Phase: Option	ENG	[0 to 255 / 0 / 1/step]

3.SP Mode Tables

SP No.	Large Category	Small Category	ENG or CTL	[Min to Max/Init./Step]
037				
4-540-038	Print Coverage	MB Phase: R	ENG	[-256 to 255 / 0 / 1/step]
4-540-039	Print Coverage	MB Phase: G	ENG	[-256 to 255 / 0 / 1/step]
4-540-040	Print Coverage	MB Phase: B	ENG	[-256 to 255 / 0 / 1/step]
4-540-041	Print Coverage	MR Phase: Option	ENG	[0 to 255 / 0 / 1/step]
4-540-042	Print Coverage	MR Phase: R	ENG	[-256 to 255 / 0 / 1/step]
4-540-043	Print Coverage	MR Phase: G	ENG	[-256 to 255 / 0 / 1/step]
4-540-044	Print Coverage	MR Phase: B	ENG	[-256 to 255 / 0 / 1/step]
4-540-045	Print Coverage	RM Phase: Option	ENG	[0 to 255 / 0 / 1/step]
4-540-046	Print Coverage	RM Phase: R	ENG	[-256 to 255 / 0 / 1/step]
4-540-047	Print Coverage	RM Phase: G	ENG	[-256 to 255 / 0 / 1/step]
4-540-048	Print Coverage	RM Phase: B	ENG	[-256 to 255 / 0 / 1/step]
4-540-049	Print Coverage	WHITE: Option	ENG	[0 to 255 / 0 / 1/step]
4-540-050	Print Coverage	WHITE:R	ENG	[-256 to 255 / 0 / 1/step]
4-540-051	Print Coverage	WHITE:G	ENG	[-256 to 255 / 0 / 1/step]
4-540-052	Print Coverage	WHITE:B	ENG	[-256 to 255 / 0 / 1/step]
4-540-053	Print Coverage	BLACK: Option	ENG	[0 to 255 / 0 / 1/step]
4-540-054	Print Coverage	BLACK:R	ENG	[-256 to 255 / 0 / 1/step]
4-540-	Print Coverage	BLACK:G	ENG	[-256 to 255 / 0 /

3.SP Mode Tables

SP No.	Large Category	Small Category	ENG or CTL	[Min to Max/Init./Step]
055				1/step]
4-540-056	Print Coverage	BLACK:B	ENG	[-256 to 255 / 0 / 1/step]
4-541-001	Photo Correction	Copied Photo	ENG*	[0 to 1 / 0 / 1/step]
4-550-005	Scan Apli:Txt/Print	MTF: 0(Off) 1-15 (Weak-Strong)	ENG	[0 to 15 / 8 / 1/step]
4-550-006	Scan Apli:Txt/Print	Smoothing: 0(x1) 1-7 (Weak-Strong)	ENG	[0 to 7 / 4 / 1/step]
4-550-007	Scan Apli:Txt/Print	Brightness: 1-255	ENG	[1 to 255 / 128 / 1/step]
4-550-008	Scan Apli:Txt/Print	Contrast: 1-255	ENG	[1 to 255 / 128 / 1/step]
4-550-009	Scan Apli:Txt/Print	Ind Dot Erase: 0(Off) 1-7 (Weak-Strong)	ENG	[0 to 7 / 0 / 1/step]
4-551-005	Scan Apli:Txt	MTF: 0(Off) 1-15 (Weak-Strong)	ENG	[0 to 15 / 8 / 1/step]
4-551-006	Scan Apli:Txt	Smoothing: 0(x1) 1-7 (Weak-Strong)	ENG	[0 to 7 / 4 / 1/step]
4-551-007	Scan Apli:Txt	Brightness: 1-255	ENG	[1 to 255 / 128 / 1/step]
4-551-008	Scan Apli:Txt	Contrast: 1-255	ENG	[1 to 255 / 128 / 1/step]
4-551-009	Scan Apli:Txt	Ind Dot Erase: 0(Off) 1-7 (Weak-Strong)	ENG	[0 to 7 / 0 / 1/step]
4-552-005	Scan Apli:Txt Dropout	MTF: 0(Off) 1-15 (Weak-Strong)	ENG	[0 to 15 / 8 / 1/step]
4-552-006	Scan Apli:Txt Dropout	Smoothing: 0(x1) 1-7 (Weak-Strong)	ENG	[0 to 7 / 4 / 1/step]
4-552-007	Scan Apli:Txt Dropout	Brightness: 1-255	ENG	[1 to 255 / 128 / 1/step]
4-552-008	Scan Apli:Txt Dropout	Contrast: 1-255	ENG	[1 to 255 / 128 / 1/step]
4-552-009	Scan Apli:Txt Dropout	Ind Dot Erase: 0(Off) 1-7 (Weak-Strong)	ENG	[0 to 7 / 0 / 1/step]
4-553-	Scan Apli:Txt/Photo	MTF: 0(Off) 1-15 (Weak-	ENG	[0 to 15 / 8 / 1/step]

3.SP Mode Tables

SP No.	Large Category	Small Category	ENG or CTL	[Min to Max/Init./Step]
005		Strong)		
4-553-006	Scan Apli:Txt/Photo	Smoothing: 0(x1) 1-7 (Weak-Strong)	ENG	[0 to 7 / 4 / 1/step]
4-553-007	Scan Apli:Txt/Photo	Brightness: 1-255	ENG	[1 to 255 / 128 / 1/step]
4-553-008	Scan Apli:Txt/Photo	Contrast: 1-255	ENG	[1 to 255 / 128 / 1/step]
4-553-009	Scan Apli:Txt/Photo	Ind Dot Erase: 0(Off) 1-7 (Weak-Strong)	ENG	[0 to 7 / 0 / 1/step]
4-554-005	Scan Apli:Photo	MTF: 0(Off) 1-15 (Weak-Strong)	ENG	[0 to 15 / 8 / 1/step]
4-554-006	Scan Apli:Photo	Smoothing: 0(x1) 1-7 (Weak-Strong)	ENG	[0 to 7 / 4 / 1/step]
4-554-007	Scan Apli:Photo	Brightness: 1-255	ENG	[1 to 255 / 128 / 1/step]
4-554-008	Scan Apli:Photo	Contrast: 1-255	ENG	[1 to 255 / 128 / 1/step]
4-554-009	Scan Apli:Photo	Ind Dot Erase: 0(Off) 1-7 (Weak-Strong)	ENG	[0 to 7 / 0 / 1/step]
4-565-005	Scan Apli:GrayScale	MTF: 0(Off) 1-15 (Weak-Strong)	ENG	[0 to 15 / 8 / 1/step]
4-565-006	Scan Apli:GrayScale	Smoothing: 0(x1) 1-7 (Weak-Strong)	ENG	[0 to 7 / 4 / 1/step]
4-565-007	Scan Apli:GrayScale	Brightness: 1-255	ENG	[1 to 255 / 128 / 1/step]
4-565-008	Scan Apli:GrayScale	Contrast: 1-255	ENG	[1 to 255 / 128 / 1/step]
4-565-009	Scan Apli:GrayScale	Ind Dot Erase: 0(Off) 1-7 (Weak-Strong)	ENG	[0 to 7 / 0 / 1/step]
4-570-005	Scan Apli:Col Txt/Photo	MTF: 0(Off) 1-15 (Weak-Strong)	ENG	[0 to 15 / 8 / 1/step]
4-570-006	Scan Apli:Col Txt/Photo	Smoothing: 0(x1) 1-7 (Weak-Strong)	ENG	[0 to 7 / 4 / 1/step]
4-570-007	Scan Apli:Col Txt/Photo	Brightness: 1-255	ENG	[1 to 255 / 128 / 1/step]
4-570-	Scan Apli:Col Txt/Photo	Contrast: 1-255	ENG	[1 to 255 / 128 /

3.SP Mode Tables

SP No.	Large Category	Small Category	ENG or CTL	[Min to Max/Init./Step]
008				1/step]
4-570-009	Scan Apli:Col Txt/Photo	Ind Dot Erase: 0(Off) 1-7 (Weak-Strong)	ENG	[0 to 7 / 0 / 1/step]
4-571-005	Scan Apli:Col Gloss Photo	MTF: 0(Off) 1-15 (Weak-Strong)	ENG	[0 to 15 / 8 / 1/step]
4-571-006	Scan Apli:Col Gloss Photo	Smoothing: 0(x1) 1-7 (Weak-Strong)	ENG	[0 to 7 / 4 / 1/step]
4-571-007	Scan Apli:Col Gloss Photo	Brightness: 1-255	ENG	[1 to 255 / 128 / 1/step]
4-571-008	Scan Apli:Col Gloss Photo	Contrast: 1-255	ENG	[1 to 255 / 128 / 1/step]
4-571-009	Scan Apli:Col Gloss Photo	Ind Dot Erase: 0(Off) 1-7 (Weak-Strong)	ENG	[0 to 7 / 0 / 1/step]
4-572-005	Scan Apli:AutoCol	MTF: 0(Off) 1-15 (Weak-Strong)	ENG	[0 to 15 / 8 / 1/step]
4-572-006	Scan Apli:AutoCol	Smoothing: 0(x1) 1-7 (Weak-Strong)	ENG	[0 to 7 / 4 / 1/step]
4-572-007	Scan Apli:AutoCol	Brightness: 1-255	ENG	[1 to 255 / 128 / 1/step]
4-572-008	Scan Apli:AutoCol	Contrast: 1-255	ENG	[1 to 255 / 128 / 1/step]
4-572-009	Scan Apli:AutoCol	Ind Dot Erase: 0(Off) 1-7 (Weak-Strong)	ENG	[0 to 7 / 0 / 1/step]
4-573-005	Scan Apli:Shiny Materials	MTF: 0(Off) 1-15 (Weak-Strong)	ENG	[0 to 15 / 8 / 1/step]
4-573-006	Scan Apli:Shiny Materials	Smoothing: 0(x1) 1-7 (Weak-Strong)	ENG	[0 to 7 / 4 / 1/step]
4-573-007	Scan Apli:Shiny Materials	Brightness: 1-255	ENG	[1 to 255 / 128 / 1/step]
4-573-008	Scan Apli:Shiny Materials	Contrast: 1-255	ENG	[1 to 255 / 128 / 1/step]
4-573-009	Scan Apli:Shiny Materials	Ind Dot Erase: 0(Off) 1-7 (Weak-Strong)	ENG	[0 to 7 / 0 / 1/step]
4-580-005	Fax Apli:Txt/Chart	MTF: 0(Off) 1-15 (Weak-Strong)	ENG	[0 to 15 / 8 / 1/step]
4-580-	Fax Apli:Txt/Chart	Smoothing: 0(x1) 1-7 (Weak-	ENG	[0 to 7 / 4 / 1/step]

3.SP Mode Tables

SP No.	Large Category	Small Category	ENG or CTL	[Min to Max/Init./Step]
006		Strong)		
4-580-007	Fax Apli:Txt/Chart	Brightness: 1-255	ENG	[1 to 255 / 128 / 1/step]
4-580-008	Fax Apli:Txt/Chart	Contrast: 1-255	ENG	[1 to 255 / 128 / 1/step]
4-580-009	Fax Apli:Txt/Chart	Ind Dot Erase: 0(Off) 1-7 (Weak-Strong)	ENG	[0 to 7 / 0 / 1/step]
4-580-010	Fax Apli:Txt/Chart	Texture Erase: 0	ENG	[0 to 2 / 0 / 1/step]
4-581-005	Fax Apli:Txt	MTF: 0(Off) 1-15 (Weak-Strong)	ENG	[0 to 15 / 8 / 1/step]
4-581-006	Fax Apli:Txt	Smoothing: 0(x1) 1-7 (Weak-Strong)	ENG	[0 to 7 / 4 / 1/step]
4-581-007	Fax Apli:Txt	Brightness: 1-255	ENG	[1 to 255 / 128 / 1/step]
4-581-008	Fax Apli:Txt	Contrast: 1-255	ENG	[1 to 255 / 128 / 1/step]
4-581-009	Fax Apli:Txt	Ind Dot Erase: 0(Off) 1-7 (Weak-Strong)	ENG	[0 to 7 / 0 / 1/step]
4-582-005	Fax Apli:Txt/Photo	MTF: 0(Off) 1-15 (Weak-Strong)	ENG	[0 to 15 / 8 / 1/step]
4-582-006	Fax Apli:Txt/Photo	Smoothing: 0(x1) 1-7 (Weak-Strong)	ENG	[0 to 7 / 4 / 1/step]
4-582-007	Fax Apli:Txt/Photo	Brightness: 1-255	ENG	[1 to 255 / 128 / 1/step]
4-582-008	Fax Apli:Txt/Photo	Contrast: 1-255	ENG	[1 to 255 / 128 / 1/step]
4-582-009	Fax Apli:Txt/Photo	Ind Dot Erase: 0(Off) 1-7 (Weak-Strong)	ENG	[0 to 7 / 0 / 1/step]
4-582-010	Fax Apli:Txt/Photo	Texture Erase: 0	ENG	[0 to 2 / 0 / 1/step]
4-583-005	Fax Apli:Photo	MTF: 0(Off) 1-15 (Weak-Strong)	ENG	[0 to 15 / 8 / 1/step]
4-583-006	Fax Apli:Photo	Smoothing: 0(x1) 1-7 (Weak-Strong)	ENG	[0 to 7 / 4 / 1/step]
4-583-	Fax Apli:Photo	Brightness: 1-255	ENG	[1 to 255 / 128 /

3.SP Mode Tables

SP No.	Large Category	Small Category	ENG or CTL	[Min to Max/Init./Step]
007				1/step]
4-583-008	Fax Apli:Photo	Contrast: 1-255	ENG	[1 to 255 / 128 / 1/step]
4-583-009	Fax Apli:Photo	Ind Dot Erase: 0(Off) 1-7 (Weak-Strong)	ENG	[0 to 7 / 0 / 1/step]
4-583-010	Fax Apli:Photo	Texture Erase: 0	ENG	[0 to 2 / 0 / 1/step]
4-584-005	Fax Apli:Original 1	MTF: 0(Off) 1-15 (Weak-Strong)	ENG	[0 to 15 / 8 / 1/step]
4-584-006	Fax Apli:Original 1	Smoothing: 0(x1) 1-7 (Weak-Strong)	ENG	[0 to 7 / 4 / 1/step]
4-584-007	Fax Apli:Original 1	Brightness: 1-255	ENG	[1 to 255 / 128 / 1/step]
4-584-008	Fax Apli:Original 1	Contrast: 1-255	ENG	[1 to 255 / 128 / 1/step]
4-584-009	Fax Apli:Original 1	Ind Dot Erase: 0(Off) 1-7 (Weak-Strong)	ENG	[0 to 7 / 0 / 1/step]
4-585-005	Fax Apli:Original 2	MTF: 0(Off) 1-15 (Weak-Strong)	ENG	[0 to 15 / 8 / 1/step]
4-585-006	Fax Apli:Original 2	Smoothing: 0(x1) 1-7 (Weak-Strong)	ENG	[0 to 7 / 4 / 1/step]
4-585-007	Fax Apli:Original 2	Brightness: 1-255	ENG	[1 to 255 / 128 / 1/step]
4-585-008	Fax Apli:Original 2	Contrast: 1-255	ENG	[1 to 255 / 128 / 1/step]
4-585-009	Fax Apli:Original 2	Independent Dot Erase (0)/ 1-7 (Strong)	ENG	[0 to 7 / 0 / 1/step]
4-600-001	SBU Version Display	SBU ID	ENG	[0x0000 to 0xFFFF / 0 / 1/step]
4-609-001	Gray Balance Set: R	Book Scan	ENG*	[-384 to 255 / -100 / 1digit/step]
4-609-002	Gray Balance Set: R	DF Scan	ENG*	[-384 to 255 / -100 / 1digit/step]
4-610-001	Gray Balance Set: G	Book Scan	ENG*	[-384 to 255 / -100 / 1digit/step]
4-610-	Gray Balance Set: G	DF Scan	ENG*	[-384 to 255 / -100 /

3.SP Mode Tables

SP No.	Large Category	Small Category	ENG or CTL	[Min to Max/Init./Step]
002				1digit/step]
4-611-001	Gray Balance Set: B	Book Scan	ENG*	[-384 to 255 / -100 / 1digit/step]
4-611-002	Gray Balance Set: B	DF Scan	ENG*	[-384 to 255 / -100 / 1digit/step]
4-646-001	Scan Adjust Error	White level	ENG*	[0 to 65535 / 0 / 1/step]
4-646-002	Scan Adjust Error	Black level	ENG*	[0 to 65535 / 0 / 1/step]
4-647-001	Scanner Hard Error	Power-ON	ENG	[0 to 65535 / 0 / 1/step]
4-688-001	DF Density Adjustment	ARDF	ENG*	[80 to 120 / 104 / 1%/step]
4-688-002	Scan Image Density Adjustment	1-pass DF	ENG*	[80 to 120 / 101 / 1%/step]
4-699-001	SBU Test Pattern Change		ENG	[0 to 255 / 0 / 1/step]
4-700-001	CIS ID Display		ENG	[0x00 to 0xFF / 0 / 1/step]
4-712-001	CIS GB Adj. Value: R		ENG*	[0 to 2048 / 1023 / 1digit/step]
4-713-001	CIS GB Adj. Value: G		ENG*	[0 to 2048 / 1023 / 1digit/step]
4-714-001	CIS GB Adj. Value: B		ENG*	[0 to 2048 / 1023 / 1digit/step]
4-730-001	FROM ADF Factory Setting	CIS Parameter	ENG	[0 to 1 / 0 / 0/step]
4-730-002	FROM Main Factory Setting	Execution ON/OFF	ENG	[0 to 1 / 0 / 0/step]
4-730-003	FROM Main Factory Setting	Execution Flag	ENG*	[0 to 1 / 0 / 1/step]
4-730-004	FROM Data Update		ENG	[0 to 1 / 0 / 0/step]
4-745-001	CIS Image Level Error Flag		ENG	[0 to 65535 / 0 / 1/step]
4-746-	CIS GB Adj Error Flag		ENG	[0 to 7 / 0 / 1/step]

3.SP Mode Tables

SP No.	Large Category	Small Category	ENG or CTL	[Min to Max/Init./Step]
001				
4-747-001	CIS Hard Error Flag		ENG	[0 to 15 / 0 / 1/step]
4-796-001	Low Density Color Correction	Front Side	ENG*	[0 to 3 / 0 / 1/step]
4-796-002	Low Density Color Correction	Rear Side	ENG*	[0 to 3 / 0 / 1/step]
4-797-001	Rear Side: Digital AE	Low Limit Setting	ENG	[0 to 1023 / 364 / 1/step]
4-797-002	Rear Side: Digital AE	Background Erase Level	ENG*	[512 to 1535 / 932 / 1/step]
4-799-001	CIS TEST Pattern	select	ENG	[0 to 5 / 0 / 1/step]
4-799-002	CIS TEST Pattern	Even Output Level Setting	ENG	[0 to 1023 / 0 / 1digit/step]
4-799-003	CIS TEST Pattern	Odd Output Level Setting	ENG	[0 to 1023 / 0 / 1digit/step]
4-803-001	Home Position Adj Value		ENG*	[-2.0 to 2.0 / 0.0 / 0.1mm/step]
4-853-001	Partial LED ON	ON/OFF(Scan)	ENG*	[0 to 1 / 1 / 1/step]
4-853-002	Partial LED ON	ON/OFF(Size Detection)	ENG*	[0 to 1 / 1 / 1/step]
4-871-001	Distortion Corr.	Distortion Corr. ON/OFF	ENG	[0 to 1 / 1 / 1/step]
4-871-002	Distortion Corr.	Distortion Initialization	ENG	[0 to 21 / 0 / 1/step]
4-871-003	Distortion Corr.	Magnification Adjust(DF)	ENG*	[-0.35 to 0.35 / 0.11 / 0.01%/step]
4-871-004	Distortion Corr.	Magnification Adjust(FB)	ENG*	[-0.35 to 0.35 / 0.00 / 0.01%/step]
4-902-001	Disp ACC Data	ditect patch(up)1	ENG	[0 to 255 / 0 / 1/step]
4-902-002	Disp ACC Data	ditect patch(up)2	ENG	[0 to 255 / 0 / 1/step]
4-902-003	Disp ACC Data	ditect patch(up)3	ENG	[0 to 255 / 0 / 1/step]

3.SP Mode Tables

SP No.	Large Category	Small Category	ENG or CTL	[Min to Max/Init./Step]
003				
4-902-004	Disp ACC Data	ditect patch(up)4	ENG	[0 to 255 / 0 / 1/step]
4-902-005	Disp ACC Data	ditect patch(up)5	ENG	[0 to 255 / 0 / 1/step]
4-902-006	Disp ACC Data	ditect patch(up)6	ENG	[0 to 255 / 0 / 1/step]
4-902-007	Disp ACC Data	ditect patch(up)7	ENG	[0 to 255 / 0 / 1/step]
4-902-008	Disp ACC Data	ditect patch(up)8	ENG	[0 to 255 / 0 / 1/step]
4-902-009	Disp ACC Data	ditect patch(up)9	ENG	[0 to 255 / 0 / 1/step]
4-902-010	Disp ACC Data	ditect patch(up)10	ENG	[0 to 255 / 0 / 1/step]
4-902-011	Disp ACC Data	ditect patch(up)11	ENG	[0 to 255 / 0 / 1/step]
4-902-012	Disp ACC Data	ditect patch(up)12	ENG	[0 to 255 / 0 / 1/step]
4-902-013	Disp ACC Data	ditect patch(up)13	ENG	[0 to 255 / 0 / 1/step]
4-902-014	Disp ACC Data	ditect patch(up)14	ENG	[0 to 255 / 0 / 1/step]
4-902-015	Disp ACC Data	ditect patch(up)15	ENG	[0 to 255 / 0 / 1/step]
4-902-016	Disp ACC Data	ditect patch(up)16	ENG	[0 to 255 / 0 / 1/step]
4-902-017	Disp ACC Data	ditect patch(up)17	ENG	[0 to 255 / 0 / 1/step]
4-902-018	Disp ACC Data	ditect patch(up)18	ENG	[0 to 255 / 0 / 1/step]
4-902-019	Disp ACC Data	ditect patch(up)19	ENG	[0 to 255 / 0 / 1/step]
4-902-020	Disp ACC Data	ditect patch(up)20	ENG	[0 to 255 / 0 / 1/step]
4-902-	Disp ACC Data	K patch (text)1	ENG	[0 to 255 / 0 / 1/step]

3.SP Mode Tables

SP No.	Large Category	Small Category	ENG or CTL	[Min to Max/Init./Step]
021				
4-902-038	Disp ACC Data	K patch (text)18	ENG	[0 to 255 / 0 / 1/step]
4-902-039	Disp ACC Data	K patch (text)19	ENG	[0 to 255 / 0 / 1/step]
4-902-040	Disp ACC Data	K patch (text)20	ENG	[0 to 255 / 0 / 1/step]
4-902-041	Disp ACC Data	C patch (text)1	ENG	[0 to 255 / 0 / 1/step]
4-902-058	Disp ACC Data	C patch (text)18	ENG	[0 to 255 / 0 / 1/step]
4-902-059	Disp ACC Data	C patch (text)19	ENG	[0 to 255 / 0 / 1/step]
4-902-060	Disp ACC Data	C patch (text)20	ENG	[0 to 255 / 0 / 1/step]
4-902-061	Disp ACC Data	M patch (text)1	ENG	[0 to 255 / 0 / 1/step]
4-902-078	Disp ACC Data	M patch (text)18	ENG	[0 to 255 / 0 / 1/step]
4-902-079	Disp ACC Data	M patch (text)19	ENG	[0 to 255 / 0 / 1/step]
4-902-080	Disp ACC Data	M patch (text)20	ENG	[0 to 255 / 0 / 1/step]
4-902-081	Disp ACC Data	Y patch (text)1	ENG	[0 to 255 / 0 / 1/step]
4-902-098	Disp ACC Data	Y patch (text)18	ENG	[0 to 255 / 0 / 1/step]
4-902-099	Disp ACC Data	Y patch (text)19	ENG	[0 to 255 / 0 / 1/step]
4-902-100	Disp ACC Data	Y patch (text)20	ENG	[0 to 255 / 0 / 1/step]
4-902-101	Disp ACC Data	K patch (photo)1	ENG	[0 to 255 / 0 / 1/step]
4-902-118	Disp ACC Data	K patch (photo)18	ENG	[0 to 255 / 0 / 1/step]
4-902-	Disp ACC Data	K patch (photo)19	ENG	[0 to 255 / 0 / 1/step]

3.SP Mode Tables

SP No.	Large Category	Small Category	ENG or CTL	[Min to Max/Init./Step]
119				
4-902-120	Disp ACC Data	K patch (photo)20	ENG	[0 to 255 / 0 / 1/step]
4-902-121	Disp ACC Data	C patch (photo)1	ENG	[0 to 255 / 0 / 1/step]
4-902-138	Disp ACC Data	C patch (photo)18	ENG	[0 to 255 / 0 / 1/step]
4-902-139	Disp ACC Data	C patch (photo)19	ENG	[0 to 255 / 0 / 1/step]
4-902-140	Disp ACC Data	C patch (photo)20	ENG	[0 to 255 / 0 / 1/step]
4-902-141	Disp ACC Data	M patch (photo)1	ENG	[0 to 255 / 0 / 1/step]
4-902-158	Disp ACC Data	M patch (photo)18	ENG	[0 to 255 / 0 / 1/step]
4-902-159	Disp ACC Data	M patch (photo)19	ENG	[0 to 255 / 0 / 1/step]
4-902-160	Disp ACC Data	M patch (photo)20	ENG	[0 to 255 / 0 / 1/step]
4-902-161	Disp ACC Data	Y patch (photo)1	ENG	[0 to 255 / 0 / 1/step]
4-902-178	Disp ACC Data	Y patch (photo)18	ENG	[0 to 255 / 0 / 1/step]
4-902-179	Disp ACC Data	Y patch (photo)19	ENG	[0 to 255 / 0 / 1/step]
4-902-180	Disp ACC Data	Y patch (photo)20	ENG	[0 to 255 / 0 / 1/step]
4-902-181	Disp ACC Data	ditectpatch down1	ENG	[0 to 255 / 0 / 1/step]
4-902-182	Disp ACC Data	ditectpatch down2	ENG	[0 to 255 / 0 / 1/step]
4-902-183	Disp ACC Data	ditectpatch down3	ENG	[0 to 255 / 0 / 1/step]
4-902-184	Disp ACC Data	ditectpatch down4	ENG	[0 to 255 / 0 / 1/step]
4-902-	Disp ACC Data	ditectpatch down5	ENG	[0 to 255 / 0 / 1/step]

3.SP Mode Tables

SP No.	Large Category	Small Category	ENG or CTL	[Min to Max/Init./Step]
185				
4-902-186	Disp ACC Data	ditectpatch down6	ENG	[0 to 255 / 0 / 1/step]
4-902-187	Disp ACC Data	ditectpatch down7	ENG	[0 to 255 / 0 / 1/step]
4-902-188	Disp ACC Data	ditectpatch down8	ENG	[0 to 255 / 0 / 1/step]
4-902-189	Disp ACC Data	ditectpatch down9	ENG	[0 to 255 / 0 / 1/step]
4-902-190	Disp ACC Data	ditectpatch down10	ENG	[0 to 255 / 0 / 1/step]
4-902-191	Disp ACC Data	ditectpatch down11	ENG	[0 to 255 / 0 / 1/step]
4-902-192	Disp ACC Data	ditectpatch down12	ENG	[0 to 255 / 0 / 1/step]
4-902-193	Disp ACC Data	ditectpatch down13	ENG	[0 to 255 / 0 / 1/step]
4-902-194	Disp ACC Data	ditectpatch down14	ENG	[0 to 255 / 0 / 1/step]
4-902-195	Disp ACC Data	ditectpatch down15	ENG	[0 to 255 / 0 / 1/step]
4-902-196	Disp ACC Data	ditectpatch down16	ENG	[0 to 255 / 0 / 1/step]
4-902-197	Disp ACC Data	ditectpatch down17	ENG	[0 to 255 / 0 / 1/step]
4-902-198	Disp ACC Data	ditectpatch down18	ENG	[0 to 255 / 0 / 1/step]
4-902-199	Disp ACC Data	ditectpatch down19	ENG	[0 to 255 / 0 / 1/step]
4-902-200	Disp ACC Data	ditectpatch down20	ENG	[0 to 255 / 0 / 1/step]
4-903-001	Filter Setting	Ind Dot Erase: Text	ENG*	[0 to 7 / 0 / 1/step]
4-903-002	Filter Setting	Ind Dot Erase: Generation Copy	ENG*	[0 to 7 / 0 / 1/step]
4-905-	Select Gradation Level		ENG*	[0 to 255 / 0 / 1/step]

3.SP Mode Tables

SP No.	Large Category	Small Category	ENG or CTL	[Min to Max/Init./Step]
001				
4-907-001	Gamma Correction	Stamp Entry	ENG	[0 to 2 / 1 / 1/step]
4-918-009	Man Gamma Adj		ENG	[0 to 0 / 0 / 0/step]
4-930-001	Coverage Ctrl: Text	Copy: Full Color 1	ENG	[0 to 400 / 200 / 1/step]
4-930-002	Coverage Ctrl: Text	Copy: Full Color 2	ENG	[0 to 400 / 200 / 1/step]
4-930-003	Coverage Ctrl: Text	Copy: Single Color	ENG	[0 to 400 / 100 / 1/step]
4-930-004	Coverage Ctrl: Text	Copy: Color Conversion	ENG	[0 to 400 / 180 / 1/step]
4-930-005	Coverage Ctrl: Text	Coverage Ctrl OFF	ENG	[0 to 400 / 400 / 1/step]
4-931-001	Coverage Ctrl: Photo	Copy: Full Color 1	ENG	[0 to 400 / 240 / 1/step]
4-931-002	Coverage Ctrl: Photo	Copy: Full Color 2	ENG	[0 to 400 / 260 / 1/step]
4-931-003	Coverage Ctrl: Photo	Copy: Single Color	ENG	[0 to 400 / 100 / 1/step]
4-931-004	Coverage Ctrl: Photo	Copy: Color Conversion	ENG	[0 to 400 / 200 / 1/step]
4-931-005	Coverage Ctrl: Photo	Coverage Ctrl OFF	ENG	[0 to 400 / 400 / 1/step]
4-938-001	ACS:Edge Mask	Copy:Sub LEdge	ENG*	[0 to 31 / 10 / 1mm/step]
4-938-002	ACS:Edge Mask	Copy:Sub TEdge	ENG*	[0 to 31 / 10 / 1mm/step]
4-938-003	ACS:Edge Mask	Copy:Main LEdge	ENG*	[0 to 31 / 10 / 1mm/step]
4-938-004	ACS:Edge Mask	Copy:Main TEdge	ENG*	[0 to 31 / 10 / 1mm/step]
4-938-005	ACS:Edge Mask	Scan:Sub LEdge	ENG*	[0 to 31 / 15 / 1mm/step]
4-938-	ACS:Edge Mask	Scan:Sub TEdge	ENG*	[0 to 31 / 15 /

3.SP Mode Tables

SP No.	Large Category	Small Category	ENG or CTL	[Min to Max/Init./Step]
006				1mm/step]
4-938-007	ACS:Edge Mask	Scan:Main LEdge	ENG*	[0 to 31 / 15 / 1mm/step]
4-938-008	ACS:Edge Mask	Scan:Main TEdge	ENG*	[0 to 31 / 15 / 1mm/step]
4-939-001	ACS:Color Range		ENG*	[-2 to 2 / 0 / 1/step]
4-950-001	ACC Position Error Count		ENG	[0 to 65535 / 0 / 1/step]
4-954-005	Restore Test Chart	Chromaticity Rank	ENG*	[0 to 255 / 0 / 1/step]
4-958-005	Restore Test Chart: Rear	Chromaticity Rank	ENG*	[0 to 255 / 0 / 1/step]
4-984-001	IBACC Target Den	IBACC notch K	ENG*	[0 to 10 / 5 / 1/step]
4-984-002	IBACC Target Den	IBACC notch C	ENG*	[0 to 10 / 5 / 1/step]
4-984-003	IBACC Target Den	IBACC notch M	ENG*	[0 to 10 / 5 / 1/step]
4-984-004	IBACC Target Den	IBACC notch Y	ENG*	[0 to 10 / 5 / 1/step]
4-993-001	High Light Correction	Sensitivity Selection	ENG	[0 to 9 / 4 / 1/step]
4-993-002	High Light Correction	Range Selection	ENG	[0 to 9 / 4 / 1/step]
4-994-001	Adj Txt/Photo Recog Level	High Compression PDF	ENG	[0 to 2 / 1 / 1/step]
4-996-001	White Paper Detection Level	strength(fax)	ENG	[0 to 6 / 3 / 1/step]
4-997-001	White Paper count conditions	conditions 1	ENG	[0 to 255 / 255 / 1/step]
4-997-002	White Paper count conditions	conditions 2	ENG	[0 to 255 / 255 / 1/step]
4-997-003	White Paper count conditions	conditions 3	ENG	[0 to 255 / 80 / 1/step]
4-997-004	White Paper count	conditions 4	ENG	[0 to 16777215 /

3.SP Mode Tables

SP No.	Large Category	Small Category	ENG or CTL	[Min to Max/Init./Step]
004	conditions			16777215 / 1/step]
4-998-001	White Paper Binary thresh	strength 0:up side	ENG	[0 to 255 / 20 / 1/step]
4-998-002	White Paper Binary thresh	strength 1:up side	ENG	[0 to 255 / 36 / 1/step]
4-998-003	White Paper Binary thresh	strength 2:up side	ENG	[0 to 255 / 52 / 1/step]
4-998-004	White Paper Binary thresh	strength 3:up side	ENG	[0 to 255 / 68 / 1/step]
4-998-005	White Paper Binary thresh	strength 4:up side	ENG	[0 to 255 / 84 / 1/step]
4-998-006	White Paper Binary thresh	strength 5:up side	ENG	[0 to 255 / 100 / 1/step]
4-998-007	White Paper Binary thresh	strength 6:up side	ENG	[0 to 255 / 116 / 1/step]
4-998-008	White Paper Binary thresh	strength 0:down side	ENG	[0 to 255 / 20 / 1/step]
4-998-009	White Paper Binary thresh	strength 1:down side	ENG	[0 to 255 / 36 / 1/step]
4-998-010	White Paper Binary thresh	strength 2:down side	ENG	[0 to 255 / 52 / 1/step]
4-998-011	White Paper Binary thresh	strength 3:down side	ENG	[0 to 255 / 68 / 1/step]
4-998-012	White Paper Binary thresh	strength 4:down side	ENG	[0 to 255 / 84 / 1/step]
4-998-013	White Paper Binary thresh	strength 5:down side	ENG	[0 to 255 / 100 / 1/step]
4-998-014	White Paper Binary thresh	strength 6:down side	ENG	[0 to 255 / 116 / 1/step]

Engine SP Tables-5

SP5-XXX (Mode)

SP No.	Large Category	Small Category	ENG or CTL	[Min to Max/Init./Step]
5-126-001	Set F-size Document		ENG	[0 to 2 / 0 / 1/step]

3.SP Mode Tables

SP No.	Large Category	Small Category	ENG or CTL	[Min to Max/Init./Step]
5-131-001	Paper Size Type Selection		ENG*	IM C6000: TWN: [0 to 2 / 2 / 1/step] NA: [0 to 2 / 1 / 1/step] KOR: [0 to 2 / 2 / 1/step] EU: [0 to 2 / 2 / 1/step] CHN: [0 to 2 / 2 / 1/step] AS: [0 to 2 / 2 / 1/step] IM C5500: TWN: [0 to 2 / 2 / 1/step] NA: [0 to 2 / 1 / 1/step] KOR: [0 to 2 / 2 / 1/step] EU: [0 to 2 / 2 / 1/step] CHN: [0 to 2 / 2 / 1/step] AS: [0 to 2 / 2 / 1/step] IM C4500: TWN: [0 to 2 / 2 / 1/step] NA: [0 to 2 / 1 / 1/step] KOR: [0 to 2 / 2 / 1/step] EU: [0 to 2 / 2 / 1/step] CHN: [0 to 2 / 2 / 1/step]

3.SP Mode Tables

SP No.	Large Category	Small Category	ENG or CTL	[Min to Max/Init./Step]
				AS: [0 to 2 / 2 / 1/step]
5-135-001	LG_Oficio Change		ENG*	[0 to 1 / 0 / 1/step]
5-181-001	Size Adjust	TRAY 1	ENG*	IM C6000: TWN: [0 to 3 / 0 / 1/step] NA: [0 to 3 / 1 / 1/step] KOR: [0 to 3 / 0 / 1/step] EU: [0 to 3 / 0 / 1/step] CHN: [0 to 3 / 0 / 1/step] AS: [0 to 3 / 0 / 1/step] IM C5500: TWN: [0 to 3 / 0 / 1/step] NA: [0 to 3 / 1 / 1/step] KOR: [0 to 3 / 0 / 1/step] EU: [0 to 3 / 0 / 1/step] CHN: [0 to 3 / 0 / 1/step] AS: [0 to 3 / 0 / 1/step] IM C4500: TWN: [0 to 3 / 0 / 1/step] NA: [0 to 3 / 1 / 1/step] KOR: [0 to 3 / 0 / 1/step]

3.SP Mode Tables

SP No.	Large Category	Small Category	ENG or CTL	[Min to Max/Init./Step]
				EU: [0 to 3 / 0 / 1/step] CHN: [0 to 3 / 0 / 1/step] AS: [0 to 3 / 0 / 1/step]
5-181-002	Size Adjust	TRAY 2: 1	ENG*	IM C6000: TWN: [0 to 1 / 0 / 1/step] NA: [0 to 1 / 1 / 1/step] KOR: [0 to 1 / 0 / 1/step] EU: [0 to 1 / 0 / 1/step] CHN: [0 to 1 / 0 / 1/step] AS: [0 to 1 / 0 / 1/step] IM C5500: TWN: [0 to 1 / 0 / 1/step] NA: [0 to 1 / 1 / 1/step] KOR: [0 to 1 / 0 / 1/step] EU: [0 to 1 / 0 / 1/step] CHN: [0 to 1 / 0 / 1/step] AS: [0 to 1 / 0 / 1/step] IM C4500: TWN: [0 to 1 / 0 / 1/step] NA: [0 to 1 / 1 / 1/step]

3.SP Mode Tables

SP No.	Large Category	Small Category	ENG or CTL	[Min to Max/Init./Step]
				KOR: [0 to 1 / 0 / 1/step] EU: [0 to 1 / 0 / 1/step] CHN: [0 to 1 / 0 / 1/step] AS: [0 to 1 / 0 / 1/step]
5-181-003	Size Adjust	TRAY 2: 2	ENG*	IM C6000: TWN: [0 to 1 / 0 / 1/step] NA: [0 to 1 / 1 / 1/step] KOR: [0 to 1 / 0 / 1/step] EU: [0 to 1 / 0 / 1/step] CHN: [0 to 1 / 0 / 1/step] AS: [0 to 1 / 0 / 1/step] IM C5500: TWN: [0 to 1 / 0 / 1/step] NA: [0 to 1 / 1 / 1/step] KOR: [0 to 1 / 0 / 1/step] EU: [0 to 1 / 0 / 1/step] CHN: [0 to 1 / 0 / 1/step] AS: [0 to 1 / 0 / 1/step] IM C4500: TWN: [0 to 1 / 0 / 1/step]

3.SP Mode Tables

SP No.	Large Category	Small Category	ENG or CTL	[Min to Max/Init./Step]
				NA: [0 to 1 / 1 / 1/step] KOR: [0 to 1 / 0 / 1/step] EU: [0 to 1 / 0 / 1/step] CHN: [0 to 1 / 0 / 1/step] AS: [0 to 1 / 0 / 1/step]
5-181-004	Size Adjust	TRAY 2: 3	ENG*	IM C6000: TWN: [0 to 1 / 0 / 1/step] NA: [0 to 1 / 1 / 1/step] KOR: [0 to 1 / 0 / 1/step] EU: [0 to 1 / 0 / 1/step] CHN: [0 to 1 / 0 / 1/step] AS: [0 to 1 / 0 / 1/step] IM C5500: TWN: [0 to 1 / 0 / 1/step] NA: [0 to 1 / 1 / 1/step] KOR: [0 to 1 / 0 / 1/step] EU: [0 to 1 / 0 / 1/step] CHN: [0 to 1 / 0 / 1/step] AS: [0 to 1 / 0 / 1/step] IM C4500:

3.SP Mode Tables

SP No.	Large Category	Small Category	ENG or CTL	[Min to Max/Init./Step]
				TWN: [0 to 1 / 0 / 1/step] NA: [0 to 1 / 1 / 1/step] KOR: [0 to 1 / 0 / 1/step] EU: [0 to 1 / 0 / 1/step] CHN: [0 to 1 / 0 / 1/step] AS: [0 to 1 / 0 / 1/step]
5-181-005	Size Adjust	TRAY 2: 4	ENG*	IM C6000: TWN: [0 to 1 / 0 / 1/step] NA: [0 to 1 / 1 / 1/step] KOR: [0 to 1 / 0 / 1/step] EU: [0 to 1 / 0 / 1/step] CHN: [0 to 1 / 0 / 1/step] AS: [0 to 1 / 0 / 1/step] IM C5500: TWN: [0 to 1 / 0 / 1/step] NA: [0 to 1 / 1 / 1/step] KOR: [0 to 1 / 0 / 1/step] EU: [0 to 1 / 0 / 1/step] CHN: [0 to 1 / 0 / 1/step] AS: [0 to 1 / 0 / 1/step]

3.SP Mode Tables

SP No.	Large Category	Small Category	ENG or CTL	[Min to Max/Init./Step]
				1/step] IM C4500: TWN: [0 to 1 / 0 / 1/step] NA: [0 to 1 / 1 / 1/step] KOR: [0 to 1 / 0 / 1/step] EU: [0 to 1 / 0 / 1/step] CHN: [0 to 1 / 0 / 1/step] AS: [0 to 1 / 0 / 1/step]
5-181-006	Size Adjust	TRAY 2: 5	ENG*	IM C6000: TWN: [0 to 1 / 0 / 1/step] NA: [0 to 1 / 1 / 1/step] KOR: [0 to 1 / 0 / 1/step] EU: [0 to 1 / 0 / 1/step] CHN: [0 to 1 / 0 / 1/step] AS: [0 to 1 / 0 / 1/step] IM C5500: TWN: [0 to 1 / 0 / 1/step] NA: [0 to 1 / 1 / 1/step] KOR: [0 to 1 / 0 / 1/step] EU: [0 to 1 / 0 / 1/step] CHN: [0 to 1 / 0 /

3.SP Mode Tables

SP No.	Large Category	Small Category	ENG or CTL	[Min to Max/Init./Step]
				1/step] AS: [0 to 1 / 0 / 1/step] IM C4500: TWN: [0 to 1 / 0 / 1/step] NA: [0 to 1 / 1 / 1/step] KOR: [0 to 1 / 0 / 1/step] EU: [0 to 1 / 0 / 1/step] CHN: [0 to 1 / 0 / 1/step] AS: [0 to 1 / 0 / 1/step]
5-181-007	Size Adjust	TRAY 3/T-LCT: 1	ENG*	IM C6000: TWN: [0 to 1 / 0 / 1/step] NA: [0 to 1 / 1 / 1/step] KOR: [0 to 1 / 0 / 1/step] EU: [0 to 1 / 0 / 1/step] CHN: [0 to 1 / 0 / 1/step] AS: [0 to 1 / 0 / 1/step] IM C5500: TWN: [0 to 1 / 0 / 1/step] NA: [0 to 1 / 1 / 1/step] KOR: [0 to 1 / 0 / 1/step] EU: [0 to 1 / 0 /

3.SP Mode Tables

SP No.	Large Category	Small Category	ENG or CTL	[Min to Max/Init./Step]
				1/step] CHN: [0 to 1 / 0 / 1/step] AS: [0 to 1 / 0 / 1/step] IM C4500: TWN: [0 to 1 / 0 / 1/step] NA: [0 to 1 / 1 / 1/step] KOR: [0 to 1 / 0 / 1/step] EU: [0 to 1 / 0 / 1/step] CHN: [0 to 1 / 0 / 1/step] AS: [0 to 1 / 0 / 1/step]
5-181-008	Size Adjust	TRAY 3: 2	ENG*	IM C6000: TWN: [0 to 1 / 0 / 1/step] NA: [0 to 1 / 1 / 1/step] KOR: [0 to 1 / 0 / 1/step] EU: [0 to 1 / 0 / 1/step] CHN: [0 to 1 / 0 / 1/step] AS: [0 to 1 / 0 / 1/step] IM C5500: TWN: [0 to 1 / 0 / 1/step] NA: [0 to 1 / 1 / 1/step] KOR: [0 to 1 / 0 /

3.SP Mode Tables

SP No.	Large Category	Small Category	ENG or CTL	[Min to Max/Init./Step]
				1/step] EU: [0 to 1 / 0 / 1/step] CHN: [0 to 1 / 0 / 1/step] AS: [0 to 1 / 0 / 1/step] IM C4500: TWN: [0 to 1 / 0 / 1/step] NA: [0 to 1 / 1 / 1/step] KOR: [0 to 1 / 0 / 1/step] EU: [0 to 1 / 0 / 1/step] CHN: [0 to 1 / 0 / 1/step] AS: [0 to 1 / 0 / 1/step]
5-181-009	Size Adjust	TRAY 3: 3	ENG*	IM C6000: TWN: [0 to 1 / 0 / 1/step] NA: [0 to 1 / 1 / 1/step] KOR: [0 to 1 / 0 / 1/step] EU: [0 to 1 / 0 / 1/step] CHN: [0 to 1 / 0 / 1/step] AS: [0 to 1 / 0 / 1/step] IM C5500: TWN: [0 to 1 / 0 / 1/step] NA: [0 to 1 / 1 /

3.SP Mode Tables

SP No.	Large Category	Small Category	ENG or CTL	[Min to Max/Init./Step]
				1/step] KOR: [0 to 1 / 0 / 1/step] EU: [0 to 1 / 0 / 1/step] CHN: [0 to 1 / 0 / 1/step] AS: [0 to 1 / 0 / 1/step] IM C4500: TWN: [0 to 1 / 0 / 1/step] NA: [0 to 1 / 1 / 1/step] KOR: [0 to 1 / 0 / 1/step] EU: [0 to 1 / 0 / 1/step] CHN: [0 to 1 / 0 / 1/step] AS: [0 to 1 / 0 / 1/step]
5-181-010	Size Adjust	TRAY 3: 4	ENG*	IM C6000: TWN: [0 to 1 / 0 / 1/step] NA: [0 to 1 / 1 / 1/step] KOR: [0 to 1 / 0 / 1/step] EU: [0 to 1 / 0 / 1/step] CHN: [0 to 1 / 0 / 1/step] AS: [0 to 1 / 0 / 1/step] IM C5500: TWN: [0 to 1 / 0 /

3.SP Mode Tables

SP No.	Large Category	Small Category	ENG or CTL	[Min to Max/Init./Step]
				1/step] NA: [0 to 1 / 1 / 1/step] KOR: [0 to 1 / 0 / 1/step] EU: [0 to 1 / 0 / 1/step] CHN: [0 to 1 / 0 / 1/step] AS: [0 to 1 / 0 / 1/step] IM C4500: TWN: [0 to 1 / 0 / 1/step] NA: [0 to 1 / 1 / 1/step] KOR: [0 to 1 / 0 / 1/step] EU: [0 to 1 / 0 / 1/step] CHN: [0 to 1 / 0 / 1/step] AS: [0 to 1 / 0 / 1/step]
5-181-011	Size Adjust	TRAY 3: 5	ENG*	IM C6000: TWN: [0 to 1 / 0 / 1/step] NA: [0 to 1 / 1 / 1/step] KOR: [0 to 1 / 0 / 1/step] EU: [0 to 1 / 0 / 1/step] CHN: [0 to 1 / 0 / 1/step] AS: [0 to 1 / 0 / 1/step]

3.SP Mode Tables

SP No.	Large Category	Small Category	ENG or CTL	[Min to Max/Init./Step]
				IM C5500: TWN: [0 to 1 / 0 / 1/step] NA: [0 to 1 / 1 / 1/step] KOR: [0 to 1 / 0 / 1/step] EU: [0 to 1 / 0 / 1/step] CHN: [0 to 1 / 0 / 1/step] AS: [0 to 1 / 0 / 1/step] IM C4500: TWN: [0 to 1 / 0 / 1/step] NA: [0 to 1 / 1 / 1/step] KOR: [0 to 1 / 0 / 1/step] EU: [0 to 1 / 0 / 1/step] CHN: [0 to 1 / 0 / 1/step] AS: [0 to 1 / 0 / 1/step]
5-181-012	Size Adjust	TRAY 4: 1	ENG*	IM C6000: TWN: [0 to 1 / 0 / 1/step] NA: [0 to 1 / 1 / 1/step] KOR: [0 to 1 / 0 / 1/step] EU: [0 to 1 / 0 / 1/step] CHN: [0 to 1 / 0 / 1/step]

3.SP Mode Tables

SP No.	Large Category	Small Category	ENG or CTL	[Min to Max/Init./Step]
				AS: [0 to 1 / 0 / 1/step] IM C5500: TWN: [0 to 1 / 0 / 1/step] NA: [0 to 1 / 1 / 1/step] KOR: [0 to 1 / 0 / 1/step] EU: [0 to 1 / 0 / 1/step] CHN: [0 to 1 / 0 / 1/step] AS: [0 to 1 / 0 / 1/step] IM C4500: TWN: [0 to 1 / 0 / 1/step] NA: [0 to 1 / 1 / 1/step] KOR: [0 to 1 / 0 / 1/step] EU: [0 to 1 / 0 / 1/step] CHN: [0 to 1 / 0 / 1/step] AS: [0 to 1 / 0 / 1/step]
5-181-013	Size Adjust	TRAY 4: 2	ENG*	IM C6000: TWN: [0 to 1 / 0 / 1/step] NA: [0 to 1 / 1 / 1/step] KOR: [0 to 1 / 0 / 1/step] EU: [0 to 1 / 0 / 1/step]

3.SP Mode Tables

SP No.	Large Category	Small Category	ENG or CTL	[Min to Max/Init./Step]
				CHN: [0 to 1 / 0 / 1/step] AS: [0 to 1 / 0 / 1/step] IM C5500: TWN: [0 to 1 / 0 / 1/step] NA: [0 to 1 / 1 / 1/step] KOR: [0 to 1 / 0 / 1/step] EU: [0 to 1 / 0 / 1/step] CHN: [0 to 1 / 0 / 1/step] AS: [0 to 1 / 0 / 1/step] IM C4500: TWN: [0 to 1 / 0 / 1/step] NA: [0 to 1 / 1 / 1/step] KOR: [0 to 1 / 0 / 1/step] EU: [0 to 1 / 0 / 1/step] CHN: [0 to 1 / 0 / 1/step] AS: [0 to 1 / 0 / 1/step]
5-181-014	Size Adjust	TRAY 4: 3	ENG*	IM C6000: TWN: [0 to 1 / 0 / 1/step] NA: [0 to 1 / 1 / 1/step] KOR: [0 to 1 / 0 / 1/step]

3.SP Mode Tables

SP No.	Large Category	Small Category	ENG or CTL	[Min to Max/Init./Step]
				EU: [0 to 1 / 0 / 1/step] CHN: [0 to 1 / 0 / 1/step] AS: [0 to 1 / 0 / 1/step] IM C5500: TWN: [0 to 1 / 0 / 1/step] NA: [0 to 1 / 1 / 1/step] KOR: [0 to 1 / 0 / 1/step] EU: [0 to 1 / 0 / 1/step] CHN: [0 to 1 / 0 / 1/step] AS: [0 to 1 / 0 / 1/step] IM C4500: TWN: [0 to 1 / 0 / 1/step] NA: [0 to 1 / 1 / 1/step] KOR: [0 to 1 / 0 / 1/step] EU: [0 to 1 / 0 / 1/step] CHN: [0 to 1 / 0 / 1/step] AS: [0 to 1 / 0 / 1/step]
5-181-015	Size Adjust	TRAY 4: 4	ENG*	IM C6000: TWN: [0 to 1 / 0 / 1/step] NA: [0 to 1 / 1 / 1/step]

3.SP Mode Tables

SP No.	Large Category	Small Category	ENG or CTL	[Min to Max/Init./Step]
				KOR: [0 to 1 / 0 / 1/step] EU: [0 to 1 / 0 / 1/step] CHN: [0 to 1 / 0 / 1/step] AS: [0 to 1 / 0 / 1/step] IM C5500: TWN: [0 to 1 / 0 / 1/step] NA: [0 to 1 / 1 / 1/step] KOR: [0 to 1 / 0 / 1/step] EU: [0 to 1 / 0 / 1/step] CHN: [0 to 1 / 0 / 1/step] AS: [0 to 1 / 0 / 1/step] IM C4500: TWN: [0 to 1 / 0 / 1/step] NA: [0 to 1 / 1 / 1/step] KOR: [0 to 1 / 0 / 1/step] EU: [0 to 1 / 0 / 1/step] CHN: [0 to 1 / 0 / 1/step] AS: [0 to 1 / 0 / 1/step]
5-181-016	Size Adjust	TRAY 4: 5	ENG*	IM C6000: TWN: [0 to 1 / 0 / 1/step]

3.SP Mode Tables

SP No.	Large Category	Small Category	ENG or CTL	[Min to Max/Init./Step]
				NA: [0 to 1 / 1 / 1/step] KOR: [0 to 1 / 0 / 1/step] EU: [0 to 1 / 0 / 1/step] CHN: [0 to 1 / 0 / 1/step] AS: [0 to 1 / 0 / 1/step] IM C5500: TWN: [0 to 1 / 0 / 1/step] NA: [0 to 1 / 1 / 1/step] KOR: [0 to 1 / 0 / 1/step] EU: [0 to 1 / 0 / 1/step] CHN: [0 to 1 / 0 / 1/step] AS: [0 to 1 / 0 / 1/step] IM C4500: TWN: [0 to 1 / 0 / 1/step] NA: [0 to 1 / 1 / 1/step] KOR: [0 to 1 / 0 / 1/step] EU: [0 to 1 / 0 / 1/step] CHN: [0 to 1 / 0 / 1/step] AS: [0 to 1 / 0 / 1/step]
5-181-	Size Adjust	LCT	ENG*	IM C6000:

3.SP Mode Tables

SP No.	Large Category	Small Category	ENG or CTL	[Min to Max/Init./Step]
017				TWN: [0 to 2 / 0 / 1/step] NA: [0 to 2 / 1 / 1/step] KOR: [0 to 2 / 0 / 1/step] EU: [0 to 2 / 0 / 1/step] CHN: [0 to 2 / 0 / 1/step] AS: [0 to 2 / 0 / 1/step] IM C5500: TWN: [0 to 2 / 0 / 1/step] NA: [0 to 2 / 1 / 1/step] KOR: [0 to 2 / 0 / 1/step] EU: [0 to 2 / 0 / 1/step] CHN: [0 to 2 / 0 / 1/step] AS: [0 to 2 / 0 / 1/step] IM C4500: TWN: [0 to 2 / 0 / 1/step] NA: [0 to 2 / 1 / 1/step] KOR: [0 to 2 / 0 / 1/step] EU: [0 to 2 / 0 / 1/step] CHN: [0 to 2 / 0 / 1/step] AS: [0 to 2 / 0 / 1/step]

3.SP Mode Tables

SP No.	Large Category	Small Category	ENG or CTL	[Min to Max/Init./Step]
				1/step]
5-186-001	RK4		ENG*	[0 to 1 / 0 / 1/step]
5-610-004	Base Gamma Ctrl Pt:Execute	Get Factory Default	ENG	[0 to 1 / 0 / 1/step]
5-610-005	Base Gamma Ctrl Pt:Execute	Set Factory Default	ENG	[0 to 1 / 0 / 1/step]
5-610-006	Base Gamma Ctrl Pt:Execute	Restore Original Value	ENG	[0 to 1 / 0 / 1/step]
5-611-001	Toner Color in 2C	B-C	ENG	[0 to 128 / 100 / 1/step]
5-611-002	Toner Color in 2C	B-M	ENG	[0 to 128 / 100 / 1/step]
5-611-003	Toner Color in 2C	G-C	ENG	[0 to 128 / 100 / 1/step]
5-611-004	Toner Color in 2C	G-Y	ENG	[0 to 128 / 100 / 1/step]
5-611-005	Toner Color in 2C	R-M	ENG	[0 to 128 / 100 / 1/step]
5-611-006	Tonner Color in 2C	R-Y	ENG	[0 to 128 / 100 / 1/step]
5-801-002	Memory Clear	Engine	ENG	[0 to 1 / 0 / 1/step]
5-805-001	Dehumid Heater ON at Stand-by	0:OFF / 1:ON	ENG*	[0 to 1 / 0 / 1/step]
5-805-101	HT for PaperTray/Scanner&PCU	Jan.:Heater for PaperTray	ENG*	IM C6000: [0 to 0 / 0 / 1/step] IM C5500: [0 to 0 / 0 / 1/step] IM C4500: [0 to 0 / 0 / 1/step]
5-805-102	HT for PaperTray/Scanner&PCU	Feb.:Heater for PaperTray	ENG*	IM C6000: [0 to 0 / 0 / 1/step] IM C5500: [0 to 0 / 0 / 1/step] IM C4500:

3.SP Mode Tables

SP No.	Large Category	Small Category	ENG or CTL	[Min to Max/Init./Step]
				[0 to 0 / 0 / 1/step]
5-805-103	HT for PaperTray/Scanner&PCU	Mar.:Heater for PaperTray	ENG*	IM C6000: [0 to 0 / 0 / 1/step] IM C5500: [0 to 0 / 0 / 1/step] IM C4500: [0 to 0 / 0 / 1/step]
5-805-104	HT for PaperTray/Scanner&PCU	Apr.:Heater for PaperTray	ENG*	IM C6000: [0 to 0 / 0 / 1/step] IM C5500: [0 to 0 / 0 / 1/step] IM C4500: [0 to 0 / 0 / 1/step]
5-805-105	HT for PaperTray/Scanner&PCU	May:Heater for PaperTray	ENG*	IM C6000: [0 to 0 / 0 / 1/step] IM C5500: [0 to 0 / 0 / 1/step] IM C4500: [0 to 0 / 0 / 1/step]
5-805-106	HT for PaperTray/Scanner&PCU	Jun.:Heater for PaperTray	ENG*	IM C6000: [0 to 0 / 0 / 1/step] IM C5500: [0 to 0 / 0 / 1/step] IM C4500: [0 to 0 / 0 / 1/step]
5-805-107	HT for PaperTray/Scanner&PCU	Jul.:Heater for PaperTray	ENG*	IM C6000: [0 to 0 / 0 / 1/step] IM C5500: [0 to 0 / 0 / 1/step] IM C4500: [0 to 0 / 0 / 1/step]
5-805-108	HT for PaperTray/Scanner&PCU	Aug.:Heater for PaperTray	ENG*	IM C6000: [0 to 0 / 0 / 1/step] IM C5500: [0 to 0 / 0 / 1/step] IM C4500: [0 to 0 / 0 / 1/step]

3.SP Mode Tables

SP No.	Large Category	Small Category	ENG or CTL	[Min to Max/Init./Step]
5-805-109	HT for PaperTray/Scanner&PCU	Sep.:Heater for PaperTray	ENG*	IM C6000: [0 to 0 / 0 / 1/step] IM C5500: [0 to 0 / 0 / 1/step] IM C4500: [0 to 0 / 0 / 1/step]
5-805-110	HT for PaperTray/Scanner&PCU	Oct.:Heater for PaperTray	ENG*	IM C6000: [0 to 0 / 0 / 1/step] IM C5500: [0 to 0 / 0 / 1/step] IM C4500: [0 to 0 / 0 / 1/step]
5-805-111	HT for PaperTray/Scanner&PCU	Nov.:Heater for PaperTray	ENG*	IM C6000: [0 to 0 / 0 / 1/step] IM C5500: [0 to 0 / 0 / 1/step] IM C4500: [0 to 0 / 0 / 1/step]
5-805-112	HT for PaperTray/Scanner&PCU	Dec.:Heater for PaperTray	ENG*	IM C6000: [0 to 0 / 0 / 1/step] IM C5500: [0 to 0 / 0 / 1/step] IM C4500: [0 to 0 / 0 / 1/step]
5-805-201	HT for PaperTray/Scanner&PCU	Jan.:Heater for Scanner&PCU	ENG*	IM C6000: [0 to 0 / 0 / 1/step] IM C5500: [0 to 0 / 0 / 1/step] IM C4500: [0 to 0 / 0 / 1/step]
5-805-202	HT for PaperTray/Scanner&PCU	Feb.:Heater for Scanner&PCU	ENG*	IM C6000: [0 to 0 / 0 / 1/step] IM C5500: [0 to 0 / 0 / 1/step] IM C4500: [0 to 0 / 0 / 1/step]
5-805-	HT for	Mar.:Heater for	ENG*	IM C6000:

3.SP Mode Tables

SP No.	Large Category	Small Category	ENG or CTL	[Min to Max/Init./Step]
203	PaperTray/Scanner&PCU	Scanner&PCU		[0 to 0 / 0 / 1/step] IM C5500: [0 to 0 / 0 / 1/step] IM C4500: [0 to 0 / 0 / 1/step]
5-805-204	HT for PaperTray/Scanner&PCU	Apr.:Heater for Scanner&PCU	ENG*	IM C6000: [0 to 0 / 0 / 1/step] IM C5500: [0 to 0 / 0 / 1/step] IM C4500: [0 to 0 / 0 / 1/step]
5-805-205	HT for PaperTray/Scanner&PCU	May:Heater for Scanner&PCU	ENG*	IM C6000: [0 to 0 / 0 / 1/step] IM C5500: [0 to 0 / 0 / 1/step] IM C4500: [0 to 0 / 0 / 1/step]
5-805-206	HT for PaperTray/Scanner&PCU	Jun.:Heater for Scanner&PCU	ENG*	IM C6000: [0 to 0 / 0 / 1/step] IM C5500: [0 to 0 / 0 / 1/step] IM C4500: [0 to 0 / 0 / 1/step]
5-805-207	HT for PaperTray/Scanner&PCU	Jul.:Heater for Scanner&PCU	ENG*	IM C6000: [0 to 0 / 0 / 1/step] IM C5500: [0 to 0 / 0 / 1/step] IM C4500: [0 to 0 / 0 / 1/step]
5-805-208	HT for PaperTray/Scanner&PCU	Aug.:Heater for Scanner&PCU	ENG*	IM C6000: [0 to 0 / 0 / 1/step] IM C5500: [0 to 0 / 0 / 1/step] IM C4500: [0 to 0 / 0 / 1/step]
5-805-209	HT for PaperTray/Scanner&PCU	Sep.:Heater for Scanner&PCU	ENG*	IM C6000: [0 to 0 / 0 / 1/step]

3.SP Mode Tables

SP No.	Large Category	Small Category	ENG or CTL	[Min to Max/Init./Step]
				IM C5500: [0 to 0 / 0 / 1/step] IM C4500: [0 to 0 / 0 / 1/step]
5-805-210	HT for PaperTray/Scanner&PCU	Oct.:Heater for Scanner&PCU	ENG*	IM C6000: [0 to 0 / 0 / 1/step] IM C5500: [0 to 0 / 0 / 1/step] IM C4500: [0 to 0 / 0 / 1/step]
5-805-211	HT for PaperTray/Scanner&PCU	Nov.:Heater for Scanner&PCU	ENG*	IM C6000: [0 to 0 / 0 / 1/step] IM C5500: [0 to 0 / 0 / 1/step] IM C4500: [0 to 0 / 0 / 1/step]
5-805-212	HT for PaperTray/Scanner&PCU	Dec.:Heater for Scanner&PCU	ENG*	IM C6000: [0 to 0 / 0 / 1/step] IM C5500: [0 to 0 / 0 / 1/step] IM C4500: [0 to 0 / 0 / 1/step]
5-810-001	SC Reset	Fusing SC Reset	ENG	[0 to 1 / 0 / 1/step]
5-810-002	SC Reset	Hard High Temp. Detection	ENG	[0 to 1 / 0 / 1/step]
5-811-002	MachineSerial	Display	ENG*	[0 to 255 / 0 / 1/step]
5-811-004	MachineSerial Set	BCU	ENG	[0 to 255 / 0 / 1/step]
5-811-021	Machine Serial Update Date	Latest	ENG*	[0 to 1 / 0 / 1/step]
5-811-022	Machine Serial Update Date	Previous	ENG*	[0 to 1 / 0 / 1/step]
5-811-023	Machine Serial	Previous	ENG*	[0 to 255 / 0 / 1/step]
5-811-	Machine Serial Update Date	Latest(BCU)	ENG*	[0 to 1 / 0 / 1/step]

SP No.	Large Category	Small Category	ENG or CTL	[Min to Max/Init./Step]
024				
5-811-025	Machine Serial Update Date	Previous(BCU)	ENG*	[0 to 1 / 0 / 1/step]
5-811-026	Machine Serial	Previous(BCU)	ENG*	[0 to 255 / 0 / 1/step]
5-894-001	External Mech Count Setting	Mech Counter Switch Setting	ENG*	[0 to 2 / 0 / 1/step]
5-900-001	Engine Log Upload	Pattern	ENG*	[0 to 4 / 0 / 1/step]
5-900-002	Engine Log Upload	Trigger	ENG*	[0 to 3 / 0 / 1/step]
5-900-003	Engine Log Upload	Execute	ENG	[0 to 1 / 0 / 1/step]
5-998-001	Fusing Warm UP	Warm Up In Advance ON/OFF	ENG*	[0 to 1 / 0 / 1/step]

Engine SP Tables-6

SP6-XXX (Peripherals)

SP No.	Large Category	Small Category	ENG or CTL	[Min to Max/Init./Step]
6-006-001	ADF Adjustment	Side-to-Side Regist: Front	ENG*	[-3.0 to 3.0 / 0.0 / 0.1mm/step]
6-006-002	ADF Adjustment	Side-to-Side Regist: Rear	ENG*	[-3.0 to 3.0 / 0.0 / 0.1mm/step]
6-006-003	ADF Adjustment	Leading Edge Registration: Front	ENG*	[-5.0 to 5.0 / 0.0 / 0.1mm/step]
6-006-004	ADF Adjustment	Leading Edge Registration: Rear	ENG*	[-5.0 to 5.0 / 0.0 / 0.1mm/step]
6-006-005	ADF Adjustment	Buckle: Duplex Front	ENG*	[-10.0 to 10.0 / 0.0 / 0.1mm/step]

3.SP Mode Tables

SP No.	Large Category	Small Category	ENG or CTL	[Min to Max/Init./Step]
6-006-006	ADF Adjustment	Buckle: Duplex Rear	ENG*	[-10.0 to 10.0 / 0.0 / 0.1mm/step]
6-006-007	ADF Adjustment	Rear Edge Erase Front	ENG*	[-10.0 to 10.0 / -2.3 / 0.1mm/step]
6-006-008	ADF Adjustment	Rear Edge Erase Rear	ENG*	[-10.0 to 10.0 / -2.3 / 0.1mm/step]
6-006-010	ADF Adjustment	L-Edge Regist (1-Pass): Front	ENG*	[-5.0 to 5.0 / 0.0 / 0.1mm/step]
6-006-011	ADF Adjustment	L-Edge Regist (1-Pass): Rear	ENG*	[-5.0 to 5.0 / 0.0 / 0.1mm/step]
6-006-012	ADF Adjustment	1st Buckle (1-Pass)	ENG*	[-3.0 to 3.0 / 0.0 / 0.1mm/step]
6-006-013	ADF Adjustment	2nd Buckle (1-Pass)	ENG*	[-2.0 to 3.0 / 0.0 / 0.1mm/step]
6-006-014	ADF Adjustment	T-Edge Erase (1-Pass): Front	ENG*	[-5.0 to 5.0 / -3.0 / 0.1mm/step]
6-006-015	ADF Adjustment	T-Edge Erase (1-Pass): Rear	ENG*	[-5.0 to 5.0 / -2.5 / 0.1mm/step]
6-006-016	ADF Adjustment	ADF Feed Jam	ENG*	[0 to 1 / 0 / 1/step]
6-006-017	ADF Adjustment	Side-to-Side Regist:Front: with Feeding Unit	ENG*	[-3.0 to 3.0 / 0.0 / 0.1mm/step]
6-006-018	ADF Adjustment	Side-to-Side Regist:Rear: with Feeding Unit	ENG*	[-3.0 to 3.0 / 0.0 / 0.1mm/step]

3.SP Mode Tables

SP No.	Large Category	Small Category	ENG or CTL	[Min to Max/Init./Step]
6-006-019	ADF Adjustment	L-Edge Regist(1-Pass):Front:with FeedingUnit	ENG*	[-5.0 to 5.0 / 0.0 / 0.1mm/step]
6-006-020	ADF Adjustment	L-Edge Regist(1-Pass):Rear:with Feeding Unit	ENG*	[-5.0 to 5.0 / 0.0 / 0.1mm/step]
6-006-021	ADF Adjustment	T-Edge Erase(1-Pass):Front:with FeedingUnit	ENG*	[-5.0 to 5.0 / -3.0 / 0.1mm/step]
6-006-022	ADF Adjustment	T-Edge Erase(1-Pass):Rear:with Feeding Unit	ENG*	[-5.0 to 5.0 / -2.5 / 0.1mm/step]
6-006-023	ADF Adjustment	1st Buckle(1-Pass):with Feeding Unit	ENG*	[0.0 to 2.0 / 0.0 / 0.1mm/step]
6-009-001	ADF FreeRun	Free Run Simplex Motion	ENG	[0 to 1 / 0 / 1/step]
6-009-002	ADF FreeRun	Free Run Duplex Motion	ENG	[0 to 1 / 0 / 1/step]
6-009-003	ADF FreeRun	Free Run Stamp Motion	ENG	[0 to 1 / 0 / 1/step]
6-009-004	ADF FreeRun	Free Run Simplex Motion(low speed)	ENG	[0 to 1 / 0 / 1/step]
6-009-005	ADF FreeRun	Free Run Simplex Motion(high speed)	ENG	[0 to 1 / 0 / 1/step]
6-009-006	ADF FreeRun	Free Run Duplex Motion(low speed)	ENG	[0 to 1 / 0 / 1/step]
6-009-007	ADF FreeRun	Free Run Duplex Motion(high speed)	ENG	[0 to 1 / 0 / 1/step]

3.SP Mode Tables

SP No.	Large Category	Small Category	ENG or CTL	[Min to Max/Init./Step]
6-010-001	Stamp Position Adj.		ENG*	[-5.0 to 5.0 / 0.0 / 0.1mm/step]
6-016-001	Original Size Detect Setting		ENG*	[0 to 255 / 0 / 1/step]
6-017-001	DF Magnification Adj.		ENG*	[-5.0 to 5.0 / 0.0 / 0.1%/step]
6-020-001	Skew Correction Moving Setting		ENG*	[0 to 1 / 0 / 1/step]
6-040-001	ADF Double Feed Detect Setup	Double Feed Detect Sensor (1-Pass)	ENG*	[0 to 1 / 0 / 1/step]
6-040-002	ADF Double Feed Detect Setup	Detect enable (1-Pass)	ENG*	[0 to 1 / 0 / 1/step]
6-040-003	ADF Double Feed Detect Setup	Detect decide (1-Pass)	ENG*	[10 to 15 / 10 / 1Times/step]
6-040-006	ADF Double Feed Detect Setup	Detect number (1-Pass)	ENG*	[1 to 8 / 2 / 1Times/step]
6-040-008	ADF Double Feed Detect Setup	Detect Test (1-Pass)	ENG	[0 to 1 / 0 / 1/step]
6-040-009	ADF Double Feed Detect Setup	Detect Adjust Result (1-Pass)	ENG	[0 to 255 / 0 / 1/step]
6-050-001	DF Feeding Unit detect ON/OFF		ENG*	[0 to 1 / 0 / 1/step]
6-099-001	Sel. ShiftTray Full:2K/3K FIN	Sel. ShiftTray Full	ENG	[0 to 1 / 0 / 1/step]

3.SP Mode Tables

SP No.	Large Category	Small Category	ENG or CTL	[Min to Max/Init./Step]
6-100-001	Sub-scanPunchPosAdj:2K/3K FIN	JPN/EU: 2-Hole	ENG	[-7.5 to 7.5 / 0.0 / 0.5mm/step]
6-100-002	Sub-scanPunchPosAdj:2K/3K FIN	NA: 3-Hole	ENG	[-7.5 to 7.5 / 0.0 / 0.5mm/step]
6-100-003	Sub-scanPunchPosAdj:2K/3K FIN	Europe: 4-Hole	ENG	[-7.5 to 7.5 / 0.0 / 0.5mm/step]
6-100-004	Sub-scanPunchPosAdj:2K/3K FIN	NEU: 4-Hole	ENG	[-7.5 to 7.5 / 0.0 / 0.5mm/step]
6-100-005	Sub-scanPunchPosAdj:2K/3K FIN	NA: 2-Hole	ENG	[-7.5 to 7.5 / 0.0 / 0.5mm/step]
6-100-006	Sub-scanPunchPosAdj:2K/3K FIN	JPN: 1-Hole	ENG	[-7.5 to 7.5 / 0.0 / 0.5mm/step]
6-101-001	Main-scanPunchPosAdj:2K/3K FIN	JPN/EU: 2-Hole	ENG	[-2.0 to 2.0 / 0.0 / 0.4mm/step]
6-101-002	Main-scanPunchPosAdj:2K/3K FIN	NA: 3-Hole	ENG	[-2.0 to 2.0 / 0.0 / 0.4mm/step]
6-101-003	Main-scanPunchPosAdj:2K/3K FIN	Europe: 4-Hole	ENG	[-2.0 to 2.0 / 0.0 / 0.4mm/step]
6-101-004	Main-scanPunchPosAdj:2K/3K FIN	NEU: 4-Hole	ENG	[-2.0 to 2.0 / 0.0 / 0.4mm/step]
6-101-005	Main-scanPunchPosAdj:2K/3K FIN	NA: 2-Hole	ENG	[-2.0 to 2.0 / 0.0 / 0.4mm/step]
6-101-006	Main-scanPunchPosAdj:2K/3K FIN	JPN:1-1Hole	ENG	[-2.0 to 2.0 / 0.0 / 0.4mm/step]

3.SP Mode Tables

SP No.	Large Category	Small Category	ENG or CTL	[Min to Max/Init./Step]
6-102-001	SkewCorrectBuckleAdj:2K/3K FIN	A3 SEF	ENG	[-5.0 to 5.0 / 0.0 / 0.2mm/step]
6-102-002	SkewCorrectBuckleAdj:2K/3K FIN	B4 SEF	ENG	[-5.0 to 5.0 / 0.0 / 0.2mm/step]
6-102-003	SkewCorrectBuckleAdj:2K/3K FIN	A4 SEF	ENG	[-5.0 to 5.0 / 0.0 / 0.2mm/step]
6-102-004	SkewCorrectBuckleAdj:2K/3K FIN	A4 LEF	ENG	[-5.0 to 5.0 / 0.0 / 0.2mm/step]
6-102-005	SkewCorrectBuckleAdj:2K/3K FIN	B5 SEF	ENG	[-5.0 to 5.0 / 0.0 / 0.2mm/step]
6-102-006	SkewCorrectBuckleAdj:2K/3K FIN	B5 LEF	ENG	[-5.0 to 5.0 / 0.0 / 0.2mm/step]
6-102-007	SkewCorrectBuckleAdj:2K/3K FIN	A5 LEF	ENG	[-5.0 to 5.0 / 0.0 / 0.2mm/step]
6-102-008	SkewCorrectBuckleAdj:2K/3K FIN	DLT SEF	ENG	[-5.0 to 5.0 / 0.0 / 0.2mm/step]
6-102-009	SkewCorrectBuckleAdj:2K/3K FIN	LG SEF	ENG	[-5.0 to 5.0 / 0.0 / 0.2mm/step]
6-102-010	SkewCorrectBuckleAdj:2K/3K FIN	Oficio SEF	ENG	[-5.0 to 5.0 / 0.0 / 0.2mm/step]
6-102-011	SkewCorrectBuckleAdj:2K/3K FIN	LT SEF	ENG	[-5.0 to 5.0 / 0.0 / 0.2mm/step]
6-102-012	SkewCorrectBuckleAdj:2K/3K FIN	LT LEF	ENG	[-5.0 to 5.0 / 0.0 / 0.2mm/step]

3.SP Mode Tables

SP No.	Large Category	Small Category	ENG or CTL	[Min to Max/Init./Step]
6-102-013	SkewCorrectBuckleAdj:2K/3K FIN	HLT LEF	ENG	[-5.0 to 5.0 / 0.0 / 0.2mm/step]
6-102-014	SkewCorrectBuckleAdj:2K/3K FIN	12"x18"	ENG	[-5.0 to 5.0 / 0.0 / 0.2mm/step]
6-102-015	SkewCorrectBuckleAdj:2K/3K FIN	8K SEF	ENG	[-5.0 to 5.0 / 0.0 / 0.2mm/step]
6-102-016	SkewCorrectBuckleAdj:2K/3K FIN	16K SEF	ENG	[-5.0 to 5.0 / 0.0 / 0.2mm/step]
6-102-017	SkewCorrectBuckleAdj:2K/3K FIN	16K LEF	ENG	[-5.0 to 5.0 / 0.0 / 0.2mm/step]
6-102-018	SkewCorrectBuckleAdj:2K/3K FIN	Other	ENG	[-5.0 to 5.0 / 0.0 / 0.2mm/step]
6-103-001	SkewCorrectCtrlSW:2K/3K FIN	A3 SEF	ENG	[0 to 1 / 0 / 1/step]
6-103-002	SkewCorrectCtrlSW:2K/3K FIN	B4 SEF	ENG	[0 to 1 / 0 / 1/step]
6-103-003	SkewCorrectCtrlSW:2K/3K FIN	A4 SEF	ENG	[0 to 1 / 0 / 1/step]
6-103-004	SkewCorrectCtrlSW:2K/3K FIN	A4 LEF	ENG	[0 to 1 / 0 / 1/step]
6-103-005	SkewCorrectCtrlSW:2K/3K FIN	B5 SEF	ENG	[0 to 1 / 0 / 1/step]
6-103-006	SkewCorrectCtrlSW:2K/3K FIN	B5 LEF	ENG	[0 to 1 / 0 / 1/step]

3.SP Mode Tables

SP No.	Large Category	Small Category	ENG or CTL	[Min to Max/Init./Step]
6-103-007	SkewCorrectCtrlSW:2K/3K FIN	A5 LEF	ENG	[0 to 1 / 0 / 1/step]
6-103-008	SkewCorrectCtrlSW:2K/3K FIN	DLT SEF	ENG	[0 to 1 / 0 / 1/step]
6-103-009	SkewCorrectCtrlSW:2K/3K FIN	LG SEF	ENG	[0 to 1 / 0 / 1/step]
6-103-010	SkewCorrectCtrlSW:2K/3K FIN	Oficio SEF	ENG	[0 to 1 / 0 / 1/step]
6-103-011	SkewCorrectCtrlSW:2K/3K FIN	LT SEF	ENG	[0 to 1 / 0 / 1/step]
6-103-012	SkewCorrectCtrlSW:2K/3K FIN	LT LEF	ENG	[0 to 1 / 0 / 1/step]
6-103-013	SkewCorrectCtrlSW:2K/3K FIN	HLT LEF	ENG	[0 to 1 / 0 / 1/step]
6-103-014	SkewCorrectCtrlSW:2K/3K FIN	12"x18"	ENG	[0 to 1 / 0 / 1/step]
6-103-015	SkewCorrectCtrlSW:2K/3K FIN	8K SEF	ENG	[0 to 1 / 0 / 1/step]
6-103-016	SkewCorrectCtrlSW:2K/3K FIN	16K SEF	ENG	[0 to 1 / 0 / 1/step]
6-103-017	SkewCorrectCtrlSW:2K/3K FIN	16K LEF	ENG	[0 to 1 / 0 / 1/step]
6-103-018	SkewCorrectCtrlSW:2K/3K FIN	Other	ENG	[0 to 1 / 0 / 1/step]

3.SP Mode Tables

SP No.	Large Category	Small Category	ENG or CTL	[Min to Max/Init./Step]
6-104-001	ShiftTrayJogPosAdj:2K/3K FIN	A3 SEF	ENG	[-1.5 to 1.5 / 0.0 / 0.5mm/step]
6-104-002	ShiftTrayJogPosAdj:2K/3K FIN	B4 SEF	ENG	[-1.5 to 1.5 / 0.0 / 0.5mm/step]
6-104-003	ShiftTrayJogPosAdj:2K/3K FIN	A4 SEF	ENG	[-1.5 to 1.5 / 0.0 / 0.5mm/step]
6-104-004	ShiftTrayJogPosAdj:2K/3K FIN	A4 LEF	ENG	[-1.5 to 1.5 / 0.0 / 0.5mm/step]
6-104-005	ShiftTrayJogPosAdj:2K/3K FIN	B5 LEF	ENG	[-1.5 to 1.5 / 0.0 / 0.5mm/step]
6-104-006	ShiftTrayJogPosAdj:2K/3K FIN	A5 LEF	ENG	[-1.5 to 1.5 / 0.0 / 0.5mm/step]
6-104-007	ShiftTrayJogPosAdj:2K/3K FIN	DLT SEF	ENG	[-1.5 to 1.5 / 0.0 / 0.5mm/step]
6-104-008	ShiftTrayJogPosAdj:2K/3K FIN	LG SEF	ENG	[-1.5 to 1.5 / 0.0 / 0.5mm/step]
6-104-009	ShiftTrayJogPosAdj:2K/3K FIN	Oficio SEF	ENG	[-1.5 to 1.5 / 0.0 / 0.5mm/step]
6-104-010	ShiftTrayJogPosAdj:2K/3K FIN	LT SEF	ENG	[-1.5 to 1.5 / 0.0 / 0.5mm/step]
6-104-011	ShiftTrayJogPosAdj:2K/3K FIN	LT LEF	ENG	[-1.5 to 1.5 / 0.0 / 0.5mm/step]
6-104-012	ShiftTrayJogPosAdj:2K/3K FIN	HLT LEF	ENG	[-1.5 to 1.5 / 0.0 / 0.5mm/step]

3.SP Mode Tables

SP No.	Large Category	Small Category	ENG or CTL	[Min to Max/Init./Step]
6-104-013	ShfftTrayJogPosAdj:2K/3K FIN	8K SEF	ENG	[-1.5 to 1.5 / 0.0 / 0.5mm/step]
6-104-014	ShfftTrayJogPosAdj:2K/3K FIN	16K LEF	ENG	[-1.5 to 1.5 / 0.0 / 0.5mm/step]
6-104-015	ShfftTrayJogPosAdj:2K/3K FIN	Other	ENG	[-1.5 to 1.5 / 0.0 / 0.5mm/step]
6-105-001	ShfftJogRtrctAngAdj:2K/3K FIN	A3 SEF	ENG	[-10 to 10 / 0 / 5deg/step]
6-105-002	ShfftJogRtrctAngAdj:2K/3K FIN	B4 SEF	ENG	[-10 to 10 / 0 / 5deg/step]
6-105-003	ShfftJogRtrctAngAdj:2K/3K FIN	A4 SEF	ENG	[-10 to 10 / 0 / 5deg/step]
6-105-004	ShfftJogRtrctAngAdj:2K/3K FIN	DLT SEF	ENG	[-10 to 10 / 0 / 5deg/step]
6-105-005	ShfftJogRtrctAngAdj:2K/3K FIN	LG SEF	ENG	[-10 to 10 / 0 / 5deg/step]
6-105-006	ShfftJogRtrctAngAdj:2K/3K FIN	Oficio SEF	ENG	[-10 to 10 / 0 / 5deg/step]
6-105-007	ShfftJogRtrctAngAdj:2K/3K FIN	LT SEF	ENG	[-10 to 10 / 0 / 5deg/step]
6-105-008	ShfftJogRtrctAngAdj:2K/3K FIN	8K SEF	ENG	[-10 to 10 / 0 / 5deg/step]
6-105-009	ShfftJogRtrctAngAdj:2K/3K FIN	Other	ENG	[-10 to 10 / 0 / 5deg/step]

3.SP Mode Tables

SP No.	Large Category	Small Category	ENG or CTL	[Min to Max/Init./Step]
6-106-001	Use Paper Jogger: 2K/3K FIN	A3 SEF	ENG	[0 to 1 / 0 / 1/step]
6-106-002	Use Paper Jogger: 2K/3K FIN	B4 SEF	ENG	[0 to 1 / 0 / 1/step]
6-106-003	Use Paper Jogger: 2K/3K FIN	A4 SEF	ENG	[0 to 1 / 0 / 1/step]
6-106-004	Use Paper Jogger: 2K/3K FIN	A4 LEF	ENG	[0 to 1 / 0 / 1/step]
6-106-005	Use Paper Jogger: 2K/3K FIN	B5 LEF	ENG	[0 to 1 / 0 / 1/step]
6-106-006	Use Paper Jogger: 2K/3K FIN	A5 LEF	ENG	[0 to 1 / 0 / 1/step]
6-106-007	Use Paper Jogger: 2K/3K FIN	DLT SEF	ENG	[0 to 1 / 0 / 1/step]
6-106-008	Use Paper Jogger: 2K/3K FIN	LG SEF	ENG	[0 to 1 / 0 / 1/step]
6-106-009	Use Paper Jogger: 2K/3K FIN	Oficio SEF	ENG	[0 to 1 / 0 / 1/step]
6-106-010	Use Paper Jogger: 2K/3K FIN	LT SEF	ENG	[0 to 1 / 0 / 1/step]
6-106-011	Use Paper Jogger: 2K/3K FIN	LT LEF	ENG	[0 to 1 / 0 / 1/step]
6-106-012	Use Paper Jogger: 2K/3K FIN	HLT LEF	ENG	[0 to 1 / 0 / 1/step]

3.SP Mode Tables

SP No.	Large Category	Small Category	ENG or CTL	[Min to Max/Init./Step]
6-106-013	Use Paper Jogger: 2K/3K FIN	8K SEF	ENG	[0 to 1 / 0 / 1/step]
6-106-014	Use Paper Jogger: 2K/3K FIN	16K LEF	ENG	[0 to 1 / 0 / 1/step]
6-106-015	Use Paper Jogger: 2K/3K FIN	Other	ENG	[0 to 1 / 0 / 1/step]
6-107-001	JogPosAdj(CmrStplr):2K/3K FIN	A3 SEF	ENG	[-1.5 to 1.5 / 0.0 / 0.5mm/step]
6-107-002	JogPosAdj(CmrStplr):2K/3K FIN	B4 SEF	ENG	[-1.5 to 1.5 / 0.0 / 0.5mm/step]
6-107-003	JogPosAdj(CmrStplr):2K/3K FIN	A4 SEF	ENG	[-1.5 to 1.5 / 0.0 / 0.5mm/step]
6-107-004	JogPosAdj(CmrStplr):2K/3K FIN	A4 LEF	ENG	[-1.5 to 1.5 / 0.0 / 0.5mm/step]
6-107-005	JogPosAdj(CmrStplr):2K/3K FIN	B5 SEF	ENG	[-1.5 to 1.5 / 0.0 / 0.5mm/step]
6-107-006	JogPosAdj(CmrStplr):2K/3K FIN	B5 LEF	ENG	[-1.5 to 1.5 / 0.0 / 0.5mm/step]
6-107-007	JogPosAdj(CmrStplr):2K/3K FIN	DLT SEF	ENG	[-1.5 to 1.5 / 0.0 / 0.5mm/step]
6-107-008	JogPosAdj(CmrStplr):2K/3K FIN	LG SEF	ENG	[-1.5 to 1.5 / 0.0 / 0.5mm/step]
6-107-009	JogPosAdj(CmrStplr):2K/3K FIN	Oficio SEF	ENG	[-1.5 to 1.5 / 0.0 / 0.5mm/step]

3.SP Mode Tables

SP No.	Large Category	Small Category	ENG or CTL	[Min to Max/Init./Step]
6-107-010	JogPosAdj(CmrStplr):2K/3K FIN	LT SEF	ENG	[-1.5 to 1.5 / 0.0 / 0.5mm/step]
6-107-011	JogPosAdj(CmrStplr):2K/3K FIN	LT LEF	ENG	[-1.5 to 1.5 / 0.0 / 0.5mm/step]
6-107-012	JogPosAdj(CmrStplr):2K/3K FIN	8K SEF	ENG	[-1.5 to 1.5 / 0.0 / 0.5mm/step]
6-107-013	JogPosAdj(CmrStplr):2K/3K FIN	16K SEF	ENG	[-1.5 to 1.5 / 0.0 / 0.5mm/step]
6-107-014	JogPosAdj(CmrStplr):2K/3K FIN	16K LEF	ENG	[-1.5 to 1.5 / 0.0 / 0.5mm/step]
6-107-015	JogPosAdj(CmrStplr):2K/3K FIN	Other	ENG	[-1.5 to 1.5 / 0.0 / 0.5mm/step]
6-108-001	JogPosAdj(BookStplr):2K/3K FIN	A3 SEF	ENG	[-1.5 to 1.5 / 0.0 / 0.5mm/step]
6-108-002	JogPosAdj(BookStplr):2K/3K FIN	B4 SEF	ENG	[-1.5 to 1.5 / 0.0 / 0.5mm/step]
6-108-003	JogPosAdj(BookStplr):2K/3K FIN	A4 SEF	ENG	[-1.5 to 1.5 / 0.0 / 0.5mm/step]
6-108-004	JogPosAdj(BookStplr):2K/3K FIN	B5 SEF	ENG	[-1.5 to 1.5 / 0.0 / 0.5mm/step]
6-108-005	JogPosAdj(BookStplr):2K/3K FIN	DLT SEF	ENG	[-1.5 to 1.5 / 0.0 / 0.5mm/step]
6-108-006	JogPosAdj(BookStplr):2K/3K FIN	LG SEF	ENG	[-1.5 to 1.5 / 0.0 / 0.5mm/step]

3.SP Mode Tables

SP No.	Large Category	Small Category	ENG or CTL	[Min to Max/Init./Step]
6-108-007	JogPosAdj(BookStplr):2K/3K FIN	Oficio SEF	ENG	[-1.5 to 1.5 / 0.0 / 0.5mm/step]
6-108-008	JogPosAdj(BookStplr):2K/3K FIN	LT SEF	ENG	[-1.5 to 1.5 / 0.0 / 0.5mm/step]
6-108-009	JogPosAdj(BookStplr):2K/3K FIN	12"x18"	ENG	[-1.5 to 1.5 / 0.0 / 0.5mm/step]
6-108-010	JogPosAdj(BookStplr):2K/3K FIN	8K SEF	ENG	[-1.5 to 1.5 / 0.0 / 0.5mm/step]
6-108-011	JogPosAdj(BookStplr):2K/3K FIN	Other	ENG	[-1.5 to 1.5 / 0.0 / 0.5mm/step]
6-109-001	CnrStplrJogTimeAdj:2K/3K FIN	A3 SEF	ENG	[0 to 2 / 0 / 1times/step]
6-109-002	CnrStplrJogTimeAdj:2K/3K FIN	B4 SEF	ENG	[0 to 2 / 0 / 1times/step]
6-109-003	CnrStplrJogTimeAdj:2K/3K FIN	A4 SEF	ENG	[0 to 2 / 0 / 1times/step]
6-109-004	CnrStplrJogTimeAdj:2K/3K FIN	A4 LEF	ENG	[0 to 2 / 0 / 1times/step]
6-109-005	CnrStplrJogTimeAdj:2K/3K FIN	B5 SEF	ENG	[0 to 2 / 0 / 1times/step]
6-109-006	CnrStplrJogTimeAdj:2K/3K FIN	B5 LEF	ENG	[0 to 2 / 0 / 1times/step]
6-109-007	CnrStplrJogTimeAdj:2K/3K FIN	DLT SEF	ENG	[0 to 2 / 0 / 1times/step]

3.SP Mode Tables

SP No.	Large Category	Small Category	ENG or CTL	[Min to Max/Init./Step]
6-109-008	CrnStplrJogTimeAdj:2K/3K FIN	LG SEF	ENG	[0 to 2 / 0 / 1times/step]
6-109-009	CrnStplrJogTimeAdj:2K/3K FIN	Oficio SEF	ENG	[0 to 2 / 0 / 1times/step]
6-109-010	CrnStplrJogTimeAdj:2K/3K FIN	LT SEF	ENG	[0 to 2 / 0 / 1times/step]
6-109-011	CrnStplrJogTimeAdj:2K/3K FIN	LT LEF	ENG	[0 to 2 / 0 / 1times/step]
6-109-012	CrnStplrJogTimeAdj:2K/3K FIN	8K SEF	ENG	[0 to 2 / 0 / 1times/step]
6-109-013	CrnStplrJogTimeAdj:2K/3K FIN	16K SEF	ENG	[0 to 2 / 0 / 1times/step]
6-109-014	CrnStplrJogTimeAdj:2K/3K FIN	16K LEF	ENG	[0 to 2 / 0 / 1times/step]
6-109-015	CrnStplrJogTimeAdj:2K/3K FIN	Other	ENG	[0 to 2 / 0 / 1times/step]
6-110-001	BookStplrJogTimeAdj:2K/3K FIN	A3 SEF	ENG	[0 to 2 / 0 / 1times/step]
6-110-002	BookStplrJogTimeAdj:2K/3K FIN	B4 SEF	ENG	[0 to 2 / 0 / 1times/step]
6-110-003	BookStplrJogTimeAdj:2K/3K FIN	A4 SEF	ENG	[0 to 2 / 0 / 1times/step]
6-110-004	BookStplrJogTimeAdj:2K/3K FIN	B5 SEF	ENG	[0 to 2 / 0 / 1times/step]

3.SP Mode Tables

SP No.	Large Category	Small Category	ENG or CTL	[Min to Max/Init./Step]
6-110-005	BookStplrJogTimeAdj:2K/3K FIN	DLT SEF	ENG	[0 to 2 / 0 / 1times/step]
6-110-006	BookStplrJogTimeAdj:2K/3K FIN	LG SEF	ENG	[0 to 2 / 0 / 1times/step]
6-110-007	BookStplrJogTimeAdj:2K/3K FIN	Oficio SEF	ENG	[0 to 2 / 0 / 1times/step]
6-110-008	BookStplrJogTimeAdj:2K/3K FIN	LT SEF	ENG	[0 to 2 / 0 / 1times/step]
6-110-009	BookStplrJogTimeAdj:2K/3K FIN	12"x18"	ENG	[0 to 2 / 0 / 1times/step]
6-110-010	BookStplrJogTimeAdj:2K/3K FIN	8K SEF	ENG	[0 to 2 / 0 / 1times/step]
6-110-011	BookStplrJogTimeAdj:2K/3K FIN	Other	ENG	[0 to 2 / 0 / 1times/step]
6-111-001	Staple Position Adj: 2K/3K FIN	A3 SEF	ENG	[-3.5 to 3.5 / 0.0 / 0.5mm/step]
6-111-002	Staple Position Adj: 2K/3K FIN	B4 SEF	ENG	[-3.5 to 3.5 / 0.0 / 0.5mm/step]
6-111-003	Staple Position Adj: 2K/3K FIN	A4 SEF	ENG	[-3.5 to 3.5 / 0.0 / 0.5mm/step]
6-111-004	Staple Position Adj: 2K/3K FIN	A4 LEF	ENG	[-3.5 to 3.5 / 0.0 / 0.5mm/step]
6-111-005	Staple Position Adj: 2K/3K FIN	B5 SEF	ENG	[-3.5 to 3.5 / 0.0 / 0.5mm/step]

3.SP Mode Tables

SP No.	Large Category	Small Category	ENG or CTL	[Min to Max/Init./Step]
6-111-006	Staple Position Adj: 2K/3K FIN	B5 LEF	ENG	[-3.5 to 3.5 / 0.0 / 0.5mm/step]
6-111-007	Staple Position Adj: 2K/3K FIN	DLT SEF	ENG	[-3.5 to 3.5 / 0.0 / 0.5mm/step]
6-111-008	Staple Position Adj: 2K/3K FIN	LG SEF	ENG	[-3.5 to 3.5 / 0.0 / 0.5mm/step]
6-111-009	Staple Position Adj: 2K/3K FIN	Oficio SEF	ENG	[-3.5 to 3.5 / 0.0 / 0.5mm/step]
6-111-010	Staple Position Adj: 2K/3K FIN	LT SEF	ENG	[-3.5 to 3.5 / 0.0 / 0.5mm/step]
6-111-011	Staple Position Adj: 2K/3K FIN	LT LEF	ENG	[-3.5 to 3.5 / 0.0 / 0.5mm/step]
6-111-012	Staple Position Adj: 2K/3K FIN	8K SEF	ENG	[-3.5 to 3.5 / 0.0 / 0.5mm/step]
6-111-013	Staple Position Adj: 2K/3K FIN	16K SEF	ENG	[-3.5 to 3.5 / 0.0 / 0.5mm/step]
6-111-014	Staple Position Adj: 2K/3K FIN	16K LEF	ENG	[-3.5 to 3.5 / 0.0 / 0.5mm/step]
6-111-015	Staple Position Adj: 2K/3K FIN	Other	ENG	[-3.5 to 3.5 / 0.0 / 0.5mm/step]
6-112-001	BookletStaplerPosAdj:2K/3K FIN	A3 SEF	ENG	[-3.0 to 3.0 / 0.0 / 0.2mm/step]
6-112-002	BookletStaplerPosAdj:2K/3K FIN	B4 SEF	ENG	[-3.0 to 3.0 / 0.0 / 0.2mm/step]

3.SP Mode Tables

SP No.	Large Category	Small Category	ENG or CTL	[Min to Max/Init./Step]
6-112-003	BookletStaplerPosAdj:2K/3K FIN	A4 SEF	ENG	[-3.0 to 3.0 / 0.0 / 0.2mm/step]
6-112-004	BookletStaplerPosAdj:2K/3K FIN	B5 SEF	ENG	[-3.0 to 3.0 / 0.0 / 0.2mm/step]
6-112-005	BookletStaplerPosAdj:2K/3K FIN	DLT SEF	ENG	[-3.0 to 3.0 / 0.0 / 0.2mm/step]
6-112-006	BookletStaplerPosAdj:2K/3K FIN	LG SEF	ENG	[-3.0 to 3.0 / 0.0 / 0.2mm/step]
6-112-007	BookletStaplerPosAdj:2K/3K FIN	Oficio SEF	ENG	[-3.0 to 3.0 / 0.0 / 0.2mm/step]
6-112-008	BookletStaplerPosAdj:2K/3K FIN	LT SEF	ENG	[-3.0 to 3.0 / 0.0 / 0.2mm/step]
6-112-009	BookletStaplerPosAdj:2K/3K FIN	12"x18"	ENG	[-1.8 to 1.8 / 0.0 / 0.2mm/step]
6-112-010	BookletStaplerPosAdj:2K/3K FIN	8K SEF	ENG	[-3.0 to 3.0 / 0.0 / 0.2mm/step]
6-112-011	BookletStaplerPosAdj:2K/3K FIN	Other	ENG	[-1.8 to 1.8 / 0.0 / 0.2mm/step]
6-113-001	BookletFolderPosAdj:2K/3K FIN	A3 SEF	ENG	[-3.0 to 3.0 / 0.0 / 0.2mm/step]
6-113-002	BookletFolderPosAdj:2K/3K FIN	B4 SEF	ENG	[-3.0 to 3.0 / 0.0 / 0.2mm/step]
6-113-003	BookletFolderPosAdj:2K/3K FIN	A4 SEF	ENG	[-3.0 to 3.0 / 0.0 / 0.2mm/step]

3.SP Mode Tables

SP No.	Large Category	Small Category	ENG or CTL	[Min to Max/Init./Step]
6-113-004	BookletFolderPosAdj:2K/3K FIN	B5 SEF	ENG	[-3.0 to 3.0 / 0.0 / 0.2mm/step]
6-113-005	BookletFolderPosAdj:2K/3K FIN	DLT SEF	ENG	[-3.0 to 3.0 / 0.0 / 0.2mm/step]
6-113-006	BookletFolderPosAdj:2K/3K FIN	LG SEF	ENG	[-3.0 to 3.0 / 0.0 / 0.2mm/step]
6-113-007	BookletFolderPosAdj:2K/3K FIN	Oficio SEF	ENG	[-3.0 to 3.0 / 0.0 / 0.2mm/step]
6-113-008	BookletFolderPosAdj:2K/3K FIN	LT SEF	ENG	[-3.0 to 3.0 / 0.0 / 0.2mm/step]
6-113-009	BookletFolderPosAdj:2K/3K FIN	12"x18"	ENG	[-3.0 to 3.0 / 0.0 / 0.2mm/step]
6-113-010	BookletFolderPosAdj:2K/3K FIN	8K SEF	ENG	[-3.0 to 3.0 / 0.0 / 0.2mm/step]
6-113-011	BookletFolderPosAdj:2K/3K FIN	Other	ENG	[-3.0 to 3.0 / 0.0 / 0.2mm/step]
6-113-012	BookletFolderPosAdj:2K/3K FIN	A3 SEF(1-5)	ENG	[-3.0 to 3.0 / 0.0 / 0.2mm/step]
6-113-013	BookletFolderPosAdj:2K/3K FIN	A3 SEF(6-10)	ENG	[-3.0 to 3.0 / 0.0 / 0.2mm/step]
6-113-014	BookletFolderPosAdj:2K/3K FIN	A3 SEF(11-15)	ENG	[-3.0 to 3.0 / 0.0 / 0.2mm/step]
6-113-015	BookletFolderPosAdj:2K/3K FIN	A3 SEF(16-over)	ENG	[-3.0 to 3.0 / 0.0 / 0.2mm/step]

3.SP Mode Tables

SP No.	Large Category	Small Category	ENG or CTL	[Min to Max/Init./Step]
6-113-016	BookletFolderPosAdj:2K/3K FIN	B4 SEF(1-5)	ENG	[-3.0 to 3.0 / 0.0 / 0.2mm/step]
6-113-017	BookletFolderPosAdj:2K/3K FIN	B4 SEF(6-10)	ENG	[-3.0 to 3.0 / 0.0 / 0.2mm/step]
6-113-018	BookletFolderPosAdj:2K/3K FIN	B4 SEF(11-15)	ENG	[-3.0 to 3.0 / 0.0 / 0.2mm/step]
6-113-019	BookletFolderPosAdj:2K/3K FIN	B4 SEF(16-over)	ENG	[-3.0 to 3.0 / 0.0 / 0.2mm/step]
6-113-020	BookletFolderPosAdj:2K/3K FIN	A4 SEF(1-5)	ENG	[-3.0 to 3.0 / 0.0 / 0.2mm/step]
6-113-021	BookletFolderPosAdj:2K/3K FIN	A4 SEF(6-10)	ENG	[-3.0 to 3.0 / 0.0 / 0.2mm/step]
6-113-022	BookletFolderPosAdj:2K/3K FIN	A4 SEF(11-15)	ENG	[-3.0 to 3.0 / 0.0 / 0.2mm/step]
6-113-023	BookletFolderPosAdj:2K/3K FIN	A4 SEF(16-over)	ENG	[-3.0 to 3.0 / 0.0 / 0.2mm/step]
6-113-024	BookletFolderPosAdj:2K/3K FIN	B5 SEF(1-5)	ENG	[-3.0 to 3.0 / 0.0 / 0.2mm/step]
6-113-025	BookletFolderPosAdj:2K/3K FIN	B5 SEF(6-10)	ENG	[-3.0 to 3.0 / 0.0 / 0.2mm/step]
6-113-026	BookletFolderPosAdj:2K/3K FIN	B5 SEF(11-15)	ENG	[-3.0 to 3.0 / 0.0 / 0.2mm/step]
6-113-027	BookletFolderPosAdj:2K/3K FIN	B5 SEF(16-over)	ENG	[-3.0 to 3.0 / 0.0 / 0.2mm/step]

3.SP Mode Tables

SP No.	Large Category	Small Category	ENG or CTL	[Min to Max/Init./Step]
6-113-028	BookletFolderPosAdj:2K/3K FIN	DLT SEF(1-5)	ENG	[-3.0 to 3.0 / 0.0 / 0.2mm/step]
6-113-029	BookletFolderPosAdj:2K/3K FIN	DLT SEF(6-10)	ENG	[-3.0 to 3.0 / 0.0 / 0.2mm/step]
6-113-030	BookletFolderPosAdj:2K/3K FIN	DLT SEF(11-15)	ENG	[-3.0 to 3.0 / 0.0 / 0.2mm/step]
6-113-031	BookletFolderPosAdj:2K/3K FIN	DLT SEF(16-over)	ENG	[-3.0 to 3.0 / 0.0 / 0.2mm/step]
6-113-032	BookletFolderPosAdj:2K/3K FIN	LG SEF(1-5)	ENG	[-3.0 to 3.0 / 0.0 / 0.2mm/step]
6-113-033	BookletFolderPosAdj:2K/3K FIN	LG SEF(6-10)	ENG	[-3.0 to 3.0 / 0.0 / 0.2mm/step]
6-113-034	BookletFolderPosAdj:2K/3K FIN	LG SEF(11-15)	ENG	[-3.0 to 3.0 / 0.0 / 0.2mm/step]
6-113-035	BookletFolderPosAdj:2K/3K FIN	LG SEF(16-over)	ENG	[-3.0 to 3.0 / 0.0 / 0.2mm/step]
6-113-036	BookletFolderPosAdj:2K/3K FIN	Oficio SEF(1-5)	ENG	[-3.0 to 3.0 / 0.0 / 0.2mm/step]
6-113-037	BookletFolderPosAdj:2K/3K FIN	Oficio SEF(6-10)	ENG	[-3.0 to 3.0 / 0.0 / 0.2mm/step]
6-113-038	BookletFolderPosAdj:2K/3K FIN	Oficio SEF(11-15)	ENG	[-3.0 to 3.0 / 0.0 / 0.2mm/step]
6-113-039	BookletFolderPosAdj:2K/3K FIN	Oficio SEF(16-over)	ENG	[-3.0 to 3.0 / 0.0 / 0.2mm/step]

3.SP Mode Tables

SP No.	Large Category	Small Category	ENG or CTL	[Min to Max/Init./Step]
6-113-040	BookletFolderPosAdj:2K/3K FIN	LT SEF(1-5)	ENG	[-3.0 to 3.0 / 0.0 / 0.2mm/step]
6-113-041	BookletFolderPosAdj:2K/3K FIN	LT SEF(6-10)	ENG	[-3.0 to 3.0 / 0.0 / 0.2mm/step]
6-113-042	BookletFolderPosAdj:2K/3K FIN	LT SEF(11-15)	ENG	[-3.0 to 3.0 / 0.0 / 0.2mm/step]
6-113-043	BookletFolderPosAdj:2K/3K FIN	LT SEF(16-over)	ENG	[-3.0 to 3.0 / 0.0 / 0.2mm/step]
6-113-044	BookletFolderPosAdj:2K/3K FIN	12"x18"(1-5)	ENG	[-3.0 to 3.0 / 0.0 / 0.2mm/step]
6-113-045	BookletFolderPosAdj:2K/3K FIN	12"x18"(6-10)	ENG	[-3.0 to 3.0 / 0.0 / 0.2mm/step]
6-113-046	BookletFolderPosAdj:2K/3K FIN	12"x18"(11-15)	ENG	[-3.0 to 3.0 / 0.0 / 0.2mm/step]
6-113-047	BookletFolderPosAdj:2K/3K FIN	12"x18"(16-over)	ENG	[-3.0 to 3.0 / 0.0 / 0.2mm/step]
6-113-048	BookletFolderPosAdj:2K/3K FIN	8K SEF(1-5)	ENG	[-3.0 to 3.0 / 0.0 / 0.2mm/step]
6-113-049	BookletFolderPosAdj:2K/3K FIN	8K SEF(6-10)	ENG	[-3.0 to 3.0 / 0.0 / 0.2mm/step]
6-113-050	BookletFolderPosAdj:2K/3K FIN	8K SEF(11-15)	ENG	[-3.0 to 3.0 / 0.0 / 0.2mm/step]
6-113-051	BookletFolderPosAdj:2K/3K FIN	8K SEF(16-over)	ENG	[-3.0 to 3.0 / 0.0 / 0.2mm/step]

3.SP Mode Tables

SP No.	Large Category	Small Category	ENG or CTL	[Min to Max/Init./Step]
6-113-052	BookletFolderPosAdj:2K/3K FIN	Other(1-5)	ENG	[-3.0 to 3.0 / 0.0 / 0.2mm/step]
6-113-053	BookletFolderPosAdj:2K/3K FIN	Other(6-10)	ENG	[-3.0 to 3.0 / 0.0 / 0.2mm/step]
6-113-054	BookletFolderPosAdj:2K/3K FIN	Other(11-15)	ENG	[-3.0 to 3.0 / 0.0 / 0.2mm/step]
6-113-055	BookletFolderPosAdj:2K/3K FIN	Other(16-over)	ENG	[-3.0 to 3.0 / 0.0 / 0.2mm/step]
6-114-001	Fold Speed Adj.: 2K/3K FIN	A3 SEF	ENG	[0 to 2 / 0 / 1/step]
6-114-002	Fold Speed Adj.: 2K/3K FIN	B4 SEF	ENG	[0 to 2 / 0 / 1/step]
6-114-003	Fold Speed Adj.: 2K/3K FIN	A4 SEF	ENG	[0 to 2 / 0 / 1/step]
6-114-004	Fold Speed Adj.: 2K/3K FIN	B5 SEF	ENG	[0 to 2 / 0 / 1/step]
6-114-005	Fold Speed Adj.: 2K/3K FIN	DLT SEF	ENG	[0 to 2 / 0 / 1/step]
6-114-006	Fold Speed Adj.: 2K/3K FIN	LG SEF	ENG	[0 to 2 / 0 / 1/step]
6-114-007	Fold Speed Adj.: 2K/3K FIN	Oficio SEF	ENG	[0 to 2 / 0 / 1/step]
6-114-008	Fold Speed Adj.: 2K/3K FIN	LT SEF	ENG	[0 to 2 / 0 / 1/step]

3.SP Mode Tables

SP No.	Large Category	Small Category	ENG or CTL	[Min to Max/Init./Step]
6-114-009	Fold Speed Adj.: 2K/3K FIN	12"x18"	ENG	[0 to 2 / 0 / 1/step]
6-114-010	Fold Speed Adj.: 2K/3K FIN	8K SEF	ENG	[0 to 2 / 0 / 1/step]
6-114-011	Fold Speed Adj.: 2K/3K FIN	Other	ENG	[0 to 2 / 0 / 1/step]
6-115-001	Finisher Free Run: 2K/3K FIN	Free Run 1	ENG	[0 to 1 / 0 / 1/step]
6-115-002	Finisher Free Run: 2K/3K FIN	Free Run 2	ENG	[0 to 1 / 0 / 1/step]
6-115-003	Finisher Free Run: 2K/3K FIN	Free Run 3	ENG	[0 to 1 / 0 / 1/step]
6-115-004	Finisher Free Run: 2K/3K FIN	Free Run 4	ENG	[0 to 1 / 0 / 1/step]
6-115-005	Finisher Free Run: 2K/3K FIN	Free Run 5	ENG	[0 to 1 / 0 / 1/step]
6-116-001	CnrStplrMxPrstkShAdj:2K/3KFIN	A3 SEF	ENG	[-1 to 0 / 0 / 1sheets/step]
6-116-002	CnrStplrMxPrstkShAdj:2K/3KFIN	B4 SEF	ENG	[-1 to 0 / 0 / 1sheets/step]
6-116-003	CnrStplrMxPrstkShAdj:2K/3KFIN	A4 SEF	ENG	[-1 to 0 / 0 / 1sheets/step]
6-116-004	CnrStplrMxPrstkShAdj:2K/3KFIN	A4 LEF	ENG	[-1 to 0 / 0 / 1sheets/step]

3.SP Mode Tables

SP No.	Large Category	Small Category	ENG or CTL	[Min to Max/Init./Step]
6-116-005	CmnrStplrMxPrstkShAdj:2K/3KFIN	B5 SEF	ENG	[-1 to 0 / 0 / 1sheets/step]
6-116-006	CmnrStplrMxPrstkShAdj:2K/3KFIN	B5 LEF	ENG	[-1 to 0 / 0 / 1sheets/step]
6-116-007	CmnrStplrMxPrstkShAdj:2K/3KFIN	DLT SEF	ENG	[-1 to 0 / 0 / 1sheets/step]
6-116-008	CmnrStplrMxPrstkShAdj:2K/3KFIN	LG SEF	ENG	[-1 to 0 / 0 / 1sheets/step]
6-116-009	CmnrStplrMxPrstkShAdj:2K/3KFIN	Oficio SEF	ENG	[-1 to 0 / 0 / 1sheets/step]
6-116-010	CmnrStplrMxPrstkShAdj:2K/3KFIN	LT SEF	ENG	[-1 to 0 / 0 / 1sheets/step]
6-116-011	CmnrStplrMxPrstkShAdj:2K/3KFIN	LT LEF	ENG	[-1 to 0 / 0 / 1sheets/step]
6-116-012	CmnrStplrMxPrstkShAdj:2K/3KFIN	8K SEF	ENG	[-1 to 0 / 0 / 1sheets/step]
6-116-013	CmnrStplrMxPrstkShAdj:2K/3KFIN	16K SEF	ENG	[-1 to 0 / 0 / 1sheets/step]
6-116-014	CmnrStplrMxPrstkShAdj:2K/3KFIN	16K LEF	ENG	[-1 to 0 / 0 / 1sheets/step]
6-116-015	CmnrStplrMxPrstkShAdj:2K/3KFIN	Other	ENG	[-1 to 0 / 0 / 1sheets/step]
6-117-001	BookStplrMxPrstkShAdj:2K/3KFIN	A3 SEF	ENG	[-2 to 0 / 0 / 1sheets/step]

3.SP Mode Tables

SP No.	Large Category	Small Category	ENG or CTL	[Min to Max/Init./Step]
6-117-002	BookStplrMxPrstkShAdj:2K/3KFIN	B4 SEF	ENG	[-2 to 0 / 0 / 1sheets/step]
6-117-003	BookStplrMxPrstkShAdj:2K/3KFIN	A4 SEF	ENG	[-2 to 0 / 0 / 1sheets/step]
6-117-004	BookStplrMxPrstkShAdj:2K/3KFIN	B5 SEF	ENG	[-2 to 0 / 0 / 1sheets/step]
6-117-005	BookStplrMxPrstkShAdj:2K/3KFIN	DLT SEF	ENG	[-2 to 0 / 0 / 1sheets/step]
6-117-006	BookStplrMxPrstkShAdj:2K/3KFIN	LG SEF	ENG	[-2 to 0 / 0 / 1sheets/step]
6-117-007	BookStplrMxPrstkShAdj:2K/3KFIN	Oficio SEF	ENG	[-2 to 0 / 0 / 1sheets/step]
6-117-008	BookStplrMxPrstkShAdj:2K/3KFIN	LT SEF	ENG	[-2 to 0 / 0 / 1sheets/step]
6-117-009	BookStplrMxPrstkShAdj:2K/3KFIN	12"x18"	ENG	[-2 to 0 / 0 / 1sheets/step]
6-117-010	BookStplrMxPrstkShAdj:2K/3KFIN	8K SEF	ENG	[-2 to 0 / 0 / 1sheets/step]
6-117-011	BookStplrMxPrstkShAdj:2K/3KFIN	Other	ENG	[-2 to 0 / 0 / 1sheets/step]
6-118-001	CnrStplrPrstkOffsAdj:2K/3KFIN	A3 SEF	ENG	[-16 to 16 / 0 / 2mm/step]
6-118-002	CnrStplrPrstkOffsAdj:2K/3KFIN	B4 SEF	ENG	[-16 to 16 / 0 / 2mm/step]

3.SP Mode Tables

SP No.	Large Category	Small Category	ENG or CTL	[Min to Max/Init./Step]
6-118-003	CmrStplrPrstkOfsAdj:2K/3KFIN	A4 SEF	ENG	[-16 to 16 / 0 / 2mm/step]
6-118-004	CmrStplrPrstkOfsAdj:2K/3KFIN	A4 LEF	ENG	[-16 to 16 / 0 / 2mm/step]
6-118-005	CmrStplrPrstkOfsAdj:2K/3KFIN	B5 SEF	ENG	[-16 to 16 / 0 / 2mm/step]
6-118-006	CmrStplrPrstkOfsAdj:2K/3KFIN	B5 LEF	ENG	[-16 to 16 / 0 / 2mm/step]
6-118-007	CmrStplrPrstkOfsAdj:2K/3KFIN	DLT SEF	ENG	[-16 to 16 / 0 / 2mm/step]
6-118-008	CmrStplrPrstkOfsAdj:2K/3KFIN	LG SEF	ENG	[-16 to 16 / 0 / 2mm/step]
6-118-009	CmrStplrPrstkOfsAdj:2K/3KFIN	Oficio SEF	ENG	[-16 to 16 / 0 / 2mm/step]
6-118-010	CmrStplrPrstkOfsAdj:2K/3KFIN	LT SEF	ENG	[-16 to 16 / 0 / 2mm/step]
6-118-011	CmrStplrPrstkOfsAdj:2K/3KFIN	LT LEF	ENG	[-16 to 16 / 0 / 2mm/step]
6-118-012	CmrStplrPrstkOfsAdj:2K/3KFIN	8K SEF	ENG	[-16 to 16 / 0 / 2mm/step]
6-118-013	CmrStplrPrstkOfsAdj:2K/3KFIN	16K SEF	ENG	[-16 to 16 / 0 / 2mm/step]
6-118-014	CmrStplrPrstkOfsAdj:2K/3KFIN	16K LEF	ENG	[-16 to 16 / 0 / 2mm/step]

3.SP Mode Tables

SP No.	Large Category	Small Category	ENG or CTL	[Min to Max/Init./Step]
6-118-015	CmnrStplrPrstkOfsAdj:2K/3KFIN	Other	ENG	[-16 to 16 / 0 / 2mm/step]
6-119-001	BookStplrPrstkOfsAdj:2K/3KFIN	A3 SEF	ENG	[-30 to 30 / 0 / 2mm/step]
6-119-002	BookStplrPrstkOfsAdj:2K/3KFIN	B4 SEF	ENG	[-30 to 30 / 0 / 2mm/step]
6-119-003	BookStplrPrstkOfsAdj:2K/3KFIN	A4 SEF	ENG	[-30 to 30 / 0 / 2mm/step]
6-119-004	BookStplrPrstkOfsAdj:2K/3KFIN	B5 SEF	ENG	[-30 to 30 / 0 / 2mm/step]
6-119-005	BookStplrPrstkOfsAdj:2K/3KFIN	DLT SEF	ENG	[-30 to 30 / 0 / 2mm/step]
6-119-006	BookStplrPrstkOfsAdj:2K/3KFIN	LG SEF	ENG	[-30 to 30 / 0 / 2mm/step]
6-119-007	BookStplrPrstkOfsAdj:2K/3KFIN	Oficio SEF	ENG	[-30 to 30 / 0 / 2mm/step]
6-119-008	BookStplrPrstkOfsAdj:2K/3KFIN	LT SEF	ENG	[-30 to 30 / 0 / 2mm/step]
6-119-009	BookStplrPrstkOfsAdj:2K/3KFIN	12"x18"	ENG	[-30 to 30 / 0 / 2mm/step]
6-119-010	BookStplrPrstkOfsAdj:2K/3KFIN	8K SEF	ENG	[-30 to 30 / 0 / 2mm/step]
6-119-011	BookStplrPrstkOfsAdj:2K/3KFIN	Other	ENG	[-30 to 30 / 0 / 2mm/step]

3.SP Mode Tables

SP No.	Large Category	Small Category	ENG or CTL	[Min to Max/Init./Step]
6-120-001	CrnStpPosExFeedAmtAdj:2K/3KFIN	A3 SEF	ENG	[0 to 30 / 0 / 10mm/step]
6-120-002	CrnStpPosExFeedAmtAdj:2K/3KFIN	B4 SEF	ENG	[0 to 30 / 0 / 10mm/step]
6-120-003	CrnStpPosExFeedAmtAdj:2K/3KFIN	A4 SEF	ENG	[0 to 30 / 0 / 10mm/step]
6-120-004	CrnStpPosExFeedAmtAdj:2K/3KFIN	A4 LEF	ENG	[0 to 30 / 0 / 10mm/step]
6-120-005	CrnStpPosExFeedAmtAdj:2K/3KFIN	B5 SEF	ENG	[0 to 30 / 0 / 10mm/step]
6-120-006	CrnStpPosExFeedAmtAdj:2K/3KFIN	B5 LEF	ENG	[0 to 30 / 0 / 10mm/step]
6-120-007	CrnStpPosExFeedAmtAdj:2K/3KFIN	DLT SEF	ENG	[0 to 30 / 0 / 10mm/step]
6-120-008	CrnStpPosExFeedAmtAdj:2K/3KFIN	LG SEF	ENG	[0 to 30 / 0 / 10mm/step]
6-120-009	CrnStpPosExFeedAmtAdj:2K/3KFIN	Oficio SEF	ENG	[0 to 30 / 0 / 10mm/step]
6-120-010	CrnStpPosExFeedAmtAdj:2K/3KFIN	LT SEF	ENG	[0 to 30 / 0 / 10mm/step]
6-120-011	CrnStpPosExFeedAmtAdj:2K/3KFIN	LT LEF	ENG	[0 to 30 / 0 / 10mm/step]
6-120-012	CrnStpPosExFeedAmtAdj:2K/3KFIN	8K SEF	ENG	[0 to 30 / 0 / 10mm/step]

3.SP Mode Tables

SP No.	Large Category	Small Category	ENG or CTL	[Min to Max/Init./Step]
6-120-013	CrmStpPosExFeedAmtAdj:2K/3KFIN	16K SEF	ENG	[0 to 30 / 0 / 10mm/step]
6-120-014	CrmStpPosExFeedAmtAdj:2K/3KFIN	16K LEF	ENG	[0 to 30 / 0 / 10mm/step]
6-120-015	CrmStpPosExFeedAmtAdj:2K/3KFIN	Other	ENG	[0 to 30 / 0 / 10mm/step]
6-121-001	NV Adj. Data Mod.	Jogger Pos. Factory Adj.	ENG	[-3.0 to 3.0 / 0.0 / 0.5mm/step]
6-121-002	NV Adj. Data Mod.	Folding Pos. Factory Adj.	ENG	[-1.4 to 1.4 / 0.0 / 0.2mm/step]
6-121-003	NV Adj. Data Mod.	Staple Stacking Fence Pos. Factory Adj.	ENG	[-1.0 to 1.0 / 0.0 / 0.2mm/step]
6-122-001	BkFoldJogSolMovAmtAdj:2K/3KFIN	A3 SEF	ENG	[-5 to 5 / 0 / 1mm/step]
6-122-002	BkFoldJogSolMovAmtAdj:2K/3KFIN	B4 SEF	ENG	[-5 to 5 / 0 / 1mm/step]
6-122-003	BkFoldJogSolMovAmtAdj:2K/3KFIN	A4 SEF	ENG	[-5 to 5 / 0 / 1mm/step]
6-122-004	BkFoldJogSolMovAmtAdj:2K/3KFIN	B5 SEF	ENG	[-5 to 5 / 0 / 1mm/step]
6-122-005	BkFoldJogSolMovAmtAdj:2K/3KFIN	DLT SEF	ENG	[-5 to 5 / 0 / 1mm/step]
6-122-006	BkFoldJogSolMovAmtAdj:2K/3KFIN	LG SEF	ENG	[-5 to 5 / 0 / 1mm/step]

3.SP Mode Tables

SP No.	Large Category	Small Category	ENG or CTL	[Min to Max/Init./Step]
6-122-007	BkFoldJogSolMovAmtAdj:2K/3KFIN	Oficio SEF	ENG	[-5 to 5 / 0 / 1mm/step]
6-122-008	BkFoldJogSolMovAmtAdj:2K/3KFIN	LT SEF	ENG	[-5 to 5 / 0 / 1mm/step]
6-122-009	BkFoldJogSolMovAmtAdj:2K/3KFIN	12"x18"	ENG	[-5 to 5 / 0 / 1mm/step]
6-122-010	BkFoldJogSolMovAmtAdj:2K/3KFIN	8K SEF	ENG	[-5 to 5 / 0 / 1mm/step]
6-122-011	BkFoldJogSolMovAmtAdj:2K/3KFIN	Other	ENG	[-5 to 5 / 0 / 1mm/step]
6-125-001	Use Paper Guide(Big Size)	All Size	ENG	[0 to 1 / 0 / 1/step]
6-126-001	Use Paper Guide(Small Size)	All Size	ENG	[0 to 1 / 0 / 1/step]
6-127-001	Paper Guide PossAdj:2K/3K FIN	All Size	ENG	[-10 to 10 / 0 / 1mm/step]
6-128-001	Paper Guide RetraAdj:2K/3K FIN	All Size	ENG	[-50 to 50 / 0 / 5mm/step]
6-129-001	Paper Guide AceptAdj:2K/3K FIN	All Size	ENG	[-50 to 50 / 0 / 5msec/step]
6-130-001	Sub-scan PunchPosAdj:FrontFIN	Domestic 2Hole(Europe 2Hole)	ENG	[-7.5 to 7.5 / 0.0 / 0.5mm/step]
6-130-002	Sub-scan PunchPosAdj:FrontFIN	North America 3Hole	ENG	[-7.5 to 7.5 / 0.0 / 0.5mm/step]

3.SP Mode Tables

SP No.	Large Category	Small Category	ENG or CTL	[Min to Max/Init./Step]
6-130-003	Sub-scan PunchPosAdj:FrontFIN	Europe 4Hole	ENG	[-7.5 to 7.5 / 0.0 / 0.5mm/step]
6-130-004	Sub-scan PunchPosAdj:FrontFIN	North Europe 4Hole	ENG	[-7.5 to 7.5 / 0.0 / 0.5mm/step]
6-130-005	Sub-scan PunchPosAdj:FrontFIN	North America 2Hole	ENG	[-7.5 to 7.5 / 0.0 / 0.5mm/step]
6-131-001	Main-scan PunchPosAdj:FrontFIN	Domestic 2Hole(Europe 2Hole)	ENG	[-2.0 to 2.0 / 0.0 / 0.4mm/step]
6-131-002	Main-scan PunchPosAdj:FrontFIN	North America 3Hole	ENG	[-2.0 to 2.0 / 0.0 / 0.4mm/step]
6-131-003	Main-scan PunchPosAdj:FrontFIN	Europe 4Hole	ENG	[-2.0 to 2.0 / 0.0 / 0.4mm/step]
6-131-004	Main-scan PunchPosAdj:FrontFIN	North Europe 4Hole	ENG	[-2.0 to 2.0 / 0.0 / 0.4mm/step]
6-131-005	Main-scan PunchPosAdj:FrontFIN	North America 2Hole	ENG	[-2.0 to 2.0 / 0.0 / 0.4mm/step]
6-132-001	Jogger Fence Fine Adj:FrontFIN	A3T	ENG	[-1.5 to 1.5 / 0.0 / 0.5mm/step]
6-132-002	Jogger Fence Fine Adj:FrontFIN	B4T	ENG	[-3.0 to 3.0 / 0.0 / 0.5mm/step]
6-132-003	Jogger Fence Fine Adj:FrontFIN	A4T	ENG	[-3.0 to 3.0 / 0.0 / 0.5mm/step]
6-132-004	Jogger Fence Fine Adj:FrontFIN	A4Y	ENG	[-1.5 to 1.5 / 0.0 / 0.5mm/step]

3.SP Mode Tables

SP No.	Large Category	Small Category	ENG or CTL	[Min to Max/Init./Step]
6-132-005	Jogger Fence Fine Adj:FrontFIN	B5T	ENG	[-3.0 to 3.0 / 0.0 / 0.5mm/step]
6-132-006	Jogger Fence Fine Adj:FrontFIN	B5Y	ENG	[-3.0 to 3.0 / 0.0 / 0.5mm/step]
6-132-007	Jogger Fence Fine Adj:FrontFIN	DLT-T	ENG	[-3.0 to 3.0 / 0.0 / 0.5mm/step]
6-132-008	Jogger Fence Fine Adj:FrontFIN	LG-T	ENG	[-3.0 to 3.0 / 0.0 / 0.5mm/step]
6-132-009	Jogger Fence Fine Adj:FrontFIN	Oficio-T	ENG	[-3.0 to 3.0 / 0.0 / 0.5mm/step]
6-132-010	Jogger Fence Fine Adj:FrontFIN	LT-T	ENG	[-3.0 to 3.0 / 0.0 / 0.5mm/step]
6-132-011	Jogger Fence Fine Adj:FrontFIN	LT-Y	ENG	[-3.0 to 3.0 / 0.0 / 0.5mm/step]
6-132-012	Jogger Fence Fine Adj:FrontFIN	8K-T	ENG	[-3.0 to 3.0 / 0.0 / 0.5mm/step]
6-132-013	Jogger Fence Fine Adj:FrontFIN	16K-T	ENG	[-3.0 to 3.0 / 0.0 / 0.5mm/step]
6-132-014	Jogger Fence Fine Adj:FrontFIN	16K-Y	ENG	[-3.0 to 3.0 / 0.0 / 0.5mm/step]
6-132-015	Jogger Fence Fine Adj:FrontFIN	Other	ENG	[-3.0 to 3.0 / 0.0 / 0.5mm/step]
6-133-001	Staple Position Adj: FrontFIN	Finisher1	ENG	[-2.0 to 2.0 / 0.0 / 0.5mm/step]

3.SP Mode Tables

SP No.	Large Category	Small Category	ENG or CTL	[Min to Max/Init./Step]
6-134-001	Finisher Free Run: FrontFIN	Free Run1	ENG	[0 to 1 / 0 / 1/step]
6-134-002	Finisher Free Run: FrontFIN	Free Run2	ENG	[0 to 1 / 0 / 1/step]
6-134-003	Finisher Free Run: FrontFIN	Free Run3	ENG	[0 to 1 / 0 / 1/step]
6-134-004	Finisher Free Run: FrontFIN	Free Run4	ENG	[0 to 1 / 0 / 1/step]
6-137-001	Pos Time Adj: FrontFIN	A3 SEF	ENG	[-100 to 100 / 0 / 1msec/step]
6-137-002	Pos Time Adj: FrontFIN	B4 SEF	ENG	[-100 to 100 / 0 / 1msec/step]
6-137-003	Pos Time Adj: FrontFIN	A4 SEF	ENG	[-100 to 100 / 0 / 1msec/step]
6-137-004	Pos Time Adj: FrontFIN	A4 LEF	ENG	[-100 to 100 / 0 / 1msec/step]
6-137-005	Pos Time Adj: FrontFIN	B5 SEF	ENG	[-100 to 100 / 0 / 1msec/step]
6-137-006	Pos Time Adj: FrontFIN	B5 LEF	ENG	[-100 to 100 / 0 / 1msec/step]
6-137-007	Pos Time Adj: FrontFIN	DLT SEF	ENG	[-100 to 100 / 0 / 1msec/step]
6-137-008	Pos Time Adj: FrontFIN	LG SEF	ENG	[-100 to 100 / 0 / 1msec/step]

3.SP Mode Tables

SP No.	Large Category	Small Category	ENG or CTL	[Min to Max/Init./Step]
6-137-009	Pos Time Adj: FrontFIN	Oficio SEF	ENG	[-100 to 100 / 0 / 1msec/step]
6-137-010	Pos Time Adj: FrontFIN	LT SEF	ENG	[-100 to 100 / 0 / 1msec/step]
6-137-011	Pos Time Adj: FrontFIN	LT LEF	ENG	[-100 to 100 / 0 / 1msec/step]
6-137-012	Pos Time Adj: FrontFIN	8K SEF	ENG	[-100 to 100 / 0 / 1msec/step]
6-137-013	Pos Time Adj: FrontFIN	16K SEF	ENG	[-100 to 100 / 0 / 1msec/step]
6-137-014	Pos Time Adj: FrontFIN	16K LEF	ENG	[-100 to 100 / 0 / 1msec/step]
6-137-015	Pos Time Adj: FrontFIN	Other	ENG	[-100 to 100 / 0 / 1msec/step]
6-140-001	Staple Position Adj: 1K FIN	Staple Stapler	ENG	[-3.5 to 3.5 / 0.0 / 0.5mm/step]
6-140-002	Staple Position Adj: 1K FIN	Stapleless Stapler	ENG	[-3.0 to 3.0 / 0.0 / 0.3mm/step]
6-141-001	Booklet Stapler Pos Adj:1K FIN	A3 SEF	ENG	[-3.0 to 3.0 / 0.0 / 0.2mm/step]
6-141-002	Booklet Stapler Pos Adj:1K FIN	B4 SEF	ENG	[-3.0 to 3.0 / 0.0 / 0.2mm/step]
6-141-003	Booklet Stapler Pos Adj:1K FIN	A4 SEF	ENG	[-3.0 to 3.0 / 0.0 / 0.2mm/step]

3.SP Mode Tables

SP No.	Large Category	Small Category	ENG or CTL	[Min to Max/Init./Step]
6-141-004	Booklet Stapler Pos Adj:1K FIN	B5 SEF	ENG	[-3.0 to 3.0 / 0.0 / 0.2mm/step]
6-141-005	Booklet Stapler Pos Adj:1K FIN	DLT SEF	ENG	[-3.0 to 3.0 / 0.0 / 0.2mm/step]
6-141-006	Booklet Stapler Pos Adj:1K FIN	LG SEF	ENG	[-3.0 to 3.0 / 0.0 / 0.2mm/step]
6-141-007	Booklet Stapler Pos Adj:1K FIN	Oficio SEF	ENG	[-3.0 to 3.0 / 0.0 / 0.2mm/step]
6-141-008	Booklet Stapler Pos Adj:1K FIN	LT SEF	ENG	[-3.0 to 3.0 / 0.0 / 0.2mm/step]
6-141-009	Booklet Stapler Pos Adj:1K FIN	12"x18"	ENG	[-3.0 to 3.0 / 0.0 / 0.2mm/step]
6-142-001	Sub-scan Punch Pos Adj:1K FIN	JPN/EU: 2-Hole	ENG	[-7.5 to 7.5 / 0.0 / 0.5mm/step]
6-142-002	Sub-scan Punch Pos Adj:1K FIN	NA: 3-Hole	ENG	[-7.5 to 7.5 / 0.0 / 0.5mm/step]
6-142-003	Sub-scan Punch Pos Adj:1K FIN	Europe: 4-Hole	ENG	[-7.5 to 7.5 / 0.0 / 0.5mm/step]
6-142-004	Sub-scan Punch Pos Adj:1K FIN	NEU: 4-Hole	ENG	[-7.5 to 7.5 / 0.0 / 0.5mm/step]
6-142-005	Sub-scan Punch Pos Adj:1K FIN	NA: 2-Hole	ENG	[-7.5 to 7.5 / 0.0 / 0.5mm/step]
6-143-001	Jogger Pos Adj:1K FIN	A3 SEF	ENG	[-1.5 to 1.5 / 0.0 / 0.5mm/step]

3.SP Mode Tables

SP No.	Large Category	Small Category	ENG or CTL	[Min to Max/Init./Step]
6-143-002	Jogger Pos Adj:1K FIN	B4 SEF	ENG	[-1.5 to 1.5 / 0.0 / 0.5mm/step]
6-143-003	Jogger Pos Adj:1K FIN	A4 SEF	ENG	[-1.5 to 1.5 / 0.0 / 0.5mm/step]
6-143-004	Jogger Pos Adj:1K FIN	A4 LEF	ENG	[-1.5 to 1.5 / 0.0 / 0.5mm/step]
6-143-005	Jogger Pos Adj:1K FIN	B5 SEF	ENG	[-1.5 to 1.5 / 0.0 / 0.5mm/step]
6-143-006	Jogger Pos Adj:1K FIN	B5 LEF	ENG	[-1.5 to 1.5 / 0.0 / 0.5mm/step]
6-143-007	Jogger Pos Adj:1K FIN	DLT SEF	ENG	[-1.5 to 1.5 / 0.0 / 0.5mm/step]
6-143-008	Jogger Pos Adj:1K FIN	LG SEF	ENG	[-1.5 to 1.5 / 0.0 / 0.5mm/step]
6-143-009	Jogger Pos Adj:1K FIN	Oficio SEF	ENG	[-1.5 to 1.5 / 0.0 / 0.5mm/step]
6-143-010	Jogger Pos Adj:1K FIN	LT SEF	ENG	[-1.5 to 1.5 / 0.0 / 0.5mm/step]
6-143-011	Jogger Pos Adj:1K FIN	LT LEF	ENG	[-1.5 to 1.5 / 0.0 / 0.5mm/step]
6-143-012	Jogger Pos Adj:1K FIN	12"x18"	ENG	[-1.5 to 1.5 / 0.0 / 0.5mm/step]
6-143-013	Jogger Pos Adj:1K FIN	8K SEF	ENG	[-1.5 to 1.5 / 0.0 / 0.5mm/step]

3.SP Mode Tables

SP No.	Large Category	Small Category	ENG or CTL	[Min to Max/Init./Step]
6-143-014	Jogger Pos Adj:1K FIN	16K SEF	ENG	[-1.5 to 1.5 / 0.0 / 0.5mm/step]
6-143-015	Jogger Pos Adj:1K FIN	16K LEF	ENG	[-1.5 to 1.5 / 0.0 / 0.5mm/step]
6-143-016	Jogger Pos Adj:1K FIN	Other	ENG	[-1.5 to 1.5 / 0.0 / 0.5mm/step]
6-144-001	Main-scan Punch Pos Adj:1K FIN	JPN/EU: 2-Hole	ENG	[-2.0 to 2.0 / 0.0 / 0.4mm/step]
6-144-002	Main-scan Punch Pos Adj:1K FIN	NA: 3-Hole	ENG	[-2.0 to 2.0 / 0.0 / 0.4mm/step]
6-144-003	Main-scan Punch Pos Adj:1K FIN	Europe: 4-Hole	ENG	[-2.0 to 2.0 / 0.0 / 0.4mm/step]
6-144-004	Main-scan Punch Pos Adj:1K FIN	NEU: 4-Hole	ENG	[-2.0 to 2.0 / 0.0 / 0.4mm/step]
6-144-005	Main-scan Punch Pos Adj:1K FIN	NA: 2-Hole	ENG	[-2.0 to 2.0 / 0.0 / 0.4mm/step]
6-145-001	Skew Correct Buckle Adj:1K FIN	A3 SEF	ENG	[-5.0 to 5.0 / 0.0 / 0.2mm/step]
6-145-002	Skew Correct Buckle Adj:1K FIN	B4 SEF	ENG	[-5.0 to 5.0 / 0.0 / 0.2mm/step]
6-145-003	Skew Correct Buckle Adj:1K FIN	A4 SEF	ENG	[-5.0 to 5.0 / 0.0 / 0.2mm/step]
6-145-004	Skew Correct Buckle Adj:1K FIN	A4 LEF	ENG	[-5.0 to 5.0 / 0.0 / 0.2mm/step]

3.SP Mode Tables

SP No.	Large Category	Small Category	ENG or CTL	[Min to Max/Init./Step]
6-145-005	Skew Correct Buckle Adj:1K FIN	B5 SEF	ENG	[-5.0 to 5.0 / 0.0 / 0.2mm/step]
6-145-006	Skew Correct Buckle Adj:1K FIN	B5 LEF	ENG	[-5.0 to 5.0 / 0.0 / 0.2mm/step]
6-145-007	Skew Correct Buckle Adj:1K FIN	A5 LEF	ENG	[-5.0 to 5.0 / 0.0 / 0.2mm/step]
6-145-008	Skew Correct Buckle Adj:1K FIN	DLT SEF	ENG	[-5.0 to 5.0 / 0.0 / 0.2mm/step]
6-145-009	Skew Correct Buckle Adj:1K FIN	LG SEF	ENG	[-5.0 to 5.0 / 0.0 / 0.2mm/step]
6-145-010	Skew Correct Buckle Adj:1K FIN	Oficio SEF	ENG	[-5.0 to 5.0 / 0.0 / 0.2mm/step]
6-145-011	Skew Correct Buckle Adj:1K FIN	LT SEF	ENG	[-5.0 to 5.0 / 0.0 / 0.2mm/step]
6-145-012	Skew Correct Buckle Adj:1K FIN	LT LEF	ENG	[-5.0 to 5.0 / 0.0 / 0.2mm/step]
6-145-013	Skew Correct Buckle Adj:1K FIN	HLT LEF	ENG	[-5.0 to 5.0 / 0.0 / 0.2mm/step]
6-145-014	Skew Correct Buckle Adj:1K FIN	12"x18"	ENG	[-5.0 to 5.0 / 0.0 / 0.2mm/step]
6-145-015	Skew Correct Buckle Adj:1K FIN	8K SEF	ENG	[-5.0 to 5.0 / 0.0 / 0.2mm/step]
6-145-016	Skew Correct Buckle Adj:1K FIN	16K SEF	ENG	[-5.0 to 5.0 / 0.0 / 0.2mm/step]

3.SP Mode Tables

SP No.	Large Category	Small Category	ENG or CTL	[Min to Max/Init./Step]
6-145-017	Skew Correct Buckle Adj:1K FIN	16K LEF	ENG	[-5.0 to 5.0 / 0.0 / 0.2mm/step]
6-145-018	Skew Correct Buckle Adj:1K FIN	Other	ENG	[-5.0 to 5.0 / 0.0 / 0.2mm/step]
6-146-001	Skew Correct Ctrl SW:1K FIN	A3 SEF	ENG	[0 to 1 / 0 / 1/step]
6-146-002	Skew Correct Ctrl SW:1K FIN	B4 SEF	ENG	[0 to 1 / 0 / 1/step]
6-146-003	Skew Correct Ctrl SW:1K FIN	A4 SEF	ENG	[0 to 1 / 0 / 1/step]
6-146-004	Skew Correct Ctrl SW:1K FIN	A4 LEF	ENG	[0 to 1 / 0 / 1/step]
6-146-005	Skew Correct Ctrl SW:1K FIN	B5 SEF	ENG	[0 to 1 / 0 / 1/step]
6-146-006	Skew Correct Ctrl SW:1K FIN	B5 LEF	ENG	[0 to 1 / 0 / 1/step]
6-146-007	Skew Correct Ctrl SW:1K FIN	A5 LEF	ENG	[0 to 1 / 0 / 1/step]
6-146-008	Skew Correct Ctrl SW:1K FIN	DLT SEF	ENG	[0 to 1 / 0 / 1/step]
6-146-009	Skew Correct Ctrl SW:1K FIN	LG SEF	ENG	[0 to 1 / 0 / 1/step]
6-146-010	Skew Correct Ctrl SW:1K FIN	Oficio SEF	ENG	[0 to 1 / 0 / 1/step]

3.SP Mode Tables

SP No.	Large Category	Small Category	ENG or CTL	[Min to Max/Init./Step]
6-146-011	Skew Correct Ctrl SW:1K FIN	LT SEF	ENG	[0 to 1 / 0 / 1/step]
6-146-012	Skew Correct Ctrl SW:1K FIN	LT LEF	ENG	[0 to 1 / 0 / 1/step]
6-146-013	Skew Correct Ctrl SW:1K FIN	HLT LEF	ENG	[0 to 1 / 0 / 1/step]
6-146-014	Skew Correct Ctrl SW:1K FIN	12"x18"	ENG	[0 to 1 / 0 / 1/step]
6-146-015	Skew Correct Ctrl SW:1K FIN	8K SEF	ENG	[0 to 1 / 0 / 1/step]
6-146-016	Skew Correct Ctrl SW:1K FIN	16K SEF	ENG	[0 to 1 / 0 / 1/step]
6-146-017	Skew Correct Ctrl SW:1K FIN	16K LEF	ENG	[0 to 1 / 0 / 1/step]
6-146-018	Skew Correct Ctrl SW:1K FIN	Other	ENG	[0 to 1 / 0 / 1/step]
6-147-001	Booklet Folder Pos Adj:1K FIN	A3 SEF	ENG	[-3.0 to 3.0 / 0.0 / 0.2mm/step]
6-147-002	Booklet Folder Pos Adj:1K FIN	B4 SEF	ENG	[-3.0 to 3.0 / 0.0 / 0.2mm/step]
6-147-003	Booklet Folder Pos Adj:1K FIN	A4 SEF	ENG	[-3.0 to 3.0 / 0.0 / 0.2mm/step]
6-147-004	Booklet Folder Pos Adj:1K FIN	B5 SEF	ENG	[-3.0 to 3.0 / 0.0 / 0.2mm/step]

3.SP Mode Tables

SP No.	Large Category	Small Category	ENG or CTL	[Min to Max/Init./Step]
6-147-005	Booklet Folder Pos Adj:1K FIN	DLT SEF	ENG	[-3.0 to 3.0 / 0.0 / 0.2mm/step]
6-147-006	Booklet Folder Pos Adj:1K FIN	LG SEF	ENG	[-3.0 to 3.0 / 0.0 / 0.2mm/step]
6-147-007	Booklet Folder Pos Adj:1K FIN	Oficio SEF	ENG	[-3.0 to 3.0 / 0.0 / 0.2mm/step]
6-147-008	Booklet Folder Pos Adj:1K FIN	LT SEF	ENG	[-3.0 to 3.0 / 0.0 / 0.2mm/step]
6-147-009	Booklet Folder Pos Adj:1K FIN	12"x18"	ENG	[-3.0 to 3.0 / 0.0 / 0.2mm/step]
6-147-010	Booklet Folder Pos Adj:1K FIN	A3 SEF(1-5)	ENG	[-3.0 to 3.0 / 0.0 / 0.2mm/step]
6-147-011	Booklet Folder Pos Adj:1K FIN	A3 SEF(6-10)	ENG	[-3.0 to 3.0 / 0.0 / 0.2mm/step]
6-147-012	Booklet Folder Pos Adj:1K FIN	A3 SEF(11-over)	ENG	[-3.0 to 3.0 / 0.0 / 0.2mm/step]
6-147-013	Booklet Folder Pos Adj:1K FIN	B4 SEF(1-5)	ENG	[-3.0 to 3.0 / 0.0 / 0.2mm/step]
6-147-014	Booklet Folder Pos Adj:1K FIN	B4 SEF(6-10)	ENG	[-3.0 to 3.0 / 0.0 / 0.2mm/step]
6-147-015	Booklet Folder Pos Adj:1K FIN	B4 SEF(11-over)	ENG	[-3.0 to 3.0 / 0.0 / 0.2mm/step]
6-147-016	Booklet Folder Pos Adj:1K FIN	A4 SEF(1-5)	ENG	[-3.0 to 3.0 / 0.0 / 0.2mm/step]

3.SP Mode Tables

SP No.	Large Category	Small Category	ENG or CTL	[Min to Max/Init./Step]
6-147-017	Booklet Folder Pos Adj:1K FIN	A4 SEF(6-10)	ENG	[-3.0 to 3.0 / 0.0 / 0.2mm/step]
6-147-018	Booklet Folder Pos Adj:1K FIN	A4 SEF(11-over)	ENG	[-3.0 to 3.0 / 0.0 / 0.2mm/step]
6-147-019	Booklet Folder Pos Adj:1K FIN	B5 SEF(1-5)	ENG	[-3.0 to 3.0 / 0.0 / 0.2mm/step]
6-147-020	Booklet Folder Pos Adj:1K FIN	B5 SEF(6-10)	ENG	[-3.0 to 3.0 / 0.0 / 0.2mm/step]
6-147-021	Booklet Folder Pos Adj:1K FIN	B5 SEF(11-over)	ENG	[-3.0 to 3.0 / 0.0 / 0.2mm/step]
6-147-022	Booklet Folder Pos Adj:1K FIN	DLT SEF(1-5)	ENG	[-3.0 to 3.0 / 0.0 / 0.2mm/step]
6-147-023	Booklet Folder Pos Adj:1K FIN	DLT SEF(6-10)	ENG	[-3.0 to 3.0 / 0.0 / 0.2mm/step]
6-147-024	Booklet Folder Pos Adj:1K FIN	DLT SEF(11-over)	ENG	[-3.0 to 3.0 / 0.0 / 0.2mm/step]
6-147-025	Booklet Folder Pos Adj:1K FIN	LG SEF(1-5)	ENG	[-3.0 to 3.0 / 0.0 / 0.2mm/step]
6-147-026	Booklet Folder Pos Adj:1K FIN	LG SEF(6-10)	ENG	[-3.0 to 3.0 / 0.0 / 0.2mm/step]
6-147-027	Booklet Folder Pos Adj:1K FIN	LG SEF(11-over)	ENG	[-3.0 to 3.0 / 0.0 / 0.2mm/step]
6-147-028	Booklet Folder Pos Adj:1K FIN	Oficio SEF(1-5)	ENG	[-3.0 to 3.0 / 0.0 / 0.2mm/step]

3.SP Mode Tables

SP No.	Large Category	Small Category	ENG or CTL	[Min to Max/Init./Step]
6-147-029	Booklet Folder Pos Adj:1K FIN	Oficio SEF(6-10)	ENG	[-3.0 to 3.0 / 0.0 / 0.2mm/step]
6-147-030	Booklet Folder Pos Adj:1K FIN	Oficio SEF(11-over)	ENG	[-3.0 to 3.0 / 0.0 / 0.2mm/step]
6-147-031	Booklet Folder Pos Adj:1K FIN	LT SEF(1-5)	ENG	[-3.0 to 3.0 / 0.0 / 0.2mm/step]
6-147-032	Booklet Folder Pos Adj:1K FIN	LT SEF(6-10)	ENG	[-3.0 to 3.0 / 0.0 / 0.2mm/step]
6-147-033	Booklet Folder Pos Adj:1K FIN	LT SEF(11-over)	ENG	[-3.0 to 3.0 / 0.0 / 0.2mm/step]
6-147-034	Booklet Folder Pos Adj:1K FIN	12"x18"(1-5)	ENG	[-3.0 to 3.0 / 0.0 / 0.2mm/step]
6-147-035	Booklet Folder Pos Adj:1K FIN	12"x18"(6-10)	ENG	[-3.0 to 3.0 / 0.0 / 0.2mm/step]
6-147-036	Booklet Folder Pos Adj:1K FIN	12"x18"(11-over)	ENG	[-3.0 to 3.0 / 0.0 / 0.2mm/step]
6-148-001	Fold Times Adj: 1K FIN		ENG	[0 to 29 / 0 / 1sec/step]
6-149-001	Last Paper Pos Time Adj:1K FIN		ENG	[0 to 1 / 0 / 1times/step]
6-150-001	PositioningStrtTimingAdj:1KFIN	A3 SEF	ENG	[-100 to 100 / 0 / 10msec/step]
6-150-002	PositioningStrtTimingAdj:1KFIN	B4 SEF	ENG	[-100 to 100 / 0 / 10msec/step]

3.SP Mode Tables

SP No.	Large Category	Small Category	ENG or CTL	[Min to Max/Init./Step]
6-150-003	PositioningStrtTimingAdj:1KFIN	A4 SEF	ENG	[-100 to 100 / 0 / 10msec/step]
6-150-004	PositioningStrtTimingAdj:1KFIN	A4 LEF	ENG	[-100 to 100 / 0 / 10msec/step]
6-150-005	PositioningStrtTimingAdj:1KFIN	B5 SEF	ENG	[-100 to 100 / 0 / 10msec/step]
6-150-006	PositioningStrtTimingAdj:1KFIN	B5 LEF	ENG	[-100 to 100 / 0 / 10msec/step]
6-150-007	PositioningStrtTimingAdj:1KFIN	DLT SEF	ENG	[-100 to 100 / 0 / 10msec/step]
6-150-008	PositioningStrtTimingAdj:1KFIN	LG SEF	ENG	[-100 to 100 / 0 / 10msec/step]
6-150-009	PositioningStrtTimingAdj:1KFIN	Oficio SEF	ENG	[-100 to 100 / 0 / 10msec/step]
6-150-010	PositioningStrtTimingAdj:1KFIN	LT SEF	ENG	[-100 to 100 / 0 / 10msec/step]
6-150-011	PositioningStrtTimingAdj:1KFIN	LT LEF	ENG	[-100 to 100 / 0 / 10msec/step]
6-150-012	PositioningStrtTimingAdj:1KFIN	12"x18"	ENG	[-100 to 100 / 0 / 10msec/step]
6-150-013	PositioningStrtTimingAdj:1KFIN	8K SEF	ENG	[-100 to 100 / 0 / 10msec/step]
6-150-014	PositioningStrtTimingAdj:1KFIN	16K SEF	ENG	[-100 to 100 / 0 / 10msec/step]

3.SP Mode Tables

SP No.	Large Category	Small Category	ENG or CTL	[Min to Max/Init./Step]
6-150-015	PositioningStrtTimingAdj:1KFIN	16K LEF	ENG	[-100 to 100 / 0 / 10msec/step]
6-150-016	PositioningStrtTimingAdj:1KFIN	Other	ENG	[-100 to 100 / 0 / 10msec/step]
6-151-001	PosTimeAdj(LstPr2ndTime):1KFIN		ENG	[-100 to 100 / 0 / 10msec/step]
6-152-001	PosTiAdj(ExcLstPr3rdTi):1KFIN	A3 SEF	ENG	[-100 to 100 / 0 / 10msec/step]
6-152-002	PosTiAdj(ExcLstPr3rdTi):1KFIN	B4 SEF	ENG	[-100 to 100 / 0 / 10msec/step]
6-152-003	PosTiAdj(ExcLstPr3rdTi):1KFIN	A4 SEF	ENG	[-100 to 100 / 0 / 10msec/step]
6-152-004	PosTiAdj(ExcLstPr3rdTi):1KFIN	A4 LEF	ENG	[-100 to 100 / 0 / 10msec/step]
6-152-005	PosTiAdj(ExcLstPr3rdTi):1KFIN	B5 SEF	ENG	[-100 to 100 / 0 / 10msec/step]
6-152-006	PosTiAdj(ExcLstPr3rdTi):1KFIN	B5 LEF	ENG	[-100 to 100 / 0 / 10msec/step]
6-152-007	PosTiAdj(ExcLstPr3rdTi):1KFIN	DLT SEF	ENG	[-100 to 100 / 0 / 10msec/step]
6-152-008	PosTiAdj(ExcLstPr3rdTi):1KFIN	LG SEF	ENG	[-100 to 100 / 0 / 10msec/step]
6-152-009	PosTiAdj(ExcLstPr3rdTi):1KFIN	Oficio SEF	ENG	[-100 to 100 / 0 / 10msec/step]

3.SP Mode Tables

SP No.	Large Category	Small Category	ENG or CTL	[Min to Max/Init./Step]
6-152-010	PosTiAdj(ExcLstPr3rdTi):1KFIN	LT SEF	ENG	[-100 to 100 / 0 / 10msec/step]
6-152-011	PosTiAdj(ExcLstPr3rdTi):1KFIN	LT LEF	ENG	[-100 to 100 / 0 / 10msec/step]
6-152-012	PosTiAdj(ExcLstPr3rdTi):1KFIN	12"x18"	ENG	[-100 to 100 / 0 / 10msec/step]
6-152-013	PosTiAdj(ExcLstPr3rdTi):1KFIN	8K SEF	ENG	[-100 to 100 / 0 / 10msec/step]
6-152-014	PosTiAdj(ExcLstPr3rdTi):1KFIN	16K SEF	ENG	[-100 to 100 / 0 / 10msec/step]
6-152-015	PosTiAdj(ExcLstPr3rdTi):1KFIN	16K LEF	ENG	[-100 to 100 / 0 / 10msec/step]
6-152-016	PosTiAdj(ExcLstPr3rdTi):1KFIN	Other	ENG	[-100 to 100 / 0 / 10msec/step]
6-154-001	Pos Time Adj By Sheet: 1K FIN	1 - 10 Sheets	ENG	[-100 to 100 / 0 / 10msec/step]
6-154-002	Pos Time Adj By Sheet: 1K FIN	11 - 20 Sheets	ENG	[-100 to 100 / 0 / 10msec/step]
6-154-003	Pos Time Adj By Sheet: 1K FIN	21 - 30 Sheets	ENG	[-100 to 100 / 0 / 10msec/step]
6-154-004	Pos Time Adj By Sheet: 1K FIN	31 - 40 Sheets	ENG	[-100 to 100 / 0 / 10msec/step]
6-154-005	Pos Time Adj By Sheet: 1K FIN	41 - 50 Sheets	ENG	[-100 to 100 / 0 / 10msec/step]

3.SP Mode Tables

SP No.	Large Category	Small Category	ENG or CTL	[Min to Max/Init./Step]
6-155-001	Paper Guide Poss Adj: 1K FIN		ENG	[-10 to 10 / 0 / 1mm/step]
6-156-001	Paper Guide Retra Adj: 1K FIN		ENG	[-50 to 50 / 0 / 5mm/step]
6-157-001	Paper Guide Acept Adj: 1K FIN		ENG	[-50 to 50 / 0 / 5msec/step]
6-158-001	Bind Speed Setting: 1K FIN_HY		ENG	[1 to 3 / 3 / 2/step]
6-159-001	Bind Times: 1K FIN_HY		ENG*	[1 to 2 / 2 / 1/step]
6-160-001	Finisher Free Run: 1K FIN	Free Run 1	ENG	[0 to 1 / 0 / 1/step]
6-160-002	Finisher Free Run: 1K FIN	Free Run 2	ENG	[0 to 1 / 0 / 1/step]
6-160-003	Finisher Free Run: 1K FIN	Free Run 3	ENG	[0 to 1 / 0 / 1/step]
6-160-004	Finisher Free Run: 1K FIN	Maintenance Part Positioning Free Run	ENG	[0 to 1 / 0 / 1/step]
6-163-001	Use Paper Guide	Big Size	ENG	[0 to 1 / 1 / 1/step]
6-163-002	Use Paper Guide	Small Size	ENG	[0 to 1 / 0 / 1/step]
6-164-001	NV Adj. Data Mod. 1KShtFIN	Jogger Pos. Factory Adj.	ENG	[-1.5 to 1.5 / 0.0 / 0.5mm/step]

3.SP Mode Tables

SP No.	Large Category	Small Category	ENG or CTL	[Min to Max/Init./Step]
6-164-002	NV Adj. Data Mod. 1KShtFIN	Stapling Pos. Factory Adj.	ENG	[-2.0 to 2.0 / 0.0 / 0.5mm/step]
6-164-003	NV Adj. Data Mod. 1KShtFIN HY	Stapling Pos. Factory Adj. (HY)	ENG	[-2.1 to 2.1 / 0.0 / 0.3mm/step]
6-164-004	NV Adj. Data Mod. 1KShtFIN HY	Stapleless Stapling Pos. Factory Adj.	ENG	[-2.1 to 2.1 / 0.0 / 0.3mm/step]
6-164-005	NV Adj. Data Mod. 1KShtFIN	Folding Pos. Factory Adj.	ENG	[-2.0 to 2.0 / 0.0 / 0.1mm/step]
6-164-006	NV Adj. Data Mod. 1KShtFIN	Booklet Stapler Pos. Factory Adj.	ENG	[-3.0 to 3.0 / 0.0 / 0.1mm/step]
6-180-001	M-ScanBindPosAdj:NoStplBindFIN		ENG	[-1.0 to 1.0 / 0.0 / 0.5mm/step]
6-182-001	ExitSpeedSwitch:NoStplBindFIN	PaperLength:297.0-457.2mm,Thick(106-300g/m2)	ENG	[0 to 4 / 1 / 1/step]
6-182-002	ExitSpeedSwitch:NoStplBindFIN	PaperLength:297.0-457.2mm,Plain(60-105g/m2)	ENG	[0 to 4 / 1 / 1/step]
6-182-003	ExitSpeedSwitch:NoStplBindFIN	PaperLength:297.0-457.2mm,Thin(52-59g/m2)	ENG	[0 to 4 / 3 / 1/step]
6-182-004	ExitSpeedSwitch:NoStplBindFIN	PaperLength:210.0-296.9mm,Thick(106-300g/m2)	ENG	[0 to 4 / 1 / 1/step]
6-182-005	ExitSpeedSwitch:NoStplBindFIN	PaperLength:210.0-296.9mm,Plain(60-105g/m2)	ENG	[0 to 4 / 1 / 1/step]
6-182-006	ExitSpeedSwitch:NoStplBindFIN	PaperLength:210.0-296.9mm,Thin(52-59g/m2)	ENG	[0 to 4 / 3 / 1/step]

3.SP Mode Tables

SP No.	Large Category	Small Category	ENG or CTL	[Min to Max/Init./Step]
6-182-007	ExitSpeedSwitch:NoStplBindFIN	PaperLength:148.0-209.9mm,Thick(106-300g/m2)	ENG	[0 to 4 / 1 / 1/step]
6-182-008	ExitSpeedSwitch:NoStplBindFIN	PaperLength:148.0-209.9mm,Plain(60-105g/m2)	ENG	[0 to 4 / 1 / 1/step]
6-182-009	ExitSpeedSwitch:NoStplBindFIN	PaperLength:148.0-209.9mm,Thin(52-59g/m2)	ENG	[0 to 4 / 3 / 1/step]
6-183-001	FinisherFreeRun:NoStplBindFIN	Free Run 1	ENG	[0 to 1 / 0 / 0/step]
6-183-002	FinisherFreeRun:NoStplBindFIN	Free Run 2	ENG	[0 to 1 / 0 / 0/step]
6-183-003	FinisherFreeRun:NoStplBindFIN	Free Run 3	ENG	[0 to 1 / 0 / 0/step]
6-186-001	BindTimes NoStplBindFIN		ENG*	[1 to 2 / 2 / 1/step]
6-301-001	Z-Fold:FineAdj 1st	A3 SEF	ENG	[-4.0 to 4.0 / 0.0 / 0.1mm/step]
6-301-002	Z-Fold:FineAdj 1st	B4 SEF	ENG	[-4.0 to 4.0 / 0.0 / 0.1mm/step]
6-301-003	Z-Fold:FineAdj 1st	A4 SEF	ENG	[-4.0 to 4.0 / 0.0 / 0.1mm/step]
6-301-004	Z-Fold:FineAdj 1st	DLT SEF	ENG	[-4.0 to 4.0 / 0.0 / 0.1mm/step]
6-301-005	Z-Fold:FineAdj 1st	LG SEF	ENG	[-4.0 to 4.0 / 0.0 / 0.1mm/step]

3.SP Mode Tables

SP No.	Large Category	Small Category	ENG or CTL	[Min to Max/Init./Step]
6-301-006	Z-Fold:FineAdj 1st	LT SEF	ENG	[-4.0 to 4.0 / 0.0 / 0.1mm/step]
6-301-007	Z-Fold:FineAdj 1st	8K SEF	ENG	[-4.0 to 4.0 / 0.0 / 0.1mm/step]
6-301-008	Z-Fold:FineAdj 1st	Oficio SEF	ENG	[-4.0 to 4.0 / 0.0 / 0.1mm/step]
6-301-009	Z-Fold:FineAdj 1st	Other	ENG	[-4.0 to 4.0 / 0.0 / 0.1mm/step]
6-302-001	Z-Fold:FineAdj 2nd	A3 SEF	ENG	[-4.0 to 4.0 / 0.0 / 0.2mm/step]
6-302-002	Z-Fold:FineAdj 2nd	B4 SEF	ENG	[-4.0 to 4.0 / 0.0 / 0.2mm/step]
6-302-003	Z-Fold:FineAdj 2nd	A4 SEF	ENG	[-4.0 to 4.0 / 0.0 / 0.2mm/step]
6-302-004	Z-Fold:FineAdj 2nd	DLT SEF	ENG	[-4.0 to 4.0 / 0.0 / 0.2mm/step]
6-302-005	Z-Fold:FineAdj 2nd	LG SEF	ENG	[-4.0 to 4.0 / 0.0 / 0.2mm/step]
6-302-006	Z-Fold:FineAdj 2nd	LT SEF	ENG	[-4.0 to 4.0 / 0.0 / 0.2mm/step]
6-302-007	Z-Fold:FineAdj 2nd	8K SEF	ENG	[-4.0 to 4.0 / 0.0 / 0.2mm/step]
6-302-008	Z-Fold:FineAdj 2nd	Oficio SEF	ENG	[-4.0 to 4.0 / 0.0 / 0.2mm/step]

3.SP Mode Tables

SP No.	Large Category	Small Category	ENG or CTL	[Min to Max/Init./Step]
6-302-009	Z-Fold:FineAdj 2nd	Other	ENG	[-4.0 to 4.0 / 0.0 / 0.2mm/step]
6-304-001	Equal 1/2:FineAdjFld	A3 SEF	ENG	[-4.0 to 4.0 / 0.0 / 0.1mm/step]
6-304-002	Equal 1/2:FineAdjFld	B4 SEF	ENG	[-4.0 to 4.0 / 0.0 / 0.1mm/step]
6-304-003	Equal 1/2:FineAdjFld	A4 SEF	ENG	[-4.0 to 4.0 / 0.0 / 0.1mm/step]
6-304-004	Equal 1/2:FineAdjFld	DLT SEF	ENG	[-4.0 to 4.0 / 0.0 / 0.1mm/step]
6-304-005	Equal 1/2:FineAdjFld	LG SEF	ENG	[-4.0 to 4.0 / 0.0 / 0.1mm/step]
6-304-006	Equal 1/2:FineAdjFld	LT SEF	ENG	[-4.0 to 4.0 / 0.0 / 0.1mm/step]
6-304-007	Equal 1/2:FineAdjFld	8K SEF	ENG	[-4.0 to 4.0 / 0.0 / 0.1mm/step]
6-304-008	Equal 1/2:FineAdjFld	12x18inch	ENG	[-4.0 to 4.0 / 0.0 / 0.1mm/step]
6-304-009	Equal 1/2:FineAdjFld	Oficio SEF	ENG	[-4.0 to 4.0 / 0.0 / 0.1mm/step]
6-304-010	Equal 1/2:FineAdjFld	Other	ENG	[-4.0 to 4.0 / 0.0 / 0.1mm/step]
6-307-001	Equal 3rds:Fine Adj 1st	A3 SEF	ENG	[-4.0 to 4.0 / 0.0 / 0.1mm/step]

3.SP Mode Tables

SP No.	Large Category	Small Category	ENG or CTL	[Min to Max/Init./Step]
6-307-002	Equal 3rds:Fine Adj 1st	DLT SEF	ENG	[-4.0 to 4.0 / 0.0 / 0.1mm/step]
6-307-003	Equal 3rds:Fine Adj 1st	A4 SEF	ENG	[-4.0 to 4.0 / 0.0 / 0.1mm/step]
6-307-004	Equal 3rds:Fine Adj 1st	LG SEF	ENG	[-4.0 to 4.0 / 0.0 / 0.1mm/step]
6-307-005	Equal 3rds:Fine Adj 1st	LT SEF	ENG	[-4.0 to 4.0 / 0.0 / 0.1mm/step]
6-307-006	Equal 3rds:Fine Adj 1st	Oficio SEF	ENG	[-4.0 to 4.0 / 0.0 / 0.1mm/step]
6-307-007	Equal 3rds:Fine Adj 1st	Other	ENG	[-4.0 to 4.0 / 0.0 / 0.1mm/step]
6-308-001	Equal 3rds:Fine Adj 2nd	A3 SEF	ENG	[-4.0 to 4.0 / 0.0 / 0.1mm/step]
6-308-002	Equal 3rds:Fine Adj 2nd	DLT SEF	ENG	[-4.0 to 4.0 / 0.0 / 0.1mm/step]
6-308-003	Equal 3rds:Fine Adj 2nd	A4 SEF	ENG	[-4.0 to 4.0 / 0.0 / 0.1mm/step]
6-308-004	Equal 3rds:Fine Adj 2nd	LG SEF	ENG	[-4.0 to 4.0 / 0.0 / 0.1mm/step]
6-308-005	Equal 3rds:Fine Adj 2nd	LT SEF	ENG	[-4.0 to 4.0 / 0.0 / 0.1mm/step]
6-308-006	Equal 3rds:Fine Adj 2nd	Oficio SEF	ENG	[-4.0 to 4.0 / 0.0 / 0.1mm/step]

3.SP Mode Tables

SP No.	Large Category	Small Category	ENG or CTL	[Min to Max/Init./Step]
6-308-007	Equal 3rds:Fine Adj 2nd	Other	ENG	[-4.0 to 4.0 / 0.0 / 0.1mm/step]
6-311-001	3rds 1 Flap:Fine Adj 1st	A3 SEF	ENG	[-4.0 to 4.0 / 0.0 / 0.1mm/step]
6-311-002	3rds 1 Flap:Fine Adj 1st	DLT SEF	ENG	[-4.0 to 4.0 / 0.0 / 0.1mm/step]
6-311-003	3rds 1 Flap:Fine Adj 1st	A4 SEF	ENG	[-4.0 to 4.0 / 0.0 / 0.1mm/step]
6-311-004	3rds 1 Flap:Fine Adj 1st	LG SEF	ENG	[-4.0 to 4.0 / 0.0 / 0.1mm/step]
6-311-005	3rds 1 Flap:Fine Adj 1st	LT SEF	ENG	[-4.0 to 4.0 / 0.0 / 0.1mm/step]
6-311-006	3rds 1 Flap:Fine Adj 1st	Oficio SEF	ENG	[-4.0 to 4.0 / 0.0 / 0.1mm/step]
6-311-007	3rds 1 Flap:Fine Adj 1st	Other	ENG	[-4.0 to 4.0 / 0.0 / 0.1mm/step]
6-312-001	3rds 1 Flap:Fine Adj 2nd	A3 SEF	ENG	[-4.0 to 4.0 / 0.0 / 0.1mm/step]
6-312-002	3rds 1 Flap:Fine Adj 2nd	DLT SEF	ENG	[-4.0 to 4.0 / 0.0 / 0.1mm/step]
6-312-003	3rds 1 Flap:Fine Adj 2nd	A4 SEF	ENG	[-4.0 to 4.0 / 0.0 / 0.1mm/step]
6-312-004	3rds 1 Flap:Fine Adj 2nd	LG SEF	ENG	[-4.0 to 4.0 / 0.0 / 0.1mm/step]

3.SP Mode Tables

SP No.	Large Category	Small Category	ENG or CTL	[Min to Max/Init./Step]
6-312-005	3rds 1 Flap:Fine Adj 2nd	LT SEF	ENG	[-4.0 to 4.0 / 0.0 / 0.1mm/step]
6-312-006	3rds 1 Flap:Fine Adj 2nd	Oficio SEF	ENG	[-4.0 to 4.0 / 0.0 / 0.1mm/step]
6-312-007	3rds 1 Flap:Fine Adj 2nd	Other	ENG	[-4.0 to 4.0 / 0.0 / 0.1mm/step]
6-313-001	Registration Buckle Adjust	A3 SEF	ENG	[0.0 to 5.0 / 2.0 / 0.5mm/step]
6-313-002	Registration Buckle Adjust	B4 SEF	ENG	[0.0 to 5.0 / 2.0 / 0.5mm/step]
6-313-003	Registration Buckle Adjust	A4 SEF	ENG	[0.0 to 5.0 / 2.0 / 0.5mm/step]
6-313-004	Registration Buckle Adjust	DLT SEF	ENG	[0.0 to 5.0 / 2.0 / 0.5mm/step]
6-313-005	Registration Buckle Adjust	LG SEF	ENG	[0.0 to 5.0 / 2.0 / 0.5mm/step]
6-313-006	Registration Buckle Adjust	LT SEF	ENG	[0.0 to 5.0 / 2.0 / 0.5mm/step]
6-313-007	Registration Buckle Adjust	8K SEF	ENG	[0.0 to 5.0 / 2.0 / 0.5mm/step]
6-313-008	Registration Buckle Adjust	12x18inch	ENG	[0.0 to 5.0 / 2.0 / 0.5mm/step]
6-313-009	Registration Buckle Adjust	Oficio SEF	ENG	[0.0 to 5.0 / 2.0 / 0.5mm/step]

3.SP Mode Tables

SP No.	Large Category	Small Category	ENG or CTL	[Min to Max/Init./Step]
6-313-010	Registration Buckle Adjust	Other	ENG	[0.0 to 5.0 / 2.0 / 0.5mm/step]
6-314-001	Registration Buckle Select		ENG	[0 to 1 / 0 / 1/step]
6-315-001	Set Number of Creasing		ENG	[0 to 4 / 1 / 1times/step]
6-316-001	Silent Mode Select		ENG	[0 to 1 / 0 / 1/step]
6-317-001	Not Fold Exit Speed	Plain: Large-Size	ENG	[0 to 4 / 1 / 1/step]
6-317-002	Not Fold Exit Speed	Plain: Middle-Size	ENG	[0 to 4 / 0 / 1/step]
6-317-003	Not Fold Exit Speed	Plain: Small-Size	ENG	[0 to 4 / 0 / 1/step]
6-317-004	Not Fold Exit Speed	Thick: Large-Size	ENG	[0 to 4 / 1 / 1/step]
6-317-005	Not Fold Exit Speed	Thick: Middle-Size	ENG	[0 to 4 / 1 / 1/step]
6-317-006	Not Fold Exit Speed	Thick: Small-Size	ENG	[0 to 4 / 0 / 1/step]
6-317-007	Not Fold Exit Speed	Thin: Large-Size	ENG	[0 to 4 / 1 / 1/step]
6-317-008	Not Fold Exit Speed	Thin: Middle-Size	ENG	[0 to 4 / 0 / 1/step]

3.SP Mode Tables

SP No.	Large Category	Small Category	ENG or CTL	[Min to Max/Init./Step]
6-317-009	Not Fold Exit Speed	Thin: Small-Size	ENG	[0 to 4 / 0 / 1/step]
6-317-010	Not Fold Exit Speed	Plain: Long-Size	ENG	[0 to 4 / 1 / 1/step]
6-317-011	Not Fold Exit Speed	Thick: Long-Size	ENG	[0 to 4 / 2 / 1/step]
6-317-012	Not Fold Exit Speed	Thin: Long-Size	ENG	[0 to 4 / 3 / 1/step]
6-318-001	Z-Fold Exit Speed	Plain: Large-Size	ENG	[0 to 4 / 2 / 1/step]
6-318-002	Z-Fold Exit Speed	Plain: Middle-Size	ENG	[0 to 4 / 2 / 1/step]
6-318-003	Z-Fold Exit Speed	Plain: Small-Size	ENG	[0 to 4 / 2 / 1/step]
6-319-001	Equal 1/2 Exit Speed	Plain: Large-Size	ENG	[0 to 4 / 2 / 1/step]
6-319-002	Equal 1/2 Exit Speed	Plain: Middle-Size	ENG	[0 to 4 / 2 / 1/step]
6-319-003	Equal 1/2 Exit Speed	Plain: Small-Size	ENG	[0 to 4 / 2 / 1/step]
6-320-001	Equal 3rds Exit Speed	Plain: Large-Size	ENG	[0 to 4 / 2 / 1/step]
6-320-002	Equal 3rds Exit Speed	Plain: Middle-Size	ENG	[0 to 4 / 2 / 1/step]

3.SP Mode Tables

SP No.	Large Category	Small Category	ENG or CTL	[Min to Max/Init./Step]
6-320-003	Equal 3rds Exit Speed	Plain: Small-Size	ENG	[0 to 4 / 2 / 1/step]
6-321-001	3rds 1 Flap Exit Fold	Plain: Large-Size	ENG	[0 to 4 / 2 / 1/step]
6-321-002	3rds 1 Flap Exit Fold	Plain: Middle-Size	ENG	[0 to 4 / 2 / 1/step]
6-321-003	3rds 1 Flap Exit Fold	Plain: Small-Size	ENG	[0 to 4 / 2 / 1/step]
6-324-001	NV Adj. Data Mod.	1st Fold Pos. Factory Setting	ENG	[-3.0 to 3.0 / 0.0 / 0.1mm/step]
6-324-002	NV Adj. Data Mod.	2nd Fold Pos. Factory Setting	ENG	[-3.0 to 3.0 / 0.0 / 0.1mm/step]
6-324-003	NV Adj. Data Mod.	Crease Pos. Factory Setting	ENG	[-3.0 to 3.0 / 0.0 / 0.1mm/step]
6-325-001	Folder. Free Run	Free Run1(Not Fold)	ENG	[0 to 1 / 0 / 1/step]
6-325-002	Folder. Free Run	Free Run2(Z-Fold)	ENG	[0 to 1 / 0 / 1/step]
6-325-003	Folder. Free Run	Free Run3(Equal 1/2)	ENG	[0 to 1 / 0 / 1/step]
6-325-004	Folder. Free Run	Free Run4(Equal 3rds)	ENG	[0 to 1 / 0 / 1/step]
6-325-005	Folder. Free Run	Free Run5(3rds 1 Flap)	ENG	[0 to 1 / 0 / 1/step]

3.SP Mode Tables

SP No.	Large Category	Small Category	ENG or CTL	[Min to Max/Init./Step]
6-326-001	Z-Fold Full Detact Adjust	Large Size	ENG	[-1.0 to 1.0 / 0.0 / 0.2v/step]
6-326-002	Z-Fold Full Detact Adjust	Middle Size	ENG	[-1.0 to 1.0 / 0.0 / 0.2v/step]
6-326-003	Z-Fold Full Detact Adjust	Small Size	ENG	[-1.0 to 1.0 / 0.0 / 0.2v/step]
6-327-001	Equal 1/2 Full Detact Adjust	Large Size	ENG	[-1.0 to 1.0 / 0.0 / 0.2v/step]
6-327-002	Equal 1/2 Full Detact Adjust	Middle Size	ENG	[-1.0 to 1.0 / 0.0 / 0.2v/step]
6-327-003	Equal 1/2 Full Detact Adjust	Small Size	ENG	[-1.0 to 1.0 / 0.0 / 0.2v/step]
6-795-001	Staple N.E. Setting 1KShtFIN	Near-End Threshold	ENG	[0 to 5000 / 500 / 100staples/step]
6-795-002	Staple N.E. Setting 1KShtFIN	Staple Remaining Setting	ENG	[0 to 5000 / 0 / 1staples/step]
6-795-003	Staple N.E. Setting 1KShtFIN	Anomaly Near-End Disp. Clear Setting	ENG	[0 to 1 / 0 / 1/step]
6-796-001	Staple N.E. Setting:2K/3K FIN	Near-End Threshold(CrnStplr)	ENG	[0 to 5000 / 800 / 100staples/step]
6-796-002	Staple N.E. Setting:2K/3K FIN	Staple Remaining Setting(CrnStplr)	ENG	[0 to 5000 / 0 / 1staples/step]
6-796-003	Staple N.E. Setting:2K/3K FIN	Near-End Threshold(BookStplr Front)	ENG	[0 to 2000 / 300 / 100staples/step]

3.SP Mode Tables

SP No.	Large Category	Small Category	ENG or CTL	[Min to Max/Init./Step]
6-796-004	Staple N.E. Setting:2K/3K FIN	Staple Remaining Setting(BookStplr Front)	ENG	[0 to 2000 / 0 / 1staples/step]
6-796-005	Staple N.E. Setting:2K/3K FIN	Near-End Threshold(BookStplr Rear)	ENG	[0 to 2000 / 300 / 100staples/step]
6-796-006	Staple N.E. Setting:2K/3K FIN	Staple Remaining Setting(BookStplr Rear)	ENG	[0 to 2000 / 0 / 1staples/step]
6-796-007	Staple N.E. Setting:2K/3K FIN	Anomaly Near-End Disp. Clear Setting	ENG	[0 to 1 / 0 / 1/step]
6-799-010	MachineSerial Display	ADF	ENG	[0 to 255 / 0 / 1/step]
6-799-020	MachineSerial Display	Bank	ENG	[0 to 255 / 0 / 1/step]
6-799-030	MachineSerial Display	LCT	ENG	[0 to 255 / 0 / 1/step]
6-799-040	MachineSerial Display	Finisher	ENG	[0 to 255 / 0 / 1/step]
6-799-050	MachineSerial Display	Folder	ENG	[0 to 255 / 0 / 1/step]
6-801-001	1-pass Stamp Unit		ENG*	[0 to 1 / 0 / 1/step]
6-900-001	ADF Bottom Plate Setting		ENG*	[0 to 1 / 0 / 1/step]
6-901-001	ADF Operation Setting		ENG	[0 to 1 / 0 / 1/step]

3.SP Mode Tables

SP No.	Large Category	Small Category	ENG or CTL	[Min to Max/Init./Step]
6-901-002	ADF Operation Setting	Stack Mode	ENG	[0 to 1 / 0 / 1/step]

Engine SP Tables-7

SP7-XXX (Data Log)

SP No.	Large Category	Small Category	ENG or CTL	[Min to Max/Init./Step]
7-621-002	PM Counter Display: Pages	# PCU:K	ENG	[0 to 99999999 / 0 / 1page/step]
7-621-003	PM Counter Display: Pages	# Dev Unit:K	ENG*	[0 to 99999999 / 0 / 1page/step]
7-621-004	PM Counter Display: Pages	Developer:K	ENG	[0 to 99999999 / 0 / 1page/step]
7-621-025	PM Counter Display: Pages	# PCU:C	ENG	[0 to 99999999 / 0 / 1page/step]
7-621-026	PM Counter Display: Pages	# Dev Unit:C	ENG*	[0 to 99999999 / 0 / 1page/step]
7-621-027	PM Counter Display: Pages	Developer:C	ENG	[0 to 99999999 / 0 / 1page/step]
7-621-048	PM Counter Display: Pages	# PCU:M	ENG	[0 to 99999999 / 0 / 1page/step]
7-621-049	PM Counter Display: Pages	# Dev Unit:M	ENG*	[0 to 99999999 / 0 / 1page/step]
7-	PM Counter Display: Pages	Developer:M	ENG	[0 to 99999999 / 0 /

3.SP Mode Tables

SP No.	Large Category	Small Category	ENG or CTL	[Min to Max/Init./Step]
621-050				1page/step]
7-621-071	PM Counter Display: Pages	# PCU:Y	ENG	[0 to 99999999 / 0 / 1page/step]
7-621-072	PM Counter Display: Pages	# Dev Unit:Y	ENG*	[0 to 99999999 / 0 / 1page/step]
7-621-073	PM Counter Display: Pages	Developer:Y	ENG	[0 to 99999999 / 0 / 1page/step]
7-621-093	PM Counter Display: Pages	# ITB Unit	ENG	[0 to 99999999 / 0 / 1page/step]
7-621-102	PM Counter Display: Pages	# ITB Cleaning Unit	ENG	[0 to 99999999 / 0 / 1page/step]
7-621-109	PM Counter Display: Pages	# PTR Unit	ENG	[0 to 99999999 / 0 / 1page/step]
7-621-115	PM Counter Display: Pages	# Fusing Unit	ENG	[0 to 99999999 / 0 / 1page/step]
7-621-116	PM Counter Display: Pages	Fusing Belt	ENG	[0 to 99999999 / 0 / 1page/step]
7-621-118	PM Counter Display: Pages	Pressure Roller	ENG	[0 to 99999999 / 0 / 1page/step]
7-621-131	PM Counter Display: Pages	Dust Filter	ENG	[0 to 99999999 / 0 / 1page/step]
7-621-142	PM Counter Display: Pages	Waste Toner Bottle	ENG	[0 to 999999999 / 0 / 1mg/step]
7-	PM Counter Display: Pages	ADF Pick-up Roller	ENG	[0 to 99999999 / 0 /

3.SP Mode Tables

SP No.	Large Category	Small Category	ENG or CTL	[Min to Max/Init./Step]
621-206				1page/step]
7-621-207	PM Counter Display: Pages	ADF Supply Belt	ENG	[0 to 99999999 / 0 / 1page/step]
7-621-208	PM Counter Display: Pages	ADF Reverse Roller	ENG	[0 to 99999999 / 0 / 1page/step]
7-622-002	PM Counter Reset	# PCU:K	ENG	[0 to 1 / 0 / 1/step]
7-622-003	PM Counter Reset	# Dev Unit:K	ENG	[0 to 1 / 0 / 1/step]
7-622-004	PM Counter Reset	Developer:K	ENG	[0 to 1 / 0 / 1/step]
7-622-025	PM Counter Reset	# PCU:C	ENG	[0 to 1 / 0 / 1/step]
7-622-026	PM Counter Reset	# Dev Unit:C	ENG	[0 to 1 / 0 / 1/step]
7-622-027	PM Counter Reset	Developer:C	ENG	[0 to 1 / 0 / 1/step]
7-622-048	PM Counter Reset	# PCU:M	ENG	[0 to 1 / 0 / 1/step]
7-622-049	PM Counter Reset	# Dev Unit:M	ENG	[0 to 1 / 0 / 1/step]
7-622-050	PM Counter Reset	Developer:M	ENG	[0 to 1 / 0 / 1/step]
7-	PM Counter Reset	# PCU:Y	ENG	[0 to 1 / 0 / 1/step]

3.SP Mode Tables

SP No.	Large Category	Small Category	ENG or CTL	[Min to Max/Init./Step]
622-071				
7-622-072	PM Counter Reset	# Dev Unit:Y	ENG	[0 to 1 / 0 / 1/step]
7-622-073	PM Counter Reset	Developer:Y	ENG	[0 to 1 / 0 / 1/step]
7-622-093	PM Counter Reset	# ITB Unit	ENG	[0 to 1 / 0 / 1/step]
7-622-102	PM Counter Reset	# ITB Cleaning Unit	ENG	[0 to 1 / 0 / 1/step]
7-622-109	PM Counter Reset	# PTR Unit	ENG	[0 to 1 / 0 / 1/step]
7-622-115	PM Counter Reset	# Fusing Unit	ENG	[0 to 1 / 0 / 1/step]
7-622-116	PM Counter Reset	Fusing Belt	ENG	[0 to 1 / 0 / 1/step]
7-622-118	PM Counter Reset	Pressure Roller	ENG	[0 to 1 / 0 / 1/step]
7-622-131	PM Counter Reset	Dust Filter	ENG	[0 to 1 / 0 / 1/step]
7-622-206	PM Counter Reset	ADF Pick-up Roller	ENG	[0 to 1 / 0 / 1/step]
7-622-207	PM Counter Reset	ADF Supply Belt	ENG	[0 to 1 / 0 / 1/step]
7-	PM Counter Reset	ADF Reverse Roller	ENG	[0 to 1 / 0 / 1/step]

3.SP Mode Tables

SP No.	Large Category	Small Category	ENG or CTL	[Min to Max/Init./Step]
622-208				
7-622-245	PM Counter Reset	PCU:All Colors	ENG	[0 to 1 / 0 / 1/step]
7-622-246	PM Counter Reset	Development Unit:All Colors	ENG	[0 to 1 / 0 / 1/step]
7-622-247	PM Counter Reset	Developer:All Colors	ENG	[0 to 1 / 0 / 1/step]
7-622-250	PM Counter Reset	SCS	ENG	[0 to 1 / 0 / 1/step]
7-623-002	PM Value Setting: Life Pages	# PCU:K	ENG	[0 to 99999999 / 0 / 1page/step]
7-623-003	PM Value Setting: Life Pages	# Dev Unit:K	ENG	[0 to 99999999 / 0 / 1page/step]
7-623-004	PM Value Setting: Life Pages	Developer:K	ENG	[0 to 99999999 / 0 / 1page/step]
7-623-025	PM Value Setting: Life Pages	# PCU:C	ENG	[0 to 99999999 / 0 / 1page/step]
7-623-026	PM Value Setting: Life Pages	# Dev Unit:C	ENG	[0 to 99999999 / 0 / 1page/step]
7-623-027	PM Value Setting: Life Pages	Developer:C	ENG	[0 to 99999999 / 0 / 1page/step]
7-623-048	PM Value Setting: Life Pages	# PCU:M	ENG	[0 to 99999999 / 0 / 1page/step]
7-	PM Value Setting: Life Pages	# Dev Unit:M	ENG	[0 to 99999999 / 0 /

3.SP Mode Tables

SP No.	Large Category	Small Category	ENG or CTL	[Min to Max/Init./Step]
623-049				1page/step]
7-623-050	PM Value Setting: Life Pages	Developer:M	ENG	[0 to 99999999 / 0 / 1page/step]
7-623-071	PM Value Setting: Life Pages	# PCU:Y	ENG	[0 to 99999999 / 0 / 1page/step]
7-623-072	PM Value Setting: Life Pages	# Dev Unit:Y	ENG	[0 to 99999999 / 0 / 1page/step]
7-623-073	PM Value Setting: Life Pages	Developer:Y	ENG	[0 to 99999999 / 0 / 1page/step]
7-623-093	PM Value Setting: Life Pages	# ITB Unit	ENG	[0 to 99999999 / 600000 / 1page/step]
7-623-102	PM Value Setting: Life Pages	# ITB Cleaning Unit	ENG	[0 to 99999999 / 600000 / 1page/step]
7-623-109	PM Value Setting: Life Pages	# PTR Unit	ENG	[0 to 99999999 / 900000 / 1page/step]
7-623-115	PM Value Setting: Life Pages	# Fusing Unit	ENG	[0 to 99999999 / 400000 / 1page/step]
7-623-116	PM Value Setting: Life Pages	Fusing Belt	ENG	[0 to 99999999 / 400000 / 1page/step]
7-623-118	PM Value Setting: Life Pages	Pressure Roller	ENG	[0 to 99999999 / 400000 / 1page/step]
7-623-131	PM Value Setting: Life Pages	Dust Filter	ENG	[0 to 99999999 / 400000 / 1page/step]
7-	PM Value Setting: Life Pages	Waste Toner Bottle	ENG	[0 to 999999999 /

3.SP Mode Tables

SP No.	Large Category	Small Category	ENG or CTL	[Min to Max/Init./Step]
623-142				1200000 / 1mg/step]
7-623-206	PM Value Setting: Life Pages	ADF Pick-up Roller	ENG	[0 to 99999999 / 120000 / 1page/step]
7-623-207	PM Value Setting: Life Pages	ADF Supply Belt	ENG	[0 to 99999999 / 120000 / 1page/step]
7-623-208	PM Value Setting: Life Pages	ADF Reverse Roller	ENG	[0 to 99999999 / 120000 / 1page/step]
7-625-002	Previous Unit Counter: Pages	# PCU:K	ENG	[0 to 99999999 / 0 / 1page/step]
7-625-003	Previous Unit Counter: Pages	# Dev Unit:K	ENG	[0 to 99999999 / 0 / 1page/step]
7-625-004	Previous Unit Counter: Pages	Developer:K	ENG	[0 to 99999999 / 0 / 1page/step]
7-625-025	Previous Unit Counter: Pages	# PCU:C	ENG	[0 to 99999999 / 0 / 1page/step]
7-625-026	Previous Unit Counter: Pages	# Dev Unit:C	ENG	[0 to 99999999 / 0 / 1page/step]
7-625-027	Previous Unit Counter: Pages	Developer:C	ENG	[0 to 99999999 / 0 / 1page/step]
7-625-048	Previous Unit Counter: Pages	# PCU:M	ENG	[0 to 99999999 / 0 / 1page/step]
7-625-049	Previous Unit Counter: Pages	# Dev Unit:M	ENG	[0 to 99999999 / 0 / 1page/step]
7-	Previous Unit Counter: Pages	Developer:M	ENG	[0 to 99999999 / 0 /

3.SP Mode Tables

SP No.	Large Category	Small Category	ENG or CTL	[Min to Max/Init./Step]
625-050				1page/step]
7-625-071	Previous Unit Counter: Pages	# PCU:Y	ENG	[0 to 99999999 / 0 / 1page/step]
7-625-072	Previous Unit Counter: Pages	# Dev Unit:Y	ENG	[0 to 99999999 / 0 / 1page/step]
7-625-073	Previous Unit Counter: Pages	Developer:Y	ENG	[0 to 99999999 / 0 / 1page/step]
7-625-093	Previous Unit Counter: Pages	# ITB Unit	ENG	[0 to 99999999 / 0 / 1page/step]
7-625-102	Previous Unit Counter: Pages	# ITB Cleaning Unit	ENG	[0 to 99999999 / 0 / 1page/step]
7-625-109	Previous Unit Counter: Pages	# PTR Unit	ENG	[0 to 99999999 / 0 / 1page/step]
7-625-115	Previous Unit Counter: Pages	# Fusing Unit	ENG	[0 to 99999999 / 0 / 1page/step]
7-625-116	Previous Unit Counter: Pages	Fusing Belt	ENG	[0 to 99999999 / 0 / 1page/step]
7-625-118	Previous Unit Counter: Pages	Pressure Roller	ENG	[0 to 99999999 / 0 / 1page/step]
7-625-131	Previous Unit Counter: Pages	Dust Filter	ENG	[0 to 99999999 / 0 / 1page/step]
7-625-142	Previous Unit Counter: Pages	Waste Toner Bottle	ENG	[0 to 999999999 / 0 / 1mg/step]
7-	Previous Unit Counter: Pages	ADF Pick-up Roller	ENG	[0 to 99999999 / 0 /

3.SP Mode Tables

SP No.	Large Category	Small Category	ENG or CTL	[Min to Max/Init./Step]
625-206				1page/step]
7-625-207	Previous Unit Counter: Pages	ADF Supply Belt	ENG	[0 to 99999999 / 0 / 1page/step]
7-625-208	Previous Unit Counter: Pages	ADF Reverse Roller	ENG	[0 to 99999999 / 0 / 1page/step]
7-626-002	Previous Unit Counter2: Pages	# PCU:K	ENG	[0 to 99999999 / 0 / 1page/step]
7-626-003	Previous Unit Counter2: Pages	# Dev Unit:K	ENG	[0 to 99999999 / 0 / 1page/step]
7-626-004	Previous Unit Counter2: Pages	Developer:K	ENG	[0 to 99999999 / 0 / 1page/step]
7-626-025	Previous Unit Counter2: Pages	# PCU:C	ENG	[0 to 99999999 / 0 / 1page/step]
7-626-026	Previous Unit Counter2: Pages	# Dev Unit:C	ENG	[0 to 99999999 / 0 / 1page/step]
7-626-027	Previous Unit Counter2: Pages	Developer:C	ENG	[0 to 99999999 / 0 / 1page/step]
7-626-048	Previous Unit Counter2: Pages	# PCU:M	ENG	[0 to 99999999 / 0 / 1page/step]
7-626-049	Previous Unit Counter2: Pages	# Dev Unit:M	ENG	[0 to 99999999 / 0 / 1page/step]
7-626-050	Previous Unit Counter2: Pages	Developer:M	ENG	[0 to 99999999 / 0 / 1page/step]
7-	Previous Unit Counter2: Pages	# PCU:Y	ENG	[0 to 99999999 / 0 /

3.SP Mode Tables

SP No.	Large Category	Small Category	ENG or CTL	[Min to Max/Init./Step]
626-071				1page/step]
7-626-072	Previous Unit Counter2: Pages	# Dev Unit:Y	ENG	[0 to 99999999 / 0 / 1page/step]
7-626-073	Previous Unit Counter2: Pages	Developer:Y	ENG	[0 to 99999999 / 0 / 1page/step]
7-626-093	Previous Unit Counter2: Pages	# ITB Unit	ENG	[0 to 99999999 / 0 / 1page/step]
7-626-102	Previous Unit Counter2: Pages	# ITB Cleaning Unit	ENG	[0 to 99999999 / 0 / 1page/step]
7-626-109	Previous Unit Counter2: Pages	# PTR Unit	ENG	[0 to 99999999 / 0 / 1page/step]
7-626-115	Previous Unit Counter2: Pages	# Fusing Unit	ENG	[0 to 99999999 / 0 / 1page/step]
7-626-116	Previous Unit Counter2: Pages	Fusing Belt	ENG	[0 to 99999999 / 0 / 1page/step]
7-626-118	Previous Unit Counter2: Pages	Pressure Roller	ENG	[0 to 99999999 / 0 / 1page/step]
7-626-131	Previous Unit Counter2: Pages	Dust Filter	ENG	[0 to 99999999 / 0 / 1page/step]
7-626-142	Previous Unit Counter2: Pages	Waste Toner Bottle	ENG	[0 to 999999999 / 0 / 1mg/step]
7-626-206	Previous Unit Counter2: Pages	ADF Pick-up Roller	ENG	[0 to 99999999 / 0 / 1page/step]
7-	Previous Unit Counter2: Pages	ADF Supply Belt	ENG	[0 to 99999999 / 0 /

3.SP Mode Tables

SP No.	Large Category	Small Category	ENG or CTL	[Min to Max/Init./Step]
626-207				1page/step]
7-626-208	Previous Unit Counter2: Pages	ADF Reverse Roller	ENG	[0 to 99999999 / 0 / 1page/step]
7-628-002	PM Counter Reset	SCS	ENG	[0 to 1 / 0 / 1/step]
7-720-001	Ave. Cvrq for Eng.	K	ENG*	[0.00 to 100.00 / 0.00 / 0.01%/step]
7-720-002	Ave. Cvrq for Eng.	C	ENG*	[0.00 to 100.00 / 0.00 / 0.01%/step]
7-720-003	Ave. Cvrq for Eng.	M	ENG*	[0.00 to 100.00 / 0.00 / 0.01%/step]
7-720-004	Ave. Cvrq for Eng.	Y	ENG*	[0.00 to 100.00 / 0.00 / 0.01%/step]
7-801-002	ROM No.	Engine	ENG	[0 to 0 / 0 / 0/step]
7-801-005	ROM No.	ADF	ENG	[0 to 0 / 0 / 0/step]
7-801-007	ROM No.	Finisher	ENG	[0 to 0 / 0 / 0/step]
7-801-009	ROM No.	PTU	ENG	[0 to 0 / 0 / 0/step]
7-801-010	ROM No.	LCT	ENG	[0 to 0 / 0 / 0/step]
7-	ROM No.	Folder	ENG	[0 to 0 / 0 / 0/step]

3.SP Mode Tables

SP No.	Large Category	Small Category	ENG or CTL	[Min to Max/Init./Step]
801-025				
7-801-102	Firmware Version	Engine	ENG	[0 to 0 / 0 / 0/step]
7-801-105	Firmware Version	ADF	ENG	[0 to 0 / 0 / 0/step]
7-801-107	Firmware Version	Finisher	ENG	[0 to 0 / 0 / 0/step]
7-801-109	Firmware Version	PTU	ENG	[0 to 0 / 0 / 0/step]
7-801-110	Firmware Version	LCT	ENG	[0 to 0 / 0 / 0/step]
7-801-125	Firmware Version	Folder	ENG	[0 to 0 / 0 / 0/step]
7-853-002	Replace Counter	# PCU:K	ENG	[0 to 255 / 0 / 1/step]
7-853-003	Replace Counter	# Dev Unit:K	ENG	[0 to 255 / 0 / 1/step]
7-853-004	Replace Counter	Developer:K	ENG	[0 to 255 / 0 / 1/step]
7-853-025	Replace Counter	# PCU:C	ENG	[0 to 255 / 0 / 1/step]
7-853-026	Replace Counter	# Dev Unit:C	ENG	[0 to 255 / 0 / 1/step]
7-	Replace Counter	Developer:C	ENG	[0 to 255 / 0 / 1/step]

3.SP Mode Tables

SP No.	Large Category	Small Category	ENG or CTL	[Min to Max/Init./Step]
853-027				
7-853-048	Replace Counter	# PCU:M	ENG	[0 to 255 / 0 / 1/step]
7-853-049	Replace Counter	# Dev Unit:M	ENG	[0 to 255 / 0 / 1/step]
7-853-050	Replace Counter	Developer:M	ENG	[0 to 255 / 0 / 1/step]
7-853-071	Replace Counter	# PCU:Y	ENG	[0 to 255 / 0 / 1/step]
7-853-072	Replace Counter	# Dev Unit:Y	ENG	[0 to 255 / 0 / 1/step]
7-853-073	Replace Counter	Developer:Y	ENG	[0 to 255 / 0 / 1/step]
7-853-093	Replace Counter	# ITB Unit	ENG	[0 to 255 / 0 / 1/step]
7-853-102	Replace Counter	# ITB Cleaning Unit	ENG	[0 to 255 / 0 / 1/step]
7-853-109	Replace Counter	# PTR Unit	ENG	[0 to 255 / 0 / 1/step]
7-853-115	Replace Counter	# Fusing Unit	ENG	[0 to 255 / 0 / 1/step]
7-853-116	Replace Counter	Fusing Belt	ENG	[0 to 255 / 0 / 1/step]
7-	Replace Counter	Pressure Roller	ENG	[0 to 255 / 0 / 1/step]

3.SP Mode Tables

SP No.	Large Category	Small Category	ENG or CTL	[Min to Max/Init./Step]
853-118				
7-853-131	Replace Counter	Dust Filter	ENG	[0 to 255 / 0 / 1/step]
7-853-142	Replace Counter	Waste Toner Bottle	ENG	[0 to 255 / 0 / 1/step]
7-853-206	Replace Counter	ADF Pick-up Roller	ENG	[0 to 255 / 0 / 1/step]
7-853-207	Replace Counter	ADF Supply Belt	ENG	[0 to 255 / 0 / 1/step]
7-853-208	Replace Counter	ADF Reverse Roller	ENG	[0 to 255 / 0 / 1/step]
7-860-001	Paper Edge	Paper Width Division 1	ENG	[0 to 4294967295 / 0 / 1mm/step]
7-860-002	Paper Edge	Paper Width Division 2	ENG	[0 to 4294967295 / 0 / 1mm/step]
7-860-003	Paper Edge	Paper Width Division 3	ENG	[0 to 4294967295 / 0 / 1mm/step]
7-860-004	Paper Edge	Paper Width Division 4	ENG	[0 to 4294967295 / 0 / 1mm/step]
7-860-005	Paper Edge	Paper Width Division 5	ENG	[0 to 4294967295 / 0 / 1mm/step]
7-860-006	Paper Edge	Paper Width Division 6	ENG	[0 to 4294967295 / 0 / 1mm/step]
7-	Paper Edge	Paper Width Division 7	ENG	[0 to 4294967295 / 0 /

3.SP Mode Tables

SP No.	Large Category	Small Category	ENG or CTL	[Min to Max/Init./Step]
860-007				1mm/step]
7-860-008	Paper Edge	Paper Width Division 8	ENG	[0 to 4294967295 / 0 / 1mm/step]
7-860-009	Paper Edge	Paper Width Division 9	ENG	[0 to 4294967295 / 0 / 1mm/step]
7-860-010	Paper Edge	Paper Width Division 10	ENG	[0 to 4294967295 / 0 / 1mm/step]
7-860-011	Paper Edge	Paper Width Division 11	ENG	[0 to 4294967295 / 0 / 1mm/step]
7-860-012	Paper Edge	Paper Width Division 12	ENG	[0 to 4294967295 / 0 / 1mm/step]
7-861-001	JAM record : include paper	Fuser Unit	ENG	[0 to 65535 / 0 / 1/step]
7-906-002	Previous Unit Counter:Distance	# PCU:K	ENG	[0 to 4294967295 / 0 / 1mm/step]
7-906-003	Previous Unit Counter:Distance	# Dev Unit:K	ENG	[0 to 4294967295 / 0 / 1mm/step]
7-906-004	Previous Unit Counter:Distance	Developer:K	ENG	[0 to 4294967295 / 0 / 1mm/step]
7-906-025	Previous Unit Counter:Distance	# PCU:C	ENG	[0 to 4294967295 / 0 / 1mm/step]
7-906-026	Previous Unit Counter:Distance	# Dev Unit:C	ENG	[0 to 4294967295 / 0 / 1mm/step]
7-	Previous Unit	Developer: C	ENG	[0 to 4294967295 / 0 /

3.SP Mode Tables

SP No.	Large Category	Small Category	ENG or CTL	[Min to Max/Init./Step]
906-027	Counter:Distance			1mm/step]
7-906-048	Previous Unit Counter:Distance	# PCU:M	ENG	[0 to 4294967295 / 0 / 1mm/step]
7-906-049	Previous Unit Counter:Distance	# Dev Unit:M	ENG	[0 to 4294967295 / 0 / 1mm/step]
7-906-050	Previous Unit Counter:Distance	Developer: M	ENG	[0 to 4294967295 / 0 / 1mm/step]
7-906-071	Previous Unit Counter:Distance	# PCU:Y	ENG	[0 to 4294967295 / 0 / 1mm/step]
7-906-072	Previous Unit Counter:Distance	# Dev Unit:Y	ENG	[0 to 4294967295 / 0 / 1mm/step]
7-906-073	Previous Unit Counter:Distance	Developer: Y	ENG	[0 to 4294967295 / 0 / 1mm/step]
7-906-093	Previous Unit Counter:Distance	# ITB Unit	ENG	[0 to 4294967295 / 0 / 1mm/step]
7-906-102	Previous Unit Counter:Distance	# ITB Cleaning Unit	ENG	[0 to 4294967295 / 0 / 1mm/step]
7-906-109	Previous Unit Counter:Distance	# PTR Unit	ENG	[0 to 4294967295 / 0 / 1mm/step]
7-906-115	Previous Unit Counter:Distance	# Fusing Unit	ENG	[0 to 4294967295 / 0 / 1mm/step]
7-906-116	Previous Unit Counter:Distance	Fusing Belt	ENG	[0 to 4294967295 / 0 / 1mm/step]
7-	Previous Unit	Pressure Roller	ENG	[0 to 4294967295 / 0 /

3.SP Mode Tables

SP No.	Large Category	Small Category	ENG or CTL	[Min to Max/Init./Step]
906-118	Counter:Distance			1mm/step]
7-906-230	Previous Unit Counter:Distance	Low Speed: # PCU:K	ENG	[0 to 4294967295 / 0 / 1mm/step]
7-906-231	Previous Unit Counter:Distance	Low Speed: # PCU:C	ENG	[0 to 4294967295 / 0 / 1mm/step]
7-906-232	Previous Unit Counter:Distance	Low Speed: # PCU:M	ENG	[0 to 4294967295 / 0 / 1mm/step]
7-906-233	Previous Unit Counter:Distance	Low Speed: # PCU:Y	ENG	[0 to 4294967295 / 0 / 1mm/step]
7-906-234	Previous Unit Counter:Distance	Middle Speed: # PCU:K	ENG	[0 to 4294967295 / 0 / 1mm/step]
7-906-235	Previous Unit Counter:Distance	Middle Speed: # PCU:C	ENG	[0 to 4294967295 / 0 / 1mm/step]
7-906-236	Previous Unit Counter:Distance	Middle Speed: # PCU:M	ENG	[0 to 4294967295 / 0 / 1mm/step]
7-906-237	Previous Unit Counter:Distance	Middle Speed: # PCU:Y	ENG	[0 to 4294967295 / 0 / 1mm/step]
7-907-002	Previous Unit Cntr:Distance(%)	# PCU:K	ENG	[0 to 255 / 0 / 1%/step]
7-907-003	Previous Unit Cntr:Distance(%)	# Dev Unit:K	ENG	[0 to 255 / 0 / 1%/step]
7-907-004	Previous Unit Cntr:Distance(%)	Developer:K	ENG	[0 to 255 / 0 / 1%/step]
7-	Previous Unit Cntr:Distance(%)	# PCU:C	ENG	[0 to 255 / 0 / 1%/step]

3.SP Mode Tables

SP No.	Large Category	Small Category	ENG or CTL	[Min to Max/Init./Step]
907-025				
7-907-026	Previous Unit Cntr:Distance(%)	# Dev Unit:C	ENG	[0 to 255 / 0 / 1%/step]
7-907-027	Previous Unit Cntr:Distance(%)	Developer:C	ENG	[0 to 255 / 0 / 1%/step]
7-907-048	Previous Unit Cntr:Distance(%)	# PCU:M	ENG	[0 to 255 / 0 / 1%/step]
7-907-049	Previous Unit Cntr:Distance(%)	# Dev Unit:M	ENG	[0 to 255 / 0 / 1%/step]
7-907-050	Previous Unit Cntr:Distance(%)	Developer:M	ENG	[0 to 255 / 0 / 1%/step]
7-907-071	Previous Unit Cntr:Distance(%)	# PCU:Y	ENG	[0 to 255 / 0 / 1%/step]
7-907-072	Previous Unit Cntr:Distance(%)	# Dev Unit:Y	ENG	[0 to 255 / 0 / 1%/step]
7-907-073	Previous Unit Cntr:Distance(%)	Developer:Y	ENG	[0 to 255 / 0 / 1%/step]
7-907-093	Previous Unit Cntr:Distance(%)	# ITB Unit	ENG	[0 to 255 / 0 / 1%/step]
7-907-102	Previous Unit Cntr:Distance(%)	# ITB Cleaning Unit	ENG	[0 to 255 / 0 / 1%/step]
7-907-109	Previous Unit Cntr:Distance(%)	# PTR Unit	ENG	[0 to 255 / 0 / 1%/step]
7-	Previous Unit Cntr:Distance(%)	# Fusing Unit	ENG	[0 to 255 / 0 / 1%/step]

3.SP Mode Tables

SP No.	Large Category	Small Category	ENG or CTL	[Min to Max/Init./Step]
907-115				
7-907-116	Previous Unit Cntr:Distance(%)	Fusing Belt	ENG	[0 to 255 / 0 / 1%/step]
7-907-118	Previous Unit Cntr:Distance(%)	Pressure Roller	ENG	[0 to 255 / 0 / 1%/step]
7-908-002	Previous Unit Counter:Pages(%)	# PCU:K	ENG	[0 to 255 / 0 / 1%/step]
7-908-003	Previous Unit Counter:Pages(%)	# Dev Unit:K	ENG	[0 to 255 / 0 / 1%/step]
7-908-004	Previous Unit Counter:Pages(%)	Developer:K	ENG	[0 to 255 / 0 / 1%/step]
7-908-025	Previous Unit Counter:Pages(%)	# PCU:C	ENG	[0 to 255 / 0 / 1%/step]
7-908-026	Previous Unit Counter:Pages(%)	# Dev Unit:C	ENG	[0 to 255 / 0 / 1%/step]
7-908-027	Previous Unit Counter:Pages(%)	Developer:C	ENG	[0 to 255 / 0 / 1%/step]
7-908-048	Previous Unit Counter:Pages(%)	# PCU:M	ENG	[0 to 255 / 0 / 1%/step]
7-908-049	Previous Unit Counter:Pages(%)	# Dev Unit:M	ENG	[0 to 255 / 0 / 1%/step]
7-908-050	Previous Unit Counter:Pages(%)	Developer:M	ENG	[0 to 255 / 0 / 1%/step]
7-	Previous Unit	# PCU:Y	ENG	[0 to 255 / 0 / 1%/step]

3.SP Mode Tables

SP No.	Large Category	Small Category	ENG or CTL	[Min to Max/Init./Step]
908-071	Counter:Pages(%)			
7-908-072	Previous Unit Counter:Pages(%)	# Dev Unit:Y	ENG	[0 to 255 / 0 / 1%/step]
7-908-073	Previous Unit Counter:Pages(%)	Developer:Y	ENG	[0 to 255 / 0 / 1%/step]
7-908-093	Previous Unit Counter:Pages(%)	# ITB Unit	ENG	[0 to 255 / 0 / 1%/step]
7-908-102	Previous Unit Counter:Pages(%)	# ITB Cleaning Unit	ENG	[0 to 255 / 0 / 1%/step]
7-908-109	Previous Unit Counter:Pages(%)	# PTR Unit	ENG	[0 to 255 / 0 / 1%/step]
7-908-115	Previous Unit Counter:Pages(%)	# Fusing Unit	ENG	[0 to 255 / 0 / 1%/step]
7-908-116	Previous Unit Counter:Pages(%)	Fusing Belt	ENG	[0 to 255 / 0 / 1%/step]
7-908-118	Previous Unit Counter:Pages(%)	Pressure Roller	ENG	[0 to 255 / 0 / 1%/step]
7-908-131	Previous Unit Counter:Pages(%)	Dust Filter	ENG	[0 to 255 / 0 / 1%/step]
7-908-142	Previous Unit Counter:Pages(%)	Waste Toner Bottle	ENG	[0 to 255 / 0 / 1%/step]
7-908-206	Previous Unit Counter:Pages(%)	ADF Pick-up Roller	ENG	[0 to 255 / 0 / 1%/step]
7-	Previous Unit	ADF Supply Belt	ENG	[0 to 255 / 0 / 1%/step]

3.SP Mode Tables

SP No.	Large Category	Small Category	ENG or CTL	[Min to Max/Init./Step]
908-207	Counter:Pages(%)			
7-908-208	Previous Unit Counter:Pages(%)	ADF Reverse Roller	ENG	[0 to 255 / 0 / 1%/step]
7-931-001	Toner Bottle Bk	Machine Serial ID	ENG*	[0 to 255 / 0 / 1/step]
7-931-002	Toner Bottle Bk	Cartridge Ver	ENG*	[0 to 255 / 0 / 1/step]
7-931-003	Toner Bottle Bk	Brand ID	ENG*	[0 to 255 / 0 / 1/step]
7-931-004	Toner Bottle Bk	Area ID	ENG*	[0 to 255 / 0 / 1/step]
7-931-005	Toner Bottle Bk	Product ID	ENG*	[0 to 255 / 0 / 1/step]
7-931-006	Toner Bottle Bk	Color ID	ENG*	[0 to 255 / 0 / 1/step]
7-931-007	Toner Bottle Bk	Maintenance ID	ENG*	[0 to 255 / 0 / 1/step]
7-931-008	Toner Bottle Bk	New Product Information	ENG*	[0 to 255 / 0 / 1/step]
7-931-009	Toner Bottle Bk	Recycle Counter	ENG*	[0 to 255 / 0 / 1/step]
7-931-010	Toner Bottle Bk	Date	ENG*	[0 to 1 / 0 / 1/step]
7-	Toner Bottle Bk	SerialNo.	ENG*	[0 to 1 / 0 / 1/step]

3.SP Mode Tables

SP No.	Large Category	Small Category	ENG or CTL	[Min to Max/Init./Step]
931-011				
7-931-012	Toner Bottle Bk	Toner Remaining	ENG*	[0 to 100 / 100 / 1%/step]
7-931-013	Toner Bottle Bk	EDP Code	ENG*	[0 to 1 / 0 / 1/step]
7-931-014	Toner Bottle Bk	End History	ENG*	[0 to 1 / 0 / 1/step]
7-931-015	Toner Bottle Bk	Refill Information	ENG*	[0 to 1 / 0 / 1/step]
7-931-016	Toner Bottle Bk	Attachment: Total Counter	ENG*	[0 to 99999999 / 0 / 1/step]
7-931-017	Toner Bottle Bk	Attachment: Color Counter	ENG*	[0 to 99999999 / 0 / 1/step]
7-931-018	Toner Bottle Bk	End: Total Counter	ENG*	[0 to 99999999 / 0 / 1/step]
7-931-019	Toner Bottle Bk	End: Color Counter	ENG*	[0 to 99999999 / 0 / 1/step]
7-931-020	Toner Bottle Bk	Attachment Date	ENG*	[0 to 1 / 0 / 1/step]
7-931-021	Toner Bottle Bk	End Date	ENG*	[0 to 1 / 0 / 1/step]
7-932-001	Toner Bottle M	Machine Serial ID	ENG*	[0 to 255 / 0 / 1/step]
7-	Toner Bottle M	Cartridge Ver	ENG*	[0 to 255 / 0 / 1/step]

3.SP Mode Tables

SP No.	Large Category	Small Category	ENG or CTL	[Min to Max/Init./Step]
932-002				
7-932-003	Toner Bottle M	Brand ID	ENG*	[0 to 255 / 0 / 1/step]
7-932-004	Toner Bottle M	Area ID	ENG*	[0 to 255 / 0 / 1/step]
7-932-005	Toner Bottle M	Product ID	ENG*	[0 to 255 / 0 / 1/step]
7-932-006	Toner Bottle M	Color ID	ENG*	[0 to 255 / 0 / 1/step]
7-932-007	Toner Bottle M	Maintenance ID	ENG*	[0 to 255 / 0 / 1/step]
7-932-008	Toner Bottle M	New Product Information	ENG*	[0 to 255 / 0 / 1/step]
7-932-009	Toner Bottle M	Recycle Counter	ENG*	[0 to 255 / 0 / 1/step]
7-932-010	Toner Bottle M	Date	ENG*	[0 to 1 / 0 / 1/step]
7-932-011	Toner Bottle M	SerialNo.	ENG*	[0 to 1 / 0 / 1/step]
7-932-012	Toner Bottle M	Toner Remaining	ENG*	[0 to 100 / 100 / 1%/step]
7-932-013	Toner Bottle M	EDP Code	ENG*	[0 to 1 / 0 / 1/step]
7-	Toner Bottle M	End History	ENG*	[0 to 1 / 0 / 1/step]

3.SP Mode Tables

SP No.	Large Category	Small Category	ENG or CTL	[Min to Max/Init./Step]
932-014				
7-932-015	Toner Bottle M	Refill Information	ENG*	[0 to 1 / 0 / 1/step]
7-932-016	Toner Bottle M	Attachment: Total Counter	ENG*	[0 to 99999999 / 0 / 1/step]
7-932-017	Toner Bottle M	Attachment: Color Counter	ENG*	[0 to 99999999 / 0 / 1/step]
7-932-018	Toner Bottle M	End: Total Counter	ENG*	[0 to 99999999 / 0 / 1/step]
7-932-019	Toner Bottle M	End: Color Counter	ENG*	[0 to 99999999 / 0 / 1/step]
7-932-020	Toner Bottle M	Attachment Date	ENG*	[0 to 1 / 0 / 1/step]
7-932-021	Toner Bottle M	End Date	ENG*	[0 to 1 / 0 / 1/step]
7-933-001	Toner Bottle C	MachineSerialID	ENG*	[0 to 255 / 0 / 1/step]
7-933-002	Toner Bottle C	Cartridge Ver	ENG*	[0 to 255 / 0 / 1/step]
7-933-003	Toner Bottle C	Brand ID	ENG*	[0 to 255 / 0 / 1/step]
7-933-004	Toner Bottle C	Area ID	ENG*	[0 to 255 / 0 / 1/step]
7-	Toner Bottle C	Product ID	ENG*	[0 to 255 / 0 / 1/step]

3.SP Mode Tables

SP No.	Large Category	Small Category	ENG or CTL	[Min to Max/Init./Step]
933-005				
7-933-006	Toner Bottle C	Color ID	ENG*	[0 to 255 / 0 / 1/step]
7-933-007	Toner Bottle C	Maintenance ID	ENG*	[0 to 255 / 0 / 1/step]
7-933-008	Toner Bottle C	New Product Information	ENG*	[0 to 255 / 0 / 1/step]
7-933-009	Toner Bottle C	Recycle Counter	ENG*	[0 to 255 / 0 / 1/step]
7-933-010	Toner Bottle C	Date	ENG*	[0 to 1 / 0 / 1/step]
7-933-011	Toner Bottle C	SerialNo.	ENG*	[0 to 1 / 0 / 1/step]
7-933-012	Toner Bottle C	Toner Remaining	ENG*	[0 to 100 / 100 / 1%/step]
7-933-013	Toner Bottle C	EDP Code	ENG*	[0 to 1 / 0 / 1/step]
7-933-014	Toner Bottle C	End History	ENG*	[0 to 1 / 0 / 1/step]
7-933-015	Toner Bottle C	Refill Information	ENG*	[0 to 1 / 0 / 1/step]
7-933-016	Toner Bottle C	Attachment: Total Counter	ENG*	[0 to 99999999 / 0 / 1/step]
7-	Toner Bottle C	Attachment: Color	ENG*	[0 to 99999999 / 0 /

3.SP Mode Tables

SP No.	Large Category	Small Category	ENG or CTL	[Min to Max/Init./Step]
933-017		Counter		1/step]
7-933-018	Toner Bottle C	End: Total Counter	ENG*	[0 to 99999999 / 0 / 1/step]
7-933-019	Toner Bottle C	End: Color Counter	ENG*	[0 to 99999999 / 0 / 1/step]
7-933-020	Toner Bottle C	Attachment Date	ENG*	[0 to 1 / 0 / 1/step]
7-933-021	Toner Bottle C	End Date	ENG*	[0 to 1 / 0 / 1/step]
7-934-001	Toner Bottle Y	MachineSerialID	ENG*	[0 to 255 / 0 / 1/step]
7-934-002	Toner Bottle Y	Cartridge Ver	ENG*	[0 to 255 / 0 / 1/step]
7-934-003	Toner Bottle Y	Brand ID	ENG*	[0 to 255 / 0 / 1/step]
7-934-004	Toner Bottle Y	Area ID	ENG*	[0 to 255 / 0 / 1/step]
7-934-005	Toner Bottle Y	Product ID	ENG*	[0 to 255 / 0 / 1/step]
7-934-006	Toner Bottle Y	Color ID	ENG*	[0 to 255 / 0 / 1/step]
7-934-007	Toner Bottle Y	Maintenance ID	ENG*	[0 to 255 / 0 / 1/step]
7-	Toner Bottle Y	New Product Information	ENG*	[0 to 255 / 0 / 1/step]

3.SP Mode Tables

SP No.	Large Category	Small Category	ENG or CTL	[Min to Max/Init./Step]
934-008				
7-934-009	Toner Bottle Y	Recycle Counter	ENG*	[0 to 255 / 0 / 1/step]
7-934-010	Toner Bottle Y	Date	ENG*	[0 to 1 / 0 / 1/step]
7-934-011	Toner Bottle Y	SerialNo.	ENG*	[0 to 1 / 0 / 1/step]
7-934-012	Toner Bottle Y	Toner Remaining	ENG*	[0 to 100 / 100 / 1%/step]
7-934-013	Toner Bottle Y	EDP Code	ENG*	[0 to 1 / 0 / 1/step]
7-934-014	Toner Bottle Y	End History	ENG*	[0 to 1 / 0 / 1/step]
7-934-015	Toner Bottle Y	Refill Information	ENG*	[0 to 1 / 0 / 1/step]
7-934-016	Toner Bottle Y	Attachment: Total Counter	ENG*	[0 to 99999999 / 0 / 1/step]
7-934-017	Toner Bottle Y	Attachment: Color Counter	ENG*	[0 to 99999999 / 0 / 1/step]
7-934-018	Toner Bottle Y	End: Total Counter	ENG*	[0 to 99999999 / 0 / 1/step]
7-934-019	Toner Bottle Y	End: Color Counter	ENG*	[0 to 99999999 / 0 / 1/step]
7-	Toner Bottle Y	Attachment Date	ENG*	[0 to 1 / 0 / 1/step]

3.SP Mode Tables

SP No.	Large Category	Small Category	ENG or CTL	[Min to Max/Init./Step]
934-020				
7-934-021	Toner Bottle Y	End Date	ENG*	[0 to 1 / 0 / 1/step]
7-935-001	Toner Bottle Log 1: Bk	SerialNo.	ENG	[0 to 1 / 0 / 1/step]
7-935-002	Toner Bottle Log 1: Bk	Attachment Date	ENG	[0 to 1 / 0 / 1/step]
7-935-003	Toner Bottle Log 1: Bk	Attachment: Total Counter	ENG	[0 to 99999999 / 0 / 1/step]
7-935-004	Toner Bottle Log 1: Bk	Refill Information	ENG*	[0 to 1 / 0 / 1/step]
7-935-011	Toner Bottle Log 2: Bk	SerialNo.	ENG	[0 to 1 / 0 / 1/step]
7-935-012	Toner Bottle Log 2: Bk	Attachment Date	ENG	[0 to 1 / 0 / 1/step]
7-935-013	Toner Bottle Log 2: Bk	Attachment: Total Counter	ENG	[0 to 99999999 / 0 / 1/step]
7-935-014	Toner Bottle Log 2: Bk	Refill Information	ENG*	[0 to 1 / 0 / 1/step]
7-935-021	Toner Bottle Log 3: Bk	SerialNo.	ENG	[0 to 1 / 0 / 1/step]
7-935-022	Toner Bottle Log 3: Bk	Attachment Date	ENG	[0 to 1 / 0 / 1/step]
7-	Toner Bottle Log 3: Bk	Attachment: Total	ENG	[0 to 99999999 / 0 /

3.SP Mode Tables

SP No.	Large Category	Small Category	ENG or CTL	[Min to Max/Init./Step]
935-023		Counter		1/step]
7-935-024	Toner Bottle Log 3: Bk	Refill Information	ENG*	[0 to 1 / 0 / 1/step]
7-935-031	Toner Bottle Log 4: Bk	SerialNo.	ENG	[0 to 1 / 0 / 1/step]
7-935-032	Toner Bottle Log 4: Bk	Attachment Date	ENG	[0 to 1 / 0 / 1/step]
7-935-033	Toner Bottle Log 4: Bk	Attachment: Total Counter	ENG	[0 to 99999999 / 0 / 1/step]
7-935-034	Toner Bottle Log 4: Bk	Refill Information	ENG*	[0 to 1 / 0 / 1/step]
7-935-041	Toner Bottle Log 5: Bk	SerialNo.	ENG	[0 to 1 / 0 / 1/step]
7-935-042	Toner Bottle Log 5: Bk	Attachment Date	ENG	[0 to 1 / 0 / 1/step]
7-935-043	Toner Bottle Log 5: Bk	Attachment: Total Counter	ENG	[0 to 99999999 / 0 / 1/step]
7-935-044	Toner Bottle Log 5: Bk	Refill Information	ENG*	[0 to 1 / 0 / 1/step]
7-936-001	Toner Bottle Log 1: M	SerialNo.	ENG	[0 to 1 / 0 / 1/step]
7-936-002	Toner Bottle Log 1: M	Attachment Date	ENG	[0 to 1 / 0 / 1/step]
7-	Toner Bottle Log 1: M	Attachment: Total	ENG	[0 to 99999999 / 0 /

3.SP Mode Tables

SP No.	Large Category	Small Category	ENG or CTL	[Min to Max/Init./Step]
936-003		Counter		1/step]
7-936-004	Toner Bottle Log 1: M	Refill Information	ENG*	[0 to 1 / 0 / 1/step]
7-936-011	Toner Bottle Log 2: M	SerialNo.	ENG	[0 to 1 / 0 / 1/step]
7-936-012	Toner Bottle Log 2: M	Attachment Date	ENG	[0 to 1 / 0 / 1/step]
7-936-013	Toner Bottle Log 2: M	Attachment: Total Counter	ENG	[0 to 99999999 / 0 / 1/step]
7-936-014	Toner Bottle Log 2: M	Refill Information	ENG*	[0 to 1 / 0 / 1/step]
7-936-021	Toner Bottle Log 3: M	SerialNo.	ENG	[0 to 1 / 0 / 1/step]
7-936-022	Toner Bottle Log 3: M	Attachment Date	ENG	[0 to 1 / 0 / 1/step]
7-936-023	Toner Bottle Log 3: M	Attachment: Total Counter	ENG	[0 to 99999999 / 0 / 1/step]
7-936-024	Toner Bottle Log 3: M	Refill Information	ENG*	[0 to 1 / 0 / 1/step]
7-936-031	Toner Bottle Log 4: M	SerialNo.	ENG	[0 to 1 / 0 / 1/step]
7-936-032	Toner Bottle Log 4: M	Attachment Date	ENG	[0 to 1 / 0 / 1/step]
7-	Toner Bottle Log 4: M	Attachment: Total	ENG	[0 to 99999999 / 0 /

3.SP Mode Tables

SP No.	Large Category	Small Category	ENG or CTL	[Min to Max/Init./Step]
936-033		Counter		1/step]
7-936-034	Toner Bottle Log 4: M	Refill Information	ENG*	[0 to 1 / 0 / 1/step]
7-936-041	Toner Bottle Log 5: M	SerialNo.	ENG	[0 to 1 / 0 / 1/step]
7-936-042	Toner Bottle Log 5: M	Attachment Date	ENG	[0 to 1 / 0 / 1/step]
7-936-043	Toner Bottle Log 5: M	Attachment: Total Counter	ENG	[0 to 99999999 / 0 / 1/step]
7-936-044	Toner Bottle Log 5: M	Refill Information	ENG*	[0 to 1 / 0 / 1/step]
7-937-001	Toner Bottle Log 1: C	SerialNo.	ENG	[0 to 1 / 0 / 1/step]
7-937-002	Toner Bottle Log 1: C	Attachment Date	ENG	[0 to 1 / 0 / 1/step]
7-937-003	Toner Bottle Log 1: C	Attachment: Total Counter	ENG	[0 to 99999999 / 0 / 1/step]
7-937-004	Toner Bottle Log 1: C	Refill Information	ENG*	[0 to 1 / 0 / 1/step]
7-937-011	Toner Bottle Log 2: C	SerialNo.	ENG	[0 to 1 / 0 / 1/step]
7-937-012	Toner Bottle Log 2: C	Attachment Date	ENG	[0 to 1 / 0 / 1/step]
7-	Toner Bottle Log 2: C	Attachment: Total	ENG	[0 to 99999999 / 0 /

3.SP Mode Tables

SP No.	Large Category	Small Category	ENG or CTL	[Min to Max/Init./Step]
937-013		Counter		1/step]
7-937-014	Toner Bottle Log 2: C	Refill Information	ENG*	[0 to 1 / 0 / 1/step]
7-937-021	Toner Bottle Log 3: C	SerialNo.	ENG	[0 to 1 / 0 / 1/step]
7-937-022	Toner Bottle Log 3: C	Attachment Date	ENG	[0 to 1 / 0 / 1/step]
7-937-023	Toner Bottle Log 3: C	Attachment: Total Counter	ENG	[0 to 99999999 / 0 / 1/step]
7-937-024	Toner Bottle Log 3: C	Refill Information	ENG*	[0 to 1 / 0 / 1/step]
7-937-031	Toner Bottle Log 4: C	SerialNo.	ENG	[0 to 1 / 0 / 1/step]
7-937-032	Toner Bottle Log 4: C	Attachment Date	ENG	[0 to 1 / 0 / 1/step]
7-937-033	Toner Bottle Log 4: C	Attachment: Total Counter	ENG	[0 to 99999999 / 0 / 1/step]
7-937-034	Toner Bottle Log 4: C	Refill Information	ENG*	[0 to 1 / 0 / 1/step]
7-937-041	Toner Bottle Log 5: C	SerialNo.	ENG	[0 to 1 / 0 / 1/step]
7-937-042	Toner Bottle Log 5: C	Attachment Date	ENG	[0 to 1 / 0 / 1/step]
7-	Toner Bottle Log 5: C	Attachment: Total	ENG	[0 to 99999999 / 0 /

3.SP Mode Tables

SP No.	Large Category	Small Category	ENG or CTL	[Min to Max/Init./Step]
937-043		Counter		1/step]
7-937-044	Toner Bottle Log 5: C	Refill Information	ENG*	[0 to 1 / 0 / 1/step]
7-938-001	Toner Bottle Log 1: Y	SerialNo.	ENG	[0 to 1 / 0 / 1/step]
7-938-002	Toner Bottle Log 1: Y	Attachment Date	ENG	[0 to 1 / 0 / 1/step]
7-938-003	Toner Bottle Log 1: Y	Attachment: Total Counter	ENG	[0 to 99999999 / 0 / 1/step]
7-938-004	Toner Bottle Log 1: Y	Refill Information	ENG*	[0 to 1 / 0 / 1/step]
7-938-011	Toner Bottle Log 2: Y	SerialNo.	ENG	[0 to 1 / 0 / 1/step]
7-938-012	Toner Bottle Log 2: Y	Attachment Date	ENG	[0 to 1 / 0 / 1/step]
7-938-013	Toner Bottle Log 2: Y	Attachment: Total Counter	ENG	[0 to 99999999 / 0 / 1/step]
7-938-014	Toner Bottle Log 2: Y	Refill Information	ENG*	[0 to 1 / 0 / 1/step]
7-938-021	Toner Bottle Log 3: Y	SerialNo.	ENG	[0 to 1 / 0 / 1/step]
7-938-022	Toner Bottle Log 3: Y	Attachment Date	ENG	[0 to 1 / 0 / 1/step]
7-	Toner Bottle Log 3: Y	Attachment: Total	ENG	[0 to 99999999 / 0 /

3.SP Mode Tables

SP No.	Large Category	Small Category	ENG or CTL	[Min to Max/Init./Step]
938-023		Counter		1/step]
7-938-024	Toner Bottle Log 3: Y	Refill Information	ENG*	[0 to 1 / 0 / 1/step]
7-938-031	Toner Bottle Log 4: Y	SerialNo.	ENG	[0 to 1 / 0 / 1/step]
7-938-032	Toner Bottle Log 4: Y	Attachment Date	ENG	[0 to 1 / 0 / 1/step]
7-938-033	Toner Bottle Log 4: Y	Attachment: Total Counter	ENG	[0 to 99999999 / 0 / 1/step]
7-938-034	Toner Bottle Log 4: Y	Refill Information	ENG*	[0 to 1 / 0 / 1/step]
7-938-041	Toner Bottle Log 5: Y	SerialNo.	ENG	[0 to 1 / 0 / 1/step]
7-938-042	Toner Bottle Log 5: Y	Attachment Date	ENG	[0 to 1 / 0 / 1/step]
7-938-043	Toner Bottle Log 5: Y	Attachment: Total Counter	ENG	[0 to 99999999 / 0 / 1/step]
7-938-044	Toner Bottle Log 5: Y	Refill Information	ENG*	[0 to 1 / 0 / 1/step]
7-940-002	PM Value Setting:Life Distance	# PCU:K	ENG	[0 to 999999999 / 0 / 1mm/step]
7-940-003	PM Value Setting:Life Distance	# Dev Unit:K	ENG	[0 to 999999999 / 0 / 1mm/step]
7-	PM Value Setting:Life Distance	Developer:K	ENG	[0 to 999999999 / 0 /

3.SP Mode Tables

SP No.	Large Category	Small Category	ENG or CTL	[Min to Max/Init./Step]
940-004				1mm/step]
7-940-025	PM Value Setting:Life Distance	# PCU:C	ENG	[0 to 999999999 / 0 / 1mm/step]
7-940-026	PM Value Setting:Life Distance	# Dev Unit:C	ENG	[0 to 999999999 / 0 / 1mm/step]
7-940-027	PM Value Setting:Life Distance	Developer:C	ENG	[0 to 999999999 / 0 / 1mm/step]
7-940-048	PM Value Setting:Life Distance	# PCU:M	ENG	[0 to 999999999 / 0 / 1mm/step]
7-940-049	PM Value Setting:Life Distance	# Dev Unit:M	ENG	[0 to 999999999 / 0 / 1mm/step]
7-940-050	PM Value Setting:Life Distance	Developer:M	ENG	[0 to 999999999 / 0 / 1mm/step]
7-940-071	PM Value Setting:Life Distance	# PCU:Y	ENG	[0 to 999999999 / 0 / 1mm/step]
7-940-072	PM Value Setting:Life Distance	# Dev Unit:Y	ENG	[0 to 999999999 / 0 / 1mm/step]
7-940-073	PM Value Setting:Life Distance	Developer:Y	ENG	[0 to 999999999 / 0 / 1mm/step]
7-940-093	PM Value Setting:Life Distance	# ITB Unit	ENG	[0 to 999999999 / 267545565 / 1mm/step]
7-940-102	PM Value Setting:Life Distance	# ITB Cleaning Unit	ENG	[0 to 999999999 / 267545566 / 1mm/step]
7-	PM Value Setting:Life Distance	# PTR Unit	ENG	[0 to 999999999 /

3.SP Mode Tables

SP No.	Large Category	Small Category	ENG or CTL	[Min to Max/Init./Step]
940-109				401318348 / 1mm/step]
7-940-115	PM Value Setting:Life Distance	# Fusing Unit	ENG	[0 to 999999999 / 291305000 / 1mm/step]
7-940-116	PM Value Setting:Life Distance	Fusing Belt	ENG	[0 to 999999999 / 291305000 / 1mm/step]
7-940-118	PM Value Setting:Life Distance	Pressure Roller	ENG	[0 to 999999999 / 291305000 / 1mm/step]
7-942-002	PM Counter Display:Distance(%)	# PCU:K	ENG	[0 to 255 / 0 / 1%/step]
7-942-003	PM Counter Display:Distance(%)	# Dev Unit:K	ENG	[0 to 255 / 0 / 1%/step]
7-942-004	PM Counter Display:Distance(%)	Developer:K	ENG	[0 to 255 / 0 / 1%/step]
7-942-025	PM Counter Display:Distance(%)	# PCU:C	ENG	[0 to 255 / 0 / 1%/step]
7-942-026	PM Counter Display:Distance(%)	# Dev Unit:C	ENG	[0 to 255 / 0 / 1%/step]
7-942-027	PM Counter Display:Distance(%)	Developer:C	ENG	[0 to 255 / 0 / 1%/step]
7-942-048	PM Counter Display:Distance(%)	# PCU:M	ENG	[0 to 255 / 0 / 1%/step]
7-942-049	PM Counter Display:Distance(%)	# Dev Unit:M	ENG	[0 to 255 / 0 / 1%/step]
7-	PM Counter	Developer:M	ENG	[0 to 255 / 0 / 1%/step]

3.SP Mode Tables

SP No.	Large Category	Small Category	ENG or CTL	[Min to Max/Init./Step]
942-050	Display:Distance(%)			
7-942-071	PM Counter Display:Distance(%)	# PCU:Y	ENG	[0 to 255 / 0 / 1%/step]
7-942-072	PM Counter Display:Distance(%)	# Dev Unit:Y	ENG	[0 to 255 / 0 / 1%/step]
7-942-073	PM Counter Display:Distance(%)	Developer:Y	ENG	[0 to 255 / 0 / 1%/step]
7-942-093	PM Counter Display:Distance(%)	# ITB Unit	ENG	[0 to 255 / 0 / 1%/step]
7-942-102	PM Counter Display:Distance(%)	# ITB Cleaning Unit	ENG	[0 to 255 / 0 / 1%/step]
7-942-109	PM Counter Display:Distance(%)	# PTR Unit	ENG	[0 to 255 / 0 / 1%/step]
7-942-115	PM Counter Display:Distance(%)	# Fusing Unit	ENG	[0 to 255 / 0 / 1%/step]
7-942-116	PM Counter Display:Distance(%)	Fusing Belt	ENG	[0 to 255 / 0 / 1%/step]
7-942-118	PM Counter Display:Distance(%)	Pressure Roller	ENG	[0 to 255 / 0 / 1%/step]
7-944-002	PM Counter Display: Distance	# PCU:K	ENG*	[0 to 4294967295 / 0 / 1mm/step]
7-944-003	PM Counter Display: Distance	# Dev Unit:K	ENG*	[0 to 4294967295 / 0 / 1mm/step]
7-	PM Counter Display: Distance	Developer:K	ENG*	[0 to 4294967295 / 0 /

3.SP Mode Tables

SP No.	Large Category	Small Category	ENG or CTL	[Min to Max/Init./Step]
944-004				1mm/step]
7-944-025	PM Counter Display: Distance	# PCU:C	ENG*	[0 to 4294967295 / 0 / 1mm/step]
7-944-026	PM Counter Display: Distance	# Dev Unit:C	ENG*	[0 to 4294967295 / 0 / 1mm/step]
7-944-027	PM Counter Display: Distance	Developer:C	ENG*	[0 to 4294967295 / 0 / 1mm/step]
7-944-048	PM Counter Display: Distance	# PCU:M	ENG*	[0 to 4294967295 / 0 / 1mm/step]
7-944-049	PM Counter Display: Distance	# Dev Unit:M	ENG*	[0 to 4294967295 / 0 / 1mm/step]
7-944-050	PM Counter Display: Distance	Developer:M	ENG*	[0 to 4294967295 / 0 / 1mm/step]
7-944-071	PM Counter Display: Distance	# PCU:Y	ENG*	[0 to 4294967295 / 0 / 1mm/step]
7-944-072	PM Counter Display: Distance	# Dev Unit:Y	ENG*	[0 to 4294967295 / 0 / 1mm/step]
7-944-073	PM Counter Display: Distance	Developer:Y	ENG*	[0 to 4294967295 / 0 / 1mm/step]
7-944-093	PM Counter Display: Distance	# ITB Unit	ENG*	[0 to 4294967295 / 0 / 1mm/step]
7-944-102	PM Counter Display: Distance	# ITB Cleaning Unit	ENG	[0 to 4294967295 / 0 / 1mm/step]
7-	PM Counter Display: Distance	# PTR Unit	ENG	[0 to 4294967295 / 0 /

3.SP Mode Tables

SP No.	Large Category	Small Category	ENG or CTL	[Min to Max/Init./Step]
944-109				1mm/step]
7-944-115	PM Counter Display: Distance	# Fusing Unit	ENG	[0 to 4294967295 / 0 / 1mm/step]
7-944-116	PM Counter Display: Distance	Fusing Belt	ENG	[0 to 4294967295 / 0 / 1mm/step]
7-944-118	PM Counter Display: Distance	Pressure Roller	ENG	[0 to 4294967295 / 0 / 1mm/step]
7-944-230	PM Counter Display: Distance	Low Speed: # PCU:K	ENG	[0 to 4294967295 / 0 / 1mm/step]
7-944-231	PM Counter Display: Distance	Low Speed: # PCU:C	ENG	[0 to 4294967295 / 0 / 1mm/step]
7-944-232	PM Counter Display: Distance	Low Speed: # PCU:M	ENG	[0 to 4294967295 / 0 / 1mm/step]
7-944-233	PM Counter Display: Distance	Low Speed: # PCU:Y	ENG	[0 to 4294967295 / 0 / 1mm/step]
7-944-234	PM Counter Display: Distance	Middle Speed: # PCU:K	ENG	[0 to 4294967295 / 0 / 1mm/step]
7-944-235	PM Counter Display: Distance	Middle Speed: # PCU:C	ENG	[0 to 4294967295 / 0 / 1mm/step]
7-944-236	PM Counter Display: Distance	Middle Speed: # PCU:M	ENG	[0 to 4294967295 / 0 / 1mm/step]
7-944-237	PM Counter Display: Distance	Middle Speed: # PCU:Y	ENG	[0 to 4294967295 / 0 / 1mm/step]
7-	Unit Replacement Date	# PCU:K	ENG*	[0 to 1 / 0 / 1/step]

3.SP Mode Tables

SP No.	Large Category	Small Category	ENG or CTL	[Min to Max/Init./Step]
950-002				
7-950-003	Unit Replacement Date	# Dev Unit:K	ENG*	[0 to 1 / 0 / 1/step]
7-950-004	Unit Replacement Date	Developer:K	ENG*	[0 to 1 / 0 / 1/step]
7-950-025	Unit Replacement Date	# PCU:C	ENG*	[0 to 1 / 0 / 1/step]
7-950-026	Unit Replacement Date	# Dev Unit:C	ENG*	[0 to 1 / 0 / 1/step]
7-950-027	Unit Replacement Date	Developer:C	ENG*	[0 to 1 / 0 / 1/step]
7-950-048	Unit Replacement Date	# PCU:M	ENG*	[0 to 1 / 0 / 1/step]
7-950-049	Unit Replacement Date	# Dev Unit:M	ENG*	[0 to 1 / 0 / 1/step]
7-950-050	Unit Replacement Date	Developer:M	ENG*	[0 to 1 / 0 / 1/step]
7-950-071	Unit Replacement Date	# PCU:Y	ENG*	[0 to 1 / 0 / 1/step]
7-950-072	Unit Replacement Date	# Dev Unit:Y	ENG*	[0 to 1 / 0 / 1/step]
7-950-073	Unit Replacement Date	Developer:Y	ENG*	[0 to 1 / 0 / 1/step]
7-	Unit Replacement Date	# ITB Unit	ENG*	[0 to 1 / 0 / 1/step]

3.SP Mode Tables

SP No.	Large Category	Small Category	ENG or CTL	[Min to Max/Init./Step]
950-093				
7-950-102	Unit Replacement Date	# ITB Cleaning Unit	ENG*	[0 to 1 / 0 / 1/step]
7-950-109	Unit Replacement Date	# PTR Unit	ENG*	[0 to 1 / 0 / 1/step]
7-950-115	Unit Replacement Date	# Fusing Unit	ENG*	[0 to 1 / 0 / 1/step]
7-950-116	Unit Replacement Date	Fusing Belt	ENG*	[0 to 1 / 0 / 1/step]
7-950-118	Unit Replacement Date	Pressure Roller	ENG*	[0 to 1 / 0 / 1/step]
7-950-131	Unit Replacement Date	Dust Filter	ENG*	[0 to 1 / 0 / 1/step]
7-950-142	Unit Replacement Date	Waste Toner Bottle	ENG*	[0 to 1 / 0 / 1/step]
7-950-206	Unit Replacement Date	ADF Pick-up Roller	ENG*	[0 to 1 / 0 / 1/step]
7-950-207	Unit Replacement Date	ADF Supply Belt	ENG*	[0 to 1 / 0 / 1/step]
7-950-208	Unit Replacement Date	ADF Reverse Roller	ENG*	[0 to 1 / 0 / 1/step]
7-951-002	Remain Day Counter: Pages	# PCU:K	ENG	[0 to 255 / 255 / 1days/step]
7-	Remain Day Counter: Pages	# Dev Unit:K	ENG	[0 to 255 / 255 /

3.SP Mode Tables

SP No.	Large Category	Small Category	ENG or CTL	[Min to Max/Init./Step]
951-003				1days/step]
7-951-004	Remain Day Counter: Pages	Developer:K	ENG	[0 to 255 / 255 / 1days/step]
7-951-025	Remain Day Counter: Pages	# PCU:C	ENG	[0 to 255 / 255 / 1days/step]
7-951-026	Remain Day Counter: Pages	# Dev Unit:C	ENG	[0 to 255 / 255 / 1days/step]
7-951-027	Remain Day Counter: Pages	Developer:C	ENG	[0 to 255 / 255 / 1days/step]
7-951-048	Remain Day Counter: Pages	# PCU:M	ENG	[0 to 255 / 255 / 1days/step]
7-951-049	Remain Day Counter: Pages	# Dev Unit:M	ENG	[0 to 255 / 255 / 1days/step]
7-951-050	Remain Day Counter: Pages	Developer:M	ENG	[0 to 255 / 255 / 1days/step]
7-951-071	Remain Day Counter: Pages	# PCU:Y	ENG	[0 to 255 / 255 / 1days/step]
7-951-072	Remain Day Counter: Pages	# Dev Unit:Y	ENG	[0 to 255 / 255 / 1days/step]
7-951-073	Remain Day Counter: Pages	Developer:Y	ENG	[0 to 255 / 255 / 1days/step]
7-951-093	Remain Day Counter: Pages	# ITB Unit	ENG	[0 to 255 / 255 / 1days/step]
7-	Remain Day Counter: Pages	# ITB Cleaning Unit	ENG	[0 to 255 / 255 /

3.SP Mode Tables

SP No.	Large Category	Small Category	ENG or CTL	[Min to Max/Init./Step]
951-102				1days/step]
7-951-109	Remain Day Counter: Pages	# PTR Unit	ENG	[0 to 255 / 255 / 1days/step]
7-951-115	Remain Day Counter: Pages	# Fusing Unit	ENG	[0 to 255 / 255 / 1days/step]
7-951-116	Remain Day Counter: Pages	Fusing Belt	ENG	[0 to 255 / 255 / 1days/step]
7-951-118	Remain Day Counter: Pages	Pressure Roller	ENG	[0 to 255 / 255 / 1days/step]
7-951-131	Remain Day Counter: Pages	Dust Filter	ENG	[0 to 255 / 255 / 1days/step]
7-951-142	Remain Day Counter: Pages	Waste Toner Bottle	ENG	[0 to 255 / 255 / 1days/step]
7-951-206	Remain Day Counter: Pages	ADF Pick-up Roller	ENG	[0 to 255 / 255 / 1days/step]
7-951-207	Remain Day Counter: Pages	ADF Supply Belt	ENG	[0 to 255 / 255 / 1days/step]
7-951-208	Remain Day Counter: Pages	ADF Reverse Roller	ENG	[0 to 255 / 255 / 1days/step]
7-952-002	Remain Day Counter: Distance	# PCU:K	ENG	[0 to 255 / 255 / 1days/step]
7-952-003	Remain Day Counter: Distance	# Dev Unit:K	ENG	[0 to 255 / 255 / 1days/step]
7-	Remain Day Counter: Distance	Developer:K	ENG	[0 to 255 / 255 /

3.SP Mode Tables

SP No.	Large Category	Small Category	ENG or CTL	[Min to Max/Init./Step]
952-004				1days/step]
7-952-025	Remain Day Counter: Distance	# PCU:C	ENG	[0 to 255 / 255 / 1days/step]
7-952-026	Remain Day Counter: Distance	# Dev Unit:C	ENG	[0 to 255 / 255 / 1days/step]
7-952-027	Remain Day Counter: Distance	Developer:C	ENG	[0 to 255 / 255 / 1days/step]
7-952-048	Remain Day Counter: Distance	# PCU:M	ENG	[0 to 255 / 255 / 1days/step]
7-952-049	Remain Day Counter: Distance	# Dev Unit:M	ENG	[0 to 255 / 255 / 1days/step]
7-952-050	Remain Day Counter: Distance	Developer:M	ENG	[0 to 255 / 255 / 1days/step]
7-952-071	Remain Day Counter: Distance	# PCU:Y	ENG	[0 to 255 / 255 / 1days/step]
7-952-072	Remain Day Counter: Distance	# Dev Unit:Y	ENG	[0 to 255 / 255 / 1days/step]
7-952-073	Remain Day Counter: Distance	Developer:Y	ENG	[0 to 255 / 255 / 1days/step]
7-952-093	Remain Day Counter: Distance	# ITB Unit	ENG	[0 to 255 / 255 / 1days/step]
7-952-102	Remain Day Counter: Distance	# ITB Cleaning Unit	ENG	[0 to 255 / 255 / 1days/step]
7-	Remain Day Counter: Distance	# PTR Unit	ENG	[0 to 255 / 255 /

3.SP Mode Tables

SP No.	Large Category	Small Category	ENG or CTL	[Min to Max/Init./Step]
952-109				1days/step]
7-952-115	Remain Day Counter: Distance	# Fusing Unit	ENG	[0 to 255 / 255 / 1days/step]
7-952-116	Remain Day Counter: Distance	Fusing Belt	ENG	[0 to 255 / 255 / 1days/step]
7-952-118	Remain Day Counter: Distance	Pressure Roller	ENG	[0 to 255 / 255 / 1days/step]
7-953-001	Operation Env. Log: PCU: K	T<=0	ENG	[0 to 999999999 / 0 / 1mm/step]
7-953-002	Operation Env. Log: PCU: K	0<T<=5:0<=H<30	ENG	[0 to 999999999 / 0 / 1mm/step]
7-953-003	Operation Env. Log: PCU: K	0<T<=5:30<=H<70	ENG	[0 to 999999999 / 0 / 1mm/step]
7-953-004	Operation Env. Log: PCU: K	0<T<=5:70<=H<=100	ENG	[0 to 999999999 / 0 / 1mm/step]
7-953-005	Operation Env. Log: PCU: K	5<T<15:0<=H<30	ENG	[0 to 999999999 / 0 / 1mm/step]
7-953-006	Operation Env. Log: PCU: K	5<T<15:30<=H<55	ENG	[0 to 999999999 / 0 / 1mm/step]
7-953-007	Operation Env. Log: PCU: K	5<T<15:55<=H<80	ENG	[0 to 999999999 / 0 / 1mm/step]
7-953-008	Operation Env. Log: PCU: K	5<T<15:80<=H<=100	ENG	[0 to 999999999 / 0 / 1mm/step]
7-	Operation Env. Log: PCU: K	15<=T<25:0<=H<30	ENG	[0 to 999999999 / 0 /

3.SP Mode Tables

SP No.	Large Category	Small Category	ENG or CTL	[Min to Max/Init./Step]
953-009				1mm/step]
7-953-010	Operation Env. Log: PCU: K	15<=T<25:30<=H<55	ENG	[0 to 999999999 / 0 / 1mm/step]
7-953-011	Operation Env. Log: PCU: K	15<=T<25:55<=H<80	ENG	[0 to 999999999 / 0 / 1mm/step]
7-953-012	Operation Env. Log: PCU: K	15<=T<25:80<=H<=100	ENG	[0 to 999999999 / 0 / 1mm/step]
7-953-013	Operation Env. Log: PCU: K	25<=T<30:0<=H<30	ENG	[0 to 999999999 / 0 / 1mm/step]
7-953-014	Operation Env. Log: PCU: K	25<=T<30:30<=H<55	ENG	[0 to 999999999 / 0 / 1mm/step]
7-953-015	Operation Env. Log: PCU: K	25<=T<30:55<=H<80	ENG	[0 to 999999999 / 0 / 1mm/step]
7-953-016	Operation Env. Log: PCU: K	25<=T<30:80<=H<=100	ENG	[0 to 999999999 / 0 / 1mm/step]
7-953-017	Operation Env. Log: PCU: K	30<=T:0<=H<30	ENG	[0 to 999999999 / 0 / 1mm/step]
7-953-018	Operation Env. Log: PCU: K	30<=T:30<=H<55	ENG	[0 to 999999999 / 0 / 1mm/step]
7-953-019	Operation Env. Log: PCU: K	30<=T:55<=H<80	ENG	[0 to 999999999 / 0 / 1mm/step]
7-953-020	Operation Env. Log: PCU: K	30<=T:80<=H<=100	ENG	[0 to 999999999 / 0 / 1mm/step]
7-	Operation Env. Log: PCU: K	35<=T:0<=H<=100	ENG	[0 to 999999999 / 0 /

3.SP Mode Tables

SP No.	Large Category	Small Category	ENG or CTL	[Min to Max/Init./Step]
953-021				1mm/step]
7-953-100	Operation Env. Log Clear		ENG	[0 to 1 / 0 / 1/step]
7-954-002	PM Counter Display: Pages (%)	# PCU:K	ENG	[0 to 255 / 0 / 1%/step]
7-954-003	PM Counter Display: Pages (%)	# Dev Unit:K	ENG	[0 to 255 / 0 / 1%/step]
7-954-004	PM Counter Display: Pages (%)	Developer:K	ENG	[0 to 255 / 0 / 1%/step]
7-954-025	PM Counter Display: Pages (%)	# PCU:C	ENG	[0 to 255 / 0 / 1%/step]
7-954-026	PM Counter Display: Pages (%)	# Dev Unit:C	ENG	[0 to 255 / 0 / 1%/step]
7-954-027	PM Counter Display: Pages (%)	Developer:C	ENG	[0 to 255 / 0 / 1%/step]
7-954-048	PM Counter Display: Pages (%)	# PCU:M	ENG	[0 to 255 / 0 / 1%/step]
7-954-049	PM Counter Display: Pages (%)	# Dev Unit:M	ENG	[0 to 255 / 0 / 1%/step]
7-954-050	PM Counter Display: Pages (%)	Developer:M	ENG	[0 to 255 / 0 / 1%/step]
7-954-071	PM Counter Display: Pages (%)	# PCU:Y	ENG	[0 to 255 / 0 / 1%/step]
7-	PM Counter Display: Pages	# Dev Unit:Y	ENG	[0 to 255 / 0 / 1%/step]

3.SP Mode Tables

SP No.	Large Category	Small Category	ENG or CTL	[Min to Max/Init./Step]
954-072	(%)			
7-954-073	PM Counter Display: Pages (%)	Developer:Y	ENG	[0 to 255 / 0 / 1%/step]
7-954-093	PM Counter Display: Pages (%)	# ITB Unit	ENG	[0 to 255 / 0 / 1%/step]
7-954-102	PM Counter Display: Pages (%)	# ITB Cleaning Unit	ENG	[0 to 255 / 0 / 1%/step]
7-954-109	PM Counter Display: Pages (%)	# PTR Unit	ENG	[0 to 255 / 0 / 1%/step]
7-954-115	PM Counter Display: Pages (%)	# Fusing Unit	ENG	[0 to 255 / 0 / 1%/step]
7-954-116	PM Counter Display: Pages (%)	Fusing Belt	ENG	[0 to 255 / 0 / 1%/step]
7-954-118	PM Counter Display: Pages (%)	Pressure Roller	ENG	[0 to 255 / 0 / 1%/step]
7-954-131	PM Counter Display: Pages (%)	Dust Filter	ENG	[0 to 255 / 0 / 1%/step]
7-954-142	PM Counter Display: Pages (%)	Waste Toner Bottle	ENG	[0 to 255 / 0 / 1%/step]
7-954-206	PM Counter Display: Pages (%)	ADF Pick-up Roller	ENG	[0 to 255 / 0 / 1%/step]
7-954-207	PM Counter Display: Pages (%)	ADF Supply Belt	ENG	[0 to 255 / 0 / 1%/step]
7-	PM Counter Display: Pages	ADF Reverse Roller	ENG	[0 to 255 / 0 / 1%/step]

3.SP Mode Tables

SP No.	Large Category	Small Category	ENG or CTL	[Min to Max/Init./Step]
954-208	(%)			
7-955-002	Estimated Remain Pages	# PCU:K	ENG	[0 to 9999999 / 0 / 1page/step]
7-955-003	Estimated Remain Pages	# Dev Unit:K	ENG	[0 to 9999999 / 0 / 1page/step]
7-955-004	Estimated Remain Pages	Developer:K	ENG	[0 to 9999999 / 0 / 1page/step]
7-955-025	Estimated Remain Pages	# PCU:C	ENG	[0 to 9999999 / 0 / 1page/step]
7-955-026	Estimated Remain Pages	# Dev Unit:C	ENG	[0 to 9999999 / 0 / 1page/step]
7-955-027	Estimated Remain Pages	Developer:C	ENG	[0 to 9999999 / 0 / 1page/step]
7-955-048	Estimated Remain Pages	# PCU:M	ENG	[0 to 9999999 / 0 / 1page/step]
7-955-049	Estimated Remain Pages	# Dev Unit:M	ENG	[0 to 9999999 / 0 / 1page/step]
7-955-050	Estimated Remain Pages	Developer:M	ENG	[0 to 9999999 / 0 / 1page/step]
7-955-071	Estimated Remain Pages	# PCU:Y	ENG	[0 to 9999999 / 0 / 1page/step]
7-955-072	Estimated Remain Pages	# Dev Unit:Y	ENG	[0 to 9999999 / 0 / 1page/step]
7-	Estimated Remain Pages	Developer:Y	ENG	[0 to 9999999 / 0 /

3.SP Mode Tables

SP No.	Large Category	Small Category	ENG or CTL	[Min to Max/Init./Step]
955-073				1page/step]
7-955-093	Estimated Remain Pages	# ITB Unit	ENG	[0 to 9999999 / 0 / 1page/step]
7-955-102	Estimated Remain Pages	# ITB Cleaning Unit	ENG	[0 to 9999999 / 0 / 1page/step]
7-955-109	Estimated Remain Pages	# PTR Unit	ENG	[0 to 9999999 / 0 / 1page/step]
7-955-115	Estimated Remain Pages	# Fusing Unit	ENG	[0 to 9999999 / 0 / 1page/step]
7-955-116	Estimated Remain Pages	Fusing Belt	ENG	[0 to 9999999 / 0 / 1page/step]
7-955-118	Estimated Remain Pages	Pressure Roller	ENG	[0 to 9999999 / 0 / 1page/step]
7-956-002	Estimated Remain Days	# PCU:K	ENG	[0 to 255 / 255 / 1days/step]
7-956-003	Estimated Remain Days	# Dev Unit:K	ENG	[0 to 255 / 255 / 1days/step]
7-956-004	Estimated Remain Days	Developer:K	ENG	[0 to 255 / 255 / 1days/step]
7-956-025	Estimated Remain Days	# PCU:C	ENG	[0 to 255 / 255 / 1days/step]
7-956-026	Estimated Remain Days	# Dev Unit:C	ENG	[0 to 255 / 255 / 1days/step]
7-	Estimated Remain Days	Developer:C	ENG	[0 to 255 / 255 /

3.SP Mode Tables

SP No.	Large Category	Small Category	ENG or CTL	[Min to Max/Init./Step]
956-027				1days/step]
7-956-048	Estimated Remain Days	# PCU:M	ENG	[0 to 255 / 255 / 1days/step]
7-956-049	Estimated Remain Days	# Dev Unit:M	ENG	[0 to 255 / 255 / 1days/step]
7-956-050	Estimated Remain Days	Developer:M	ENG	[0 to 255 / 255 / 1days/step]
7-956-071	Estimated Remain Days	# PCU:Y	ENG	[0 to 255 / 255 / 1days/step]
7-956-072	Estimated Remain Days	# Dev Unit:Y	ENG	[0 to 255 / 255 / 1days/step]
7-956-073	Estimated Remain Days	Developer:Y	ENG	[0 to 255 / 255 / 1days/step]
7-956-093	Estimated Remain Days	# ITB Unit	ENG	[0 to 255 / 255 / 1days/step]
7-956-102	Estimated Remain Days	# ITB Cleaning Unit	ENG	[0 to 255 / 255 / 1days/step]
7-956-109	Estimated Remain Days	# PTR Unit	ENG	[0 to 255 / 255 / 1days/step]
7-956-115	Estimated Remain Days	# Fusing Unit	ENG	[0 to 255 / 255 / 1days/step]
7-956-116	Estimated Remain Days	Fusing Belt	ENG	[0 to 255 / 255 / 1days/step]
7-	Estimated Remain Days	Pressure Roller	ENG	[0 to 255 / 255 /

3.SP Mode Tables

SP No.	Large Category	Small Category	ENG or CTL	[Min to Max/Init./Step]
956-118				1days/step]
7-956-131	Estimated Remain Days	Dust Filter	ENG	[0 to 255 / 255 / 1days/step]
7-956-142	Estimated Remain Days	Waste Toner Bottle	ENG	[0 to 255 / 255 / 1days/step]
7-956-206	Estimated Remain Days	ADF Pick-up Roller	ENG	[0 to 255 / 255 / 1days/step]
7-956-207	Estimated Remain Days	ADF Supply Belt	ENG	[0 to 255 / 255 / 1days/step]
7-956-208	Estimated Remain Days	ADF Reverse Roller	ENG	[0 to 255 / 255 / 1days/step]
7-957-002	Monthly Average Pages	# PCU:K	ENG	[0 to 9999999 / 0 / 1page/step]
7-957-003	Monthly Average Pages	# Dev Unit:K	ENG	[0 to 9999999 / 0 / 1page/step]
7-957-004	Monthly Average Pages	Developer:K	ENG	[0 to 9999999 / 0 / 1page/step]
7-957-025	Monthly Average Pages	# PCU:C	ENG	[0 to 9999999 / 0 / 1page/step]
7-957-026	Monthly Average Pages	# Dev Unit:C	ENG	[0 to 9999999 / 0 / 1page/step]
7-957-027	Monthly Average Pages	Developer:C	ENG	[0 to 9999999 / 0 / 1page/step]
7-	Monthly Average Pages	# PCU:M	ENG	[0 to 9999999 / 0 /

3.SP Mode Tables

SP No.	Large Category	Small Category	ENG or CTL	[Min to Max/Init./Step]
957-048				1page/step]
7-957-049	Monthly Average Pages	# Dev Unit:M	ENG	[0 to 9999999 / 0 / 1page/step]
7-957-050	Monthly Average Pages	Developer:M	ENG	[0 to 9999999 / 0 / 1page/step]
7-957-071	Monthly Average Pages	# PCU:Y	ENG	[0 to 9999999 / 0 / 1page/step]
7-957-072	Monthly Average Pages	# Dev Unit:Y	ENG	[0 to 9999999 / 0 / 1page/step]
7-957-073	Monthly Average Pages	Developer:Y	ENG	[0 to 9999999 / 0 / 1page/step]
7-957-093	Monthly Average Pages	# ITB Unit	ENG	[0 to 9999999 / 0 / 1page/step]
7-957-102	Monthly Average Pages	# ITB Cleaning Unit	ENG	[0 to 9999999 / 0 / 1page/step]
7-957-109	Monthly Average Pages	# PTR Unit	ENG	[0 to 9999999 / 0 / 1page/step]
7-957-115	Monthly Average Pages	# Fusing Unit	ENG	[0 to 9999999 / 0 / 1page/step]
7-957-116	Monthly Average Pages	Fusing Belt	ENG	[0 to 9999999 / 0 / 1page/step]
7-957-118	Monthly Average Pages	Pressure Roller	ENG	[0 to 9999999 / 0 / 1page/step]
7-	PM Value	# PCU:K	ENG	[1 to 30 / 15 /

3.SP Mode Tables

SP No.	Large Category	Small Category	ENG or CTL	[Min to Max/Init./Step]
958-002	Setting:DaysThreshold			1days/step]
7-958-003	PM Value Setting:DaysThreshold	# Dev Unit:K	ENG	[1 to 30 / 15 / 1days/step]
7-958-004	PM Value Setting:DaysThreshold	Developer:K	ENG	[1 to 30 / 15 / 1days/step]
7-958-025	PM Value Setting:DaysThreshold	# PCU:C	ENG	[1 to 30 / 15 / 1days/step]
7-958-026	PM Value Setting:DaysThreshold	# Dev Unit:C	ENG	[1 to 30 / 15 / 1days/step]
7-958-027	PM Value Setting:DaysThreshold	Developer:C	ENG	[1 to 30 / 15 / 1days/step]
7-958-048	PM Value Setting:DaysThreshold	# PCU:M	ENG	[1 to 30 / 15 / 1days/step]
7-958-049	PM Value Setting:DaysThreshold	# Dev Unit:M	ENG	[1 to 30 / 15 / 1days/step]
7-958-050	PM Value Setting:DaysThreshold	Developer:M	ENG	[1 to 30 / 15 / 1days/step]
7-958-071	PM Value Setting:DaysThreshold	# PCU:Y	ENG	[1 to 30 / 15 / 1days/step]
7-958-072	PM Value Setting:DaysThreshold	# Dev Unit:Y	ENG	[1 to 30 / 15 / 1days/step]
7-958-073	PM Value Setting:DaysThreshold	Developer:Y	ENG	[1 to 30 / 15 / 1days/step]
7-	PM Value	# ITB Unit	ENG	[1 to 30 / 15 /

3.SP Mode Tables

SP No.	Large Category	Small Category	ENG or CTL	[Min to Max/Init./Step]
958-093	Setting:DaysThreshold			1days/step]
7-958-102	PM Value Setting:DaysThreshold	# ITB Cleaning Unit	ENG	[1 to 30 / 15 / 1days/step]
7-958-109	PM Value Setting:DaysThreshold	# PTR Unit	ENG	[1 to 30 / 15 / 1days/step]
7-958-115	PM Value Setting:DaysThreshold	# Fusing Unit	ENG	[1 to 30 / 15 / 1days/step]
7-958-116	PM Value Setting:DaysThreshold	Fusing Belt	ENG	[1 to 30 / 15 / 1days/step]
7-958-118	PM Value Setting:DaysThreshold	Pressure Roller	ENG	[1 to 30 / 15 / 1days/step]
7-958-131	PM Value Setting:DaysThreshold	Dust Filter	ENG	[1 to 30 / 15 / 1days/step]
7-958-142	PM Value Setting:DaysThreshold	Waste Toner Bottle	ENG	[1 to 30 / 15 / 1days/step]
7-958-206	PM Value Setting:DaysThreshold	ADF Pick-up Roller	ENG	[1 to 30 / 15 / 1days/step]
7-958-207	PM Value Setting:DaysThreshold	ADF Supply Belt	ENG	[1 to 30 / 15 / 1days/step]
7-958-208	PM Value Setting:DaysThreshold	ADF Reverse Roller	ENG	[1 to 30 / 15 / 1days/step]
7-960-002	Estimated Usage Rate	# PCU:K	ENG	[0 to 255 / 0 / 1%/step]
7-	Estimated Usage Rate	# Dev Unit:K	ENG	[0 to 255 / 0 / 1%/step]

3.SP Mode Tables

SP No.	Large Category	Small Category	ENG or CTL	[Min to Max/Init./Step]
960-003				
7-960-004	Estimated Usage Rate	Developer:K	ENG	[0 to 255 / 0 / 1%/step]
7-960-025	Estimated Usage Rate	# PCU:C	ENG	[0 to 255 / 0 / 1%/step]
7-960-026	Estimated Usage Rate	# Dev Unit:C	ENG	[0 to 255 / 0 / 1%/step]
7-960-027	Estimated Usage Rate	Developer:C	ENG	[0 to 255 / 0 / 1%/step]
7-960-048	Estimated Usage Rate	# PCU:M	ENG	[0 to 255 / 0 / 1%/step]
7-960-049	Estimated Usage Rate	# Dev Unit:M	ENG	[0 to 255 / 0 / 1%/step]
7-960-050	Estimated Usage Rate	Developer:M	ENG	[0 to 255 / 0 / 1%/step]
7-960-071	Estimated Usage Rate	# PCU:Y	ENG	[0 to 255 / 0 / 1%/step]
7-960-072	Estimated Usage Rate	# Dev Unit:Y	ENG	[0 to 255 / 0 / 1%/step]
7-960-073	Estimated Usage Rate	Developer:Y	ENG	[0 to 255 / 0 / 1%/step]
7-960-093	Estimated Usage Rate	# ITB Unit	ENG	[0 to 255 / 0 / 1%/step]
7-	Estimated Usage Rate	# ITB Cleaning Unit	ENG	[0 to 255 / 0 / 1%/step]

3.SP Mode Tables

SP No.	Large Category	Small Category	ENG or CTL	[Min to Max/Init./Step]
960-102				
7-960-109	Estimated Usage Rate	# PTR Unit	ENG	[0 to 255 / 0 / 1%/step]
7-960-115	Estimated Usage Rate	# Fusing Unit	ENG	[0 to 255 / 0 / 1%/step]
7-960-116	Estimated Usage Rate	Fusing Belt	ENG	[0 to 255 / 0 / 1%/step]
7-960-118	Estimated Usage Rate	Pressure Roller	ENG	[0 to 255 / 0 / 1%/step]
7-960-131	Estimated Usage Rate	Dust Filter	ENG	[0 to 255 / 0 / 1%/step]
7-960-142	Estimated Usage Rate	Waste Toner Bottle	ENG	[0 to 255 / 0 / 1%/step]
7-960-206	Estimated Usage Rate	ADF Pick-up Roller	ENG	[0 to 255 / 0 / 1%/step]
7-960-207	Estimated Usage Rate	ADF Supply Belt	ENG	[0 to 255 / 0 / 1%/step]
7-960-208	Estimated Usage Rate	ADF Reverse Roller	ENG	[0 to 255 / 0 / 1%/step]
7-978-001	SC670-01 Log	First Occurred	ENG*	[0 to 1 / 0 / 1/step]
7-978-002	SC670-01 Log	First Data1	ENG*	[0x00000000 to 0xFFFFFFFF / 0x00000000 / 1/step]
7-	SC670-01 Log	First Data2	ENG*	[0x00000000 to

3.SP Mode Tables

SP No.	Large Category	Small Category	ENG or CTL	[Min to Max/Init./Step]
978-003				0xFFFFFFFF / 0x00000000 / 1/step]
7-978-004	SC670-01 Log	First Data3	ENG*	[0x00000000 to 0xFFFFFFFF / 0x00000000 / 1/step]
7-978-005	SC670-01 Log	First Data4	ENG*	[0x00000000 to 0xFFFFFFFF / 0x00000000 / 1/step]
7-978-006	SC670-01 Log	First Data5	ENG*	[0x00000000 to 0xFFFFFFFF / 0x00000000 / 1/step]
7-978-011	SC670-01 Log	Latest Occurred	ENG*	[0 to 1 / 0 / 1/step]
7-978-012	SC670-01 Log	Latest Data1	ENG*	[0x00000000 to 0xFFFFFFFF / 0x00000000 / 1/step]
7-978-013	SC670-01 Log	Latest Data2	ENG*	[0x00000000 to 0xFFFFFFFF / 0x00000000 / 1/step]
7-978-014	SC670-01 Log	Latest Data3	ENG*	[0x00000000 to 0xFFFFFFFF / 0x00000000 / 1/step]
7-978-015	SC670-01 Log	Latest Data4	ENG*	[0x00000000 to 0xFFFFFFFF / 0x00000000 / 1/step]
7-978-016	SC670-01 Log	Latest Data5	ENG*	[0x00000000 to 0xFFFFFFFF / 0x00000000 / 1/step]
7-979-001	ENG Reset Log	Data1	ENG*	[0x00 to 0xFF / 0x00 / 1/step]
7-979-002	ENG Reset Log	Data2	ENG*	[0x0000 to 0xFFFF / 0x0000 / 1/step]
7-	ENG Reset Log	Data3	ENG*	[0x0000 to 0xFFFF /

SP No.	Large Category	Small Category	ENG or CTL	[Min to Max/Init./Step]
979-003				0x0000 / 1/step]
7-979-004	ENG Reset Log	Data4	ENG*	[0x0000 to 0xFFFF / 0x0000 / 1/step]
7-979-005	ENG Reset Log	Data5	ENG*	[0x0000 to 0xFFFF / 0x0000 / 1/step]
7-979-006	ENG Reset Log	Data6	ENG*	[0x0000 to 0xFFFF / 0x0000 / 1/step]
7-979-007	ENG Reset Log	Data7	ENG*	[0x0000 to 0xFFFF / 0x0000 / 1/step]
7-979-008	ENG Reset Log	Data8	ENG*	[0x0000 to 0xFFFF / 0x0000 / 1/step]
7-979-009	ENG Reset Log	Data9	ENG*	[0x0000 to 0xFFFF / 0x0000 / 1/step]
7-979-010	ENG Reset Log	Data10	ENG*	[0x0000 to 0xFFFF / 0x0000 / 1/step]
7-979-011	ENG Reset Log	Data11	ENG*	[0x0000 to 0xFFFF / 0x0000 / 1/step]
7-979-012	ENG Reset Log	Data12	ENG*	[0x0000 to 0xFFFF / 0x0000 / 1/step]
7-979-013	ENG Reset Log	Data13	ENG*	[0x0000 to 0xFFFF / 0x0000 / 1/step]
7-979-014	ENG Reset Log	Data14	ENG*	[0x0000 to 0xFFFF / 0x0000 / 1/step]
7-	ENG Reset Log	Data15	ENG*	[0x0000 to 0xFFFF /

3.SP Mode Tables

SP No.	Large Category	Small Category	ENG or CTL	[Min to Max/Init./Step]
979-015				0x0000 / 1/step]
7-979-016	ENG Reset Log	Data16	ENG*	[0x0000 to 0xFFFF / 0x0000 / 1/step]
7-979-017	ENG Reset Log	Data17	ENG*	[0x0000 to 0xFFFF / 0x0000 / 1/step]
7-979-018	ENG Reset Log	Data18	ENG*	[0x0000 to 0xFFFF / 0x0000 / 1/step]
7-979-019	ENG Reset Log	Data19	ENG*	[0x0000 to 0xFFFF / 0x0000 / 1/step]
7-979-020	ENG Reset Log	Data20	ENG*	[0x0000 to 0xFFFF / 0x0000 / 1/step]
7-979-021	ENG Reset Log	Data21	ENG*	[0x0000 to 0xFFFF / 0x0000 / 1/step]
7-980-001	Current for Torque Calculation	OPCTransferMotor	ENG*	[0.000 to 9.999 / 0.000 / 0.001A/step]
7-980-002	Current for Torque Calculation	BkDevMotor	ENG*	[0.000 to 9.999 / 0.000 / 0.001A/step]
7-980-003	Current for Torque Calculation	ColorOpcMotor	ENG*	[0.000 to 9.999 / 0.000 / 0.001A/step]
7-980-004	Current for Torque Calculation	ColorDevMotor	ENG*	[0.000 to 9.999 / 0.000 / 0.001A/step]
7-980-005	Current for Torque Calculation	FusingMotor	ENG*	[0.000 to 9.999 / 0.000 / 0.001A/step]
7-	Edict:OffsetValueForTorqCalcu	ManualExe	ENG	[0 to 1 / 0 / 1/step]

3.SP Mode Tables

SP No.	Large Category	Small Category	ENG or CTL	[Min to Max/Init./Step]
981-001				
7-982-001	OffsetValueForTorqCalculation	OPCTransferMotor	ENG*	[0.00 to 655.35 / 0.00 / 0.01-/step]
7-982-002	OffsetValueForTorqCalculation	BkDevMotor	ENG*	[0.00 to 655.35 / 0.00 / 0.01-/step]
7-982-003	OffsetValueForTorqCalculation	ColorOpcMotor	ENG*	[0.00 to 655.35 / 0.00 / 0.01-/step]
7-982-004	OffsetValueForTorqCalculation	ColorDevMotor	ENG*	[0.00 to 655.35 / 0.00 / 0.01-/step]
7-982-005	OffsetValueForTorqCalculation	FusingMotor	ENG*	[0.00 to 655.35 / 0.00 / 0.01-/step]
7-983-001	OutputLevel1CountNo.	OPCTransferMotor	ENG*	[0 to 65535 / 0 / 1Count/step]
7-983-002	OutputLevel1CountNo.	BkDevMotor	ENG*	[0 to 65535 / 0 / 1Count/step]
7-983-003	OutputLevel1CountNo.	ColorOpcMotor	ENG*	[0 to 65535 / 0 / 1Count/step]
7-983-004	OutputLevel1CountNo.	ColorDevMotor	ENG*	[0 to 65535 / 0 / 1Count/step]
7-983-005	OutputLevel1CountNo.	FusingMotor	ENG*	[0 to 65535 / 0 / 1Count/step]
7-984-001	OutputLevel2CountNo.	OPCTransferMotor	ENG*	[0 to 65535 / 0 / 1Count/step]
7-	OutputLevel2CountNo.	BkDevMotor	ENG*	[0 to 65535 / 0 /

3.SP Mode Tables

SP No.	Large Category	Small Category	ENG or CTL	[Min to Max/Init./Step]
984-002				1Count/step]
7-984-003	OutputLevel2CountNo.	ColorOpcMotor	ENG*	[0 to 65535 / 0 / 1Count/step]
7-984-004	OutputLevel2CountNo.	ColorDevMotor	ENG*	[0 to 65535 / 0 / 1Count/step]
7-984-005	OutputLevel2CountNo.	FusingMotor	ENG*	[0 to 65535 / 0 / 1Count/step]
7-985-001	OutputLevel3CountNo.	OPCTransferMotor	ENG*	[0 to 65535 / 0 / 1Count/step]
7-985-002	OutputLevel3CountNo.	BkDevMotor	ENG*	[0 to 65535 / 0 / 1Count/step]
7-985-003	OutputLevel3CountNo.	ColorOpcMotor	ENG*	[0 to 65535 / 0 / 1Count/step]
7-985-004	OutputLevel3CountNo.	ColorDevMotor	ENG*	[0 to 65535 / 0 / 1Count/step]
7-985-005	OutputLevel3CountNo.	FusingMotor	ENG*	[0 to 65535 / 0 / 1Count/step]
7-986-001	VelocityErr.CountNo.	OPCTransferMotor	ENG*	[0 to 65535 / 0 / 1Count/step]
7-986-002	VelocityErr.CountNo.	BkDevMotor	ENG*	[0 to 65535 / 0 / 1Count/step]
7-986-003	VelocityErr.CountNo.	ColorOpcMotor	ENG*	[0 to 65535 / 0 / 1Count/step]
7-	VelocityErr.CountNo.	ColorDevMotor	ENG*	[0 to 65535 / 0 /

3.SP Mode Tables

SP No.	Large Category	Small Category	ENG or CTL	[Min to Max/Init./Step]
986-004				1Count/step]
7-986-005	VelocityErr.CountNo.	FusingMotor	ENG*	[0 to 65535 / 0 / 1Count/step]

Controller SP Mode Tables

Controller SP Tables-5

SP5-XXX (Mode)

SP No.	Large Category	Small Category	ENG or CTL	[Min to Max/Init./Step]
5-009-201	Add display language	1-8	CTL*	[0 to 255 / 0 / 1/step]
5-009-202	Add display language	9-16	CTL*	[0 to 255 / 0 / 1/step]
5-009-203	Add display language	17-24	CTL*	[0 to 255 / 0 / 1/step]
5-009-204	Add display language	25-32	CTL*	[0 to 255 / 0 / 1/step]
5-009-205	Add display language	33-40	CTL*	[0 to 255 / 0 / 1/step]
5-009-206	Add display language	41-48	CTL*	[0 to 255 / 0 / 1/step]
5-009-207	Add display language	49-56	CTL*	[0 to 255 / 0 / 1/step]
5-024-001	mm/inch Display Selection	0:mm 1:inch	CTL*	NA: [0 to 1 / 1 / 1/step] EU: [0 to 1 / 0 / 1/step] AS: [0 to 1 / 0 / 1/step] CHN: [0 to 1 / 0 / 1/step] TWN: [0 to 1 / 0 / 1/step]

3.SP Mode Tables

SP No.	Large Category	Small Category	ENG or CTL	[Min to Max/Init./Step]
				KOR: [0 to 1 / 0 / 1/step]
5-045-001	Accounting counter	Counter Method	CTL*	[0 to 7 / 0 / 1/step]
5-047-001	Paper Display	Backing Paper	CTL*	[0 to 1 / 0 / 1/step]
5-051-001	TonerRefillDetectionDisplay		CTL*	[0 to 1 / 0 / 1/step]
5-055-001	Display IP address		CTL*	[0 to 1 / 0 / 1/step]
5-061-001	Toner Remaining Icon Display Change		CTL*	[0 to 1 / 0 / 1/step]
5-061-002	Toner PreNearEnd Display Change		CTL*	[0 to 1 / 0 / 1/step]
5-062-002	Part Replacement Alert Display	Photoconductor Unit (Black)	CTL*	[0 to 1 / 0 / 1/step]
5-062-003	Part Replacement Alert Display	Development unit: Bk	CTL*	[0 to 1 / 0 / 1/step]
5-062-025	Part Replacement Alert Display	Photoconductor Unit (Cyan)	CTL*	[0 to 1 / 0 / 1/step]
5-062-026	Part Replacement Alert Display	Development unit: C	CTL*	[0 to 1 / 0 / 1/step]
5-062-048	Part Replacement Alert Display	Photoconductor Unit (Magenta)	CTL*	[0 to 1 / 0 / 1/step]

3.SP Mode Tables

SP No.	Large Category	Small Category	ENG or CTL	[Min to Max/Init./Step]
5-062-049	Part Replacement Alert Display	Development unit: M	CTL*	[0 to 1 / 0 / 1/step]
5-062-071	Part Replacement Alert Display	Photoconductor Unit (Yellow)	CTL*	[0 to 1 / 0 / 1/step]
5-062-072	Part Replacement Alert Display	Development unit: Y	CTL*	[0 to 1 / 0 / 1/step]
5-062-093	Part Replacement Alert Display	Intermediate Transfer Unit	CTL*	[0 to 1 / 0 / 1/step]
5-062-102	Part Replacement Alert Display	ITB Cleaning Unit	CTL*	[0 to 1 / 0 / 1/step]
5-062-109	Part Replacement Alert Display	Paper Transfer Unit	CTL*	[0 to 1 / 0 / 1/step]
5-062-115	Part Replacement Alert Display	Fuser Unit	CTL*	[0 to 1 / 0 / 1/step]
5-062-116	Part Replacement Alert Display	Fuser Unit: Belt	CTL*	[0 to 1 / 0 / 1/step]
5-062-118	Part Replacement Alert Display	Fuser Unit: Pressure Roller	CTL*	[0 to 1 / 0 / 1/step]
5-062-131	Part Replacement Alert Display	Dust Filter	CTL*	[0 to 1 / 0 / 1/step]
5-062-142	Part Replacement Alert Display	Waste Toner Bottle	CTL*	[0 to 1 / 0 / 1/step]
5-062-206	Part Replacement Alert Display	ADF Pick-up Roller	CTL*	[0 to 1 / 0 / 1/step]

3.SP Mode Tables

SP No.	Large Category	Small Category	ENG or CTL	[Min to Max/Init./Step]
5-062-207	Part Replacement Alert Display	ADF Transfer Belt	CTL*	[0 to 1 / 0 / 1/step]
5-062-208	Part Replacement Alert Display	ADF Reverse Rolle	CTL*	[0 to 1 / 0 / 1/step]
5-066-001	PM Parts Display		CTL*	[0 to 1 / 0 / 1/step]
5-067-002	Part Replacement Operation Type	Photoconductor Unit (Black)	CTL*	[0 to 1 / 0 / 1/step]
5-067-003	Part Replacement Operation Type	Development unit: Bk	CTL*	[0 to 1 / 0 / 1/step]
5-067-025	Part Replacement Operation Type	Photoconductor Unit (Cyan)	CTL*	[0 to 1 / 0 / 1/step]
5-067-026	Part Replacement Operation Type	Development unit: C	CTL*	[0 to 1 / 0 / 1/step]
5-067-048	Part Replacement Operation Type	Photoconductor Unit (Magenta)	CTL*	[0 to 1 / 0 / 1/step]
5-067-049	Part Replacement Operation Type	Development unit: M	CTL*	[0 to 1 / 0 / 1/step]
5-067-071	Part Replacement Operation Type	Photoconductor Unit (Yellow)	CTL*	[0 to 1 / 0 / 1/step]
5-067-072	Part Replacement Operation Type	Development unit: Y	CTL*	[0 to 1 / 0 / 1/step]
5-067-093	Part Replacement Operation Type	Intermediate Transfer Unit	CTL*	[0 to 1 / 0 / 1/step]

3.SP Mode Tables

SP No.	Large Category	Small Category	ENG or CTL	[Min to Max/Init./Step]
5-067-102	Part Replacement Operation Type	ITB Cleaning Unit	CTL*	[0 to 1 / 0 / 1/step]
5-067-109	Part Replacement Operation Type	Paper Transfer Unit	CTL*	[0 to 1 / 0 / 1/step]
5-067-115	Part Replacement Operation Type	Fuser Unit	CTL*	[0 to 1 / 0 / 1/step]
5-067-116	Part Replacement Operation Type	Fuser Unit: Belt	CTL*	[0 to 1 / 0 / 1/step]
5-067-118	Part Replacement Operation Type	Fuser Unit: Pressure Roller	CTL*	[0 to 1 / 0 / 1/step]
5-067-131	Part Replacement Operation Type	Dust Filter	CTL*	[0 to 1 / 0 / 1/step]
5-067-142	Part Replacement Operation Type	Waste Toner Bottle	CTL*	[0 to 1 / 0 / 1/step]
5-067-206	Part Replacement Operation Type	ADF Pick-up Roller	CTL*	[0 to 1 / 0 / 1/step]
5-067-207	Part Replacement Operation Type	ADF Transfer Belt	CTL*	[0 to 1 / 0 / 1/step]
5-067-208	Part Replacement Operation Type	ADF Reverse Rolle	CTL*	[0 to 1 / 0 / 1/step]
5-071-001	Set Bypass Paper Size Display		CTL	[0 to 1 / 0 / 1/step]
5-073-001	Supply Part Replacement Operation Type	Waste Tonner Bottle	CTL*	[0 to 1 / 0 / 1/step]

3.SP Mode Tables

SP No.	Large Category	Small Category	ENG or CTL	[Min to Max/Init./Step]
5-074-002	Home Key Customization	Login Setting	CTL*	[0 to 255 / 0 / 1/step]
5-074-050	Home Key Customization	Show Home Edit Menu	CTL	[0 to 2 / 0 / 1/step]
5-074-091	Home Key Customization	Function Setting	CTL*	[0 to 2 / 0 / 1/step]
5-074-092	Home Key Customization	Product ID	CTL*	[0 to 0xffffffff / 0 / 1/step]
5-074-093	Home Key Customization	Application Screen ID	CTL*	[0 to 255 / 0 / 1/step]
5-075-003	USB Keyboard	Display setting	CTL*	[0 to 1 / 0 / 1/step]
5-081-001	ServiceSP Entry Code Setting		CTL*	[0 to 0 / 0 / 0/step]
5-083-001	LED Light Switch Setting	Toner Near End	CTL*	[0 to 1 / 0 / 1/step]
5-083-002	LED Light Switch Setting	Waste Toner Near End	CTL*	[0 to 1 / 0 / 1/step]
5-085-001	Keyboard Setting	CH/TW SoftKeyboard Setting	CTL*	NA: [0 to 2 / 0 / 1/step] EU: [0 to 2 / 0 / 1/step] AS: [0 to 2 / 0 / 1/step] CHN: [0 to 2 / 1 / 1/step] TWN: [0 to 2 / 2 /

3.SP Mode Tables

SP No.	Large Category	Small Category	ENG or CTL	[Min to Max/Init./Step]
				1/step] KOR: [0 to 2 / 0 / 1/step]
5-101-202	Copy Auto Clear Setting	Auto Clear Timer Setting (0:ON 1:OFF)	CTL*	[0 to 1 / 0 / 1/step]
5-113-001	Optional Counter Type	Default Optional Counter Type	CTL*	[0 to 8 / 0 / 1/step]
5-113-002	Optional Counter Type	External Optional Counter Type	CTL*	[0 to 3 / 0 / 1/step]
5-114-001	Optional Counter I/F	MF Key Card Extension	CTL*	[0 to 1 / 0 / 1/step]
5-118-001	Disable Copying		CTL*	[0 to 1 / 0 / 1/step]
5-118-003	Copy mode setting	DocumentServer:Printed File Auto Delete	CTL*	[0 to 1 / 0 / 1/step]
5-118-004	Copy mode setting	Copy Limit Warning Display Setting	CTL	[0 to 1 / 1 / 1/step]
5-120-001	Mode Clear Opt. Counter Removal	0:Yes 1:StandBy 2:No	CTL*	[0 to 2 / 0 / 1/step]
5-121-001	Counter Up Timing	0:Feed 1:Exit	CTL*	[0 to 1 / 0 / 1/step]
5-127-001	APS Mode		CTL*	[0 to 1 / 0 / 1/step]
5-128-001	Code Mode With Key/Card Option		CTL*	[0 to 1 / 0 / 1/step]

3.SP Mode Tables

SP No.	Large Category	Small Category	ENG or CTL	[Min to Max/Init./Step]
5-148-002	Size Detection OFF	Tray 1	CTL*	[0 to 1 / 0 / 1/step]
5-150-001	Length Setting	Bypass(0:OFF 1:Long)	CTL	[0 to 1 / 1 / 1/step]
5-167-001	Fax Printing Mode at Optional Counter Off		CTL*	[0 to 1 / 0 / 1/step]
5-169-001	CE Login		CTL*	[0 to 1 / 0 / 1/step]
5-188-001	Copy Nv Version		CTL*	[0 to 0 / 0 / 0/step]
5-191-001	Mode Set	Power Str Set	CTL*	[0 to 1 / 1 / 1/step]
5-193-001	External Controller Info. Settings		CTL	[0 to 10 / 0 / 1/step]
5-196-001	Copier Vendor Mode	90 deg. Rotation	CTL	[0 to 1 / 0 / 1/step]
5-196-002	Copier Vendor Mode	Color and Tray Selection	CTL	[0 to 1 / 0 / 1/step]
5-199-001	Paper Exit After Staple End	Staple(1:Without 2:After 0:Auto)	CTL	[0 to 2 / 0 / 1/step]
5-199-002	Paper Exit After Staple End	Saddle(1:Without 2:After 0:Auto)	CTL	[0 to 2 / 0 / 1/step]
5-199-003	Paper Exit After Staple End	Stapless(1:Without 2:After 0:Auto)	CTL	[0 to 2 / 0 / 1/step]

3.SP Mode Tables

SP No.	Large Category	Small Category	ENG or CTL	[Min to Max/Init./Step]
5-212-003	Page Numbering	Duplex Printout Left/Right Position of Left/Right Facing	CTL*	[-1000 to 1000 / 0 / 0.01mm/step]
5-212-004	Page Numbering	Duplex Printout Top/Bottom Position of Left/Right Facing	CTL*	[-1000 to 1000 / 0 / 0.01mm/step]
5-212-018	Page Numbering	Duplex Printout Left/Right Position of Top/Bottom Facing	CTL*	[-1000 to 1000 / 0 / 0.01mm/step]
5-212-019	Page Numbering	Duplex Printout Top/Bottom Position of Top/Bottom Facing	CTL*	[-1000 to 1000 / 0 / 0.01mm/step]
5-227-201	Page Numbering	Allow Page No. Entry	CTL*	[2 to 9 / 9 / 1/step]
5-227-202	Page Numbering	Zero Surplus Setting	CTL*	[0 to 1 / 0 / 1/step]
5-302-002	Set Time	Time Difference	CTL*	NA: [-1440 to 1440 / -300 / 1/step] EU: [-1440 to 1440 / 60 / 1/step] AS: [-1440 to 1440 / 480 / 1/step] CHN: [-1440 to 1440 / 480 / 1/step] TWN: [-1440 to 1440 / 480 / 1/step] KOR: [-1440 to 1440 / 540 / 1/step]
5-	Auto Off Set	Auto Off Limit Set	CTL*	[0 to 1 / 0 / 1/step]

3.SP Mode Tables

SP No.	Large Category	Small Category	ENG or CTL	[Min to Max/Init./Step]
305-101				
5-307-001	Daylight Saving Time	Setting	CTL*	NA: [0 to 1 / 1 / 1/step] EU: [0 to 1 / 1 / 1/step] AS: [0 to 1 / 0 / 1/step] CHN: [0 to 1 / 0 / 1/step] TWN: [0 to 1 / 0 / 1/step] KOR: [0 to 1 / 0 / 1/step]
5-307-003	Daylight Saving Time	Rule Set(Start)	CTL*	NA: [0 to 0xffffffff / 0x03200210 / 1/step] EU: [0 to 0xffffffff / 0x03500010 / 1/step] AS: [0 to 0xffffffff / 0x10500010 / 1/step] CHN: [0 to 0xffffffff / 0 / 1/step] TWN: [0 to 0xffffffff / 0 / 1/step] KOR: [0 to 0xffffffff / 0 / 1/step]
5-307-004	Daylight Saving Time	Rule Set(End)	CTL*	NA: [0 to 0xffffffff / 0x11100200 / 1/step] EU: [0 to 0xffffffff / 0x10500100 / 1/step] AS: [0 to 0xffffffff /

3.SP Mode Tables

SP No.	Large Category	Small Category	ENG or CTL	[Min to Max/Init./Step]
				0x03100000 / 1/step] CHN: [0 to 0xffffffff / 0 / 1/step] TWN: [0 to 0xffffffff / 0 / 1/step] KOR: [0 to 0xffffffff / 0 / 1/step]
5-401-103	Access Control	Default Document ACL	CTL*	[0 to 3 / 0 / 1/step]
5-401-104	Access Control	Authentication Time	CTL*	[0 to 255 / 0 / 1sec/step]
5-401-162	Access Control	Extend Certification Detail	CTL*	[0 to 0xff / 0 / 1/step]
5-401-200	Access Control	SDK1 UniqueID	CTL*	[0 to 0xFFFFFFFF / 0 / 1/step]
5-401-201	Access Control	SDK1 Certification Method	CTL*	[0 to 0xFF / 0 / 1/step]
5-401-210	Access Control	SDK2 UniqueID	CTL*	[0 to 0xFFFFFFFF / 0 / 1/step]
5-401-211	Access Control	SDK2 Certification Method	CTL*	[0 to 0xFF / 0 / 1/step]
5-401-220	Access Control	SDK3 UniqueID	CTL*	[0 to 0xFFFFFFFF / 0 / 1/step]
5-401-221	Access Control	SDK3 Certification Method	CTL*	[0 to 0xFF / 0 / 1/step]
5-	Access Control	SDK Certification Device	CTL*	[0 to 0xff / 0 /

3.SP Mode Tables

SP No.	Large Category	Small Category	ENG or CTL	[Min to Max/Init./Step]
401-230				1/step]
5-401-240	Access Control	Detail Option	CTL*	[0 to 0xff / 0 / 1/step]
5-402-101	Access Control	SDKJ1 Limit Setting	CTL*	[0 to 0xFF / 0 / 1/step]
5-402-102	Access Control	SDKJ2 Limit Setting	CTL*	[0 to 0xFF / 0 / 1/step]
5-402-103	Access Control	SDKJ3 Limit Setting	CTL*	[0 to 0xFF / 0 / 1/step]
5-402-104	Access Control	SDKJ4 Limit Setting	CTL*	[0 to 0xFF / 0 / 1/step]
5-402-105	Access Control	SDKJ5 Limit Setting	CTL*	[0 to 0xFF / 0 / 1/step]
5-402-106	Access Control	SDKJ6 Limit Setting	CTL*	[0 to 0xFF / 0 / 1/step]
5-402-107	Access Control	SDKJ7 Limit Setting	CTL*	[0 to 0xFF / 0 / 1/step]
5-402-108	Access Control	SDKJ8 Limit Setting	CTL*	[0 to 0xFF / 0 / 1/step]
5-402-109	Access Control	SDKJ9 Limit Setting	CTL*	[0 to 0xFF / 0 / 1/step]
5-402-110	Access Control	SDKJ10 Limit Setting	CTL*	[0 to 0xFF / 0 / 1/step]

3.SP Mode Tables

SP No.	Large Category	Small Category	ENG or CTL	[Min to Max/Init./Step]
5-402-111	Access Control	SDKJ11 Limit Setting	CTL*	[0 to 0xFF / 0 / 1/step]
5-402-112	Access Control	SDKJ12 Limit Setting	CTL*	[0 to 0xFF / 0 / 1/step]
5-402-113	Access Control	SDKJ13 Limit Setting	CTL*	[0 to 0xFF / 0 / 1/step]
5-402-114	Access Control	SDKJ14 Limit Setting	CTL*	[0 to 0xFF / 0 / 1/step]
5-402-115	Access Control	SDKJ15 Limit Setting	CTL*	[0 to 0xFF / 0 / 1/step]
5-402-116	Access Control	SDKJ16 Limit Setting	CTL*	[0 to 0xFF / 0 / 1/step]
5-402-117	Access Control	SDKJ17 Limit Setting	CTL*	[0 to 0xFF / 0 / 1/step]
5-402-118	Access Control	SDKJ18 Limit Setting	CTL*	[0 to 0xFF / 0 / 1/step]
5-402-119	Access Control	SDKJ19 Limit Setting	CTL*	[0 to 0xFF / 0 / 1/step]
5-402-120	Access Control	SDKJ20 Limit Setting	CTL*	[0 to 0xFF / 0 / 1/step]
5-402-121	Access Control	SDKJ21 Limit Setting	CTL*	[0 to 0xFF / 0 / 1/step]
5-402-122	Access Control	SDKJ22 Limit Setting	CTL*	[0 to 0xFF / 0 / 1/step]

3.SP Mode Tables

SP No.	Large Category	Small Category	ENG or CTL	[Min to Max/Init./Step]
5-402-123	Access Control	SDKJ23 Limit Setting	CTL*	[0 to 0xFF / 0 / 1/step]
5-402-124	Access Control	SDKJ24 Limit Setting	CTL*	[0 to 0xFF / 0 / 1/step]
5-402-125	Access Control	SDKJ25 Limit Setting	CTL*	[0 to 0xFF / 0 / 1/step]
5-402-126	Access Control	SDKJ26 Limit Setting	CTL*	[0 to 0xFF / 0 / 1/step]
5-402-127	Access Control	SDKJ27 Limit Setting	CTL*	[0 to 0xFF / 0 / 1/step]
5-402-128	Access Control	SDKJ28 Limit Setting	CTL*	[0 to 0xFF / 0 / 1/step]
5-402-129	Access Control	SDKJ29 Limit Setting	CTL*	[0 to 0xFF / 0 / 1/step]
5-402-130	Access Control	SDKJ30 Limit Setting	CTL*	[0 to 0xFF / 0 / 1/step]
5-402-141	Access Control	SDKJ1 ProductID	CTL*	[0 to 0xffffffff / 0 / 1/step]
5-402-142	Access Control	SDKJ2 ProductID	CTL*	[0 to 0xffffffff / 0 / 1/step]
5-402-143	Access Control	SDKJ3 ProductID	CTL*	[0 to 0xffffffff / 0 / 1/step]
5-402-144	Access Control	SDKJ4 ProductID	CTL*	[0 to 0xffffffff / 0 / 1/step]

3.SP Mode Tables

SP No.	Large Category	Small Category	ENG or CTL	[Min to Max/Init./Step]
5-402-145	Access Control	SDKJ5 ProductID	CTL*	[0 to 0xffffffff / 0 / 1/step]
5-402-146	Access Control	SDKJ6 ProductID	CTL*	[0 to 0xffffffff / 0 / 1/step]
5-402-147	Access Control	SDKJ7 ProductID	CTL*	[0 to 0xffffffff / 0 / 1/step]
5-402-148	Access Control	SDKJ8 ProductID	CTL*	[0 to 0xffffffff / 0 / 1/step]
5-402-149	Access Control	SDKJ9 ProductID	CTL*	[0 to 0xffffffff / 0 / 1/step]
5-402-150	Access Control	SDKJ10 ProductID	CTL*	[0 to 0xffffffff / 0 / 1/step]
5-402-151	Access Control	SDKJ11 ProductID	CTL*	[0 to 0xffffffff / 0 / 1/step]
5-402-152	Access Control	SDKJ12 ProductID	CTL*	[0 to 0xffffffff / 0 / 1/step]
5-402-153	Access Control	SDKJ13 ProductID	CTL*	[0 to 0xffffffff / 0 / 1/step]
5-402-154	Access Control	SDKJ14 ProductID	CTL*	[0 to 0xffffffff / 0 / 1/step]
5-402-155	Access Control	SDKJ15 ProductID	CTL*	[0 to 0xffffffff / 0 / 1/step]
5-402-156	Access Control	SDKJ16 ProductID	CTL*	[0 to 0xffffffff / 0 / 1/step]

3.SP Mode Tables

SP No.	Large Category	Small Category	ENG or CTL	[Min to Max/Init./Step]
5-402-157	Access Control	SDKJ17 ProductID	CTL*	[0 to 0xffffffff / 0 / 1/step]
5-402-158	Access Control	SDKJ18 ProductID	CTL*	[0 to 0xffffffff / 0 / 1/step]
5-402-159	Access Control	SDKJ19 ProductID	CTL*	[0 to 0xffffffff / 0 / 1/step]
5-402-160	Access Control	SDKJ20 ProductID	CTL*	[0 to 0xffffffff / 0 / 1/step]
5-402-161	Access Control	SDKJ21 ProductID	CTL*	[0 to 0xffffffff / 0 / 1/step]
5-402-162	Access Control	SDKJ22 ProductID	CTL*	[0 to 0xffffffff / 0 / 1/step]
5-402-163	Access Control	SDKJ23 ProductID	CTL*	[0 to 0xffffffff / 0 / 1/step]
5-402-164	Access Control	SDKJ24 ProductID	CTL*	[0 to 0xffffffff / 0 / 1/step]
5-402-165	Access Control	SDKJ25 ProductID	CTL*	[0 to 0xffffffff / 0 / 1/step]
5-402-166	Access Control	SDKJ26 ProductID	CTL*	[0 to 0xffffffff / 0 / 1/step]
5-402-167	Access Control	SDKJ27 ProductID	CTL*	[0 to 0xffffffff / 0 / 1/step]
5-402-168	Access Control	SDKJ28 ProductID	CTL*	[0 to 0xffffffff / 0 / 1/step]

3.SP Mode Tables

SP No.	Large Category	Small Category	ENG or CTL	[Min to Max/Init./Step]
5-402-169	Access Control	SDKJ29 ProductID	CTL*	[0 to 0xffffffff / 0 / 1/step]
5-402-170	Access Control	SDKJ30 ProductID	CTL*	[0 to 0xffffffff / 0 / 1/step]
5-404-001	User Code Count Clear	User Code Count Clear	CTL*	[0 to 0 / 0 / 0/step]
5-411-004	LDAP-Certification	Simplified Authentication	CTL*	[0 to 1 / 1 / 1/step]
5-411-005	LDAP-Certification	Password Null Not Permit	CTL*	[0 to 1 / 1 / 1/step]
5-411-006	LDAP-Certification	Detail Option	CTL*	[0 to 0xff / 0 / 1/step]
5-412-100	Krb-Certification	Encrypt Mode	CTL*	[0 to 0xFF / 0x1F / 1/step]
5-413-001	Lockout Setting	Lockout On/Off	CTL*	[0 to 1 / 0 / 1/step]
5-413-002	Lockout Setting	Lockout Threshold	CTL*	[1 to 10 / 5 / 1/step]
5-413-003	Lockout Setting	Cancelation On/Off	CTL*	[0 to 1 / 0 / 1/step]
5-413-004	Lockout Setting	Cancelation Time	CTL*	[1 to 9999 / 60 / 1min/step]
5-414-001	Access Mitigation	Mitigation On/Off	CTL*	[0 to 1 / 0 / 1/step]

3.SP Mode Tables

SP No.	Large Category	Small Category	ENG or CTL	[Min to Max/Init./Step]
5-414-002	Access Mitigation	Mitigation Time	CTL*	[0 to 60 / 15 / 1min/step]
5-415-001	Password Attack	Permissible Number	CTL*	[0 to 100 / 30 / 1/step]
5-415-002	Password Attack	Detect Time	CTL*	[1 to 10 / 5 / 1/step]
5-416-001	Access Information	Access User Max Num	CTL*	[50 to 200 / 200 / 1/step]
5-416-002	Access Information	Access Password Max Num	CTL*	[50 to 200 / 200 / 1/step]
5-416-003	Access Information	Monitor Interval	CTL*	[1 to 10 / 3 / 1/step]
5-417-001	Access Attack	Access Permissible Number	CTL*	[0 to 500 / 100 / 1/step]
5-417-002	Access Attack	Attack Detect Time	CTL*	[10 to 30 / 10 / 1sec/step]
5-417-003	Access Attack	Productivity Fall Waite	CTL*	[0 to 9 / 3 / 1sec/step]
5-417-004	Access Attack	Attack Max Num	CTL*	[50 to 200 / 200 / 1/step]
5-420-001	User Authentication	Copy	CTL*	[0 to 1 / 0 / 1/step]
5-420-002	User Authentication	Color Security Setting	CTL	[0 to 255 / 0 / 1/step]

3.SP Mode Tables

SP No.	Large Category	Small Category	ENG or CTL	[Min to Max/Init./Step]
5-420-011	User Authentication	DocumentServer	CTL*	[0 to 1 / 0 / 1/step]
5-420-021	User Authentication	Fax	CTL*	[0 to 1 / 0 / 1/step]
5-420-031	User Authentication	Scanner	CTL*	[0 to 1 / 0 / 1/step]
5-420-041	User Authentication	Printer	CTL*	[0 to 1 / 0 / 1/step]
5-420-051	User Authentication	SDK1	CTL*	[0 to 1 / 0 / 1/step]
5-420-061	User Authentication	SDK2	CTL*	[0 to 1 / 0 / 1/step]
5-420-071	User Authentication	SDK3	CTL*	[0 to 1 / 0 / 1/step]
5-420-081	User Authentication	Browser	CTL*	[0 to 1 / 0 / 1/step]
5-430-001	Auth Dialog Message Change	Message Change On/Off	CTL*	[0 to 1 / 0 / 1/step]
5-430-002	Auth Dialog Message Change	Message Text Download	CTL	[0 to 0 / 0 / 0/step]
5-430-003	Auth Dialog Message Change	Message Text ID	CTL	[0 to 0 / 0 / 0/step]
5-431-010	External Auth User Preset	Tag	CTL*	[0 to 1 / 1 / 1/step]

3.SP Mode Tables

SP No.	Large Category	Small Category	ENG or CTL	[Min to Max/Init./Step]
5-431-011	External Auth User Preset	Entry	CTL*	[0 to 1 / 1 / 1/step]
5-431-012	External Auth User Preset	Group	CTL*	[0 to 1 / 1 / 1/step]
5-431-020	External Auth User Preset	Mail	CTL*	[0 to 1 / 1 / 1/step]
5-431-030	External Auth User Preset	Fax	CTL*	[0 to 1 / 1 / 1/step]
5-431-031	External Auth User Preset	FaxSub	CTL*	[0 to 1 / 1 / 1/step]
5-431-032	External Auth User Preset	Folder	CTL*	[0 to 1 / 1 / 1/step]
5-431-033	External Auth User Preset	ProtectCode	CTL*	[0 to 1 / 1 / 1/step]
5-431-034	External Auth User Preset	SmtplAuth	CTL*	[0 to 1 / 1 / 1/step]
5-431-035	External Auth User Preset	LdapAuth	CTL*	[0 to 1 / 1 / 1/step]
5-431-036	External Auth User Preset	Smb Ftp Fldr Auth	CTL*	[0 to 1 / 1 / 1/step]
5-431-037	External Auth User Preset	AcntAcl	CTL*	[0 to 1 / 1 / 1/step]
5-431-038	External Auth User Preset	DocumentAcl	CTL*	[0 to 1 / 1 / 1/step]

3.SP Mode Tables

SP No.	Large Category	Small Category	ENG or CTL	[Min to Max/Init./Step]
5-431-040	External Auth User Preset	CertCrypt	CTL*	[0 to 1 / 0 / 1/step]
5-431-050	External Auth User Preset	UserLimitCount	CTL*	[0 to 1 / 1 / 1/step]
5-481-001	Authentication Error Code	System Log Disp	CTL*	[0 to 1 / 0 / 1/step]
5-481-002	Authentication Error Code	Panel Disp	CTL*	[0 to 1 / 1 / 1/step]
5-490-001	MF KeyCard	Job Permit Setting	CTL*	[0 to 1 / 0 / 1/step]
5-490-002	MF KeyCard	Count Mode Setting	CTL*	[0 to 1 / 0 / 1/step]
5-491-001	Optional Counter	Detail Option	CTL*	[0 to 0xff / 0 / 1/step]
5-501-001	PM Alarm	PM Alarm Level	CTL*	[0 to 9999 / 0 / 1/step]
5-504-001	Jam Alarm		CTL*	[0 to 3 / 3 / 1/step]
5-504-002	Jam Alarm	Threshold	CTL*	[1 to 99 / 10 / 1/step]
5-505-001	Error Alarm		CTL*	IM C3000: [0 to 255 / 25 / 1/step] IM C3500: [0 to 255 / 35 / 1/step] IM C2000: [0 to 255 / 15 / 1/step]

3.SP Mode Tables

SP No.	Large Category	Small Category	ENG or CTL	[Min to Max/Init./Step]
				IM C2500: [0 to 255 / 20 / 1/step] IM C4500: [0 to 255 / 50 / 1/step] IM C5500: [0 to 255 / 60 / 1/step] IM C6000: [0 to 255 / 75 / 1/step]
5-505-002	Error Alarm	Threshold	CTL*	[1 to 99 / 5 / 1/step]
5-507-001	Supply/CC Alarm	Paper Supply Alarm	CTL*	[0 to 1 / 0 / 1/step]
5-507-002	Supply/CC Alarm	Staple Supply Alarm	CTL*	[0 to 1 / 1 / 1/step]
5-507-003	Supply/CC Alarm	Toner Supply Alarm	CTL*	[0 to 1 / 1 / 1/step]
5-507-005	Supply/CC Alarm	DrumLifeRemain Supply Alarm	CTL*	[0 to 1 / 1 / 1/step]
5-507-006	Supply/CC Alarm	WasteTonerBottle	CTL*	[0 to 2 / 1 / 1/step]
5-507-007	Supply/CC Alarm	Tensya Supply Alarm	CTL*	[0 to 1 / 1 / 1/step]
5-507-008	Supply/CC Alarm	Fuser Supply Alarm	CTL*	[0 to 1 / 0 / 1/step]
5-507-013	Supply/CC Alarm	FuserBelt Supply Alarm	CTL*	[0 to 1 / 0 / 1/step]
5-	Supply/CC Alarm	WasteTonerBottle Call Timing	CTL*	[0 to 2 / 2 / 1/step]

3.SP Mode Tables

SP No.	Large Category	Small Category	ENG or CTL	[Min to Max/Init./Step]
507-070				
5-507-080	Supply/CC Alarm	Toner Call Timing	CTL*	[0 to 1 / 0 / 1/step]
5-507-081	Supply/CC Alarm	Toner Call Threshold:Bk	CTL*	[10 to 90 / 50 / 10%/step]
5-507-082	Supply/CC Alarm	Toner Call Threshold:CMY	CTL*	[10 to 90 / 50 / 10%/step]
5-507-128	Supply/CC Alarm	Interval: Others	CTL*	[250 to 10000 / 1000 / 1/step]
5-507-132	Supply/CC Alarm	Interval: A3	CTL*	[250 to 10000 / 1000 / 1/step]
5-507-133	Supply/CC Alarm	Interval: A4	CTL*	[250 to 10000 / 1000 / 1/step]
5-507-134	Supply/CC Alarm	Interval: A5	CTL*	[250 to 10000 / 1000 / 1/step]
5-507-141	Supply/CC Alarm	Interval: B4	CTL*	[250 to 10000 / 1000 / 1/step]
5-507-142	Supply/CC Alarm	Interval: B5	CTL*	[250 to 10000 / 1000 / 1/step]
5-507-160	Supply/CC Alarm	Interval: DLT	CTL*	[250 to 10000 / 1000 / 1/step]
5-507-164	Supply/CC Alarm	Interval: LG	CTL*	[250 to 10000 / 1000 / 1/step]

3.SP Mode Tables

SP No.	Large Category	Small Category	ENG or CTL	[Min to Max/Init./Step]
5-507-166	Supply/CC Alarm	Interval: LT	CTL*	[250 to 10000 / 1000 / 1/step]
5-507-172	Supply/CC Alarm	Interval: HLT	CTL*	[250 to 10000 / 1000 / 1/step]
5-508-001	CC Call	Jam Remains	CTL*	[0 to 1 / 1 / 1/step]
5-508-002	CC Call	Continuous Jams	CTL*	[0 to 1 / 1 / 1/step]
5-508-003	CC Call	Continuous Door Open	CTL*	[0 to 1 / 1 / 1/step]
5-508-011	CC Call	Jam Detection: Time Length	CTL*	[3 to 30 / 10 / 1/step]
5-508-012	CC Call	Jam Detection: Continuous Count	CTL*	[2 to 10 / 5 / 1/step]
5-508-013	CC Call	Door Open: Time Length	CTL*	[3 to 30 / 10 / 1/step]
5-513-001	PartsAlermlevelCount	Normal	CTL*	[1 to 9999 / 300 / 1/step]
5-513-002	PartsAlermlevelCount	Df	CTL*	[1 to 9999 / 300 / 1/step]
5-514-001	PartsAlermlev	Normal	CTL*	[0 to 1 / 1 / 1/step]
5-514-002	PartsAlermlev	Df	CTL*	[0 to 1 / 0 / 1/step]

3.SP Mode Tables

SP No.	Large Category	Small Category	ENG or CTL	[Min to Max/Init./Step]
5-515-001	SC/Alarm Setting	SC Call	CTL*	[0 to 1 / 1 / 1/step]
5-515-002	SC/Alarm Setting	Service Parts Near End Call	CTL*	[0 to 1 / 1 / 1/step]
5-515-003	SC/Alarm Setting	Service Parts End Call	CTL*	[0 to 1 / 1 / 1/step]
5-515-004	SC/Alarm Setting	User Call	CTL*	[0 to 1 / 1 / 1/step]
5-515-006	SC/Alarm Setting	Communication Test Call	CTL*	[0 to 1 / 1 / 1/step]
5-515-007	SC/Alarm Setting	Machine Information Notice	CTL*	[0 to 1 / 1 / 1/step]
5-515-008	SC/Alarm Setting	Alarm Notice	CTL*	[0 to 1 / 1 / 1/step]
5-515-009	SC/Alarm Setting	Non Genuine Tonner Ararm	CTL*	[0 to 1 / 1 / 1/step]
5-515-010	SC/Alarm Setting	Supply Automatic Ordering Call	CTL*	[0 to 1 / 1 / 1/step]
5-515-011	SC/Alarm Setting	Supply Management Report Call	CTL*	[0 to 1 / 1 / 1/step]
5-515-012	SC/Alarm Setting	Jam/Door Open Call	CTL*	[0 to 1 / 1 / 1/step]
5-515-050	SC/Alarm Setting	Timeout:Manual Call	CTL*	[1 to 255 / 5 / 1min/step]

3.SP Mode Tables

SP No.	Large Category	Small Category	ENG or CTL	[Min to Max/Init./Step]
5-515-051	SC/Alarm Setting	Timeout:Other Call	CTL*	[1 to 255 / 10 / 1min/step]
5-517-061	Get Machine Information	AutoDiscovery Execution Setting	CTL	[0 to 1 / 0 / 1/step]
5-517-062	Get Machine Information	AutoDiscovery Execution Interval	CTL	[0 to 1 / 0 / 1/step]
5-517-063	Get Machine Information	AutoDiscovery Execution Weekday	CTL	[0 to 6 / 0 / 1/step]
5-517-064	Get Machine Information	AutoDiscovery Execution Hour	CTL	[0 to 23 / 0 / 1/step]
5-517-065	Get Machine Information	AutoDiscovery Execution Minute	CTL	[0 to 59 / 0 / 1/step]
5-517-066	Get Machine Information	AutoDiscovery SNMP Community Name	CTL	[0 to 0 / 0 / 0/step]
5-517-100	Get Machine Information	GetLog:NotificationSetting	CTL*	[0 to 1 / 0 / 1/step]
5-618-001	Color Mode Display Selection		CTL*	[0 to 1 / 0 / 1/step]
5-713-001	Service Branch Information (IM C3500/C3000/C2500/C2000 only)	Service Branch Information Code	CTL*	[0 to 0 / 0 / 0/step]
5-728-001	Network Setting	NAT Machine Port1	CTL*	[1 to 65535 / 49101 / 1/step]
5-728-	Network Setting	NAT UI Port1	CTL*	[1 to 65535 / 55101 / 1/step]

3.SP Mode Tables

SP No.	Large Category	Small Category	ENG or CTL	[Min to Max/Init./Step]
002				
5-728-003	Network Setting	NAT Machine Port2	CTL*	[1 to 65535 / 49102 / 1/step]
5-728-004	Network Setting	NAT UI Port2	CTL*	[1 to 65535 / 55102 / 1/step]
5-728-005	Network Setting	NAT Machine Port3	CTL*	[1 to 65535 / 49103 / 1/step]
5-728-006	Network Setting	NAT UI Port3	CTL*	[1 to 65535 / 55103 / 1/step]
5-728-007	Network Setting	NAT Machine Port4	CTL*	[1 to 65535 / 49104 / 1/step]
5-728-008	Network Setting	NAT UI Port4	CTL*	[1 to 65535 / 55104 / 1/step]
5-728-009	Network Setting	NAT Machine Port5	CTL*	[1 to 65535 / 49105 / 1/step]
5-728-010	Network Setting	NAT UI Port5	CTL*	[1 to 65535 / 55105 / 1/step]
5-728-011	Network Setting	NAT Machine Port6	CTL*	[1 to 65535 / 49106 / 1/step]
5-728-012	Network Setting	NAT UI Port6	CTL*	[1 to 65535 / 55106 / 1/step]
5-728-013	Network Setting	NAT Machine Port7	CTL*	[1 to 65535 / 49107 / 1/step]
5-	Network Setting	NAT UI Port7	CTL*	[1 to 65535 /

3.SP Mode Tables

SP No.	Large Category	Small Category	ENG or CTL	[Min to Max/Init./Step]
728-014				55107 / 1/step]
5-728-015	Network Setting	NAT Machine Port8	CTL*	[1 to 65535 / 49108 / 1/step]
5-728-016	Network Setting	NAT UI Port8	CTL*	[1 to 65535 / 55108 / 1/step]
5-728-017	Network Setting	NAT Machine Port9	CTL*	[1 to 65535 / 49109 / 1/step]
5-728-018	Network Setting	NAT UI Port9	CTL*	[1 to 65535 / 55109 / 1/step]
5-728-019	Network Setting	NAT Machine Port10	CTL*	[1 to 65535 / 49110 / 1/step]
5-728-020	Network Setting	NAT UI Port10	CTL*	[1 to 65535 / 55110 / 1/step]
5-728-101	Network Setting	PacketCapture	CTL	[0 to 1 / 0 / 1/step]
5-728-102	Network Setting	PacketCapture:mode	CTL	[0 to 1 / 0 / 1/step]
5-728-103	Network Setting	PacketCapture:interface	CTL	[0 to 3 / 0 / 1/step]
5-728-104	Network Setting	PacketCapture:length	CTL	[54 to 65535 / 128 / 1/step]
5-728-105	Network Setting	PacketCapture:broadcast	CTL	[0 to 1 / 0 / 1/step]

3.SP Mode Tables

SP No.	Large Category	Small Category	ENG or CTL	[Min to Max/Init./Step]
5-728-106	Network Setting	PacketCapture:specify port	CTL	[0 to 1 / 0 / 1/step]
5-728-107	Network Setting	PacketCapture:portnumber	CTL	[0 to 65535 / 0 / 1/step]
5-728-108	Network Setting	PacketCapture:time	CTL	[0 to 0xffffffff / 0 / 1/step]
5-729-013	Print Server	Active IPv6 Link Local Address	CTL	[0 to 0 / 0 / 0/step]
5-729-014	Print Server	IPv6 Stateless Auto Setting	CTL	[0 to 1 / 1 / 1/step]
5-729-015	Print Server	Active IPv6 Stateless Address 1	CTL	[0 to 0 / 0 / 0/step]
5-729-016	Print Server	Active IPv6 Stateless Address 2	CTL	[0 to 0 / 0 / 0/step]
5-729-019	Print Server	IPv6 Manual Address	CTL*	[0 to 0 / 0 / 0/step]
5-729-020	Print Server	IPv6 Gateway Address	CTL*	[0 to 0 / 0 / 0/step]
5-730-010	Extended Function Setting	Expiration Prior Alarm Set	CTL*	[0 to 999 / 20 / 1days/step]
5-731-001	Counter Effect	Change Mk1 Cnt(Paper->Combine)	CTL*	[0 to 1 / 0 / 1/step]
5-732-002	Reset Job After Jam(Copy)		CTL*	[0 to 1 / 0 / 1/step]

3.SP Mode Tables

SP No.	Large Category	Small Category	ENG or CTL	[Min to Max/Init./Step]
5-734-001	PDF Setting	PDF/A Fixed	CTL*	[0 to 1 / 0 / 1/step]
5-745-211	DeemedPowerConsumption	Controller Standby	CTL*	[0 to 9999 / 0 / 1/step]
5-745-212	DeemedPowerConsumption	STR	CTL*	[0 to 9999 / 0 / 1/step]
5-745-213	DeemedPowerConsumption	Main Power Off	CTL*	[0 to 9999 / 0 / 1/step]
5-745-214	DeemedPowerConsumption	Scanning and Printing	CTL*	[0 to 9999 / 0 / 1/step]
5-745-215	DeemedPowerConsumption	Printing	CTL*	[0 to 9999 / 0 / 1/step]
5-745-216	DeemedPowerConsumption	Scanning	CTL*	[0 to 9999 / 0 / 1/step]
5-745-217	DeemedPowerConsumption	Engine Standby	CTL*	[0 to 9999 / 0 / 1/step]
5-745-218	DeemedPowerConsumption	Low Power Consumption	CTL*	[0 to 9999 / 0 / 1/step]
5-745-219	DeemedPowerConsumption	Silent condition	CTL*	[0 to 9999 / 0 / 1/step]
5-745-220	DeemedPowerConsumption	Heater Off	CTL*	[0 to 9999 / 0 / 1/step]
5-748-101	OpePanel Setting	Op Type Action Setting	CTL	[0 to 255 / 0 / 1/step]

3.SP Mode Tables

SP No.	Large Category	Small Category	ENG or CTL	[Min to Max/Init./Step]
5-748-102	OpePanel Setting	External Controller Action Setting	CTL*	[0 to 255 / 0 / 1/step]
5-748-201	OpePanel Setting	Cheetah Panel Connect Setting	CTL*	[0 to 1 / 0 / 1/step]
5-749-001	Import/Export	Export	CTL	[0 to 0 / 0 / 0/step]
5-749-101	Import/Export	Import	CTL	[0 to 0 / 0 / 0/step]
5-752-001	Copy:WebAPI Setting	Copy:FlairAPI Setting	CTL*	[0 to 255 / 0 / 1/step]
5-755-001	Display Setting	Disp Administrator Password Change Scrn	CTL*	[0 to 0 / 0 / 0/step]
5-755-002	Display Setting	Hide Administrator Password Change Scrn	CTL	[0 to 0 / 0 / 0/step]
5-758-001	RemoteUI Setting	Authentication	CTL*	[0 to 1 / 0 / 1/step]
5-759-001	Machine Limit Count	Machine Limit Count Setting	CTL*	[0 to 1 / 0 / 1/step]
5-759-061	Machine Limit Count	Full Color Limit Count	CTL*	[0 to 99999999 / 0 / 1/step]
5-759-062	Machine Limit Count	Mono Color Limit Count	CTL*	[0 to 99999999 / 0 / 1/step]
5-760-001	PaaS	Status	CTL*	[0 to 1 / 0 / 1/step]

3.SP Mode Tables

SP No.	Large Category	Small Category	ENG or CTL	[Min to Max/Init./Step]
5-760-002	PaaS	Enter PaaS Mode	CTL	[0 to 1 / 0 / 1/step]
5-760-003	PaaS	Contract ID	CTL*	[0 to 0 / 0 / 0/step]
5-760-004	PaaS	Authentication Key	CTL*	[0 to 0 / 0 / 0/step]
5-760-005	PaaS	Server Name	CTL*	[0 to 0 / 0 / 0/step]
5-760-006	PaaS	Server URL Path	CTL*	[0 to 0 / 0 / 0/step]
5-760-007	PaaS	Server Port Number	CTL*	[1 to 65535 / 443 / 1/step]
5-760-008	PaaS	Contract Status	CTL*	[0 to 1 / 0 / 1/step]
5-760-009	PaaS	Registration	CTL	[0 to 1 / 0 / 1/step]
5-760-010	PaaS	Unregistration	CTL	[0 to 1 / 0 / 1/step]
5-760-011	PaaS	Overwrite Registration on Server	CTL	[0 to 1 / 0 / 1/step]
5-760-012	PaaS	Execution Return Code	CTL	[0 to 255 / 0 / 1/step]
5-760-013	PaaS	Error Code	CTL	[0 to 0xffffffff / 0 / 1/step]

3.SP Mode Tables

SP No.	Large Category	Small Category	ENG or CTL	[Min to Max/Init./Step]
5-760-014	PaaS	3G Signal Error	CTL	[0 to 0 / 0 / 0/step]
5-760-015	PaaS	Use Proxy	CTL*	[0 to 1 / 0 / 1/step]
5-760-016	PaaS	Proxy Server	CTL*	[0 to 0 / 0 / 0/step]
5-760-017	PaaS	Proxy Port Number	CTL*	[0 to 65535 / 0 / 1/step]
5-760-018	PaaS	Proxy User Name	CTL*	[0 to 0 / 0 / 0/step]
5-760-019	PaaS	Proxy User Password	CTL*	[0 to 0 / 0 / 0/step]
5-760-020	PaaS	Retry Interval	CTL*	[0 to 65535 / 5 / 1sec/step]
5-760-021	PaaS	Retry Count	CTL*	[0 to 255 / 3 / 1/step]
5-760-022	PaaS	Device Information Call	CTL	[0 to 1 / 0 / 1/step]
5-760-023	PaaS	Next Update Time	CTL*	[0 to 0 / 0 / 1/step]
5-760-024	PaaS	Enter Normal Mode	CTL	[0 to 1 / 0 / 1/step]
5-760-025	PaaS	Prescribed Print Sheet No/Page	CTL	[0 to 99999999 / 0 / 1/step]

3.SP Mode Tables

SP No.	Large Category	Small Category	ENG or CTL	[Min to Max/Init./Step]
5-760-027	PaaS	Permit Setting	CTL*	[0 to 3 / 0 / 1/step]
5-760-028	PaaS	Selection Country	CTL*	[0 to 1 / 0 / 1/step]
5-761-001	SmartOperationPanel Setting	Restore the default Home screen	CTL	[0 to 255 / 0 / 1/step]
5-761-007	SmartOperationPanel Setting	Introduction Setting Boot Mode	CTL*	[0 to 255 / 0 / 1/step]
5-764-001	NFC Setting	GuestNetwork	CTL*	[0 to 1 / 0 / 1/step]
5-764-002	NFC Setting	Encrypted Communication Permission	CTL*	[0 to 1 / 0 / 1/step]
5-764-003	NFC Setting	Access Port1	CTL*	[0 to 65535 / 8081 / 1/step]
5-764-004	NFC Setting	Access Port2	CTL*	[0 to 65535 / 8080 / 1/step]
5-764-005	NFC Setting	Access Port3	CTL*	[0 to 65535 / 80 / 1/step]
5-801-001	Memory Clear	All Clear	CTL	[0 to 0 / 0 / 0/step]
5-801-003	Memory Clear	SCS	CTL	[0 to 0 / 0 / 0/step]
5-801-004	Memory Clear	IMH Memory Clr	CTL*	[0 to 0 / 0 / 0/step]

3.SP Mode Tables

SP No.	Large Category	Small Category	ENG or CTL	[Min to Max/Init./Step]
5-801-005	Memory Clear	MCS	CTL	[0 to 0 / 0 / 0/step]
5-801-006	Memory Clear	Copier application	CTL	[0 to 0 / 0 / 0/step]
5-801-007	Memory Clear	Fax Application	CTL	[0 to 0 / 0 / 0/step]
5-801-008	Memory Clear	Printer Application	CTL	[0 to 0 / 0 / 0/step]
5-801-009	Memory Clear	Scanner Application	CTL	[0 to 0 / 0 / 0/step]
5-801-010	Memory Clear	Web Service	CTL	[0 to 0 / 0 / 0/step]
5-801-011	Memory Clear	NCS	CTL	[0 to 0 / 0 / 0/step]
5-801-012	Memory Clear	R-FAX	CTL	[0 to 0 / 0 / 0/step]
5-801-014	Memory Clear	Clear DCS Setting	CTL*	[0 to 0 / 0 / 0/step]
5-801-015	Memory Clear	Clear UCS Setting	CTL*	[0 to 0 / 0 / 0/step]
5-801-016	Memory Clear	MIRS Setting	CTL*	[0 to 0 / 0 / 0/step]
5-801-017	Memory Clear	CCS	CTL	[0 to 0 / 0 / 0/step]

3.SP Mode Tables

SP No.	Large Category	Small Category	ENG or CTL	[Min to Max/Init./Step]
5-801-018	Memory Clear	SRM Memory Clr	CTL	[0 to 0 / 0 / 0/step]
5-801-019	Memory Clear	LCS	CTL*	[0 to 0 / 0 / 0/step]
5-801-020	Cleae Memory	Web Uapli	CTL	[0 to 0 / 0 / 0/step]
5-801-021	Memory Clear	ECS	CTL	[0 to 0 / 0 / 0/step]
5-801-023	Memory Clear	AICS	CTL*	[0 to 0 / 0 / 0/step]
5-801-025	Cleae Memory	websys	CTL	[0 to 0 / 0 / 0/step]
5-801-027	Memory Clear	SAS	CTL*	[0 to 0 / 0 / 0/step]
5-801-028	Memory Clear	Rest WebService	CTL*	[0 to 0 / 0 / 0/step]
5-801-030	Memory Clear	Clear DFE Setting	CTL	[0 to 0 / 0 / 0/step]
5-812-001	Service Tel. No. Setting	Service	CTL*	[0 to 0 / 0 / 0/step]
5-812-002	Service Tel. No. Setting	Facsimile	CTL*	[0 to 0 / 0 / 0/step]
5-812-003	Service Tel. No. Setting	Supply	CTL*	[0 to 0 / 0 / 0/step]

3.SP Mode Tables

SP No.	Large Category	Small Category	ENG or CTL	[Min to Max/Init./Step]
5-812-004	Service Tel. No. Setting	Operation	CTL*	[0 to 0 / 0 / 0/step]
5-816-001	Remote Service	I/F Setting	CTL*	[0 to 2 / 2 / 1/step]
5-816-002	Remote Service	CE Call	CTL*	[0 to 1 / 0 / 1/step]
5-816-003	Remote Service	Function Flag	CTL*	[0 to 1 / 0 / 1/step]
5-816-007	Remote Service	SSL Disable	CTL*	[0 to 1 / 0 / 1/step]
5-816-008	Remote Service	RCG Connect Timeout	CTL*	[1 to 90 / 30 / 1sec/step]
5-816-009	Remote Service	RCG Write Timeout	CTL*	[0 to 100 / 60 / 1sec/step]
5-816-010	Remote Service	RCG Read Timeout	CTL*	[0 to 100 / 60 / 1sec/step]
5-816-011	Remote Service	Port 80 Enable	CTL*	[0 to 1 / 0 / 1/step]
5-816-013	Remote Service	RFU Timing	CTL*	[0 to 1 / 1 / 1/step]
5-816-014	Remote Service	RCG Error Cause	CTL*	[0 to 2 / 0 / 1/step]
5-816-102	Remote Service	CERT:Encrypt Level	CTL*	[1 to 2 / 1 / 1/step]

3.SP Mode Tables

SP No.	Large Category	Small Category	ENG or CTL	[Min to Max/Init./Step]
5-816-103	Remote Service	Client Communication Method	CTL*	[0 to 3 / 0 / 1/step]
5-816-104	Remote Service	Client Communication Limit	CTL*	[1 to 7 / 7 / 1/step]
5-816-115	Remote Service	Network Information Waiting timer	CTL*	[5 to 255 / 5 / 1sec/step]
5-816-150	Remote Service	Selection Country	CTL*	NA: [0 to 10 / 1 / 1/step] EU: [0 to 10 / 3 / 1/step] AS: [0 to 10 / 0 / 1/step] CHN: [0 to 10 / 0 / 1/step] TWN: [0 to 10 / 0 / 1/step] KOR: [0 to 10 / 0 / 1/step]
5-816-151	Remote Service	Line Type Automatic Judgement	CTL	[0 to 1 / 0 / 1/step]
5-816-152	Remote Service	Line Type Judgement Result	CTL	[0 to 255 / 0 / 0/step]
5-816-153	Remote Service	Selection Dial / Push	CTL*	NA: [0 to 1 / 0 / 0/step] EU: [0 to 1 / 0 / 0/step] AS: [0 to 2 / 0 / 0/step] CHN: [0 to 2 / 0 / 0/step] TWN: [0 to 2 / 0 /

3.SP Mode Tables

SP No.	Large Category	Small Category	ENG or CTL	[Min to Max/Init./Step]
				0/step] KOR: [0 to 2 / 0 / 0/step]
5-816-154	Remote Service	Outside Line Outgoing Number	CTL*	[0 to 0 / 0 / 0/step]
5-816-156	Remote Service	Dial Up User Name	CTL*	[0 to 0 / 0 / 0/step]
5-816-157	Remote Service	Dial Up Password	CTL*	[0 to 0 / 0 / 0/step]
5-816-161	Remote Service	Local Phone Number	CTL*	[0 to 0 / 0 / 0/step]
5-816-162	Remote Service	Connection Timing Adjustment Incoming	CTL*	[0 to 24 / 1 / 1/step]
5-816-163	Remote Service	Access Point	CTL*	[0 to 0 / 0 / 0/step]
5-816-164	Remote Service	Line Connecting	CTL*	[0 to 1 / 0 / 1/step]
5-816-173	Remote Service	Modem Serial No.	CTL*	[0 to 0 / 0 / 0/step]
5-816-174	Remote Service	Retransmission Limit	CTL	[0 to 1 / 0 / 1/step]
5-816-187	Remote Service	FAX TX Priority	CTL*	[0 to 1 / 0 / 1/step]
5-816-190	Remote Service	3G DongleID	CTL*	[0 to 0 / 0 / 0/step]

3.SP Mode Tables

SP No.	Large Category	Small Category	ENG or CTL	[Min to Max/Init./Step]
5-816-209	Remote Service	Instl Clear	CTL	[0 to 1 / 0 / 1/step]
5-821-002	Remote Service RCG Setting	RCG IPv4 Address	CTL*	[0 to 0xffffffff / 0 / 1/step]
5-821-003	Remote Service RCG Setting	RCG Port	CTL*	[0 to 65535 / 443 / 1/step]
5-821-004	Remote Service RCG Setting	RCG IPv4 URL Path	CTL*	[0 to 0 / 0 / 0/step]
5-821-005	Remote Service RCG Setting	RCG IPv6 Address	CTL*	[0 to 0 / 0 / 0/step]
5-821-006	Remote Service RCG Setting	RCG IPv6 URL Path	CTL*	[0 to 0 / 0 / 0/step]
5-821-007	Remote Service RCG Setting	RCG Host Name	CTL*	[0 to 0 / 0 / 0/step]
5-821-008	Remote Service RCG Setting	RCG Host URL Path	CTL*	[0 to 0 / 0 / 0/step]
5-824-001	NV-RAM Data Upload		CTL	[0 to 0 / 0 / 0/step]
5-825-001	NV-RAM Data Download		CTL	[0 to 0 / 0 / 0/step]
5-828-039	Network Setting	User Class	CTL*	[0 to 0 / 0 / 0/step]
5-828-040	Network Setting	Class Id	CTL*	[0 to 0 / 0 / 0/step]

3.SP Mode Tables

SP No.	Large Category	Small Category	ENG or CTL	[Min to Max/Init./Step]
5-828-050	Network Setting	1284 Compatibility (Centro)	CTL*	[0 to 1 / 1 / 1/step]
5-828-052	Network Setting	ECP (Centro)	CTL*	[0 to 1 / 1 / 1/step]
5-828-065	Network Setting	Job Spooling	CTL*	[0 to 1 / 0 / 1/step]
5-828-066	Network Setting	Job Spooling Clear: Start Time	CTL*	[0 to 1 / 1 / 1/step]
5-828-069	Network Setting	Job Spooling (Protocol)	CTL*	[0x00 to 0xff / 0x7f / 0/step]
5-828-087	Network Setting	Protocol usage	CTL*	[0x00000000 to 0xffffffff / 0x00000000 / 1/step]
5-828-090	Network Setting	TELNET(0:OFF 1:ON)	CTL*	[0 to 1 / 1 / 1/step]
5-828-091	Network Setting	Web(0:OFF 1:ON)	CTL*	[0 to 1 / 1 / 1/step]
5-828-145	Network Setting	Active IPv6 Link Local Address	CTL	[0 to 0 / 0 / 0/step]
5-828-147	Network Setting	Active IPv6 Stateless Address 1	CTL	[0 to 0 / 0 / 0/step]
5-828-149	Network Setting	Active IPv6 Stateless Address 2	CTL	[0 to 0 / 0 / 0/step]
5-828-	Network Setting	Active IPv6 Stateless Address 3	CTL	[0 to 0 / 0 / 0/step]

3.SP Mode Tables

SP No.	Large Category	Small Category	ENG or CTL	[Min to Max/Init./Step]
151				
5-828-153	Network Setting	Active IPv6 Stateless Address 4	CTL	[0 to 0 / 0 / 0/step]
5-828-155	Network Setting	Active IPv6 Stateless Address 5	CTL	[0 to 0 / 0 / 0/step]
5-828-156	Network Setting	IPv6 Manual Address	CTL*	[0 to 0 / 0 / 0/step]
5-828-158	Network Setting	IPv6 Gateway Address	CTL*	[0 to 0 / 0 / 0/step]
5-828-161	Network Setting	IPv6 Stateless Auto Setting	CTL*	[0 to 1 / 1 / 1/step]
5-828-219	Network Setting	IPsec Aggressive Mode Setting	CTL*	[0 to 1 / 0 / 1/step]
5-828-236	Network Setting	Web Item visible	CTL*	[0x0000 to 0xffff / 0xffff / 1/step]
5-828-237	Network Setting	Web shopping link visible	CTL*	[0 to 1 / 1 / 1/step]
5-828-238	Network Setting	Web Supplies Link visible	CTL*	[0 to 1 / 1 / 1/step]
5-828-239	Network Setting	Web Link1 Name	CTL*	[0 to 0 / 0 / 0/step]
5-828-240	Network Setting	Web Link1 URL	CTL*	[0 to 0 / 0 / 0/step]
5-	Network Setting	Web Link1 visible	CTL*	[0 to 1 / 1 / 1/step]

3.SP Mode Tables

SP No.	Large Category	Small Category	ENG or CTL	[Min to Max/Init./Step]
828-241				
5-828-242	Network Setting	Web Link2 Name	CTL*	[0 to 0 / 0 / 0/step]
5-828-243	Network Setting	Web Link2 URL	CTL*	[0 to 0 / 0 / 0/step]
5-828-244	Network Setting	Web Link2 visible	CTL*	[0 to 1 / 1 / 1/step]
5-828-249	Network Setting	DHCPv6 DUID	CTL	[0 to 0 / 0 / 0/step]
5-832-001	HDD	HDD Formatting (ALL)	CTL	[0 to 0 / 0 / 0/step]
5-832-002	HDD	HDD Formatting (IMH)	CTL	[0 to 0 / 0 / 0/step]
5-832-003	HDD	HDD Formatting (Thumbnail/OCR)	CTL	[0 to 0 / 0 / 0/step]
5-832-004	HDD	HDD Formatting (Job Log)	CTL	[0 to 0 / 0 / 0/step]
5-832-005	HDD	HDD Formatting (Printer Fonts)	CTL	[0 to 0 / 0 / 0/step]
5-832-006	HDD	HDD Formatting (User Info)	CTL	[0 to 0 / 0 / 0/step]
5-832-007	HDD	Mail RX Data	CTL	[0 to 0 / 0 / 0/step]

3.SP Mode Tables

SP No.	Large Category	Small Category	ENG or CTL	[Min to Max/Init./Step]
5-832-008	HDD	Mail TX Data	CTL	[0 to 0 / 0 / 0/step]
5-832-009	HDD	HDD Formatting (Data for a Design)	CTL	[0 to 0 / 0 / 0/step]
5-832-010	HDD	HDD Formatting (Log)	CTL	[0 to 0 / 0 / 0/step]
5-832-011	HDD	HDD Formatting (Ridoc I/F)	CTL	[0 to 0 / 0 / 0/step]
5-832-012	HDD	HDD Formatting (Thumbnail)	CTL	[0 to 0 / 0 / 0/step]
5-836-001	Capture Setting	Capture Function (0:Off 1:On)	CTL*	[0 to 1 / 0 / 1/step]
5-836-011	Capture Setting	Capture Setting: Copy	CTL*	[0 to 1 / 0 / 1/step]
5-836-012	Capture Setting	Capture Setting: Doc. Svr.	CTL*	[0 to 1 / 0 / 1/step]
5-836-013	Capture Setting	Capture Setting: Fax RX Printer	CTL*	[0 to 1 / 0 / 1/step]
5-836-014	Capture Setting	Capture Setting: Fax TX	CTL*	[0 to 1 / 0 / 1/step]
5-836-015	Capture Setting	Capture Setting: Printer	CTL*	[0 to 1 / 0 / 1/step]
5-836-016	Capture Setting	Capture Setting: Scanner	CTL*	[0 to 1 / 0 / 1/step]

3.SP Mode Tables

SP No.	Large Category	Small Category	ENG or CTL	[Min to Max/Init./Step]
5-836-017	Capture Setting	Capture Setting: SDK	CTL*	[0 to 1 / 0 / 1/step]
5-836-061	Capture Setting	Captured File Resend (0:Off 1:On)	CTL*	[0 to 1 / 1 / 1/step]
5-836-071	Capture Setting	Reduction for Copy Color	CTL*	[0 to 3 / 2 / 1/step]
5-836-072	Capture Setting	Reduction for Copy B&W Text	CTL*	[0 to 6 / 0 / 1/step]
5-836-073	Capture Setting	Reduction for Copy B&W Other	CTL*	[0 to 6 / 0 / 1/step]
5-836-074	Capture Setting	Reduction for Printer Color	CTL*	[0 to 3 / 2 / 1/step]
5-836-075	Capture Setting	Reduction for Printer B&W	CTL*	[0 to 6 / 0 / 1/step]
5-836-077	Capture Setting	Reduction for Printer Color 1200dpi	CTL*	[1 to 5 / 4 / 1/step]
5-836-078	Capture Setting	Reduction for Printer B&W 1200dpi	CTL*	[1 to 5 / 1 / 1/step]
5-836-081	Capture Setting	Format for Copy Color	CTL*	[0 to 0 / 0 / 1/step]
5-836-082	Capture Setting	Format for Copy B&W Text	CTL*	[0 to 3 / 1 / 1/step]
5-836-083	Capture Setting	Format for Copy B&W Other	CTL*	[0 to 3 / 1 / 1/step]

3.SP Mode Tables

SP No.	Large Category	Small Category	ENG or CTL	[Min to Max/Init./Step]
5-836-084	Capture Setting	Format for Printer Color	CTL*	[0 to 0 / 0 / 1/step]
5-836-085	Capture Setting	Format for Printer B&W	CTL*	[0 to 3 / 1 / 1/step]
5-836-091	Capture Setting	Default for JPEG	CTL*	[5 to 95 / 50 / 1/step]
5-836-101	Capture Setting	Primary srv IP address	CTL*	[0 to 0xffffffff / 0x00 / 0/step]
5-836-102	Capture Setting	Primary srv scheme	CTL*	[0 to 0 / 0 / 0/step]
5-836-103	Capture Setting	Primary srv port number	CTL*	[1 to 65535 / 80 / 1/step]
5-836-104	Capture Setting	Primary srv URL path	CTL*	[0 to 0 / 0 / 0/step]
5-836-111	Capture Setting	Secondary srv IP address	CTL*	[0 to 0xffffffff / 0x00 / 0/step]
5-836-112	Capture Setting	Secondary srv scheme	CTL*	[0 to 0 / 0 / 0/step]
5-836-113	Capture Setting	Secondary srv port number	CTL*	[1 to 65535 / 80 / 1/step]
5-836-114	Capture Setting	Secondary srv URL path	CTL*	[0 to 0 / 0 / 0/step]
5-836-120	Capture Setting	Default Reso Rate Switch	CTL*	[0 to 1 / 0 / 1/step]

3.SP Mode Tables

SP No.	Large Category	Small Category	ENG or CTL	[Min to Max/Init./Step]
5-836-121	Capture Setting	Reso: Copy(Color)	CTL*	[0 to 255 / 2 / 1/step]
5-836-122	Capture Setting	Reso: Copy(Mono)	CTL*	[0 to 255 / 3 / 1/step]
5-836-123	Capture Setting	Reso: Print(Color)	CTL*	[0 to 255 / 2 / 1/step]
5-836-124	Capture Setting	Reso: Print(Mono)	CTL*	[0 to 255 / 3 / 1/step]
5-836-125	Capture Setting	Reso: Fax(Color)	CTL*	[0 to 255 / 4 / 1/step]
5-836-126	Capture Setting	Reso: Fax(Mono)	CTL*	[0 to 255 / 3 / 1/step]
5-836-127	Capture Setting	Reso: Scan(Color)	CTL*	[0 to 255 / 4 / 1/step]
5-836-128	Capture Setting	Reso: Scan(Mono)	CTL*	[0 to 255 / 3 / 1/step]
5-836-129	Capture Setting	Reso: SDK(Color)	CTL*	[0 to 255 / 4 / 1/step]
5-836-130	Capture Setting	Reso: SDK(Mono)	CTL*	[0 to 255 / 3 / 1/step]
5-836-141	Capture Setting	All Addr Info Switch	CTL*	[0 to 1 / 1 / 1/step]
5-836-142	Capture Setting	Stand-by Doc Max Number	CTL*	[10 to 10000 / 2000 / 1/step]

3.SP Mode Tables

SP No.	Large Category	Small Category	ENG or CTL	[Min to Max/Init./Step]
5-836-143	Capture Setting	ClearLightPDF Switch	CTL*	[0 to 1 / 0 / 1/step]
5-840-006	IEEE 802.11	Channel MAX	CTL*	[1 to 14 / 14 / 1/step]
5-840-007	IEEE 802.11	Channel MIN	CTL*	[1 to 14 / 1 / 1/step]
5-840-011	IEEE 802.11	WEP Key Select	CTL*	[0x00 to 0x11 / 0x00 / 0/step]
5-840-045	IEEE 802.11	WPA Debug Lvl	CTL*	[1 to 3 / 3 / 1/step]
5-840-046	IEEE 802.11	11w	CTL*	[0 to 2 / 0 / 1/step]
5-840-047	IEEE 802.11	PSK Set Type	CTL*	[0 to 1 / 0 / 1/step]
5-841-001	Supply Name Setting	Toner Name Setting: Black	CTL*	[0 to 0 / 0 / 0/step]
5-841-002	Supply Name Setting	Toner Name Setting: Cyan	CTL*	[0 to 0 / 0 / 0/step]
5-841-003	Supply Name Setting	Toner Name Setting: Yellow	CTL*	[0 to 0 / 0 / 0/step]
5-841-004	Supply Name Setting	Toner Name Setting: Magenta	CTL*	[0 to 0 / 0 / 0/step]
5-841-007	Supply Name Setting	OrgStamp	CTL*	[0 to 0 / 0 / 0/step]

3.SP Mode Tables

SP No.	Large Category	Small Category	ENG or CTL	[Min to Max/Init./Step]
5-841-009	Supply Name Setting	WasteTonerBottle	CTL*	[0 to 0 / 0 / 0/step]
5-841-011	Supply Name Setting	StapleStd1	CTL*	[0 to 0 / 0 / 0/step]
5-841-012	Supply Name Setting	StapleStd2	CTL*	[0 to 0 / 0 / 0/step]
5-841-013	Supply Name Setting	StapleStd3	CTL*	[0 to 0 / 0 / 0/step]
5-841-014	Supply Name Setting	StapleStd4	CTL*	[0 to 0 / 0 / 0/step]
5-841-021	Supply Name Setting	StapleBind1	CTL*	[0 to 0 / 0 / 0/step]
5-841-022	Supply Name Setting	StapleBind2	CTL*	[0 to 0 / 0 / 0/step]
5-841-023	Supply Name Setting	StapleBind3	CTL*	[0 to 0 / 0 / 0/step]
5-842-001	GWWS Analysis	Setting 1	CTL*	[0x00 to 0xFF / 0 / 1/step]
5-842-002	GWWS Analysis	Setting 2	CTL*	[0x00 to 0xFF / 0 / 1/step]
5-844-001	USB	Transfer Rate	CTL*	[1 to 4 / 4 / 0/step]
5-844-002	USB	Vendor ID	CTL*	[0x0000 to 0xffff / 0x05ca / 0/step]

3.SP Mode Tables

SP No.	Large Category	Small Category	ENG or CTL	[Min to Max/Init./Step]
5-844-003	USB	Product ID	CTL*	[0x0000 to 0xffff / 0x0403 / 0/step]
5-844-004	USB	Device Release Number	CTL*	[0 to 9999 / 100 / 1/step]
5-844-005	USB	Fixed USB Port	CTL*	[0 to 2 / 0 / 1/step]
5-844-006	USB	PnP Model Name	CTL*	[0 to 0 / 0 / 0/step]
5-844-007	USB	PnP Serial Number	CTL*	[0 to 0 / 0 / 0/step]
5-844-008	USB	Mac Supply Level	CTL*	[0 to 1 / 1 / 1/step]
5-844-009	USB	USB Toggle Clear Mode	CTL*	[0 to 1 / 0 / 1/step]
5-844-100	USB	Notify Unsupport	CTL*	[0 to 1 / 1 / 1/step]
5-845-001	Delivery Server Setting	FTP Port No.	CTL*	[1 to 65535 / 3670 / 1/step]
5-845-002	Delivery Server Setting	IP Address (Primary)	CTL*	[0 to 0xffffffff / 0x00 / -/step]
5-845-006	Delivery Server Setting	Delivery Error Display Time	CTL*	[0 to 999 / 300 / 1sec/step]
5-845-008	Delivery Server Setting	IP Address (Secondary)	CTL*	[0 to 0xffffffff / 0x00 / -/step]

3.SP Mode Tables

SP No.	Large Category	Small Category	ENG or CTL	[Min to Max/Init./Step]
5-845-009	Delivery Server Setting	Delivery Server Model	CTL*	[0 to 4 / 0 / 1/step]
5-845-010	Delivery Server Setting	Delivery Svr. Capability	CTL*	[0 to 255 / 0 / 1/step]
5-845-011	Delivery Server Setting	Delivery Svr. Capability (Ext)	CTL*	[0 to 255 / 0 / 1/step]
5-845-013	Delivery Server Setting	Server Scheme(Primary)	CTL*	[0 to 0 / 0 / 0/step]
5-845-014	Delivery Server Setting	Server Port Number(Primary)	CTL*	[1 to 65535 / 80 / 1/step]
5-845-015	Delivery Server Setting	Server URL Path(Primary)	CTL*	[0 to 0 / 0 / 0/step]
5-845-016	Delivery Server Setting	Server Scheme(Secondary)	CTL*	[0 to 0 / 0 / 0/step]
5-845-017	Delivery Server Setting	Server Port Number(Secondary)	CTL*	[1 to 65535 / 80 / 1/step]
5-845-018	Delivery Server Setting	Server URL Path(Secondary)	CTL*	[0 to 0 / 0 / 0/step]
5-845-022	Delivery Server Setting	Rapid Sending Control	CTL*	[0 to 1 / 1 / 1/step]
5-846-001	UCS Setting	Machine ID (for Delivery Server)	CTL*	[0 to 0 / 0 / 0/step]
5-846-002	UCS Setting	Machine ID Clear (for Delivery Server)	CTL*	[0 to 0 / 0 / 0/step]

3.SP Mode Tables

SP No.	Large Category	Small Category	ENG or CTL	[Min to Max/Init./Step]
5-846-003	UCS Setting	Maximum Entries	CTL*	[2000 to 20000 / 2000 / 1/step]
5-846-006	UCS Setting	Delivery Server Retry Timer	CTL*	[0 to 255 / 0 / 1/step]
5-846-007	UCS Setting	Delivery Server Retry Times	CTL*	[0 to 255 / 0 / 1/step]
5-846-008	UCS Setting	Delivery Server Maximum Entries	CTL*	[2000 to 20000 / 2000 / 1/step]
5-846-010	UCS Setting	LDAP Search Timeout	CTL*	[1 to 255 / 60 / 1/step]
5-846-020	UCS Setting	WSD Maximum Entries	CTL*	[50 to 250 / 250 / 1/step]
5-846-021	UCS Setting	Folder Auth Change	CTL*	[0 to 1 / 0 / 1/step]
5-846-040	UCS Setting	Addr Book Migration(USB->HDD)	CTL*	[0 to 0 / 0 / 0/step]
5-846-041	UCS Setting	Fill Addr Acl Info	CTL*	[0 to 0 / 0 / 0/step]
5-846-043	UCS Setting	Addr Book Media	CTL*	[0 to 30 / 0 / 1/step]
5-846-047	UCS Setting	Initialize Local Addr Book	CTL*	[0 to 0 / 0 / 0/step]
5-846-048	UCS Setting	Initialize Delivery Addr Book	CTL*	[0 to 0 / 0 / 0/step]

3.SP Mode Tables

SP No.	Large Category	Small Category	ENG or CTL	[Min to Max/Init./Step]
5-846-049	UCS Setting	Initialize LDAP Addr Book	CTL*	[0 to 0 / 0 / 0/step]
5-846-050	UCS Setting	Initialize All Addr Book	CTL*	[0 to 0 / 0 / 0/step]
5-846-051	UCS Setting	Backup All Addr Book	CTL*	[0 to 0 / 0 / 0/step]
5-846-052	UCS Setting	Restore All Addr Book	CTL*	[0 to 0 / 0 / 0/step]
5-846-053	UCS Setting	Clear Backup Info	CTL*	[0 to 0 / 0 / 0/step]
5-846-060	UCS Setting	Search option	CTL*	[0x00 to 0xff / 0x0f / 1/step]
5-846-062	UCS Setting	Complexity option 1	CTL*	[0 to 32 / 0 / 1/step]
5-846-063	UCS Setting	Complexity option 2	CTL*	[0 to 32 / 0 / 1/step]
5-846-064	UCS Setting	Complexity option 3	CTL*	[0 to 32 / 0 / 1/step]
5-846-065	UCS Setting	Complexity option 4	CTL*	[0 to 32 / 0 / 1/step]
5-846-091	UCS Setting	FTP Auth Port Setting	CTL*	[0 to 65535 / 3671 / 1/step]
5-846-094	UCS Setting	Encryption Stat	CTL*	[0 to 255 / 0 / 0/step]

3.SP Mode Tables

SP No.	Large Category	Small Category	ENG or CTL	[Min to Max/Init./Step]
5-846-100	UCS Setting	Initialize Suprvisor	CTL	[0 to 0 / 0 / 0/step]
5-847-001	Rep Resolution Reduction	Rate for Copy Color	CTL*	[0 to 5 / 2 / 1/step]
5-847-002	Rep Resolution Reduction	Rate for Copy B&W Text	CTL*	[0 to 6 / 0 / 1/step]
5-847-003	Rep Resolution Reduction	Rate for Copy B&W Other	CTL*	[0 to 6 / 0 / 1/step]
5-847-004	Rep Resolution Reduction	Rate for Printer Color	CTL*	[0 to 5 / 2 / 1/step]
5-847-005	Rep Resolution Reduction	Rate for Printer B&W	CTL*	[0 to 6 / 0 / 1/step]
5-847-006	Rep Resolution Reduction	Rate for Printer Color 1200dpi	CTL*	[0 to 5 / 4 / 1/step]
5-847-007	Rep Resolution Reduction	Rate for Printer B&W 1200dpi	CTL*	[0 to 6 / 1 / 1/step]
5-847-021	Rep Resolution Reduction	Network Quality Default for JPEG	CTL*	[5 to 95 / 50 / 1/step]
5-848-002	Web Service	Access Ctrl: Repository(onlyLower4bits)	CTL*	[0x00 to 0xFF / 0x02 / 0/step]
5-848-003	Web Service	Access Ctrl: Doc.Svr.Print (Lower 4bits)	CTL*	[0x00 to 0xFF / 0x00 / 0/step]
5-848-004	Web Service	Access Ctrl: uirectory (Lower 4bits)	CTL*	[0x00 to 0xFF / 0x00 / 0/step]

3.SP Mode Tables

SP No.	Large Category	Small Category	ENG or CTL	[Min to Max/Init./Step]
5-848-007	Web Service	Access Ctrl: Comm. Log Fax(Lower 4bits)	CTL*	[0x00 to 0xFF / 0x00 / 0/step]
5-848-009	Web Service	Access Ctrl: Job Ctrl (Lower 4bits)	CTL*	[0x00 to 0xFF / 0x00 / 0/step]
5-848-011	Web Service	Access Ctrl: Devicemanagement(Lower 4bits)	CTL*	[0x00 to 0xFF / 0x00 / 0/step]
5-848-021	Web Service	Access Ctrl: Delivery (Lower 4bits)	CTL*	[0x00 to 0xFF / 0x00 / 0/step]
5-848-022	Web Service	Access Ctrl: uadministration (Lower 4bits)	CTL*	[0x00 to 0xFF / 0x00 / 0/step]
5-848-024	Web Service	Access Ctrl: Log Service (Lower 4bits)	CTL*	[0x00 to 0xFF / 0x00 / 0/step]
5-848-025	Web Service	Access Ctrl: Rest WebService (Lower 4bits)	CTL*	[0x00 to 0xFF / 0x00 / 0/step]
5-848-045	Web Service	Reverse Proxy Server Setting(ESA Port)	CTL*	[0x00 to 0xFF / 0 / 1/step]
5-848-046	Web Service	8080/51443 Port Open Time	CTL*	[0 to 300 / 60 / 1/step]
5-848-099	Web Service	Repository: Download Image Setting	CTL*	[0x00 to 0xFF / 0x00 / 1/step]
5-848-100	Web Service	Repository: Download Image Max. Size	CTL*	[1 to 2048 / 2048 / 1/step]
5-848-150	Web Service	Log Operation Mode	CTL*	[0 to 9 / 0 / 1/step]

3.SP Mode Tables

SP No.	Large Category	Small Category	ENG or CTL	[Min to Max/Init./Step]
5-848-217	LogTrans	Setting: Timing	CTL*	[0 to 2 / 0 / 1/step]
5-848-218	SysLogTrans	Setting: Timing	CTL	[0 to 1 / 0 / 1/step]
5-848-220	SysLogTrans	Primary srv port number	CTL	[1 to 65535 / 80 / 1/step]
5-848-221	SysLogTrans	Check Cert	CTL	[0 to 1 / 0 / 1/step]
5-849-001	Installation Date	Display	CTL*	[0 to 0 / 0 / 0/step]
5-849-002	Installation Date	Switch to Print	CTL*	[0 to 1 / 0 / 1/step]
5-849-003	Installation Date	Total Counter	CTL*	[0 to 99999999 / 0 / 1/step]
5-850-003	Address Book Function	Replacement of Circuit Classifications	CTL	[0 to 0 / 0 / 0/step]
5-851-001	Bluetooth	Mode	CTL*	[0x00 to 0x01 / 0x00 / 1/step]
5-853-001	Stamp Data Download		CTL	[0 to 0 / 0 / 0/step]
5-856-002	Remote ROM Update	Local Port	CTL	[0 to 1 / 0 / 1/step]
5-858-001	Collect Machine Info	0:OFF 1:ON	CTL	[0 to 1 / 1 / 1/step]

3.SP Mode Tables

SP No.	Large Category	Small Category	ENG or CTL	[Min to Max/Init./Step]
5-858-002	Collect Machine Info	Save To (0:HDD 1:SD)	CTL	[0 to 1 / 0 / 1/step]
5-858-003	Collect Machine Info	Make Log Trace Dir	CTL	[0 to 1 / 0 / 0/step]
5-858-101	Collect Machine Info	Failure Occuring Date	CTL	[0 to 20371212 / 0 / 1/step]
5-858-102	Collect Machine Info	Tracing Days	CTL	[1 to 180 / 2 / 1day/step]
5-858-103	Collect Machine Info	Acquire Fax Address(0:OFF 1:ON)	CTL	[0 to 1 / 0 / 1/step]
5-858-111	Collect Machine Info	Acquire All Info & Logs	CTL	[0 to 1 / 0 / 0/step]
5-858-121	Collect Machine Info	Acquire Configuration Page	CTL	[0 to 1 / 0 / 0/step]
5-858-122	Collect Machine Info	Acquire Font Page	CTL	[0 to 1 / 0 / 0/step]
5-858-123	Collect Machine Info	Acquire Print Setting List	CTL	[0 to 1 / 0 / 0/step]
5-858-124	Collect Machine Info	Acquire Error Log	CTL	[0 to 1 / 0 / 0/step]
5-858-131	Collect Machine Info	Acquire Fax Info	CTL	[0 to 1 / 0 / 0/step]
5-858-141	Collect Machine Info	Acquire All Debug Logs	CTL	[0 to 1 / 0 / 0/step]

3.SP Mode Tables

SP No.	Large Category	Small Category	ENG or CTL	[Min to Max/Init./Step]
5-858-142	Collect Machine Info	Acquire Controller Debug Logs Only	CTL	[0 to 1 / 0 / 0/step]
5-858-143	Collect Machine Info	Acquire Engine Debug Logs Only	CTL	[0 to 1 / 0 / 0/step]
5-858-144	Collect Machine Info	Acquire Opepanel Debug Logs Only	CTL	[0 to 1 / 0 / 0/step]
5-858-145	Collect Machine Info	Acquire FCU Debug Logs Only	CTL	[0 to 1 / 0 / 0/step]
5-858-146	Collect Machine Info	Acquire Only Network Packets	CTL	[0 to 1 / 0 / 0/step]
5-860-020	SMTP/POP3/IMAP4	Partial Mail Receive Timeout	CTL*	[1 to 168 / 72 / 1hour/step]
5-860-021	SMTP/POP3/IMAP4	MDN Response RFC2298 Compliance	CTL*	[0 to 1 / 1 / 1/step]
5-860-022	SMTP/POP3/IMAP4	SMTP Auth. From Field Replacement	CTL*	[0 to 1 / 0 / 1/step]
5-860-025	SMTP/POP3/IMAP4	SMTP Auth. Direct Setting	CTL*	[0 to 0xff / 0x0 / 1/step]
5-860-026	SMTP/POP3/IMAP4	S/MIME:MIME Header Setting	CTL*	[0 to 2 / 0 / 1/step]
5-860-028	SMTP/POP3/IMAP4	S/MIME: Authentication Check	CTL*	[0 to 1 / 0 / 1/step]
5-860-029	SMTP/POP3/IMAP4	SMTP Server 3G Line IP Address	CTL*	[0 to 0xffffffff / 0x00 / -/step]

3.SP Mode Tables

SP No.	Large Category	Small Category	ENG or CTL	[Min to Max/Init./Step]
5-861-201	Account Setting	Send Domain1	CTL	[0 to 0 / 0 / 0/step]
5-861-202	Account Setting	Send Domain2	CTL	[0 to 0 / 0 / 0/step]
5-861-203	Account Setting	Send Domain3	CTL	[0 to 0 / 0 / 0/step]
5-866-001	E-Mail Report	Report Validity	CTL	[0 to 1 / 0 / 1/step]
5-866-005	E-Mail Report	Add Date Field	CTL*	[0 to 1 / 0 / 1/step]
5-866-109	E-Mail Report	CounterE-Mail:3G Line Validity	CTL*	[0 to 1 / 0 / 1/step]
5-866-110	E-Mail Report	CounterE-Mail:Validity	CTL*	[0 to 1 / 0 / 1/step]
5-866-111	E-Mail Report	CounterE-Mail:Destination Registration	CTL*	[0 to 0 / 0 / 0/step]
5-866-112	E-Mail Report	CounterE-Mail:Send Test	CTL*	[0 to 0 / 0 / 0/step]
5-866-113	E-Mail Report	CounterE-Mail:Next Send Date	CTL*	[0 to 0 / 0 / 0/step]
5-866-114	E-Mail Report	CounterE-Mail:Send Date Setting	CTL*	[0 to 31 / 0 / 1/step]
5-866-115	E-Mail Report	CounterE-Mail:Send Time Setting	CTL*	[0 to 2359 / 0 / 1/step]

3.SP Mode Tables

SP No.	Large Category	Small Category	ENG or CTL	[Min to Max/Init./Step]
5-866-121	E-Mail Report	CounterE-Mail:Destination1	CTL*	[0 to 0 / 0 / 0/step]
5-866-122	E-Mail Report	CounterE-Mail:Destination2	CTL*	[0 to 0 / 0 / 0/step]
5-866-123	E-Mail Report	CounterE-Mail:Destination3	CTL*	[0 to 0 / 0 / 0/step]
5-870-001	Common KeyInfo Writing	Writing	CTL	[0 to 1 / 0 / 1/step]
5-870-003	Common KeyInfo Writing	Initialize	CTL	[0 to 1 / 0 / 1/step]
5-870-004	Common Key Info Writing	Writing: 2048bit	CTL	[0 to 1 / 0 / 1/step]
5-873-001	SDCardAppliMove	MoveExec	CTL	[0 to 0 / 0 / 1/step]
5-873-002	SDCardAppliMove	UndoExec	CTL	[0 to 0 / 0 / 1/step]
5-875-001	SC Auto Reboot	Reboot Setting	CTL*	[0 to 1 / 0 / 1/step]
5-875-002	SC Auto Reboot	Reboot Type	CTL*	[0 to 1 / 0 / 1/step]
5-878-001	Option Setup	Data Overwrite Security	CTL	[0 to 0 / 0 / 0/step]
5-878-002	Option Setup	HDD Encryption	CTL	[0 to 0 / 0 / 0/step]

3.SP Mode Tables

SP No.	Large Category	Small Category	ENG or CTL	[Min to Max/Init./Step]
5-878-004	Option Setup	OCR Dictionary	CTL	[0 to 0 / 0 / 0/step]
5-881-001	Fixed Phrase Block Erasing		CTL	[0 to 0 / 0 / 0/step]
5-885-020	Set WIM Function	DocSvr Acc Ctrl	CTL*	[0x00 to 0xFF / 0x00 / 0/step]
5-885-050	Set WIM Function	DocSvr Format	CTL*	[0 to 2 / 0 / 1/step]
5-885-051	Set WIM Function	DocSvr Trans	CTL*	[5 to 20 / 10 / 1/step]
5-885-100	Set WIM Function	Set Signature	CTL*	[0 to 2 / 0 / 1/step]
5-885-101	Set WIM Function	Set Encrypsion	CTL*	[0 to 1 / 0 / 1/step]
5-885-200	Set WIM Function	Detect Mem Leak	CTL*	[0x00 to 0xFF / 0x00 / 0/step]
5-885-205	Set WIM Function	MonitorDisable	CTL*	[0 to 1 / 0 / 1/step]
5-886-100	Farm Update Setting	Skip Version Check	CTL	[0 to 1 / 0 / 1/step]
5-886-101	Farm Update Setting	Skip LR Check	CTL	[0 to 1 / 0 / 1/step]
5-886-111	Farm Update Setting	Auto Update Setting	CTL*	[0 to 1 / 0 / 1/step]

3.SP Mode Tables

SP No.	Large Category	Small Category	ENG or CTL	[Min to Max/Init./Step]
5-886-112	Farm Update Setting	Auto Update Prohibit Term Setting	CTL*	[0 to 1 / 1 / 1/step]
5-886-113	Farm Update Setting	Auto Update Prohibit Start hour	CTL*	[0 to 23 / 9 / 1hour/step]
5-886-114	Farm Update Setting	Auto Update Prohibit End hour	CTL*	[0 to 23 / 17 / 1hour/step]
5-886-115	Farm Update Setting	SFU Auto Download Setting	CTL*	[0 to 1 / 0 / 1/step]
5-886-116	Farm Update Setting	Auto Update Next Date	CTL*	[0 to 0 / 0 / 0/step]
5-886-117	Farm Update Setting	Auto Update Retry Interval Hour	CTL*	[1 to 24 / 1 / 1hour/step]
5-886-120	Farm Update Setting	Auto Update Prohibit Day of Week Setting	CTL*	[0 to 255 / 0 / 1/step]
5-886-151	Farm Update Setting	Permit SubId Update	CTL*	[0 to 1 / 0 / 1/step]
5-886-201	Farm Update Setting	Restore Date	CTL*	[0 to 0 / 0 / 0/step]
5-886-202	Farm Update Setting	Save Old Version List	CTL	[0 to 0 / 0 / 0/step]
5-887-001	SD GetCounter		CTL	[0 to 0 / 0 / 0/step]
5-888-001	Personal Information Protect		CTL*	[0 to 1 / 0 / 1/step]

3.SP Mode Tables

SP No.	Large Category	Small Category	ENG or CTL	[Min to Max/Init./Step]
5-893-001	SDK Application Counter	SDK-1	CTL	[0 to 0 / 0 / 0/step]
5-893-002	SDK Application Counter	SDK-2	CTL	[0 to 0 / 0 / 0/step]
5-893-003	SDK Application Counter	SDK-3	CTL	[0 to 0 / 0 / 0/step]
5-893-004	SDK Application Counter	SDK-4	CTL	[0 to 0 / 0 / 0/step]
5-893-005	SDK Application Counter	SDK-5	CTL	[0 to 0 / 0 / 0/step]
5-893-006	SDK Application Counter	SDK-6	CTL	[0 to 0 / 0 / 0/step]
5-893-007	SDK Application Counter	SDK-7	CTL	[0 to 0 / 0 / 0/step]
5-893-008	SDK Application Counter	SDK-8	CTL	[0 to 0 / 0 / 0/step]
5-893-009	SDK Application Counter	SDK-9	CTL	[0 to 0 / 0 / 0/step]
5-893-010	SDK Application Counter	SDK-10	CTL	[0 to 0 / 0 / 0/step]
5-893-011	SDK Application Counter	SDK-11	CTL	[0 to 0 / 0 / 0/step]
5-893-012	SDK Application Counter	SDK-12	CTL	[0 to 0 / 0 / 0/step]

3.SP Mode Tables

SP No.	Large Category	Small Category	ENG or CTL	[Min to Max/Init./Step]
5-895-001	Application invalidation	Printer	CTL	[0 to 1 / 0 / 0/step]
5-895-002	Application invalidation	Scanner	CTL	[0 to 1 / 0 / 0/step]
5-907-001	Plug & Play Maker/Model Name		CTL*	[0 to 255 / 0 / 1/step]
5-913-002	Switchover Permission Time	Print Application Timer	CTL*	[0 to 30 / 3 / 1/step]
5-967-001	Copy Server : Set Function	(0:ON 1:OFF)	CTL*	[0 to 1 / 0 / 1/step]
5-973-101	User Stamp Registration	Frame deletion setting	CTL*	[0 to 3 / 0 / 1/step]
5-985-001	Device Setting	On Board NIC	CTL	[0 to 2 / 0 / 1/step]
5-985-002	Device Setting	On Board USB	CTL	[0 to 1 / 0 / 1/step]
5-990-001	SP Print Mode	All (Data List)	CTL	[0 to 255 / 0 / 0/step]
5-990-002	SP Print Mode	SP (Mode Data List)	CTL	[0 to 255 / 0 / 0/step]
5-990-003	SP Print Mode	User Program	CTL	[0 to 255 / 0 / 0/step]
5-990-004	SP Print Mode	Logging Data	CTL	[0 to 255 / 0 / 0/step]

3.SP Mode Tables

SP No.	Large Category	Small Category	ENG or CTL	[Min to Max/Init./Step]
5-990-005	SP Print Mode	Diagnostic Report	CTL	[0 to 255 / 0 / 0/step]
5-990-006	SP Print Mode	Non-Default	CTL	[0 to 255 / 0 / 0/step]
5-990-007	SP Print Mode	NIB Summary	CTL	[0 to 0 / 0 / 0/step]
5-990-008	SP Print Mode	Capture Log	CTL	[0 to 255 / 0 / 1/step]
5-990-021	SMC Print	Copier User Program	CTL	[0 to 0 / 0 / 0/step]
5-990-022	SP Print Mode	Scanner SP	CTL	[0 to 255 / 0 / 0/step]
5-990-023	SP Print Mode	Scanner User Program	CTL	[0 to 255 / 0 / 0/step]
5-990-024	SP Print Mode	SDK/J Summary	CTL	[0 to 0 / 0 / 0/step]
5-990-025	SP Print Mode	SDK/J Application Info	CTL	[0 to 0 / 0 / 0/step]
5-990-026	SP Print Mode	Printer SP	CTL	[0 to 255 / 0 / 0/step]
5-990-027	SP Print Mode	SmartOperationPanel SP	CTL	[0 to 255 / 0 / 0/step]
5-990-028	SP Print Mode	SmartOperationPanel UP	CTL	[0 to 255 / 0 / 0/step]

3.SP Mode Tables

SP No.	Large Category	Small Category	ENG or CTL	[Min to Max/Init./Step]
5-991-001	Kit Summary Print (IM C3500/C3000/C2500/C2000 only)		CTL	[0 to 0 / 0 / 0/step]
5-992-001	SP Text Mode	All (Data List)	CTL	[0 to 255 / 0 / 0/step]
5-992-002	SP Text Mode	SP (Mode Data List)	CTL	[0 to 255 / 0 / 0/step]
5-992-003	SP Text Mode	User Program	CTL	[0 to 255 / 0 / 0/step]
5-992-004	SP Text Mode	Logging Data	CTL	[0 to 255 / 0 / 0/step]
5-992-005	SP Text Mode	Diagnostic Report	CTL	[0 to 255 / 0 / 0/step]
5-992-006	SP Text Mode	Non-Default	CTL	[0 to 255 / 0 / 0/step]
5-992-007	SP Text Mode	NIB Summary	CTL	[0 to 0 / 0 / 0/step]
5-992-008	SP Text Mode	Capture Log	CTL	[0 to 255 / 0 / 1/step]
5-992-021	SP Text Mode	Copier User Program	CTL	[0 to 0 / 0 / 0/step]
5-992-022	SP Text Mode	Scanner SP	CTL	[0 to 255 / 0 / 0/step]
5-992-	SP Text Mode	Scanner User Program	CTL	[0 to 255 / 0 / 0/step]

3.SP Mode Tables

SP No.	Large Category	Small Category	ENG or CTL	[Min to Max/Init./Step]
023				
5-992-024	SP Text Mode	SDK/J Summary	CTL	[0 to 0 / 0 / 0/step]
5-992-025	SP Text Mode	SDK/J Application Info	CTL	[0 to 0 / 0 / 0/step]
5-992-026	SP Text Mode	Printer SP	CTL	[0 to 255 / 0 / 0/step]
5-992-027	SP Text Mode	SmartOperationPanel SP	CTL	[0 to 255 / 0 / 0/step]
5-992-028	SP Text Mode	SmartOperationPanel UP	CTL	[0 to 255 / 0 / 0/step]
5-993-001	SP Text Mode(Privacy)	All (Data List)	CTL*	[0 to 255 / 0 / 0/step]
5-993-002	SP Text Mode(Privacy)	SP (Mode Data List)	CTL*	[0 to 255 / 0 / 0/step]
5-993-003	SP Text Mode(Privacy)	User Program	CTL*	[0 to 255 / 0 / 0/step]
5-993-004	SP Text Mode(Privacy)	Logging Data	CTL*	[0 to 255 / 0 / 0/step]
5-993-005	SP Text Mode(Privacy)	Diagnostic Report	CTL*	[0 to 255 / 0 / 0/step]
5-993-006	SP Text Mode(Privacy)	Non-Default	CTL*	[0 to 255 / 0 / 0/step]
5-	SP Text Mode(Privacy)	NIB Summary	CTL*	[0 to 0 / 0 / 0/step]

3.SP Mode Tables

SP No.	Large Category	Small Category	ENG or CTL	[Min to Max/Init./Step]
993-007				
5-993-008	SP Text Mode(Privacy)	Capture Log	CTL*	[0 to 255 / 0 / 1/step]
5-993-021	SP Text Mode	Copier User Program	CTL*	[0 to 0 / 0 / 0/step]
5-993-022	SP Text Mode(Privacy)	Scanner SP	CTL*	[0 to 255 / 0 / 0/step]
5-993-023	SP Text Mode(Privacy)	Scanner User Program	CTL*	[0 to 255 / 0 / 0/step]
5-993-024	SP Text Mode(Privacy)	SDK/J Summary	CTL*	[0 to 0 / 0 / 0/step]
5-993-025	SP Text Mode(Privacy)	SDK/J Application Info	CTL*	[0 to 0 / 0 / 0/step]
5-993-026	SP Text Mode(Privacy)	Printer SP	CTL*	[0 to 255 / 0 / 0/step]
5-993-027	SP Text Mode(Privacy)	SmartOperationPanel SP	CTL*	[0 to 255 / 0 / 0/step]
5-993-028	SP Text Mode(Privacy)	SmartOperationPanel UP	CTL*	[0 to 255 / 0 / 0/step]

Controller SP Tables-6

SP6-XXX (XXX)

SP No.	Large Category	Small Category	ENG or CTL	[Min to Max/Init./Step]
6-830-	Extra	Staples 0 to 50 (Initial:0)	CTL*	[0 to 50 / 0 / 1/step]

3.SP Mode Tables

SP No.	Large Category	Small Category	ENG or CTL	[Min to Max/Init./Step]
001				
6-830-002	Extra	Saddles 0 to 50 (Initial:0)	CTL*	[0 to 50 / 0 / 1/step]
6-830-003	Extra	Half-Fold 0 to 50 (Initial:0)	CTL*	[0 to 50 / 0 / 1/step]
6-830-005	Extra	StaplessStaples 0 to 50 (Initial:0)	CTL*	[0 to 50 / 0 / 1/step]
6-890-001	Function Enabled	Z-Fold 0:No Punch 1:Punching OK	CTL	[0 to 1 / 1 / 1/step]

Controller SP Tables-7

SP7-XXX (Data Log)

SP No.	Large Category	Small Category	ENG or CTL	[Min to Max/Init./Step]
7-334-001	Function Use Count	Original Orientation	CTL*	[0 to 0xffffffff / 0 / 0/step]
7-334-002	Function Use Count	Reverse Orientation	CTL*	[0 to 0xffffffff / 0 / 0/step]
7-334-003	Function Use Count	All Job Stop	CTL*	[0 to 0xffffffff / 0 / 0/step]
7-334-004	Function Use Count	Copy Quality	CTL*	[0 to 0xffffffff / 0 / 0/step]
7-334-005	Function Use Count	Mag. FixRatio	CTL*	[0 to 0xffffffff / 0 / 0/step]
7-334-006	Function Use Count	Mag. Ratio	CTL*	[0 to 0xffffffff / 0 / 0/step]
7-334-007	Function Use Count	Size Mag.	CTL*	[0 to 0xffffffff / 0 / 0/step]
7-334-008	Function Use Count	Direct. Mag.	CTL*	[0 to 0xffffffff / 0 / 0/step]
7-334-009	Function Use Count	Dir. Size Mag.	CTL*	[0 to 0xffffffff / 0 / 0/step]
7-334-010	Function Use Count	Auto Reduce/Enlarge	CTL*	[0 to 0xffffffff / 0 / 0/step]
7-334-011	Function Use Count	Create Margin	CTL*	[0 to 0xffffffff / 0 / 0/step]

3.SP Mode Tables

SP No.	Large Category	Small Category	ENG or CTL	[Min to Max/Init./Step]
7-334-012	Function Use Count	OneSideDpx	CTL*	[0 to 0xffffffff / 0 / 0/step]
7-334-013	Function Use Count	Cover	CTL*	[0 to 0xffffffff / 0 / 0/step]
7-334-014	Function Use Count	Chapter	CTL*	[0 to 0xffffffff / 0 / 0/step]
7-334-015	Function Use Count	SlipSheet	CTL*	[0 to 0xffffffff / 0 / 0/step]
7-334-016	Function Use Count	EraseCenter	CTL*	[0 to 0xffffffff / 0 / 0/step]
7-334-017	Function Use Count	EraseFrame	CTL*	[0 to 0xffffffff / 0 / 0/step]
7-334-018	Function Use Count	MarginAdj	CTL*	[0 to 0xffffffff / 0 / 0/step]
7-334-019	Function Use Count	Centering	CTL*	[0 to 0xffffffff / 0 / 0/step]
7-334-020	Function Use Count	Double	CTL*	[0 to 0xffffffff / 0 / 0/step]
7-334-021	Function Use Count	Repeat	CTL*	[0 to 0xffffffff / 0 / 0/step]
7-334-022	Function Use Count	Mirror	CTL*	[0 to 0xffffffff / 0 / 0/step]
7-334-023	Function Use Count	Negative	CTL*	[0 to 0xffffffff / 0 / 0/step]
7-334-024	Function Use Count	NumBeringStmp	CTL*	[0 to 0xffffffff / 0 / 0/step]
7-334-025	Function Use Count	Stmp	CTL*	[0 to 0xffffffff / 0 / 0/step]
7-334-026	Function Use Count	UserStmp	CTL*	[0 to 0xffffffff / 0 / 0/step]
7-334-027	Function Use Count	DateStmp	CTL*	[0 to 0xffffffff / 0 / 0/step]
7-334-028	Function Use Count	PageStmp	CTL*	[0 to 0xffffffff / 0 / 0/step]
7-334-029	Function Use Count	CharStmp	CTL*	[0 to 0xffffffff / 0 / 0/step]

3.SP Mode Tables

SP No.	Large Category	Small Category	ENG or CTL	[Min to Max/Init./Step]
7-334-030	Function Use Count	CharNumStmp	CTL*	[0 to 0xffffffff / 0 / 0/step]
7-334-031	Function Use Count	JimonStmp	CTL*	[0 to 0xffffffff / 0 / 0/step]
7-334-032	Function Use Count	ReserveCopy	CTL*	[0 to 0xffffffff / 0 / 0/step]
7-334-033	Function Use Count	IntCopy	CTL*	[0 to 0xffffffff / 0 / 0/step]
7-334-034	Function Use Count	ProgrameCopy	CTL*	[0 to 0xffffffff / 0 / 0/step]
7-334-035	Function Use Count	CheckCopy	CTL*	[0 to 0xffffffff / 0 / 0/step]
7-334-036	Function Use Count	BackNum	CTL*	[0 to 0xffffffff / 0 / 0/step]
7-334-037	Function Use Count	FullColor	CTL*	[0 to 0xffffffff / 0 / 0/step]
7-334-038	Function Use Count	TwoColor	CTL*	[0 to 0xffffffff / 0 / 0/step]
7-334-039	Function Use Count	SingleColor	CTL*	[0 to 0xffffffff / 0 / 0/step]
7-334-040	Function Use Count	MonoColor	CTL*	[0 to 0xffffffff / 0 / 0/step]
7-334-041	Function Use Count	Acs	CTL*	[0 to 0xffffffff / 0 / 0/step]
7-334-042	Function Use Count	Accessibility	CTL*	[0 to 0xffffffff / 0 / 0/step]
7-334-043	Function Use Count	SmallSizeTray	CTL*	[0 to 0xffffffff / 0 / 0/step]
7-334-044	Function Use Count	Jewelry	CTL*	[0 to 0xffffffff / 0 / 0/step]
7-335-001	Total Job Count	LegacyCopy	CTL*	[0 to 0xffffffff / 0 / 0/step]
7-335-002	Total Job Count	SmartCopy	CTL*	[0 to 0xffffffff / 0 / 0/step]
7-335-003	Total Job Count	SmartCopy FullHouse	CTL*	[0 to 0xffffffff / 0 / 0/step]

3.SP Mode Tables

SP No.	Large Category	Small Category	ENG or CTL	[Min to Max/Init./Step]
7-335-004	Total Job Count	SimpleCopy	CTL*	[0 to 0xffffffff / 0 / 0/step]
7-335-005	Total Job Count	OtherCopy	CTL*	[0 to 0xffffffff / 0 / 0/step]
7-401-001	Total SC	SC Counter	CTL*	[0 to 65535 / 0 / 0/step]
7-401-002	Total SC	Total SC Counter	CTL*	[0 to 65535 / 0 / 0/step]
7-403-001	SC History	Latest	CTL*	[0 to 0 / 0 / 0/step]
7-403-002	SC History	Latest 1	CTL*	[0 to 0 / 0 / 0/step]
7-403-003	SC History	Latest 2	CTL*	[0 to 0 / 0 / 0/step]
7-403-004	SC History	Latest 3	CTL*	[0 to 0 / 0 / 0/step]
7-403-005	SC History	Latest 4	CTL*	[0 to 0 / 0 / 0/step]
7-403-006	SC History	Latest 5	CTL*	[0 to 0 / 0 / 0/step]
7-403-007	SC History	Latest 6	CTL*	[0 to 0 / 0 / 0/step]
7-403-008	SC History	Latest 7	CTL*	[0 to 0 / 0 / 0/step]
7-403-009	SC History	Latest 8	CTL*	[0 to 0 / 0 / 0/step]
7-403-010	SC History	Latest 9	CTL*	[0 to 0 / 0 / 0/step]
7-404-001	Software Error History	Latest	CTL*	[0 to 0 / 0 / 0/step]
7-404-002	Software Error History	Latest 1	CTL*	[0 to 0 / 0 / 0/step]
7-404-003	Software Error History	Latest 2	CTL*	[0 to 0 / 0 / 0/step]
7-404-004	Software Error History	Latest 3	CTL*	[0 to 0 / 0 / 0/step]

3.SP Mode Tables

SP No.	Large Category	Small Category	ENG or CTL	[Min to Max/Init./Step]
7-404-005	Software Error History	Latest 4	CTL*	[0 to 0 / 0 / 0/step]
7-404-006	Software Error History	Latest 5	CTL*	[0 to 0 / 0 / 0/step]
7-404-007	Software Error History	Latest 6	CTL*	[0 to 0 / 0 / 0/step]
7-404-008	Software Error History	Latest 7	CTL*	[0 to 0 / 0 / 0/step]
7-404-009	Software Error History	Latest 8	CTL*	[0 to 0 / 0 / 0/step]
7-404-010	Software Error History	Latest 9	CTL*	[0 to 0 / 0 / 0/step]
7-502-001	Total Paper Jam	Jam Counter	CTL*	[0 to 65535 / 0 / 0/step]
7-502-002	Total Paper Jam	Total Jam Counter	CTL*	[0 to 65535 / 0 / 0/step]
7-503-001	Total Original Jam	Original Jam Counter	CTL*	[0 to 65535 / 0 / 0/step]
7-503-002	Total Original Jam	Total Original Jam Counter	CTL*	[0 to 65535 / 0 / 0/step]
7-504-001	Paper Jam Location	At Power On	CTL*	[0 to 65535 / 0 / 0/step]
7-504-003	Paper Jam Location	Tray 1: On	CTL*	[0 to 65535 / 0 / 0/step]
7-504-004	Paper Jam Location	Tray 2: On	CTL*	[0 to 65535 / 0 / 0/step]
7-504-005	Paper Jam Location	Tray 3: On	CTL*	[0 to 65535 / 0 / 0/step]
7-504-006	Paper Jam Location	Tray 4: On	CTL*	[0 to 65535 / 0 / 0/step]
7-504-007	Paper Jam Location	LCT: On	CTL*	[0 to 65535 / 0 / 0/step]
7-504-008	Paper Jam Location	Bypass: On	CTL*	[0 to 65535 / 0 / 0/step]
7-504-009	Paper Jam Location	Duplex: On	CTL*	[0 to 65535 / 0 / 0/step]

3.SP Mode Tables

SP No.	Large Category	Small Category	ENG or CTL	[Min to Max/Init./Step]
7-504-011	Paper Jam Location	Transport Sensor 1: On	CTL*	[0 to 65535 / 0 / 0/step]
7-504-012	Paper Jam Location	Transport Sensor 2: On	CTL*	[0 to 65535 / 0 / 0/step]
7-504-013	Paper Jam Location	Vertical Trans. Sn 3: On	CTL*	[0 to 65535 / 0 / 0/step]
7-504-014	Paper Jam Location	Vertical Trans. Sn 4: On	CTL*	[0 to 65535 / 0 / 0/step]
7-504-015	Paper Jam Location	LCT Transport Sensor: On	CTL*	[0 to 65535 / 0 / 0/step]
7-504-017	Paper Jam Location	Registration Sensor: On	CTL*	[0 to 65535 / 0 / 0/step]
7-504-018	Paper Jam Location	Fusing Entrance Sensor: On	CTL*	[0 to 65535 / 0 / 0/step]
7-504-019	Paper Jam Location	Fusing Exit Sensor: On	CTL*	[0 to 65535 / 0 / 0/step]
7-504-020	Paper Jam Location	Paper Exit Sensor: On	CTL*	[0 to 65535 / 0 / 0/step]
7-504-021	Paper Jam Location	Bridge Exit Sensor: On	CTL*	[0 to 65535 / 0 / 0/step]
7-504-022	Paper Jam Location	Bridge Transport Sensor: On	CTL*	[0 to 65535 / 0 / 0/step]
7-504-024	Paper Jam Location	Inverter Sensor: On	CTL*	[0 to 65535 / 0 / 0/step]
7-504-025	Paper Jam Location	Duplex Exit Sensor: On	CTL*	[0 to 65535 / 0 / 0/step]
7-504-027	Paper Jam Location	Duplex Entrance Sensor: On	CTL*	[0 to 65535 / 0 / 0/step]
7-504-048	Paper Jam Location	Bypass Feed Sensor 1: On	CTL*	[0 to 65535 / 0 / 0/step]
7-504-051	Paper Jam Location	Transport Sensor 1: Off	CTL*	[0 to 65535 / 0 / 0/step]
7-504-052	Paper Jam Location	Transport Sensor 2: Off	CTL*	[0 to 65535 / 0 / 0/step]
7-504-053	Paper Jam Location	Vertical Trans. Sn 3: Off	CTL*	[0 to 65535 / 0 / 0/step]

3.SP Mode Tables

SP No.	Large Category	Small Category	ENG or CTL	[Min to Max/Init./Step]
7-504-054	Paper Jam Location	Vertical Trans. Sn 4: Off	CTL*	[0 to 65535 / 0 / 0/step]
7-504-057	Paper Jam Location	Registration Sensor: Off	CTL*	[0 to 65535 / 0 / 0/step]
7-504-058	Paper Jam Location	LCT Transport Sensor: Off	CTL*	[0 to 65535 / 0 / 0/step]
7-504-060	Paper Jam Location	Paper Exit Sensor: Off	CTL*	[0 to 65535 / 0 / 0/step]
7-504-061	Paper Jam Location	Bridge Exit Sensor: Off	CTL*	[0 to 65535 / 0 / 0/step]
7-504-062	Paper Jam Location	Bridge Transport Sensor: Off	CTL*	[0 to 65535 / 0 / 0/step]
7-504-064	Paper Jam Location	Inverter Sensor: Off	CTL*	[0 to 65535 / 0 / 0/step]
7-504-065	Paper Jam Location	Duplex Exit Sensor: Off	CTL*	[0 to 65535 / 0 / 0/step]
7-504-067	Paper Jam Location	Duplex Entrance Sensor: Off	CTL*	[0 to 65535 / 0 / 0/step]
7-504-096	Paper Jam Location	Timing Lose	CTL*	[0 to 65535 / 0 / 0/step]
7-504-100	Paper Jam Location	Entrance Sensor: On	CTL*	[0 to 65535 / 0 / 0/step]
7-504-101	Paper Jam Location	Entrance Sensor: Off	CTL*	[0 to 65535 / 0 / 0/step]
7-504-102	Paper Jam Location	Transport Sensor: On	CTL*	[0 to 65535 / 0 / 0/step]
7-504-103	Paper Jam Location	Transport Sensor: Off	CTL*	[0 to 65535 / 0 / 0/step]
7-504-104	Paper Jam Location	Paper Exit	CTL*	[0 to 65535 / 0 / 0/step]
7-504-105	Paper Jam Location	Front Jogger Motor	CTL*	[0 to 65535 / 0 / 0/step]
7-504-106	Paper Jam Location	Rear Jogger Motor	CTL*	[0 to 65535 / 0 / 0/step]
7-504-107	Paper Jam Location	Shift Roller Motor	CTL*	[0 to 65535 / 0 / 0/step]

3.SP Mode Tables

SP No.	Large Category	Small Category	ENG or CTL	[Min to Max/Init./Step]
7-504-108	Paper Jam Location	Positioning Roller Motor	CTL*	[0 to 65535 / 0 / 0/step]
7-504-109	Paper Jam Location	Exit Guide Plate Motor	CTL*	[0 to 65535 / 0 / 0/step]
7-504-110	Paper Jam Location	Stapler Movement Motor	CTL*	[0 to 65535 / 0 / 0/step]
7-504-111	Paper Jam Location	Shift Tray Lift Motor	CTL*	[0 to 65535 / 0 / 0/step]
7-504-112	Paper Jam Location	Staple Motor	CTL*	[0 to 65535 / 0 / 0/step]
7-504-113	Paper Jam Location	Paper Stopper Motor	CTL*	[0 to 65535 / 0 / 0/step]
7-504-114	Paper Jam Location	Punch Motor	CTL*	[0 to 65535 / 0 / 0/step]
7-504-115	Paper Jam Location	Punch Unit Movement Motor	CTL*	[0 to 65535 / 0 / 0/step]
7-504-116	Paper Jam Location	Horizontal Reg. Movement Motor	CTL*	[0 to 65535 / 0 / 0/step]
7-504-149	Paper Jam Location	Invalid Main Machine Data Setting	CTL*	[0 to 65535 / 0 / 0/step]
7-504-150	Paper Jam Location	Entrance Sensor: On	CTL*	[0 to 65535 / 0 / 0/step]
7-504-151	Paper Jam Location	Entrance Sensor: Off	CTL*	[0 to 65535 / 0 / 0/step]
7-504-152	Paper Jam Location	Horizontal Transport Sn: On	CTL*	[0 to 65535 / 0 / 0/step]
7-504-153	Paper Jam Location	Horizontal Transport Sn: Off	CTL*	[0 to 65535 / 0 / 0/step]
7-504-154	Paper Jam Location	Switchback Transport Sn: On	CTL*	[0 to 65535 / 0 / 0/step]
7-504-155	Paper Jam Location	Switchback Transport Sn: Off	CTL*	[0 to 65535 / 0 / 0/step]
7-504-156	Paper Jam Location	Proof Tray Exit: On	CTL*	[0 to 65535 / 0 / 0/step]
7-504-157	Paper Jam Location	Proof Tray Exit: Off	CTL*	[0 to 65535 / 0 / 0/step]

3.SP Mode Tables

SP No.	Large Category	Small Category	ENG or CTL	[Min to Max/Init./Step]
7-504-158	Paper Jam Location	Shift Tray Exit: On	CTL*	[0 to 65535 / 0 / 0/step]
7-504-159	Paper Jam Location	Shift Tray Exit: Off	CTL*	[0 to 65535 / 0 / 0/step]
7-504-160	Paper Jam Location	Booklet Stapler Exit: On	CTL*	[0 to 65535 / 0 / 0/step]
7-504-161	Paper Jam Location	Booklet Stapler Exit: Off	CTL*	[0 to 65535 / 0 / 0/step]
7-504-162	Paper Jam Location	Entrance Transport Motor	CTL*	[0 to 65535 / 0 / 0/step]
7-504-163	Paper Jam Location	Horizontal Transport Motor	CTL*	[0 to 65535 / 0 / 0/step]
7-504-164	Paper Jam Location	Pre-Stack Transport Motor	CTL*	[0 to 65535 / 0 / 0/step]
7-504-165	Paper Jam Location	Intermediate Transport Motor	CTL*	[0 to 65535 / 0 / 0/step]
7-504-166	Paper Jam Location	Paper Exit Motor	CTL*	[0 to 65535 / 0 / 0/step]
7-504-167	Paper Jam Location	Trailing Edge Stopper Motor	CTL*	[0 to 65535 / 0 / 0/step]
7-504-168	Paper Jam Location	Paper Exit Guide Plate Motor	CTL*	[0 to 65535 / 0 / 0/step]
7-504-169	Paper Jam Location	Punch Unit Drive Motor	CTL*	[0 to 65535 / 0 / 0/step]
7-504-170	Paper Jam Location	Punch Unit Movement Motor	CTL*	[0 to 65535 / 0 / 0/step]
7-504-171	Paper Jam Location	S-to-S Regist Move Motor	CTL*	[0 to 65535 / 0 / 0/step]
7-504-172	Paper Jam Location	Lower Junction Gate Motor	CTL*	[0 to 65535 / 0 / 0/step]
7-504-173	Paper Jam Location	Jogger Motor	CTL*	[0 to 65535 / 0 / 0/step]
7-504-174	Paper Jam Location	Positioning Roller Drive Motor	CTL*	[0 to 65535 / 0 / 0/step]
7-504-175	Paper Jam Location	Feed Out Motor	CTL*	[0 to 65535 / 0 / 0/step]

3.SP Mode Tables

SP No.	Large Category	Small Category	ENG or CTL	[Min to Max/Init./Step]
7-504-176	Paper Jam Location	Corner Stapler Movement Motor	CTL*	[0 to 65535 / 0 / 0/step]
7-504-177	Paper Jam Location	Corner Stapler Motor	CTL*	[0 to 65535 / 0 / 0/step]
7-504-178	Paper Jam Location	Booklet Jogger Motor	CTL*	[0 to 65535 / 0 / 0/step]
7-504-179	Paper Jam Location	Booklet Guide Motor	CTL*	[0 to 65535 / 0 / 0/step]
7-504-180	Paper Jam Location	Booklet Jogger Fence Motor	CTL*	[0 to 65535 / 0 / 0/step]
7-504-181	Paper Jam Location	Booklet Stapler Motor	CTL*	[0 to 65535 / 0 / 0/step]
7-504-182	Paper Jam Location	Movement Roller Transport Motor	CTL*	[0 to 65535 / 0 / 0/step]
7-504-183	Paper Jam Location	Folding Transport Motor	CTL*	[0 to 65535 / 0 / 0/step]
7-504-184	Paper Jam Location	Square Folding Motor	CTL*	[0 to 65535 / 0 / 0/step]
7-504-185	Paper Jam Location	Tray Lift Motor	CTL*	[0 to 65535 / 0 / 0/step]
7-504-186	Paper Jam Location	Shift Motor	CTL*	[0 to 65535 / 0 / 0/step]
7-504-187	Paper Jam Location	Front Shift Jogger Motor	CTL*	[0 to 65535 / 0 / 0/step]
7-504-188	Paper Jam Location	Rear Shift Jogger Motor	CTL*	[0 to 65535 / 0 / 0/step]
7-504-189	Paper Jam Location	Shift Jogger Retraction Motor	CTL*	[0 to 65535 / 0 / 0/step]
7-504-190	Paper Jam Location	Drag Roller Vibrating Motor	CTL*	[0 to 65535 / 0 / 0/step]
7-504-191	Paper Jam Location	Leading Edge Guide Motor	CTL*	[0 to 65535 / 0 / 0/step]
7-504-192	Paper Jam Location	Positioning Transport Motor	CTL*	[0 to 65535 / 0 / 0/step]
7-504-193	Paper Jam Location	Paper Guide Motor	CTL*	[0 to 65535 / 0 / 0/step]

3.SP Mode Tables

SP No.	Large Category	Small Category	ENG or CTL	[Min to Max/Init./Step]
7-504-194	Paper Jam Location	Invalid Main Machine Data Setting	CTL*	[0 to 65535 / 0 / 0/step]
7-504-200	Paper Jam Location	Entrance: On	CTL*	[0 to 65535 / 0 / 0/step]
7-504-201	Paper Jam Location	Entrance: Off	CTL*	[0 to 65535 / 0 / 0/step]
7-504-202	Paper Jam Location	Proof Tray Exit: On	CTL*	[0 to 65535 / 0 / 0/step]
7-504-203	Paper Jam Location	Proof Tray Exit: Off	CTL*	[0 to 65535 / 0 / 0/step]
7-504-204	Paper Jam Location	Intermediate Transport (R): On	CTL*	[0 to 65535 / 0 / 0/step]
7-504-205	Paper Jam Location	Intermediate Transport (L): On	CTL*	[0 to 65535 / 0 / 0/step]
7-504-206	Paper Jam Location	Intermediate Transport (L): Off	CTL*	[0 to 65535 / 0 / 0/step]
7-504-207	Paper Jam Location	Shift Tray Paper Exit: On	CTL*	[0 to 65535 / 0 / 0/step]
7-504-208	Paper Jam Location	Shift Tray Paper Exit: Off	CTL*	[0 to 65535 / 0 / 0/step]
7-504-209	Paper Jam Location	Paper Bundle Transport: On	CTL*	[0 to 65535 / 0 / 0/step]
7-504-210	Paper Jam Location	Trailing Edge Stopper Trans.: On	CTL*	[0 to 65535 / 0 / 0/step]
7-504-211	Paper Jam Location	Trailing Edge Stopper Trans.: Off	CTL*	[0 to 65535 / 0 / 0/step]
7-504-212	Paper Jam Location	Center-Folding Exit: On	CTL*	[0 to 65535 / 0 / 0/step]
7-504-213	Paper Jam Location	Center-Folding Exit: Off	CTL*	[0 to 65535 / 0 / 0/step]
7-504-220	Paper Jam Location	Entrance Transport Motor	CTL*	[0 to 65535 / 0 / 0/step]
7-504-221	Paper Jam Location	Proof Transport Motor	CTL*	[0 to 65535 / 0 / 0/step]
7-504-222	Paper Jam Location	Exit Trans./Posit & Move Rllr Mt	CTL*	[0 to 65535 / 0 / 0/step]

3.SP Mode Tables

SP No.	Large Category	Small Category	ENG or CTL	[Min to Max/Init./Step]
7-504-223	Paper Jam Location	Shift Motor	CTL*	[0 to 65535 / 0 / 0/step]
7-504-224	Paper Jam Location	Jogger Motor	CTL*	[0 to 65535 / 0 / 0/step]
7-504-225	Paper Jam Location	Exit Guide Plate Motor	CTL*	[0 to 65535 / 0 / 0/step]
7-504-226	Paper Jam Location	Feed Out Motor	CTL*	[0 to 65535 / 0 / 0/step]
7-504-227	Paper Jam Location	Tray Lift Motor	CTL*	[0 to 65535 / 0 / 0/step]
7-504-228	Paper Jam Location	Positioning Motor	CTL*	[0 to 65535 / 0 / 0/step]
7-504-229	Paper Jam Location	Stapler Movement Motor	CTL*	[0 to 65535 / 0 / 0/step]
7-504-230	Paper Jam Location	Stapler Motor	CTL*	[0 to 65535 / 0 / 0/step]
7-504-231	Paper Jam Location	Punch Motors	CTL*	[0 to 65535 / 0 / 0/step]
7-504-232	Paper Jam Location	Paper Bundle Transport Motors	CTL*	[0 to 65535 / 0 / 0/step]
7-504-233	Paper Jam Location	Trailing Edge Stopper Motor	CTL*	[0 to 65535 / 0 / 0/step]
7-504-234	Paper Jam Location	Folding Blade Motor	CTL*	[0 to 65535 / 0 / 0/step]
7-504-235	Paper Jam Location	Paper Guide Motor	CTL*	[0 to 65535 / 0 / 0/step]
7-504-236	Paper Jam Location	Stapleless Stapler Movement Motor	CTL*	[0 to 65535 / 0 / 0/step]
7-504-237	Paper Jam Location	Stapleless Stapler Motor	CTL*	[0 to 65535 / 0 / 0/step]
7-504-238	Paper Jam Location	Moveable Guide Plate Motor	CTL*	[0 to 65535 / 0 / 0/step]
7-504-239	Paper Jam Location	Drag Roller Paper Surface Retract Motor	CTL*	[0 to 65535 / 0 / 0/step]
7-504-249	Paper Jam Location	Invalid Main Machine Data Setting	CTL*	[0 to 65535 / 0 / 0/step]

3.SP Mode Tables

SP No.	Large Category	Small Category	ENG or CTL	[Min to Max/Init./Step]
7-505-001	Original Jam Detection	At Power On	CTL*	[0 to 65535 / 0 / 0/step]
7-505-013	Original Jam Detection	Separation Sensor: On	CTL*	[0 to 65535 / 0 / 0/step]
7-505-014	Original Jam Detection	Skew Correction Sensor 1: On	CTL*	[0 to 65535 / 0 / 0/step]
7-505-015	Original Jam Detection	Scanning Entrance Sensor: On	CTL*	[0 to 65535 / 0 / 0/step]
7-505-016	Original Jam Detection	Registration Sensor: On	CTL*	[0 to 65535 / 0 / 0/step]
7-505-017	Original Jam Detection	Original Exit Sensor: On	CTL*	[0 to 65535 / 0 / 0/step]
7-505-018	Original Jam Detection	Skew Correction Sensor 2: On	CTL*	[0 to 65535 / 0 / 0/step]
7-505-063	Original Jam Detection	Separation Sensor: Off	CTL*	[0 to 65535 / 0 / 0/step]
7-505-064	Original Jam Detection	Skew Correction Sensor: Off	CTL*	[0 to 65535 / 0 / 0/step]
7-505-065	Original Jam Detection	Scanning Entrance Sensor: Off	CTL*	[0 to 65535 / 0 / 0/step]
7-505-066	Original Jam Detection	Registration Sensor: Off	CTL*	[0 to 65535 / 0 / 0/step]
7-505-067	Original Jam Detection	Original Exit Sensor: Off	CTL*	[0 to 65535 / 0 / 0/step]
7-505-099	Original Jam Detection	Double Feed Detection	CTL*	[0 to 65535 / 0 / 0/step]
7-505-239	Original Jam Detection	Original Pullout	CTL*	[0 to 65535 / 0 / 0/step]
7-506-005	Jam Count by Paper Size	A4 LEF	CTL*	[0 to 65535 / 0 / 0/step]
7-506-006	Jam Count by Paper Size	A5 LEF	CTL*	[0 to 65535 / 0 / 0/step]
7-506-014	Jam Count by Paper Size	B5 LEF	CTL*	[0 to 65535 / 0 / 0/step]
7-506-038	Jam Count by Paper Size	LT LEF	CTL*	[0 to 65535 / 0 / 0/step]

3.SP Mode Tables

SP No.	Large Category	Small Category	ENG or CTL	[Min to Max/Init./Step]
7-506-044	Jam Count by Paper Size	HLT LEF	CTL*	[0 to 65535 / 0 / 0/step]
7-506-132	Jam Count by Paper Size	A3 SEF	CTL*	[0 to 65535 / 0 / 0/step]
7-506-133	Jam Count by Paper Size	A4 SEF	CTL*	[0 to 65535 / 0 / 0/step]
7-506-134	Jam Count by Paper Size	A5 SEF	CTL*	[0 to 65535 / 0 / 0/step]
7-506-141	Jam Count by Paper Size	B4 SEF	CTL*	[0 to 65535 / 0 / 0/step]
7-506-142	Jam Count by Paper Size	B5 SEF	CTL*	[0 to 65535 / 0 / 0/step]
7-506-160	Jam Count by Paper Size	DLT SEF	CTL*	[0 to 65535 / 0 / 0/step]
7-506-164	Jam Count by Paper Size	LG SEF	CTL*	[0 to 65535 / 0 / 0/step]
7-506-166	Jam Count by Paper Size	LT SEF	CTL*	[0 to 65535 / 0 / 0/step]
7-506-172	Jam Count by Paper Size	HLT SEF	CTL*	[0 to 65535 / 0 / 0/step]
7-506-255	Jam Count by Paper Size	Others	CTL*	[0 to 65535 / 0 / 0/step]
7-507-001	Plotter Jam History	Latest	CTL*	[0 to 0 / 0 / 0/step]
7-507-002	Plotter Jam History	Latest 1	CTL*	[0 to 0 / 0 / 0/step]
7-507-003	Plotter Jam History	Latest 2	CTL*	[0 to 0 / 0 / 0/step]
7-507-004	Plotter Jam History	Latest 3	CTL*	[0 to 0 / 0 / 0/step]
7-507-005	Plotter Jam History	Latest 4	CTL*	[0 to 0 / 0 / 0/step]
7-507-006	Plotter Jam History	Latest 5	CTL*	[0 to 0 / 0 / 0/step]
7-507-007	Plotter Jam History	Latest 6	CTL*	[0 to 0 / 0 / 0/step]

3.SP Mode Tables

SP No.	Large Category	Small Category	ENG or CTL	[Min to Max/Init./Step]
7-507-008	Plotter Jam History	Latest 7	CTL*	[0 to 0 / 0 / 0/step]
7-507-009	Plotter Jam History	Latest 8	CTL*	[0 to 0 / 0 / 0/step]
7-507-010	Plotter Jam History	Latest 9	CTL*	[0 to 0 / 0 / 0/step]
7-508-001	Original Jam History	Latest	CTL*	[0 to 0 / 0 / 0/step]
7-508-002	Original Jam History	Latest 1	CTL*	[0 to 0 / 0 / 0/step]
7-508-003	Original Jam History	Latest 2	CTL*	[0 to 0 / 0 / 0/step]
7-508-004	Original Jam History	Latest 3	CTL*	[0 to 0 / 0 / 0/step]
7-508-005	Original Jam History	Latest 4	CTL*	[0 to 0 / 0 / 0/step]
7-508-006	Original Jam History	Latest 5	CTL*	[0 to 0 / 0 / 0/step]
7-508-007	Original Jam History	Latest 6	CTL*	[0 to 0 / 0 / 0/step]
7-508-008	Original Jam History	Latest 7	CTL*	[0 to 0 / 0 / 0/step]
7-508-009	Original Jam History	Latest 8	CTL*	[0 to 0 / 0 / 0/step]
7-508-010	Original Jam History	Latest 9	CTL*	[0 to 0 / 0 / 0/step]
7-509-045	Paper Jam Location	Entrance Sensor: On	CTL*	[0 to 65535 / 0 / 0/step]
7-509-046	Paper Jam Location	Entrance Sensor: Off	CTL*	[0 to 65535 / 0 / 0/step]
7-509-047	Paper Jam Location	Exit Sensor: On	CTL*	[0 to 65535 / 0 / 0/step]
7-509-048	Paper Jam Location	Exit Sensor: Off	CTL*	[0 to 65535 / 0 / 0/step]
7-509-049	Paper Jam Location	Shift Motor	CTL*	[0 to 65535 / 0 / 0/step]

3.SP Mode Tables

SP No.	Large Category	Small Category	ENG or CTL	[Min to Max/Init./Step]
7-509-050	Paper Jam Location	Junction Gate Motor	CTL*	[0 to 65535 / 0 / 0/step]
7-509-051	Paper Jam Location	Exit Paper Pressure Motor	CTL*	[0 to 65535 / 0 / 0/step]
7-509-052	Paper Jam Location	Stapler Motor	CTL*	[0 to 65535 / 0 / 0/step]
7-509-053	Paper Jam Location	Feed Out Motor	CTL*	[0 to 65535 / 0 / 0/step]
7-509-094	Paper Jam Location	Invalid Main Machine Data Setting	CTL*	[0 to 65535 / 0 / 0/step]
7-509-095	Paper Jam Location	Registration Sensor: On	CTL*	[0 to 65535 / 0 / 0/step]
7-509-096	Paper Jam Location	Registration Sensor: Off	CTL*	[0 to 65535 / 0 / 0/step]
7-509-097	Paper Jam Location	1st Fold Sensor: On	CTL*	[0 to 65535 / 0 / 0/step]
7-509-098	Paper Jam Location	1st Fold Sensor: Off	CTL*	[0 to 65535 / 0 / 0/step]
7-509-099	Paper Jam Location	2nd Fold Sensor: On	CTL*	[0 to 65535 / 0 / 0/step]
7-509-100	Paper Jam Location	2nd Fold Sensor: Off	CTL*	[0 to 65535 / 0 / 0/step]
7-509-101	Paper Jam Location	Crease Sensor: On	CTL*	[0 to 65535 / 0 / 0/step]
7-509-102	Paper Jam Location	Crease Sensor: Off	CTL*	[0 to 65535 / 0 / 0/step]
7-509-103	Paper Jam Location	Folder Tray Exit Sensor: On	CTL*	[0 to 65535 / 0 / 0/step]
7-509-104	Paper Jam Location	Folder Tray Exit Sensor: Off	CTL*	[0 to 65535 / 0 / 0/step]
7-509-105	Paper Jam Location	Horizontal Path Exit Sensor: On	CTL*	[0 to 65535 / 0 / 0/step]
7-509-106	Paper Jam Location	Horizontal Path Exit Sensor: Off	CTL*	[0 to 65535 / 0 / 0/step]
7-509-115	Paper Jam Location	Registration Motor	CTL*	[0 to 65535 / 0 / 0/step]

3.SP Mode Tables

SP No.	Large Category	Small Category	ENG or CTL	[Min to Max/Init./Step]
7-509-116	Paper Jam Location	JG Crease Motor:JG	CTL*	[0 to 65535 / 0 / 0/step]
7-509-117	Paper Jam Location	Transport Motor	CTL*	[0 to 65535 / 0 / 0/step]
7-509-118	Paper Jam Location	1st Fold Motor	CTL*	[0 to 65535 / 0 / 0/step]
7-509-119	Paper Jam Location	2nd Fold Motor	CTL*	[0 to 65535 / 0 / 0/step]
7-509-120	Paper Jam Location	JG Crease Motor:Crease	CTL*	[0 to 65535 / 0 / 0/step]
7-509-144	Paper Jam Location	Invalid Main Machine Data Setting	CTL*	[0 to 65535 / 0 / 0/step]
7-509-255	Paper Jam Location	No Finsher Response	CTL*	[0 to 65535 / 0 / 0/step]
7-514-001	Paper Jam Count by Location	At Power On	CTL*	[0 to 65535 / 0 / 0/step]
7-514-003	Paper Jam Count by Location	Tray 1: On	CTL*	[0 to 65535 / 0 / 0/step]
7-514-004	Paper Jam Count by Location	Tray 2: On	CTL*	[0 to 65535 / 0 / 0/step]
7-514-005	Paper Jam Count by Location	Tray 3: On	CTL*	[0 to 65535 / 0 / 0/step]
7-514-006	Paper Jam Count by Location	Tray 4: On	CTL*	[0 to 65535 / 0 / 0/step]
7-514-007	Paper Jam Count by Location	LCT: On	CTL*	[0 to 65535 / 0 / 0/step]
7-514-008	Paper Jam Count by Location	Bypass: On	CTL*	[0 to 65535 / 0 / 0/step]
7-514-009	Paper Jam Count by Location	Duplex: On	CTL*	[0 to 65535 / 0 / 0/step]
7-514-011	Paper Jam Count by Location	Transport Sensor 1: On	CTL*	[0 to 65535 / 0 / 0/step]
7-514-012	Paper Jam Count by Location	Transport Sensor 2: On	CTL*	[0 to 65535 / 0 / 0/step]
7-514-013	Paper Jam Count by Location	Vertical Trans. Sn 3: On	CTL*	[0 to 65535 / 0 / 0/step]

3.SP Mode Tables

SP No.	Large Category	Small Category	ENG or CTL	[Min to Max/Init./Step]
7-514-014	Paper Jam Count by Location	Vertical Trans. Sn 4: On	CTL*	[0 to 65535 / 0 / 0/step]
7-514-015	Paper Jam Count by Location	LCT Transport Sensor: On	CTL*	[0 to 65535 / 0 / 0/step]
7-514-017	Paper Jam Count by Location	Registration Sensor: On	CTL*	[0 to 65535 / 0 / 0/step]
7-514-018	Paper Jam Count by Location	Fusing Entrance Sensor: On	CTL*	[0 to 65535 / 0 / 0/step]
7-514-019	Paper Jam Count by Location	Fusing Exit Sensor: On	CTL*	[0 to 65535 / 0 / 0/step]
7-514-020	Paper Jam Count by Location	Paper Exit Sensor: On	CTL*	[0 to 65535 / 0 / 0/step]
7-514-021	Paper Jam Count by Location	Bridge Exit Sensor: On	CTL*	[0 to 65535 / 0 / 0/step]
7-514-022	Paper Jam Count by Location	Bridge Transport Sensor: On	CTL*	[0 to 65535 / 0 / 0/step]
7-514-024	Paper Jam Count by Location	Inverter Sensor: On	CTL*	[0 to 65535 / 0 / 0/step]
7-514-025	Paper Jam Count by Location	Duplex Exit Sensor: On	CTL*	[0 to 65535 / 0 / 0/step]
7-514-027	Paper Jam Count by Location	Duplex Entrance Sensor: On	CTL*	[0 to 65535 / 0 / 0/step]
7-514-048	Paper Jam Count by Location	Bypass Feed Sensor 1: On	CTL*	[0 to 65535 / 0 / 0/step]
7-514-051	Paper Jam Count by Location	Transport Sensor 1: Off	CTL*	[0 to 65535 / 0 / 0/step]
7-514-052	Paper Jam Count by Location	Transport Sensor 2: Off	CTL*	[0 to 65535 / 0 / 0/step]
7-514-053	Paper Jam Count by Location	Vertical Trans. Sn 3: Off	CTL*	[0 to 65535 / 0 / 0/step]
7-514-054	Paper Jam Count by Location	Vertical Trans. Sn 4: Off	CTL*	[0 to 65535 / 0 / 0/step]
7-514-057	Paper Jam Count by Location	Registration Sensor: Off	CTL*	[0 to 65535 / 0 / 0/step]
7-514-058	Paper Jam Count by Location	LCT Transport Sensor: Off	CTL*	[0 to 65535 / 0 / 0/step]

3.SP Mode Tables

SP No.	Large Category	Small Category	ENG or CTL	[Min to Max/Init./Step]
7-514-060	Paper Jam Count by Location	Paper Exit Sensor: Off	CTL*	[0 to 65535 / 0 / 0/step]
7-514-061	Paper Jam Count by Location	Bridge Exit Sensor: Off	CTL*	[0 to 65535 / 0 / 0/step]
7-514-062	Paper Jam Count by Location	Bridge Transport Sensor: Off	CTL*	[0 to 65535 / 0 / 0/step]
7-514-064	Paper Jam Count by Location	Inverter Sensor: Off	CTL*	[0 to 65535 / 0 / 0/step]
7-514-065	Paper Jam Count by Location	Duplex Exit Sensor: Off	CTL*	[0 to 65535 / 0 / 0/step]
7-514-067	Paper Jam Count by Location	Duplex Entrance Sensor: Off	CTL*	[0 to 65535 / 0 / 0/step]
7-514-096	Paper Jam Count by Location	Timing Lose	CTL*	[0 to 65535 / 0 / 0/step]
7-514-100	Paper Jam Count by Location	Entrance Sensor: On	CTL*	[0 to 65535 / 0 / 0/step]
7-514-101	Paper Jam Count by Location	Entrance Sensor: Off	CTL*	[0 to 65535 / 0 / 0/step]
7-514-102	Paper Jam Count by Location	Transport Sensor: On	CTL*	[0 to 65535 / 0 / 0/step]
7-514-103	Paper Jam Count by Location	Transport Sensor: Off	CTL*	[0 to 65535 / 0 / 0/step]
7-514-104	Paper Jam Count by Location	Paper Exit	CTL*	[0 to 65535 / 0 / 0/step]
7-514-105	Paper Jam Count by Location	Front Jogger Motor	CTL*	[0 to 65535 / 0 / 0/step]
7-514-106	Paper Jam Count by Location	Rear Jogger Motor	CTL*	[0 to 65535 / 0 / 0/step]
7-514-107	Paper Jam Count by Location	Shift Roller Motor	CTL*	[0 to 65535 / 0 / 0/step]
7-514-108	Paper Jam Count by Location	Positioning Roller Motor	CTL*	[0 to 65535 / 0 / 0/step]
7-514-109	Paper Jam Count by Location	Exit Guide Plate Motor	CTL*	[0 to 65535 / 0 / 0/step]
7-514-110	Paper Jam Count by Location	Stapler Movement Motor	CTL*	[0 to 65535 / 0 / 0/step]

3.SP Mode Tables

SP No.	Large Category	Small Category	ENG or CTL	[Min to Max/Init./Step]
7-514-111	Paper Jam Count by Location	Shift Tray Lift Motor	CTL*	[0 to 65535 / 0 / 0/step]
7-514-112	Paper Jam Count by Location	Staple Motor	CTL*	[0 to 65535 / 0 / 0/step]
7-514-113	Paper Jam Count by Location	Paper Stopper Motor	CTL*	[0 to 65535 / 0 / 0/step]
7-514-114	Paper Jam Count by Location	Punch Motor	CTL*	[0 to 65535 / 0 / 0/step]
7-514-115	Paper Jam Count by Location	Punch Unit Movement Motor	CTL*	[0 to 65535 / 0 / 0/step]
7-514-116	Paper Jam Count by Location	Horizontal Reg. Movement Motor	CTL*	[0 to 65535 / 0 / 0/step]
7-514-149	Paper Jam Count by Location	Invalid Main Machine Data Setting	CTL*	[0 to 65535 / 0 / 0/step]
7-514-150	Paper Jam Count by Location	Entrance Sensor: On	CTL*	[0 to 65535 / 0 / 0/step]
7-514-151	Paper Jam Count by Location	Entrance Sensor: Off	CTL*	[0 to 65535 / 0 / 0/step]
7-514-152	Paper Jam Count by Location	Horizontal Transport Sn: On	CTL*	[0 to 65535 / 0 / 0/step]
7-514-153	Paper Jam Count by Location	Horizontal Transport Sn: Off	CTL*	[0 to 65535 / 0 / 0/step]
7-514-154	Paper Jam Count by Location	Switchback Transport Sn: On	CTL*	[0 to 65535 / 0 / 0/step]
7-514-155	Paper Jam Count by Location	Switchback Transport Sn: Off	CTL*	[0 to 65535 / 0 / 0/step]
7-514-156	Paper Jam Count by Location	Proof Tray Exit: On	CTL*	[0 to 65535 / 0 / 0/step]
7-514-157	Paper Jam Count by Location	Proof Tray Exit: Off	CTL*	[0 to 65535 / 0 / 0/step]
7-514-158	Paper Jam Count by Location	Shift Tray Exit: On	CTL*	[0 to 65535 / 0 / 0/step]
7-514-159	Paper Jam Count by Location	Shift Tray Exit: Off	CTL*	[0 to 65535 / 0 / 0/step]
7-514-160	Paper Jam Count by Location	Booklet Stapler Exit: On	CTL*	[0 to 65535 / 0 / 0/step]

3.SP Mode Tables

SP No.	Large Category	Small Category	ENG or CTL	[Min to Max/Init./Step]
7-514-161	Paper Jam Count by Location	Booklet Stapler Exit: Off	CTL*	[0 to 65535 / 0 / 0/step]
7-514-162	Paper Jam Count by Location	Entrance Transport Motor	CTL*	[0 to 65535 / 0 / 0/step]
7-514-163	Paper Jam Count by Location	Horizontal Transport Motor	CTL*	[0 to 65535 / 0 / 0/step]
7-514-164	Paper Jam Count by Location	Pre-Stack Transport Motor	CTL*	[0 to 65535 / 0 / 0/step]
7-514-165	Paper Jam Count by Location	Intermediate Transport Motor	CTL*	[0 to 65535 / 0 / 0/step]
7-514-166	Paper Jam Count by Location	Paper Exit Motor	CTL*	[0 to 65535 / 0 / 0/step]
7-514-167	Paper Jam Count by Location	Trailing Edge Stopper Motor	CTL*	[0 to 65535 / 0 / 0/step]
7-514-168	Paper Jam Count by Location	Paper Exit Guide Plate Motor	CTL*	[0 to 65535 / 0 / 0/step]
7-514-169	Paper Jam Count by Location	Punch Unit Drive Motor	CTL*	[0 to 65535 / 0 / 0/step]
7-514-170	Paper Jam Count by Location	Punch Unit Movement Motor	CTL*	[0 to 65535 / 0 / 0/step]
7-514-171	Paper Jam Count by Location	S-to-S Regist Move Motor	CTL*	[0 to 65535 / 0 / 0/step]
7-514-172	Paper Jam Count by Location	Lower Junction Gate Motor	CTL*	[0 to 65535 / 0 / 0/step]
7-514-173	Paper Jam Count by Location	Jogger Motor	CTL*	[0 to 65535 / 0 / 0/step]
7-514-174	Paper Jam Count by Location	Positioning Roller Drive Motor	CTL*	[0 to 65535 / 0 / 0/step]
7-514-175	Paper Jam Count by Location	Feed Out Motor	CTL*	[0 to 65535 / 0 / 0/step]
7-514-176	Paper Jam Count by Location	Corner Stapler Movement Motor	CTL*	[0 to 65535 / 0 / 0/step]
7-514-177	Paper Jam Count by Location	Corner Stapler Motor	CTL*	[0 to 65535 / 0 / 0/step]
7-514-178	Paper Jam Count by Location	Booklet Jogger Motor	CTL*	[0 to 65535 / 0 / 0/step]

3.SP Mode Tables

SP No.	Large Category	Small Category	ENG or CTL	[Min to Max/Init./Step]
7-514-179	Paper Jam Count by Location	Booklet Guide Motor	CTL*	[0 to 65535 / 0 / 0/step]
7-514-180	Paper Jam Count by Location	Booklet Jogger Fence Motor	CTL*	[0 to 65535 / 0 / 0/step]
7-514-181	Paper Jam Count by Location	Booklet Stapler Motor	CTL*	[0 to 65535 / 0 / 0/step]
7-514-182	Paper Jam Count by Location	Movement Roller Transport Motor	CTL*	[0 to 65535 / 0 / 0/step]
7-514-183	Paper Jam Count by Location	Folding Transport Motor	CTL*	[0 to 65535 / 0 / 0/step]
7-514-184	Paper Jam Count by Location	Square Folding Motor	CTL*	[0 to 65535 / 0 / 0/step]
7-514-185	Paper Jam Count by Location	Tray Lift Motor	CTL*	[0 to 65535 / 0 / 0/step]
7-514-186	Paper Jam Count by Location	Shift Motor	CTL*	[0 to 65535 / 0 / 0/step]
7-514-187	Paper Jam Count by Location	Front Shift Jogger Motor	CTL*	[0 to 65535 / 0 / 0/step]
7-514-188	Paper Jam Count by Location	Rear Shift Jogger Motor	CTL*	[0 to 65535 / 0 / 0/step]
7-514-189	Paper Jam Count by Location	Shift Jogger Retraction Motor	CTL*	[0 to 65535 / 0 / 0/step]
7-514-190	Paper Jam Count by Location	Drag Roller Vibrating Motor	CTL*	[0 to 65535 / 0 / 0/step]
7-514-191	Paper Jam Count by Location	Leading Edge Guide Motor	CTL*	[0 to 65535 / 0 / 0/step]
7-514-192	Paper Jam Count by Location	Positioning Transport Motor	CTL*	[0 to 65535 / 0 / 0/step]
7-514-193	Paper Jam Count by Location	Paper Guide Motor	CTL*	[0 to 65535 / 0 / 0/step]
7-514-194	Paper Jam Count by Location	Invalid Main Machine Data Setting	CTL*	[0 to 65535 / 0 / 0/step]
7-514-200	Paper Jam Count by Location	Entrance: On	CTL*	[0 to 65535 / 0 / 0/step]
7-514-201	Paper Jam Count by Location	Entrance: Off	CTL*	[0 to 65535 / 0 / 0/step]

3.SP Mode Tables

SP No.	Large Category	Small Category	ENG or CTL	[Min to Max/Init./Step]
7-514-202	Paper Jam Count by Location	Proof Tray Exit: On	CTL*	[0 to 65535 / 0 / 0/step]
7-514-203	Paper Jam Count by Location	Proof Tray Exit: Off	CTL*	[0 to 65535 / 0 / 0/step]
7-514-204	Paper Jam Count by Location	Intermediate Transport (R): On	CTL*	[0 to 65535 / 0 / 0/step]
7-514-205	Paper Jam Count by Location	Intermediate Transport (L): On	CTL*	[0 to 65535 / 0 / 0/step]
7-514-206	Paper Jam Count by Location	Intermediate Transport (L): Off	CTL*	[0 to 65535 / 0 / 0/step]
7-514-207	Paper Jam Count by Location	Shift Tray Paper Exit: On	CTL*	[0 to 65535 / 0 / 0/step]
7-514-208	Paper Jam Count by Location	Shift Tray Paper Exit: Off	CTL*	[0 to 65535 / 0 / 0/step]
7-514-209	Paper Jam Count by Location	Paper Bundle Transport: On	CTL*	[0 to 65535 / 0 / 0/step]
7-514-210	Paper Jam Count by Location	Trailing Edge Stopper Trans.: On	CTL*	[0 to 65535 / 0 / 0/step]
7-514-211	Paper Jam Count by Location	Trailing Edge Stopper Trans.: Off	CTL*	[0 to 65535 / 0 / 0/step]
7-514-212	Paper Jam Count by Location	Center-Folding Exit: On	CTL*	[0 to 65535 / 0 / 0/step]
7-514-213	Paper Jam Count by Location	Center-Folding Exit: Off	CTL*	[0 to 65535 / 0 / 0/step]
7-514-220	Paper Jam Count by Location	Entrance Transport Motor	CTL*	[0 to 65535 / 0 / 0/step]
7-514-221	Paper Jam Count by Location	Proof Transport Motor	CTL*	[0 to 65535 / 0 / 0/step]
7-514-222	Paper Jam Count by Location	Exit Trans./Posit & Move Rllr Mt	CTL*	[0 to 65535 / 0 / 0/step]
7-514-223	Paper Jam Count by Location	Shift Motor	CTL*	[0 to 65535 / 0 / 0/step]
7-514-224	Paper Jam Count by Location	Jogger Motor	CTL*	[0 to 65535 / 0 / 0/step]
7-514-225	Paper Jam Count by Location	Exit Guide Plate Motor	CTL*	[0 to 65535 / 0 / 0/step]

3.SP Mode Tables

SP No.	Large Category	Small Category	ENG or CTL	[Min to Max/Init./Step]
7-514-226	Paper Jam Count by Location	Feed Out Motor	CTL*	[0 to 65535 / 0 / 0/step]
7-514-227	Paper Jam Count by Location	Tray Lift Motor	CTL*	[0 to 65535 / 0 / 0/step]
7-514-228	Paper Jam Count by Location	Positioning Motor	CTL*	[0 to 65535 / 0 / 0/step]
7-514-229	Paper Jam Count by Location	Stapler Movement Motor	CTL*	[0 to 65535 / 0 / 0/step]
7-514-230	Paper Jam Count by Location	Stapler Motor	CTL*	[0 to 65535 / 0 / 0/step]
7-514-231	Paper Jam Count by Location	Punch Motors	CTL*	[0 to 65535 / 0 / 0/step]
7-514-232	Paper Jam Count by Location	Paper Bundle Transport Motors	CTL*	[0 to 65535 / 0 / 0/step]
7-514-233	Paper Jam Count by Location	Trailing Edge Stopper Motor	CTL*	[0 to 65535 / 0 / 0/step]
7-514-234	Paper Jam Count by Location	Folding Blade Motor	CTL*	[0 to 65535 / 0 / 0/step]
7-514-235	Paper Jam Count by Location	Paper Guide Motor	CTL*	[0 to 65535 / 0 / 0/step]
7-514-236	Paper Jam Count by Location	Stapleless Stapler Movement Motor	CTL*	[0 to 65535 / 0 / 0/step]
7-514-237	Paper Jam Count by Location	Stapleless Stapler Motor	CTL*	[0 to 65535 / 0 / 0/step]
7-514-238	Paper Jam Count by Location	Moveable Guide Plate Motor	CTL*	[0 to 65535 / 0 / 0/step]
7-514-239	Paper Jam Count by Location	Drag Roller Paper Surface Retract Motor	CTL*	[0 to 65535 / 0 / 0/step]
7-514-249	Paper Jam Count by Location	Invalid Main Machine Data Setting	CTL*	[0 to 65535 / 0 / 0/step]
7-515-001	Original Jam Count by Detection	At Power On	CTL*	[0 to 65535 / 0 / 0/step]
7-515-013	Original Jam Count by Detection	Separation Sensor: On	CTL*	[0 to 65535 / 0 / 0/step]
7-515-014	Original Jam Count by Detection	Skew Correction Sensor 1: On	CTL*	[0 to 65535 / 0 / 0/step]

3.SP Mode Tables

SP No.	Large Category	Small Category	ENG or CTL	[Min to Max/Init./Step]
7-515-015	Original Jam Count by Detection	Scanning Entrance Sensor: On	CTL*	[0 to 65535 / 0 / 0/step]
7-515-016	Original Jam Count by Detection	Registration Sensor: On	CTL*	[0 to 65535 / 0 / 0/step]
7-515-017	Original Jam Count by Detection	Original Exit Sensor: On	CTL*	[0 to 65535 / 0 / 0/step]
7-515-018	Original Jam Count by Detection	Skew Correction Sensor 2: On	CTL*	[0 to 65535 / 0 / 0/step]
7-515-063	Original Jam Count by Detection	Separation Sensor: Off	CTL*	[0 to 65535 / 0 / 0/step]
7-515-064	Original Jam Count by Detection	Skew Correction Sensor: Off	CTL*	[0 to 65535 / 0 / 0/step]
7-515-065	Original Jam Count by Detection	Scanning Entrance Sensor: Off	CTL*	[0 to 65535 / 0 / 0/step]
7-515-066	Original Jam Count by Detection	Registration Sensor: Off	CTL*	[0 to 65535 / 0 / 0/step]
7-515-067	Original Jam Count by Detection	Original Exit Sensor: Off	CTL*	[0 to 65535 / 0 / 0/step]
7-515-099	Original Jam Count by Detection	Double Feed Detection	CTL*	[0 to 65535 / 0 / 0/step]
7-515-239	Original Jam Count by Detection	Original Pullout	CTL*	[0 to 65535 / 0 / 0/step]
7-516-005	Paper Size Jam Count	A4 LEF	CTL*	[0 to 65535 / 0 / 0/step]
7-516-006	Paper Size Jam Count	A5 LEF	CTL*	[0 to 65535 / 0 / 0/step]
7-516-014	Paper Size Jam Count	B5 LEF	CTL*	[0 to 65535 / 0 / 0/step]
7-516-038	Paper Size Jam Count	LT LEF	CTL*	[0 to 65535 / 0 / 0/step]
7-516-044	Paper Size Jam Count	HLT LEF	CTL*	[0 to 65535 / 0 / 0/step]
7-516-132	Paper Size Jam Count	A3 SEF	CTL*	[0 to 65535 / 0 / 0/step]
7-516-133	Paper Size Jam Count	A4 SEF	CTL*	[0 to 65535 / 0 / 0/step]

3.SP Mode Tables

SP No.	Large Category	Small Category	ENG or CTL	[Min to Max/Init./Step]
7-516-134	Paper Size Jam Count	A5 SEF	CTL*	[0 to 65535 / 0 / 0/step]
7-516-141	Paper Size Jam Count	B4 SEF	CTL*	[0 to 65535 / 0 / 0/step]
7-516-142	Paper Size Jam Count	B5 SEF	CTL*	[0 to 65535 / 0 / 0/step]
7-516-160	Paper Size Jam Count	DLT SEF	CTL*	[0 to 65535 / 0 / 0/step]
7-516-164	Paper Size Jam Count	LG SEF	CTL*	[0 to 65535 / 0 / 0/step]
7-516-166	Paper Size Jam Count	LT SEF	CTL*	[0 to 65535 / 0 / 0/step]
7-516-172	Paper Size Jam Count	HLT SEF	CTL*	[0 to 65535 / 0 / 0/step]
7-516-255	Paper Size Jam Count	Others	CTL*	[0 to 65535 / 0 / 0/step]
7-519-045	Paper Jam Count by Location	Entrance Sensor: On	CTL*	[0 to 65535 / 0 / 0/step]
7-519-046	Paper Jam Count by Location	Entrance Sensor: Off	CTL*	[0 to 65535 / 0 / 0/step]
7-519-047	Paper Jam Count by Location	Exit Sensor: On	CTL*	[0 to 65535 / 0 / 0/step]
7-519-048	Paper Jam Count by Location	Exit Sensor: Off	CTL*	[0 to 65535 / 0 / 0/step]
7-519-049	Paper Jam Count by Location	Shift Motor	CTL*	[0 to 65535 / 0 / 0/step]
7-519-050	Paper Jam Count by Location	Junction Gate Motor	CTL*	[0 to 65535 / 0 / 0/step]
7-519-051	Paper Jam Count by Location	Exit Paper Pressure Motor	CTL*	[0 to 65535 / 0 / 0/step]
7-519-052	Paper Jam Count by Location	Stapler Motor	CTL*	[0 to 65535 / 0 / 0/step]
7-519-053	Paper Jam Count by Location	Feed Out Motor	CTL*	[0 to 65535 / 0 / 0/step]
7-519-094	Paper Jam Count by Location	Invalid Main Machine Data Setting	CTL*	[0 to 65535 / 0 / 0/step]

3.SP Mode Tables

SP No.	Large Category	Small Category	ENG or CTL	[Min to Max/Init./Step]
7-519-095	Paper Jam Count by Location	Registration Sensor: On	CTL*	[0 to 65535 / 0 / 0/step]
7-519-096	Paper Jam Count by Location	Registration Sensor: Off	CTL*	[0 to 65535 / 0 / 0/step]
7-519-097	Paper Jam Count by Location	1st Fold Sensor: On	CTL*	[0 to 65535 / 0 / 0/step]
7-519-098	Paper Jam Count by Location	1st Fold Sensor: Off	CTL*	[0 to 65535 / 0 / 0/step]
7-519-099	Paper Jam Count by Location	2nd Fold Sensor: On	CTL*	[0 to 65535 / 0 / 0/step]
7-519-100	Paper Jam Count by Location	2nd Fold Sensor: Off	CTL*	[0 to 65535 / 0 / 0/step]
7-519-101	Paper Jam Count by Location	Crease Sensor: On	CTL*	[0 to 65535 / 0 / 0/step]
7-519-102	Paper Jam Count by Location	Crease Sensor: Off	CTL*	[0 to 65535 / 0 / 0/step]
7-519-103	Paper Jam Count by Location	Folder Tray Exit Sensor: On	CTL*	[0 to 65535 / 0 / 0/step]
7-519-104	Paper Jam Count by Location	Folder Tray Exit Sensor: Off	CTL*	[0 to 65535 / 0 / 0/step]
7-519-105	Paper Jam Count by Location	Horizontal Path Exit Sensor: On	CTL*	[0 to 65535 / 0 / 0/step]
7-519-106	Paper Jam Count by Location	Horizontal Path Exit Sensor: Off	CTL*	[0 to 65535 / 0 / 0/step]
7-519-115	Paper Jam Count by Location	Registration Motor	CTL*	[0 to 65535 / 0 / 0/step]
7-519-116	Paper Jam Count by Location	JG Crease Motor:JG	CTL*	[0 to 65535 / 0 / 0/step]
7-519-117	Paper Jam Count by Location	Transport Motor	CTL*	[0 to 65535 / 0 / 0/step]
7-519-118	Paper Jam Count by Location	1st Fold Motor	CTL*	[0 to 65535 / 0 / 0/step]
7-519-119	Paper Jam Count by Location	2nd Fold Motor	CTL*	[0 to 65535 / 0 / 0/step]
7-519-120	Paper Jam Count by Location	JG Crease Motor:Crease	CTL*	[0 to 65535 / 0 / 0/step]

3.SP Mode Tables

SP No.	Large Category	Small Category	ENG or CTL	[Min to Max/Init./Step]
7-519-144	Paper Jam Count by Location	Invalid Main Machine Data Setting	CTL*	[0 to 65535 / 0 / 0/step]
7-519-255	Paper Jam Count by Location	No Finsher Response	CTL*	[0 to 65535 / 0 / 0/step]
7-520-001	Update Log	ErrorRecord1	CTL*	[0 to 255 / 0 / 1/step]
7-520-002	Update Log	ErrorRecord2	CTL*	[0 to 255 / 0 / 1/step]
7-520-003	Update Log	ErrorRecord3	CTL*	[0 to 255 / 0 / 1/step]
7-520-004	Update Log	ErrorRecord4	CTL*	[0 to 255 / 0 / 1/step]
7-520-005	Update Log	ErrorRecord5	CTL*	[0 to 255 / 0 / 1/step]
7-520-006	Update Log	ErrorRecord6	CTL*	[0 to 255 / 0 / 1/step]
7-520-007	Update Log	ErrorRecord7	CTL*	[0 to 255 / 0 / 1/step]
7-520-008	Update Log	ErrorRecord8	CTL*	[0 to 255 / 0 / 1/step]
7-520-009	Update Log	ErrorRecord9	CTL*	[0 to 255 / 0 / 1/step]
7-520-010	Update Log	ErrorRecord10	CTL*	[0 to 255 / 0 / 1/step]
7-520-011	Update Log	Auto:StartDate1	CTL*	[0 to 0 / 0 / 0/step]
7-520-012	Update Log	Auto:StartDate2	CTL*	[0 to 0 / 0 / 0/step]
7-520-013	Update Log	Auto:StartDate3	CTL*	[0 to 0 / 0 / 0/step]
7-520-014	Update Log	Auto:StartDate4	CTL*	[0 to 0 / 0 / 0/step]
7-520-015	Update Log	Auto:StartDate5	CTL*	[0 to 0 / 0 / 0/step]
7-520-021	Update Log	Auto:EndDate1	CTL*	[0 to 0 / 0 / 0/step]

3.SP Mode Tables

SP No.	Large Category	Small Category	ENG or CTL	[Min to Max/Init./Step]
7-520-022	Update Log	Auto:EndDate2	CTL*	[0 to 0 / 0 / 0/step]
7-520-023	Update Log	Auto:EndDate3	CTL*	[0 to 0 / 0 / 0/step]
7-520-024	Update Log	Auto:EndDate4	CTL*	[0 to 0 / 0 / 0/step]
7-520-025	Update Log	Auto:EndDate5	CTL*	[0 to 0 / 0 / 0/step]
7-520-031	Update Log	Auto:Piecemark1	CTL*	[0 to 0 / 0 / 0/step]
7-520-032	Update Log	Auto:Piecemark2	CTL*	[0 to 0 / 0 / 0/step]
7-520-033	Update Log	Auto:Piecemark3	CTL*	[0 to 0 / 0 / 0/step]
7-520-034	Update Log	Auto:Piecemark4	CTL*	[0 to 0 / 0 / 0/step]
7-520-035	Update Log	Auto:Piecemark5	CTL*	[0 to 0 / 0 / 0/step]
7-520-041	Update Log	Auto:Version1	CTL*	[0 to 0 / 0 / 0/step]
7-520-042	Update Log	Auto:Version2	CTL*	[0 to 0 / 0 / 0/step]
7-520-043	Update Log	Auto:Version3	CTL*	[0 to 0 / 0 / 0/step]
7-520-044	Update Log	Auto:Version4	CTL*	[0 to 0 / 0 / 0/step]
7-520-045	Update Log	Auto:Version5	CTL*	[0 to 0 / 0 / 0/step]
7-520-051	Update Log	Auto:Result1	CTL*	[0 to 255 / 0 / 1/step]
7-520-052	Update Log	Auto:Result2	CTL*	[0 to 255 / 0 / 1/step]
7-520-053	Update Log	Auto:Result3	CTL*	[0 to 255 / 0 / 1/step]
7-520-054	Update Log	Auto:Result4	CTL*	[0 to 255 / 0 / 1/step]

3.SP Mode Tables

SP No.	Large Category	Small Category	ENG or CTL	[Min to Max/Init./Step]
7-520-055	Update Log	Auto:Result5	CTL*	[0 to 255 / 0 / 1/step]
7-520-056	Update Log	Auto:Result6	CTL*	[0 to 255 / 0 / 1/step]
7-520-057	Update Log	Auto:Result7	CTL*	[0 to 255 / 0 / 1/step]
7-520-058	Update Log	Auto:Result8	CTL*	[0 to 255 / 0 / 1/step]
7-520-059	Update Log	Auto:Result9	CTL*	[0 to 255 / 0 / 1/step]
7-520-060	Update Log	Auto:Result10	CTL*	[0 to 255 / 0 / 1/step]
7-617-001	PM Parts Counter Display	Normal	CTL*	[0 to 9999999 / 0 / 0/step]
7-617-002	PM Parts Counter Display	Df	CTL*	[0 to 9999999 / 0 / 0/step]
7-618-001	PM Parts Counter Reset	Normal	CTL	[0 to 0 / 0 / 0/step]
7-618-002	PM Parts Counter Reset	Df	CTL	[0 to 0 / 0 / 0/step]
7-624-002	Part Replacement Operation ON/OFF	Photoconductor Unit (Black)	CTL*	[0 to 1 / 1 / 1/step]
7-624-003	Part Replacement Operation ON/OFF	Development unit: Bk	CTL*	[0 to 1 / 1 / 1/step]
7-624-025	Part Replacement Operation ON/OFF	Photoconductor Unit (Cyan)	CTL*	[0 to 1 / 1 / 1/step]
7-624-026	Part Replacement Operation ON/OFF	Development unit: C	CTL*	[0 to 1 / 1 / 1/step]
7-624-048	Part Replacement Operation ON/OFF	Photoconductor Unit (Magenta)	CTL*	[0 to 1 / 1 / 1/step]
7-624-049	Part Replacement Operation ON/OFF	Development unit: M	CTL*	[0 to 1 / 1 / 1/step]
7-624-071	Part Replacement Operation ON/OFF	Photoconductor Unit (Yellow)	CTL*	[0 to 1 / 1 / 1/step]
7-624-072	Part Replacement Operation ON/OFF	Development unit: Y	CTL*	[0 to 1 / 1 / 1/step]

3.SP Mode Tables

SP No.	Large Category	Small Category	ENG or CTL	[Min to Max/Init./Step]
7-624-093	Part Replacement Operation ON/OFF	Intermediate Transfer Unit	CTL*	[0 to 1 / 1 / 1/step]
7-624-102	Part Replacement Operation ON/OFF	ITB Cleaning Unit	CTL*	[0 to 1 / 1 / 1/step]
7-624-109	Part Replacement Operation ON/OFF	Paper Transfer Unit	CTL*	[0 to 1 / 1 / 1/step]
7-624-115	Part Replacement Operation ON/OFF	Fuser Unit	CTL*	[0 to 1 / 1 / 1/step]
7-624-116	Part Replacement Operation ON/OFF	Fuser Unit: Belt	CTL*	[0 to 1 / 1 / 1/step]
7-624-118	Part Replacement Operation ON/OFF	Fuser Unit: Pressure Roller	CTL*	[0 to 1 / 1 / 1/step]
7-624-131	Part Replacement Operation ON/OFF	Dust Filter	CTL*	[0 to 1 / 1 / 1/step]
7-624-142	Part Replacement Operation ON/OFF	Waste Toner Bottle	CTL*	[0 to 1 / 1 / 1/step]
7-624-206	Part Replacement Operation ON/OFF	ADF Pick-up Roller	CTL*	[0 to 1 / 1 / 1/step]
7-624-207	Part Replacement Operation ON/OFF	ADF Transfer Belt	CTL*	[0 to 1 / 1 / 1/step]
7-624-208	Part Replacement Operation ON/OFF	ADF Reverse Rolle	CTL*	[0 to 1 / 1 / 1/step]
7-801-255	ROM No./ Firmware Version		CTL	[0 to 0 / 0 / 0/step]
7-803-001	PM Counter Display	Paper	CTL*	[0 to 9999999 / 0 / 0/step]
7-804-001	PM Counter Reset	Paper	CTL	[0 to 0 / 0 / 0/step]
7-807-001	SC/Jam Counter Reset		CTL	[0 to 0 / 0 / 0/step]
7-826-001	MF Error Counter	Error Total	CTL*	[0 to 9999999 / 0 / 0/step]
7-826-002	MF Error Counter	Error Staple	CTL*	[0 to 9999999 / 0 / 0/step]
7-827-001	MF Error Counter Clear		CTL	[0 to 0 / 0 / 0/step]

3.SP Mode Tables

SP No.	Large Category	Small Category	ENG or CTL	[Min to Max/Init./Step]
7-832-001	Self-Diagnose Result Display		CTL	[0 to 0 / 0 / 0/step]
7-835-001	ACC Counter	Copy ACC	CTL*	[0 to 9999999 / 0 / 0/step]
7-835-002	ACC Counter	Printer ACC	CTL*	[0 to 9999999 / 0 / 0/step]
7-836-001	Total Memory Size		CTL	[0 to 0xffffffff / 0 / 0MB/step]
7-840-001	ServiceSP Entry Code Chg Hist	Change Time :Latest	CTL*	[0 to 0 / 0 / 0/step]
7-840-002	ServiceSP Entry Code Chg Hist	Change Time :Last1	CTL*	[0 to 0 / 0 / 0/step]
7-840-101	ServiceSP Entry Code Chg Hist	Initialize Time :Latest	CTL*	[0 to 0 / 0 / 0/step]
7-840-102	ServiceSP Entry Code Chg Hist	Initialize Time :Last1	CTL*	[0 to 0 / 0 / 0/step]
7-841-001	HddSmartInfoNrs	1-9	CTL*	[0 to 0 / 0 / 0/step]
7-841-002	HddSmartInfoNrs	10-18	CTL*	[0 to 0 / 0 / 0/step]
7-841-003	HddSmartInfoNrs	19-27	CTL*	[0 to 0 / 0 / 0/step]
7-841-004	HddSmartInfoNrs	28	CTL*	[0 to 0 / 0 / 0/step]
7-841-051	HddSmartInfoSc	1-9	CTL*	[0 to 0 / 0 / 0/step]
7-841-052	HddSmartInfoSc	10-18	CTL*	[0 to 0 / 0 / 0/step]
7-841-053	HddSmartInfoSc	19-27	CTL*	[0 to 0 / 0 / 0/step]
7-841-054	HddSmartInfoSc	28	CTL*	[0 to 0 / 0 / 0/step]
7-855-001	Coverage Range	Coverage Range 1	CTL*	[1 to 200 / 5 / 1%/step]
7-855-002	Coverage Range	Coverage Range 2	CTL*	[1 to 200 / 20 / 1%/step]

3.SP Mode Tables

SP No.	Large Category	Small Category	ENG or CTL	[Min to Max/Init./Step]
7-901-001	Assert Info.	File Name	CTL*	[0 to 0 / 0 / 0/step]
7-901-002	Assert Info.	Number of Lines	CTL*	[0 to 0 / 0 / 0/step]
7-901-003	Assert Info.	Location	CTL*	[0 to 0 / 0 / 0/step]
7-910-001	ROM No	System/Copy	CTL	[0 to 0 / 0 / 0/step]
7-910-002	ROM No	Engine	CTL	[0 to 0 / 0 / 0/step]
7-910-003	ROM No	Lcdc	CTL	[0 to 0 / 0 / 0/step]
7-910-005	ROM No	ADF	CTL	[0 to 0 / 0 / 0/step]
7-910-007	ROM No	Finisher1	CTL	[0 to 0 / 0 / 0/step]
7-910-009	ROM No	Bank	CTL	[0 to 0 / 0 / 0/step]
7-910-010	ROM No	LCT	CTL	[0 to 0 / 0 / 0/step]
7-910-012	ROM No	FCU	CTL	[0 to 0 / 0 / 0/step]
7-910-018	ROM No	NetworkSupport	CTL	[0 to 0 / 0 / 0/step]
7-910-022	ROM No	BIOS	CTL	[0 to 0 / 0 / 0/step]
7-910-023	ROM No	HDD Format Option	CTL	[0 to 0 / 0 / 0/step]
7-910-025	ROM No	Folding Unit	CTL	[0 to 0 / 0 / 0/step]
7-910-150	ROM No	RPCS	CTL	[0 to 0 / 0 / 0/step]
7-910-151	ROM No	PS	CTL	[0 to 0 / 0 / 0/step]
7-910-152	ROM No	RPDL	CTL	[0 to 0 / 0 / 0/step]

3.SP Mode Tables

SP No.	Large Category	Small Category	ENG or CTL	[Min to Max/Init./Step]
7-910-153	ROM No	R98	CTL	[0 to 0 / 0 / 0/step]
7-910-154	ROM No	R16	CTL	[0 to 0 / 0 / 0/step]
7-910-155	ROM No	RPGL	CTL	[0 to 0 / 0 / 0/step]
7-910-156	ROM No	R55	CTL	[0 to 0 / 0 / 0/step]
7-910-157	ROM No	RTIFF	CTL	[0 to 0 / 0 / 0/step]
7-910-158	ROM No	PCL	CTL	[0 to 0 / 0 / 0/step]
7-910-159	ROM No	PCLXL	CTL	[0 to 0 / 0 / 0/step]
7-910-160	ROM No	MSIS	CTL	[0 to 0 / 0 / 0/step]
7-910-162	ROM No	PDF	CTL	[0 to 0 / 0 / 0/step]
7-910-164	ROM No	PictBridge	CTL	[0 to 0 / 0 / 0/step]
7-910-165	ROM No	PJL	CTL	[0 to 0 / 0 / 0/step]
7-910-166	ROM No (IM C6000/C5500/C4500 only)	IPDS	CTL	[0 to 0 / 0 / 0/step]
7-910-167	ROM No	MediaPrint:JPEG	CTL	[0 to 0 / 0 / 0/step]
7-910-168	ROM No	MediaPrint:TIFF	CTL	[0 to 0 / 0 / 0/step]
7-910-169	ROM No	XPS	CTL	[0 to 0 / 0 / 0/step]
7-910-180	ROM No	FONT	CTL	[0 to 0 / 0 / 0/step]
7-910-181	ROM No	FONT1	CTL	[0 to 0 / 0 / 0/step]
7-910-	ROM No	FONT2	CTL	[0 to 0 / 0 / 0/step]

3.SP Mode Tables

SP No.	Large Category	Small Category	ENG or CTL	[Min to Max/Init./Step]
182				
7-910-183	ROM No	FONT3	CTL	[0 to 0 / 0 / 0/step]
7-910-184	ROM No	FONT4	CTL	[0 to 0 / 0 / 0/step]
7-910-185	ROM No	FONT5	CTL	[0 to 0 / 0 / 0/step]
7-910-186	ROM No	FONT6	CTL	[0 to 0 / 0 / 0/step]
7-910-187	ROM No	FONT7	CTL	[0 to 0 / 0 / 0/step]
7-910-200	ROM No	Factory	CTL	[0 to 0 / 0 / 0/step]
7-910-201	ROM No	Copy	CTL	[0 to 0 / 0 / 0/step]
7-910-202	ROM No	NetworkDocBox	CTL	[0 to 0 / 0 / 0/step]
7-910-203	ROM No	Fax	CTL	[0 to 0 / 0 / 0/step]
7-910-204	ROM No	Printer	CTL	[0 to 0 / 0 / 0/step]
7-910-205	ROM No	Scanner	CTL	[0 to 0 / 0 / 0/step]
7-910-206	ROM No	RFax	CTL	[0 to 0 / 0 / 0/step]
7-910-210	ROM No	MIB	CTL	[0 to 0 / 0 / 0/step]
7-910-211	ROM No	Websupport	CTL	[0 to 0 / 0 / 0/step]
7-910-212	ROM No	WebUapl	CTL	[0 to 0 / 0 / 0/step]
7-910-213	ROM No	SDK1	CTL	[0 to 0 / 0 / 0/step]
7-910-214	ROM No	SDK2	CTL	[0 to 0 / 0 / 0/step]
7-910-	ROM No	SDK3	CTL	[0 to 0 / 0 / 0/step]

3.SP Mode Tables

SP No.	Large Category	Small Category	ENG or CTL	[Min to Max/Init./Step]
215				
7-910-250	ROM No	Package	CTL	[0 to 0 / 0 / 0/step]
7-911-001	Firmware Version	System/Copy	CTL	[0 to 0 / 0 / 0/step]
7-911-002	Firmware Version	Engine	CTL	[0 to 0 / 0 / 0/step]
7-911-003	Firmware Version	Lcdc	CTL	[0 to 0 / 0 / 0/step]
7-911-005	Firmware Version	ADF	CTL	[0 to 0 / 0 / 0/step]
7-911-007	Firmware Version	Finisher1	CTL	[0 to 0 / 0 / 0/step]
7-911-009	Firmware Version	Bank	CTL	[0 to 0 / 0 / 0/step]
7-911-010	Firmware Version	LCT	CTL	[0 to 0 / 0 / 0/step]
7-911-012	Firmware Version	FCU	CTL	[0 to 0 / 0 / 0/step]
7-911-018	Firmware Version	NetworkSupport	CTL	[0 to 0 / 0 / 0/step]
7-911-022	Firmware Version	BIOS	CTL	[0 to 0 / 0 / 0/step]
7-911-023	Firmware Version	HDD Format Option	CTL	[0 to 0 / 0 / 0/step]
7-911-025	Firmware Version	Folding Unit	CTL	[0 to 0 / 0 / 0/step]
7-911-150	Firmware Version	RPCS	CTL	[0 to 0 / 0 / 0/step]
7-911-151	Firmware Version	PS	CTL	[0 to 0 / 0 / 0/step]
7-911-152	Firmware Version	RPDL	CTL	[0 to 0 / 0 / 0/step]
7-911-153	Firmware Version	R98	CTL	[0 to 0 / 0 / 0/step]
7-911-	Firmware Version	R16	CTL	[0 to 0 / 0 / 0/step]

3.SP Mode Tables

SP No.	Large Category	Small Category	ENG or CTL	[Min to Max/Init./Step]
154				
7-911-155	Firmware Version	RPGL	CTL	[0 to 0 / 0 / 0/step]
7-911-156	Firmware Version	R55	CTL	[0 to 0 / 0 / 0/step]
7-911-157	Firmware Version	RTIFF	CTL	[0 to 0 / 0 / 0/step]
7-911-158	Firmware Version	PCL	CTL	[0 to 0 / 0 / 0/step]
7-911-159	Firmware Version	PCLXL	CTL	[0 to 0 / 0 / 0/step]
7-911-160	Firmware Version	MSIS	CTL	[0 to 0 / 0 / 0/step]
7-911-162	Firmware Version	PDF	CTL	[0 to 0 / 0 / 0/step]
7-911-164	Firmware Version	PictBridge	CTL	[0 to 0 / 0 / 0/step]
7-911-165	Firmware Version	PJL	CTL	[0 to 0 / 0 / 0/step]
7-911-166	Firmware Version (IM C6000/C5500/C4500 only)	IPDS	CTL	[0 to 0 / 0 / 0/step]
7-911-167	Firmware Version	MediaPrint:JPEG	CTL	[0 to 0 / 0 / 0/step]
7-911-168	Firmware Version	MediaPrint:TIFF	CTL	[0 to 0 / 0 / 0/step]
7-911-169	Firmware Version	XPS	CTL	[0 to 0 / 0 / 0/step]
7-911-180	Firmware Version	FONT	CTL	[0 to 0 / 0 / 0/step]
7-911-181	Firmware Version	FONT1	CTL	[0 to 0 / 0 / 0/step]
7-911-182	Firmware Version	FONT2	CTL	[0 to 0 / 0 / 0/step]
7-911-183	Firmware Version	FONT3	CTL	[0 to 0 / 0 / 0/step]

3.SP Mode Tables

SP No.	Large Category	Small Category	ENG or CTL	[Min to Max/Init./Step]
7-911-184	Firmware Version	FONT4	CTL	[0 to 0 / 0 / 0/step]
7-911-185	Firmware Version	FONT5	CTL	[0 to 0 / 0 / 0/step]
7-911-186	Firmware Version	FONT6	CTL	[0 to 0 / 0 / 0/step]
7-911-187	Firmware Version	FONT7	CTL	[0 to 0 / 0 / 0/step]
7-911-200	Firmware Version	Factory	CTL	[0 to 0 / 0 / 0/step]
7-911-201	Firmware Version	Copy	CTL	[0 to 0 / 0 / 0/step]
7-911-202	Firmware Version	NetworkDocBox	CTL	[0 to 0 / 0 / 0/step]
7-911-203	Firmware Version	Fax	CTL	[0 to 0 / 0 / 0/step]
7-911-204	Firmware Version	Printer	CTL	[0 to 0 / 0 / 0/step]
7-911-205	Firmware Version	Scanner	CTL	[0 to 0 / 0 / 0/step]
7-911-206	Firmware Version	RFax	CTL	[0 to 0 / 0 / 0/step]
7-911-210	Firmware Version	MIB	CTL	[0 to 0 / 0 / 0/step]
7-911-211	Firmware Version	Websupport	CTL	[0 to 0 / 0 / 0/step]
7-911-212	Firmware Version	WebUapl	CTL	[0 to 0 / 0 / 0/step]
7-911-213	Firmware Version	SDK1	CTL	[0 to 0 / 0 / 0/step]
7-911-214	Firmware Version	SDK2	CTL	[0 to 0 / 0 / 0/step]
7-911-215	Firmware Version	SDK3	CTL	[0 to 0 / 0 / 0/step]
7-911-250	Firmware Version	Package	CTL	[0 to 0 / 0 / 0/step]

3.SP Mode Tables

Controller SP Tables-8

SP8-XXX (Data Log 2)-1

SP No.	Large Category	Small Category	ENG or CTL	[Min to Max/Init./Step]
8-001-001	T:Total Jobs		CTL*	[0 to 99999999 / 0 / 1/step]
8-002-001	C:Total Jobs		CTL*	[0 to 99999999 / 0 / 1/step]
8-003-001	F:Total Jobs		CTL*	[0 to 99999999 / 0 / 1/step]
8-004-001	P:Total Jobs		CTL*	[0 to 99999999 / 0 / 1/step]
8-005-001	S:Total Jobs		CTL*	[0 to 99999999 / 0 / 1/step]
8-006-001	L:Total Jobs		CTL*	[0 to 99999999 / 0 / 1/step]
8-011-001	T:Jobs/LS		CTL*	[0 to 99999999 / 0 / 1/step]
8-012-001	C:Jobs/LS		CTL*	[0 to 99999999 / 0 / 1/step]
8-013-001	F:Jobs/LS		CTL*	[0 to 99999999 / 0 / 1/step]
8-014-001	P:Jobs/LS		CTL*	[0 to 99999999 / 0 / 1/step]
8-015-001	S:Jobs/LS		CTL*	[0 to 99999999 / 0 / 1/step]
8-016-001	L:Jobs/LS		CTL*	[0 to 99999999 / 0 / 1/step]
8-017-001	O:Jobs/LS		CTL*	[0 to 99999999 / 0 / 1/step]
8-021-001	T:Pjob/LS		CTL*	[0 to 99999999 / 0 / 1/step]
8-022-001	C:Pjob/LS		CTL*	[0 to 99999999 / 0 / 1/step]
8-023-001	F:Pjob/LS		CTL*	[0 to 99999999 / 0 / 1/step]
8-024-001	P:Pjob/LS		CTL*	[0 to 99999999 / 0 / 1/step]

3.SP Mode Tables

SP No.	Large Category	Small Category	ENG or CTL	[Min to Max/Init./Step]
001				1/step]
8-025-001	S:Pjob/LS		CTL*	[0 to 99999999 / 0 / 1/step]
8-026-001	L:Pjob/LS		CTL*	[0 to 99999999 / 0 / 1/step]
8-027-001	O:Pjob/LS		CTL*	[0 to 99999999 / 0 / 1/step]
8-031-001	T:Pjob/DesApl		CTL*	[0 to 99999999 / 0 / 1/step]
8-032-001	C:Pjob/DesApl		CTL*	[0 to 99999999 / 0 / 1/step]
8-033-001	F:Pjob/DesApl		CTL*	[0 to 99999999 / 0 / 1/step]
8-034-001	P:Pjob/DesApl		CTL*	[0 to 99999999 / 0 / 1/step]
8-035-001	S:Pjob/DesApl		CTL*	[0 to 99999999 / 0 / 1/step]
8-036-001	L:Pjob/DesApl		CTL*	[0 to 99999999 / 0 / 1/step]
8-037-001	O:Pjob/DesApl		CTL*	[0 to 99999999 / 0 / 1/step]
8-041-001	T:TX Jobs/LS		CTL*	[0 to 99999999 / 0 / 1/step]
8-042-001	C:TX Jobs/LS		CTL*	[0 to 99999999 / 0 / 1/step]
8-043-001	F:TX Jobs/LS		CTL*	[0 to 99999999 / 0 / 1/step]
8-044-001	P:TX Jobs/LS		CTL*	[0 to 99999999 / 0 / 1/step]
8-045-001	S:TX Jobs/LS		CTL*	[0 to 99999999 / 0 / 1/step]
8-046-001	L:TX Jobs/LS		CTL*	[0 to 99999999 / 0 / 1/step]
8-047-001	O:TX Jobs/LS		CTL*	[0 to 99999999 / 0 / 1/step]
8-051-	T:TX Jobs/DesApl		CTL*	[0 to 99999999 / 0 /

3.SP Mode Tables

SP No.	Large Category	Small Category	ENG or CTL	[Min to Max/Init./Step]
001				1/step]
8-052-001	C:TX Jobs/DesApl		CTL*	[0 to 99999999 / 0 / 1/step]
8-053-001	F:TX Jobs/DesApl		CTL*	[0 to 99999999 / 0 / 1/step]
8-054-001	P:TX Jobs/DesApl		CTL*	[0 to 99999999 / 0 / 1/step]
8-055-001	S:TX Jobs/DesApl		CTL*	[0 to 99999999 / 0 / 1/step]
8-056-001	L:TX Jobs/DesApl		CTL*	[0 to 99999999 / 0 / 1/step]
8-057-001	O:TX Jobs/DesApl		CTL*	[0 to 99999999 / 0 / 1/step]
8-061-001	T:FIN Jobs	Sort	CTL*	[0 to 99999999 / 0 / 1/step]
8-061-002	T:FIN Jobs	Stack	CTL*	[0 to 99999999 / 0 / 1/step]
8-061-003	T:FIN Jobs	Staple	CTL*	[0 to 99999999 / 0 / 1/step]
8-061-004	T:FIN Jobs	Booklet	CTL*	[0 to 99999999 / 0 / 1/step]
8-061-005	T:FIN Jobs	Z-Fold	CTL*	[0 to 99999999 / 0 / 1/step]
8-061-006	T:FIN Jobs	Punch	CTL*	[0 to 99999999 / 0 / 1/step]
8-061-007	T:FIN Jobs	Other	CTL*	[0 to 99999999 / 0 / 1/step]
8-061-008	T:FIN Jobs	Inside-Fold	CTL*	[0 to 99999999 / 0 / 1/step]
8-061-009	T:FIN Jobs	Three-IN-Fold	CTL*	[0 to 99999999 / 0 / 1/step]
8-061-010	T:FIN Jobs	Three-OUT-Fold	CTL*	[0 to 99999999 / 0 / 1/step]
8-061-011	T:FIN Jobs	Four-Fold	CTL*	[0 to 99999999 / 0 / 1/step]
8-061-	T:FIN Jobs	KANNON-Fold	CTL*	[0 to 99999999 / 0 /

3.SP Mode Tables

SP No.	Large Category	Small Category	ENG or CTL	[Min to Max/Init./Step]
012				1/step]
8-061-013	T:FIN Jobs	Perfect-Bind	CTL*	[0 to 99999999 / 0 / 1/step]
8-061-014	T:FIN Jobs	Ring-Bind	CTL*	[0 to 99999999 / 0 / 1/step]
8-061-015	T:FIN Jobs	3rd Vendor	CTL*	[0 to 99999999 / 0 / 1/step]
8-061-016	T:FIN Jobs	TwinLoop-Bind	CTL*	[0 to 99999999 / 0 / 1/step]
8-062-001	C:FIN Jobs	Sort	CTL*	[0 to 99999999 / 0 / 1/step]
8-062-002	C:FIN Jobs	Stack	CTL*	[0 to 99999999 / 0 / 1/step]
8-062-003	C:FIN Jobs	Staple	CTL*	[0 to 99999999 / 0 / 1/step]
8-062-004	C:FIN Jobs	Booklet	CTL*	[0 to 99999999 / 0 / 1/step]
8-062-005	C:FIN Jobs	Z-Fold	CTL*	[0 to 99999999 / 0 / 1/step]
8-062-006	C:FIN Jobs	Punch	CTL*	[0 to 99999999 / 0 / 1/step]
8-062-007	C:FIN Jobs	Other	CTL*	[0 to 99999999 / 0 / 1/step]
8-062-008	C:FIN Jobs	Inside-Fold	CTL*	[0 to 99999999 / 0 / 1/step]
8-062-009	C:FIN Jobs	Three-IN-Fold	CTL*	[0 to 99999999 / 0 / 1/step]
8-062-010	C:FIN Jobs	Three-OUT-Fold	CTL*	[0 to 99999999 / 0 / 1/step]
8-062-011	C:FIN Jobs	Four-Fold	CTL*	[0 to 99999999 / 0 / 1/step]
8-062-012	C:FIN Jobs	KANNON-Fold	CTL*	[0 to 99999999 / 0 / 1/step]
8-062-013	C:FIN Jobs	Perfect-Bind	CTL*	[0 to 99999999 / 0 / 1/step]
8-062-	C:FIN Jobs	Ring-Bind	CTL*	[0 to 99999999 / 0 /

3.SP Mode Tables

SP No.	Large Category	Small Category	ENG or CTL	[Min to Max/Init./Step]
014				1/step]
8-062-015	C:FIN Jobs	3rd Vendor	CTL*	[0 to 99999999 / 0 / 1/step]
8-062-016	C:FIN Jobs	TwinLoop-Bind	CTL*	[0 to 99999999 / 0 / 1/step]
8-063-001	F:FIN Jobs	Sort	CTL*	[0 to 99999999 / 0 / 1/step]
8-063-002	F:FIN Jobs	Stack	CTL*	[0 to 99999999 / 0 / 1/step]
8-063-003	F:FIN Jobs	Staple	CTL*	[0 to 99999999 / 0 / 1/step]
8-063-004	F:FIN Jobs	Booklet	CTL*	[0 to 99999999 / 0 / 1/step]
8-063-005	F:FIN Jobs	Z-Fold	CTL*	[0 to 99999999 / 0 / 1/step]
8-063-006	F:FIN Jobs	Punch	CTL*	[0 to 99999999 / 0 / 1/step]
8-063-007	F:FIN Jobs	Other	CTL*	[0 to 99999999 / 0 / 1/step]
8-063-008	F:FIN Jobs	Inside-Fold	CTL*	[0 to 99999999 / 0 / 1/step]
8-063-009	F:FIN Jobs	Three-IN-Fold	CTL*	[0 to 99999999 / 0 / 1/step]
8-063-010	F:FIN Jobs	Three-OUT-Fold	CTL*	[0 to 99999999 / 0 / 1/step]
8-063-011	F:FIN Jobs	Four-Fold	CTL*	[0 to 99999999 / 0 / 1/step]
8-063-012	F:FIN Jobs	KANNON-Fold	CTL*	[0 to 99999999 / 0 / 1/step]
8-063-013	F:FIN Jobs	Perfect-Bind	CTL*	[0 to 99999999 / 0 / 1/step]
8-063-014	F:FIN Jobs	Ring-Bind	CTL*	[0 to 99999999 / 0 / 1/step]
8-063-015	F:FIN Jobs	3rd Vendor	CTL*	[0 to 99999999 / 0 / 1/step]
8-063-	F:FIN Jobs	TwinLoop-Bind	CTL*	[0 to 99999999 / 0 /

3.SP Mode Tables

SP No.	Large Category	Small Category	ENG or CTL	[Min to Max/Init./Step]
016				1/step]
8-064-001	P:FIN Jobs	Sort	CTL*	[0 to 99999999 / 0 / 1/step]
8-064-002	P:FIN Jobs	Stack	CTL*	[0 to 99999999 / 0 / 1/step]
8-064-003	P:FIN Jobs	Staple	CTL*	[0 to 99999999 / 0 / 1/step]
8-064-004	P:FIN Jobs	Booklet	CTL*	[0 to 99999999 / 0 / 1/step]
8-064-005	P:FIN Jobs	Z-Fold	CTL*	[0 to 99999999 / 0 / 1/step]
8-064-006	P:FIN Jobs	Punch	CTL*	[0 to 99999999 / 0 / 1/step]
8-064-007	P:FIN Jobs	Other	CTL*	[0 to 99999999 / 0 / 1/step]
8-064-008	P:FIN Jobs	Inside-Fold	CTL*	[0 to 99999999 / 0 / 1/step]
8-064-009	P:FIN Jobs	Three-IN-Fold	CTL*	[0 to 99999999 / 0 / 1/step]
8-064-010	P:FIN Jobs	Three-OUT-Fold	CTL*	[0 to 99999999 / 0 / 1/step]
8-064-011	P:FIN Jobs	Four-Fold	CTL*	[0 to 99999999 / 0 / 1/step]
8-064-012	P:FIN Jobs	KANNON-Fold	CTL*	[0 to 99999999 / 0 / 1/step]
8-064-013	P:FIN Jobs	Perfect-Bind	CTL*	[0 to 99999999 / 0 / 1/step]
8-064-014	P:FIN Jobs	Ring-Bind	CTL*	[0 to 99999999 / 0 / 1/step]
8-064-015	P:FIN Jobs	3rd Vendor	CTL*	[0 to 99999999 / 0 / 1/step]
8-064-016	P:FIN Jobs	TwinLoop-Bind	CTL*	[0 to 99999999 / 0 / 1/step]
8-065-001	S:FIN Jobs	Sort	CTL*	[0 to 99999999 / 0 / 1/step]
8-065-	S:FIN Jobs	Stack	CTL*	[0 to 99999999 / 0 /

3.SP Mode Tables

SP No.	Large Category	Small Category	ENG or CTL	[Min to Max/Init./Step]
002				1/step]
8-065-003	S:FIN Jobs	Staple	CTL*	[0 to 99999999 / 0 / 1/step]
8-065-004	S:FIN Jobs	Booklet	CTL*	[0 to 99999999 / 0 / 1/step]
8-065-005	S:FIN Jobs	Z-Fold	CTL*	[0 to 99999999 / 0 / 1/step]
8-065-006	S:FIN Jobs	Punch	CTL*	[0 to 99999999 / 0 / 1/step]
8-065-007	S:FIN Jobs	Other	CTL*	[0 to 99999999 / 0 / 1/step]
8-065-008	S:FIN Jobs	Inside-Fold	CTL*	[0 to 99999999 / 0 / 1/step]
8-065-009	S:FIN Jobs	Three-IN-Fold	CTL*	[0 to 99999999 / 0 / 1/step]
8-065-010	S:FIN Jobs	Three-OUT-Fold	CTL*	[0 to 99999999 / 0 / 1/step]
8-065-011	S:FIN Jobs	Four-Fold	CTL*	[0 to 99999999 / 0 / 1/step]
8-065-012	S:FIN Jobs	KANNON-Fold	CTL*	[0 to 99999999 / 0 / 1/step]
8-065-013	S:FIN Jobs	Perfect-Bind	CTL*	[0 to 99999999 / 0 / 1/step]
8-065-014	S:FIN Jobs	Ring-Bind	CTL*	[0 to 99999999 / 0 / 1/step]
8-065-015	S:FIN Jobs	3rd Vendor	CTL*	[0 to 99999999 / 0 / 1/step]
8-065-016	S:FIN Jobs	TwinLoop-Bind	CTL*	[0 to 99999999 / 0 / 1/step]
8-066-001	L:FIN Jobs	Sort	CTL*	[0 to 99999999 / 0 / 1/step]
8-066-002	L:FIN Jobs	Stack	CTL*	[0 to 99999999 / 0 / 1/step]
8-066-003	L:FIN Jobs	Staple	CTL*	[0 to 99999999 / 0 / 1/step]
8-066-	L:FIN Jobs	Booklet	CTL*	[0 to 99999999 / 0 /

3.SP Mode Tables

SP No.	Large Category	Small Category	ENG or CTL	[Min to Max/Init./Step]
004				1/step]
8-066-005	L:FIN Jobs	Z-Fold	CTL*	[0 to 99999999 / 0 / 1/step]
8-066-006	L:FIN Jobs	Punch	CTL*	[0 to 99999999 / 0 / 1/step]
8-066-007	L:FIN Jobs	Other	CTL*	[0 to 99999999 / 0 / 1/step]
8-066-008	L:FIN Jobs	Inside-Fold	CTL*	[0 to 99999999 / 0 / 1/step]
8-066-009	L:FIN Jobs	Three-IN-Fold	CTL*	[0 to 99999999 / 0 / 1/step]
8-066-010	L:FIN Jobs	Three-OUT-Fold	CTL*	[0 to 99999999 / 0 / 1/step]
8-066-011	L:FIN Jobs	Four-Fold	CTL*	[0 to 99999999 / 0 / 1/step]
8-066-012	L:FIN Jobs	KANNON-Fold	CTL*	[0 to 99999999 / 0 / 1/step]
8-066-013	L:FIN Jobs	Perfect-Bind	CTL*	[0 to 99999999 / 0 / 1/step]
8-066-014	L:FIN Jobs	Ring-Bind	CTL*	[0 to 99999999 / 0 / 1/step]
8-066-015	L:FIN Jobs	3rd Vendor	CTL*	[0 to 99999999 / 0 / 1/step]
8-066-016	L:FIN Jobs	TwinLoop-Bind	CTL*	[0 to 99999999 / 0 / 1/step]
8-067-001	O:FIN Jobs	Sort	CTL*	[0 to 99999999 / 0 / 1/step]
8-067-002	O:FIN Jobs	Stack	CTL*	[0 to 99999999 / 0 / 1/step]
8-067-003	O:FIN Jobs	Staple	CTL*	[0 to 99999999 / 0 / 1/step]
8-067-004	O:FIN Jobs	Booklet	CTL*	[0 to 99999999 / 0 / 1/step]
8-067-005	O:FIN Jobs	Z-Fold	CTL*	[0 to 99999999 / 0 / 1/step]
8-067-	O:FIN Jobs	Punch	CTL*	[0 to 99999999 / 0 /

3.SP Mode Tables

SP No.	Large Category	Small Category	ENG or CTL	[Min to Max/Init./Step]
006				1/step]
8-067-007	O:FIN Jobs	Other	CTL*	[0 to 99999999 / 0 / 1/step]
8-067-008	O:FIN Jobs	Inside-Fold	CTL*	[0 to 99999999 / 0 / 1/step]
8-067-009	O:FIN Jobs	Three-IN-Fold	CTL*	[0 to 99999999 / 0 / 1/step]
8-067-010	O:FIN Jobs	Three-OUT-Fold	CTL*	[0 to 99999999 / 0 / 1/step]
8-067-011	O:FIN Jobs	Four-Fold	CTL*	[0 to 99999999 / 0 / 1/step]
8-067-012	O:FIN Jobs	KANNON-Fold	CTL*	[0 to 99999999 / 0 / 1/step]
8-067-013	O:FIN Jobs	Perfect-Bind	CTL*	[0 to 99999999 / 0 / 1/step]
8-067-014	O:FIN Jobs	Ring-Bind	CTL*	[0 to 99999999 / 0 / 1/step]
8-067-015	O:FIN Jobs	3rd Vendor	CTL*	[0 to 99999999 / 0 / 1/step]
8-067-016	O:FIN Jobs	TwinLoop-Bind	CTL*	[0 to 99999999 / 0 / 1/step]
8-071-001	T:Jobs/PGS	1 Page	CTL*	[0 to 99999999 / 0 / 1/step]
8-071-002	T:Jobs/PGS	2 Pages	CTL*	[0 to 99999999 / 0 / 1/step]
8-071-003	T:Jobs/PGS	3 Pages	CTL*	[0 to 99999999 / 0 / 1/step]
8-071-004	T:Jobs/PGS	4 Pages	CTL*	[0 to 99999999 / 0 / 1/step]
8-071-005	T:Jobs/PGS	5 Pages	CTL*	[0 to 99999999 / 0 / 1/step]
8-071-006	T:Jobs/PGS	6~10 Pages	CTL*	[0 to 99999999 / 0 / 1/step]
8-071-007	T:Jobs/PGS	11~20 Pages	CTL*	[0 to 99999999 / 0 / 1/step]
8-071-	T:Jobs/PGS	21~50 Pages	CTL*	[0 to 99999999 / 0 /

3.SP Mode Tables

SP No.	Large Category	Small Category	ENG or CTL	[Min to Max/Init./Step]
008				1/step]
8-071-009	T:Jobs/PGS	51~100 Pages	CTL*	[0 to 99999999 / 0 / 1/step]
8-071-010	T:Jobs/PGS	101~300 Pages	CTL*	[0 to 99999999 / 0 / 1/step]
8-071-011	T:Jobs/PGS	301~500 Pages	CTL*	[0 to 99999999 / 0 / 1/step]
8-071-012	T:Jobs/PGS	501~700 Pages	CTL*	[0 to 99999999 / 0 / 1/step]
8-071-013	T:Jobs/PGS	701~1000 Pages	CTL*	[0 to 99999999 / 0 / 1/step]
8-071-014	T:Jobs/PGS	1001~ Pages	CTL*	[0 to 99999999 / 0 / 1/step]
8-072-001	C:Jobs/PGS	1 Page	CTL*	[0 to 99999999 / 0 / 1/step]
8-072-002	C:Jobs/PGS	2 Pages	CTL*	[0 to 99999999 / 0 / 1/step]
8-072-003	C:Jobs/PGS	3 Pages	CTL*	[0 to 99999999 / 0 / 1/step]
8-072-004	C:Jobs/PGS	4 Pages	CTL*	[0 to 99999999 / 0 / 1/step]
8-072-005	C:Jobs/PGS	5 Pages	CTL*	[0 to 99999999 / 0 / 1/step]
8-072-006	C:Jobs/PGS	6~10 Pages	CTL*	[0 to 99999999 / 0 / 1/step]
8-072-007	C:Jobs/PGS	11~20 Pages	CTL*	[0 to 99999999 / 0 / 1/step]
8-072-008	C:Jobs/PGS	21~50 Pages	CTL*	[0 to 99999999 / 0 / 1/step]
8-072-009	C:Jobs/PGS	51~100 Pages	CTL*	[0 to 99999999 / 0 / 1/step]
8-072-010	C:Jobs/PGS	101~300 Pages	CTL*	[0 to 99999999 / 0 / 1/step]
8-072-011	C:Jobs/PGS	301~500 Pages	CTL*	[0 to 99999999 / 0 / 1/step]
8-072-	C:Jobs/PGS	501~700 Pages	CTL*	[0 to 99999999 / 0 /

3.SP Mode Tables

SP No.	Large Category	Small Category	ENG or CTL	[Min to Max/Init./Step]
012				1/step]
8-072-013	C:Jobs/PGS	701~1000 Pages	CTL*	[0 to 99999999 / 0 / 1/step]
8-072-014	C:Jobs/PGS	1001~ Pages	CTL*	[0 to 99999999 / 0 / 1/step]
8-073-001	F:Jobs/PGS	1 Page	CTL*	[0 to 99999999 / 0 / 1/step]
8-073-002	F:Jobs/PGS	2 Pages	CTL*	[0 to 99999999 / 0 / 1/step]
8-073-003	F:Jobs/PGS	3 Pages	CTL*	[0 to 99999999 / 0 / 1/step]
8-073-004	F:Jobs/PGS	4 Pages	CTL*	[0 to 99999999 / 0 / 1/step]
8-073-005	F:Jobs/PGS	5 Pages	CTL*	[0 to 99999999 / 0 / 1/step]
8-073-006	F:Jobs/PGS	6~10 Pages	CTL*	[0 to 99999999 / 0 / 1/step]
8-073-007	F:Jobs/PGS	11~20 Pages	CTL*	[0 to 99999999 / 0 / 1/step]
8-073-008	F:Jobs/PGS	21~50 Pages	CTL*	[0 to 99999999 / 0 / 1/step]
8-073-009	F:Jobs/PGS	51~100 Pages	CTL*	[0 to 99999999 / 0 / 1/step]
8-073-010	F:Jobs/PGS	101~300 Pages	CTL*	[0 to 99999999 / 0 / 1/step]
8-073-011	F:Jobs/PGS	301~500 Pages	CTL*	[0 to 99999999 / 0 / 1/step]
8-073-012	F:Jobs/PGS	501~700 Pages	CTL*	[0 to 99999999 / 0 / 1/step]
8-073-013	F:Jobs/PGS	701~1000 Pages	CTL*	[0 to 99999999 / 0 / 1/step]
8-073-014	F:Jobs/PGS	1001~ Pages	CTL*	[0 to 99999999 / 0 / 1/step]
8-074-001	P:Jobs/PGS	1 Page	CTL*	[0 to 99999999 / 0 / 1/step]
8-074-	P:Jobs/PGS	2 Pages	CTL*	[0 to 99999999 / 0 /

3.SP Mode Tables

SP No.	Large Category	Small Category	ENG or CTL	[Min to Max/Init./Step]
002				1/step]
8-074-003	P:Jobs/PGS	3 Pages	CTL*	[0 to 99999999 / 0 / 1/step]
8-074-004	P:Jobs/PGS	4 Pages	CTL*	[0 to 99999999 / 0 / 1/step]
8-074-005	P:Jobs/PGS	5 Pages	CTL*	[0 to 99999999 / 0 / 1/step]
8-074-006	P:Jobs/PGS	6~10 Pages	CTL*	[0 to 99999999 / 0 / 1/step]
8-074-007	P:Jobs/PGS	11~20 Pages	CTL*	[0 to 99999999 / 0 / 1/step]
8-074-008	P:Jobs/PGS	21~50 Pages	CTL*	[0 to 99999999 / 0 / 1/step]
8-074-009	P:Jobs/PGS	51~100 Pages	CTL*	[0 to 99999999 / 0 / 1/step]
8-074-010	P:Jobs/PGS	101~300 Pages	CTL*	[0 to 99999999 / 0 / 1/step]
8-074-011	P:Jobs/PGS	301~500 Pages	CTL*	[0 to 99999999 / 0 / 1/step]
8-074-012	P:Jobs/PGS	501~700 Pages	CTL*	[0 to 99999999 / 0 / 1/step]
8-074-013	P:Jobs/PGS	701~1000 Pages	CTL*	[0 to 99999999 / 0 / 1/step]
8-074-014	P:Jobs/PGS	1001~ Pages	CTL*	[0 to 99999999 / 0 / 1/step]
8-075-001	S:Jobs/PGS	1 Page	CTL*	[0 to 99999999 / 0 / 1/step]
8-075-002	S:Jobs/PGS	2 Pages	CTL*	[0 to 99999999 / 0 / 1/step]
8-075-003	S:Jobs/PGS	3 Pages	CTL*	[0 to 99999999 / 0 / 1/step]
8-075-004	S:Jobs/PGS	4 Pages	CTL*	[0 to 99999999 / 0 / 1/step]
8-075-005	S:Jobs/PGS	5 Pages	CTL*	[0 to 99999999 / 0 / 1/step]
8-075-	S:Jobs/PGS	6~10 Pages	CTL*	[0 to 99999999 / 0 /

3.SP Mode Tables

SP No.	Large Category	Small Category	ENG or CTL	[Min to Max/Init./Step]
006				1/step]
8-075-007	S:Jobs/PGS	11~20 Pages	CTL*	[0 to 99999999 / 0 / 1/step]
8-075-008	S:Jobs/PGS	21~50 Pages	CTL*	[0 to 99999999 / 0 / 1/step]
8-075-009	S:Jobs/PGS	51~100 Pages	CTL*	[0 to 99999999 / 0 / 1/step]
8-075-010	S:Jobs/PGS	101~300 Pages	CTL*	[0 to 99999999 / 0 / 1/step]
8-075-011	S:Jobs/PGS	301~500 Pages	CTL*	[0 to 99999999 / 0 / 1/step]
8-075-012	S:Jobs/PGS	501~700 Pages	CTL*	[0 to 99999999 / 0 / 1/step]
8-075-013	S:Jobs/PGS	701~1000 Pages	CTL*	[0 to 99999999 / 0 / 1/step]
8-075-014	S:Jobs/PGS	1001~ Pages	CTL*	[0 to 99999999 / 0 / 1/step]
8-076-001	L:Jobs/PGS	1 Page	CTL*	[0 to 99999999 / 0 / 1/step]
8-076-002	L:Jobs/PGS	2 Pages	CTL*	[0 to 99999999 / 0 / 1/step]
8-076-003	L:Jobs/PGS	3 Pages	CTL*	[0 to 99999999 / 0 / 1/step]
8-076-004	L:Jobs/PGS	4 Pages	CTL*	[0 to 99999999 / 0 / 1/step]
8-076-005	L:Jobs/PGS	5 Pages	CTL*	[0 to 99999999 / 0 / 1/step]
8-076-006	L:Jobs/PGS	6~10 Pages	CTL*	[0 to 99999999 / 0 / 1/step]
8-076-007	L:Jobs/PGS	11~20 Pages	CTL*	[0 to 99999999 / 0 / 1/step]
8-076-008	L:Jobs/PGS	21~50 Pages	CTL*	[0 to 99999999 / 0 / 1/step]
8-076-009	L:Jobs/PGS	51~100 Pages	CTL*	[0 to 99999999 / 0 / 1/step]
8-076-	L:Jobs/PGS	101~300 Pages	CTL*	[0 to 99999999 / 0 /

3.SP Mode Tables

SP No.	Large Category	Small Category	ENG or CTL	[Min to Max/Init./Step]
010				1/step]
8-076-011	L:Jobs/PGS	301~500 Pages	CTL*	[0 to 99999999 / 0 / 1/step]
8-076-012	L:Jobs/PGS	501~700 Pages	CTL*	[0 to 99999999 / 0 / 1/step]
8-076-013	L:Jobs/PGS	701~1000 Pages	CTL*	[0 to 99999999 / 0 / 1/step]
8-076-014	L:Jobs/PGS	1001~ Pages	CTL*	[0 to 99999999 / 0 / 1/step]
8-077-001	O:Jobs/PGS	1 Page	CTL*	[0 to 99999999 / 0 / 1/step]
8-077-002	O:Jobs/PGS	2 Pages	CTL*	[0 to 99999999 / 0 / 1/step]
8-077-003	O:Jobs/PGS	3 Pages	CTL*	[0 to 99999999 / 0 / 1/step]
8-077-004	O:Jobs/PGS	4 Pages	CTL*	[0 to 99999999 / 0 / 1/step]
8-077-005	O:Jobs/PGS	5 Pages	CTL*	[0 to 99999999 / 0 / 1/step]
8-077-006	O:Jobs/PGS	6~10 Pages	CTL*	[0 to 99999999 / 0 / 1/step]
8-077-007	O:Jobs/PGS	11~20 Pages	CTL*	[0 to 99999999 / 0 / 1/step]
8-077-008	O:Jobs/PGS	21~50 Pages	CTL*	[0 to 99999999 / 0 / 1/step]
8-077-009	O:Jobs/PGS	51~100 Pages	CTL*	[0 to 99999999 / 0 / 1/step]
8-077-010	O:Jobs/PGS	101~300 Pages	CTL*	[0 to 99999999 / 0 / 1/step]
8-077-011	O:Jobs/PGS	301~500 Pages	CTL*	[0 to 99999999 / 0 / 1/step]
8-077-012	O:Jobs/PGS	501~700 Pages	CTL*	[0 to 99999999 / 0 / 1/step]
8-077-013	O:Jobs/PGS	701~1000 Pages	CTL*	[0 to 99999999 / 0 / 1/step]
8-077-	O:Jobs/PGS	1001~ Pages	CTL*	[0 to 99999999 / 0 /

3.SP Mode Tables

SP No.	Large Category	Small Category	ENG or CTL	[Min to Max/Init./Step]
014				1/step]
8-081-001	T:Smart Device	Smart Device	CTL*	[0 to 99999999 / 0 / 1/step]
8-082-001	C:Smart Device	Smart Device	CTL*	[0 to 99999999 / 0 / 1/step]
8-083-001	F:Smart Device	Smart Device	CTL*	[0 to 99999999 / 0 / 1/step]
8-084-001	P:Smart Device	Smart Device	CTL*	[0 to 99999999 / 0 / 1/step]
8-085-001	S:Smart Device	Smart Device	CTL*	[0 to 99999999 / 0 / 1/step]
8-091-001	T:Jobs/Driv	V3 RPCS	CTL*	[0 to 99999999 / 0 / 1/step]
8-091-002	T:Jobs/Driv	V3 RPCS Basic	CTL*	[0 to 99999999 / 0 / 1/step]
8-091-003	T:Jobs/Driv	V4 RPCS Inbox	CTL*	[0 to 99999999 / 0 / 1/step]
8-091-004	T:Jobs/Driv	V4 RPCS Generic	CTL*	[0 to 99999999 / 0 / 1/step]
8-091-005	T:Jobs/Driv	V4 RPCS	CTL*	[0 to 99999999 / 0 / 1/step]
8-091-006	T:Jobs/Driv	V3 XPS(RPCS)	CTL*	[0 to 99999999 / 0 / 1/step]
8-091-007	T:Jobs/Driv	V3 PS	CTL*	[0 to 99999999 / 0 / 1/step]
8-091-008	T:Jobs/Driv	V3 PS UD	CTL*	[0 to 99999999 / 0 / 1/step]
8-091-009	T:Jobs/Driv	V3 PS UD Generic	CTL*	[0 to 99999999 / 0 / 1/step]
8-091-010	T:Jobs/Driv	V4 PS UD	CTL*	[0 to 99999999 / 0 / 1/step]
8-091-011	T:Jobs/Driv	V4 PS UD Generic	CTL*	[0 to 99999999 / 0 / 1/step]
8-091-012	T:Jobs/Driv	V3 GL/GL2	CTL*	[0 to 99999999 / 0 / 1/step]
8-091-	T:Jobs/Driv	V3 GL/GL2 Generic	CTL*	[0 to 99999999 / 0 /

3.SP Mode Tables

SP No.	Large Category	Small Category	ENG or CTL	[Min to Max/Init./Step]
013				1/step]
8-091-014	T:Jobs/Driv	V4 GL/GL2	CTL*	[0 to 99999999 / 0 / 1/step]
8-091-015	T:Jobs/Driv	PDF Direct	CTL*	[0 to 99999999 / 0 / 1/step]
8-091-016	T:Jobs/Driv	V3 PCL5e/5c	CTL*	[0 to 99999999 / 0 / 1/step]
8-091-017	T:Jobs/Driv	V3 PCL5e/5c Generic	CTL*	[0 to 99999999 / 0 / 1/step]
8-091-018	T:Jobs/Driv	V3 PCL XL	CTL*	[0 to 99999999 / 0 / 1/step]
8-091-019	T:Jobs/Driv	V3 PCL XL UD	CTL*	[0 to 99999999 / 0 / 1/step]
8-091-020	T:Jobs/Driv	V3 PCL XL UD Generic	CTL*	[0 to 99999999 / 0 / 1/step]
8-091-021	T:Jobs/Driv	V4 PCL XL UD	CTL*	[0 to 99999999 / 0 / 1/step]
8-091-022	T:Jobs/Driv	V4 PCL XL UD Generic	CTL*	[0 to 99999999 / 0 / 1/step]
8-091-023	T:Jobs/Driv	XPS	CTL*	[0 to 99999999 / 0 / 1/step]
8-091-024	T:Jobs/Driv	V3 PC-Fax	CTL*	[0 to 99999999 / 0 / 1/step]
8-091-025	T:Jobs/Driv	V4 PC-Fax	CTL*	[0 to 99999999 / 0 / 1/step]
8-091-026	T:Jobs/Driv	Other	CTL*	[0 to 99999999 / 0 / 1/step]
8-094-001	P:Jobs/Driv	V3 RPCS	CTL*	[0 to 99999999 / 0 / 1/step]
8-094-002	P:Jobs/Driv	V3 RPCS Basic	CTL*	[0 to 99999999 / 0 / 1/step]
8-094-003	P:Jobs/Driv	V4 RPCS Inbox	CTL*	[0 to 99999999 / 0 / 1/step]
8-094-004	P:Jobs/Driv	V4 RPCS Generic	CTL*	[0 to 99999999 / 0 / 1/step]
8-094-	P:Jobs/Driv	V4 RPCS	CTL*	[0 to 99999999 / 0 /

3.SP Mode Tables

SP No.	Large Category	Small Category	ENG or CTL	[Min to Max/Init./Step]
005				1/step]
8-094-006	P:Jobs/Driv	V3 XPS(RPCS)	CTL*	[0 to 99999999 / 0 / 1/step]
8-094-007	P:Jobs/Driv	V3 PS	CTL*	[0 to 99999999 / 0 / 1/step]
8-094-008	P:Jobs/Driv	V3 PS UD	CTL*	[0 to 99999999 / 0 / 1/step]
8-094-009	P:Jobs/Driv	V3 PS UD Generic	CTL*	[0 to 99999999 / 0 / 1/step]
8-094-010	P:Jobs/Driv	V4 PS UD	CTL*	[0 to 99999999 / 0 / 1/step]
8-094-011	P:Jobs/Driv	V4 PS UD Generic	CTL*	[0 to 99999999 / 0 / 1/step]
8-094-012	P:Jobs/Driv	V3 GL/GL2	CTL*	[0 to 99999999 / 0 / 1/step]
8-094-013	P:Jobs/Driv	V3 GL/GL2 Generic	CTL*	[0 to 99999999 / 0 / 1/step]
8-094-014	P:Jobs/Driv	V4 GL/GL2	CTL*	[0 to 99999999 / 0 / 1/step]
8-094-015	P:Jobs/Driv	PDF Direct	CTL*	[0 to 99999999 / 0 / 1/step]
8-094-016	P:Jobs/Driv	V3 PCL5e/5c	CTL*	[0 to 99999999 / 0 / 1/step]
8-094-017	P:Jobs/Driv	V3 PCL5e/5c Generic	CTL*	[0 to 99999999 / 0 / 1/step]
8-094-018	P:Jobs/Driv	V3 PCL XL	CTL*	[0 to 99999999 / 0 / 1/step]
8-094-019	P:Jobs/Driv	V3 PCL XL UD	CTL*	[0 to 99999999 / 0 / 1/step]
8-094-020	P:Jobs/Driv	V3 PCL XL UD Generic	CTL*	[0 to 99999999 / 0 / 1/step]
8-094-021	P:Jobs/Driv	V4 PCL XL UD	CTL*	[0 to 99999999 / 0 / 1/step]
8-094-022	P:Jobs/Driv	V4 PCL XL UD Generic	CTL*	[0 to 99999999 / 0 / 1/step]
8-094-	P:Jobs/Driv	XPS	CTL*	[0 to 99999999 / 0 /

3.SP Mode Tables

SP No.	Large Category	Small Category	ENG or CTL	[Min to Max/Init./Step]
023				1/step]
8-094-024	P:Jobs/Driv	V3 PC-Fax	CTL*	[0 to 99999999 / 0 / 1/step]
8-094-025	P:Jobs/Driv	V4 PC-Fax	CTL*	[0 to 99999999 / 0 / 1/step]
8-094-026	P:Jobs/Driv	Other	CTL*	[0 to 99999999 / 0 / 1/step]
8-111-001	T:FAX TX Jobs	BW(Tel)	CTL*	[0 to 99999999 / 0 / 1/step]
8-111-002	T:FAX TX Jobs	Color(Tel)	CTL*	[0 to 99999999 / 0 / 1/step]
8-111-101	T:FAX TX Jobs	BW(Cloud)	CTL*	[0 to 99999999 / 0 / 1/step]
8-111-102	T:FAX TX Jobs	Color(Cloud)	CTL*	[0 to 99999999 / 0 / 1/step]
8-113-001	F:FAX TX Jobs	BW(Tel)	CTL*	[0 to 99999999 / 0 / 1/step]
8-113-002	F:FAX TX Jobs	Color(Tel)	CTL*	[0 to 99999999 / 0 / 1/step]
8-113-101	F:FAX TX Jobs	BW(Cloud)	CTL*	[0 to 99999999 / 0 / 1/step]
8-113-102	F:FAX TX Jobs	Color(Cloud)	CTL*	[0 to 99999999 / 0 / 1/step]
8-121-001	T:IFAX TX Jobs	BW	CTL*	[0 to 99999999 / 0 / 1/step]
8-121-002	T:IFAX TX Jobs	Color	CTL*	[0 to 99999999 / 0 / 1/step]
8-123-001	F:IFAX TX Jobs	BW	CTL*	[0 to 99999999 / 0 / 1/step]
8-123-002	F:IFAX TX Jobs	Color	CTL*	[0 to 99999999 / 0 / 1/step]
8-131-001	T:S-to-Email Jobs	BW	CTL*	[0 to 99999999 / 0 / 1/step]
8-131-002	T:S-to-Email Jobs	Color	CTL*	[0 to 99999999 / 0 / 1/step]
8-131-	T:S-to-Email Jobs	ACS	CTL*	[0 to 99999999 / 0 /

3.SP Mode Tables

SP No.	Large Category	Small Category	ENG or CTL	[Min to Max/Init./Step]
003				1/step]
8-135-001	S:S-to-Email Jobs	B/W	CTL*	[0 to 99999999 / 0 / 1/step]
8-135-002	S:S-to-Email Jobs	Color	CTL*	[0 to 99999999 / 0 / 1/step]
8-135-003	S:S-to-Email Jobs	ACS	CTL*	[0 to 99999999 / 0 / 1/step]
8-141-001	T:Deliv Jobs/Svr	B/W	CTL*	[0 to 99999999 / 0 / 1/step]
8-141-002	T:Deliv Jobs/Svr	Color	CTL*	[0 to 99999999 / 0 / 1/step]
8-141-003	T:Deliv Jobs/Svr	ACS	CTL*	[0 to 99999999 / 0 / 1/step]
8-145-001	S:Deliv Jobs/Svr	B/W	CTL*	[0 to 99999999 / 0 / 1/step]
8-145-002	S:Deliv Jobs/Svr	Color	CTL*	[0 to 99999999 / 0 / 1/step]
8-145-003	S:Deliv Jobs/Svr	ACS	CTL*	[0 to 99999999 / 0 / 1/step]
8-151-001	T:Deliv Jobs/PC	B/W	CTL*	[0 to 99999999 / 0 / 1/step]
8-151-002	T:Deliv Jobs/PC	Color	CTL*	[0 to 99999999 / 0 / 1/step]
8-151-003	T:Deliv Jobs/PC	ACS	CTL*	[0 to 99999999 / 0 / 1/step]
8-155-001	S:Deliv Jobs/PC	B/W	CTL*	[0 to 99999999 / 0 / 1/step]
8-155-002	S:Deliv Jobs/PC	Color	CTL*	[0 to 99999999 / 0 / 1/step]
8-155-003	S:Deliv Jobs/PC	ACS	CTL*	[0 to 99999999 / 0 / 1/step]
8-161-001	T:PCFAX TX Jobs		CTL*	[0 to 99999999 / 0 / 1/step]
8-163-001	F:PCFAX TX Jobs		CTL*	[0 to 99999999 / 0 / 1/step]
8-171-	T:Deliv	B/W	CTL*	[0 to 99999999 / 0 /

3.SP Mode Tables

SP No.	Large Category	Small Category	ENG or CTL	[Min to Max/Init./Step]
001	Jobs/WSD/DSM			1/step]
8-171-002	T:Deliv Jobs/WSD/DSM	Color	CTL*	[0 to 99999999 / 0 / 1/step]
8-171-003	T:Deliv Jobs/WSD/DSM	ACS	CTL*	[0 to 99999999 / 0 / 1/step]
8-175-001	S:Deliv Jobs/WSD/DSM	B/W	CTL*	[0 to 99999999 / 0 / 1/step]
8-175-002	S:Deliv Jobs/WSD/DSM	Color	CTL*	[0 to 99999999 / 0 / 1/step]
8-175-003	S:Deliv Jobs/WSD/DSM	ACS	CTL*	[0 to 99999999 / 0 / 1/step]
8-181-001	T:Scan to Media Jobs	B/W	CTL*	[0 to 99999999 / 0 / 1/step]
8-181-002	T:Scan to Media Jobs	Color	CTL*	[0 to 99999999 / 0 / 1/step]
8-181-003	T:Scan to Media Jobs	ACS	CTL*	[0 to 99999999 / 0 / 1/step]
8-185-001	S:Scan to Media Jobs	B/W	CTL*	[0 to 99999999 / 0 / 1/step]
8-185-002	S:Scan to Media Jobs	Color	CTL*	[0 to 99999999 / 0 / 1/step]
8-185-003	S:Scan to Media Jobs	ACS	CTL*	[0 to 99999999 / 0 / 1/step]
8-191-001	T:Total Scan PGS		CTL*	[0 to 99999999 / 0 / 1/step]
8-192-001	C:Total Scan PGS		CTL*	[0 to 99999999 / 0 / 1/step]
8-193-001	F:Total Scan PGS		CTL*	[0 to 99999999 / 0 / 1/step]
8-195-001	S:Total Scan PGS		CTL*	[0 to 99999999 / 0 / 1/step]
8-196-001	L:Total Scan PGS		CTL*	[0 to 99999999 / 0 / 1/step]
8-201-001	T:LSize Scan PGS	A3/DLT, Larger	CTL*	[0 to 99999999 / 0 / 1/step]
8-203-	F:LSize Scan PGS	A3/DLT, Larger	CTL*	[0 to 99999999 / 0 /

3.SP Mode Tables

SP No.	Large Category	Small Category	ENG or CTL	[Min to Max/Init./Step]
001				1/step]
8-205-001	S:LSize Scan PGS	A3/DLT, Larger	CTL*	[0 to 99999999 / 0 / 1/step]
8-211-001	T:Scan PGS/LS		CTL*	[0 to 99999999 / 0 / 1/step]
8-212-001	C:Scan PGS/LS		CTL*	[0 to 99999999 / 0 / 1/step]
8-213-001	F:Scan PGS/LS		CTL*	[0 to 99999999 / 0 / 1/step]
8-215-001	S:Scan PGS/LS		CTL*	[0 to 99999999 / 0 / 1/step]
8-216-001	L:Scan PGS/LS		CTL*	[0 to 99999999 / 0 / 1/step]
8-221-001	ADF Org Feeds	Front	CTL*	[0 to 99999999 / 0 / 1/step]
8-221-002	ADF Org Feeds	Back	CTL*	[0 to 99999999 / 0 / 1/step]
8-231-001	Scan PGS/Mode	Large Volume	CTL*	[0 to 99999999 / 0 / 1/step]
8-231-002	Scan PGS/Mode	SADF	CTL*	[0 to 99999999 / 0 / 1/step]
8-231-003	Scan PGS/Mode	Mixed Size	CTL*	[0 to 99999999 / 0 / 1/step]
8-231-004	Scan PGS/Mode	Custom Size	CTL*	[0 to 99999999 / 0 / 1/step]
8-231-005	Scan PGS/Mode	Platen	CTL*	[0 to 99999999 / 0 / 1/step]
8-231-006	Scan PGS/Mode	Mixed 1side/2side	CTL*	[0 to 99999999 / 0 / 1/step]
8-231-007	Scan PGS/Mode	ID card Feeder	CTL*	[0 to 99999999 / 0 / 1/step]
8-241-001	T:Scan PGS/Org	Text	CTL*	[0 to 99999999 / 0 / 1/step]
8-241-002	T:Scan PGS/Org	Text/Photo	CTL*	[0 to 99999999 / 0 / 1/step]
8-241-	T:Scan PGS/Org	Photo	CTL*	[0 to 99999999 / 0 /

3.SP Mode Tables

SP No.	Large Category	Small Category	ENG or CTL	[Min to Max/Init./Step]
003				1/step]
8-241-004	T:Scan PGS/Org	GenCopy, Pale	CTL*	[0 to 99999999 / 0 / 1/step]
8-241-005	T:Scan PGS/Org	Map	CTL*	[0 to 99999999 / 0 / 1/step]
8-241-006	T:Scan PGS/Org	Normal/Detail	CTL*	[0 to 99999999 / 0 / 1/step]
8-241-007	T:Scan PGS/Org	Fine/Super Fine	CTL*	[0 to 99999999 / 0 / 1/step]
8-241-008	T:Scan PGS/Org	Binary	CTL*	[0 to 99999999 / 0 / 1/step]
8-241-009	T:Scan PGS/Org	Grayscale	CTL*	[0 to 99999999 / 0 / 1/step]
8-241-010	T:Scan PGS/Org	Color	CTL*	[0 to 99999999 / 0 / 1/step]
8-241-011	T:Scan PGS/Org	Other	CTL*	[0 to 99999999 / 0 / 1/step]
8-242-001	C:Scan PGS/Org	Text	CTL*	[0 to 99999999 / 0 / 1/step]
8-242-002	C:Scan PGS/Org	Text/Photo	CTL*	[0 to 99999999 / 0 / 1/step]
8-242-003	C:Scan PGS/Org	Photo	CTL*	[0 to 99999999 / 0 / 1/step]
8-242-004	C:Scan PGS/Org	GenCopy, Pale	CTL*	[0 to 99999999 / 0 / 1/step]
8-242-005	C:Scan PGS/Org	Map	CTL*	[0 to 99999999 / 0 / 1/step]
8-242-011	C:Scan PGS/Org	Other	CTL*	[0 to 99999999 / 0 / 1/step]
8-243-001	F:Scan PGS/Org	Text	CTL*	[0 to 99999999 / 0 / 1/step]
8-243-002	F:Scan PGS/Org	Text/Photo	CTL*	[0 to 99999999 / 0 / 1/step]
8-243-003	F:Scan PGS/Org	Photo	CTL*	[0 to 99999999 / 0 / 1/step]
8-243-	F:Scan PGS/Org	Normal/Detail	CTL*	[0 to 99999999 / 0 /

3.SP Mode Tables

SP No.	Large Category	Small Category	ENG or CTL	[Min to Max/Init./Step]
006				1/step]
8-243-007	F:Scan PGS/Org	Fine/Super Fine	CTL*	[0 to 99999999 / 0 / 1/step]
8-243-011	F:Scan PGS/Org	Other	CTL*	[0 to 99999999 / 0 / 1/step]
8-245-001	S:Scan PGS/Org	Text	CTL*	[0 to 99999999 / 0 / 1/step]
8-245-002	S:Scan PGS/Org	Text/Photo	CTL*	[0 to 99999999 / 0 / 1/step]
8-245-003	S:Scan PGS/Org	Photo	CTL*	[0 to 99999999 / 0 / 1/step]
8-245-004	S:Scan PGS/Org	GenCopy, Pale	CTL*	[0 to 99999999 / 0 / 1/step]
8-245-008	S:Scan PGS/Org	Binary	CTL*	[0 to 99999999 / 0 / 1/step]
8-245-009	S:Scan PGS/Org	Grayscale	CTL*	[0 to 99999999 / 0 / 1/step]
8-245-010	S:Scan PGS/Org	Color	CTL*	[0 to 99999999 / 0 / 1/step]
8-245-011	S:Scan PGS/Org	Other	CTL*	[0 to 99999999 / 0 / 1/step]
8-246-001	L:Scan PGS/Org	Text	CTL*	[0 to 99999999 / 0 / 1/step]
8-246-002	L:Scan PGS/Org	Text/Photo	CTL*	[0 to 99999999 / 0 / 1/step]
8-246-003	L:Scan PGS/Org	Photo	CTL*	[0 to 99999999 / 0 / 1/step]
8-246-004	L:Scan PGS/Org	GenCopy, Pale	CTL*	[0 to 99999999 / 0 / 1/step]
8-246-005	L:Scan PGS/Org	Map	CTL*	[0 to 99999999 / 0 / 1/step]
8-246-011	L:Scan PGS/Org	Other	CTL*	[0 to 99999999 / 0 / 1/step]
8-251-001	T:Scan PGS/ImgEdt		CTL*	[0 to 99999999 / 0 / 1/step]
8-252-	C:Scan PGS/ImgEdt		CTL*	[0 to 99999999 / 0 /

3.SP Mode Tables

SP No.	Large Category	Small Category	ENG or CTL	[Min to Max/Init./Step]
001				1/step]
8-255-001	S:Scn PGS/ImgEdt		CTL*	[0 to 99999999 / 0 / 1/step]
8-256-001	L:Scn PGS/ImgEdt		CTL*	[0 to 99999999 / 0 / 1/step]
8-257-001	O:Scn PGS/ImgEdt		CTL*	[0 to 99999999 / 0 / 1/step]
8-261-001	T:Scn PGS/ColCr	Color Conversion	CTL*	[0 to 99999999 / 0 / 1/step]
8-261-002	T:Scn PGS/ColCr	Color Erase	CTL*	[0 to 99999999 / 0 / 1/step]
8-261-003	T:Scn PGS/ColCr	Background	CTL*	[0 to 99999999 / 0 / 1/step]
8-261-004	T:Scn PGS/ColCr	Other	CTL*	[0 to 99999999 / 0 / 1/step]
8-262-001	C:Scn PGS/ColCr	Color Conversion	CTL*	[0 to 99999999 / 0 / 1/step]
8-262-002	C:Scn PGS/ColCr	Color Erase	CTL*	[0 to 99999999 / 0 / 1/step]
8-262-003	C:Scn PGS/ColCr	Background	CTL*	[0 to 99999999 / 0 / 1/step]
8-262-004	C:Scn PGS/ColCr	Other	CTL*	[0 to 99999999 / 0 / 1/step]
8-265-001	S:Scn PGS/ColCr	Color Conversion	CTL*	[0 to 99999999 / 0 / 1/step]
8-265-002	S:Scn PGS/ColCr	Color Erase	CTL*	[0 to 99999999 / 0 / 1/step]
8-265-003	S:Scn PGS/ColCr	Background	CTL*	[0 to 99999999 / 0 / 1/step]
8-265-004	S:Scn PGS/ColCr	Other	CTL*	[0 to 99999999 / 0 / 1/step]
8-266-001	L:Scn PGS/ColCr	Color Conversion	CTL*	[0 to 99999999 / 0 / 1/step]
8-266-002	L:Scn PGS/ColCr	Color Erase	CTL*	[0 to 99999999 / 0 / 1/step]
8-266-003	L:Scn PGS/ColCr	Background	CTL*	[0 to 99999999 / 0 / 1/step]

3.SP Mode Tables

SP No.	Large Category	Small Category	ENG or CTL	[Min to Max/Init./Step]
003				1/step]
8-266-004	L:Scn PGS/ColCr	Other	CTL*	[0 to 99999999 / 0 / 1/step]
8-281-001	T:Scn PGS/TWAIN		CTL*	[0 to 99999999 / 0 / 1/step]
8-285-001	S:Scn PGS/TWAIN		CTL*	[0 to 99999999 / 0 / 1/step]
8-291-001	T:Scn PGS/Stamp		CTL*	[0 to 99999999 / 0 / 1/step]
8-293-001	F:Scn PGS/Stamp		CTL*	[0 to 99999999 / 0 / 1/step]
8-295-001	S:Scn PGS/Stamp		CTL*	[0 to 99999999 / 0 / 1/step]
8-301-001	T:Scn PGS/Size	A3	CTL*	[0 to 99999999 / 0 / 1/step]
8-301-002	T:Scn PGS/Size	A4	CTL*	[0 to 99999999 / 0 / 1/step]
8-301-003	T:Scn PGS/Size	A5	CTL*	[0 to 99999999 / 0 / 1/step]
8-301-004	T:Scn PGS/Size	B4	CTL*	[0 to 99999999 / 0 / 1/step]
8-301-005	T:Scn PGS/Size	B5	CTL*	[0 to 99999999 / 0 / 1/step]
8-301-006	T:Scn PGS/Size	DLT	CTL*	[0 to 99999999 / 0 / 1/step]
8-301-007	T:Scn PGS/Size	LG	CTL*	[0 to 99999999 / 0 / 1/step]
8-301-008	T:Scn PGS/Size	LT	CTL*	[0 to 99999999 / 0 / 1/step]
8-301-009	T:Scn PGS/Size	HLT	CTL*	[0 to 99999999 / 0 / 1/step]
8-301-010	T:Scn PGS/Size	Full Bleed	CTL*	[0 to 99999999 / 0 / 1/step]
8-301-254	T:Scn PGS/Size	Other (Standard)	CTL*	[0 to 99999999 / 0 / 1/step]
8-301-	T:Scn PGS/Size	Other (Custom)	CTL*	[0 to 99999999 / 0 /

3.SP Mode Tables

SP No.	Large Category	Small Category	ENG or CTL	[Min to Max/Init./Step]
255				1/step]
8-302-001	C:Scan PGS/Size	A3	CTL*	[0 to 99999999 / 0 / 1/step]
8-302-002	C:Scan PGS/Size	A4	CTL*	[0 to 99999999 / 0 / 1/step]
8-302-003	C:Scan PGS/Size	A5	CTL*	[0 to 99999999 / 0 / 1/step]
8-302-004	C:Scan PGS/Size	B4	CTL*	[0 to 99999999 / 0 / 1/step]
8-302-005	C:Scan PGS/Size	B5	CTL*	[0 to 99999999 / 0 / 1/step]
8-302-006	C:Scan PGS/Size	DLT	CTL*	[0 to 99999999 / 0 / 1/step]
8-302-007	C:Scan PGS/Size	LG	CTL*	[0 to 99999999 / 0 / 1/step]
8-302-008	C:Scan PGS/Size	LT	CTL*	[0 to 99999999 / 0 / 1/step]
8-302-009	C:Scan PGS/Size	HLT	CTL*	[0 to 99999999 / 0 / 1/step]
8-302-010	C:Scan PGS/Size	Full Bleed	CTL*	[0 to 99999999 / 0 / 1/step]
8-302-254	C:Scan PGS/Size	Other (Standard)	CTL*	[0 to 99999999 / 0 / 1/step]
8-302-255	C:Scan PGS/Size	Other (Custom)	CTL*	[0 to 99999999 / 0 / 1/step]
8-303-001	F:Scan PGS/Size	A3	CTL*	[0 to 99999999 / 0 / 1/step]
8-303-002	F:Scan PGS/Size	A4	CTL*	[0 to 99999999 / 0 / 1/step]
8-303-003	F:Scan PGS/Size	A5	CTL*	[0 to 99999999 / 0 / 1/step]
8-303-004	F:Scan PGS/Size	B4	CTL*	[0 to 99999999 / 0 / 1/step]
8-303-005	F:Scan PGS/Size	B5	CTL*	[0 to 99999999 / 0 / 1/step]
8-303-	F:Scan PGS/Size	DLT	CTL*	[0 to 99999999 / 0 /

3.SP Mode Tables

SP No.	Large Category	Small Category	ENG or CTL	[Min to Max/Init./Step]
006				1/step]
8-303-007	F:Scan PGS/Size	LG	CTL*	[0 to 99999999 / 0 / 1/step]
8-303-008	F:Scan PGS/Size	LT	CTL*	[0 to 99999999 / 0 / 1/step]
8-303-009	F:Scan PGS/Size	HLT	CTL*	[0 to 99999999 / 0 / 1/step]
8-303-010	F:Scan PGS/Size	Full Bleed	CTL*	[0 to 99999999 / 0 / 1/step]
8-303-254	F:Scan PGS/Size	Other (Standard)	CTL*	[0 to 99999999 / 0 / 1/step]
8-303-255	F:Scan PGS/Size	Other (Custom)	CTL*	[0 to 99999999 / 0 / 1/step]
8-305-001	S:Scan PGS/Size	A3	CTL*	[0 to 99999999 / 0 / 1/step]
8-305-002	S:Scan PGS/Size	A4	CTL*	[0 to 99999999 / 0 / 1/step]
8-305-003	S:Scan PGS/Size	A5	CTL*	[0 to 99999999 / 0 / 1/step]
8-305-004	S:Scan PGS/Size	B4	CTL*	[0 to 99999999 / 0 / 1/step]
8-305-005	S:Scan PGS/Size	B5	CTL*	[0 to 99999999 / 0 / 1/step]
8-305-006	S:Scan PGS/Size	DLT	CTL*	[0 to 99999999 / 0 / 1/step]
8-305-007	S:Scan PGS/Size	LG	CTL*	[0 to 99999999 / 0 / 1/step]
8-305-008	S:Scan PGS/Size	LT	CTL*	[0 to 99999999 / 0 / 1/step]
8-305-009	S:Scan PGS/Size	HLT	CTL*	[0 to 99999999 / 0 / 1/step]
8-305-010	S:Scan PGS/Size	Full Bleed	CTL*	[0 to 99999999 / 0 / 1/step]
8-305-254	S:Scan PGS/Size	Other (Standard)	CTL*	[0 to 99999999 / 0 / 1/step]
8-305-	S:Scan PGS/Size	Other (Custom)	CTL*	[0 to 99999999 / 0 /

3.SP Mode Tables

SP No.	Large Category	Small Category	ENG or CTL	[Min to Max/Init./Step]
255				1/step]
8-306-001	L:Scan PGS/Size	A3	CTL*	[0 to 99999999 / 0 / 1/step]
8-306-002	L:Scan PGS/Size	A4	CTL*	[0 to 99999999 / 0 / 1/step]
8-306-003	L:Scan PGS/Size	A5	CTL*	[0 to 99999999 / 0 / 1/step]
8-306-004	L:Scan PGS/Size	B4	CTL*	[0 to 99999999 / 0 / 1/step]
8-306-005	L:Scan PGS/Size	B5	CTL*	[0 to 99999999 / 0 / 1/step]
8-306-006	L:Scan PGS/Size	DLT	CTL*	[0 to 99999999 / 0 / 1/step]
8-306-007	L:Scan PGS/Size	LG	CTL*	[0 to 99999999 / 0 / 1/step]
8-306-008	L:Scan PGS/Size	LT	CTL*	[0 to 99999999 / 0 / 1/step]
8-306-009	L:Scan PGS/Size	HLT	CTL*	[0 to 99999999 / 0 / 1/step]
8-306-010	L:Scan PGS/Size	Full Bleed	CTL*	[0 to 99999999 / 0 / 1/step]
8-306-254	L:Scan PGS/Size	Other (Standard)	CTL*	[0 to 99999999 / 0 / 1/step]
8-306-255	L:Scan PGS/Size	Other (Custom)	CTL*	[0 to 99999999 / 0 / 1/step]
8-311-001	T:Scan PGS/Rez	1200dpi ~	CTL*	[0 to 99999999 / 0 / 1/step]
8-311-002	T:Scan PGS/Rez	600dpi~1199dpi	CTL*	[0 to 99999999 / 0 / 1/step]
8-311-003	T:Scan PGS/Rez	400dpi~599dpi	CTL*	[0 to 99999999 / 0 / 1/step]
8-311-004	T:Scan PGS/Rez	200dpi~399dpi	CTL*	[0 to 99999999 / 0 / 1/step]
8-311-005	T:Scan PGS/Rez	~199dpi	CTL*	[0 to 99999999 / 0 / 1/step]
8-315-	S:Scan PGS/Rez	1200dpi ~	CTL*	[0 to 99999999 / 0 /

3.SP Mode Tables

SP No.	Large Category	Small Category	ENG or CTL	[Min to Max/Init./Step]
001				1/step]
8-315-002	S:Scan PGS/Rez	600dpi~1199dpi	CTL*	[0 to 99999999 / 0 / 1/step]
8-315-003	S:Scan PGS/Rez	400dpi~599dpi	CTL*	[0 to 99999999 / 0 / 1/step]
8-315-004	S:Scan PGS/Rez	200dpi~399dpi	CTL*	[0 to 99999999 / 0 / 1/step]
8-315-005	S:Scan PGS/Rez	~199dpi	CTL*	[0 to 99999999 / 0 / 1/step]
8-321-001	T:Sacn Poster	2 Sheet	CTL*	[0 to 99999999 / 0 / 1/step]
8-321-002	T:Sacn Poster	4 Sheet	CTL*	[0 to 99999999 / 0 / 1/step]
8-321-003	T:Sacn Poster	9 Sheet	CTL*	[0 to 99999999 / 0 / 1/step]
8-322-001	C:Sacn Poster	2 Sheet	CTL*	[0 to 99999999 / 0 / 1/step]
8-322-002	C:Sacn Poster	4 Sheet	CTL*	[0 to 99999999 / 0 / 1/step]
8-322-003	C:Sacn Poster	9 Sheet	CTL*	[0 to 99999999 / 0 / 1/step]
8-326-001	L:Sacn Poster	2 Sheet	CTL*	[0 to 99999999 / 0 / 1/step]
8-326-002	L:Sacn Poster	4 Sheet	CTL*	[0 to 99999999 / 0 / 1/step]
8-326-003	L:Sacn Poster	9 Sheet	CTL*	[0 to 99999999 / 0 / 1/step]
8-381-001	T:Total PrtPGS	Field Number	CTL*	[0 to 99999999 / 0 / 1/step]
8-381-101	T:Total PrtPGS	DFE:Field Number	CTL*	[0 to 99999999 / 0 / 1/step]
8-382-001	C:Total PrtPGS	Field Number	CTL*	[0 to 99999999 / 0 / 1/step]
8-383-001	F:Total PrtPGS	Field Number	CTL*	[0 to 99999999 / 0 / 1/step]
8-384-	P:Total PrtPGS	Field Number	CTL*	[0 to 99999999 / 0 /

3.SP Mode Tables

SP No.	Large Category	Small Category	ENG or CTL	[Min to Max/Init./Step]
001				1/step]
8-384-101	P:Total PrtPGS	DFE:Field Number	CTL*	[0 to 99999999 / 0 / 1/step]
8-385-001	S:Total PrtPGS	Field Number	CTL*	[0 to 99999999 / 0 / 1/step]
8-386-001	L:Total PrtPGS	Field Number	CTL*	[0 to 99999999 / 0 / 1/step]
8-387-001	O:Total PrtPGS	Field Number	CTL*	[0 to 99999999 / 0 / 1/step]
8-391-001	LSize PrtPGS	A3/DLT, Larger	CTL*	[0 to 99999999 / 0 / 1/step]
8-391-003	LSize PrtPGS	BannerPaper	CTL*	[0 to 99999999 / 0 / 1/step]
8-401-001	T:PrtPGS/LS		CTL*	[0 to 99999999 / 0 / 1/step]
8-402-001	C:PrtPGS/LS		CTL*	[0 to 99999999 / 0 / 1/step]
8-403-001	F:PrtPGS/LS		CTL*	[0 to 99999999 / 0 / 1/step]
8-404-001	P:PrtPGS/LS		CTL*	[0 to 99999999 / 0 / 1/step]
8-405-001	S:PrtPGS/LS		CTL*	[0 to 99999999 / 0 / 1/step]
8-406-001	L:PrtPGS/LS		CTL*	[0 to 99999999 / 0 / 1/step]
8-411-001	Prints/Duplex		CTL*	[0 to 99999999 / 0 / 1/step]
8-421-001	T:PrtPGS/Dup Comb	Simplex> Duplex	CTL*	[0 to 99999999 / 0 / 1/step]
8-421-002	T:PrtPGS/Dup Comb	Duplex> Duplex	CTL*	[0 to 99999999 / 0 / 1/step]
8-421-003	T:PrtPGS/Dup Comb	Book> Duplex	CTL*	[0 to 99999999 / 0 / 1/step]
8-421-004	T:PrtPGS/Dup Comb	Simplex Combine	CTL*	[0 to 99999999 / 0 / 1/step]
8-421-	T:PrtPGS/Dup Comb	Duplex Combine	CTL*	[0 to 99999999 / 0 /

3.SP Mode Tables

SP No.	Large Category	Small Category	ENG or CTL	[Min to Max/Init./Step]
005				1/step]
8-421-006	T:PrtPGS/Dup Comb	2in1	CTL*	[0 to 99999999 / 0 / 1/step]
8-421-007	T:PrtPGS/Dup Comb	4in1	CTL*	[0 to 99999999 / 0 / 1/step]
8-421-008	T:PrtPGS/Dup Comb	6in1	CTL*	[0 to 99999999 / 0 / 1/step]
8-421-009	T:PrtPGS/Dup Comb	8in1	CTL*	[0 to 99999999 / 0 / 1/step]
8-421-010	T:PrtPGS/Dup Comb	9in1	CTL*	[0 to 99999999 / 0 / 1/step]
8-421-011	T:PrtPGS/Dup Comb	16in1	CTL*	[0 to 99999999 / 0 / 1/step]
8-421-012	T:PrtPGS/Dup Comb	Booklet	CTL*	[0 to 99999999 / 0 / 1/step]
8-421-013	T:PrtPGS/Dup Comb	Magazine	CTL*	[0 to 99999999 / 0 / 1/step]
8-421-014	T:PrtPGS/Dup Comb	2in1 + Booklet	CTL*	[0 to 99999999 / 0 / 1/step]
8-421-015	T:PrtPGS/Dup Comb	4in1 + Booklet	CTL*	[0 to 99999999 / 0 / 1/step]
8-421-016	T:PrtPGS/Dup Comb	6in1 + Booklet	CTL*	[0 to 99999999 / 0 / 1/step]
8-421-017	T:PrtPGS/Dup Comb	8in1 + Booklet	CTL*	[0 to 99999999 / 0 / 1/step]
8-421-018	T:PrtPGS/Dup Comb	9in1 + Booklet	CTL*	[0 to 99999999 / 0 / 1/step]
8-421-019	T:PrtPGS/Dup Comb	2in1 + Magazine	CTL*	[0 to 99999999 / 0 / 1/step]
8-421-020	T:PrtPGS/Dup Comb	4in1 + Magazine	CTL*	[0 to 99999999 / 0 / 1/step]
8-421-021	T:PrtPGS/Dup Comb	6in1 + Magazine	CTL*	[0 to 99999999 / 0 / 1/step]
8-421-022	T:PrtPGS/Dup Comb	8in1 + Magazine	CTL*	[0 to 99999999 / 0 / 1/step]
8-421-	T:PrtPGS/Dup Comb	9in1 + Magazine	CTL*	[0 to 99999999 / 0 /

3.SP Mode Tables

SP No.	Large Category	Small Category	ENG or CTL	[Min to Max/Init./Step]
023				1/step]
8-421-024	T:PrtPGS/Dup Comb	16in1 + Magazine	CTL*	[0 to 99999999 / 0 / 1/step]
8-422-001	C:PrtPGS/Dup Comb	Simplex> Duplex	CTL*	[0 to 99999999 / 0 / 1/step]
8-422-002	C:PrtPGS/Dup Comb	Duplex> Duplex	CTL*	[0 to 99999999 / 0 / 1/step]
8-422-003	C:PrtPGS/Dup Comb	Book> Duplex	CTL*	[0 to 99999999 / 0 / 1/step]
8-422-004	C:PrtPGS/Dup Comb	Simplex Combine	CTL*	[0 to 99999999 / 0 / 1/step]
8-422-005	C:PrtPGS/Dup Comb	Duplex Combine	CTL*	[0 to 99999999 / 0 / 1/step]
8-422-006	C:PrtPGS/Dup Comb	2in1	CTL*	[0 to 99999999 / 0 / 1/step]
8-422-007	C:PrtPGS/Dup Comb	4in1	CTL*	[0 to 99999999 / 0 / 1/step]
8-422-009	C:PrtPGS/Dup Comb	8in1	CTL*	[0 to 99999999 / 0 / 1/step]
8-422-012	C:PrtPGS/Dup Comb	Booklet	CTL*	[0 to 99999999 / 0 / 1/step]
8-422-013	C:PrtPGS/Dup Comb	Magazine	CTL*	[0 to 99999999 / 0 / 1/step]
8-422-014	C:PrtPGS/Dup Comb	2in1 + Booklet	CTL*	[0 to 99999999 / 0 / 1/step]
8-422-015	C:PrtPGS/Dup Comb	4in1 + Booklet	CTL*	[0 to 99999999 / 0 / 1/step]
8-422-017	C:PrtPGS/Dup Comb	8in1 + Booklet	CTL*	[0 to 99999999 / 0 / 1/step]
8-422-019	C:PrtPGS/Dup Comb	2in1 + Magazine	CTL*	[0 to 99999999 / 0 / 1/step]
8-422-020	C:PrtPGS/Dup Comb	4in1 + Magazine	CTL*	[0 to 99999999 / 0 / 1/step]
8-422-022	C:PrtPGS/Dup Comb	8in1 + Magazine	CTL*	[0 to 99999999 / 0 / 1/step]
8-423-	F:PrtPGS/Dup Comb	Simplex> Duplex	CTL*	[0 to 99999999 / 0 /

3.SP Mode Tables

SP No.	Large Category	Small Category	ENG or CTL	[Min to Max/Init./Step]
001				1/step]
8-423-004	F:PrtPGS/Dup Comb	Simplex Combine	CTL*	[0 to 99999999 / 0 / 1/step]
8-423-005	F:PrtPGS/Dup Comb	Duplex Combine	CTL*	[0 to 99999999 / 0 / 1/step]
8-423-006	F:PrtPGS/Dup Comb	2in1	CTL*	[0 to 99999999 / 0 / 1/step]
8-423-007	F:PrtPGS/Dup Comb	4in1	CTL*	[0 to 99999999 / 0 / 1/step]
8-423-009	F:PrtPGS/Dup Comb	8in1	CTL*	[0 to 99999999 / 0 / 1/step]
8-423-011	F:PrtPGS/Dup Comb	16in1	CTL*	[0 to 99999999 / 0 / 1/step]
8-423-012	F:PrtPGS/Dup Comb	Booklet	CTL*	[0 to 99999999 / 0 / 1/step]
8-423-013	F:PrtPGS/Dup Comb	Magazine	CTL*	[0 to 99999999 / 0 / 1/step]
8-423-014	F:PrtPGS/Dup Comb	2in1 + Booklet	CTL*	[0 to 99999999 / 0 / 1/step]
8-423-015	F:PrtPGS/Dup Comb	4in1 + Booklet	CTL*	[0 to 99999999 / 0 / 1/step]
8-423-017	F:PrtPGS/Dup Comb	8in1 + Booklet	CTL*	[0 to 99999999 / 0 / 1/step]
8-423-019	F:PrtPGS/Dup Comb	2in1 + Magazine	CTL*	[0 to 99999999 / 0 / 1/step]
8-423-020	F:PrtPGS/Dup Comb	4in1 + Magazine	CTL*	[0 to 99999999 / 0 / 1/step]
8-423-022	F:PrtPGS/Dup Comb	8in1 + Magazine	CTL*	[0 to 99999999 / 0 / 1/step]
8-423-024	F:PrtPGS/Dup Comb	16in1 + Magazine	CTL*	[0 to 99999999 / 0 / 1/step]
8-424-001	P:PrtPGS/Dup Comb	Simplex> Duplex	CTL*	[0 to 99999999 / 0 / 1/step]
8-424-004	P:PrtPGS/Dup Comb	Simplex Combine	CTL*	[0 to 99999999 / 0 / 1/step]
8-424-	P:PrtPGS/Dup Comb	Duplex Combine	CTL*	[0 to 99999999 / 0 /

3.SP Mode Tables

SP No.	Large Category	Small Category	ENG or CTL	[Min to Max/Init./Step]
005				1/step]
8-424-006	P:PrtPGS/Dup Comb	2in1	CTL*	[0 to 99999999 / 0 / 1/step]
8-424-007	P:PrtPGS/Dup Comb	4in1	CTL*	[0 to 99999999 / 0 / 1/step]
8-424-008	P:PrtPGS/Dup Comb	6in1	CTL*	[0 to 99999999 / 0 / 1/step]
8-424-009	P:PrtPGS/Dup Comb	8in1	CTL*	[0 to 99999999 / 0 / 1/step]
8-424-010	P:PrtPGS/Dup Comb	9in1	CTL*	[0 to 99999999 / 0 / 1/step]
8-424-011	P:PrtPGS/Dup Comb	16in1	CTL*	[0 to 99999999 / 0 / 1/step]
8-424-012	P:PrtPGS/Dup Comb	Booklet	CTL*	[0 to 99999999 / 0 / 1/step]
8-424-013	P:PrtPGS/Dup Comb	Magazine	CTL*	[0 to 99999999 / 0 / 1/step]
8-424-014	P:PrtPGS/Dup Comb	2in1 + Booklet	CTL*	[0 to 99999999 / 0 / 1/step]
8-424-015	P:PrtPGS/Dup Comb	4in1 + Booklet	CTL*	[0 to 99999999 / 0 / 1/step]
8-424-016	P:PrtPGS/Dup Comb	6in1 + Booklet	CTL*	[0 to 99999999 / 0 / 1/step]
8-424-017	P:PrtPGS/Dup Comb	8in1 + Booklet	CTL*	[0 to 99999999 / 0 / 1/step]
8-424-018	P:PrtPGS/Dup Comb	9in1 + Booklet	CTL*	[0 to 99999999 / 0 / 1/step]
8-424-019	P:PrtPGS/Dup Comb	2in1 + Magazine	CTL*	[0 to 99999999 / 0 / 1/step]
8-424-020	P:PrtPGS/Dup Comb	4in1 + Magazine	CTL*	[0 to 99999999 / 0 / 1/step]
8-424-021	P:PrtPGS/Dup Comb	6in1 + Magazine	CTL*	[0 to 99999999 / 0 / 1/step]
8-424-022	P:PrtPGS/Dup Comb	8in1 + Magazine	CTL*	[0 to 99999999 / 0 / 1/step]
8-424-	P:PrtPGS/Dup Comb	9in1 + Magazine	CTL*	[0 to 99999999 / 0 /

3.SP Mode Tables

SP No.	Large Category	Small Category	ENG or CTL	[Min to Max/Init./Step]
023				1/step]
8-424-024	P:PrtPGS/Dup Comb	16in1 + Magazine	CTL*	[0 to 99999999 / 0 / 1/step]
8-425-001	S:PrtPGS/Dup Comb	Simplex> Duplex	CTL*	[0 to 99999999 / 0 / 1/step]
8-425-004	S:PrtPGS/Dup Comb	Simplex Combine	CTL*	[0 to 99999999 / 0 / 1/step]
8-425-005	S:PrtPGS/Dup Comb	Duplex Combine	CTL*	[0 to 99999999 / 0 / 1/step]
8-425-006	S:PrtPGS/Dup Comb	2in1	CTL*	[0 to 99999999 / 0 / 1/step]
8-425-007	S:PrtPGS/Dup Comb	4in1	CTL*	[0 to 99999999 / 0 / 1/step]
8-425-009	S:PrtPGS/Dup Comb	8in1	CTL*	[0 to 99999999 / 0 / 1/step]
8-425-010	S:PrtPGS/Dup Comb	9in1	CTL*	[0 to 99999999 / 0 / 1/step]
8-425-011	S:PrtPGS/Dup Comb	16in1	CTL*	[0 to 99999999 / 0 / 1/step]
8-425-012	S:PrtPGS/Dup Comb	Booklet	CTL*	[0 to 99999999 / 0 / 1/step]
8-425-013	S:PrtPGS/Dup Comb	Magazine	CTL*	[0 to 99999999 / 0 / 1/step]
8-425-014	S:PrtPGS/Dup Comb	2in1 + Booklet	CTL*	[0 to 99999999 / 0 / 1/step]
8-425-015	S:PrtPGS/Dup Comb	4in1 + Booklet	CTL*	[0 to 99999999 / 0 / 1/step]
8-425-017	S:PrtPGS/Dup Comb	8in1 + Booklet	CTL*	[0 to 99999999 / 0 / 1/step]
8-425-018	S:PrtPGS/Dup Comb	9in1 + Booklet	CTL*	[0 to 99999999 / 0 / 1/step]
8-425-019	S:PrtPGS/Dup Comb	2in1 + Magazine	CTL*	[0 to 99999999 / 0 / 1/step]
8-425-020	S:PrtPGS/Dup Comb	4in1 + Magazine	CTL*	[0 to 99999999 / 0 / 1/step]
8-425-	S:PrtPGS/Dup Comb	8in1 + Magazine	CTL*	[0 to 99999999 / 0 /

3.SP Mode Tables

SP No.	Large Category	Small Category	ENG or CTL	[Min to Max/Init./Step]
022				1/step]
8-425-023	S:PrtPGS/Dup Comb	9in1 + Magazine	CTL*	[0 to 99999999 / 0 / 1/step]
8-425-024	S:PrtPGS/Dup Comb	16in1 + Magazine	CTL*	[0 to 99999999 / 0 / 1/step]
8-426-001	L:PrtPGS/Dup Comb	Simplex> Duplex	CTL*	[0 to 99999999 / 0 / 1/step]
8-426-004	L:PrtPGS/Dup Comb	Simplex Combine	CTL*	[0 to 99999999 / 0 / 1/step]
8-426-005	L:PrtPGS/Dup Comb	Duplex Combine	CTL*	[0 to 99999999 / 0 / 1/step]
8-426-006	L:PrtPGS/Dup Comb	2in1	CTL*	[0 to 99999999 / 0 / 1/step]
8-426-007	L:PrtPGS/Dup Comb	4in1	CTL*	[0 to 99999999 / 0 / 1/step]
8-426-009	L:PrtPGS/Dup Comb	8in1	CTL*	[0 to 99999999 / 0 / 1/step]
8-426-011	L:PrtPGS/Dup Comb	16in1	CTL*	[0 to 99999999 / 0 / 1/step]
8-426-012	L:PrtPGS/Dup Comb	Booklet	CTL*	[0 to 99999999 / 0 / 1/step]
8-426-013	L:PrtPGS/Dup Comb	Magazine	CTL*	[0 to 99999999 / 0 / 1/step]
8-426-014	L:PrtPGS/Dup Comb	2in1 + Booklet	CTL*	[0 to 99999999 / 0 / 1/step]
8-426-015	L:PrtPGS/Dup Comb	4in1 + Booklet	CTL*	[0 to 99999999 / 0 / 1/step]
8-426-017	L:PrtPGS/Dup Comb	8in1 + Booklet	CTL*	[0 to 99999999 / 0 / 1/step]
8-426-019	L:PrtPGS/Dup Comb	2in1 + Magazine	CTL*	[0 to 99999999 / 0 / 1/step]
8-426-020	L:PrtPGS/Dup Comb	4in1 + Magazine	CTL*	[0 to 99999999 / 0 / 1/step]
8-426-022	L:PrtPGS/Dup Comb	8in1 + Magazine	CTL*	[0 to 99999999 / 0 / 1/step]
8-426-	L:PrtPGS/Dup Comb	16in1 + Magazine	CTL*	[0 to 99999999 / 0 /

3.SP Mode Tables

SP No.	Large Category	Small Category	ENG or CTL	[Min to Max/Init./Step]
024				1/step]
8-427-001	O:PrtPGS/Dup Comb	Simplex> Duplex	CTL*	[0 to 99999999 / 0 / 1/step]
8-427-002	O:PrtPGS/Dup Comb	Duplex> Duplex	CTL*	[0 to 99999999 / 0 / 1/step]
8-427-003	O:PrtPGS/Dup Comb	Book> Duplex	CTL*	[0 to 99999999 / 0 / 1/step]
8-427-004	O:PrtPGS/Dup Comb	Simplex Combine	CTL*	[0 to 99999999 / 0 / 1/step]
8-427-005	O:PrtPGS/Dup Comb	Duplex Combine	CTL*	[0 to 99999999 / 0 / 1/step]
8-427-006	O:PrtPGS/Dup Comb	2in1	CTL*	[0 to 99999999 / 0 / 1/step]
8-427-007	O:PrtPGS/Dup Comb	4in1	CTL*	[0 to 99999999 / 0 / 1/step]
8-427-008	O:PrtPGS/Dup Comb	6in1	CTL*	[0 to 99999999 / 0 / 1/step]
8-427-009	O:PrtPGS/Dup Comb	8in1	CTL*	[0 to 99999999 / 0 / 1/step]
8-427-010	O:PrtPGS/Dup Comb	9in1	CTL*	[0 to 99999999 / 0 / 1/step]
8-427-011	O:PrtPGS/Dup Comb	16in1	CTL*	[0 to 99999999 / 0 / 1/step]
8-427-012	O:PrtPGS/Dup Comb	Booklet	CTL*	[0 to 99999999 / 0 / 1/step]
8-427-013	O:PrtPGS/Dup Comb	Magazine	CTL*	[0 to 99999999 / 0 / 1/step]
8-427-014	O:PrtPGS/Dup Comb	2in1 + Booklet	CTL*	[0 to 99999999 / 0 / 1/step]
8-427-015	O:PrtPGS/Dup Comb	4in1 + Booklet	CTL*	[0 to 99999999 / 0 / 1/step]
8-427-016	O:PrtPGS/Dup Comb	6in1 + Booklet	CTL*	[0 to 99999999 / 0 / 1/step]
8-427-017	O:PrtPGS/Dup Comb	8in1 + Booklet	CTL*	[0 to 99999999 / 0 / 1/step]
8-427-	O:PrtPGS/Dup Comb	9in1 + Booklet	CTL*	[0 to 99999999 / 0 /

3.SP Mode Tables

SP No.	Large Category	Small Category	ENG or CTL	[Min to Max/Init./Step]
018				1/step]
8-427-019	O:PrtPGS/Dup Comb	2in1 + Magazine	CTL*	[0 to 99999999 / 0 / 1/step]
8-427-020	O:PrtPGS/Dup Comb	4in1 + Magazine	CTL*	[0 to 99999999 / 0 / 1/step]
8-427-021	O:PrtPGS/Dup Comb	6in1 + Magazine	CTL*	[0 to 99999999 / 0 / 1/step]
8-427-022	O:PrtPGS/Dup Comb	8in1 + Magazine	CTL*	[0 to 99999999 / 0 / 1/step]
8-427-023	O:PrtPGS/Dup Comb	9in1 + Magazine	CTL*	[0 to 99999999 / 0 / 1/step]
8-427-024	O:PrtPGS/Dup Comb	16in1 + Magazine	CTL*	[0 to 99999999 / 0 / 1/step]
8-431-001	T:PrtPGS/ImgEdt	Cover/Slip Sheet	CTL*	[0 to 99999999 / 0 / 1/step]
8-431-002	T:PrtPGS/ImgEdt	Series/Book	CTL*	[0 to 99999999 / 0 / 1/step]
8-431-003	T:PrtPGS/ImgEdt	User Stamp	CTL*	[0 to 99999999 / 0 / 1/step]
8-432-001	C:PrtPGS/ImgEdt	Cover/Slip Sheet	CTL*	[0 to 99999999 / 0 / 1/step]
8-432-002	C:PrtPGS/ImgEdt	Series/Book	CTL*	[0 to 99999999 / 0 / 1/step]
8-432-003	C:PrtPGS/ImgEdt	User Stamp	CTL*	[0 to 99999999 / 0 / 1/step]
8-434-001	P:PrtPGS/ImgEdt	Cover/Slip Sheet	CTL*	[0 to 99999999 / 0 / 1/step]
8-434-002	P:PrtPGS/ImgEdt	Series/Book	CTL*	[0 to 99999999 / 0 / 1/step]
8-434-003	P:PrtPGS/ImgEdt	User Stamp	CTL*	[0 to 99999999 / 0 / 1/step]
8-436-001	L:PrtPGS/ImgEdt	Cover/Slip Sheet	CTL*	[0 to 99999999 / 0 / 1/step]
8-436-002	L:PrtPGS/ImgEdt	Series/Book	CTL*	[0 to 99999999 / 0 / 1/step]
8-436-003	L:PrtPGS/ImgEdt	User Stamp	CTL*	[0 to 99999999 / 0 / 1/step]

3.SP Mode Tables

SP No.	Large Category	Small Category	ENG or CTL	[Min to Max/Init./Step]
003				1/step]
8-437-001	O:PrtPGS/ImgEdt	Cover/Slip Sheet	CTL*	[0 to 99999999 / 0 / 1/step]
8-437-002	O:PrtPGS/ImgEdt	Series/Book	CTL*	[0 to 99999999 / 0 / 1/step]
8-437-003	O:PrtPGS/ImgEdt	User Stamp	CTL*	[0 to 99999999 / 0 / 1/step]
8-441-001	T:PrtPGS/Ppr Size	A3	CTL*	[0 to 99999999 / 0 / 1/step]
8-441-002	T:PrtPGS/Ppr Size	A4	CTL*	[0 to 99999999 / 0 / 1/step]
8-441-003	T:PrtPGS/Ppr Size	A5	CTL*	[0 to 99999999 / 0 / 1/step]
8-441-004	T:PrtPGS/Ppr Size	B4	CTL*	[0 to 99999999 / 0 / 1/step]
8-441-005	T:PrtPGS/Ppr Size	B5	CTL*	[0 to 99999999 / 0 / 1/step]
8-441-006	T:PrtPGS/Ppr Size	DLT	CTL*	[0 to 99999999 / 0 / 1/step]
8-441-007	T:PrtPGS/Ppr Size	LG	CTL*	[0 to 99999999 / 0 / 1/step]
8-441-008	T:PrtPGS/Ppr Size	LT	CTL*	[0 to 99999999 / 0 / 1/step]
8-441-009	T:PrtPGS/Ppr Size	HLT	CTL*	[0 to 99999999 / 0 / 1/step]
8-441-010	T:PrtPGS/Ppr Size	Full Bleed	CTL*	[0 to 99999999 / 0 / 1/step]
8-441-254	T:PrtPGS/Ppr Size	Other (Standard)	CTL*	[0 to 99999999 / 0 / 1/step]
8-441-255	T:PrtPGS/Ppr Size	Other (Custom)	CTL*	[0 to 99999999 / 0 / 1/step]
8-442-001	C:PrtPGS/Ppr Size	A3	CTL*	[0 to 99999999 / 0 / 1/step]
8-442-002	C:PrtPGS/Ppr Size	A4	CTL*	[0 to 99999999 / 0 / 1/step]
8-442-	C:PrtPGS/Ppr Size	A5	CTL*	[0 to 99999999 / 0 /

3.SP Mode Tables

SP No.	Large Category	Small Category	ENG or CTL	[Min to Max/Init./Step]
003				1/step]
8-442-004	C:PrtPGS/Ppr Size	B4	CTL*	[0 to 99999999 / 0 / 1/step]
8-442-005	C:PrtPGS/Ppr Size	B5	CTL*	[0 to 99999999 / 0 / 1/step]
8-442-006	C:PrtPGS/Ppr Size	DLT	CTL*	[0 to 99999999 / 0 / 1/step]
8-442-007	C:PrtPGS/Ppr Size	LG	CTL*	[0 to 99999999 / 0 / 1/step]
8-442-008	C:PrtPGS/Ppr Size	LT	CTL*	[0 to 99999999 / 0 / 1/step]
8-442-009	C:PrtPGS/Ppr Size	HLT	CTL*	[0 to 99999999 / 0 / 1/step]
8-442-010	C:PrtPGS/Ppr Size	Full Bleed	CTL*	[0 to 99999999 / 0 / 1/step]
8-442-254	C:PrtPGS/Ppr Size	Other (Standard)	CTL*	[0 to 99999999 / 0 / 1/step]
8-442-255	C:PrtPGS/Ppr Size	Other (Custom)	CTL*	[0 to 99999999 / 0 / 1/step]
8-443-001	F:PrtPGS/Ppr Size	A3	CTL*	[0 to 99999999 / 0 / 1/step]
8-443-002	F:PrtPGS/Ppr Size	A4	CTL*	[0 to 99999999 / 0 / 1/step]
8-443-003	F:PrtPGS/Ppr Size	A5	CTL*	[0 to 99999999 / 0 / 1/step]
8-443-004	F:PrtPGS/Ppr Size	B4	CTL*	[0 to 99999999 / 0 / 1/step]
8-443-005	F:PrtPGS/Ppr Size	B5	CTL*	[0 to 99999999 / 0 / 1/step]
8-443-006	F:PrtPGS/Ppr Size	DLT	CTL*	[0 to 99999999 / 0 / 1/step]
8-443-007	F:PrtPGS/Ppr Size	LG	CTL*	[0 to 99999999 / 0 / 1/step]
8-443-008	F:PrtPGS/Ppr Size	LT	CTL*	[0 to 99999999 / 0 / 1/step]
8-443-	F:PrtPGS/Ppr Size	HLT	CTL*	[0 to 99999999 / 0 /

3.SP Mode Tables

SP No.	Large Category	Small Category	ENG or CTL	[Min to Max/Init./Step]
009				1/step]
8-443-010	F:PrtPGS/Ppr Size	Full Bleed	CTL*	[0 to 99999999 / 0 / 1/step]
8-443-254	F:PrtPGS/Ppr Size	Other (Standard)	CTL*	[0 to 99999999 / 0 / 1/step]
8-443-255	F:PrtPGS/Ppr Size	Other (Custom)	CTL*	[0 to 99999999 / 0 / 1/step]
8-444-001	P:PrtPGS/Ppr Size	A3	CTL*	[0 to 99999999 / 0 / 1/step]
8-444-002	P:PrtPGS/Ppr Size	A4	CTL*	[0 to 99999999 / 0 / 1/step]
8-444-003	P:PrtPGS/Ppr Size	A5	CTL*	[0 to 99999999 / 0 / 1/step]
8-444-004	P:PrtPGS/Ppr Size	B4	CTL*	[0 to 99999999 / 0 / 1/step]
8-444-005	P:PrtPGS/Ppr Size	B5	CTL*	[0 to 99999999 / 0 / 1/step]
8-444-006	P:PrtPGS/Ppr Size	DLT	CTL*	[0 to 99999999 / 0 / 1/step]
8-444-007	P:PrtPGS/Ppr Size	LG	CTL*	[0 to 99999999 / 0 / 1/step]
8-444-008	P:PrtPGS/Ppr Size	LT	CTL*	[0 to 99999999 / 0 / 1/step]
8-444-009	P:PrtPGS/Ppr Size	HLT	CTL*	[0 to 99999999 / 0 / 1/step]
8-444-010	P:PrtPGS/Ppr Size	Full Bleed	CTL*	[0 to 99999999 / 0 / 1/step]
8-444-254	P:PrtPGS/Ppr Size	Other (Standard)	CTL*	[0 to 99999999 / 0 / 1/step]
8-444-255	P:PrtPGS/Ppr Size	Other (Custom)	CTL*	[0 to 99999999 / 0 / 1/step]
8-445-001	S:PrtPGS/Ppr Size	A3	CTL*	[0 to 99999999 / 0 / 1/step]
8-445-002	S:PrtPGS/Ppr Size	A4	CTL*	[0 to 99999999 / 0 / 1/step]
8-445-	S:PrtPGS/Ppr Size	A5	CTL*	[0 to 99999999 / 0 /

3.SP Mode Tables

SP No.	Large Category	Small Category	ENG or CTL	[Min to Max/Init./Step]
003				1/step]
8-445-004	S:PrtPGS/Ppr Size	B4	CTL*	[0 to 99999999 / 0 / 1/step]
8-445-005	S:PrtPGS/Ppr Size	B5	CTL*	[0 to 99999999 / 0 / 1/step]
8-445-006	S:PrtPGS/Ppr Size	DLT	CTL*	[0 to 99999999 / 0 / 1/step]
8-445-007	S:PrtPGS/Ppr Size	LG	CTL*	[0 to 99999999 / 0 / 1/step]
8-445-008	S:PrtPGS/Ppr Size	LT	CTL*	[0 to 99999999 / 0 / 1/step]
8-445-009	S:PrtPGS/Ppr Size	HLT	CTL*	[0 to 99999999 / 0 / 1/step]
8-445-010	S:PrtPGS/Ppr Size	Full Bleed	CTL*	[0 to 99999999 / 0 / 1/step]
8-445-254	S:PrtPGS/Ppr Size	Other (Standard)	CTL*	[0 to 99999999 / 0 / 1/step]
8-445-255	S:PrtPGS/Ppr Size	Other (Custom)	CTL*	[0 to 99999999 / 0 / 1/step]
8-446-001	L:PrtPGS/Ppr Size	A3	CTL*	[0 to 99999999 / 0 / 1/step]
8-446-002	L:PrtPGS/Ppr Size	A4	CTL*	[0 to 99999999 / 0 / 1/step]
8-446-003	L:PrtPGS/Ppr Size	A5	CTL*	[0 to 99999999 / 0 / 1/step]
8-446-004	L:PrtPGS/Ppr Size	B4	CTL*	[0 to 99999999 / 0 / 1/step]
8-446-005	L:PrtPGS/Ppr Size	B5	CTL*	[0 to 99999999 / 0 / 1/step]
8-446-006	L:PrtPGS/Ppr Size	DLT	CTL*	[0 to 99999999 / 0 / 1/step]
8-446-007	L:PrtPGS/Ppr Size	LG	CTL*	[0 to 99999999 / 0 / 1/step]
8-446-008	L:PrtPGS/Ppr Size	LT	CTL*	[0 to 99999999 / 0 / 1/step]
8-446-	L:PrtPGS/Ppr Size	HLT	CTL*	[0 to 99999999 / 0 /

3.SP Mode Tables

SP No.	Large Category	Small Category	ENG or CTL	[Min to Max/Init./Step]
009				1/step]
8-446-010	L:PrtPGS/Ppr Size	Full Bleed	CTL*	[0 to 99999999 / 0 / 1/step]
8-446-254	L:PrtPGS/Ppr Size	Other (Standard)	CTL*	[0 to 99999999 / 0 / 1/step]
8-446-255	L:PrtPGS/Ppr Size	Other (Custom)	CTL*	[0 to 99999999 / 0 / 1/step]
8-447-001	O:PrtPGS/Ppr Size	A3	CTL*	[0 to 99999999 / 0 / 1/step]
8-447-002	O:PrtPGS/Ppr Size	A4	CTL*	[0 to 99999999 / 0 / 1/step]
8-447-003	O:PrtPGS/Ppr Size	A5	CTL*	[0 to 99999999 / 0 / 1/step]
8-447-004	O:PrtPGS/Ppr Size	B4	CTL*	[0 to 99999999 / 0 / 1/step]
8-447-005	O:PrtPGS/Ppr Size	B5	CTL*	[0 to 99999999 / 0 / 1/step]
8-447-006	O:PrtPGS/Ppr Size	DLT	CTL*	[0 to 99999999 / 0 / 1/step]
8-447-007	O:PrtPGS/Ppr Size	LG	CTL*	[0 to 99999999 / 0 / 1/step]
8-447-008	O:PrtPGS/Ppr Size	LT	CTL*	[0 to 99999999 / 0 / 1/step]
8-447-009	O:PrtPGS/Ppr Size	HLT	CTL*	[0 to 99999999 / 0 / 1/step]
8-447-010	O:PrtPGS/Ppr Size	Full Bleed	CTL*	[0 to 99999999 / 0 / 1/step]
8-447-254	O:PrtPGS/Ppr Size	Other (Standard)	CTL*	[0 to 99999999 / 0 / 1/step]
8-447-255	O:PrtPGS/Ppr Size	Other (Custom)	CTL*	[0 to 99999999 / 0 / 1/step]
8-451-001	PrtPGS/Ppr Tray	Bypass Tray	CTL*	[0 to 99999999 / 0 / 1/step]
8-451-002	PrtPGS/Ppr Tray	Tray 1	CTL*	[0 to 99999999 / 0 / 1/step]
8-451-	PrtPGS/Ppr Tray	Tray 2	CTL*	[0 to 99999999 / 0 /

3.SP Mode Tables

SP No.	Large Category	Small Category	ENG or CTL	[Min to Max/Init./Step]
003				1/step]
8-451-004	PrtPGS/Ppr Tray	Tray 3	CTL*	[0 to 99999999 / 0 / 1/step]
8-451-005	PrtPGS/Ppr Tray	Tray 4	CTL*	[0 to 99999999 / 0 / 1/step]
8-451-006	PrtPGS/Ppr Tray	Tray 5	CTL*	[0 to 99999999 / 0 / 1/step]
8-451-007	PrtPGS/Ppr Tray	Tray 6	CTL*	[0 to 99999999 / 0 / 1/step]
8-451-008	PrtPGS/Ppr Tray	Tray 7	CTL*	[0 to 99999999 / 0 / 1/step]
8-451-009	PrtPGS/Ppr Tray	Tray 8	CTL*	[0 to 99999999 / 0 / 1/step]
8-451-010	PrtPGS/Ppr Tray	Tray 9	CTL*	[0 to 99999999 / 0 / 1/step]
8-451-011	PrtPGS/Ppr Tray	Tray 10	CTL*	[0 to 99999999 / 0 / 1/step]
8-451-012	PrtPGS/Ppr Tray	Tray 11	CTL*	[0 to 99999999 / 0 / 1/step]
8-451-013	PrtPGS/Ppr Tray	Tray 12	CTL*	[0 to 99999999 / 0 / 1/step]
8-451-014	PrtPGS/Ppr Tray	Tray 13	CTL*	[0 to 99999999 / 0 / 1/step]
8-451-015	PrtPGS/Ppr Tray	Tray 14	CTL*	[0 to 99999999 / 0 / 1/step]
8-451-016	PrtPGS/Ppr Tray	Tray 15	CTL*	[0 to 99999999 / 0 / 1/step]
8-451-101	PrtPGS/Ppr Tray	LC Inserter	CTL*	[0 to 99999999 / 0 / 1/step]
8-451-102	PrtPGS/Ppr Tray	3rd Vendor	CTL*	[0 to 99999999 / 0 / 1/step]

SP8-XXX (Data Log 2)-2

SP No.	Large Category	Small Category	ENG or CTL	[Min to Max/Init./Step]
8-461-001	T:PrtPGS/Ppr Type	Normal	CTL*	[0 to 99999999 / 0 / 1/step]

3.SP Mode Tables

SP No.	Large Category	Small Category	ENG or CTL	[Min to Max/Init./Step]
8-461-002	T:PrtPGS/Ppr Type	Recycled	CTL*	[0 to 99999999 / 0 / 1/step]
8-461-003	T:PrtPGS/Ppr Type	Special	CTL*	[0 to 99999999 / 0 / 1/step]
8-461-004	T:PrtPGS/Ppr Type	Thick	CTL*	[0 to 99999999 / 0 / 1/step]
8-461-005	T:PrtPGS/Ppr Type	Normal (Back)	CTL*	[0 to 99999999 / 0 / 1/step]
8-461-006	T:PrtPGS/Ppr Type	Thick (Back)	CTL*	[0 to 99999999 / 0 / 1/step]
8-461-007	T:PrtPGS/Ppr Type	OHP	CTL*	[0 to 99999999 / 0 / 1/step]
8-461-008	T:PrtPGS/Ppr Type	Other	CTL*	[0 to 99999999 / 0 / 1/step]
8-462-001	C:PrtPGS/Ppr Type	Normal	CTL*	[0 to 99999999 / 0 / 1/step]
8-462-002	C:PrtPGS/Ppr Type	Recycled	CTL*	[0 to 99999999 / 0 / 1/step]
8-462-003	C:PrtPGS/Ppr Type	Special	CTL*	[0 to 99999999 / 0 / 1/step]
8-462-004	C:PrtPGS/Ppr Type	Thick	CTL*	[0 to 99999999 / 0 / 1/step]
8-462-005	C:PrtPGS/Ppr Type	Normal (Back)	CTL*	[0 to 99999999 / 0 / 1/step]
8-462-006	C:PrtPGS/Ppr Type	Thick (Back)	CTL*	[0 to 99999999 / 0 / 1/step]
8-462-007	C:PrtPGS/Ppr Type	OHP	CTL*	[0 to 99999999 / 0 / 1/step]
8-462-008	C:PrtPGS/Ppr Type	Other	CTL*	[0 to 99999999 / 0 / 1/step]
8-463-001	F:PrtPGS/Ppr Type	Normal	CTL*	[0 to 99999999 / 0 / 1/step]
8-463-002	F:PrtPGS/Ppr Type	Recycled	CTL*	[0 to 99999999 / 0 / 1/step]
8-463-003	F:PrtPGS/Ppr Type	Special	CTL*	[0 to 99999999 / 0 / 1/step]

3.SP Mode Tables

SP No.	Large Category	Small Category	ENG or CTL	[Min to Max/Init./Step]
8-463-004	F:PrtPGS/Ppr Type	Thick	CTL*	[0 to 99999999 / 0 / 1/step]
8-463-005	F:PrtPGS/Ppr Type	Normal (Back)	CTL*	[0 to 99999999 / 0 / 1/step]
8-463-006	F:PrtPGS/Ppr Type	Thick (Back)	CTL*	[0 to 99999999 / 0 / 1/step]
8-463-007	F:PrtPGS/Ppr Type	OHP	CTL*	[0 to 99999999 / 0 / 1/step]
8-463-008	F:PrtPGS/Ppr Type	Other	CTL*	[0 to 99999999 / 0 / 1/step]
8-464-001	P:PrtPGS/Ppr Type	Normal	CTL*	[0 to 99999999 / 0 / 1/step]
8-464-002	P:PrtPGS/Ppr Type	Recycled	CTL*	[0 to 99999999 / 0 / 1/step]
8-464-003	P:PrtPGS/Ppr Type	Special	CTL*	[0 to 99999999 / 0 / 1/step]
8-464-004	P:PrtPGS/Ppr Type	Thick	CTL*	[0 to 99999999 / 0 / 1/step]
8-464-005	P:PrtPGS/Ppr Type	Normal (Back)	CTL*	[0 to 99999999 / 0 / 1/step]
8-464-006	P:PrtPGS/Ppr Type	Thick (Back)	CTL*	[0 to 99999999 / 0 / 1/step]
8-464-007	P:PrtPGS/Ppr Type	OHP	CTL*	[0 to 99999999 / 0 / 1/step]
8-464-008	P:PrtPGS/Ppr Type	Other	CTL*	[0 to 99999999 / 0 / 1/step]
8-466-001	L:PrtPGS/Ppr Type	Normal	CTL*	[0 to 99999999 / 0 / 1/step]
8-466-002	L:PrtPGS/Ppr Type	Recycled	CTL*	[0 to 99999999 / 0 / 1/step]
8-466-003	L:PrtPGS/Ppr Type	Special	CTL*	[0 to 99999999 / 0 / 1/step]
8-466-004	L:PrtPGS/Ppr Type	Thick	CTL*	[0 to 99999999 / 0 / 1/step]
8-466-005	L:PrtPGS/Ppr Type	Normal (Back)	CTL*	[0 to 99999999 / 0 / 1/step]

3.SP Mode Tables

SP No.	Large Category	Small Category	ENG or CTL	[Min to Max/Init./Step]
8-466-006	L:PrtPGS/Ppr Type	Thick (Back)	CTL*	[0 to 99999999 / 0 / 1/step]
8-466-007	L:PrtPGS/Ppr Type	OHP	CTL*	[0 to 99999999 / 0 / 1/step]
8-466-008	L:PrtPGS/Ppr Type	Other	CTL*	[0 to 99999999 / 0 / 1/step]
8-471-001	PrtPGS/Mag	~49%	CTL*	[0 to 99999999 / 0 / 1/step]
8-471-002	PrtPGS/Mag	50%~99%	CTL*	[0 to 99999999 / 0 / 1/step]
8-471-003	PrtPGS/Mag	100%	CTL*	[0 to 99999999 / 0 / 1/step]
8-471-004	PrtPGS/Mag	101%~200%	CTL*	[0 to 99999999 / 0 / 1/step]
8-471-005	PrtPGS/Mag	201% ~	CTL*	[0 to 99999999 / 0 / 1/step]
8-481-001	T:PrtPGS/TonSave		CTL*	[0 to 99999999 / 0 / 1/step]
8-484-001	P:PrtPGS/TonSave		CTL*	[0 to 99999999 / 0 / 1/step]
8-491-001	T:PrtPGS/Col Mode	B/W	CTL*	[0 to 99999999 / 0 / 1/step]
8-491-002	T:PrtPGS/Col Mode	Single Color	CTL*	[0 to 99999999 / 0 / 1/step]
8-491-003	T:PrtPGS/Col Mode	Two Color	CTL*	[0 to 99999999 / 0 / 1/step]
8-491-004	T:PrtPGS/Col Mode	Full Color	CTL*	[0 to 99999999 / 0 / 1/step]
8-491-051	T:PrtPGS/Col Mode	B/W(Banner)	CTL*	[0 to 99999999 / 0 / 1/step]
8-491-052	T:PrtPGS/Col Mode	Single Color(Banner)	CTL*	[0 to 99999999 / 0 / 1/step]
8-491-053	T:PrtPGS/Col Mode	Two Color(Banner)	CTL*	[0 to 99999999 / 0 / 1/step]
8-491-054	T:PrtPGS/Col Mode	Full Color(Banner)	CTL*	[0 to 99999999 / 0 / 1/step]

3.SP Mode Tables

SP No.	Large Category	Small Category	ENG or CTL	[Min to Max/Init./Step]
8-492-001	C:PrtPGS/Col Mode	B/W	CTL*	[0 to 99999999 / 0 / 1/step]
8-492-002	C:PrtPGS/Col Mode	Single Color	CTL*	[0 to 99999999 / 0 / 1/step]
8-492-003	C:PrtPGS/Col Mode	Two Color	CTL*	[0 to 99999999 / 0 / 1/step]
8-492-004	C:PrtPGS/Col Mode	Full Color	CTL*	[0 to 99999999 / 0 / 1/step]
8-492-051	C:PrtPGS/Col Mode	B/W(Banner)	CTL*	[0 to 99999999 / 0 / 1/step]
8-492-052	C:PrtPGS/Col Mode	Single Color(Banner)	CTL*	[0 to 99999999 / 0 / 1/step]
8-492-053	C:PrtPGS/Col Mode	Two Color(Banner)	CTL*	[0 to 99999999 / 0 / 1/step]
8-492-054	C:PrtPGS/Col Mode	Full Color(Banner)	CTL*	[0 to 99999999 / 0 / 1/step]
8-493-001	F:PrtPGS/Col Mode	B/W	CTL*	[0 to 99999999 / 0 / 1/step]
8-493-002	F:PrtPGS/Col Mode	Single Color	CTL*	[0 to 99999999 / 0 / 1/step]
8-493-003	F:PrtPGS/Col Mode	Two Color	CTL*	[0 to 99999999 / 0 / 1/step]
8-493-004	F:PrtPGS/Col Mode	Full Color	CTL*	[0 to 99999999 / 0 / 1/step]
8-493-051	F:PrtPGS/Col Mode	B/W(Banner)	CTL*	[0 to 99999999 / 0 / 1/step]
8-493-052	F:PrtPGS/Col Mode	Single Color(Banner)	CTL*	[0 to 99999999 / 0 / 1/step]
8-493-053	F:PrtPGS/Col Mode	Two Color(Banner)	CTL*	[0 to 99999999 / 0 / 1/step]
8-493-054	F:PrtPGS/Col Mode	Full Color(Banner)	CTL*	[0 to 99999999 / 0 / 1/step]
8-496-001	L:PrtPGS/Col Mode	B/W	CTL*	[0 to 99999999 / 0 / 1/step]
8-496-002	L:PrtPGS/Col Mode	Single Color	CTL*	[0 to 99999999 / 0 / 1/step]

3.SP Mode Tables

SP No.	Large Category	Small Category	ENG or CTL	[Min to Max/Init./Step]
8-496-003	L:PrtPGS/Col Mode	Two Color	CTL*	[0 to 99999999 / 0 / 1/step]
8-496-004	L:PrtPGS/Col Mode	Full Color	CTL*	[0 to 99999999 / 0 / 1/step]
8-496-051	L:PrtPGS/Col Mode	BW(Banner)	CTL*	[0 to 99999999 / 0 / 1/step]
8-496-052	L:PrtPGS/Col Mode	Single Color(Banner)	CTL*	[0 to 99999999 / 0 / 1/step]
8-496-053	L:PrtPGS/Col Mode	Two Color(Banner)	CTL*	[0 to 99999999 / 0 / 1/step]
8-496-054	L:PrtPGS/Col Mode	Full Color(Banner)	CTL*	[0 to 99999999 / 0 / 1/step]
8-497-001	O:PrtPGS/Col Mode	BW	CTL*	[0 to 99999999 / 0 / 1/step]
8-497-002	O:PrtPGS/Col Mode	Single Color	CTL*	[0 to 99999999 / 0 / 1/step]
8-497-003	O:PrtPGS/Col Mode	Two Color	CTL*	[0 to 99999999 / 0 / 1/step]
8-497-004	O:PrtPGS/Col Mode	Full Color	CTL*	[0 to 99999999 / 0 / 1/step]
8-497-051	O:PrtPGS/Col Mode	BW(Banner)	CTL*	[0 to 99999999 / 0 / 1/step]
8-497-052	O:PrtPGS/Col Mode	Single Color(Banner)	CTL*	[0 to 99999999 / 0 / 1/step]
8-497-053	O:PrtPGS/Col Mode	Two Color(Banner)	CTL*	[0 to 99999999 / 0 / 1/step]
8-497-054	O:PrtPGS/Col Mode	Full Color(Banner)	CTL*	[0 to 99999999 / 0 / 1/step]
8-501-001	T:PrtPGS/Col Mode	BW	CTL*	[0 to 99999999 / 0 / 1/step]
8-501-002	T:PrtPGS/Col Mode	Mono Color	CTL*	[0 to 99999999 / 0 / 1/step]
8-501-003	T:PrtPGS/Col Mode	Full Color	CTL*	[0 to 99999999 / 0 / 1/step]
8-501-004	T:PrtPGS/Col Mode	Single Color	CTL*	[0 to 99999999 / 0 / 1/step]

3.SP Mode Tables

SP No.	Large Category	Small Category	ENG or CTL	[Min to Max/Init./Step]
8-501-005	T:PrtPGS/Col Mode	Two Color	CTL*	[0 to 99999999 / 0 / 1/step]
8-501-051	T:PrtPGS/Col Mode	B/W(Banner)	CTL*	[0 to 99999999 / 0 / 1/step]
8-501-052	T:PrtPGS/Col Mode	Full Color(Banner)	CTL*	[0 to 99999999 / 0 / 1/step]
8-501-053	T:PrtPGS/Col Mode	Single Color(Banner)	CTL*	[0 to 99999999 / 0 / 1/step]
8-501-054	T:PrtPGS/Col Mode	Two Color(Banner)	CTL*	[0 to 99999999 / 0 / 1/step]
8-501-101	T:PrtPGS/Col Mode	DFE:B/W	CTL*	[0 to 99999999 / 0 / 1/step]
8-501-102	T:PrtPGS/Col Mode	DFE:Mono Color	CTL*	[0 to 99999999 / 0 / 1/step]
8-501-103	T:PrtPGS/Col Mode	DFE:Full Color	CTL*	[0 to 99999999 / 0 / 1/step]
8-501-104	T:PrtPGS/Col Mode	DFE:Single Color	CTL*	[0 to 99999999 / 0 / 1/step]
8-501-105	T:PrtPGS/Col Mode	DFE:Two Color	CTL*	[0 to 99999999 / 0 / 1/step]
8-501-151	T:PrtPGS/Col Mode	DFE:B/W(Banner)	CTL*	[0 to 99999999 / 0 / 1/step]
8-501-152	T:PrtPGS/Col Mode	DFE:Full Color(Banner)	CTL*	[0 to 99999999 / 0 / 1/step]
8-501-153	T:PrtPGS/Col Mode	DFE:Single Color(Banner)	CTL*	[0 to 99999999 / 0 / 1/step]
8-501-154	T:PrtPGS/Col Mode	DFE:Two Color(Banner)	CTL*	[0 to 99999999 / 0 / 1/step]
8-504-001	P:PrtPGS/Col Mode	B/W	CTL*	[0 to 99999999 / 0 / 1/step]
8-504-002	P:PrtPGS/Col Mode	Mono Color	CTL*	[0 to 99999999 / 0 / 1/step]
8-504-003	P:PrtPGS/Col Mode	Full Color	CTL*	[0 to 99999999 / 0 / 1/step]
8-504-004	P:PrtPGS/Col Mode	Single Color	CTL*	[0 to 99999999 / 0 / 1/step]

3.SP Mode Tables

SP No.	Large Category	Small Category	ENG or CTL	[Min to Max/Init./Step]
8-504-005	P:PrtPGS/Col Mode	Two Color	CTL*	[0 to 99999999 / 0 / 1/step]
8-504-051	P:PrtPGS/Col Mode	B/W(Banner)	CTL*	[0 to 99999999 / 0 / 1/step]
8-504-052	P:PrtPGS/Col Mode	Full Color(Banner)	CTL*	[0 to 99999999 / 0 / 1/step]
8-504-053	P:PrtPGS/Col Mode	Single Color(Banner)	CTL*	[0 to 99999999 / 0 / 1/step]
8-504-054	P:PrtPGS/Col Mode	Two Color(Banner)	CTL*	[0 to 99999999 / 0 / 1/step]
8-504-101	P:PrtPGS/Col Mode	DFE:B/W	CTL*	[0 to 99999999 / 0 / 1/step]
8-504-102	P:PrtPGS/Col Mode	DFE:Mono Color	CTL*	[0 to 99999999 / 0 / 1/step]
8-504-103	P:PrtPGS/Col Mode	DFE:Full Color	CTL*	[0 to 99999999 / 0 / 1/step]
8-504-104	P:PrtPGS/Col Mode	DFE:Single Color	CTL*	[0 to 99999999 / 0 / 1/step]
8-504-105	P:PrtPGS/Col Mode	DFE:Two Color	CTL*	[0 to 99999999 / 0 / 1/step]
8-504-151	P:PrtPGS/Col Mode	DFE:B/W(Banner)	CTL*	[0 to 99999999 / 0 / 1/step]
8-504-152	P:PrtPGS/Col Mode	DFE:Full Color(Banner)	CTL*	[0 to 99999999 / 0 / 1/step]
8-504-153	P:PrtPGS/Col Mode	DFE:Single Color(Banner)	CTL*	[0 to 99999999 / 0 / 1/step]
8-504-154	P:PrtPGS/Col Mode	DFE:Two Color(Banner)	CTL*	[0 to 99999999 / 0 / 1/step]
8-507-001	O:PrtPGS/Col Mode	B/W	CTL*	[0 to 99999999 / 0 / 1/step]
8-507-002	O:PrtPGS/Col Mode	Mono Color	CTL*	[0 to 99999999 / 0 / 1/step]
8-507-003	O:PrtPGS/Col Mode	Full Color	CTL*	[0 to 99999999 / 0 / 1/step]
8-507-004	O:PrtPGS/Col Mode	Single Color	CTL*	[0 to 99999999 / 0 / 1/step]

3.SP Mode Tables

SP No.	Large Category	Small Category	ENG or CTL	[Min to Max/Init./Step]
8-507-005	O:PrtPGS/Col Mode	Two Color	CTL*	[0 to 99999999 / 0 / 1/step]
8-507-051	O:PrtPGS/Col Mode	B/W(Banner)	CTL*	[0 to 99999999 / 0 / 1/step]
8-507-052	O:PrtPGS/Col Mode	Full Color(Banner)	CTL*	[0 to 99999999 / 0 / 1/step]
8-507-053	O:PrtPGS/Col Mode	Single Color(Banner)	CTL*	[0 to 99999999 / 0 / 1/step]
8-507-054	O:PrtPGS/Col Mode	Two Color(Banner)	CTL*	[0 to 99999999 / 0 / 1/step]
8-511-001	T:PrtPGS/Emul	RPCS	CTL*	[0 to 99999999 / 0 / 1/step]
8-511-002	T:PrtPGS/Emul	RPDL	CTL*	[0 to 99999999 / 0 / 1/step]
8-511-003	T:PrtPGS/Emul	PS3	CTL*	[0 to 99999999 / 0 / 1/step]
8-511-004	T:PrtPGS/Emul	R98	CTL*	[0 to 99999999 / 0 / 1/step]
8-511-005	T:PrtPGS/Emul	R16	CTL*	[0 to 99999999 / 0 / 1/step]
8-511-006	T:PrtPGS/Emul	GL/GL2	CTL*	[0 to 99999999 / 0 / 1/step]
8-511-007	T:PrtPGS/Emul	R55	CTL*	[0 to 99999999 / 0 / 1/step]
8-511-008	T:PrtPGS/Emul	RTIFF	CTL*	[0 to 99999999 / 0 / 1/step]
8-511-009	T:PrtPGS/Emul	PDF	CTL*	[0 to 99999999 / 0 / 1/step]
8-511-010	T:PrtPGS/Emul	PCL5e/5c	CTL*	[0 to 99999999 / 0 / 1/step]
8-511-011	T:PrtPGS/Emul	PCL XL	CTL*	[0 to 99999999 / 0 / 1/step]
8-511-012	T:PrtPGS/Emul	IPDL-C	CTL*	[0 to 99999999 / 0 / 1/step]
8-511-013	T:PrtPGS/Emul	BM-Links	CTL*	[0 to 99999999 / 0 / 1/step]

3.SP Mode Tables

SP No.	Large Category	Small Category	ENG or CTL	[Min to Max/Init./Step]
8-511-014	T:PrtPGS/Emul	Other	CTL*	[0 to 99999999 / 0 / 1/step]
8-511-015	T:PrtPGS/Emul	IPDS	CTL*	[0 to 99999999 / 0 / 1/step]
8-511-016	T:PrtPGS/Emul	XPS	CTL*	[0 to 99999999 / 0 / 1/step]
8-511-017	T:PrtPGS/Emul	IRIPS PS	CTL*	[0 to 99999999 / 0 / 1/step]
8-511-018	T:PrtPGS/Emul	IRIPS PDF	CTL*	[0 to 99999999 / 0 / 1/step]
8-511-019	T:PrtPGS/Emul	PictBridge	CTL*	[0 to 99999999 / 0 / 1/step]
8-511-020	T:PrtPGS/Emul	MediaPrintTIFF	CTL*	[0 to 99999999 / 0 / 1/step]
8-511-021	T:PrtPGS/Emul	MediaPrintJPEG	CTL*	[0 to 99999999 / 0 / 1/step]
8-511-022	T:PrtPGS/Emul	GG PDF	CTL*	[0 to 99999999 / 0 / 1/step]
8-511-023	T:PrtPGS/Emul	GG PCL	CTL*	[0 to 99999999 / 0 / 1/step]
8-514-001	P:PrtPGS/Emul	RPCS	CTL*	[0 to 99999999 / 0 / 1/step]
8-514-002	P:PrtPGS/Emul	RPDL	CTL*	[0 to 99999999 / 0 / 1/step]
8-514-003	P:PrtPGS/Emul	PS3	CTL*	[0 to 99999999 / 0 / 1/step]
8-514-004	P:PrtPGS/Emul	R98	CTL*	[0 to 99999999 / 0 / 1/step]
8-514-005	P:PrtPGS/Emul	R16	CTL*	[0 to 99999999 / 0 / 1/step]
8-514-006	P:PrtPGS/Emul	GL/GL2	CTL*	[0 to 99999999 / 0 / 1/step]
8-514-007	P:PrtPGS/Emul	R55	CTL*	[0 to 99999999 / 0 / 1/step]
8-514-008	P:PrtPGS/Emul	RTIFF	CTL*	[0 to 99999999 / 0 / 1/step]

3.SP Mode Tables

SP No.	Large Category	Small Category	ENG or CTL	[Min to Max/Init./Step]
8-514-009	P:PrtPGS/Emul	PDF	CTL*	[0 to 99999999 / 0 / 1/step]
8-514-010	P:PrtPGS/Emul	PCL5e/5c	CTL*	[0 to 99999999 / 0 / 1/step]
8-514-011	P:PrtPGS/Emul	PCL XL	CTL*	[0 to 99999999 / 0 / 1/step]
8-514-012	P:PrtPGS/Emul	IPDL-C	CTL*	[0 to 99999999 / 0 / 1/step]
8-514-013	P:PrtPGS/Emul	BM-Links	CTL*	[0 to 99999999 / 0 / 1/step]
8-514-014	P:PrtPGS/Emul	Other	CTL*	[0 to 99999999 / 0 / 1/step]
8-514-015	P:PrtPGS/Emul	IPDS	CTL*	[0 to 99999999 / 0 / 1/step]
8-514-016	P:PrtPGS/Emul	XPS	CTL*	[0 to 99999999 / 0 / 1/step]
8-514-017	P:PrtPGS/Emul	IRIPS PS	CTL*	[0 to 99999999 / 0 / 1/step]
8-514-018	P:PrtPGS/Emul	IRIPS PDF	CTL*	[0 to 99999999 / 0 / 1/step]
8-514-019	P:PrtPGS/Emul	PictBridge	CTL*	[0 to 99999999 / 0 / 1/step]
8-514-020	P:PrtPGS/Emul	MediaPrintTIFF	CTL*	[0 to 99999999 / 0 / 1/step]
8-514-021	P:PrtPGS/Emul	MediaPrintJPEG	CTL*	[0 to 99999999 / 0 / 1/step]
8-514-022	P:PrtPGS/Emul	GG PDF	CTL*	[0 to 99999999 / 0 / 1/step]
8-514-023	P:PrtPGS/Emul	GG PCL	CTL*	[0 to 99999999 / 0 / 1/step]
8-521-001	T:PrtPGS/FIN	Sort	CTL*	[0 to 99999999 / 0 / 1/step]
8-521-002	T:PrtPGS/FIN	Stack	CTL*	[0 to 99999999 / 0 / 1/step]
8-521-003	T:PrtPGS/FIN	Staple	CTL*	[0 to 99999999 / 0 / 1/step]

3.SP Mode Tables

SP No.	Large Category	Small Category	ENG or CTL	[Min to Max/Init./Step]
8-521-004	T:PrtPGS/FIN	Booklet	CTL*	[0 to 99999999 / 0 / 1/step]
8-521-005	T:PrtPGS/FIN	Z-Fold	CTL*	[0 to 99999999 / 0 / 1/step]
8-521-006	T:PrtPGS/FIN	Punch	CTL*	[0 to 99999999 / 0 / 1/step]
8-521-007	T:PrtPGS/FIN	Other	CTL*	[0 to 99999999 / 0 / 1/step]
8-521-008	T:PrtPGS/FIN	Inside-Fold	CTL*	[0 to 99999999 / 0 / 1/step]
8-521-009	T:PrtPGS/FIN	Three-IN-Fold	CTL*	[0 to 99999999 / 0 / 1/step]
8-521-010	T:PrtPGS/FIN	Three-OUT-Fold	CTL*	[0 to 99999999 / 0 / 1/step]
8-521-011	T:PrtPGS/FIN	Four-Fold	CTL*	[0 to 99999999 / 0 / 1/step]
8-521-012	T:PrtPGS/FIN	KANNON-Fold	CTL*	[0 to 99999999 / 0 / 1/step]
8-521-013	T:PrtPGS/FIN	Perfect-Bind	CTL*	[0 to 99999999 / 0 / 1/step]
8-521-014	T:PrtPGS/FIN	Ring-Bind	CTL*	[0 to 99999999 / 0 / 1/step]
8-521-015	T:PrtPGS/FIN	3rd Vendor	CTL*	[0 to 99999999 / 0 / 1/step]
8-521-016	T:PrtPGS/FIN	TwinLoop-Bind	CTL*	[0 to 99999999 / 0 / 1/step]
8-522-001	C:PrtPGS/FIN	Sort	CTL*	[0 to 99999999 / 0 / 1/step]
8-522-002	C:PrtPGS/FIN	Stack	CTL*	[0 to 99999999 / 0 / 1/step]
8-522-003	C:PrtPGS/FIN	Staple	CTL*	[0 to 99999999 / 0 / 1/step]
8-522-004	C:PrtPGS/FIN	Booklet	CTL*	[0 to 99999999 / 0 / 1/step]
8-522-005	C:PrtPGS/FIN	Z-Fold	CTL*	[0 to 99999999 / 0 / 1/step]

3.SP Mode Tables

SP No.	Large Category	Small Category	ENG or CTL	[Min to Max/Init./Step]
8-522-006	C:PrtPGS/FIN	Punch	CTL*	[0 to 99999999 / 0 / 1/step]
8-522-007	C:PrtPGS/FIN	Other	CTL*	[0 to 99999999 / 0 / 1/step]
8-522-008	C:PrtPGS/FIN	Inside-Fold	CTL*	[0 to 99999999 / 0 / 1/step]
8-522-009	C:PrtPGS/FIN	Three-IN-Fold	CTL*	[0 to 99999999 / 0 / 1/step]
8-522-010	C:PrtPGS/FIN	Three-OUT-Fold	CTL*	[0 to 99999999 / 0 / 1/step]
8-522-011	C:PrtPGS/FIN	Four-Fold	CTL*	[0 to 99999999 / 0 / 1/step]
8-522-012	C:PrtPGS/FIN	KANNON-Fold	CTL*	[0 to 99999999 / 0 / 1/step]
8-522-013	C:PrtPGS/FIN	Perfect-Bind	CTL*	[0 to 99999999 / 0 / 1/step]
8-522-014	C:PrtPGS/FIN	Ring-Bind	CTL*	[0 to 99999999 / 0 / 1/step]
8-522-015	C:PrtPGS/FIN	3rd Vendor	CTL*	[0 to 99999999 / 0 / 1/step]
8-522-016	C:PrtPGS/FIN	TwinLoop-Bind	CTL*	[0 to 99999999 / 0 / 1/step]
8-523-001	F:PrtPGS/FIN	Sort	CTL*	[0 to 99999999 / 0 / 1/step]
8-523-002	F:PrtPGS/FIN	Stack	CTL*	[0 to 99999999 / 0 / 1/step]
8-523-003	F:PrtPGS/FIN	Staple	CTL*	[0 to 99999999 / 0 / 1/step]
8-523-004	F:PrtPGS/FIN	Booklet	CTL*	[0 to 99999999 / 0 / 1/step]
8-523-005	F:PrtPGS/FIN	Z-Fold	CTL*	[0 to 99999999 / 0 / 1/step]
8-523-006	F:PrtPGS/FIN	Punch	CTL*	[0 to 99999999 / 0 / 1/step]
8-523-007	F:PrtPGS/FIN	Other	CTL*	[0 to 99999999 / 0 / 1/step]

3.SP Mode Tables

SP No.	Large Category	Small Category	ENG or CTL	[Min to Max/Init./Step]
8-523-008	F:PrtPGS/FIN	Inside-Fold	CTL*	[0 to 99999999 / 0 / 1/step]
8-523-009	F:PrtPGS/FIN	Three-IN-Fold	CTL*	[0 to 99999999 / 0 / 1/step]
8-523-010	F:PrtPGS/FIN	Three-OUT-Fold	CTL*	[0 to 99999999 / 0 / 1/step]
8-523-011	F:PrtPGS/FIN	Four-Fold	CTL*	[0 to 99999999 / 0 / 1/step]
8-523-012	F:PrtPGS/FIN	KANNON-Fold	CTL*	[0 to 99999999 / 0 / 1/step]
8-523-013	F:PrtPGS/FIN	Perfect-Bind	CTL*	[0 to 99999999 / 0 / 1/step]
8-523-014	F:PrtPGS/FIN	Ring-Bind	CTL*	[0 to 99999999 / 0 / 1/step]
8-523-015	F:PrtPGS/FIN	3rd Vendor	CTL*	[0 to 99999999 / 0 / 1/step]
8-523-016	F:PrtPGS/FIN	TwinLoop-Bind	CTL*	[0 to 99999999 / 0 / 1/step]
8-524-001	P:PrtPGS/FIN	Sort	CTL*	[0 to 99999999 / 0 / 1/step]
8-524-002	P:PrtPGS/FIN	Stack	CTL*	[0 to 99999999 / 0 / 1/step]
8-524-003	P:PrtPGS/FIN	Staple	CTL*	[0 to 99999999 / 0 / 1/step]
8-524-004	P:PrtPGS/FIN	Booklet	CTL*	[0 to 99999999 / 0 / 1/step]
8-524-005	P:PrtPGS/FIN	Z-Fold	CTL*	[0 to 99999999 / 0 / 1/step]
8-524-006	P:PrtPGS/FIN	Punch	CTL*	[0 to 99999999 / 0 / 1/step]
8-524-007	P:PrtPGS/FIN	Other	CTL*	[0 to 99999999 / 0 / 1/step]
8-524-008	P:PrtPGS/FIN	Inside-Fold	CTL*	[0 to 99999999 / 0 / 1/step]
8-524-009	P:PrtPGS/FIN	Three-IN-Fold	CTL*	[0 to 99999999 / 0 / 1/step]

3.SP Mode Tables

SP No.	Large Category	Small Category	ENG or CTL	[Min to Max/Init./Step]
8-524-010	P:PrtPGS/FIN	Three-OUT-Fold	CTL*	[0 to 99999999 / 0 / 1/step]
8-524-011	P:PrtPGS/FIN	Four-Fold	CTL*	[0 to 99999999 / 0 / 1/step]
8-524-012	P:PrtPGS/FIN	KANNON-Fold	CTL*	[0 to 99999999 / 0 / 1/step]
8-524-013	P:PrtPGS/FIN	Perfect-Bind	CTL*	[0 to 99999999 / 0 / 1/step]
8-524-014	P:PrtPGS/FIN	Ring-Bind	CTL*	[0 to 99999999 / 0 / 1/step]
8-524-015	P:PrtPGS/FIN	3rd Vendor	CTL*	[0 to 99999999 / 0 / 1/step]
8-524-016	P:PrtPGS/FIN	TwinLoop-Bind	CTL*	[0 to 99999999 / 0 / 1/step]
8-525-001	S:PrtPGS/FIN	Sort	CTL*	[0 to 99999999 / 0 / 1/step]
8-525-002	S:PrtPGS/FIN	Stack	CTL*	[0 to 99999999 / 0 / 1/step]
8-525-003	S:PrtPGS/FIN	Staple	CTL*	[0 to 99999999 / 0 / 1/step]
8-525-004	S:PrtPGS/FIN	Booklet	CTL*	[0 to 99999999 / 0 / 1/step]
8-525-005	S:PrtPGS/FIN	Z-Fold	CTL*	[0 to 99999999 / 0 / 1/step]
8-525-006	S:PrtPGS/FIN	Punch	CTL*	[0 to 99999999 / 0 / 1/step]
8-525-007	S:PrtPGS/FIN	Other	CTL*	[0 to 99999999 / 0 / 1/step]
8-525-008	S:PrtPGS/FIN	Inside-Fold	CTL*	[0 to 99999999 / 0 / 1/step]
8-525-009	S:PrtPGS/FIN	Three-IN-Fold	CTL*	[0 to 99999999 / 0 / 1/step]
8-525-010	S:PrtPGS/FIN	Three-OUT-Fold	CTL*	[0 to 99999999 / 0 / 1/step]
8-525-011	S:PrtPGS/FIN	Four-Fold	CTL*	[0 to 99999999 / 0 / 1/step]

3.SP Mode Tables

SP No.	Large Category	Small Category	ENG or CTL	[Min to Max/Init./Step]
8-525-012	S:PrtPGS/FIN	KANNON-Fold	CTL*	[0 to 99999999 / 0 / 1/step]
8-525-013	S:PrtPGS/FIN	Perfect-Bind	CTL*	[0 to 99999999 / 0 / 1/step]
8-525-014	S:PrtPGS/FIN	Ring-Bind	CTL*	[0 to 99999999 / 0 / 1/step]
8-525-015	S:PrtPGS/FIN	3rd Vendor	CTL*	[0 to 99999999 / 0 / 1/step]
8-525-016	S:PrtPGS/FIN	TwinLoop-Bind	CTL*	[0 to 99999999 / 0 / 1/step]
8-526-001	L:PrtPGS/FIN	Sort	CTL*	[0 to 99999999 / 0 / 1/step]
8-526-002	L:PrtPGS/FIN	Stack	CTL*	[0 to 99999999 / 0 / 1/step]
8-526-003	L:PrtPGS/FIN	Staple	CTL*	[0 to 99999999 / 0 / 1/step]
8-526-004	L:PrtPGS/FIN	Booklet	CTL*	[0 to 99999999 / 0 / 1/step]
8-526-005	L:PrtPGS/FIN	Z-Fold	CTL*	[0 to 99999999 / 0 / 1/step]
8-526-006	L:PrtPGS/FIN	Punch	CTL*	[0 to 99999999 / 0 / 1/step]
8-526-007	L:PrtPGS/FIN	Other	CTL*	[0 to 99999999 / 0 / 1/step]
8-526-008	L:PrtPGS/FIN	Inside-Fold	CTL*	[0 to 99999999 / 0 / 1/step]
8-526-009	L:PrtPGS/FIN	Three-IN-Fold	CTL*	[0 to 99999999 / 0 / 1/step]
8-526-010	L:PrtPGS/FIN	Three-OUT-Fold	CTL*	[0 to 99999999 / 0 / 1/step]
8-526-011	L:PrtPGS/FIN	Four-Fold	CTL*	[0 to 99999999 / 0 / 1/step]
8-526-012	L:PrtPGS/FIN	KANNON-Fold	CTL*	[0 to 99999999 / 0 / 1/step]
8-526-013	L:PrtPGS/FIN	Perfect-Bind	CTL*	[0 to 99999999 / 0 / 1/step]

3.SP Mode Tables

SP No.	Large Category	Small Category	ENG or CTL	[Min to Max/Init./Step]
8-526-014	L:PrtPGS/FIN	Ring-Bind	CTL*	[0 to 99999999 / 0 / 1/step]
8-526-015	L:PrtPGS/FIN	3rd Vendor	CTL*	[0 to 99999999 / 0 / 1/step]
8-526-016	L:PrtPGS/FIN	TwinLoop-Bind	CTL*	[0 to 99999999 / 0 / 1/step]
8-531-001	Staple	Staples	CTL*	[0 to 99999999 / 0 / 1/step]
8-531-002	Staple	Stapless	CTL*	[0 to 99999999 / 0 / 1/step]
8-551-001	T:PrtBooks/FIN	Perfect-Bind	CTL*	[0 to 99999999 / 0 / 1/step]
8-551-002	T:PrtBooks/FIN	Ring-Bind	CTL*	[0 to 99999999 / 0 / 1/step]
8-551-003	T:PrtBooks/FIN	TwinLoop-Bind	CTL*	[0 to 99999999 / 0 / 1/step]
8-552-001	C:PrtBooks/FIN	Perfect-Bind	CTL*	[0 to 99999999 / 0 / 1/step]
8-552-002	C:PrtBooks/FIN	Ring-Bind	CTL*	[0 to 99999999 / 0 / 1/step]
8-552-003	C:PrtBooks/FIN	TwinLoop-Bind	CTL*	[0 to 99999999 / 0 / 1/step]
8-554-001	P:PrtBooks/FIN	Perfect-Bind	CTL*	[0 to 99999999 / 0 / 1/step]
8-554-002	P:PrtBooks/FIN	Ring-Bind	CTL*	[0 to 99999999 / 0 / 1/step]
8-554-003	P:PrtBooks/FIN	TwinLoop-Bind	CTL*	[0 to 99999999 / 0 / 1/step]
8-556-001	L:PrtBooks/FIN	Perfect-Bind	CTL*	[0 to 99999999 / 0 / 1/step]
8-556-002	L:PrtBooks/FIN	Ring-Bind	CTL*	[0 to 99999999 / 0 / 1/step]
8-556-003	L:PrtBooks/FIN	TwinLoop-Bind	CTL*	[0 to 99999999 / 0 / 1/step]
8-561-001	T:A Sheet Of Paper	Total: Over A3/DLT	CTL*	[0 to 99999999 / 0 / 1/step]

3.SP Mode Tables

SP No.	Large Category	Small Category	ENG or CTL	[Min to Max/Init./Step]
8-561-002	T:A Sheet Of Paper	Total: Under A3/DLT	CTL*	[0 to 99999999 / 0 / 1/step]
8-561-003	T:A Sheet Of Paper	Duplex: Over A3/DLT	CTL*	[0 to 99999999 / 0 / 1/step]
8-561-004	T:A Sheet Of Paper	Duplex: Under A3/DLT	CTL*	[0 to 99999999 / 0 / 1/step]
8-562-001	C:A Sheet Of Paper	Total: Over A3/DLT	CTL*	[0 to 99999999 / 0 / 1/step]
8-562-002	C:A Sheet Of Paper	Total: Under A3/DLT	CTL*	[0 to 99999999 / 0 / 1/step]
8-562-003	C:A Sheet Of Paper	Duplex: Over A3/DLT	CTL*	[0 to 99999999 / 0 / 1/step]
8-562-004	C:A Sheet Of Paper	Duplex: Under A3/DLT	CTL*	[0 to 99999999 / 0 / 1/step]
8-563-001	F:A Sheet Of Paper	Total: Over A3/DLT	CTL*	[0 to 99999999 / 0 / 1/step]
8-563-002	F:A Sheet Of Paper	Total: Under A3/DLT	CTL*	[0 to 99999999 / 0 / 1/step]
8-563-003	F:A Sheet Of Paper	Duplex: Over A3/DLT	CTL*	[0 to 99999999 / 0 / 1/step]
8-563-004	F:A Sheet Of Paper	Duplex: Under A3/DLT	CTL*	[0 to 99999999 / 0 / 1/step]
8-564-001	P:A Sheet Of Paper	Total: Over A3/DLT	CTL*	[0 to 99999999 / 0 / 1/step]
8-564-002	P:A Sheet Of Paper	Total: Under A3/DLT	CTL*	[0 to 99999999 / 0 / 1/step]
8-564-003	P:A Sheet Of Paper	Duplex: Over A3/DLT	CTL*	[0 to 99999999 / 0 / 1/step]
8-564-004	P:A Sheet Of Paper	Duplex: Under A3/DLT	CTL*	[0 to 99999999 / 0 / 1/step]
8-566-001	L:A Sheet Of Paper	Total: Over A3/DLT	CTL*	[0 to 99999999 / 0 / 1/step]
8-566-002	L:A Sheet Of Paper	Total: Under A3/DLT	CTL*	[0 to 99999999 / 0 / 1/step]
8-566-003	L:A Sheet Of Paper	Duplex: Over A3/DLT	CTL*	[0 to 99999999 / 0 / 1/step]

3.SP Mode Tables

SP No.	Large Category	Small Category	ENG or CTL	[Min to Max/Init./Step]
8-566-004	L:A Sheet Of Paper	Duplex: Under A3/DLT	CTL*	[0 to 99999999 / 0 / 1/step]
8-567-001	O:A Sheet Of Paper	Total: Over A3/DLT	CTL*	[0 to 99999999 / 0 / 1/step]
8-567-002	O:A Sheet Of Paper	Total: Under A3/DLT	CTL*	[0 to 99999999 / 0 / 1/step]
8-567-003	O:A Sheet Of Paper	Duplex: Over A3/DLT	CTL*	[0 to 99999999 / 0 / 1/step]
8-567-004	O:A Sheet Of Paper	Duplex: Under A3/DLT	CTL*	[0 to 99999999 / 0 / 1/step]
8-581-001	T:Counter	Total	CTL*	[0 to 99999999 / 0 / 1/step]
8-581-002	T:Counter	Total: Full Color	CTL*	[0 to 99999999 / 0 / 1/step]
8-581-003	T:Counter	B&W/Single Color	CTL*	[0 to 99999999 / 0 / 1/step]
8-581-004	T:Counter	Development: CMY	CTL*	[0 to 99999999 / 0 / 1/step]
8-581-005	T:Counter	Development: K	CTL*	[0 to 99999999 / 0 / 1/step]
8-581-006	T:Counter	Copy: Color	CTL*	[0 to 99999999 / 0 / 1/step]
8-581-007	T:Counter	Copy: B/W	CTL*	[0 to 99999999 / 0 / 1/step]
8-581-008	T:Counter	Print: Color	CTL*	[0 to 99999999 / 0 / 1/step]
8-581-009	T:Counter	Print: B/W	CTL*	[0 to 99999999 / 0 / 1/step]
8-581-010	T:Counter	Total: Color	CTL*	[0 to 99999999 / 0 / 1/step]
8-581-011	T:Counter	Total: B/W	CTL*	[0 to 99999999 / 0 / 1/step]
8-581-012	T:Counter	Full Color: A3	CTL*	[0 to 99999999 / 0 / 1/step]
8-581-013	T:Counter	Full Color: B4 JIS or Smaller	CTL*	[0 to 99999999 / 0 / 1/step]

3.SP Mode Tables

SP No.	Large Category	Small Category	ENG or CTL	[Min to Max/Init./Step]
8-581-014	T:Counter	Full Color Print	CTL*	[0 to 99999999 / 0 / 1/step]
8-581-015	T:Counter	Mono Color Print	CTL*	[0 to 99999999 / 0 / 1/step]
8-581-016	T:Counter	Full Color GPC	CTL*	[0 to 99999999 / 0 / 1/step]
8-581-017	T:Counter	Twin Color Mode Print	CTL*	[0 to 99999999 / 0 / 1/step]
8-581-018	T:Counter	Full Color Print(Twin)	CTL*	[0 to 99999999 / 0 / 1/step]
8-581-019	T:Counter	Mono Color Print(Twin)	CTL*	[0 to 99999999 / 0 / 1/step]
8-581-020	T:Counter	Full Color Total(CV)	CTL*	[0 to 99999999 / 0 / 1/step]
8-581-021	T:Counter	Mono Color Total(CV)	CTL*	[0 to 99999999 / 0 / 1/step]
8-581-022	T:Counter	Full Color Print(CV)	CTL*	[0 to 99999999 / 0 / 1/step]
8-581-028	T:Counter	Development: CMY(A3)	CTL*	[0 to 99999999 / 0 / 1/step]
8-581-029	T:Counter	Development: K(A3)	CTL*	[0 to 99999999 / 0 / 1/step]
8-581-030	T:Counter	Total: Color(A3)	CTL*	[0 to 99999999 / 0 / 1/step]
8-581-031	T:Counter	Total: B/W(A3)	CTL*	[0 to 99999999 / 0 / 1/step]
8-582-001	C:Counter	B/W	CTL*	[0 to 99999999 / 0 / 1/step]
8-582-002	C:Counter	Single Color	CTL*	[0 to 99999999 / 0 / 1/step]
8-582-003	C:Counter	Two Color	CTL*	[0 to 99999999 / 0 / 1/step]
8-582-004	C:Counter	Full Color	CTL*	[0 to 99999999 / 0 / 1/step]
8-582-011	C:Counter	B/W:Simplex:Over A3/DLT	CTL*	[0 to 99999999 / 0 / 1/step]

3.SP Mode Tables

SP No.	Large Category	Small Category	ENG or CTL	[Min to Max/Init./Step]
8-582-012	C:Counter	BW:Simplex:Under A3/DLT	CTL*	[0 to 99999999 / 0 / 1/step]
8-582-013	C:Counter	BW:Duplex:Over A3/DLT	CTL*	[0 to 99999999 / 0 / 1/step]
8-582-014	C:Counter	BW:Duplex:Under A3/DLT	CTL*	[0 to 99999999 / 0 / 1/step]
8-582-015	C:Counter	Single Color:Simplex:Over A3/DLT	CTL*	[0 to 99999999 / 0 / 1/step]
8-582-016	C:Counter	Single Color:Simplex:Under A3/DLT	CTL*	[0 to 99999999 / 0 / 1/step]
8-582-017	C:Counter	Single Color:Duplex:Over A3/DLT	CTL*	[0 to 99999999 / 0 / 1/step]
8-582-018	C:Counter	Single Color:Duplex:Under A3/DLT	CTL*	[0 to 99999999 / 0 / 1/step]
8-582-019	C:Counter	Two Color:Simplex:Over A3/DLT	CTL*	[0 to 99999999 / 0 / 1/step]
8-582-020	C:Counter	Two Color:Simplex:Under A3/DLT	CTL*	[0 to 99999999 / 0 / 1/step]
8-582-021	C:Counter	Two Color:Duplex:Over A3/DLT	CTL*	[0 to 99999999 / 0 / 1/step]
8-582-022	C:Counter	Two Color:Duplex:Under A3/DLT	CTL*	[0 to 99999999 / 0 / 1/step]
8-582-023	C:Counter	Full Color:Simplex:Over A3/DLT	CTL*	[0 to 99999999 / 0 / 1/step]
8-582-024	C:Counter	Full Color:Simplex:Under A3/DLT	CTL*	[0 to 99999999 / 0 / 1/step]
8-582-025	C:Counter	Full Color:Duplex:Over A3/DLT	CTL*	[0 to 99999999 / 0 / 1/step]
8-582-026	C:Counter	Full Color:Duplex:Under A3/DLT	CTL*	[0 to 99999999 / 0 / 1/step]
8-583-001	F:Counter	BW	CTL*	[0 to 99999999 / 0 / 1/step]
8-583-002	F:Counter	Single Color	CTL*	[0 to 99999999 / 0 / 1/step]
8-583-011	F:Counter	BW:Simplex:Over A3/DLT	CTL*	[0 to 99999999 / 0 / 1/step]

3.SP Mode Tables

SP No.	Large Category	Small Category	ENG or CTL	[Min to Max/Init./Step]
8-583-012	F:Counter	BW:Simplex:Under A3/DLT	CTL*	[0 to 99999999 / 0 / 1/step]
8-583-013	F:Counter	BW:Duplex:Over A3/DLT	CTL*	[0 to 99999999 / 0 / 1/step]
8-583-014	F:Counter	BW:Duplex:Under A3/DLT	CTL*	[0 to 99999999 / 0 / 1/step]
8-583-015	F:Counter	Single Color:Simplex:Over A3/DLT	CTL*	[0 to 99999999 / 0 / 1/step]
8-583-016	F:Counter	Single Color:Simplex:Under A3/DLT	CTL*	[0 to 99999999 / 0 / 1/step]
8-583-017	F:Counter	Single Color:Duplex:Over A3/DLT	CTL*	[0 to 99999999 / 0 / 1/step]
8-583-018	F:Counter	Single Color:Duplex:Under A3/DLT	CTL*	[0 to 99999999 / 0 / 1/step]
8-584-001	P:Counter	BW	CTL*	[0 to 99999999 / 0 / 1/step]
8-584-002	P:Counter	Mono Color	CTL*	[0 to 99999999 / 0 / 1/step]
8-584-003	P:Counter	Full Color	CTL*	[0 to 99999999 / 0 / 1/step]
8-584-004	P:Counter	Single Color	CTL*	[0 to 99999999 / 0 / 1/step]
8-584-005	P:Counter	Two Color	CTL*	[0 to 99999999 / 0 / 1/step]
8-584-011	P:Counter	BW:Simplex:Over A3/DLT	CTL*	[0 to 99999999 / 0 / 1/step]
8-584-012	P:Counter	BW:Simplex:Under A3/DLT	CTL*	[0 to 99999999 / 0 / 1/step]
8-584-013	P:Counter	BW:Duplex:Over A3/DLT	CTL*	[0 to 99999999 / 0 / 1/step]
8-584-014	P:Counter	BW:Duplex:Under A3/DLT	CTL*	[0 to 99999999 / 0 / 1/step]
8-584-015	P:Counter	Single Color:Simplex:Over A3/DLT	CTL*	[0 to 99999999 / 0 / 1/step]
8-584-016	P:Counter	Single Color:Simplex:Under A3/DLT	CTL*	[0 to 99999999 / 0 / 1/step]

3.SP Mode Tables

SP No.	Large Category	Small Category	ENG or CTL	[Min to Max/Init./Step]
8-584-017	P:Counter	Single Color:Duplex:Over A3/DLT	CTL*	[0 to 99999999 / 0 / 1/step]
8-584-018	P:Counter	Single Color:Duplex:Under A3/DLT	CTL*	[0 to 99999999 / 0 / 1/step]
8-584-019	P:Counter	Two Color:Simplex:Over A3/DLT	CTL*	[0 to 99999999 / 0 / 1/step]
8-584-020	P:Counter	Two Color:Simplex:Under A3/DLT	CTL*	[0 to 99999999 / 0 / 1/step]
8-584-021	P:Counter	Two Color:Duplex:Over A3/DLT	CTL*	[0 to 99999999 / 0 / 1/step]
8-584-022	P:Counter	Two Color:Duplex:Under A3/DLT	CTL*	[0 to 99999999 / 0 / 1/step]
8-584-023	P:Counter	Full Color:Simplex:Over A3/DLT	CTL*	[0 to 99999999 / 0 / 1/step]
8-584-024	P:Counter	Full Color:Simplex:Under A3/DLT	CTL*	[0 to 99999999 / 0 / 1/step]
8-584-025	P:Counter	Full Color:Duplex:Over A3/DLT	CTL*	[0 to 99999999 / 0 / 1/step]
8-584-026	P:Counter	Full Color:Duplex:Under A3/DLT	CTL*	[0 to 99999999 / 0 / 1/step]
8-585-001	S:Counter	Over A3/DLT	CTL*	[0 to 99999999 / 0 / 1/step]
8-585-002	S:Counter	Under A3/DLT	CTL*	[0 to 99999999 / 0 / 1/step]
8-586-001	L:Counter	B/W	CTL*	[0 to 99999999 / 0 / 1/step]
8-586-002	L:Counter	Single Color	CTL*	[0 to 99999999 / 0 / 1/step]
8-586-003	L:Counter	Two Color	CTL*	[0 to 99999999 / 0 / 1/step]
8-586-004	L:Counter	Full Color	CTL*	[0 to 99999999 / 0 / 1/step]
8-586-011	L:Counter	B/W:Simplex:Over A3/DLT	CTL*	[0 to 99999999 / 0 / 1/step]
8-586-012	L:Counter	B/W:Simplex:Under A3/DLT	CTL*	[0 to 99999999 / 0 / 1/step]

3.SP Mode Tables

SP No.	Large Category	Small Category	ENG or CTL	[Min to Max/Init./Step]
8-586-013	L:Counter	BW:Duplex:Over A3/DLT	CTL*	[0 to 99999999 / 0 / 1/step]
8-586-014	L:Counter	BW:Duplex:Under A3/DLT	CTL*	[0 to 99999999 / 0 / 1/step]
8-586-015	L:Counter	Single Color:Simplex:Over A3/DLT	CTL*	[0 to 99999999 / 0 / 1/step]
8-586-016	L:Counter	Single Color:Simplex:Under A3/DLT	CTL*	[0 to 99999999 / 0 / 1/step]
8-586-017	L:Counter	Single Color:Duplex:Over A3/DLT	CTL*	[0 to 99999999 / 0 / 1/step]
8-586-018	L:Counter	Single Color:Duplex:Under A3/DLT	CTL*	[0 to 99999999 / 0 / 1/step]
8-586-019	L:Counter	Two Color:Simplex:Over A3/DLT	CTL*	[0 to 99999999 / 0 / 1/step]
8-586-020	L:Counter	Two Color:Simplex:Under A3/DLT	CTL*	[0 to 99999999 / 0 / 1/step]
8-586-021	L:Counter	Two Color:Duplex:Over A3/DLT	CTL*	[0 to 99999999 / 0 / 1/step]
8-586-022	L:Counter	Two Color:Duplex:Under A3/DLT	CTL*	[0 to 99999999 / 0 / 1/step]
8-586-023	L:Counter	Full Color:Simplex:Over A3/DLT	CTL*	[0 to 99999999 / 0 / 1/step]
8-586-024	L:Counter	Full Color:Simplex:Under A3/DLT	CTL*	[0 to 99999999 / 0 / 1/step]
8-586-025	L:Counter	Full Color:Duplex:Over A3/DLT	CTL*	[0 to 99999999 / 0 / 1/step]
8-586-026	L:Counter	Full Color:Duplex:Under A3/DLT	CTL*	[0 to 99999999 / 0 / 1/step]
8-587-011	O:Counter	BW:Simplex:Over A3/DLT	CTL*	[0 to 99999999 / 0 / 1/step]
8-587-012	O:Counter	BW:Simplex:Under A3/DLT	CTL*	[0 to 99999999 / 0 / 1/step]
8-587-013	O:Counter	BW:Duplex:Over A3/DLT	CTL*	[0 to 99999999 / 0 / 1/step]
8-587-014	O:Counter	BW:Duplex:Under A3/DLT	CTL*	[0 to 99999999 / 0 / 1/step]

3.SP Mode Tables

SP No.	Large Category	Small Category	ENG or CTL	[Min to Max/Init./Step]
8-587-015	O:Counter	Single Color:Simplex:Over A3/DLT	CTL*	[0 to 99999999 / 0 / 1/step]
8-587-016	O:Counter	Single Color:Simplex:Under A3/DLT	CTL*	[0 to 99999999 / 0 / 1/step]
8-587-017	O:Counter	Single Color:Duplex:Over A3/DLT	CTL*	[0 to 99999999 / 0 / 1/step]
8-587-018	O:Counter	Single Color:Duplex:Under A3/DLT	CTL*	[0 to 99999999 / 0 / 1/step]
8-587-019	O:Counter	Two Color:Simplex:Over A3/DLT	CTL*	[0 to 99999999 / 0 / 1/step]
8-587-020	O:Counter	Two Color:Simplex:Under A3/DLT	CTL*	[0 to 99999999 / 0 / 1/step]
8-587-021	O:Counter	Two Color:Duplex:Over A3/DLT	CTL*	[0 to 99999999 / 0 / 1/step]
8-587-022	O:Counter	Two Color:Duplex:Under A3/DLT	CTL*	[0 to 99999999 / 0 / 1/step]
8-587-023	O:Counter	Full Color:Simplex:Over A3/DLT	CTL*	[0 to 99999999 / 0 / 1/step]
8-587-024	O:Counter	Full Color:Simplex:Under A3/DLT	CTL*	[0 to 99999999 / 0 / 1/step]
8-587-025	O:Counter	Full Color:Duplex:Over A3/DLT	CTL*	[0 to 99999999 / 0 / 1/step]
8-587-026	O:Counter	Full Color:Duplex:Under A3/DLT	CTL*	[0 to 99999999 / 0 / 1/step]
8-591-001	O:Counter	A3/DLT	CTL*	[0 to 99999999 / 0 / 1/step]
8-591-002	O:Counter	Duplex	CTL*	[0 to 99999999 / 0 / 1/step]
8-591-005	O:Counter	Banner	CTL*	[0 to 99999999 / 0 / 1/step]
8-601-001	T:Coverage Counter	BW	CTL*	[0 to 2147483647 / 0 / 1%/step]
8-601-002	T:Coverage Counter	Color	CTL*	[0 to 2147483647 / 0 / 1%/step]
8-601-011	T:Coverage Counter	BW Printing Pages	CTL*	[0 to 99999999 / 0 / 1/step]

3.SP Mode Tables

SP No.	Large Category	Small Category	ENG or CTL	[Min to Max/Init./Step]
8-601-012	T:Coverage Counter	Color Printing Pages	CTL*	[0 to 99999999 / 0 / 1/step]
8-601-021	T:Coverage Counter	Coverage Counter 1	CTL*	[0 to 99999999 / 0 / 1/step]
8-601-022	T:Coverage Counter	Coverage Counter 2	CTL*	[0 to 99999999 / 0 / 1/step]
8-601-023	T:Coverage Counter	Coverage Counter 3	CTL*	[0 to 99999999 / 0 / 1/step]
8-601-031	Coverage Counter	Coverage Counter 1 (YMC)	CTL*	[0 to 99999999 / 0 / 1/step]
8-601-032	Coverage Counter	Coverage Counter 2 (YMC)	CTL*	[0 to 99999999 / 0 / 1/step]
8-601-033	Coverage Counter	Coverage Counter 3 (YMC)	CTL*	[0 to 99999999 / 0 / 1/step]
8-602-001	C:Coverage Counter	B/W	CTL*	[0 to 2147483647 / 0 / 1%/step]
8-602-002	C:Coverage Counter	Single Color	CTL*	[0 to 2147483647 / 0 / 1%/step]
8-602-003	C:Coverage Counter	Two Color	CTL*	[0 to 2147483647 / 0 / 1%/step]
8-602-004	C:Coverage Counter	Full Color	CTL*	[0 to 2147483647 / 0 / 1%/step]
8-603-001	F:Coverage Counter	B/W	CTL*	[0 to 2147483647 / 0 / 1%/step]
8-603-002	F:Coverage Counter	Single Color	CTL*	[0 to 2147483647 / 0 / 1%/step]
8-604-001	P:Coverage Counter	B/W	CTL*	[0 to 2147483647 / 0 / 1%/step]
8-604-002	P:Coverage Counter	Single Color	CTL*	[0 to 2147483647 / 0 / 1%/step]
8-604-003	P:Coverage Counter	Two Color	CTL*	[0 to 2147483647 / 0 / 1%/step]
8-604-004	P:Coverage Counter	Full Color	CTL*	[0 to 2147483647 / 0 / 1%/step]
8-606-001	L:Coverage Counter	B/W	CTL*	[0 to 2147483647 / 0 / 1%/step]

3.SP Mode Tables

SP No.	Large Category	Small Category	ENG or CTL	[Min to Max/Init./Step]
8-606-002	L:Coverage Counter	Single Color	CTL*	[0 to 2147483647 / 0 / 1%/step]
8-606-003	L:Coverage Counter	Two Color	CTL*	[0 to 2147483647 / 0 / 1%/step]
8-606-004	L:Coverage Counter	Full Color	CTL*	[0 to 2147483647 / 0 / 1%/step]
8-617-001	SDK Apli Counter	SDK-1	CTL*	[0 to 99999999 / 0 / 1/step]
8-617-002	SDK Apli Counter	SDK-2	CTL*	[0 to 99999999 / 0 / 1/step]
8-617-003	SDK Apli Counter	SDK-3	CTL*	[0 to 99999999 / 0 / 1/step]
8-617-004	SDK Apli Counter	SDK-4	CTL*	[0 to 99999999 / 0 / 1/step]
8-617-005	SDK Apli Counter	SDK-5	CTL*	[0 to 99999999 / 0 / 1/step]
8-617-006	SDK Apli Counter	SDK-6	CTL*	[0 to 99999999 / 0 / 1/step]
8-617-007	SDK Apli Counter	SDK-7	CTL*	[0 to 99999999 / 0 / 1/step]
8-617-008	SDK Apli Counter	SDK-8	CTL*	[0 to 99999999 / 0 / 1/step]
8-617-009	SDK Apli Counter	SDK-9	CTL*	[0 to 99999999 / 0 / 1/step]
8-617-010	SDK Apli Counter	SDK-10	CTL*	[0 to 99999999 / 0 / 1/step]
8-617-011	SDK Apli Counter	SDK-11	CTL*	[0 to 99999999 / 0 / 1/step]
8-617-012	SDK Apli Counter	SDK-12	CTL*	[0 to 99999999 / 0 / 1/step]
8-621-001	Func Use Counter	Function-001	CTL*	[0 to 99999999 / 0 / 1/step]
8-621-002	Func Use Counter	Function-002	CTL*	[0 to 99999999 / 0 / 1/step]
8-621-003	Func Use Counter	Function-003	CTL*	[0 to 99999999 / 0 / 1/step]

3.SP Mode Tables

SP No.	Large Category	Small Category	ENG or CTL	[Min to Max/Init./Step]
8-621-004	Func Use Counter	Function-004	CTL*	[0 to 99999999 / 0 / 1/step]
8-621-005	Func Use Counter	Function-005	CTL*	[0 to 99999999 / 0 / 1/step]
8-621-006	Func Use Counter	Function-006	CTL*	[0 to 99999999 / 0 / 1/step]
8-621-007	Func Use Counter	Function-007	CTL*	[0 to 99999999 / 0 / 1/step]
8-621-008	Func Use Counter	Function-008	CTL*	[0 to 99999999 / 0 / 1/step]
8-621-009	Func Use Counter	Function-009	CTL*	[0 to 99999999 / 0 / 1/step]
8-621-010	Func Use Counter	Function-010	CTL*	[0 to 99999999 / 0 / 1/step]
8-621-011	Func Use Counter	Function-011	CTL*	[0 to 99999999 / 0 / 1/step]
8-621-012	Func Use Counter	Function-012	CTL*	[0 to 99999999 / 0 / 1/step]
8-621-013	Func Use Counter	Function-013	CTL*	[0 to 99999999 / 0 / 1/step]
8-621-014	Func Use Counter	Function-014	CTL*	[0 to 99999999 / 0 / 1/step]
8-621-015	Func Use Counter	Function-015	CTL*	[0 to 99999999 / 0 / 1/step]
8-621-016	Func Use Counter	Function-016	CTL*	[0 to 99999999 / 0 / 1/step]
8-621-017	Func Use Counter	Function-017	CTL*	[0 to 99999999 / 0 / 1/step]
8-621-018	Func Use Counter	Function-018	CTL*	[0 to 99999999 / 0 / 1/step]
8-621-019	Func Use Counter	Function-019	CTL*	[0 to 99999999 / 0 / 1/step]
8-621-020	Func Use Counter	Function-020	CTL*	[0 to 99999999 / 0 / 1/step]
8-621-021	Func Use Counter	Function-021	CTL*	[0 to 99999999 / 0 / 1/step]

3.SP Mode Tables

SP No.	Large Category	Small Category	ENG or CTL	[Min to Max/Init./Step]
8-621-022	Func Use Counter	Function-022	CTL*	[0 to 99999999 / 0 / 1/step]
8-621-023	Func Use Counter	Function-023	CTL*	[0 to 99999999 / 0 / 1/step]
8-621-024	Func Use Counter	Function-024	CTL*	[0 to 99999999 / 0 / 1/step]
8-621-025	Func Use Counter	Function-025	CTL*	[0 to 99999999 / 0 / 1/step]
8-621-026	Func Use Counter	Function-026	CTL*	[0 to 99999999 / 0 / 1/step]
8-621-027	Func Use Counter	Function-027	CTL*	[0 to 99999999 / 0 / 1/step]
8-621-028	Func Use Counter	Function-028	CTL*	[0 to 99999999 / 0 / 1/step]
8-621-029	Func Use Counter	Function-029	CTL*	[0 to 99999999 / 0 / 1/step]
8-621-030	Func Use Counter	Function-030	CTL*	[0 to 99999999 / 0 / 1/step]
8-621-031	Func Use Counter	Function-031	CTL*	[0 to 99999999 / 0 / 1/step]
8-621-032	Func Use Counter	Function-032	CTL*	[0 to 99999999 / 0 / 1/step]
8-621-033	Func Use Counter	Function-033	CTL*	[0 to 99999999 / 0 / 1/step]
8-621-034	Func Use Counter	Function-034	CTL*	[0 to 99999999 / 0 / 1/step]
8-621-035	Func Use Counter	Function-035	CTL*	[0 to 99999999 / 0 / 1/step]
8-621-036	Func Use Counter	Function-036	CTL*	[0 to 99999999 / 0 / 1/step]
8-621-037	Func Use Counter	Function-037	CTL*	[0 to 99999999 / 0 / 1/step]
8-621-038	Func Use Counter	Function-038	CTL*	[0 to 99999999 / 0 / 1/step]
8-621-039	Func Use Counter	Function-039	CTL*	[0 to 99999999 / 0 / 1/step]

3.SP Mode Tables

SP No.	Large Category	Small Category	ENG or CTL	[Min to Max/Init./Step]
8-621-040	Func Use Counter	Function-040	CTL*	[0 to 99999999 / 0 / 1/step]
8-621-041	Func Use Counter	Function-041	CTL*	[0 to 99999999 / 0 / 1/step]
8-621-042	Func Use Counter	Function-042	CTL*	[0 to 99999999 / 0 / 1/step]
8-621-043	Func Use Counter	Function-043	CTL*	[0 to 99999999 / 0 / 1/step]
8-621-044	Func Use Counter	Function-044	CTL*	[0 to 99999999 / 0 / 1/step]
8-621-045	Func Use Counter	Function-045	CTL*	[0 to 99999999 / 0 / 1/step]
8-621-046	Func Use Counter	Function-046	CTL*	[0 to 99999999 / 0 / 1/step]
8-621-047	Func Use Counter	Function-047	CTL*	[0 to 99999999 / 0 / 1/step]
8-621-048	Func Use Counter	Function-048	CTL*	[0 to 99999999 / 0 / 1/step]
8-621-049	Func Use Counter	Function-049	CTL*	[0 to 99999999 / 0 / 1/step]
8-621-050	Func Use Counter	Function-050	CTL*	[0 to 99999999 / 0 / 1/step]
8-621-051	Func Use Counter	Function-051	CTL*	[0 to 99999999 / 0 / 1/step]
8-621-052	Func Use Counter	Function-052	CTL*	[0 to 99999999 / 0 / 1/step]
8-621-053	Func Use Counter	Function-053	CTL*	[0 to 99999999 / 0 / 1/step]
8-621-054	Func Use Counter	Function-054	CTL*	[0 to 99999999 / 0 / 1/step]
8-621-055	Func Use Counter	Function-055	CTL*	[0 to 99999999 / 0 / 1/step]
8-621-056	Func Use Counter	Function-056	CTL*	[0 to 99999999 / 0 / 1/step]
8-621-057	Func Use Counter	Function-057	CTL*	[0 to 99999999 / 0 / 1/step]

3.SP Mode Tables

SP No.	Large Category	Small Category	ENG or CTL	[Min to Max/Init./Step]
8-621-058	Func Use Counter	Function-058	CTL*	[0 to 99999999 / 0 / 1/step]
8-621-059	Func Use Counter	Function-059	CTL*	[0 to 99999999 / 0 / 1/step]
8-621-060	Func Use Counter	Function-060	CTL*	[0 to 99999999 / 0 / 1/step]
8-621-061	Func Use Counter	Function-061	CTL*	[0 to 99999999 / 0 / 1/step]
8-621-062	Func Use Counter	Function-062	CTL*	[0 to 99999999 / 0 / 1/step]
8-621-063	Func Use Counter	Function-063	CTL*	[0 to 99999999 / 0 / 1/step]
8-621-064	Func Use Counter	Function-064	CTL*	[0 to 99999999 / 0 / 1/step]
8-631-001	T:FAX TX PGS	B/W(Tel)	CTL*	[0 to 99999999 / 0 / 1/step]
8-631-002	T:FAX TX PGS	Color(Tel)	CTL*	[0 to 99999999 / 0 / 1/step]
8-631-101	T:FAX TX PGS	B/W(Cloud)	CTL*	[0 to 99999999 / 0 / 1/step]
8-631-102	T:FAX TX PGS	Color(Cloud)	CTL*	[0 to 99999999 / 0 / 1/step]
8-633-001	F:FAX TX PGS	B/W(Tel)	CTL*	[0 to 99999999 / 0 / 1/step]
8-633-002	F:FAX TX PGS	Color(Tel)	CTL*	[0 to 99999999 / 0 / 1/step]
8-633-101	F:FAX TX PGS	B/W(Cloud)	CTL*	[0 to 99999999 / 0 / 1/step]
8-633-102	F:FAX TX PGS	Color(Cloud)	CTL*	[0 to 99999999 / 0 / 1/step]
8-641-001	T:IFAX TX PGS	B/W	CTL*	[0 to 99999999 / 0 / 1/step]
8-641-002	T:IFAX TX PGS	Color	CTL*	[0 to 99999999 / 0 / 1/step]
8-643-001	F:IFAX TX PGS	B/W	CTL*	[0 to 99999999 / 0 / 1/step]

3.SP Mode Tables

SP No.	Large Category	Small Category	ENG or CTL	[Min to Max/Init./Step]
8-643-002	F:IFAX TX PGS	Color	CTL*	[0 to 99999999 / 0 / 1/step]
8-651-001	T:S-to-Email PGS	B/W	CTL*	[0 to 99999999 / 0 / 1/step]
8-651-002	T:S-to-Email PGS	Color	CTL*	[0 to 99999999 / 0 / 1/step]
8-655-001	S:S-to-Email PGS	B/W	CTL*	[0 to 99999999 / 0 / 1/step]
8-655-002	S:S-to-Email PGS	Color	CTL*	[0 to 99999999 / 0 / 1/step]
8-661-001	T:Deliv PGS/Svr	B/W	CTL*	[0 to 99999999 / 0 / 1/step]
8-661-002	T:Deliv PGS/Svr	Color	CTL*	[0 to 99999999 / 0 / 1/step]
8-665-001	S:Deliv PGS/Svr	B/W	CTL*	[0 to 99999999 / 0 / 1/step]
8-665-002	S:Deliv PGS/Svr	Color	CTL*	[0 to 99999999 / 0 / 1/step]
8-671-001	T:Deliv PGS/PC	B/W	CTL*	[0 to 99999999 / 0 / 1/step]
8-671-002	T:Deliv PGS/PC	Color	CTL*	[0 to 99999999 / 0 / 1/step]
8-675-001	S:Deliv PGS/PC	B/W	CTL*	[0 to 99999999 / 0 / 1/step]
8-675-002	S:Deliv PGS/PC	Color	CTL*	[0 to 99999999 / 0 / 1/step]
8-681-001	T:PCFAX TXPGS		CTL*	[0 to 99999999 / 0 / 1/step]
8-683-001	F:PCFAX TXPGS		CTL*	[0 to 99999999 / 0 / 1/step]
8-691-001	T:TX PGS/LS		CTL*	[0 to 99999999 / 0 / 1/step]
8-692-001	C:TX PGS/LS		CTL*	[0 to 99999999 / 0 / 1/step]
8-693-001	F:TX PGS/LS		CTL*	[0 to 99999999 / 0 / 1/step]

3.SP Mode Tables

SP No.	Large Category	Small Category	ENG or CTL	[Min to Max/Init./Step]
8-694-001	P:TX PGS/LS		CTL*	[0 to 99999999 / 0 / 1/step]
8-695-001	S:TX PGS/LS		CTL*	[0 to 99999999 / 0 / 1/step]
8-696-001	L:TX PGS/LS		CTL*	[0 to 99999999 / 0 / 1/step]
8-701-001	TX PGS/Port	PSTN-1	CTL*	[0 to 99999999 / 0 / 1/step]
8-701-002	TX PGS/Port	PSTN-2	CTL*	[0 to 99999999 / 0 / 1/step]
8-701-003	TX PGS/Port	PSTN-3	CTL*	[0 to 99999999 / 0 / 1/step]
8-701-004	TX PGS/Port	ISDN(G3,G4)	CTL*	[0 to 99999999 / 0 / 1/step]
8-701-005	TX PGS/Port	Network	CTL*	[0 to 99999999 / 0 / 1/step]
8-711-001	T:Scan PGS/Comp	JPEG/JPEG2000	CTL*	[0 to 99999999 / 0 / 1/step]
8-711-002	T:Scan PGS/Comp	TIFF(Multi/Single)	CTL*	[0 to 99999999 / 0 / 1/step]
8-711-003	T:Scan PGS/Comp	PDF	CTL*	[0 to 99999999 / 0 / 1/step]
8-711-004	T:Scan PGS/Comp	Other	CTL*	[0 to 99999999 / 0 / 1/step]
8-711-005	T:Scan PGS/Comp	PDF/Comp	CTL*	[0 to 99999999 / 0 / 1/step]
8-711-006	T:Scan PGS/Comp	PDF/A	CTL*	[0 to 99999999 / 0 / 1/step]
8-711-007	T:Scan PGS/Comp	PDF(OCR)	CTL*	[0 to 99999999 / 0 / 1/step]
8-711-008	T:Scan PGS/Comp	PDF/Comp(OCR)	CTL*	[0 to 99999999 / 0 / 1/step]
8-711-009	T:Scan PGS/Comp	PDF/A(OCR)	CTL*	[0 to 99999999 / 0 / 1/step]
8-715-001	S:Scan PGS/Comp	JPEG/JPEG2000	CTL*	[0 to 99999999 / 0 / 1/step]

3.SP Mode Tables

SP No.	Large Category	Small Category	ENG or CTL	[Min to Max/Init./Step]
8-715-002	S:Scan PGS/Comp	TIFF(Multi/Single)	CTL*	[0 to 99999999 / 0 / 1/step]
8-715-003	S:Scan PGS/Comp	PDF	CTL*	[0 to 99999999 / 0 / 1/step]
8-715-004	S:Scan PGS/Comp	Other	CTL*	[0 to 99999999 / 0 / 1/step]
8-715-005	S:Scan PGS/Comp	PDF/Comp	CTL*	[0 to 99999999 / 0 / 1/step]
8-715-006	S:Scan PGS/Comp	PDF/A	CTL*	[0 to 99999999 / 0 / 1/step]
8-715-007	S:Scan PGS/Comp	PDF(OCR)	CTL*	[0 to 99999999 / 0 / 1/step]
8-715-008	S:Scan PGS/Comp	PDF/Comp(OCR)	CTL*	[0 to 99999999 / 0 / 1/step]
8-715-009	S:Scan PGS/Comp	PDF/A(OCR)	CTL*	[0 to 99999999 / 0 / 1/step]
8-721-001	T:Deliv PGS/WSD/DSM	B/W	CTL	[0 to 99999999 / 0 / 1/step]
8-721-002	T:Deliv PGS/WSD/DSM	Color	CTL	[0 to 99999999 / 0 / 1/step]
8-725-001	S:Deliv PGS/WSD/DSM	B/W	CTL*	[0 to 99999999 / 0 / 1/step]
8-725-002	S:Deliv PGS/WSD/DSM	Color	CTL*	[0 to 99999999 / 0 / 1/step]
8-731-001	T:Scan PGS/Media	B/W	CTL*	[0 to 99999999 / 0 / 1/step]
8-731-002	T:Scan PGS/Media	Color	CTL*	[0 to 99999999 / 0 / 1/step]
8-735-001	S:Scan PGS/Media	B/W	CTL*	[0 to 99999999 / 0 / 1/step]
8-735-002	S:Scan PGS/Media	Color	CTL*	[0 to 99999999 / 0 / 1/step]
8-741-001	RX PGS/Port	PSTN-1	CTL*	[0 to 99999999 / 0 / 1/step]
8-741-002	RX PGS/Port	PSTN-2	CTL*	[0 to 99999999 / 0 / 1/step]

3.SP Mode Tables

SP No.	Large Category	Small Category	ENG or CTL	[Min to Max/Init./Step]
8-741-003	RX PGS/Port	PSTN-3	CTL*	[0 to 99999999 / 0 / 1/step]
8-741-004	RX PGS/Port	ISDN(G3,G4)	CTL*	[0 to 99999999 / 0 / 1/step]
8-741-005	RX PGS/Port	Network	CTL*	[0 to 99999999 / 0 / 1/step]
8-771-001	Dev Counter	Total	CTL*	[0 to 99999999 / 0 / 1/step]
8-771-002	Dev Counter	K	CTL*	[0 to 99999999 / 0 / 1/step]
8-771-003	Dev Counter	Y	CTL*	[0 to 99999999 / 0 / 1/step]
8-771-004	Dev Counter	M	CTL*	[0 to 99999999 / 0 / 1/step]
8-771-005	Dev Counter	C	CTL*	[0 to 99999999 / 0 / 1/step]
8-781-001	Toner_Botol_Info.	BK	CTL*	[0 to 99999999 / 0 / 1/step]
8-781-002	Toner_Botol_Info.	Y	CTL*	[0 to 99999999 / 0 / 1/step]
8-781-003	Toner_Botol_Info.	M	CTL*	[0 to 99999999 / 0 / 1/step]
8-781-004	Toner_Botol_Info.	C	CTL*	[0 to 99999999 / 0 / 1/step]
8-791-001	LS Memory Remain		CTL*	[0 to 100 / 0 / 1%/step]
8-801-001	Toner Remain	K	CTL*	[0 to 100 / 0 / 1%/step]
8-801-002	Toner Remain	Y	CTL*	[0 to 100 / 0 / 1%/step]
8-801-003	Toner Remain	M	CTL*	[0 to 100 / 0 / 1%/step]
8-801-004	Toner Remain	C	CTL*	[0 to 100 / 0 / 1%/step]
8-811-001	Eco Counter	Eco Total	CTL*	[0 to 99999999 / 0 / 1/step]

3.SP Mode Tables

SP No.	Large Category	Small Category	ENG or CTL	[Min to Max/Init./Step]
8-811-002	Eco Counter	Color	CTL*	[0 to 99999999 / 0 / 1/step]
8-811-003	Eco Counter	Full Color	CTL*	[0 to 99999999 / 0 / 1/step]
8-811-004	Eco Counter	Duplex	CTL*	[0 to 99999999 / 0 / 1/step]
8-811-005	Eco Counter	Combine	CTL*	[0 to 99999999 / 0 / 1/step]
8-811-006	Eco Counter	Color(%)	CTL*	[0 to 100 / 0 / 1%/step]
8-811-007	Eco Counter	Full Color(%)	CTL*	[0 to 100 / 0 / 1%/step]
8-811-008	Eco Counter	Duplex(%)	CTL*	[0 to 100 / 0 / 1%/step]
8-811-009	Eco Counter	Combine(%)	CTL*	[0 to 100 / 0 / 1%/step]
8-811-010	Eco Counter	Paper Cut(%)	CTL*	[0 to 100 / 0 / 1%/step]
8-811-051	Eco Counter	Sync Eco Total	CTL*	[0 to 99999999 / 0 / 1/step]
8-811-052	Eco Counter	Sync Color	CTL*	[0 to 99999999 / 0 / 1/step]
8-811-053	Eco Counter	Sync Full Color	CTL*	[0 to 99999999 / 0 / 1/step]
8-811-054	Eco Counter	Sync Duplex	CTL*	[0 to 99999999 / 0 / 1/step]
8-811-055	Eco Counter	Sync Combine	CTL*	[0 to 99999999 / 0 / 1/step]
8-811-056	Eco Counter	Sync Color(%)	CTL*	[0 to 100 / 0 / 1%/step]
8-811-057	Eco Counter	Sync Full Color(%)	CTL*	[0 to 100 / 0 / 1%/step]
8-811-058	Eco Counter	Sync Duplex(%)	CTL*	[0 to 100 / 0 / 1%/step]
8-811-059	Eco Counter	Sync Combine(%)	CTL*	[0 to 100 / 0 / 1%/step]

3.SP Mode Tables

SP No.	Large Category	Small Category	ENG or CTL	[Min to Max/Init./Step]
8-811-060	Eco Counter	Sync Paper Cut(%)	CTL*	[0 to 100 / 0 / 1%/step]
8-811-101	Eco Counter	Eco Totalr>Last	CTL*	[0 to 99999999 / 0 / 1/step]
8-811-102	Eco Counter	Color>Last	CTL*	[0 to 99999999 / 0 / 1/step]
8-811-103	Eco Counter	Full Color>Last	CTL*	[0 to 99999999 / 0 / 1/step]
8-811-104	Eco Counter	Duplex>Last	CTL*	[0 to 99999999 / 0 / 1/step]
8-811-105	Eco Counter	Combine>Last	CTL*	[0 to 99999999 / 0 / 1/step]
8-811-106	Eco Counter	Color(%):Last	CTL*	[0 to 100 / 0 / 1%/step]
8-811-107	Eco Counter	Full Color(%):Last	CTL*	[0 to 100 / 0 / 1%/step]
8-811-108	Eco Counter	Duplex(%):Last	CTL*	[0 to 100 / 0 / 1%/step]
8-811-109	Eco Counter	Combine(%):Last	CTL*	[0 to 100 / 0 / 1%/step]
8-811-110	Eco Counter	Paper Cut(%):Last	CTL*	[0 to 100 / 0 / 1%/step]
8-811-151	Eco Counter	Sync Eco Totalr>Last	CTL*	[0 to 99999999 / 0 / 1/step]
8-811-152	Eco Counter	Sync Color>Last	CTL*	[0 to 99999999 / 0 / 1/step]
8-811-153	Eco Counter	Sync Full Color>Last	CTL*	[0 to 99999999 / 0 / 1/step]
8-811-154	Eco Counter	Sync Duplex>Last	CTL*	[0 to 99999999 / 0 / 1/step]
8-811-155	Eco Counter	Sync Combine>Last	CTL*	[0 to 99999999 / 0 / 1/step]
8-811-156	Eco Counter	Sync Color(%):Last	CTL*	[0 to 100 / 0 / 1%/step]
8-811-157	Eco Counter	Sync Full Color(%):Last	CTL*	[0 to 100 / 0 / 1%/step]

3.SP Mode Tables

SP No.	Large Category	Small Category	ENG or CTL	[Min to Max/Init./Step]
8-811-158	Eco Counter	Sync Duplex(%):Last	CTL*	[0 to 100 / 0 / 1%/step]
8-811-159	Eco Counter	Sync Combine(%):Last	CTL*	[0 to 100 / 0 / 1%/step]
8-811-160	Eco Counter	Sync Paper Cut(%):Last	CTL*	[0 to 100 / 0 / 1%/step]
8-851-011	Cvr Cnt:0-10%	0~2%:BK	CTL*	[0 to 99999999 / 0 / 1/step]
8-851-012	Cvr Cnt:0-10%	0~2%:Y	CTL*	[0 to 99999999 / 0 / 1/step]
8-851-013	Cvr Cnt:0-10%	0~2%:M	CTL*	[0 to 99999999 / 0 / 1/step]
8-851-014	Cvr Cnt:0-10%	0~2%:C	CTL*	[0 to 99999999 / 0 / 1/step]
8-851-021	Cvr Cnt:0-10%	3~4%:BK	CTL*	[0 to 99999999 / 0 / 1/step]
8-851-022	Cvr Cnt:0-10%	3~4%:Y	CTL*	[0 to 99999999 / 0 / 1/step]
8-851-023	Cvr Cnt:0-10%	3~4%:M	CTL*	[0 to 99999999 / 0 / 1/step]
8-851-024	Cvr Cnt:0-10%	3~4%:C	CTL*	[0 to 99999999 / 0 / 1/step]
8-851-031	Cvr Cnt:0-10%	5~7%:BK	CTL*	[0 to 99999999 / 0 / 1/step]
8-851-032	Cvr Cnt:0-10%	5~7%:Y	CTL*	[0 to 99999999 / 0 / 1/step]
8-851-033	Cvr Cnt:0-10%	5~7%:M	CTL*	[0 to 99999999 / 0 / 1/step]
8-851-034	Cvr Cnt:0-10%	5~7%:C	CTL*	[0 to 99999999 / 0 / 1/step]
8-851-041	Cvr Cnt:0-10%	8~10%:BK	CTL*	[0 to 99999999 / 0 / 1/step]
8-851-042	Cvr Cnt:0-10%	8~10%:Y	CTL*	[0 to 99999999 / 0 / 1/step]
8-851-043	Cvr Cnt:0-10%	8~10%:M	CTL*	[0 to 99999999 / 0 / 1/step]

3.SP Mode Tables

SP No.	Large Category	Small Category	ENG or CTL	[Min to Max/Init./Step]
8-851-044	Cvr Cnt:0-10%	8~10%:C	CTL*	[0 to 99999999 / 0 / 1/step]
8-861-001	Cvr Cnt:11-20%	BK	CTL*	[0 to 99999999 / 0 / 1/step]
8-861-002	Cvr Cnt:11-20%	Y	CTL*	[0 to 99999999 / 0 / 1/step]
8-861-003	Cvr Cnt:11-20%	M	CTL*	[0 to 99999999 / 0 / 1/step]
8-861-004	Cvr Cnt:11-20%	C	CTL*	[0 to 99999999 / 0 / 1/step]
8-871-001	Cvr Cnt:21-30%	BK	CTL*	[0 to 99999999 / 0 / 1/step]
8-871-002	Cvr Cnt:21-30%	Y	CTL*	[0 to 99999999 / 0 / 1/step]
8-871-003	Cvr Cnt:21-30%	M	CTL*	[0 to 99999999 / 0 / 1/step]
8-871-004	Cvr Cnt:21-30%	C	CTL*	[0 to 99999999 / 0 / 1/step]
8-881-001	Cvr Cnt:31%-	BK	CTL*	[0 to 99999999 / 0 / 1/step]
8-881-002	Cvr Cnt:31%-	Y	CTL*	[0 to 99999999 / 0 / 1/step]
8-881-003	Cvr Cnt:31%-	M	CTL*	[0 to 99999999 / 0 / 1/step]
8-881-004	Cvr Cnt:31%-	C	CTL*	[0 to 99999999 / 0 / 1/step]
8-891-001	Page/Toner Bottle	BK	CTL*	[0 to 99999999 / 0 / 1/step]
8-891-002	Page/Toner Bottle	Y	CTL*	[0 to 99999999 / 0 / 1/step]
8-891-003	Page/Toner Bottle	M	CTL*	[0 to 99999999 / 0 / 1/step]
8-891-004	Page/Toner Bottle	C	CTL*	[0 to 99999999 / 0 / 1/step]
8-901-001	Page/Toner_Prev1	BK	CTL*	[0 to 99999999 / 0 / 1/step]

3.SP Mode Tables

SP No.	Large Category	Small Category	ENG or CTL	[Min to Max/Init./Step]
8-901-002	Page/Toner_Prev1	Y	CTL*	[0 to 99999999 / 0 / 1/step]
8-901-003	Page/Toner_Prev1	M	CTL*	[0 to 99999999 / 0 / 1/step]
8-901-004	Page/Toner_Prev1	C	CTL*	[0 to 99999999 / 0 / 1/step]
8-911-001	Page/Toner_Prev2	BK	CTL	[0 to 99999999 / 0 / 1/step]
8-911-002	Page/Toner_Prev2	Y	CTL	[0 to 99999999 / 0 / 1/step]
8-911-003	Page/Toner_Prev2	M	CTL	[0 to 99999999 / 0 / 1/step]
8-911-004	Page/Toner_Prev2	C	CTL	[0 to 99999999 / 0 / 1/step]
8-921-001	Cvr Cnt/Total	Coverage(%):BK	CTL*	[0 to 2147483647 / 0 / 1%/step]
8-921-002	Cvr Cnt/Total	Coverage(%):Y	CTL*	[0 to 2147483647 / 0 / 1%/step]
8-921-003	Cvr Cnt/Total	Coverage(%):M	CTL*	[0 to 2147483647 / 0 / 1%/step]
8-921-004	Cvr Cnt/Total	Coverage(%):C	CTL*	[0 to 2147483647 / 0 / 1%/step]
8-921-011	Cvr Cnt/Total	Coverage/P:BK	CTL*	[0 to 99999999 / 0 / 1/step]
8-921-012	Cvr Cnt/Total	Coverage/P:Y	CTL*	[0 to 99999999 / 0 / 1/step]
8-921-013	Cvr Cnt/Total	Coverage/P:M	CTL*	[0 to 99999999 / 0 / 1/step]
8-921-014	Cvr Cnt/Total	Coverage/P:C	CTL*	[0 to 99999999 / 0 / 1/step]
8-941-001	Machine Status	Operation Time	CTL*	[0 to 99999999 / 0 / 1/step]
8-941-002	Machine Status	Standby Time	CTL*	[0 to 99999999 / 0 / 1/step]
8-941-003	Machine Status	Energy Save Time	CTL*	[0 to 99999999 / 0 / 1/step]

3.SP Mode Tables

SP No.	Large Category	Small Category	ENG or CTL	[Min to Max/Init./Step]
8-941-004	Machine Status	Low Power Time	CTL*	[0 to 99999999 / 0 / 1/step]
8-941-005	Machine Status	Off Mode Time	CTL*	[0 to 99999999 / 0 / 1/step]
8-941-006	Machine Status	SC	CTL*	[0 to 99999999 / 0 / 1/step]
8-941-007	Machine Status	PrtJam	CTL*	[0 to 99999999 / 0 / 1/step]
8-941-008	Machine Status	OrgJam	CTL*	[0 to 99999999 / 0 / 1/step]
8-941-009	Machine Status	Supply PM Unit End	CTL*	[0 to 99999999 / 0 / 1/step]
8-951-001	AddBook Register	User Code /User ID	CTL*	[0 to 99999 / 0 / 1/step]
8-951-002	AddBook Register	Mail Address	CTL*	[0 to 99999 / 0 / 1/step]
8-951-003	AddBook Register	Fax Destination	CTL*	[0 to 99999 / 0 / 1/step]
8-951-004	AddBook Register	Group	CTL*	[0 to 99999 / 0 / 1/step]
8-951-005	AddBook Register	Transfer Request	CTL*	[0 to 99999 / 0 / 1/step]
8-951-006	AddBook Register	F-Code	CTL*	[0 to 99999 / 0 / 1/step]
8-951-007	AddBook Register	Copy Program	CTL*	[0 to 255 / 0 / 1/step]
8-951-008	AddBook Register	Fax Program	CTL*	[0 to 255 / 0 / 1/step]
8-951-009	AddBook Register	Printer Program	CTL*	[0 to 255 / 0 / 1/step]
8-951-010	AddBook Register	Scanner Program	CTL*	[0 to 255 / 0 / 1/step]
8-961-001	Electricity Status	Ctrl Standby Time	CTL*	[0 to 99999999 / 0 / 1/step]
8-961-002	Electricity Status	STR Time	CTL*	[0 to 99999999 / 0 / 1/step]

3.SP Mode Tables

SP No.	Large Category	Small Category	ENG or CTL	[Min to Max/Init./Step]
8-961-003	Electricity Status	Main Power Off Time	CTL*	[0 to 99999999 / 0 / 1/step]
8-961-004	Electricity Status	Reading and Printing Time	CTL*	[0 to 99999999 / 0 / 1/step]
8-961-005	Electricity Status	Printing Time	CTL*	[0 to 99999999 / 0 / 1/step]
8-961-006	Electricity Status	Reading Time	CTL*	[0 to 99999999 / 0 / 1/step]
8-961-007	Electricity Status	Eng Waiting Time	CTL*	[0 to 99999999 / 0 / 1/step]
8-961-008	Electricity Status	Low Power State Time	CTL*	[0 to 99999999 / 0 / 1/step]
8-961-009	Electricity Status	Silent State Time	CTL*	[0 to 99999999 / 0 / 1/step]
8-961-010	Electricity Status	Heater Off State Time	CTL*	[0 to 99999999 / 0 / 1/step]
8-961-011	Electricity Status	LCD on Time	CTL*	[0 to 99999999 / 0 / 1/step]
8-961-101	Electricity Status	Silent Print	CTL*	[0 to 99999999 / 0 / 1/step]
8-971-001	Unit Control	Engine Off Recovery Count	CTL*	[0 to 99999999 / 0 / 1/step]
8-971-002	Unit Control	Power Off Count	CTL*	[0 to 99999999 / 0 / 1/step]
8-971-003	Unit Control	Force Power Off Count	CTL*	[0 to 99999999 / 0 / 1/step]
8-999-001	Admin. Counter List	Total	CTL*	[0 to 99999999 / 0 / 1/step]
8-999-002	Admin. Counter List	Copy: Full Color	CTL*	[0 to 99999999 / 0 / 1/step]
8-999-003	Admin. Counter List	Copy: BW	CTL*	[0 to 99999999 / 0 / 1/step]
8-999-004	Admin. Counter List	Copy: Single Color	CTL*	[0 to 99999999 / 0 / 1/step]
8-999-005	Admin. Counter List	Copy: Two Color	CTL*	[0 to 99999999 / 0 / 1/step]

3.SP Mode Tables

SP No.	Large Category	Small Category	ENG or CTL	[Min to Max/Init./Step]
8-999-006	Admin. Counter List	Printer: Full Color	CTL*	[0 to 99999999 / 0 / 1/step]
8-999-007	Admin. Counter List	Printer: BW	CTL*	[0 to 99999999 / 0 / 1/step]
8-999-008	Admin. Counter List	Printer: Single Color	CTL*	[0 to 99999999 / 0 / 1/step]
8-999-009	Admin. Counter List	Printer: Two Color	CTL*	[0 to 99999999 / 0 / 1/step]
8-999-010	Admin. Counter List	Fax Print: BW	CTL*	[0 to 99999999 / 0 / 1/step]
8-999-012	Admin. Counter List	A3/DLT	CTL*	[0 to 99999999 / 0 / 1/step]
8-999-013	Admin. Counter List	Duplex	CTL*	[0 to 99999999 / 0 / 1/step]
8-999-022	Admin. Counter List	Copy: Full Color(%)	CTL*	[0 to 2147483647 / 0 / 1/step]
8-999-023	Admin. Counter List	Copy: BW(%)	CTL*	[0 to 2147483647 / 0 / 1/step]
8-999-024	Admin. Counter List	Copy: Single Color(%)	CTL*	[0 to 2147483647 / 0 / 1/step]
8-999-025	Admin. Counter List	Copy: Two Color(%)	CTL*	[0 to 2147483647 / 0 / 1/step]
8-999-026	Admin. Counter List	Printer: Full Color(%)	CTL*	[0 to 2147483647 / 0 / 1/step]
8-999-027	Admin. Counter List	Printer: BW(%)	CTL*	[0 to 2147483647 / 0 / 1/step]
8-999-028	Admin. Counter List	Printer: Single Color(%)	CTL*	[0 to 2147483647 / 0 / 1/step]
8-999-029	Admin. Counter List	Printer: Two Color(%)	CTL*	[0 to 2147483647 / 0 / 1/step]
8-999-030	Admin. Counter List	Fax Print: BW(%)	CTL*	[0 to 2147483647 / 0 / 1/step]
8-999-032	Admin. Counter List	Banner	CTL*	[0 to 99999999 / 0 / 1/step]
8-999-101	Admin. Counter List	Transmission Total: Color	CTL*	[0 to 99999999 / 0 / 1/step]

3.SP Mode Tables

SP No.	Large Category	Small Category	ENG or CTL	[Min to Max/Init./Step]
8-999-102	Admin. Counter List	Transmission Total: BW	CTL*	[0 to 99999999 / 0 / 1/step]
8-999-103	Admin. Counter List	FAX Transmission	CTL*	[0 to 99999999 / 0 / 1/step]
8-999-104	Admin. Counter List	Scanner Transmission: Color	CTL*	[0 to 99999999 / 0 / 1/step]
8-999-105	Admin. Counter List	Scanner Transmission: BW	CTL*	[0 to 99999999 / 0 / 1/step]
8-999-111	Admin. Counter List	Total: Full Color Simplex Over A3/DLT	CTL*	[0 to 99999999 / 0 / 1/step]
8-999-112	Admin. Counter List	Total: Full Color Simplex Under A3/DLT	CTL*	[0 to 99999999 / 0 / 1/step]
8-999-113	Admin. Counter List	Total: Full Color Duplex Over A3/DLT	CTL*	[0 to 99999999 / 0 / 1/step]
8-999-114	Admin. Counter List	Total: Full Color Duplex Under A3/DLT	CTL*	[0 to 99999999 / 0 / 1/step]
8-999-115	Admin. Counter List	Total: BW Simplex Over A3/DLT	CTL*	[0 to 99999999 / 0 / 1/step]
8-999-116	Admin. Counter List	Total: BW Simplex Under A3/DLT	CTL*	[0 to 99999999 / 0 / 1/step]
8-999-117	Admin. Counter List	Total: BW Duplex Over A3/DLT	CTL*	[0 to 99999999 / 0 / 1/step]
8-999-118	Admin. Counter List	Total: BW Duplex Under A3/DLT	CTL*	[0 to 99999999 / 0 / 1/step]
8-999-119	Admin. Counter List	Total: Single Color Simplex Over A3/DLT	CTL*	[0 to 99999999 / 0 / 1/step]
8-999-120	Admin. Counter List	Total: Single Color Simplex Under A3/DLT	CTL*	[0 to 99999999 / 0 / 1/step]
8-999-121	Admin. Counter List	Total: Single Color Duplex Over A3/DLT	CTL*	[0 to 99999999 / 0 / 1/step]
8-999-122	Admin. Counter List	Total: Single Color Duplex Under A3/DLT	CTL*	[0 to 99999999 / 0 / 1/step]
8-999-123	Admin. Counter List	Total: Two Color Simplex Over A3/DLT	CTL*	[0 to 99999999 / 0 / 1/step]
8-999-124	Admin. Counter List	Total: Two Color Simplex Under A3/DLT	CTL*	[0 to 99999999 / 0 / 1/step]

3.SP Mode Tables

SP No.	Large Category	Small Category	ENG or CTL	[Min to Max/Init./Step]
8-999-125	Admin. Counter List	Total: Two Color Duplex Over A3/DLT	CTL*	[0 to 99999999 / 0 / 1/step]
8-999-126	Admin. Counter List	Total: Two Color Duplex Under A3/DLT	CTL*	[0 to 99999999 / 0 / 1/step]
8-999-131	Admin. Counter List	Copy: Full Color Simplex Over A3/DLT	CTL*	[0 to 99999999 / 0 / 1/step]
8-999-132	Admin. Counter List	Copy: Full Color Simplex Under A3/DLT	CTL*	[0 to 99999999 / 0 / 1/step]
8-999-133	Admin. Counter List	Copy: Full Color Duplex Over A3/DLT	CTL*	[0 to 99999999 / 0 / 1/step]
8-999-134	Admin. Counter List	Copy: Full Color Duplex Under A3/DLT	CTL*	[0 to 99999999 / 0 / 1/step]
8-999-135	Admin. Counter List	Copy: BW Simplex Over A3/DLT	CTL*	[0 to 99999999 / 0 / 1/step]
8-999-136	Admin. Counter List	Copy: BW Simplex Under A3/DLT	CTL*	[0 to 99999999 / 0 / 1/step]
8-999-137	Admin. Counter List	Copy: BW Duplex Over A3/DLT	CTL*	[0 to 99999999 / 0 / 1/step]
8-999-138	Admin. Counter List	Copy: BW Duplex Under A3/DLT	CTL*	[0 to 99999999 / 0 / 1/step]
8-999-139	Admin. Counter List	Copy: Single Color Simplex Over A3/DLT	CTL*	[0 to 99999999 / 0 / 1/step]
8-999-140	Admin. Counter List	Copy: Single Color Simplex Under A3/DLT	CTL*	[0 to 99999999 / 0 / 1/step]
8-999-141	Admin. Counter List	Copy: Single Color Duplex Over A3/DLT	CTL*	[0 to 99999999 / 0 / 1/step]
8-999-142	Admin. Counter List	Copy: Single Color Duplex Under A3/DLT	CTL*	[0 to 99999999 / 0 / 1/step]
8-999-143	Admin. Counter List	Copy: Two Color Simplex Over A3/DLT	CTL*	[0 to 99999999 / 0 / 1/step]
8-999-144	Admin. Counter List	Copy: Two Color Simplex Under A3/DLT	CTL*	[0 to 99999999 / 0 / 1/step]
8-999-145	Admin. Counter List	Copy: Two Color Duplex Over A3/DLT	CTL*	[0 to 99999999 / 0 / 1/step]
8-999-146	Admin. Counter List	Copy: Two Color Duplex Under A3/DLT	CTL*	[0 to 99999999 / 0 / 1/step]

3.SP Mode Tables

SP No.	Large Category	Small Category	ENG or CTL	[Min to Max/Init./Step]
8-999-151	Admin. Counter List	Printer: Full Color Simplex Over A3/DLT	CTL*	[0 to 99999999 / 0 / 1/step]
8-999-152	Admin. Counter List	Printer: Full Color Simplex Under A3/DLT	CTL*	[0 to 99999999 / 0 / 1/step]
8-999-153	Admin. Counter List	Printer: Full Color Duplex Over A3/DLT	CTL*	[0 to 99999999 / 0 / 1/step]
8-999-154	Admin. Counter List	Printer: Full Color Duplex Under A3/DLT	CTL*	[0 to 99999999 / 0 / 1/step]
8-999-155	Admin. Counter List	Printer: BW Simplex Over A3/DLT	CTL*	[0 to 99999999 / 0 / 1/step]
8-999-156	Admin. Counter List	Printer: BW Simplex Under A3/DLT	CTL*	[0 to 99999999 / 0 / 1/step]
8-999-157	Admin. Counter List	Printer: BW Duplex Over A3/DLT	CTL*	[0 to 99999999 / 0 / 1/step]
8-999-158	Admin. Counter List	Printer: BW Duplex Under A3/DLT	CTL*	[0 to 99999999 / 0 / 1/step]
8-999-159	Admin. Counter List	Printer: Single Color Simplex Over A3/DLT	CTL*	[0 to 99999999 / 0 / 1/step]
8-999-160	Admin. Counter List	Printer: Single Color Simplex Under A3/DLT	CTL*	[0 to 99999999 / 0 / 1/step]
8-999-161	Admin. Counter List	Printer: Single Color Duplex Over A3/DLT	CTL*	[0 to 99999999 / 0 / 1/step]
8-999-162	Admin. Counter List	Printer: Single Color Duplex Under A3/DLT	CTL*	[0 to 99999999 / 0 / 1/step]
8-999-163	Admin. Counter List	Printer: Two Color Simplex Over A3/DLT	CTL*	[0 to 99999999 / 0 / 1/step]
8-999-164	Admin. Counter List	Printer: Two Color Simplex Under A3/DLT	CTL*	[0 to 99999999 / 0 / 1/step]
8-999-165	Admin. Counter List	Printer: Two Color Duplex Over A3/DLT	CTL*	[0 to 99999999 / 0 / 1/step]
8-999-166	Admin. Counter List	Printer: Two Color Duplex Under A3/DLT	CTL*	[0 to 99999999 / 0 / 1/step]
8-999-171	Admin. Counter List	Fax: BW Simplex Over A3/DLT	CTL*	[0 to 99999999 / 0 / 1/step]
8-999-172	Admin. Counter List	Fax: BW Simplex Under A3/DLT	CTL*	[0 to 99999999 / 0 / 1/step]

3.SP Mode Tables

SP No.	Large Category	Small Category	ENG or CTL	[Min to Max/Init./Step]
8-999-173	Admin. Counter List	Fax: BW Duplex Over A3/DLT	CTL*	[0 to 999999999 / 0 / 1/step]
8-999-174	Admin. Counter List	Fax: BW Duplex Under A3/DLT	CTL*	[0 to 999999999 / 0 / 1/step]
8-999-191	Admin. Counter List	Scan: Over A3/DLT	CTL*	[0 to 999999999 / 0 / 1/step]
8-999-192	Admin. Counter List	Scan: Under A3/DLT	CTL*	[0 to 999999999 / 0 / 1/step]

Input and Output Check

Input Check Table

Main Machine, Paper Feed Tray

5803	[INPUT Check]		
5-803-001	Registration Sensor	ENG	[0 or 1 / 0 / 1/step] 0: paper exist 1: paper non exist
	Responds to paper existence on register sensor position.		
5-803-002	Paper Feed Sensor 1	ENG	[0 or 1 / 0 / 1/step] 0: paper exist 1: paper non exist
	Responds to paper existence on 1st paper feed sensor position.		
5-803-003	Transport Sensor 1	ENG	[0 or 1 / 0 / 1/step] 0: paper exist 1: paper non exist
	Responds to paper existence on 1st carry sensor position.		
5-803-004	Paper Feed Sensor 2	ENG	[0 or 1 / 0 / 1/step] 0: paper exist 1: paper non exist
	Responds to paper existence on 2nd paper feed sensor position.		
5-803-005	Transport Sensor 2	ENG	[0 or 1 / 0 / 1/step] 0: paper exist 1: paper non exist
	Responds to paper existence on 2nd carry sensor position.		
5-803-006	Fusing Entrance Sensor	ENG	[0 or 1 / 0 / 1/step] 0: paper exist 1: paper non exist
	Responds to paper existence on fusing entrance sensor position.		
5-803-007	Fusing Exit Sensor	ENG	[0 or 1 / 0 / 1/step] 0: paper exist 1: paper non exist
	Responds to paper existence on fusing exit sensor position. (0: paper exist, 1: paper non exist)		
5-803-008	Paper Exit Sensor	ENG	[0 or 1 / 0 / 1/step] 0: paper exist 1: paper non exist
	Responds to paper existence on paper exit sensor position.		

5-803-009	Inverter Sensor	ENG	[0 or 1 / 0 / 1/step] 0: paper exist 1: paper non exist
	Responds to paper existence on reverse sensor position.		
5-803-010	Duplex Exit Sensor	ENG	[0 or 1 / 0 / 1/step] 0: paper exist 1: paper non exist
	Responds to paper existence on duplex exit sensor position.		
5-803-011	Duplex Entrance Sensor	ENG	[0 or 1 / 0 / 1/step] 0: paper exist 1: paper non exist
	Responds to paper existence on duplex entrance sensor position.		
5-803-012	Tray Full Exit Sensor	ENG	[0 or 1 / 0 / 1/step] 0: Not full 1: full
	Detects paper full of main unit paper exit tray.		
5-803-013	Tray 1: Paper Height Sensor	ENG	[0 to 3 / 0 / 1/step] When full is 100%, 11: 71 to 100% 01: 31 to 70% 00: 11 to 30% 10: 1 to 10%
	Detects remaining paper amount of 1st paper feed tray. *Check SP5-803-015 for paper end.		
5-803-014	Tray 1: Upper Limit Sensor	ENG	[0 or 1 / 0 / 1/step] 0: less then limit 1: high then limit
	Detects the height of paper loaded in 1st paper feed tray. * As long as you do not press the white bar of the machine side in the tray back, not output.		
5-803-015	Tray 1: Paper End Detection	ENG	[0 or 1 / 0 / 1/step] 0: No paper 1: paper remaining
	Detects paper is running out on 1st paper feed tray.		
5-803-016	Tray 1: Set Sensor	ENG	[0 or 1 / 0 / 1/step] 0: set 1: not set
	Detects that 1st paper feed tray is set to main unit.		
5-803-	Tray 2: Paper Height Sensor	ENG	[0 to 3 / 0 / 1/step]

3.SP Mode Tables

017			When full is 100%, 11: 71 to 100% 01: 31 to 70% 00: 11 to 30% 10: 1 to 10%
	Detects remaining paper amount of 2nd paper feed tray. *Check SP5-803-019 for paper end.		
5-803-018	Tray 2: Paper End Sensor	ENG	[0 or 1 / 0 / 1/step] 0: less then limit 1: high then limit
	Detects the height of paper loaded in 2nd paper feed tray. * As long as you do not press the white bar of the machine side in the tray back, not output.		
5-803-019	Tray 2: Paper End Detection	ENG	[0 or 1 / 0 / 1/step] 0: No paper 1: paper remaining
	Detects paper running out of 2nd paper feed tray.		
5-803-020	Tray 2: Set Sensor	ENG	[0 or 1 / 0 / 1/step] 0: set 1: not set
	Detects that 2nd paper feed tray is set to main unit.		
5-803-021	Tray 2: Size Sensor	ENG	[0 to 15 / 0 / 1/step]
	Value changes depending on paper size (fence position) set to 2nd paper feed tray.		
5-803-022	By-pass: Paper End Sensor	ENG	[0 or 1 / 0 / 1/step] 0: No paper 1: paper remaining
	Detects paper is running out on bypass tray.		
5-803-023	By-pass: Main Scan Length Sensor	ENG	[0 to 31 / 0 / 1/step]
	Value changes depending on main scan direction of paper set to bypass tray.		
5-803-024	By-pass: Sub Scan Length Sensor	ENG	[0 or 1 / 0 / 1/step]
	Value changes depending on sub scan direction of paper set to bypass tray.		
5-803-025	Interlock Release Detection	ENG	[00 to 11 / 0 / 1/step] 00: Unlocked 11: Locked
	Detects open/close of interlock switch (front cover/right cover).		
5-803-026	Right Door Open/Close Sensor	ENG	[0 or 1 / 0 / 1/step] 0: close 1: open
	Detects right door status.		

3.SP Mode Tables

5-803-027	Duplex Guide Plate Open/Close Sensor	ENG	[0 or 1 / 0 / 1/step] 0: close 1: open
	Detects duplex guide plate status.		
5-803-028	PTR Open/Close Sensor	ENG	[0 or 1 / 0 / 1/step] 0: open 1: close
	Detects paper transfer unit status.		
5-803-029	ITB Contact Sensor	ENG	[0 or 1 / 0 / 1/step] 0: Abutting 1: Alienate
	Detects image transfer roller (Y, M, and C) and photoreceptors distance.		
5-803-030	PTR Contact Sensor	ENG	[0 or 1 / 0 / 1/step] 0: Abutting 1: Alienate
	Detects image transfer belt and paper transfer rollers distance.		
5-803-031	New ITB Unit Detection	ENG	[0 or 1 / 0 / 1/step] 0: New unit 1: Used unit
	Detects New/Old of ITB unit.		
5-803-032	Toner Collection Full Sensor	ENG	[0 or 1 / 0 / 1/step] 0: Not full 1: full
	Detects full of waste toner bottle.		
5-803-033	Toner Collection Bottle Set Sensor	ENG	[0 or 1 / 0 / 1/step] 0: set 1: not set
	Detects that waste toner bottle is set to main unit.		
5-803-034	Toner End Sensor:Y	ENG	[0 or 1 / 0 / 1/step] 0: End 1: Not End
	Detects remaining toner amount. *Power with SP5-804-173 before checking.		
5-803-035	Toner End Sensor:M	ENG	[0 or 1 / 0 / 1/step] 0: End 1: Not End
	Detects remaining toner amount. *Power with SP5-804-173 before checking.		

3.SP Mode Tables

5-803-036	Toner End Sensor:C	ENG	[0 or 1 / 0 / 1/step] 0: End 1: Not End
	Detects remaining toner amount. *Power with SP5-804-173 before checking.		
5-803-037	Toner End Sensor:K	ENG	[0 or 1 / 0 / 1/step] 0: End 1: Not End
	Detects remaining toner amount. *Power with SP5-804-172 before checking.		
5-803-038	Fusing:Area Detection	ENG	[0 to 15 / 0 / 1/step] 10:100V System 01:200V system 00, 01:unit set error
	Detects region of fusing unit.		
5-803-039	Fusing:New Unit Detection	ENG	[0 or 1 / 0 / 1/step] 0: New 1: Old
	Detects New/Old of fusing unit.		
5-803-040	Fusing Temp Detect	ENG	[0 or 1 / 0 / 1/step] 0: Normal 1: High temperature
	Detects whether high temperature is detected from fusing unit.		
5-803-041	NC Sensor Temp Detection/ 2	ENG	[0 or 1 / 0 / 1/step] 0: Normal 1: High temperature
	Detects whether high temperature is detected from fusing unit.		
5-803-042	NC Sensor Temp Detection/ 1	ENG	[0 or 1 / 0 / 1/step] 0: Normal 1: High temperature
	Detects whether high temperature is detected from fusing unit.		
5-803-047	Nip Pres. Release Home Position Sensor	ENG	[0 or 1 / 0 / 1/step] 0: Pressured 1: Not pressured
	Detects state of fusing nip pressure.		
5-803-048	Fusing Fan: Lock	ENG	[0 or 1 / 0 / 1/step] 0: Running 1: Stopped, or locked

	Detects locking of fusing exhaust heat fan.		
5-803-049	Dev Fan: Right: Lock	ENG	[0 or 1 / 0 / 1/step] 0: Running 1: Stopped, or locked
	Detects locking of developer air intake fan (right).		
5-803-051	PSU Cooling Fan: Lock	ENG	[0 or 1 / 0 / 1/step] 0: Running 1: Stopped, or locked
	Detects locking of PSU cooling fan.		
5-803-052	Ozone Fan: Lock	ENG	[0 or 1 / 0 / 1/step] 0: Running 1: Stopped, or locked
	Detects locking of ozone exhaust air fan.		
5-803-055	PCB Box Cooling Fan: Lock	ENG	[0 or 1 / 0 / 1/step] 0: Running 1: Stopped, or locked
	Detects locking of electric box cooling fan.		
5-803-056	Drive Cooling Fan: Lock	ENG	[0 or 1 / 0 / 1/step] 0: Running 1: Stopped, or locked
	Detects locking of drive cooling fan. *C6000/C5500/C4500 only		
5-803-057	Ventilation Fan: Lock	ENG	[0 or 1 / 0 / 1/step] 0: Running 1: Stopped, or locked
	Detects locking of main unit exhaust heat fan. *C6000/C5500/C4500 only		
5-803-058	Paper Exit Cooling Fan: Lock	ENG	[0 or 1 / 0 / 1/step] 0: Running 1: Stopped, or locked
	Detects locking of paper exit cooling fan.		
5-803-060	Toner Supply Cooling Fan: Lock	ENG	[0 or 1 / 0 / 1/step] 0: Running 1: Stopped, or locked
	Detects locking of toner supply cooling fan.		
5-803-061	Development Motor K: Lock	ENG	[0 or 1 / 0 / 1/step] 0: Running 1: Stopped, or locked

3.SP Mode Tables

	Detects locking of developer motor (K). *C6000/C5500/C4500 only		
5-803-063	Development Motor FC: Lock	ENG	[0 or 1 / 0 / 1/step] 0: Stopped, or locked 1: Running
	Detects locking of developer motor (FC).		
5-803-064	Drum Motor FC: Lock	ENG	[0 or 1 / 0 / 1/step] 0: Stopped, or locked 1: Running
	Detects locking of drum motor (FC).		
5-803-065	Fusing Motor: Lock	ENG	[0 or 1 / 0 / 1/step] 0: Stopped, or locked 1: Running
	Detects locking of fusing motor.		
5-803-066	Transfer Drum Motor K: Lock	ENG	[0 or 1 / 0 / 1/step] 0: Stopped, or locked 1: Running
	Detects locking of transfer drum motor K.		
5-803-068	PP:CB:SC Detection	ENG	[0 or 1 / 0 / 1/step] 0: SC detected 1: Normal
	Detects SC of HVP (electrify/develop).		
5-803-069	PP:TTS:SC Detection	ENG	[0 or 1 / 0 / 1/step] 0: SC detected 1: Normal
	Detects SC of HVP (transfer).		
5-803-072	Key Counter: Set 1	ENG	[0 or 1 / 0 / 1/step] 0: set 1:unset key counter: set 1=0, 2=1 for set, others for unset
	Detects setting of key counter.		
5-803-073	Key Counter: Set 2	ENG	[0 or 1 / 0 / 1/step] 0: unset 1:set (key counter: set 1=0, 2=1 for set, others for unset)
	Detects setting of key counter.		

5-803-074	Key Card Set	ENG	[0 or 1 / 0 / 1/step] 0: set 1: not set
	Detects that key card is set to main unit.		
5-803-075	1 Bin Tray: Paper Sensor	ENG	[0 or 1 / 0 / 1/step] 0: paper exist 1: paper non exist
	Detects that paper is left upon the tray.		
5-803-076	1 Bin Tray: Set Detection System	ENG	[0 or 1 / 0 / 1/step] 0: paper exist 1: paper non exist
	Detects that tray is set to main unit.		
5-803-077	Bridge Relay Sensor	ENG	[0 or 1 / 0 / 1/step] 0: paper exist 1: paper non exist
	Responds to paper existence on carry sensor position or bridge unit.		
5-803-078	Bridge Exit Sensor	ENG	[0 or 1 / 0 / 1/step] 0: Paper exist 1: Paper do not exist
	Responds to paper existence on paper exit sensor position or bridge unit.		
5-803-079	Bridge Set Detection System	ENG	[0 or 1 / 0 / 1/step] 10: set 11: not set
	Detects that bridge unit is set to main unit.		
5-803-082	Bridge Relay/Left Exit Cover Sensor	ENG	[0 or 1 / 0 / 1/step] 0: close 1: open
	Detects open/close of the left carry cover open/close sensor (left paper exit tray) and the relay carry cover open/close sensor (bridge unit).		
5-803-083	Bridge Exit/Upper Exit Cover Sensor	ENG	[0 or 1 / 0 / 1/step] 0: close 1: open
	Detects open/close of the upper carry cover open/close sensor (left paper exit tray) and the relay paper exit cover open/close sensor (bridge unit).		
5-803-084	Shift Tray: Set Detection System	ENG	[0 or 1 / 0 / 1/step] 01: set 11: not set
	Detects that shift tray is set to main unit.		

3.SP Mode Tables

5-803-085	Shift Tray: Position Sensor 1	ENG	[0 or 1 / 0 / 1/step] 0: Stop on this side. during moving towards inner 1: Stop on inner side. during moving towards this side
	Detects shift tray position.		
5-803-086	Shift Tray: Position Sensor 2	ENG	[0 or 1 / 0 / 1/step]
	*It is a backup sensor with this machine, so "1" is always displayed)		
5-803-094	GAVD Open/Close Detection	ENG	[0 or 1 / 0 / 1/step]
	For checking door open/close during process. No need to operate.		
5-803-095	Bridge 24V Fuse Detection	ENG	[0 or 1 / 0 / 1/step] 0: Not cut 1: Cut
	Detects state of 24V fuse on the bridge unit.		
5-803-096	Bridge 5V Fuse Detection	ENG	[0 or 1 / 0 / 1/step] 0: Not cut 1: Cut
	Detects state of 5V fuse on the bridge unit.		
5-803-097	Fusing Shading Plate Sensor /1	ENG	[0 or 1 / 0 / 1/step] 0: Not shading 1: shading
	Detects position of fusing shade plate. *C6000/C5500/C4500 only		
5-803-100	IOB TRANSPORT:Overcurrent Detect	ENG	[0 or 1 / 0 / 1/step]
	-		
5-803-101	IOB ENGINE:Overcurrent Detect	ENG	[0 or 1 / 0 / 1/step]
	-		
5-803-102	IDTAG Power:Overcurrent Detect	ENG	[0 or 1 / 0 / 1/step]
	-		
5-803-103	Toner Sensor Power:Overcurrent Detect	ENG	[0 or 1 / 0 / 1/step]
	-		
5-803-105	By-pass: Main Scan Length Sensor Set	ENG	[0 to 400 / 0 / 0.1/mm]
	-		

5-803-106	By-pass: Main Scan Length Sensor Unit:mm	ENG	[0 or 1 / 0 / 1/step]
	-		
5-803-200	HP Sensor Tests the scanner HP sensor.	ENG	[0 or 1 / 0 / 1/step]
5-803-201	Platen Cover Sensor Tests the book open/close sensor.	ENG	[0 or 1 / 0 / 1/step]
5803	[INPUT Check]		
	Gets information of specified sensor.		
5-803-211	Bank: Tray3: Feed Sensor	ENG	[0 or 1 / 0 / 1/step] 0: paper not detected 1: paper detected.
5-803-212	Bank: Tray4: Feed Sensor	ENG	
5-803-213	Bank: Tray5: Feed Sensor	ENG	
5-803-214	Bank: Tray3: Transport Sensor	ENG	
5-803-215	Bank: Tray4: Transport Sensor	ENG	
5-803-216	Bank: Tray5: Transport Sensor	ENG	
5-803-217	Bank: Feed Cover Open Detection 1	ENG	
5-803-218	Bank: Feed Cover Open Detection 2	ENG	
5-803-219	LCT Paper Supply Open/Close	ENG	
5-803-220	LCT Slide Open/Close	ENG	[0 or 1 / 0 / 1/step] 0: slide open 1: slide closed

PP:CB:SC Detection

ARDF

6007	[ADF INPUT Check]		
	Gets sensor information from ADF. Displays signal level of sensor as it is.		
6-007-001	Original Length 1 (B5 Detection Sensor)	ENG	[0 or 1 / 0 / 1/step]
6-007-002	Original Length 2 (A4 Detection Sensor)	ENG	[0 or 1 / 0 / 1/step]

3.SP Mode Tables

6-007-003	Original Length 3 (LG Detection Sensor)	ENG	[0 or 1 / 0 / 1/step]
6-007-004	Original Width 1	ENG	[0 or 1 / 0 / 1/step]
6-007-005	Original Width 2	ENG	[0 or 1 / 0 / 1/step]
6-007-006	Original Width 3	ENG	[0 or 1 / 0 / 1/step]
6-007-007	Original Width 4	ENG	[0 or 1 / 0 / 1/step]
6-007-008	Original Width 5	ENG	[0 or 1 / 0 / 1/step]
6-007-009	Original Detection	ENG	[0 or 1 / 0 / 1/step]
6-007-011	Skew Correction	ENG	[0 or 1 / 0 / 1/step]
6-007-013	Registration Sensor	ENG	[0 or 1 / 0 / 1/step]
6-007-014	Exit Sensor	ENG	[0 or 1 / 0 / 1/step]
6-007-015	Feed Cover Sensor	ENG	[0 or 1 / 0 / 1/step]
6-007-016	Lift Up Sensor	ENG	[0 or 1 / 0 / 1/step]
6-007-023	Rear Edge Detection	ENG	[0 or 1 / 0 / 1/step]

SPDF

6011	[1-Pass ADF INPUT Check]		
6-011-001	Original Length 1 (B5 Sensor)	ENG	[0 or 1 / 0 / 1/step]
	Gets sensor information from ADF. Gives 1 when there is a paper at sensor area.		
6-011-002	Original Length 2 (A4 Sensor)	ENG	[0 or 1 / 0 / 1/step]
	Gets sensor information from ADF. Gives 1 when there is a paper at sensor area.		
6-011-003	Original Length 3 (LG Sensor)	ENG	[0 or 1 / 0 / 1/step]
	Gets sensor information from ADF. Gives 1 when there is a paper at sensor area.		
6-011-004	Original Width 1	ENG	[0 or 1 / 0 / 1/step]
	Gets sensor information from ADF. Gives 1 when there is a paper at sensor area.		
6-011-005	Original Width 2	ENG	[0 or 1 / 0 / 1/step]
	Gets sensor information from ADF. Gives 1 when there is a paper at sensor area.		
6-011-006	Original Width 3	ENG	[0 or 1 / 0 / 1/step]
	Gets sensor information from ADF. Gives 1 when there is a paper at sensor area.		
6-011-007	Original Width 4	ENG	[0 or 1 / 0 / 1/step]
	Gets sensor information from ADF. Gives 1 when there is a paper at sensor area.		
6-011-008	Original Width 5	ENG	[0 or 1 / 0 / 1/step]
	Gets sensor information from ADF. Gives 1 when there is a paper at sensor area.		
6-011-009	Original Detection	ENG	[0 or 1 / 0 / 1/step]
	Gets sensor information from ADF. Gives 1 when original is set.		
6-011-010	Separation Sensor	ENG	[0 or 1 / 0 / 1/step]
	Gets sensor information from ADF. Gives 1 when there is a paper at sensor area.		
6-011-011	Skew Correction	ENG	[0 or 1 / 0 / 1/step]
	Gets sensor information from ADF. Gives 1 when there is a paper at sensor area.		

6-011-012	Scan Entrance Sensor	ENG	[0 or 1 / 0 / 1/step]
	Gets sensor information from ADF. Gives 1 when there is a paper at sensor area.		
6-011-013	Registration Sensor	ENG	[0 or 1 / 0 / 1/step]
	Gets sensor information from ADF. Gives 1 when there is a paper at sensor area.		
6-011-014	Exit Sensor	ENG	[0 or 1 / 0 / 1/step]
	Gets sensor information from ADF. Gives 1 when there is a paper at sensor area.		
6-011-015	Feed Cover Sensor	ENG	[0 or 1 / 0 / 1/step]
	Gets sensor information from ADF. Gives 1 when cover is open.		
6-011-016	Lift Up Sensor	ENG	[0 or 1 / 0 / 1/step]
	Gets sensor information from ADF. Gives 1 when lift up.		
6-011-018	Pick-Up Roller HP Sensor	ENG	[0 or 1 / 0 / 1/step]
	Gets sensor information from ADF. Gives 1 when pick up roller is not in home position.		
6-011-021	Bottom Plate HP Sensor	ENG	[0 or 1 / 0 / 1/step]
	Gets sensor information from ADF. Gives 1 when bottom plate is not in home position.		
6-011-022	Bottom Plate Position Sensor	ENG	[0 or 1 / 0 / 1/step]
	Gets sensor information from ADF. Gives 1 when pick up roller is not in the correct position.		
6-011-023	Original Length 4 (LT/A4 Tail Sensor)	ENG	[0 or 1 / 0 / 1/step]
	Gets sensor information from ADF. Gives 1 when there is a paper at sensor area.		
6-011-024	Double Feed Detect Sensor	ENG	[0 or 1 / 0 / 1/step]
	Gets sensor information from ADF. Gives 1 when there is a paper at sensor area.		
6-011-025	Feeding Unit Sensor	ENG	[0 or 1 / 0 / 1/step]
	Gets sensor information from ADF. Gives 1 when there is a paper at sensor area.		

Booklet Finisher SR3290/Finisher SR3280

6123	[INPUT Check: 2K/3K FIN]		
6-123-001	Entrance Sensor	ENG	[0 or 1 / 0 / 1/step]
	Gets information of specified sensor. Displays signal level of sensor as it is.		
6-123-002	Horizontal Transport Sensor	ENG	[0 or 1 / 0 / 1/step]
	Gets information of specified sensor. Displays signal level of sensor as it is.		
6-123-003	Switchback Transport Sensor	ENG	[0 or 1 / 0 / 1/step]
	Gets information of specified sensor. Displays signal level of sensor as it is.		
6-123-004	Proof Tray Exit Sensor	ENG	[0 or 1 / 0 / 1/step]
	Gets information of specified sensor. Displays signal level of sensor as it is.		
6-123-005	Shift Tray Exit Sensor	ENG	[0 or 1 / 0 / 1/step]
	Gets information of specified sensor. Displays signal level of sensor as it is.		
6-123-	Booklet Stapler Exit Sensor	ENG	[0 or 1 / 0 / 1/step]

3.SP Mode Tables

006	Gets information of specified sensor. Displays signal level of sensor as it is.		
6-123-007	Paper Exit Open/Close Guide HP Sensor	ENG	[0 or 1 / 0 / 1/step]
	Gets information of specified sensor. Displays signal level of sensor as it is.		
6-123-008	Punch HP Sensor	ENG	[0 or 1 / 0 / 1/step]
	Gets information of specified sensor. Displays signal level of sensor as it is.		
6-123-009	Punch Move HP Sensor	ENG	[0 or 1 / 0 / 1/step]
	Gets information of specified sensor. Displays signal level of sensor as it is.		
6-123-010	S-to-S Registration Detection HP Sensor	ENG	[0 or 1 / 0 / 1/step]
	Gets information of specified sensor. Displays signal level of sensor as it is.		
6-123-011	Lower Junction Solenoid HP Sensor	ENG	[0 or 1 / 0 / 1/step]
	Gets information of specified sensor. Displays signal level of sensor as it is.		
6-123-012	Jogger HP Sensor	ENG	[0 or 1 / 0 / 1/step]
	Gets information of specified sensor. Displays signal level of sensor as it is.		
6-123-013	Positioning Roller HP Sensor	ENG	[0 or 1 / 0 / 1/step]
	Gets information of specified sensor. Displays signal level of sensor as it is.		
6-123-014	Feed-out HP Sensor	ENG	[0 or 1 / 0 / 1/step]
	Gets information of specified sensor. Displays signal level of sensor as it is.		
6-123-015	Stapler Moving HP Sensor	ENG	[0 or 1 / 0 / 1/step]
	Gets information of specified sensor. Displays signal level of sensor as it is.		
6-123-016	Booklet Stapler HP Sensor	ENG	[0 or 1 / 0 / 1/step]
	Gets information of specified sensor. Displays signal level of sensor as it is.		
6-123-017	Booklet Jogger HP Sensor	ENG	[0 or 1 / 0 / 1/step]
	Gets information of specified sensor. Displays signal level of sensor as it is.		
6-123-018	Booklet Jog Solenoid HP Sensor	ENG	[0 or 1 / 0 / 1/step]
	Gets information of specified sensor. Displays signal level of sensor as it is.		
6-123-019	Booklet Standard Fence HP Sensor	ENG	[0 or 1 / 0 / 1/step]
	Gets information of specified sensor. Displays signal level of sensor as it is.		
6-123-020	Booklet Stapler HP Sensor	ENG	[0 or 1 / 0 / 1/step]
	Gets information of specified sensor. Displays signal level of sensor as it is.		
6-123-022	Folder Blade Cam HP Sensor	ENG	[0 or 1 / 0 / 1/step]
	Gets information of specified sensor. Displays signal level of sensor as it is.		
6-123-023	Folder Blade HP Sensor	ENG	[0 or 1 / 0 / 1/step]
	Gets information of specified sensor. Displays signal level of sensor as it is.		
6-123-024	Shift Roller HP Sensor	ENG	[0 or 1 / 0 / 1/step]
	Gets information of specified sensor. Displays signal level of sensor as it is.		
6-123-028	Drag Roller Vibrating HP Sensor	ENG	[0 or 1 / 0 / 1/step]
	Gets information of specified sensor. Displays signal level of sensor as it is.		
6-123-	LE Guide HP Sensor	ENG	[0 or 1 / 0 / 1/step]

029	Gets information of specified sensor. Displays signal level of sensor as it is.		
6-123-030	TE Stack Plate HP Sensor	ENG	[0 or 1 / 0 / 1/step]
030	Gets information of specified sensor. Displays signal level of sensor as it is.		
6-123-031	Staple Tray Paper Sensor	ENG	[0 or 1 / 0 / 1/step]
031	Gets information of specified sensor. Displays signal level of sensor as it is.		
6-123-032	ITB Paper Sensor	ENG	[0 or 1 / 0 / 1/step]
032	Gets information of specified sensor. Displays signal level of sensor as it is.		
6-123-033	Booklet Stapler Transport Paper Sn: Upper	ENG	[0 or 1 / 0 / 1/step]
033	Gets information of specified sensor. Displays signal level of sensor as it is.		
6-123-034	Booklet Stapler Transport Paper Sn: Lower	ENG	[0 or 1 / 0 / 1/step]
034	Gets information of specified sensor. Displays signal level of sensor as it is.		
6-123-035	Paper Height Sensor: Shift	ENG	[0 or 1 / 0 / 1/step]
035	Gets information of specified sensor. Displays signal level of sensor as it is.		
6-123-036	Corner Stapler Paper Height Sensor 1	ENG	[0 or 1 / 0 / 1/step]
036	Gets information of specified sensor. Displays signal level of sensor as it is.		
6-123-037	Corner Stapler Paper Height Sensor 2	ENG	[0 or 1 / 0 / 1/step]
037	Gets information of specified sensor. Displays signal level of sensor as it is.		
6-123-038	Proof Tray Full Sensor	ENG	[0 or 1 / 0 / 1/step]
038	Gets information of specified sensor. Displays signal level of sensor as it is.		
6-123-039	Booklet Stapler Full Sensor 1	ENG	[0 or 1 / 0 / 1/step]
039	Gets information of specified sensor. Displays signal level of sensor as it is.		
6-123-040	Booklet Stapler Full Sensor 2	ENG	[0 or 1 / 0 / 1/step]
040	Gets information of specified sensor. Displays signal level of sensor as it is.		
6-123-041	S-to-S Registration Detection Sensor	ENG	[0 or 1 / 0 / 1/step]
041	Gets information of specified sensor. Displays signal level of sensor as it is.		
6-123-042	Punch RPS Sensor	ENG	[0 or 1 / 0 / 1/step]
042	Gets information of specified sensor. Displays signal level of sensor as it is.		
6-123-043	Corner Stapler Leading Edge Detection Sensor	ENG	[0 or 1 / 0 / 1/step]
043	Gets information of specified sensor. Displays signal level of sensor as it is.		
6-123-044	Corner Stapler Staple End Sensor	ENG	[0 or 1 / 0 / 1/step]
044	Gets information of specified sensor. Displays signal level of sensor as it is.		
6-123-045	Booklet Stapler Staple End Sensor: Front	ENG	[0 or 1 / 0 / 1/step]
045	Gets information of specified sensor. Displays signal level of sensor as it is.		
6-123-046	Booklet Stapler Staple End Sensor: Rear	ENG	[0 or 1 / 0 / 1/step]
046	Gets information of specified sensor. Displays signal level of sensor as it is.		
6-123-047	Shift Tray Lower Limit Sensor 1	ENG	[0 or 1 / 0 / 1/step]
047	Gets information of specified sensor. Displays signal level of sensor as it is.		
6-123-	Shift Tray Lower Limit Sensor 2	ENG	[0 or 1 / 0 / 1/step]

3.SP Mode Tables

048	Gets information of specified sensor. Displays signal level of sensor as it is.		
6-123-049	Shift Tray Lower Limit Sensor 3	ENG	[0 or 1 / 0 / 1/step]
049	Gets information of specified sensor. Displays signal level of sensor as it is.		
6-123-050	Shift Tray Lower Limit Sensor 4	ENG	[0 or 1 / 0 / 1/step]
050	Gets information of specified sensor. Displays signal level of sensor as it is.		
6-123-051	Shift Tray Lower Limit Sensor 5	ENG	[0 or 1 / 0 / 1/step]
051	Gets information of specified sensor. Displays signal level of sensor as it is.		
6-123-052	Punch Chad Full Sensor	ENG	[0 or 1 / 0 / 1/step]
052	Gets information of specified sensor. Displays signal level of sensor as it is.		
6-123-053	Punch Set Detection	ENG	[0 or 1 / 0 / 1/step] 0: connected 1: not connected
	Gets connection status of punch unit.		
6-123-054	Shift Jogger Set Detection	ENG	[0 or 1 / 0 / 1/step] 0: connected 1: not connected
	Gets connection status of setting jogger unit. * Not used: this motor is not installed in this finisher.The optional jogger unit is required.		
6-123-055	Booklet Stapler Set Detection	ENG	[0 or 1 / 0 / 1/step] 0: not connected 1: connected
	Gets connection status of saddle stitch unit.		
6-123-056	Front Door SW	ENG	[0 or 1 / 0 / 1/step]
056	Gets information of specified switch. Displays signal level of switch as it is.		
6-123-057	Dynamic Roller Open/Close Guide Plate Sensor	ENG	[0 or 1 / 0 / 1/step]
057	Gets information of specified switch. Displays signal level of switch as it is.		
6-123-058	Tray Upper Limit SW	ENG	[0 or 1 / 0 / 1/step]
058	Gets information of specified switch. Displays signal level of switch as it is.		
6-123-059	Paper Exit Open/Close Guide Plate Limit SW	ENG	[0 or 1 / 0 / 1/step]
059	Gets information of specified switch. Displays signal level of switch as it is.		
6-123-060	Punch Selection DIPSW 1	ENG	[0 or 1 / 0 / 1/step]
060	Gets information of specified switch. Displays signal level of switch as it is.		
6-123-061	Punch Selection DIPSW 2	ENG	[0 or 1 / 0 / 1/step]
061	Gets information of specified switch. Displays signal level of switch as it is.		
6-123-065	Paper Guide HP Sensor	ENG	[0 or 1 / 0 / 1/step]
065	Gets information of specified switch. Displays signal level of switch as it is.		
6-123-	Shift Jogger HP Sensor: Front	ENG	[0 or 1 / 0 / 1/step]

066	Gets information of specified switch. Displays signal level of switch as it is.		
6-123-067	Shift Jogger HP Sensor: Rear	ENG	[0 or 1 / 0 / 1/step]
067	Gets information of specified switch. Displays signal level of switch as it is.		
6-123-068	Shift Jogger Retraction HP Sensor: Upper	ENG	[0 or 1 / 0 / 1/step]
068	Gets information of specified switch. Displays signal level of switch as it is.		
6-123-069	Shift Jogger Retraction HP Sensor: Lower	ENG	[0 or 1 / 0 / 1/step]
069	Gets information of specified switch. Displays signal level of switch as it is.		
6-123-070	TE Height Front Detection	ENG	[0 or 1 / 0 / 1/step]
070	Gets information of specified switch. Displays signal level of switch as it is.		
6-123-071	TE Height Rear Detection	ENG	[0 or 1 / 0 / 1/step]
071	Gets information of specified switch. Displays signal level of switch as it is.		

Booklet Finisher SR3270/Finisher SR3260

6161	[FIN (1K FIN) INPUT Check]		
	Gets information of specified sensor. Displays signal level of sensor as it is.		
6-161-001	Entrance Sensor	ENG	[0 or 1 / 0 / 1/step]
6-161-002	Upper Cover Open/Close Sensor	ENG	[0 or 1 / 0 / 1/step]
6-161-003	Proof Tray Exit Sensor	ENG	[0 or 1 / 0 / 1/step]
6-161-004	Proof Tray Full Sensor	ENG	[0 or 1 / 0 / 1/step]
6-161-005	Shift HP Sensor	ENG	[0 or 1 / 0 / 1/step]
6-161-006	Exit Guide Plate Open/Close HP Sensor	ENG	[0 or 1 / 0 / 1/step]
6-161-007	Shift Paper Exit (Lift Tray Exit) Sensor	ENG	[0 or 1 / 0 / 1/step]
6-161-008	Positioning Roller HP Sensor	ENG	[0 or 1 / 0 / 1/step]
6-161-009	Lift Tray Paper Sensor	ENG	[0 or 1 / 0 / 1/step]
6-161-010	Jogger HP Sensor	ENG	[0 or 1 / 0 / 1/step]
6-161-011	Feed Out HP Sensor	ENG	[0 or 1 / 0 / 1/step]
6-161-012	Lift Tray Lower Limit Sensor (Upper)	ENG	[0 or 1 / 0 / 1/step]
6-161-013	Lift Tray Lower Limit Sensor (Lower)	ENG	[0 or 1 / 0 / 1/step]
6-161-014	Staple Tray Paper Sensor	ENG	[0 or 1 / 0 / 1/step]
6-161-015	Stapler Moving HP Sensor	ENG	[0 or 1 / 0 / 1/step]
6-161-016	Near End Sensor (Common: Corner/Bklt Stplr)	ENG	[0 or 1 / 0 / 1/step]
6-161-017	Self Priming Sensor (Common:Cmr/Bklt Stplr)	ENG	[0 or 1 / 0 / 1/step]
6-161-018	Driver HP Sensor (Corner/Booklet Stapler)	ENG	[0 or 1 / 0 / 1/step]
6-161-020	Clincher HP Sensor (Corner/Booklet Stapler)	ENG	[0 or 1 / 0 / 1/step]
6-161-022	Stapler Retraction Sensor	ENG	[0 or 1 / 0 / 1/step]
6-161-023	Untitled	ENG	[0 or 1 / 0 / 1/step]
6-161-024	Untitled	ENG	[0 or 1 / 0 / 1/step]

3.SP Mode Tables

6-161-025	Untitled	ENG	[0 or 1 / 0 / 1/step]
6-161-026	Punch HP Sensor	ENG	[0 or 1 / 0 / 1/step]
6-161-028	Punch Hopper Full Sensor	ENG	[0 or 1 / 0 / 1/step]
6-161-029	Punch Move HP Sensor	ENG	[0 or 1 / 0 / 1/step]
6-161-030	S-to-S Registration Detection HP Sensor	ENG	[0 or 1 / 0 / 1/step]
6-161-031	S-to-S Registration Detection Sensor	ENG	[0 or 1 / 0 / 1/step]
6161	[FIN (1K FIN) INPUT Check]		
	Gets information of specified switch. Displays signal level of switch as it is.		
6-161-032	Punch Selection DIPSW 1	ENG	[0 or 1 / 0 / 1/step]
6-161-033	Punch Selection DIPSW 2	ENG	[0 or 1 / 0 / 1/step]
6161	[FIN (1K FIN) INPUT Check]		
	Gets information of specified sensor. Displays signal level of sensor as it is.		
6-161-034	ITB Transport Sensor: Right	ENG	[0 or 1 / 0 / 1/step]
6-161-035	ITB Transport Sensor: Left	ENG	[0 or 1 / 0 / 1/step]
6-161-036	Stack Transport Sensor	ENG	[0 or 1 / 0 / 1/step]
6-161-037	Stack Trans Upper Pressure Release HP Sensor	ENG	[0 or 1 / 0 / 1/step]
6-161-038	Stack Trans Lower Pressure Release HP Sensor	ENG	[0 or 1 / 0 / 1/step]
6-161-039	Fold Blade HP Sensor	ENG	[0 or 1 / 0 / 1/step]
6-161-040	Fold Cam HP Sensor	ENG	[0 or 1 / 0 / 1/step]
6-161-041	TE Stopper Transport Sensor	ENG	[0 or 1 / 0 / 1/step]
6-161-042	TE Stopper HP Sensor	ENG	[0 or 1 / 0 / 1/step]
6-161-043	Booklet Folder Exit Sensor	ENG	[0 or 1 / 0 / 1/step]
6-161-044	Booklet Folder Tray Full Sensor: Upper	ENG	[0 or 1 / 0 / 1/step]
6-161-045	Booklet Folder Tray Full Sensor: Lower	ENG	[0 or 1 / 0 / 1/step]
6161	[FIN (1K FIN) INPUT Check]		
	Gets information of specified switch. Displays signal level of switch as it is.		
6-161-046	Door Open/Close SW	ENG	[0 or 1 / 0 / 1/step]
6-161-047	Lift Tray Upper Limit SW	ENG	[0 or 1 / 0 / 1/step]
6161	[FIN (1K FIN) INPUT Check]		
	Gets information of specified sensor. Displays signal level of sensor as it is.		
6-161-048	Paper Guide HP Sensor	ENG	[0 or 1 / 0 / 1/step]

Internal Finisher SR3250

6135	[INPUT Check: FrontFIN]		
	Gets information of specified sensor. Displays signal level of sensor as it is.		
6-135-001	Entrance Sensor	*ENG	[0 or 1 / 0 / 1/step]
6-135-002	Carry Sensor	*ENG	[0 or 1 / 0 / 1/step]
6-135-003	Exit Sensor	*ENG	[0 or 1 / 0 / 1/step]

6-135-004	Staple Tray Paper Sensor	*ENG	[0 or 1 / 0 / 1/step]
6-135-005	Front Jogger HP Sensor	*ENG	[0 or 1 / 0 / 1/step]
6-135-006	Rear Jogger HP Sensor	*ENG	[0 or 1 / 0 / 1/step]
6-135-007	Sft Roller HP Sensor	*ENG	[0 or 1 / 0 / 1/step]
6-135-008	Hitroll HP Sensor	*ENG	[0 or 1 / 0 / 1/step]
6-135-009	Ext Guide Plate HP Sensor	*ENG	[0 or 1 / 0 / 1/step]
6-135-010	Staple Moving HP Sensor	ENG	[0 or 1 / 0 / 1/step]
6-135-011	Shift Tray Paper Sensor	ENG	[0 or 1 / 0 / 1/step]
6-135-012	Shift Tray Limit Sensor	ENG	[0 or 1 / 0 / 1/step]
6-135-013	Staple Rotation Sensor	ENG	[0 or 1 / 0 / 1/step]
6-135-014	Staple Near End Sensor	ENG	[0 or 1 / 0 / 1/step]
6-135-015	Self Priming Sensor	ENG	[0 or 1 / 0 / 1/step]
6-135-016	Stopper HP Sensor	ENG	[0 or 1 / 0 / 1/step]
6-135-017	Punch HP Sensor	ENG	[0 or 1 / 0 / 1/step]
6-135-018	Punch Pluse Count Sensor	ENG	[0 or 1 / 0 / 1/step]
6-135-019	Punch Chad Full Sensor	ENG	[0 or 1 / 0 / 1/step]
6-135-020	Punch Moving HP Sensor	ENG	[0 or 1 / 0 / 1/step]
6-135-021	Punch Registration Detection HP Sensor	ENG	[0 or 1 / 0 / 1/step]
6-135-022	Punch Registration Detection Sensor	ENG	[0 or 1 / 0 / 1/step]
6135	[INPUT Check: FrontFIN]		
	Gets information of specified switch. Displays signal level of switch as it is.		
6-135-023	Slide Door SW	ENG	[0 or 1 / 0 / 1/step]
6-135-024	Shift Tray Upper Limit SW	ENG	[0 or 1 / 0 / 1/step]
6-135-025	Hopper Cover Sensor	ENG	[0 or 1 / 0 / 1/step]
6-135-026	Punch Front Sensor	ENG	[0 or 1 / 0 / 1/step]

Internal Finisher SR3300

6184	[Input Check: NoStpIBindFIN]		
6-184-001	Entrance Sensor	ENG	[0 or 1 / 0 / 1/step]
	Gets the entrance sensor information of non staple finisher. (0: Sensor Off, 1: Sensor On)		
6-184-002	Exit Sensor	ENG	[0 or 1 / 0 / 1/step]
	Gets the paper exit sensor information of non staple finisher. (0: Sensor Off, 1: Sensor On)		
6-184-003	Horizontal Registration Detection Sensor	ENG	[0 or 1 / 0 / 1/step]
	Gets the horizontal registration sensor information of non staple finisher. (0: Sensor Off, 1: Sensor On)		
6-184-	Shift HP Sensor	ENG	[0 or 1 / 0 / 1/step]

3.SP Mode Tables

004	Gets the shift HP sensor information of non staple finisher. (0: Sensor Off, 1: Sensor On)		
6-184-005	Junction Solenoid HP Sensor	ENG	[0 or 1 / 0 / 1/step]
	Gets the junction solenoid HP sensor information of non staple finisher. (0: Sensor Off, 1: Sensor On, "0" appears if sensor detects home position)		
6-184-006	Exit Pressure Release HP Sensor	ENG	[0 or 1 / 0 / 1/step]
	Gets the exit pressure release HP sensor information of non staple finisher. (0: Sensor Off, 1: Sensor On)		
6-184-007	Stapler HP Sensor	ENG	[0 or 1 / 0 / 1/step]
	Gets the stapler HP sensor information of non staple finisher. (0: Sensor On, "0" appears if sensor detects home position)		
6-184-008	Tray Full Detection Sensor 1	ENG	[0 or 1 / 0 / 1/step]
	Gets the tray full detection sensor 1 information of non staple finisher. (0: Paper overflow)		
6-184-009	Tray Full Detection Sensor 2	ENG	[0 or 1 / 0 / 1/step]
	Gets the tray full detection sensor 2 information of non staple finisher. (0: Paper overflow)		
6-184-010	Slide Door Open/Close Door SW	ENG	[0 or 1 / 0 / 1/step]
	Gets the slide door switch information of non staple finisher. (0: Close, 1: Open)		

Internal Multi-Fold Unit

6322	[INPUT Check]		
6-322-001	Registration Sensor	ENG	[0 to 1 / 0 / 1] 0: Paper 1: No paper
6-322-002	Folding Junction HP Sensor	ENG	[0 to 1 / 0 / 1] 0: Not HP 1: HP
6-322-003	1st 2-direction Paper Feed SN	ENG	[0 to 1 / 0 / 1] 0: Paper 1: No paper
6-322-004	2nd 2-direction Paper Feed SN	ENG	[0 to 1 / 0 / 1] 0: Paper 1: No paper
6-322-005	Crease Sensor	ENG	[0 to 1 / 0 / 1] 0: Paper 1: No paper

6322	[INPUT Check]		
6-322-006	Crease HP Sensor	ENG	[0 to 1 / 0 / 1] 0: Not HP 1: HP
6-322-007	Top Tray Exit Sensor	ENG	[0 to 1 / 0 / 1] 0: Paper 1: No paper
6-322-008	Top Tray Full Sensor 1	ENG	[0 to 1 / 0 / 1] 0: Full 1: Not full
6-322-009	Top Tray Full Sensor 2	ENG	[0 to 1 / 0 / 1] 0: Not full 1: Full
6-322-010	Bridge Exit	ENG	[0 to 1 / 0 / 1] 0: Paper 1: No paper
6-322-011	Cover SW	ENG	[0 to 1 / 0 / 1] 0: Closed 1: Open
6-322-012	Exit Unit Open/Close SW	ENG	[0 to 1 / 0 / 1] 0: Closed 1: Open

Output Check Table

Main Machine, Paper Feed Tray

5804	[OUTPUT Check]		
5-804-001	Feed Pickup Solenoid 1 Moves 1st paper feed tray pick up solenoid.	ENG	[OFF/ON]
5-804-002	Feed Pickup Solenoid 2 Moves 2nd paper feed tray pick up solenoid.	ENG	[OFF/ON]
5-804-003	Bypass Pickup Solenoid Moves bypass pick up solenoid.	ENG	[OFF/ON]
5-804-004	Exit Junction Solenoid Moves output paper divide solenoid.	ENG	[OFF/ON]
5804	[OUTPUT Check]		
	Moves paper feed tray rising motor. * Do not execute SP 5-804-006/008 without removing the paper tray. Otherwise, the tray		

3.SP Mode Tables

	might be damaged.		
5-804-005	Tray 1 Lift Motor: CW	ENG	[OFF/ON]
5-804-006	Tray 1 Lift Motor: CCW	ENG	
5-804-007	Tray 2 Lift Motor: CW	ENG	
5-804-008	Tray 2 Lift Motor: CCW	ENG	
5804	[OUTPUT Check]		
	Moves register motor.		
5-804-009	Regist Motor: CCW: Standard Speed	ENG	[OFF/ON]
5-804-010	Regist Motor: CCW: Middle Speed *C6000/C5500/C4500 only	ENG	
5-804-011	Regist Motor: CCW: Low Speed	ENG	
5804	[OUTPUT Check]		
5-804-015	Regist Motor: Position Hold	ENG	[OFF/ON]
	Holds position of register motor.		
5804	[OUTPUT Check]		
	Moves paper feed motor. * It is fed if there is paper in the paper tray.		
5-804-016	Feed Motor: CW: Standard Speed	ENG	[OFF/ON]
5-804-017	Feed Motor: CW: Middle Speed	ENG	
5-804-018	Feed Motor: CW: Low Speed	ENG	
5-804-022	Feed Motor: CCW: Standard Speed	ENG	
5-804-023	Feed Motor: CCW: Middle Speed *C6000/C5500/C4500 only	ENG	
5-804-024	Feed Motor: CCW: Low Speed	ENG	
5804	[OUTPUT Check]		
	Moves vertical carry motor.		
5-804-	Bypass V-Transport Motor: CW: Std Speed	ENG	[OFF/ON]

028			
5-804-029	Bypass V-Transport Motor: CW: Middle Speed *C6000/C5500/C4500 only	ENG	
5-804-030	Bypass V-Transport Motor: CW: Low Speed	ENG	
5804	[OUTPUT Check]		
5-804-034	Bypass V-Transport Motor: Position Hold Holds position of vertical carry motor.	ENG	[OFF/ON]
5-804-037	Exit Motor: CW: Fusing Pressure Release Moves fusing dis-pressure. * If driving this motor while attaching the fusing unit, be sure to stop it less than 5 seconds. Otherwise, the unit might be damaged.	ENG	[OFF/ON]
5804	[OUTPUT Check] Moves paper exit motor.		
5-804-041	Exit Motor: CCW: Standard Speed	ENG	[OFF/ON]
5-804-042	Exit Motor: CCW: Middle Speed *C6000/C5500/C4500 only	ENG	
5-804-043	Exit Motor: CCW: Low Speed	ENG	
5804	[OUTPUT Check] Moves reverse motor.		
5-804-047	Inverter Motor: CW: Standard Speed	ENG	[OFF/ON]
5-804-048	Inverter Motor: CW: Middle Speed *C6000/C5500/C4500 only	ENG	
5-804-049	Inverter Motor: CW: Low Speed	ENG	
5-804-052	Inverter Mt: CW: Normal Speed: Duplex	ENG	
5-804-054	Inverter Mt: CW: Low Speed: Duplex	ENG	
5-804-056	Inverter Motor: CCW: Standard Speed	ENG	
5-804-057	Inverter Motor: CCW: Middle Speed *C6000/C5500/C4500 only	ENG	
5-804-058	Inverter Motor: CCW: Low Speed	ENG	

3.SP Mode Tables

5-804-061	Inverter Mt: CCW: Normal Speed: Inc Speed	ENG		
5804	[OUTPUT Check]			
	Moves duplex entrance motor.			
5-804-065	Duplex Entrance Motor: CW: Standard Speed	ENG	[OFF/ON]	
5-804-066	Duplex Entrance Motor: CW: Middle Speed *C6000/C5500/C4500 only	ENG		
5-804-067	Duplex Entrance Motor: CW: Low Speed	ENG		
5-804-068	Duplex Entrance Motor: Normal Speed: Duplex	ENG		
5-804-069	Duplex Entrance Motor: Low Speed: Duplex	ENG		
5804	[OUTPUT Check]			
	Moves duplex bypass motor.			
5-804-071	Duplex Bypass Motor: CW: Standard Speed	ENG	[OFF/ON]	
5-804-072	Duplex Bypass Motor: CW: Middle Speed *C6000/C5500/C4500 only	ENG		
5-804-073	Duplex Bypass Motor: CW: Low Speed	ENG		
5-804-074	Duplex Bypass Motor: CW: Normal Speed: Dup	ENG		
5-804-075	Duplex Bypass Motor: CW: Low Speed: Duplex	ENG		
5-804-077	Duplex Bypass Motor: CCW: Standard Speed	ENG		
5-804-078	Duplex Bypass Motor: CCW: Middle Speed *C6000/C5500/C4500 only	ENG		
5-804-079	Duplex Bypass Motor: CCW: Low Speed	ENG		
5804	[OUTPUT Check]			
5-804-083	Duplex Bypass Motor: Position Hold	ENG		[OFF/ON]
	Holds position of duplex bypass motor.			
5804	[OUTPUT Check]			
	Moves fusing motor. *See Important below			
5-804-	Fusing Motor: CW: Standard Speed	ENG	[OFF/ON]	

092			
5-804-093	Fusing Motor: CW: Middle Speed *C6000/C5500/C4500 only	ENG	
5-804-094	Fusing Motor: CW: Low Speed	ENG	
5-804-098	Fusing Motor: CCW: Low Speed	ENG	
<p>Important: Use the procedure below to do the output checks for the fusing exit motor. If you do not follow this procedure, a kink will form in the fusing belt sleeve, and the fusing sleeve belt unit will need to be replaced.</p> <p>1. Do one of the following:</p> <ul style="list-style-type: none"> • Open the right cover of the paper bank • Remove one of the toner bottles • Pull out the waste toner bottle half-way • Remove the fusing unit <p>2. Enter SP mode.</p> <p>3. Do the following output checks:</p> <ul style="list-style-type: none"> • SP5-804-092 (Fusing Motor: CW: Standard Speed) • SP5-804-093 (Fusing Motor: CW: Middle Speed) • SP5-804-094 (Fusing Motor: CW: Low Speed) • SP5-804-098 (Fusing Motor: CCW: Low Speed) <p>4. Without exiting SP mode, turn the main power switch off and then on again.</p> <p>Important: If you exit SP mode before you turn the main power switch off, the fusing exit motor will stay off when the machine warms up. Heat will be concentrated in one area of the fusing belt sleeve and cause a kink to form. If this happens, you will need to replace the fusing sleeve belt unit.</p> <p>5. Do the reverse of what you did in step 1 (for example, reattach the fusing unit).</p>			
5-804-102	PCB Box Cooling Fan Moves PCB box cooling fan.	ENG	[OFF/ON]
5-804-103	PCB Box Cooling Fan: Half Speed Moves PCB box cooling fan.	ENG	[OFF/ON]
5804	[OUTPUT Check]		
5-804-104	Polygon Motor: L Runs motor with 21969 rpm.	ENG	[OFF/ON]
5-804-105	Polygon Motor: M Runs motor with 25512 rpm.	ENG	[OFF/ON]
5-804-106	Polygon Motor: H Runs motor with 30236 rpm.	ENG	[OFF/ON]
5-804-	Polygon Motor: HH	ENG	[OFF/ON]

3.SP Mode Tables

107	Runs motor with 34488 rpm.		
5-804-109	ExhaustCooling Fan: Half Speed	ENG	[OFF/ON]
	Moves exhaust cooling fan.		
5-804-110	Fusing Fan: Full Speed	ENG	[OFF/ON]
	Moves fusing exhaust heat fan.		
5-804-111	Fusing Fan: Half Speed	ENG	[OFF/ON]
	Moves fusing exhaust heat fan.		
5-804-112	PSU Coolingt Fan: Half Speed	ENG	[OFF/ON]
	Moves PSU cooling fan.		
5-804-113	PSU Coolingt Fan	ENG	[OFF/ON]
	Moves PSU cooling fan.		
5-804-114	Ozone Fan	ENG	[OFF/ON]
	Moves ozone exhaust heat fan.		
5-804-115	Exhaust Cooling Fan	ENG	[OFF/ON]
	Moves exhaust cooling fan.		
5-804-116	Development: Right: Half Speed	ENG	[OFF/ON]
	Moves development intake fan.		
5-804-117	Drive Cooling/ Main/ Toner Supply Cooling Fan	ENG	[OFF/ON]
	Moves drive cooling fan (not included in this machine), main exhaust fan (not included in this machine), and toner supply cooling fan.		
5-804-118	Development: Right	ENG	[OFF/ON]
	Moves development intake fan.		
5-804-119	Development Solenoid	ENG	[OFF/ON]
	Moves development solenoid. *C3500/C3000/C2500/C2000 only		
5804	[OUTPUT Check]		
	Moves develop motor.		
5-804-120	Development Motor K: Standard Speed *C6000/C5500/C4500 only	ENG	[OFF/ON]
5-804-121	Development Motor K: Middle Speed *C6000/C5500/C4500 only	ENG	
5-804-122	Development Motor K: Low Speed *C6000/C5500/C4500 only	ENG	
5-804-128	Development Motor FC: Standard Speed	ENG	
5-804-	Development Motor FC: Middle Speed	ENG	

129	*C6000/C5500/C4500 only		
5-804-130	Development Motor FC: Low Speed	ENG	
5804	[OUTPUT Check]		
	Moves/Stops drum motor FC. * Execute this SP after correcting the cam position so that ITB contact/separation lever of the color station is released.		
5-804-132	Drum Motor FC: Standard Speed	ENG	[OFF/ON]
5-804-133	Drum Motor FC: Middle Speed *C6000/C5500/C4500 only	ENG	
5-804-134	Drum Motor FC: Low Speed	ENG	
5804	[OUTPUT Check]		
	Moves/Stops transfer drum motor K. * Execute this SP after correcting the cam position so that ITB contact/separation lever of the color station is released.		
5-804-136	Transfer Drum Motor K: Standard Speed	ENG	[OFF/ON]
5-804-137	Transfer Drum Motor K: Middle Speed *C6000/C5500/C4500 only	ENG	
5-804-138	Transfer Drum Motor K: Low Speed	ENG	
5804	[OUTPUT Check]		
	Moves paper transfer divide motor.		
5-804-140	PTR Contact Motor: CW	ENG	[OFF/ON]
5-804-141	PTR Contact Motor: CCW	ENG	
5804	[OUTPUT Check]		
	Moves image transfer divide motor (reverse to toner supply motor M). * Execute this SP after correcting the cam position so that ITB contact/separation lever of the color station is released.		
5-804-150	Toner Supply Motor M: CW:(ITB Contact)	ENG	[OFF/ON]
5804	[OUTPUT Check]		
	Moves relay carry motor (bridge unit)/left paper exit carry motor (left paper exit tray).		
5-804-	Bridge Relay/Left Exit Motor: Normal Speed	ENG	[OFF/ON]

3.SP Mode Tables

163			
5-804-164	Bridge Relay/Left Exit Motor: Middle Speed *C6000/C5500/C4500 only	ENG	
5-804-165	Bridge Relay/Left Exit Motor: Low Speed	ENG	
5-804-166	Bridge Relay/Left Ex Mt: Normal Speed Upper	ENG	
5804	[OUTPUT Check]		
5-804-169	Bridge Junction/Left Exit Junction Solenoid Moves relay divide solenoid (bridge unit)/left paper exit divide solenoid (left paper exit tray).	ENG	[OFF/ON]
5-804-170	Shift Tray Motor: CW Moves shift tray motor.	ENG	[OFF/ON]
5-804-171	Shift Tray Motor: CCW Moves shift tray motor.	ENG	[OFF/ON]
5-804-172	Toner End Sensor: K Power Supples power to toner end sensor (K).	ENG	[OFF/ON]
5-804-174	Drum PCL: K Lights (PWM drive) the drum PCL (K). * Continuing the OPC's exposure, it might accumulate damage due to electrostatic locally. • If operating QL without rotation, be sure to stop it within 10 seconds. • Do rotate the OPC drum when QL is turned on. *C2500/C2000 only	ENG	[OFF/ON]
5-804-175	Drum PCL: FC Lights (PWM drive) the drum PCL (FC). * Continuing the OPC's exposure, it might accumulate damage due to electrostatic locally. • If operating QL without rotation, be sure to stop it within 10 seconds. • Do rotate the OPC drum when QL is turned on. *C2500/C2000 only	ENG	[OFF/ON]
5804	[OUTPUT Check] Outputs PWM for electrify HVP (DC/AC:Y/M/C/K). If you enable this SP when the drum is suspended, the drum surface picks up a static charge, resulting in horizontal banding. It is recommended to enable this SP with the PCDU removed.If enabling this SP with the PCDU installed, be sure to enable it only for a short time and check that image quality degradation does not occurred after that. If horizontal banding occurs, it is resolved by printing and then leaving the machine idle for a while. If the problem persists, replace the PCU.		
5-804-	PP: Charge DC: Y	ENG	[OFF/ON]

176			
5-804-177	PP: Charge DC: M	ENG	
5-804-178	PP: Charge DC: C	ENG	
5-804-179	PP: Charge DC: K	ENG	
5-804-180	PP: Charge AC: Y	ENG	
5-804-181	PP: Charge AC: M	ENG	
5-804-182	PP: Charge AC: C	ENG	
5-804-183	PP: Charge AC: K	ENG	
5804	[OUTPUT Check]		
	<p>Outputs PWM for develop HVP.</p> <p>If you enable this SP when the drum is suspended, the drum surface picks up a static charge, resulting in horizontal banding on printed image or adhesion of carrier to the drum surface. It is recommended to enable this SP with the PCDU removed.</p>		
5-804-184	PP: Development: Y	ENG	[OFF/ON]
5-804-185	PP: Development: M	ENG	
5-804-186	PP: Development: C	ENG	
5-804-187	PP: Development: K	ENG	
5804	[OUTPUT Check]		
	<p>Outputs PWM for transfer HVP (image transfer: Y/M/C/K).</p> <p>The image transfer bias involves constant current control, so if you enable this SP when the image transfer belt is not operating or not installed, there is a risk of HVP error. When enabling this SP, it is recommended to keep its operation time within 2 seconds.</p>		
5-804-195	PP: ITB: Y	ENG	[OFF/ON]
5-804-196	PP: ITB: M	ENG	
5-804-	PP: ITB: C	ENG	

3.SP Mode Tables

197			
5-804-198	PP: ITB: K	ENG	
5804	[OUTPUT Check]		
	Outputs PWM for transfer HVP (paper transfer: +/-).		
5-804-199	PP: PTR: +	ENG	[OFF/ON]
5-804-200	PP: PTR: -	ENG	
5804	[OUTPUT Check]		
5-804-202	Scanner Lamp	ENG	[OFF/ON]
	Checks output of scanner lamp. Use to check light source malfunction when SC101-01, SC101-02, SC102-00, SC142-00 occurs.		
5-804-206	PTR Open/Close LED	ENG	[OFF/ON]
	Lights paper transfer open/close LED.		
5-804-208	TM/P Sensor: F	ENG	[OFF/ON]
	Lights TM/P sensor: Front glowing part.		
5-804-209	TM/P Sensor: C	ENG	[OFF/ON]
	Lights TM/P sensor: Center glowing part.		
5-804-210	TM/P Sensor: R	ENG	[OFF/ON]
	Lights TM/P sensor: Rear glowing part.		
5-804-211	Toner Sensor Power	ENG	[OFF/ON]
5-804-232	Toner IDTAG Power	ENG	[OFF/ON]
5804	[OUTPUT Check]		
5-804-235	Fusing Shading Plate M: CW	ENG	[OFF/ON]
	<p>Moves shade plate of fusing Md to CW direction.</p> <p>* Execute this SP after removing the fusing unit.</p> <p>Continuing to turn the fusing shield drive motor while attaching the fusing unit, the units may be damaged.</p> <p>Procedure:</p> <ol style="list-style-type: none"> 1. Remove the fusing unit. 2. Remove the waste tonner bottle. 3. Execute this SP. <p>*C6000/C5500/C4500 only</p>		
5-804-	Fusing Shading Plate M: CCW	ENG	[OFF/ON]

236	<p>Moves shade plate of fusing Md to CCW direction.</p> <p>* Execute this SP after removing the fusing unit.</p> <p>Continuing to turn the fusing shield drive motor while attaching the fusing unit, the units may be damaged.</p> <p>Procedure:</p> <ol style="list-style-type: none"> 1. Remove the fusing unit. 2. Remove the waste tonner bottle. 3. Execute this SP. <p>*C6000/C5500/C4500 only</p>		
5-804-239	Fusing Exit Drive Solenoid	ENG	[OFF/ON]
5804	[OUTPUT Check]		
	Continuously drives specified motor for operation test.		
5-804-241	Bank: Tray3: Feed Mt: Standard Speed	ENG	[OFF/ON]
5-804-242	Bank: Tray4: Feed Mt: Standard Speed	ENG	
5-804-243	Bank: Tray5: Feed Mt: Standard Speed	ENG	
5-804-244	Bank: Tray3: Transport Mt: Standard Speed	ENG	
5-804-245	Bank: Tray4: Transport Mt: Standard Speed	ENG	
5-804-246	Bank: Tray5: Transport Mt: Standard Speed	ENG	
5804	[OUTPUT Check]		
	Drives specified motor for a certain period of time to test operation.		
5-804-247	Bank: Tray3: PU Solenoid	ENG	[OFF/ON]
5-804-248	Bank: Tray4: PU Solenoid	ENG	
5-804-249	Bank: Tray5: PU Solenoid	ENG	

ARDF

6008	[ADF OUTPUT Check]		
	Checks operation of the load of ADF.		
6-008-003	Feed Motor Forward	ENG	[OFF/ON]

3.SP Mode Tables

	Rotates paper feed motor forward.		
6-008-004	Feed Motor Reverse	ENG	[OFF/ON]
	Rotates paper feed motor backward.		
6-008-005	Relay Motor Forward	ENG	[OFF/ON]
	Rotates carry motor forward.		
6-008-006	Relay Motor Reverse	ENG	[OFF/ON]
	Rotates carry motor backward.		
6-008-011	Inverter Solenoid	ENG	[OFF/ON]
	Interval drives reverse solenoid.		
6-008-012	Stamp	ENG	[OFF/ON]
	Interval drives DONE stamp.		
6-008-013	Fan Motor	ENG	[OFF/ON]
	Interval drives FAN motor.		
6-008-014	Feed Clutch	ENG	[OFF/ON]
	Interval drives paper feed clutch.		
6-008-015	Feed Solenoid	ENG	[OFF/ON]
	Interval drives paper feed solenoid.		

SPDF

6012	[1-Pass ADF OUTPUT Check]		
	For Single-Pass simultaneous duplex models only.		
6-012-001	Pick-Up Motor Forward	ENG	[OFF/ON]
	Forwardly rotates ADF pick up motor.		
6-012-003	Feed Motor Forward	ENG	[OFF/ON]
	Forwardly rotates ADF paper feed motor.		
6-012-005	Relay Motor Forward	ENG	[OFF/ON]
	Forwardly rotates ADF paper carry motor.		
6-012-009	Exit Motor Forward	ENG	[OFF/ON]
	Forwardly rotates ADF paper exit motor.		
6-012-010	Bottom Plate Motor For/Rev	ENG	[OFF/ON]
	Moves up/down the bottom plate by driving the ADF bottom plate motor forward, backward.		
6-012-012	Stamp	ENG	[OFF/ON]
	Stamps the DONE stamp.		
6-012-015	Pull-Out Motor Forward	ENG	[OFF/ON]
	Forwardly rotates ADF pull out motor.		

6-012-016	Middle Motor Forward	ENG	[OFF/ON]
	Forwardly rotates ADF middle motor.		

Booklet Finisher SR3290/Finisher SR3280

6124	[OUTPUT Check: 2K/3K FIN]		
6-124-001	Entrance Transport Motor	ENG	[OFF/ON]
	Drives specified motor for a certain period of time to test operation.		
6-124-002	Horizontal Transport Motor	ENG	[OFF/ON]
	Drives specified motor for a certain period of time to test operation.		
6-124-003	Pre-Stack Transport Motor	ENG	[OFF/ON]
	Drives specified motor for a certain period of time to test operation.		
6-124-004	ITB Transport Motor	ENG	[OFF/ON]
	Drives specified motor for a certain period of time to test operation.		
6-124-005	Paper Exit Motor	ENG	[OFF/ON]
	Drives specified motor for a certain period of time to test operation.		
6-124-006	Upper Junction Solenoid	ENG	[OFF/ON]
	Turns NO/OFF specified solenoid for validation.		
6-124-007	TE Stack Plate Motor	ENG	[OFF/ON]
	Drives specified motor for a certain period of time to test operation.		
6-124-008	Paper Exit Open/Close Guide Plate Motor	ENG	[OFF/ON]
	Drives specified motor for a certain period of time to test operation.		
6-124-009	Punching Motor	ENG	[OFF/ON]
	Drives specified motor for a certain period of time to test operation.		
6-124-010	Punch Move Motor	ENG	[OFF/ON]
	Drives specified motor for a certain period of time to test operation.		
6-124-011	S-to-S Registration Detection Move Motor	ENG	[OFF/ON]
	Drives specified motor for a certain period of time to test operation.		
6-124-012	Lower Junction Solenoid Motor	ENG	[OFF/ON]
	Drives specified motor for a certain period of time to test operation.		
6-124-013	Jogger Motor	ENG	[OFF/ON]
	Drives specified motor for a certain period of time to test operation.		
6-124-014	Positioning Roller Rotation Motor	ENG	[OFF/ON]
	Drives specified motor for a certain period of time to test operation.		
6-124-015	Feed-out Motor	ENG	[OFF/ON]
	Drives specified motor for a certain period of time to test operation.		
6-124-016	Booklet Stapler Move Motor	ENG	[OFF/ON]
	Drives specified motor for a certain period of time to test operation.		
6-124-	Corner Stapler Motor	ENG	[OFF/ON]

3.SP Mode Tables

017	Drives specified motor for a certain period of time to test operation.		
6-124-018	Booklet Stapler Jogger Motor	ENG	[OFF/ON]
018	Drives specified motor for a certain period of time to test operation.		
6-124-019	Booklet Stapler Jog Solenoid Move Motor	ENG	[OFF/ON]
019	Drives specified motor for a certain period of time to test operation.		
6-124-020	Booklet Stapler Standard Fence Motor	ENG	[OFF/ON]
020	Drives specified motor for a certain period of time to test operation.		
6-124-021	Booklet Stapler Motor	ENG	[OFF/ON]
021	Drives specified motor for a certain period of time to test operation.		
6-124-022	Dynamic Roller Transport Motor	ENG	[OFF/ON]
022	Drives specified motor for a certain period of time to test operation.		
6-124-023	Folder Transport Motor	ENG	[OFF/ON]
023	Drives specified motor for a certain period of time to test operation.		
6-124-025	Press-fold Motor	ENG	[OFF/ON]
025	Drives specified motor for a certain period of time to test operation.		
6-124-026	Tray Lift Motor	ENG	[OFF/ON]
026	Drives specified motor for a certain period of time to test operation.		
6-124-027	Shift Motor	ENG	[OFF/ON]
027	Drives specified motor for a certain period of time to test operation.		
6-124-028	Front Shift Jogger Motor	ENG	[OFF/ON]
028	Drives specified motor for a certain period of time to test operation. * Not used: this motor is not installed in this finisher.The optional jogger unit is required.		
6-124-029	Rear Shift Jogger Motor	ENG	[OFF/ON]
029	Drives specified motor for a certain period of time to test operation. * Not used: this motor is not installed in this finisher.The optional jogger unit is required.		
6-124-030	Shift Jogger Retraction Motor	ENG	[OFF/ON]
030	Drives specified motor for a certain period of time to test operation. * Not used: this motor is not installed in this finisher.The optional jogger unit is required.		
6-124-031	Drag Roller Vibrating Motor	ENG	[OFF/ON]
031	Drives specified motor for a certain period of time to test operation.		
6-124-032	LE Guide Motor	ENG	[OFF/ON]
032	Drives specified motor for a certain period of time to test operation.		
6-124-033	Navigation LED (All)	ENG	[OFF/ON]
033	Lights all guide LED.		
6-124-	Positioning Roller Transport Motor	ENG	[OFF/ON]

037	Drives specified motor for a certain period of time to test operation.		
6-124-	Paper Guide Motor	ENG	[OFF/ON]
038	Drives specified motor for a certain period of time to test operation.		

Booklet Finisher SR3270/Finisher SR3260

6162	[FIN (1K FIN) OUTPUT Check]		
	Continuously runs specified motor for operation test.		
6-162-001	Entrance Transport Motor	ENG	[OFF/ON]
6-162-002	Proof Transport Motor	ENG	[OFF/ON]
6-162-003	Paper Feed/Positioning & Move Roller Motor	ENG	[OFF/ON]
6162	[FIN (1K FIN) OUTPUT Check]		
	Drives specified motor for a certain period of time to test operation.		
6-162-004	Junction Solenoid	ENG	[OFF/ON]
6-162-005	Shift Motor	ENG	[OFF/ON]
6-162-006	Jogger Motor	ENG	[OFF/ON]
6-162-007	Exit Guide Plate Open/Close Motor	ENG	[OFF/ON]
6-162-008	Feed-out Motor	ENG	[OFF/ON]
6-162-009	Tray Lift Motor	ENG	[OFF/ON]
6-162-011	Positioning Roller Motor	ENG	[OFF/ON]
6-162-012	Stapler Shift Motor	ENG	[OFF/ON]
6-162-013	Stapler Motor	ENG	[OFF/ON]
6-162-014	Untitled	ENG	[OFF/ON]
6-162-015	Untitled	ENG	[OFF/ON]
6-162-016	Untitled	ENG	[OFF/ON]
6-162-017	Punch Motor	ENG	[OFF/ON]
6-162-018	Punch Move Motor	ENG	[OFF/ON]
6-162-019	S-to-S Registration Detection Move Motor	ENG	[OFF/ON]
6-162-020	Stack Transport Motor: Upper	ENG	[OFF/ON]
6-162-021	Stck Trns Uppr Prss Rls/Stndrd Fence Rtrct M	ENG	[OFF/ON]
6-162-022	Stack Lower Pressure Release Motor	ENG	[OFF/ON]
6162	[FIN (1K FIN) OUTPUT Check]		
	Continuously runs specified motor for operation test.		
6-162-023	Folder Transport Motor	ENG	[OFF/ON]
6162	[FIN (1K FIN) OUTPUT Check]		
	Drives specified motor for a certain period of time to test operation.		
6-162-024	TE Stopper Motor	ENG	[OFF/ON]
6-162-025	Folder Blade Motor	ENG	[OFF/ON]
6162	[FIN (1K FIN) OUTPUT Check]		

3.SP Mode Tables

	Lights all guide LED.		
6-162-026	Navigation LED (All)	ENG	[OFF/ON]

Internal Finisher SR3250

6136	[OUTPUT Check: FrontFIN]		
	Continuously drives specified motor for operation test.		
6-136-001	Entrance Motor	*ENG	[OFF/ON]
6-136-002	Carry Motor	ENG	[OFF/ON]
6-136-003	Exit Motor	ENG	[OFF/ON]
6136	[OUTPUT Check: FrontFIN]		
	Drives specified motor for a certain period of time to test operation.		
6-136-004	Front Jogger Motor	ENG	[OFF/ON]
6-136-005	Rear Jogger Motor	ENG	[OFF/ON]
6-136-006	Shift Motor	ENG	[OFF/ON]
6-136-007	Hitroll Motor	ENG	[OFF/ON]
6-136-008	Exit Guide Plate Motor	ENG	[OFF/ON]
6-136-009	Staple Moving Motor	ENG	[OFF/ON]
6-136-010	Tray Motor	ENG	[OFF/ON]
6-136-011	Staple Motor	ENG	[OFF/ON]
6-136-012	Stopper Motor	ENG	[OFF/ON]
6-136-013	Punch Motor	ENG	[OFF/ON]
6-136-014	Punch Moving Motor	ENG	[OFF/ON]
6-136-015	Punch Registration Moving Motor	ENG	[OFF/ON]

Internal Finisher SR3300

6185	[Output Check: NoStpIBindFIN]		
6-185-001	Transport Motor	ENG	[OFF/ON]
	Checks the transport motor's movement of non staple finisher.		
6-185-002	Shift Motor	ENG	[OFF/ON]
	Checks the shift motor's movement of non staple finisher.		
6-185-003	Junction Solenoid Motor	ENG	[OFF/ON]
	Checks the junction solenoid motor's movement of non staple finisher.		
6-185-004	Exit Pressure Release Motor	ENG	[OFF/ON]
	Checks the exit pressure release motor's movement of non staple finisher.		
6-185-005	Stapler Motor	ENG	[OFF/ON]

	Checks the stapler motor's movement of non staple finisher.
--	---

Internal Multi-Fold Unit

6323	[OUTPUT Check]		
6-323-001	Transport Motor	ENG	[OFF/ON]
6-323-002	Registration Motor	ENG	[OFF/ON]
6-323-003	Folding Motor	ENG	[OFF/ON]
6-323-004	2nd 2-direct Paper Feed Motor	ENG	[OFF/ON]
6-323-005	JG/Crease Motor	ENG	[OFF/ON]
6-323-006	Junction Solenoid	ENG	[OFF/ON]
6-323-007	Navigation LED (All)	ENG	[OFF/ON]

Printer Service Menu

SP1-XXX (Service Mode)

1001	[Bit Switch]		Values	
1-001-001	Bit Switch 1		0	1
	bit 0	DFU	-	-
	bit 1	sysName Value This BitSw can switch the value of the sysName of the standard MIB.	Model name (PnP name)	Hostname
	bit 2	DFU	-	-
	bit 3	I/O Timeout Enables/Disables MFP I/O Timeouts. If disabled, the MFP I/O Timeout setting will not be in effect. I/O Timeouts will never occur.	Enabled	Disabled
	bit 4	SD Card Save Mode This BitSw enables the SD card save mode setting menu to be displayed. After enabling this BitSw, the Card Save settings will appear under: "User Tools > Machine Features >Printer Features > List/Test print"	Disabled	Enabled
	bit 5	Paper Size Error Margin When a PS job is printed on a custom paper size, the job might not print because of a paper size mismatch caused by a calculation error. This BitSw can set the allowable margin of error value. Note:This is available for PS, PDF only.	±5pt	±10pt
	bit 6	Color Balance Switching 1 This BitSw can be used to restore the color balance to match that of Fuji-Xerox devices. Note: If both BitSw #2-0, BitSw #2-4 and BitSw #1-6 are configured to "1", the configuration of #2-0 will be given priority and the color balance of 09S and earlier models will be used.	Standard Color Balance	FX compatibility
	bit 7	Printable Area Frame Border Prints all RPCS and PCL jobs with a border around the	Disabled	Enabled

	printable area. Note:This is available for PCL, RPCS only.		
--	---	--	--

1001	[Bit Switch]	Values	
1-	Bit Switch 2	0	1
001- 002	bit Color Balance Switching 2 0 This BitSw can be used to restore the color balance to match 09S and earlier model deveices. Note: If both BitSw #2-0 and BitSw #2-4 are configured to "1", the configuration of #2-0 will be given priority and the color balance of 09S and earlier models will be used.	Standard Color Balance	Color balance of 09S and earlier models.
	bit 1 DFU	-	-
	bit Collation Type 2 The type of collation will be applied to a job when the job does not explicitly define a collation type. Note: If #5-0 is enabled, this BitSw has no effect.	Shift Collate	Normal Collate
	bit PDL Auto Switching 3 Enables/Disables the MFPs ability to switch the PDL processor when receiving a job which contains both PS andPCL5e/c.	Enabled	Disabled
	bit Color Balance Switching 3 4 This BitSw can be used to restore the color balance to match 09A and extended 09A model devices. Note: If both BitSw #2-0 and BitSw #2-4 are configured to "1", the configuration of #2-0 will be given priority and the color balance of 09S and earlier models will be used.	Standard Color Balance	Color balance of 09A and extended 09A models.
	bit 5 DFU	-	-
	bit 6 DFU	-	-
	bit 7 DFU	-	-

1001	[Bit Switch]	Values	
1-001-	Bit Switch 3	0	1

3.SP Mode Tables

003	bit 0	DFU	-	-
	bit 1	DFU	-	-
	bit 2	<p>Legacy HP Compatibility</p> <p>Uses the same left margin as older HP models such as HP4000/HP8000.</p> <p>This setting enables the starting position of the graphics in the job to be changed.</p> <p>If this BitSw is enabled, the left margin command of "<ESC>*r0A" will be conducted as "<ESC>*r1A".</p> <p>PCL command are bellow:</p> <ul style="list-style-type: none"> - <Esc> *r0A ->Start Graphics at X coordinate of Zero - <Esc> *r1A ->Start Graphics at Current Cursor  <ul style="list-style-type: none"> • This is available for PCL5e/c only. 	Disabled	Enabled
	bit 3	DFU	-	-
	bit 4	DFU	-	-
	bit 5	DFU	-	-
	bit 6	DFU	-	-
	bit 7	DFU	-	-

1001	[Bit Switch]	Values	
1-001-004	Bit Switch 4	0	1
bit 0	DFU	-	-
bit 1	DFU	-	-
bit 2	DFU	-	-
bit 3	<p>Paper Path for IPDS Simplex Pages</p> <p>This setting enables you to route the IPDS simplex job through the duplex unit.</p>	Simplex paper path	Duplex paper path

		<ul style="list-style-type: none"> When this BitSw is set to duplex paper path, the simplex page might be printed on the reverse side. 		
bit 4	DFU		-	-
bit 5	DFU		-	-
bit 6	DFU		-	-
bit 7	DFU		-	-

1001	[Bit Switch]	Values	
1-001-005	Bit Switch 5	0	1
bit 0	Display Finishing Settings If enabled, users will be able to configure the Collate Settings, Staple Settings, and Punch Settings from the operation panel. The available Settings will depend on the device and configured options. After enabling this BitSw, the settings will appear under: "User Tools > Machine Features >Printer Features > System"	Hide settings	Display settings
bit 1	Number of Copies with Paper Mismatch If a paper size or type mismatch occurs while printing multiple copies, only a single copy is output by default. Using this BitSw, the device can be configured to print all copies even if a paper mismatch occurs.	Print Single Copy	Print All Copies
bit 2	GPS Filter If the GPS Filter is disabled, SDK applications will not be able to alter the print data standard printer applications receive. Note: The main purpose of this BitSw is for troubleshooting the effects of SDK applications on data.	Enabled	Disabled
bit	PS Trigger for PDL Switching	Standard	Pattern1

3.SP Mode Tables

3	Specifying the auto detection algorithm for PS while switching the print language. If the Pattern1 is selected, "%%" is used as a printer system PS trigger.	pattern	
bit 4	Increase Max. Number of Stored Jobs. Changes the maximum number of jobs that can be stored on the HDD. The default (disabled) is 100. If this is enabled, the max. will be raised to 750 or 1000 depending on the model.	Disabled (100)	Enabled (XXX)
bit 5	DFU	-	-
bit 6	Change Imposition Specification This setting enables the specification for imposition such as page alignment and image rotation to be changed to the specification of old models when job orientation and paper size are mixed. The old models are below: - PCL: 04A and earlier models - PS/PDF/RPCS: 05S and earlier models - BMLinkS: 05A and earlier models IRIPS PS/PDF : - 09A and earlier models: Operation under current model specification is not supported (Operation with older specification is recommended) - 15S and later models: Operation under current model specification is supported.	Standard specification	Old model specification
bit 7	Paper Path for Letterhead Simplex Job This setting enables the simplex job to be routed through the duplex unit. Only affects jobs specified as letterhead.	Simplex paper path	Duplex paper path

1001	[Bit Switch]		
1-001-006	Bit Switch 6	0	1
	bit 0	DFU	-
	bit 1	DFU	-
	bit 2	DFU	-
	bit 3	DFU	-
	bit 4	DFU	-

	bit 5	DFU	-	-
	bit 6	DFU	-	-
	bit 7	DFU	-	-

1001	[Bit Switch]			
1-001-007	Bit Switch 7		0	1
	bit 0	DFU	-	-
	bit 1	DFU	-	-
	bit 2	DFU	-	-
	bit 3	DFU	-	-
	bit 4	DFU	-	-
	bit 5	DFU	-	-
	bit 6	DFU	-	-
	bit 7	DFU	-	-

1001	[Bit Switch]			
1-001-008	Bit Switch 8		0	1
	bit 0	DFU	-	-
	bit 1	DFU	-	-
	bit 2	DFU	-	-
	bit 3	BW Printing without the PJL Color Command "DATAMODE"	Disabled	Enabled
		This setting enables a job to be printed in BW without the PJL color command "DATAMODE". Note: Color jobs will not be printed without the PJL color command "DATAMODE". Note: This is available for PCL, PS only.		
	bit 4	DFU	-	-
	bit 5	DFU	-	-
bit 6	PJL/PDL Color Command Priority	PJL Priority	PDL Priority	
	This setting enables the priority of a PDL color command to be changed when a PJL color command is "@PJL RENDERMODE = GRAYSCALE" in a job.			

3.SP Mode Tables

		Note:This is available for PCL,RPCS,PS.		
	bit 7	DFU	-	-

1001	[Bit Switch]			
1-	Bit Switch 9		0	1
001- 009	bit 0	<p>PDL Auto Detection timeout of jobs submitted via USB or Parallel Port (IEEE 1284).</p> <p>To be used if PDL auto-detection fails. A failure of PDL autodetection doesn't necessarily mean that the job can't be printed. This bit switch tells the device whether to time-out immediately (default) upon failure or to wait 10 seconds.</p>	Disabled (Immediately)	Enabled (10 seconds)
	bit 1	DFU	-	-
	bit 2	<p>Job Cancel</p> <p>This setting enables it to be specified whether jobs will be cancelled after a jam occurs.</p> <p>Note: If this BitSw is enabled, printing under the following conditions might result in problems:</p> <ul style="list-style-type: none"> - Job submission via USB or Parallel Port - Spool printing (WIM >Configuration > Device Settings > System) - Printing a large number of jobs continuously (The status of the job are not acquired when jobs exceeding the number guaranteed by the job monitor are continuously printed.) 	Not cancelled	Cancelled
	bit 3	DFU	-	-
	bit 4	<p>Timing of the PJL Status ReadBack (JOB END) when printing multiple collated copies.</p> <p>This BitSw determines the timing of the PJL STATUS JOB END sent when multiple collated copies are being printed.</p> <p>Mode 0: JOB END is sent by the device to the client after the first copy has completed printing. This causes the page counter to be incremented after the first copy and then again at the end of the job.</p> <p>Mode 1: JOB END is sent by the device to the client after</p>	Mode 0	Mode 1

		the last copy has finished printing. This causes the page counter to be incremented at the end of each job.		
bit	UTF-8 Mode	<p>Enabled (=0): Text composed of UTF-8 characters can be displayed in the operation panel.</p> <p>Disabled (=1): UTF-8 characters cannot be displayed in the operation panel.</p> <p>For example, job names are sometimes stored in the MIB using UTF-8 encoded characters. When these are displayed on the operation panel, they will be garbled unless this BitSw is enabled (=0).</p>	Enabled	Disabled
5				
bit	Print Option Configuration (rsh, rcp, ftp)	This BitSw enables the specification of the configuration of the print option using rcp/rsh/ftp.	Enabled	Disabled
6				
bit	Enable/Disable Print from USB/SD's Preview function	<p>Determines whether the Print from USB/SD function will have the Preview function.</p> <p>Enabled (=0): Print from USB/SD will have the Preview function.</p> <p>Disabled (=1): Print from USB/SD will not have the Preview function.</p>	Enabled	Disabled
7				

1001	[Bit Switch]			
1-	Bit Switch A		0	1
001-010	bit	DFU	-	-
	0			
	bit	DFU	-	-
	1			
	bit	DFU	-	-
	2			
	bit	DFU	-	-
	3			
	bit	DFU	-	-
	4			
	bit	Store and Skip Error Job locks the queue	Queue is not locked after	Queue locked after
	5	If this is 1, then after a job is stored using Store and		

3.SP Mode Tables

		Skip error Job (SSEJ), new jobs cannot be added to the queue until the stored job has been completely printed.	SSEJ	SSEJ
bit 6	Allow use of Store and Skip error Job if connected to an external charge device.		Does not allow SSEJ with ECD	Allows SSEJ with ECD
	If this is 0, Store and Skip error Job (SSEJ) will be automatically disabled if an external charge device is connected. Note: We do not officially support enabling this bitsw (1). Use it at your own risk.			
bit 7	Job cancels remaining pages when the paid-for pages have been printed on an external charge device		Job does not cancel	Job cancels
	When setting 1 is enabled, after printing the paid-for pages on an external charge device, the job that includes any remaining pages will be canceled. This setting will prevent the next user from printing the unnecessary pages from the previous user's print job.			

1001	[Bit Switch]				
1-	Bit Switch B		0	1	
001- 011	bit 0	DFU	-	-	
	bit 1	DFU	-	-	
	bit 2	Limitless Paper Feeding for the Bypass Tray When the Bypass Tray is the target of the "Auto Tray Select", and "Machine Setting(s): Any Type" is configured for the "Tray Setting Priority" of the Bypass Tray, this BitSw can switch the behavior whether or not Limitless Paper Feeding is applied to the Bypass Tray. Enabled (=0: Default): Limitless Paper Feeding is applied to the Bypass Tray. If a tray other than the Bypass Tray matches the job's paper size and type but has run out of paper, printing will occur from the Bypass Tray. Disabled (=1): Limitless Paper Feeding is not applied to the Bypass Tray. If a tray other than the Bypass Tray matches the job's paper size and type but has run out of paper, printing will stop and an	Enabled	Disabled	

		<p>alert will appear on the LCD screen, stating that the tray has run out of paper. This prevents unexpected use of the Bypass Tray.</p> <p>Limitations when this BitSw is set to "1":</p> <ul style="list-style-type: none"> - Jobs that contain more than one paper size cannot be printed. - The "Paper Tray Priority: Printer" setting must be configured to a tray other than the Bypass Tray. 		
bit	Change the behavior of the center staple		Cancel the job	Continue to print
3	<p>This Bit Switch can change the behavior of the center staple when the maximum number of sheets for stapling is exceeded.</p> <p>0 (default):</p> <p>The job is canceled and an error is recorded in the log.</p> <p>1:</p> <p>The job is not canceled and is produced. How the job is produced in any behavior depends on the type of finisher.</p>			
bit	"Apply Auto Paper Select" to Override Paper Size or Paper Type of the Device		Disabled	Enabled
4	<p>If this BitSw is enabled, the "Apply Auto Paper Select" setting will decide if the paper size or paper type that is specified in the device settings should be overridden by the job's commands when "Tray Setting Priority" is set to "Driver/Command" or "Machine Setting(s): Any Type".</p> <ul style="list-style-type: none"> - Apply Auto Paper Select = OFF: Overridden (priority is given to the job's commands) - Apply Auto Paper Select = ON: NOT overridden (priority is given to the device settings) 			
bit	DFU		-	-
5				
bit	Tray Selection when a Paper Mismatch Occurs.		Disabled	Enabled
6	<p>This BitSw enables the inactive auto paper select tray to be unselectable when a paper size/type mismatch occurs.</p>			
bit	DFU		-	-
7				

1001	[Bit Switch]		
1-001-012	Bit Switch C	0	1
	bit	DFU	-
	0		-

3.SP Mode Tables

	bit 1	DFU	-	-
	bit 2	DFU	-	-
	bit 3	Switching paper discharge operation when the limit number of sheets stapled is exceeded	one by one	Upper limit number
		-		
	bit 4	DFU	-	-
	bit 5	Change User ID type Displayed on Operation Panel	Login User Name	User ID
		If this BitSw is enabled, the user ID type on the operation panel can change to the user ID behavior exhibited in 14A and earlier models.		
	bit 6	Air Print	Enabled	Disabled
-				
bit 7	AirPrint PDF	Enabled	Disabled	
	-			

1002	[Bit Switch2]			
1-002-001	Bit Switch (2) 1 Settings		0	1
	bit 0	Paper size mismatch display	Enabled	Disabled
		Display warning screen (40909) of paper size mismatch.		
bit 1 to 7	DFU	-	-	

1002	[Bit Switch2]			
1-002-002	Bit Switch (2) 2 Settings		0	1
	bit 0 to 7	DFU	-	-

1002	[Bit Switch2]			
1-002-003	Bit Switch (2) 3 Settings		0	1
	bit 0 to 7	DFU	-	-

1002	[Bit Switch2]			
1-002-004	Bit Switch (2) 4 Settings		0	1
	bit 0 to 7	DFU	-	-

1002	[Bit Switch2]			
1-002-005	Bit Switch (2) 5 Settings		0	1

	bit 0 to 7	DFU	-	-
--	------------	-----	---	---

1002	[Bit Switch2]			
1-002-006	Bit Switch (2) 6 Settings		0	1
	bit 0 to 7	DFU	-	-

1002	[Bit Switch2]			
1-002-007	Bit Switch (2) 7 Settings		0	1
	bit 0 to 7	DFU	-	-

1002	[Bit Switch2]			
1-002-008	Bit Switch (2) 8 Settings		0	1
	bit 0 to 7	DFU	-	-

1002	[Bit Switch2]			
1-002-009	Bit Switch (2) 9 Settings		0	1
	bit 0 to 7	DFU	-	-

1002	[Bit Switch2]			
1-002-010	Bit Switch (2) A Settings		0	1
	bit 0 to 7	DFU	-	-

1002	[Bit Switch2]			
1-002-011	Bit Switch (2) B Settings		0	1
	bit 0 to 7	DFU	-	-

1002	[Bit Switch2]			
1-002-012	Bit Switch (2) C Settings		0	1
	bit 0 to 7	DFU	-	-

1003	[Clear Setting]			
1-003-001	Initialize System	*CTL	[- / - / -] [Execute]	
	Initializes settings in the "System" menu of the user mode.			
1-003-003	Delete Program	*CTL	[- / - / -] [Execute]	

1004	[Print Summary]			
-------------	------------------------	--	--	--

3.SP Mode Tables

	Prints the service summary sheet (a summary of all the controller settings).		
1-004-001	Print Summary	*CTL	[- / - / -] [Execute]
1-004-002	Print Summary2	*CTL	[- / - / -] [Execute]

1005	[Display Version]		
1-005-002	Printer Version	*CTL	[- / - / -]
	Displays the version of the controller firmware.		

1006	[Sample / Proof Print]		
1-006-001	Sample / Proof Print	*CTL	[0 or 1 / 1 / 1 /step] 0: Linked, 1: On
	Enables and disables the document server. When you select "0," the document server is enabled or disabled in accordance with Copy Service Mode SP5-967. When you select "1," the document server is enabled regardless of Copy Service Mode SP5-967.		

1101	[Data Recall]		
	Recalls a set of gamma settings. This can be either a) the factory setting, b) the previous setting, or c) the current setting.		
1-101-001	Factory	*CTL	[- / - / -] [Execute]
1-101-002	Previous	*CTL	
1-101-003	Current	*CTL	
1-101-004	ACC	*CTL	

1102	[Resolution Setting]		
	Selects the printing mode (resolution) for the printer gamma adjustment.		
1-102-001	Tone Control Mode Selection	CTL	[0 to 9 / 0 / 1/step] 0: 1200x1200 Photo (2bit/4col) 1: 1200x1200 Photo (1bit/4col) 2: 600x600 Photo (4bit/4col) 3: 600x600 Photo (2bit/4col) 4: 600x600 Photo (1bit/4col) 5: 1200x1200 Text (2bit/4col)

			6: 1200x1200 Text (1bit/4col) 7: 600x600 Text (4bit/4col) 8: 600x600 Text (2bit/4col) 9: 600x600 Text (1bit/4col)
--	--	--	--

1103	[Test Page]		
	Prints the test page to check the color balance before and after the gamma adjustment.		
1-103-001	Color Gray Scale	CTL	[- / - / -]
1-103-002	Color Pattern	CTL	[Execute]

1104	[Gamma Adjustment]		
	Adjusts the printer gamma for the mode selected in the "Mode Selection" menu.		
1-104-001	Black: Highlight	CTL	[0 to 30 / 00 / 1/step]
1-104-002	Black: Shadow	CTL	
1-104-003	Black: Middle	CTL	
1-104-004	Black: IDmax	CTL	
1-104-021	Cyan: Highlight	CTL	
1-104-022	Cyan: Shadow	CTL	
1-104-023	Cyan: Middle	CTL	
1-104-024	Cyan: IDmax	CTL	
1-104-041	Magenta: Highlight	CTL	
1-104-042	Magenta: Shadow	CTL	
1-104-043	Magenta: Middle	CTL	
1-104-044	Magenta: IDmax	CTL	
1-104-061	Yellow: Highlight	CTL	
1-104-062	Yellow: Shadow	CTL	
1-104-063	Yellow: Middle	CTL	
1-104-064	Yellow: IDmax	CTL	

1105	[Save Tone Control Value]		
	Stores the print gamma adjusted with the "Gamma Adj." menu item as the current setting. Before the machine stores the new "current setting", it moves the data currently stored as the "current setting" to the "previous setting" memory storage location.		
1-105-001	Save Tone Control Value	*CTL	[- / - / -] [Execute]

1106	[Toner Limit]
-------------	----------------------

3.SP Mode Tables

	Adjusts the maximum toner amount for image development.		
1-106-001	Toner Limit Value	*CTL	[0 to 400 / 0 / 1 %/step]

1110	[Media Print Device Setting]		
	Selects the setting for the media print device.		
1-110-002	0: Disable 1: Enable	*CTL	[0 or 1 / 1 / 1 / step]

1111	[All Job Delete Mode]		
1-111-001	-	*CTL	[0 or 1 / 0 / 1 / step] 0: Excluding New Job 1: Including New Job
	Selects whether to include an image processing job in jobs subject to full cancellation from the SCS job list.		

1113	[IBACC Exec]		
	Sets IBACC correction execution (calculation IBACC gamma) on / off. 0: Not calculate IBACC gamma. (Sets IBACC gamma linear) 1: Calculate IBACC gamma		
1-113-001	0:Off 1:On	*CTL	[0 or 1 / 1 / 1/step]

1114	[IBACC ToneCtlSet]		
	Sets back to the previous value of IBACC gamma correction for all resolutions. If there is no previous value, sets to the factory default values.		
1-114-001	Tone (Prev.)	CTL	-
1-114-002	Tone (Factory)	CTL	-

1115	[IBACC Exec Time]		
	Displays the time when IBACC is executed or sets back to the previous / initial value.		
1-115-001	Time	CTL	-

Scanner Service Menu

SP1-XXX (System and Others)

1001	[Scan Nv Version]		
	Displays the scanner firmware version stored in NVRAM in a 9-digit format: Func. Name_Model Name_History No.		
1-001-005	-	*CTL	[- / - / -]

1005	[Erase Margin(Remote scan)]		
	Creates an erase margin for all edges of the scanned image. If the machine has scanned the edge of the original, create a margin. This SP is activated only when the machine uses TWAIN scanning.		
1-005-001	Range from 0 to 5 mm	*CTL	[0 to 5 / 0 / 1 mm]

1009	[Remote scan disable]		
	1-009-001	-	*CTL
			[0 or 1 / 0 / 1] 0: ON (enabled) 1: OFF (disabled)
	This SP switches the TWAIN scanner function on/off. This is one of the scanner application functions.		

1010	[Non Display Clear Light PDF]		
	1-010-001	-	*CTL
			[0 or 1 / 0 / 1] 0: Display, 1: No display
	Display or Non display remote scan.		

1011	[Org Count Display]		
	1-011-001	-	*CTL
			[0 or 1 / 0 / 1] 0: OFF (no display) 1: ON (count displays)
	This SP codes switches the original count display on/off.		

1012	[User Info Release]		
	1-012-001	-	*CTL
			[0 or 1 / 1 / 1] 1: Release 0: Do not release

3.SP Mode Tables

	<p>This SP code sets the machine to release or not release the following items at job end.</p> <ul style="list-style-type: none"> • Destination (E-mail/Folder/CS) • Sender name • Mail Text • Subject line • File name
--	--

1013	[Multi Media Function]		
1-013-002	-	*CTL	[0 or 1 / 1 / 1] 0: Disable 1: Enable
<p>This SP code enables/disables the multi-media function option (USB 2.0/SD Slot) mounted on the front of the machine. Operators can scan documents to either an SD card or a USB memory device inserted into this unit. This SP must be enabled (set to "1") in order for the device to function.</p>			

1014	[Scan to Folder Pass Input Set]		
1-014-001	-	*CTL	[0 or 1 / 0 / 1] 0: Disable 1: Enable
<p>Enables / Disables to input password for Scan To Folder.</p>			

1016	[Scan To Email Sender Address]		
Specify the Scan To Email sender address.			
1-016-001	-	*CTL	[0 or 1 / 0 / 1] 0: Login user address 1: POP before SMTP address

1041	[Scan:FlairAPI Setting]			
1-041-001	0x00 – 0xff	*CTL	* see BitSwitch below:	
<p>Sets Scanner FlairAPI Function enable / disable. This SP is set by BitSwitch and needs to reboot the machine after making changes.</p>				
bit	Setting	meanings		Description
		0	1	
bit 0	Start of FlairAPI Server	Off (Do not Start)	On (Start)	Sets whether to start exclusive FlairAPI http server. If it is 0, scanning FlairAPI function and simple UI function will be disabled.
bit 1	Access	Disabled	Enabled	If it is "0", accessing is limited from the

	permission of FlairAPI from outside of the machine			machine only, such as operating panel, SDK/J, MFP browsers etc... If it is "1", accessing is allowed from outside of FlairAPI such as PC, Remote UI, IT-Box etc...
bit 2	IPv6 (Exclusive) / IPv4 (Priority) Switching	IPv6 (Exclusive)	IPv4 (Priority)	If this bit is "0", only IPv6 accessing is permitted. If this bit is "1" and IPv4 is enabled, the machine uses IPv4 accessing. If this bit is "1" and IPv4 is disabled, the machine uses IPv6 accessing. In this case, it is unable to access through Smart Operation Panel if IPv4 address is enabled.
bit 3	Remote UI Function	Not Used	Use	Sets use of Remote UI for scanner function.
bit 4	Reserved	-	-	-
bit 5	Reserved	-	-	-
bit 6	Reserved	-	-	-
bit 7	Reserved	-	-	-

1042	[Scan To Email Sender Address]		
	Specify the format to display the date when sending files by Scan To Email.		
1-042-001	-	*CTL	[0 to 3/ 0 / 1] 0: Pursuant to the language setting (Default) 1: MM/DD/YYYY 2: DD/MM/YYYY 3: YYYY/MM/DD

1043	[Result Screen Doc Name Display]		
	Specify whether or not to display the document name (for security purposes) on the screen displaying the Scan To Email transmission result.		
1-043-001	-	*CTL	[0 to 1/ 0 / 1] 0: NoDisplay 1:Dispaly

SP2-XXX (Scanning-image Quality)

2021	[Compression Level (Gray-scale)]
-------------	----------------------------------

3.SP Mode Tables

	Selects the compression ratio for grayscale processing mode (JPEG) for the five settings that can be selected at the operation panel.		
2-021-001	Comp1:5-95	*CTL	[5 to 95 / 20 / 1 / step]
2-021-002	Comp2:5-95	*CTL	[5 to 95 / 40 / 1 / step]
2-021-003	Comp3:5-95	*CTL	[5 to 95 / 65 / 1 / step]
2-021-004	Comp4:5-95	*CTL	[5 to 95 / 80 / 1 / step]
2-021-005	Comp5:5-95	*CTL	[5 to 95 / 95 / 1 / step]

2023	[ACS setting of ClearLightPDF]		
	This SP code enables/disables the ACS function.		
2-023-001	-	*CTL	[0 or 1 / 1 / 1 / step] 0: Disable 1: Enable

2024	[Compression ratio of ClearLight PDF] Selects the compression ratio for clearlight PDF for the two settings that can be selected at the operation panel.		
2-024-001	Compression Ratio (Normal image)	*CTL	[5 to 95 / 25 / 1 / step]
2-024-002	Compression Ratio (High)	*CTL	[5 to 95 / 15 / 1 / step]

2025	[Compression ratio of ClearLightPDF JPEG2000] Selects the compression ratio for clearlight PDF for the two settings that can be selected at the operation panel.		
2-025-001	Compression Ratio (Normal) JPEG2000	*CTL	[5 to 95 / 25 / 1 / step]
2-025-002	Compression Ratio (High) JPEG2000	*CTL	[5 to 95 / 15 / 1 / step]

2030	[OCR PDF DetectSens]		
2-030-001	Level5:	*CTL	[0 to 255 / 250 / 1 / step]
2-030-002	Level5:	*CTL	[0 to 100 / 80 / 1 / step]

2-030-003	Level5:	*CTL	[0 to 100 / 80 / 1 / step]
-----------	---------	------	-----------------------------------

2031	[Vertical Judgment Setting]		
001	Function Setting: 0 - 1	*CTL	[0 to 1 / 0 / 1 / step] 0:Enable 1:Disable
	When the image does not become upright state due to the vertical judgment error, set this SP to "0: Disable". After changing the setting, turn OFF/ON the main power.		
002	Algorithm Setting: 0 - 2	*CTL	[0 to 2 / 0 / 1 / step] 0: Normal Algorithm 1: Simple Algorithm 2: Composite Algorithm
	Set the identification algorithm when SP2-031-001 is "1: Enable". Change the setting when the vertical judgment error occur frequently. After changing the setting, turn OFF/ON the main power.		

SP3-XXX

3044	-		
3-044-001	-	CTL*	[0 to 1 / 1 / 1 / -]
	Specify the compression ratio of scanned image data when using clear light PDF. 0: High (The value in SP2-024-02 is applied.) 1: Normal (The value in SP2-024-01 is applied.)		

3045	-		
3-045-001	-	CTL*	[0 to 5 / 5 / 1 / -]
	Specify which location (server) to search first when searching for the mail address. 0: LDAP Server 1 1: LDAP Server 2 2: LDAP Server 3 3: LDAP Server 4 4: LDAP Server 5 5: Machine Address Book		

3053	-		
3-053-001	-	CTL*	[0 to 1 / 0 / 1 / -]
	Specify the compression ratio of scanned image data when using clear light PDF. 0: JPEG (The value in SP2-025-02 is applied.) 0: JPEG2000 (The value in SP2-025-01 is applied.)		

3.SP Mode Tables

3-053-002	-	CTL*	[0 to 1 / 0 / 1 / -]
	Specify the compression ratio of a scanned text image when using clear light PDF. 0: MMR 1: JBIG2		

3066	[High Compression PDF Priority Setting]		
3-066-001	-	CTL*	[0 to 1 / 1 / 1 / -]
	Specify the clear light PDF generation mode. 0: Generate PDF 1: Handling Speed		

3067	[flate Compression Setting]		
3-067-001	-	CTL*	[0 to 1 / 1 / 1 / -]
	Specify whether to enable or disable clear light PDF compression. 0: Disable 1: Enable		

3070	[Scan Limit Warning Display Setting]		
3-070-001	-	CTL*	[0 to 1 / 1 / 1 / -]
	Specify whether or not to display the warning when the number of scans reaches the upper limit. 0: Not Display 1: Display		

3071	[Function Use Count]		
3-071-001	WSD	CTL*	[0 to 4294967295 / 1 / 1 / -]
	Counts the number of jobs sent via Scan to PC of the WSD function.		
3-071-002	DSM	CTL*	[0 to 4294967295 / 1 / 1 / -]
	Counts the number of jobs sent via Scan to PC of the DSM function.		
3-071-003	SmallSizeTray	CTL*	[0 to 4294967295 / 1 / 1 / -]
	Counts the number of originals fed from the small paper feeding unit.		
3-071-004	BlankDetect Ocr	CTL*	[0 to 4294967295 / 1 / 1 / -]
	Counts the number of jobs to which the blank paper elimination function (with OCR) is		

3.SP Mode Tables

	applied.		
3-071-005	BlankDetect	CTL*	[0 to 4294967295 /1 / 1 / -]
	Counts the number of jobs to which the blank paper elimination function (without OCR) is applied.		
3-071-006	AirPrint/Mopria	CTL*	[0 to 4294967295 /1 / 1 / -]
	Counts the number of pages scanned with AirPrint/Mopria.		
3-071-007	ScanToURL	CTL*	[0 to 4294967295 /1 / 1 / -]
	Counts the number of pages sent with ScanToURL.		

3072	[Total Job Count]		
3-072-001	LegacyScnan	CTL*	[0 to 4294967295 /1 / 1 / -]
	Counts the number of times a job is executed using "Scanner (Classic)".		
3-072-002	SmartScan	CTL*	[0 to 4294967295 /1 / 1 / -]
	Counts the number of times a job is executed using "Scanner".		
3-072-003	SimpleScan	CTL*	[0 to 4294967295 /1 / 1 / -]
	Counts the number of times a job is executed using "Simple Scanner".		
3-072-004	MediaScan	CTL*	[0 to 4294967295 /1 / 1 / -]
	Counts the number of times a job is executed using the Media Scanner function.		
3-072-005	OtherScan	CTL*	[0 to 4294967295 /1 / 1 / -]
	Counts the number of times a job is executed using any other scanner function.		

4. Software Configuration

Printing Features

Behavior of USB Printer Detection

An MFP/LP connected via USB sends its product name and unique serial number. With the data, the machine determines whether requires a printer driver for the USB device to be installed.

SP5-844-005 allows you to change how to determine the MFP/LP requires a printer driver installation:

- **OFF**
If SP5-844-005 is set to OFF, the unique serial number of the device is sent to the computer. As a result, if the device is swapped out for a device of the same product, pop-up messages will appear, because the serial numbers between the two are different.
- **Level 1**
If SP5-844-005 is set to Level 1, a common serial number for the product such as "MP 305+" series is sent to the computer. As a result, if the device is swapped out for a device of the same product, pop-up messages will not appear because the devices are recognized as having the same serial number.
- **Level 2**
If SP5-844-005 is set to Level 2, a common serial number for all GW/GW+ models is sent to the computer. As a result, if a GW/GW+ device is swapped out for a different GW/GW+ device, pop-up messages will not appear because the devices are both recognized as being based on GW/GW+.

Auto PDL Detection Function

Overview

The Auto PDL Detection function gives the MFP the ability to determine the PDL of a job or of specific parts of a job. This can be especially useful in cases where the PDL is not specified or if the job contains multiple PDLs.

Conditions for detection of the PDL

The MFP will only attempt to detect a job's PDL if all of the following conditions are met.

- No @PJL ENTER LANGUAGE command is contained in the job
- No submission protocol options (lpr, ftp, rcp, or rsh options) have been used to specify the PDL
- Settings > Printer Settings > System > Printer Language = Auto

PDL detection by the printer system, PCL interpreter and PS interpreter

There are 3 components in the printer which can perform Auto PDL Detection:

1. **Printer system:**

Uses a set of triggers unique to PCL5, PS or PDF. Up to 2KB from the start of the job can be searched for triggers.

2. **PCL interpreter:**

It can detect PS triggers in PCL data. If a PS trigger is detected, the PCL interpreter will abort processing and return the unprocessed part of the job back to the printer system. Up to 256 bytes from the start of each page can be searched for triggers.

3. **PS interpreter:**

It can detect PCL5 triggers in PS data. If a PCL trigger is detected, the PS interpreter will abort processing and return the unprocessed part of the job back to the printer system. The entire page (regardless of the number of bytes) is searched for triggers.



- 2. and 3. can be disabled using Printer Bit Switch 2-3=1.
- If the "Printer Language" is configured to anything other than Auto, all detection will be disabled.
- An interpreter submits a job page by page to the rasterizer. Therefore, when an interpreter detects a trigger mid-job, the previous pages will have already been submitted and will be output using the previously detected PDL.
- If the PDL cannot be detected by the printer system, then the PDL defaults to the one configured in "Configuration > Printer Basic Settings > Default Printer Language".

The Printer Language setting and Default Printer Language setting in WIM:



PDL selection and switching

3 types of PDL selection/switching are performed:

1. PDL selection (PCL5 or PS (including PDF)) at the beginning of the job: performed by the printer

4. Software Configuration

system



2. PDL switching from PCL5 to PS: performed by the PCL interpreter and the printer system



3. PDL switching from PS to PCL5: performed by the PS interpreter and the printer system



Triggers

Printer system

PCL5 triggers	[ESC]E [FF]
PS triggers	%!PS-Adobe-3.1 "%" "dict begin"

	"bind def" "findfont" "showpage" "/statusdict" "0 startjob" [EOT] 0x04 "}" + space character + "def" "userdict (*)" 0x14
PDF triggers	%PDF- %!PS-Adobe-M.nPDF- (*M, n=numeric)

* "userdict" is excluded by configuring Printer Bit Switch 5-3=1.



- Up to 2KB from the start of the job can be searched for triggers.
- By configuring Printer Bit Switch 5-3=1:
 - "%%" can be added to the PS triggers
 - "userdict" is excluded
- If a job is identified as PDF, it will be sent to the PS interpreter to be processed as a regular PS job.

PS interpreter

PCL5 trigger	[ESC]E and 2 or more continuous PCL commands
--------------	--



- Up to 256 bytes from the start of each page can be searched for triggers.

Some possible problems

Garbled output:

If a string of characters (or binary data) is mistaken as a trigger and an incorrect PDL is applied, the output will be garbled.

Incorrect printer settings:

Printer settings, for example the paper size, is incorrectly applied. This can happen when the printer settings at the beginning of the job are initialized before a PDL switch occurred and no settings were configured for the rest of the job.

Printer Bit Switch description

Bit Switch 2-3

This controls Auto PDL Detection by the PCL interpreter and PS interpreter.

BitSW 2-3=0 (default):

4. Software Configuration

If PDL switching is applied to the job, all of the printer system, PCL interpreter and PS interpreter will search for switching criteria (triggers).

BitSW 2-3=1:

Only the printer system will search for switching criteria (triggers). PCL/PS interpreters will not.

Bit Switch 5-3

This affects the PDL switching criteria (triggers) used by the printer system.

BitSW 5-3=0 (default):

"%%" is not used as a printer system PS trigger. "%%" will not call the PS interpreter.

BitSW 5-3=1:

"%%" is used as a printer system PS trigger.

The reason that "%%" is not included as a trigger by default, is that a string of text in the body of the job such as the below, could result in a false positive. This would trigger a switch and result garbled output.

%%%%%%%%%

However some customers prefer that "%%" be included as a switching criteria. BitSW5-3=1 should be used in such a case.



- A side effect of BitSW5-3=1 is that "userdict" will no longer be used as a PS trigger.

Bit Switch 9-0

These determine whether Auto PDL Detection for print jobs transmitted via USB/parallel will wait 10 seconds to make sure the first 2KB of the job has been sent.

The Printer system portion of the Auto PDL Detection function is only performed on the first 2KB of a job and can wait up to 10 seconds for that first 2KB to arrive. As the printer is unable to detect the end of jobs submitted over a USB/Parallel connection, it might be preferable to not wait 10 seconds if jobs of less than 2KB are going to be printed. Enabling/disabling this waiting time is the purpose of BitSw 9-0.

BitSw 9-0=0 (default):

The printer system will not wait 10 seconds for the first 2KB of data to arrive.

BitSw 9-0=1:

The printer system will wait up to 10 seconds for the first 2KB of data to arrive.

Print Images Rotation

Printer Bit Switch description

Bit Switch 5-6

This change the way an MFP/LP rotates PCL, PS, PDF, or RPCS print images.

BitSW 5-6=0 (default):

A uniform binding edge (short or long edge) will be applied to every page of every job. Pages will always be rotated as if they were to be bound on that edge.

BitSW 5-6=1:

A uniform binding edge (short or long edge) will only be applied if the job is stapled, punched, or Z-

folded. Otherwise, the bound edge might differ from page to page.

Example:

A 3-page job. Page 1 has the PCL simplex command. Page 2 and 3 have the PCL duplex long-edge bind commands.

No finishing options (staple, punch, z-fold) are used.

Bit Switch #5-6=0:



Bit Switch #5-6=1:



- Used in conjunction with Bit Switch #5-6, Orientation Auto Detect for PS/PDF jobs might cause unexpected results.

PJL USTATUS

Printer Bit Switch description

Bit Switch 9-4

These control the way PJL USTATUS returns page count totals in cases where multiple copies of a job are being printed.

BitSw 9-4=0 (default):

This change the way an MFP/LP rotates PCL, PS, PDF, or RPCS print images.

1. The page count for a single copy is returned after the first copy is printed.

4. Software Configuration

2. The page count for the rest of the copies, excluding the first copy, is returned after all copies have been printed.
3. This emulates an older HP PCL firmware spec. It is only needed for compatibility with legacy software.

BitSw 9-4=1:

The page count for all copies is output after all copies have been printed.

This emulates more recent HP PCL firmware specs.

For example, consider 3 copies of a 3 page job:

9-4 = 0

@PJM USTATUS JOB

START

NAME="TEST_page1-3"

@PJM USTATUS PAGE

1

@PJM USTATUS PAGE

2

@PJM USTATUS PAGE

3

@PJM USTATUS JOB

END

NAME="TEST_page1-3"

PAGES=3

<comment> The page count of the first copy is returned.</comment>

@PJM USTATUS PAGE

1

@PJM USTATUS PAGE

2

@PJM USTATUS PAGE

3

@PJM USTATUS PAGE

4

@PJM USTATUS PAGE

5

@PJM USTATUS PAGE

6

<comment> The page count of the remaining two copies is returned.</comment>

9-4 = 1

@PJM USTATUS JOB

START

1818

```

NAME="Microsoft Word - TEST_page1-3"
@PJM USTATUS PAGE
1
@PJM USTATUS PAGE
2
@PJM USTATUS PAGE
3
@PJM USTATUS PAGE
4
@PJM USTATUS PAGE
5
@PJM USTATUS PAGE
6@PJM USTATUS PAGE
7
@PJM USTATUS PAGE
8
@PJM USTATUS PAGE
9
@PJM USTATUS JOB
END
NAME="Microsoft Word - TEST_page1-3"
PAGES=9
<comment> The page count of all three copies is returned.</comment>

```

Adjustment

User Code Authentication to Restrict Color Printing

The Effect of Bit Switch 8-3 on Host Printing with User Code Authentication

This page explains the difference between the default configuration of the device and the effect of enabling Bit Switch 8-3.

If a GW device is running User Code Authentication to restrict color printing and the host system does not add the necessary commands to the print job, the default configuration is for a job that does not include the PJL SET DATAMODE command to be aborted. However, if Bit Switch 8-3 is enabled, a job that does not include the PJL SET DATAMODE command is forced to print in black and white instead. Flow charts illustrating the process of the Bit Switch 8-3 settings in more detail are included in the sections below.

Default Configuration: Bit Switch 8-3 not enabled (Set to 0)

4. Software Configuration

In the following flow chart, the lines and comments in **Red** represent the processing path of a host system's print job in a default case:

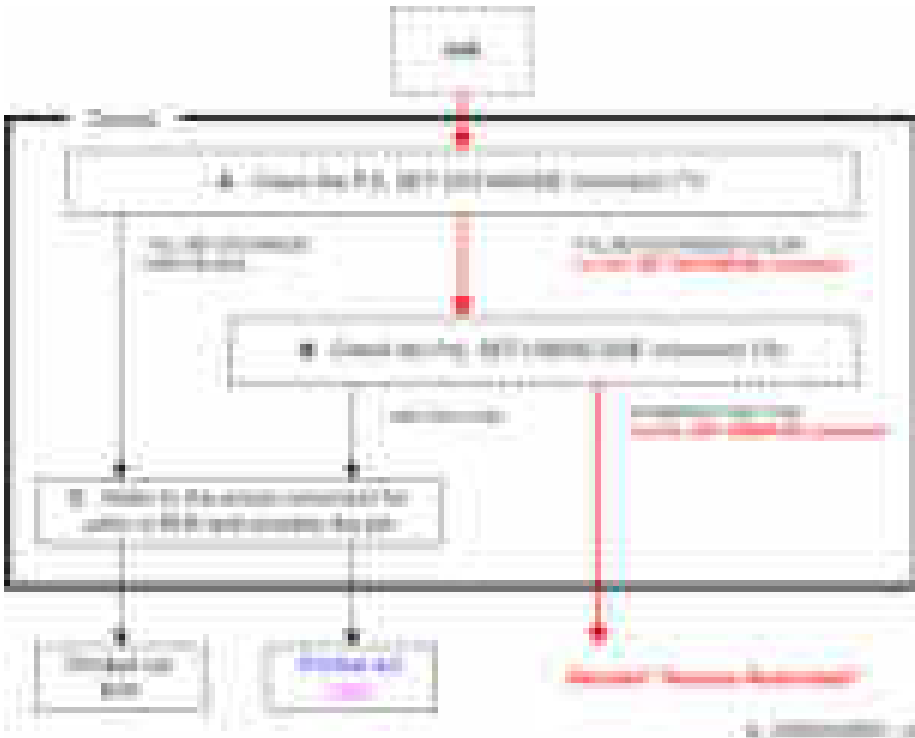

(*1) In a PS job, the command is RCsetdevicecolor, and divided by its value, (gray) or (cmyk).

(*2) In a PS job, the command is {setuserinfo}.

Bit Switch 8-3 Enabled (Set to 1)

Bit Switch 8-3 changes the way a GW device handles the PJI SET DATAMODE (or RCsetdevicecolor) command. With Bit Switch 8-3 enabled, **any job which does not include such a command is forced to print out in B/W.**

In the following flow chart, the lines and comments in **Blue** represent the processing path of a host system job:

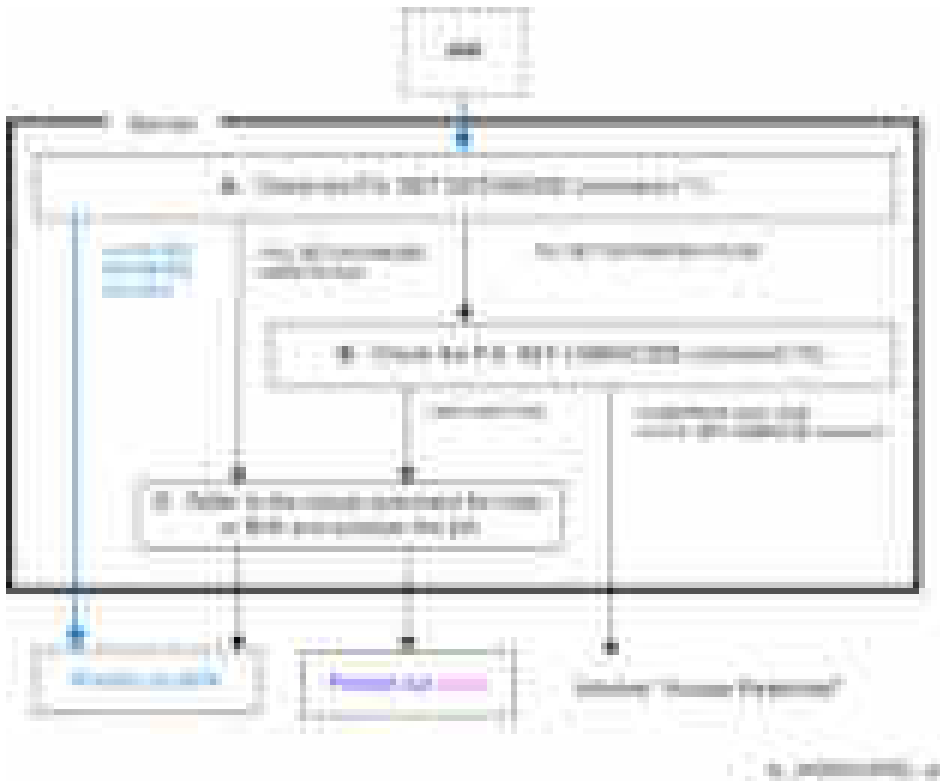

(*1) In a PS job, the command is RCsetdevicecolor, and divided by its value, (gray) or (cmyk).

(*2) In a PS job, the command is {setuserinfo}.

Scanner Settings

Display settings of recently used scan destination

Configuring the scanner interface so that the most recently used scan destination is cleared.

Whether the MFP clears the most recently used scan destination, can be configured using Scanner SP 1-012-001.

By default, this is cleared to avoid subsequent users scanning to it by mistake.

Scanner SP 1-012-001

1 (default): Clear

0: Do not clear

This will cause all of the following to be cleared after the scanning is complete:

- Destination
- Sender
- Email subject
- Email message
- File name

Scanner SP 1-012-001=1 (default):



Exceptions:

- User Auth.:
If SP 1-012-001 = 0 and if User Auth. (excluding User Code authentication) is enabled, the most recently used scan destination will only be retained until the user logs out.
- Scanner Auto Reset timer:
Even if SP 1-012-001 = 0 the most recently used scan destination can still be cleared by the Scanner Auto Reset timer. If the Scanner Auto Reset timer is shorter than the System Auto Reset timer, then the most recently used scan destination will be cleared when the Scanner Auto Reset timer elapses.

The Setting of SMTP authentication in Scan to Email

Scan to Email fails with the error message "Transmission has failed ". The SMTP username and 1822

password are correct. How can I make Scan to Email pass ?

Change SP 5-860-022 "SMTP Auth. From Field Replacement" to On. By doing this, Scan to Email will pass the SMTP authentication.



- Using this option to solve the above problem, the device email address will appear in the email's "From" field. The email address of the user who sent the email will appear in the "Reply-to" field.

Explanation

This is an SMTP authentication issue that aborts transmission of an already started Scan to Email.

Currently this has only been reproduced using MS-Exchange server.

MS-Exchange requires that all of the following match:

1. The sender's address in the "MAIL FROM" field. This is also known as the "envelope sender" or "MIME sender". It is an SMTP command sent at the beginning of the email transmission process.
2. The sender's address in the mail header "From:" field. This appears as "From" in email clients. It is a part of the email itself.
3. The email address corresponding to the SMTP username used to login into the SMTP server.

When the MFP logs into the SMTP server, the email address of the username 3) will be compared to 1) and 2). If these comparisons fail, authentication will also fail. Exchange server will stop the transmission procedure, and the "Transmission has failed" message will be returned to the sender.

Typical example

NG case:

SP5-860-022 is Off:

1. The "MAIL FROM" field = device (Fig.1)
2. The mail header "From:" field = user (Fig.2)
3. The SMTP username = device (Fig.1)

When the SMTP server compares 2) and 3) the Exchange Server will stop the transmission procedure.

OK case:

SP5-860 can be used to make the values in the above example, match.

In this example, if SP5-860-022 is On, the user's email address in the mail header '2)' will be replaced by the Administrator's email address. (see Fig.3)

To solve the problem, the Administrator's address must be the same as the device's address.

If this is done:

1. The "Mail From: field = device (Fig.1)
2. The mail header "From:" field = administrator (Fig.3)
3. The SMTP username = device (Fig.1)

1,2 and 3 must match and the authentication should be successful.



- The user's email address will still be inserted into the reply-to field.

4. Software Configuration

Fig.1 Default device SMTP username, password and email address



Fig.2 A user's email address in the Address Book



Fig.3 Administrator's email address

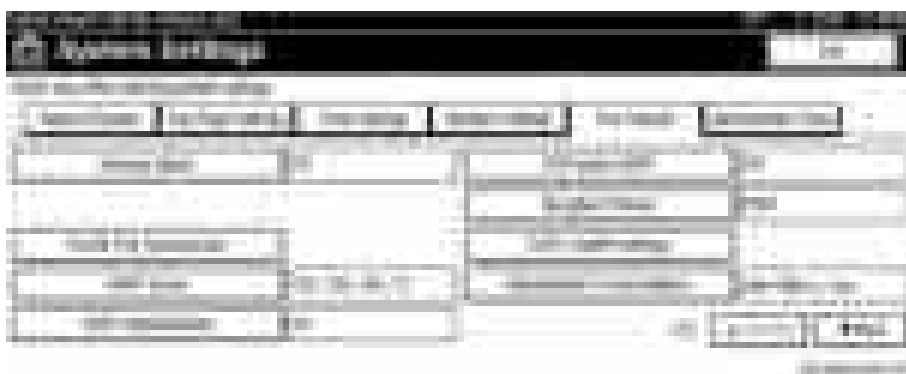

Determining the Account Used for Scan to Folder

This section explains how the machine determines which account Scan to Folder uses to access a scan destination and the effects of System SP 5-846-021.

This method depends on how the destination is accessed, whether authentication is being used, and SP 5-846-021.

Cases:

Case	Destination selection	User auth.	Account used to access the folder
A	Manual entry	Either enabled or	The user's account *

Case	Destination selection	User auth.	Account used to access the folder
		disabled	
B	Destination list	disabled	The recipient's account (as configured in the Address Book's Folder Authentication setting)
C		enabled	If SP 5-846-021 = 0 (default): The authenticated user's account 1: The recipient's account (as configured in the Address Book's Folder Authentication setting)

* The "user's account" will be either the one entered during scanning (see the Manual Entry screen capture) or if User Auth. is enabled, the account configured in the user's Folder Authentication setting will be used.

The destination's access logs:

Case A or Case C with SP=0: The access logs can be used to determine which user sent the scan.



Case B or Case C with SP=1: All access will be logged as the same user.



Security Features

How to Restrict Access to the WIM Job Menu

1. Enter 'Printer' SP mode.
2. Set SP5-888-001
0: (default): "Job" menu is enabled.
1: "Job" menu is disabled.



- This setting takes effect only if user authentication (other than User Code auth.) is disabled.



How to Restrict Web Image Monitor Access to the Document Server

System (Copier) SP 5-885-020 bit 0, 1 and 7 restrict Web Image Monitor access to the DS. It disables the following WIM settings:

- The entire Document Server menu (shown in blue in fig1)
- Job > Document Server (shown in red in fig1)

See the following for details:

Bit 0:

Bit 0 = 0 (default): Allows anyone (guests, users, admins) access to the DS via WIM.

Bit 0 = 1: Prevents everyone from accessing the DS via WIM.

Bit 1:

Bit 1 = 0 (default): Allows anyone (guests, users, admins) access to the DS via WIM.

Bit 1 = 1: Only administrators can access the DS via WIM.



- Without admin privileges, even authenticated users will be unable to access the DS via WIM.

Bit 7:

Bit 7 = 0 (default): Allows anyone (guests, users, admins) access to the DS via WIM.

Bit 7 = 1: Only administrators and authenticated users can access the DS via WIM.

The most restrictive result of combining these three configurations will take priority. So for example:

Bit 0 = 0

Bit 1 = 1

Bit 7 = 1

As Bit 1 = 1 is the most restrictive of the three, it will take precedence over the other two and only administrators will be able to access the DS via WIM.

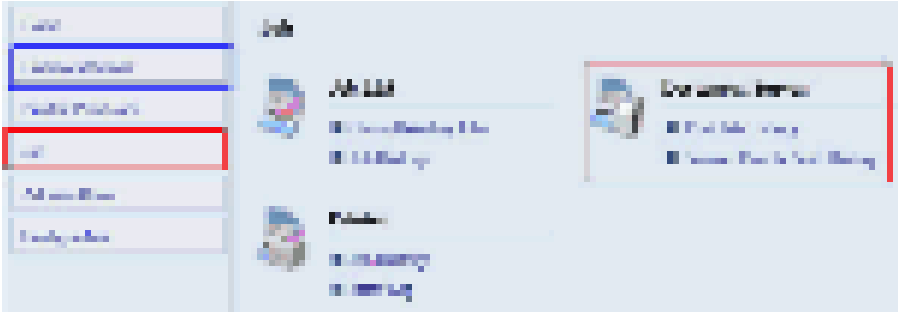

•

- In order for SP5-885-020 to have any effect, the Document Server must be enabled (SP5-967-001=0). For information about SP5-967-001, refer to Disabling the Document Server using System SP5-967-001 and Printer SP1-006-001.
- Access to the entire "Job" menu can be restricted using SP 5-888-001. For details, refer to Use of SP 5-888-001 to restrict access to the "Job" menu on WIM.

User Authentication for Specific MFP Applications

The SP5-420 settings enable/disable User Authentication for specific MFP applications.

SP 5-420 User Authentication Value (Default: 0)

SP 5-420	User Authentication	Value (Default: 0)	
SP5-420-001	Copy	0 (ON)	1 (OFF)
SP5-420-011	Document Server		
SP5-420-021	Fax		
SP5-420-031	Scanner		
SP5-420-041	Printer		

1. Enable User Authentication for the device as a whole:
User Tools > System Settings > Administrator Tools > User Authentication Management
2. Use the SP5-420 settings to specify the applications to which User authentication is to apply.